

9013 PUMPTROL[®] Commercial Pressure Switches Type F and 9013 Commercial Pressure Switches Type G

Catalog
January

07



Electromechanical Square D Brand 9013 Pressure Switches

- **Selection** *pages 4 to 5*
- **Presentation** *pages 6 to 7*
- **Characteristics** *pages 8 to 9*
- **9013FSG PUMPTROL® Commercial Pressure Switches**
 - Reference Numbers *pages 10 to 11*
 - Pressure Codes *10*
 - Ordering Information *10*
 - Modifications *11*
- **9013FTG PUMPTROL® Commercial Pressure Switches**
 - Reference Numbers *pages 12 to 13*
 - Pressure Codes *12*
 - Ordering Information *12*
 - Modifications *13*
- **9013FYG PUMPTROL® Commercial Pressure Switches**
 - Reference Numbers *pages 14 to 15*
 - Pressure Codes *14*
 - Ordering Information *14*
 - Modifications *15*
- **9013FRG PUMPTROL® Commercial Pressure Switches**
 - Reference Numbers *pages 16 to 19*
 - Pressure Codes *16 & 18*
 - Ordering Information *16 & 18*
 - Modifications *17 & 19*
- **9013FHG PUMPTROL® Commercial Pressure Switches**
 - Reference Numbers *pages 20 to 21*
 - Pressure Codes *20*
 - Ordering Information *20*
 - Modifications *21*
- **9013G Commercial Pressure Switches**
 - Reference Numbers *pages 22 to 27*
 - Pressure Codes *22, 24, 26*
 - Ordering Information *22, 24, 26*
 - Modifications *23, 25*
 - Replacement Parts *27*
- **9013 Type F and G**
 - Dimensions *pages 28 to 29*
- **Product Reference**
 - Index *pages 30*

Commercial Pressure Switches

Electromechanical Square D Brand 9013

Conforming to UL508 and CSA

Applications	Type of Installation	Power Circuit	Power Circuit	Power Circuit
	Controls	Fresh or sea water	Fresh or sea water	Fresh or sea water
	Type of Operation	Regulation between 2 thresholds (adjustable differential). Suitable for all pumps.	Detection of a single threshold (non-adjustable differential)	Regulation between 2 thresholds (adjustable differential). For higher HP and pressure requirements.



Family		PUMPTROL 9013FSG	PUMPTROL 9013FTG	PUMPTROL 9013FYG
Size / Range	PSI	20 - 65	20 - 65	25 - 80
	BAR	1.38 - 4.48	1.38 - 4.48	1.72 - 5.52
Conforming to standards		NEMA A600 UL508	UL508	NEMA A600 UL508
Product certifications		UL File: E12158 CCN NKPZ CSA File: LR 25490 Class 3211 06	UL Listed, CSA Certified	UL File: E12158 CCN NKPZ CSA File: LR 25490 Class 3211 06
Dimensions (l x h x w) in inches (mm)		3.76 x 2.8 x 2.78 (95.5 x 71.12 x 70.6)	3.76 x 2.8 x 2.78 (95.5 x 71.12 x 70.6)	3.76 x 2.8 x 2.78 (95.5 x 71.12 x 70.6)
Contact blocks	Snap action contacts	2 N.C.	2 N.C.	2 N.C.
Degree of protection		NEMA Type 1, NEMA Type 3R, and IP20	NEMA Type 1, NEMA Type 3R, and IP20	NEMA Type 1, NEMA Type 3R, and IP20
Connections	Electrical	Screw terminals	Screw terminals	Screw terminals
Cable Entries	Fluid	Multiple	Multiple	Multiple
		2	2	2
Type reference		9013FSG●●●	9013FTG●●●	9013FYG●●●
Characteristics		Page 8	Page 8	Page 8
Interpretation of Reference Numbers		Page 10 and 11	Page 12 and 13	Page 14 and 15
Other versions: Form B7, one grommet, CE Form B8, two grommets, CE		— —	— —	— —

Power Circuit	Power Circuit	Power Circuit
Fresh or sea water	Air only	Water or Air
Reverse acting, contacts open on falling pressure (adjustable differential)	Controls electrically driven air compressors, contacts open on rising pressure (non-adjustable differential, adjustable cut-out), diaphragm actuated	Light industrial, with higher electrical ratings for direct control of motors in pumps and compressors, contacts open on rising pressure (adjustable differential)



PUMPTROL 9013FRG	PUMPTROL 9013FHG	9013G
6 - 150	40 - 200	10 - 250
0.41 - 10.34	2.76 - 13.79	0.69 - 17.24
NEMA A300 UL508	NEMA A600 UL508	NEMA A600 UL508
UL File: E12158 CCN NKPZ CSA File: LR 25490 Class 3211 06	UL Listed, CSA Certified	UL File: E12158 CCN NKPZ (except GHR and GSR) UL File: E12443 CCN NOWT (for GHR and GSR) CSA File: LR 25490 Class 3211 06 (except GHR and GSR) CSA File: LR 26817 Class 3218 05 (for GHR and GSR)
3.76 x 2.8 x 2.78 (95.5 x 71.12 x 70.6)	3.76 x 2.8 x 2.78 (95.5 x 71.12 x 70.6)	3.68 x 3.85 x 3.44 (93.47 x 97.79 x 87.37)
2 N.C.	2 N.C.	2 N.C.
NEMA Type 1, NEMA Type 3R, and IP20	NEMA Type 1, NEMA Type 3R, and IP20	NEMA Type 1, NEMA Type 3R, NEMA Type 7, NEMA Type 9, and IP20
Screw terminals Multiple 2	Screw terminals Multiple 2	Screw terminals Multiple 3 knock-outs available

9013FRG●●●	9013FHG●●●	9013G●●●
-------------------	-------------------	-----------------

Page 9	Page 9	Page 9
Page 16 - 19	Page 20 and 21	Page 22 - 27
—	—	—
—	—	—

Commercial Pressure Switches

Electromechanical Square D Brand 9013

For power circuits, FSG, FTG, FYG, FRG, FHG, and G

Presentation

The PUMPTROL® 9013 Type F Commercial Pressure Switches are UL Listed and CSA Certified as commercial control equipment. Type G pressure switches are UL Listed and CSA Certified as commercial / light industrial control equipment.

The Type FHG - PUMPTROL® Compressor Pressure Switch is used to control electrically driven air compressors and is diaphragm actuated and has contacts that open on rising pressure.

The Type FSG, FYG, FRG - PUMPTROL® Water Pump Pressure Switches are used to control electrically driven water pumps and have the following features:

The Type FSG is the standard water pump switch, suitable for all types of pumps: jets, submersible, reciprocating, etc.

The Type FYG is designed to meet higher horsepower and pressure requirements. The Type FRG is reverse acting: the contacts open on falling pressure. All are diaphragm actuated.

The Type G Commercial/Light Industrial Pressure Switch is used to control electrically driven water pumps and air compressors. It has higher electrical ratings for direct control of motors in pump and compressor applications. The Type G switch is diaphragm actuated and has contacts that open on rising pressure.

Operating Points

Every pressure switch has two operating points; one on rising pressure and one of falling pressure. The operating point on rising pressure is referred to as the TRIP POINT or cut out for pumps and compressors and the operating point on falling pressure is referred to as the RESET POINT or cut in for pumps and compressors. These operating points are called the SETTINGS of the switch.

Differential

The differential is the difference in pressure between the trip point (cut-out) and the reset point (cut-in). It can be adjustable or non-adjustable.

Example: Cut-in (30 psi) / Cut-out (50 psi) Differential equals 20 psi

Range

The range indicates the pressure limits within which the operating points (settings) can be adjusted. The range is referenced to the operating point on rising pressure (trip point). The differential subtracts from the trip point setting.

During the normal operating cycle, system pressure should never exceed the upper limit of the range when using a diaphragm actuated switch. This will greatly reduce the life of the diaphragm.

Maximum Allowable Pressure

Maximum allowable pressure is the pressure to which a switch can be subjected without causing a change in operating characteristics, shift in settings, or damage to the device.

Pressure surges may occur in a system during the start up of a machine or from valve operation. Surges are not normally detrimental to the life of a switch if the surge is within the maximum allowable pressure rating of the switch. Diaphragm actuated switches should not be subjected to more than 10 surges per day. More frequent surges will greatly reduce the life of the diaphragm.

Commercial Pressure Switches

Electromechanical Square D Brand 9013

For power circuits, FSG, FTG, FYG, FRG, FHG, and G

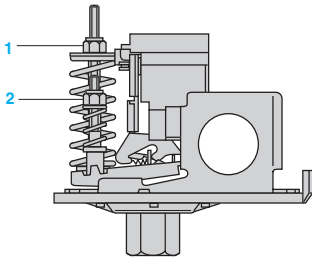

Settings

Pressure switches with adjustable differential (Types FSG, FYG and FRG)

When setting the pressure switch, adjust the switching point on rising pressure first and then the switching point on falling pressure.

Switching point on falling pressure

The switching point on falling pressure is set by adjusting screw-nut **1**.

Switching point on rising pressure

The switching point on rising pressure is set by adjusting screw-nut **2**.

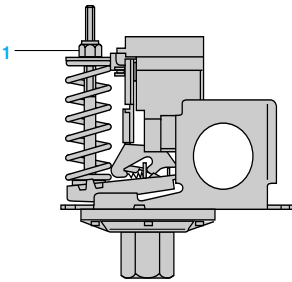

Pressure switches with non-adjustable differential (Types FTG, and FHG)

Only the switching point on rising pressure is adjustable.

Switching point on rising pressure

The switching point on rising pressure is set by adjusting screw-nut **1**.

Switching point on falling pressure

The switching point on falling pressure is not adjustable.

The difference between the tripping and resetting points of the contact is the differential of the switch (contact differential, friction, etc.).

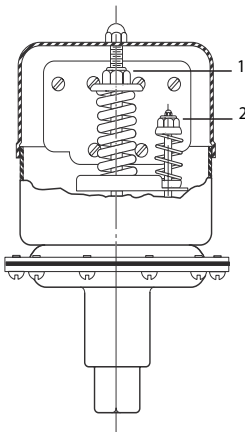

Pressure switches with adjustable differential (Type G)

When setting the pressure switch, adjust the switching point on rising pressure first and then the switching point on falling pressure.

Switching point on falling pressure

The switching point on falling pressure is set by adjusting screw-nut **1**.

Switching point on rising pressure

The switching point on rising pressure is set by adjusting screw-nut **2**.

Commercial Pressure Switches

Electromechanical Square D Brand 9013

For power circuits, FSG, FTG, FYG

Environmental characteristics		
Pressure switch type		FSG FTG FYG
Conformity to standards		UL 508, NEC Article 430-84, ANSI /NSF Standard 61, FDA 21CFR.2600
Product Certifications		UL File E12158 CCN NKPZ , CSA File LR 25490 Class 321106
Protective treatment		N/A
Ambient air temperature	°C	For operation, 0 °C (32 °F) min to 125 °C (257 °F) max For storage, -30 °C (-22 °F) min to 70 °C (158 °F) max
Fluids controlled		Fresh water, or sea water (with Form Q)
Materials		Cover: polypropylene, Noryl® thermoplastic resin or equivalent for Type 3R, Component material in contact with fluid: flange, zinc plated or equivalent (fluid entry), diaphragm, nitrile or equivalent rubber
Operating position		NEMA Type 1, and Type IP20 in any position, NEMA Type 3R in the vertical position only
Vibration		—
Shock		—
Electric shock		—
Degree of protection		NEMA Type 1, IP20 and NEMA Type 3R (some references) must be mounted in vertical position to maintain enclosure rating
Operating rate	cycles/m	10
Repeat accuracy		+/- 3 % of the range
Fluid connection		1/8" NPSF internal, 1/4" NPSF internal, 1/2" NPT External, 1/4" Bayonet (barbed), 90 deg. Elbow 1/4" Bayonet, Four Way Flange, 3/8" NPSF (Internal), 1/4" Flare, other specials
Electrical connection		2 open side entries, 3/4" diameter, with two flats

Contact block characteristics		
Type of contacts		One 2 pole, 2 N/C (4 terminal) contacts, snap action
Resistance across terminals	m Ω	< 25
Terminal referencing		N/A
Short-circuit protection	A	5,000
Connection		Screw clamp terminals. Clamping capacity up to #10 AWG (5.261 mm ²)
Electrical durability	cycles	100,000
Mechanical durability	cycles	300,000

Electrical Ratings											
2 Pole		FSG / FSW			FTG			FYG			
Power ratings of controlled motors	Voltage	~ 1-phase	~ 3-phase	≡	~ 1-phase	~ 3-phase	≡	~ 1-phase	~ 3-phase	≡	
	115 V	1.1 kW (1.5 HP)	1.5 kW (2 HP)	0.18 kW (.25 HP)	0.75 kW (1 HP)	—	—	—	1.5 kW (2 HP)	2.2 kW (3 HP)	0.37 kW (.50 HP)
	230 V	1.5 kW (2 HP)	2.2 kW (3 HP)	0.18 kW (.25 HP)	0.75 kW (1 HP)	—	—	—	2.2 kW (3 HP)	3.7 kW (5 HP)	0.37 kW (.50 HP)
	460 / 575 V	—	0.75 kW (1 HP)	—	—	—	—	—	—	0.75 kW (1 HP)	—

Commercial Pressure Switches

Electromechanical Square D Brand 9013

For power circuits, FRG, FHG, and G

Environmental characteristics

Pressure switch type		FRG	FHG	G
Conformity to standards		UL 508, NEC Article 430-84, ANSI /NSF Standard 61, FDA 21CFR.2600		
Product Certifications		UL File E12158 CCN NKPZ , CSA File LR 25490 Class 321106		
Protective treatment		N/A		
Ambient air temperature	°C	For operation, 0 °C (32 °F) min to 125 °C (257 °F) max For storage, -30 °C (-22 °F) min to 70 °C (158 °F) max		
Fluids controlled		Fresh water, or sea water (with Form Q)		
Materials		Cover: polypropylene, Noryl® thermoplastic resin or equivalent for Type 3R, Component material in contact with fluid: flange, zinc plated or equivalent (fluid entry), nitrile or equivalent rubber (diaphragm)		
Operating position		NEMA Type 1, and Type IP20 in any position, NEMA Type 3R in the vertical position only		
Vibration resistance		—		
Shock resistance		—		
Electric shock protection		—		
Degree of protection		NEMA Type 1, IP20 and NEMA Type 3R (some references) must be mounted in vertical position to maintain enclosure rating		
Operating rate	cycles/m	10		
Repeat accuracy		+/- 3 % of the range		
Fluid connection		1/8" NPSF internal, 1/4" NPSF internal, 1/2"NPT External, 1/4" Bayonet (barbed), 90 deg. Elbow 1/4" Bayonet, Four Way Flange, 3/8" NPSF (Internal), 1/4" Flare, other specials		
Electrical connection		2 open side entries, 3/4" diameter, with two flats		3 Conduit 1/2" Knockouts

Contact block characteristics

Type of contacts		One 2 pole, 2 N/C (4 terminal) contacts, snap action
Resistance across terminals	m Ω	< 25
Terminal referencing		N/A
Short-circuit protection	A	5,000
Connection		Screw clamp terminals. Clamping capacity up to #10 AWG (5.261 mm ²)
Electrical durability	cycles	100,000
Mechanical durability	cycles	300,000

Electrical Ratings

1 Pole		FRG			FHG ▲ ■			G		
Power ratings of controlled motors	Voltage	~ 1-phase	~ 3-phase	≡	~ 1-phase	~ 3-phase	≡	~ 1-phase	~ 3-phase	≡
	32 V	—	—	—	—	—	—	—	—	—
Note: Type FRG and G are all Form H	115 V	0.75 kW (1 HP)	—	0.18 kW (.25 HP)	1.1 kW (1.5 HP)	1.5 kW (2 HP)	0.18 kW (.25 HP)	0.75 kW (1 HP)	—	0.37 kW (.50 HP)
▲ Includes FHG 2, 3, 4, 9, 12, 13, 14, 19, 42, 44, 49	230 V	0.75 kW (1 HP)	—	0.18 kW (.25 HP)	1.5 kW (2 HP)	2.2 kW (3 HP)	0.18 kW (.25 HP)	1.5 kW (2 HP)	—	0.37 kW (.50 HP)
	460 / 575 V	—	—	—	—	0.75 kW (1 HP)	—	1.5 kW (2 HP)	—	—
2 Pole		~ 1-phase	~ 3-phase	≡	~ 1-phase	~ 3-phase	≡	~ 1-phase	~ 3-phase	≡
Note: ■ Includes FHG 22, 24, 29, 32, 33, 34, 39, 52, 54, 59	32 V	—	—	0.18 kW (.25 HP)	—	—	—	—	—	—
	115 V	0.75 kW (1 HP)	0.75 kW (1 HP)	0.18 kW (.25 HP)	1.5 kW (2 HP)	2.2 kW (3 HP)	0.37 kW (.50 HP)	1.5 kW (2 HP)	2.2 kW (3 HP)	0.75 kW (1 HP)
	230 V	0.75 kW (1 HP)	0.75 kW (1 HP)	0.18 kW (.25 HP)	2.2 kW (3 HP)	3.7 kW (5 HP)	0.37 kW (.50 HP)	2.2 kW (3 HP)	3.7 kW (5 HP)	0.75 kW (1 HP)
	460 / 575 V	—	—	—	—	0.75 kW (1 HP)	—	3.7 kW (5 HP)	3.7 kW (5 HP)	—

Commercial Pressure Switches

Electromechanical Square D Brand 9013
For power circuits, FSG
2-pole 2 N/C contacts
Degree of protection IP20, NEMA Type 1

Flange Style

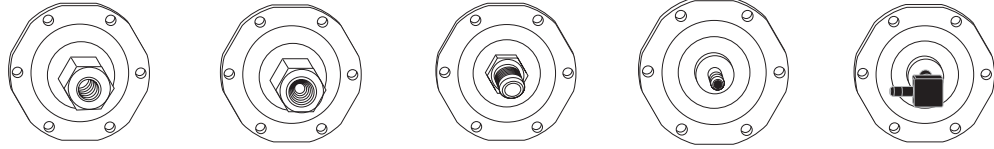

Adjustable range of switching point 1.4...4.6 bar (20.3...66.7 psi)
Contacts open on rising pressure

Differential	Adjustable				
Fluid connections	1/8" NPSF internal	1/4" NPSF internal	1/4" NPT external	1/4" Bayonet (barbed)	90 ° Elbow 1/4" Bayonet
References					
NEMA Type 1, IP20	9013FSG1	9013FSG2	9013FSG9	9013FSG10	9013FSG20
NEMA Type 3R ■	9013FSW1	9013FSW2	9013FSW9	9013FSW10	9013FSW20
Fluids controlled	Water	Water	Water	Water	Water
Pressure range					
Cut-Out PSIG (bar)	20-65 (1.4-4.5)	20-65 (1.4-4.5)	20-65 (1.4-4.5)	20-65 (1.4-4.5)	20-65 (1.4-4.5)
Cut-In PSIG (bar)	5-45 (0.3-3.1)	5-45 (0.3-3.1)	5-45 (0.3-3.1)	5-45 (0.3-3.1)	5-45 (0.3-3.1)
Weight lbs (kg)	0.75 lbs (0.340)	0.75 lbs (0.340)	0.75 lbs (0.340)	0.75 lbs (0.340)	0.75 lbs (0.340)

Complementary characteristics not shown under general characteristics

Differential PSIG (bar)	15-30 (1.03-2.06)
Maximum permissible pressure PSIG (bar)	65 (4.48)
Mechanical life	300,000 operating cycles
Cable entry	2 cable entries 0.88" (22.4mm)
Pressure switch type	Diaphragm

Ordering Information

- 1 Specify Class 9013 Type FSG.
- 2 Select pressure code and add code designation to end of type number. Be sure that pressure code falls within the limits of the device as shown in the device listings.
- 3 If special features are desired, add the appropriate Form letter to the Class and Type. Arrange Form letters in alphabetical sequence when ordering more than one special feature. If no packaging code is indicated, devices will be shipped individually packaged.
- 4 Place packaging code at end of sequence with other forms when ordering.
For standard pack of 20 devices per box C20
Example: 9013FSG2J21MIC20

Pressure Codes

Below is the pressure code table.
Existence of a code does not imply that the code is available for any or all devices.

Settings	Code
5-21 PSI	J15
8-20 PSI	J16
20-40 PSI	J20
20-50 PSI	J18
30-50 PSI	J21
40-60 PSI	J24
50-70 PSI	J33
55-85 PSI	J34
60-80 PSI	J25
Specify pressure settings	J99

■ Must be mounted in vertical position to maintain enclosure rating.

Commercial Pressure Switches

Electromechanical Square D Brand 9013

For power circuits, FSG
2-pole 2 N/C contacts
Degree of protection IP20, NEMA Type 1

Flange Style

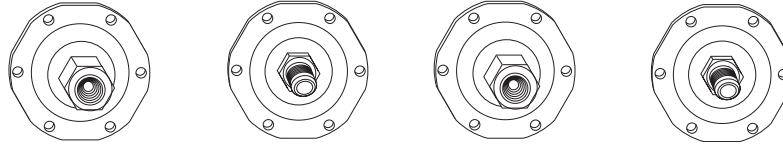

Adjustable range of switching point 1.4...4.6 bar (20.3...66.7 psi)
Contacts open on rising pressure

Differential	Adjustable				
Fluid connections	¼" NPSF internal	¼"NPT external	¼" NPSF internal	¼"NPT external	
References					
NEMA Type 1, IP20	9013FSG22	9013FSG29	9013FSG42	9013FSG49	9013FSG1 - 20 with M4 ♦
NEMA Type 3R ■	9013FSW22	9013FSW29	9013FSW42	9013FSW49	
Fluids controlled	Water	Water	Water	Water	Water
Pressure range					
Cut-Out PSIG (bar)	20-50 (1.4-3.5)	20-60 (1.4-4.1)	9-30 (0.6-3.1)	9-30 (0.6-3.1)	34-65 (2.3-4.5)
Cut-In PSIG (bar)	10-30 (0.7-2.1)	10-45 (0.7-3.1)	3-10 (0.2-0.7)	3-10 (0.2-0.7)	19-45 (1.3-3.1)
Weight lbs (kg)	0.75 lbs (0.340)	0.75 lbs (0.340)	0.75 lbs (0.340)	0.75 lbs (0.340)	0.75 lbs (0.340)

Complementary characteristics not shown under general characteristics

Differential PSIG (bar)	10-30 (0.7-2.1)	10-30 (0.7-2.1)	6-20 (0.4-1.4)	6-20 (0.4-1.4)	15-30 (1.0-2.1)
Maximum permissible pressure PSIG (bar)	50 (3.5)	60 (4.1)	30 (2.1)	30 (2.1)	65 (4.5)
Mechanical life (operating cycles)	300,000				
Cable entry	2 cable entries 0.88" (22.4mm) with 0.84" (21.3mm) across flat.				
Pressure switch type	Diaphragm				

Modifications

Descriptor	Applies to:	Form Letter
Standard pack of 20 devices per box	All type F	C20
Maintained manual cut-out lever (AUTO-OFF)	FSG, FYG	M1
Low pressure cut-off (AUTO-START-OFF) operates at approximately 10 PSIG below cut-in and will turn off the pump	FSG, FYG (Type 1-20 only)	M4
Pulsation plug (standard on FSG4)	FSG2, 9	P ♦
Salt water flange (¼ NPSF Internal only)	All type F	Q
Plastic flange (max. temp 120 F / max. pressure 80 psi)	FRG, FSG, FYG ¼ NPSF internal only	Q8
½" conduit bushing - ½" long thread - on left	All type F	T
½" conduit bushing - ½" long thread - on right	All type F	T1
Slip-on connections (load side terminals only)	FSG, FYG	U
Slip-on connectors (line and load terminals)	FSG, FYG	U2
Black cover	FSG, FYG	Z22

- ♦ Nylon pulsation plug can be field installed on types having 1/4" NPSF internal connector. Part number 1530S6G1 is one bag of 50 plugs.
- Must be mounted in vertical position to maintain enclosure rating.

Commercial Pressure Switches

Electromechanical Square D Brand 9013
For power circuits, FTG
2-pole 2 N/C contacts
Degree of protection IP20, NEMA Type 1

Flange Style

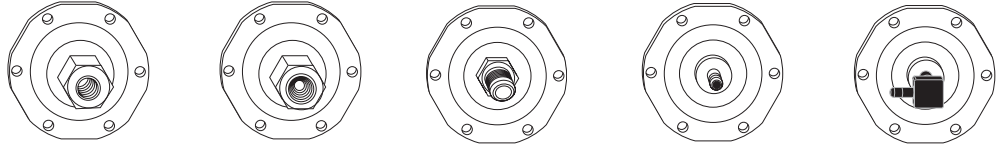

Non-adjustable range of switching point
Contacts open on rising pressure

Differential	Non-adjustable				
Fluid connections	1/8" NPSF internal	1/4" NPSF internal	1/4" NPT external	1/4" Bayonet (barbed)	90 ° Elbow 1/4" Bayonet
References					
NEMA Type 1, IP20	9013FTG1	9013FTG2	9013FTG9	9013FTG10	9013FTG20
NEMA Type 3R ■	9013FTW1	9013FTW2	9013FTW9	9013FTW10	9013FTW20
Fluids controlled	Water	Water	Water	Water	Water
Pressure range					
Cut-Out PSIG (bar)	20-65 (1.4-4.5)	20-65 (1.4-4.5)	20-65 (1.4-4.5)	20-65 (1.4-4.5)	20-65 (1.4-4.5)
Cut-In PSIG (bar)	N/A	N/A	N/A	N/A	N/A
Weight lbs (kg)	0.75 lbs (0.340)	0.75 lbs (0.340)	0.75 lbs (0.340)	0.75 lbs (0.340)	0.75 lbs (0.340)

Complementary characteristics not shown under general characteristics

Differential PSIG (bar)	20 (1.4)
Maximum permissible pressure PSIG (bar)	65 (4.5)
Mechanical life	300, 000 operating cycles
Cable entry	2 cable entries 0.88" (22.4mm) with 0.84" (21.3mm) across flat.
Pressure switch type	Diaphragm

Ordering Information

- 1 Specify Class 9013 Type FTG.
- 2 Select pressure code and add code designation to end of type number. Be sure that pressure code falls within the limits of the device as shown in the device listings.
- 3 If special features are desired, add the appropriate Form letter to the Class and Type. Arrange Form letters in alphabetical sequence when ordering more than one special feature. If no packaging code is indicated, devices will be shipped individually packaged.
- 4 Place packaging code at end of sequence with other forms when ordering. Sold in lots or multiples of 500.
Example: 9013FTG2J21C500

Pressure Codes

Below is the pressure code table.
Existence of a code does not imply that the code is available for any or all devices.

Settings	Code
5-21 PSI	J15
8-20 PSI	J16
20-40 PSI	J20
20-50 PSI	J18
30-50 PSI	J21
40-60 PSI	J24
50-70 PSI	J33
55-85 PSI	J34
60-80 PSI	J25
Specify pressure settings	J99

■ Must be mounted in vertical position to maintain enclosure rating.

Commercial Pressure Switches

Electromechanical Square D Brand 9013

For power circuits, FTG
2-pole 2 N/C contacts
Degree of protection IP20, NEMA Type 1

Flange Style

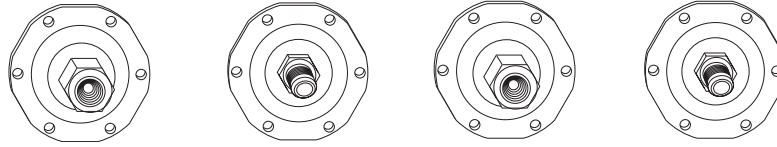

Non-adjustable range of switching point
Contacts open on rising pressure

Differential	Non-adjustable			
Fluid connections	1/4" NPSF internal	1/4" NPT external	1/4" NPSF internal	1/4" NPT external
References				
NEMA Type 1, IP20	9013FTG22	9013FTG29	9013FTG42	9013FTG49
NEMA Type 3R ■	9013FTW22	9013FTW29	9013FTW42	9013FTW49
Fluids controlled	Water	Water	Water	Water
Pressure range				
Cut-Out PSIG (bar)	20-50 (1.4-3.5)	20-60 (1.4-4.1)	9-30 (0.6-3.1)	9-30 (0.6-3.1)
Cut-In PSIG (bar)	N/A	N/A	N/A	N/A
Weight lbs (kg)	0.75 lbs (0.340)	0.75 lbs (0.340)	0.75 lbs (0.340)	0.75 lbs (0.340)
Complementary characteristics not shown under general characteristics				
Differential PSIG (bar)	20 (1.4)	15 (1.0)	20 (1.4)	20 (1.4)
Maximum permissible pressure PSIG (bar)	50 (3.5)	60 (4.1)	30 (3.1)	30 (3.1)
Mechanical life (operating cycles)	300,000			
Cable entry	2 cable entries 0.88" (22.4mm) with 0.84" (21.3mm) across flat.			
Pressure switch type	Diaphragm			

Modifications

Description	Applies to:	Form Letter
Standard pack of 500 devices per box	All type FTG	C500
Pulsation plug	FTG2, 9	P ◆
1/2" conduit bushing - 1/2" long thread - on left	All type FTG	T
1/2" conduit bushing - 1/2" long thread - on right	All type FTG	T1
Slip-on connectors (line and load terminals)	All type FTG, FYG	U2 ▲
Black cover	FTG, FYG	Z22

- ◆ Nylon pulsation plug can be field installed on types having 1/4" NPSF internal connector. Part number 1530S6G1 is one bag of 50 plugs.
- Must be mounted in vertical position to maintain enclosure rating.
- ▲ Slip-on connections on load side is standard

Commercial Pressure Switches

Electromechanical Square D Brand 9013
For power circuits, FYG
2-pole 2 N/C contacts
Degree of protection IP20, NEMA Type 1

Flange Style

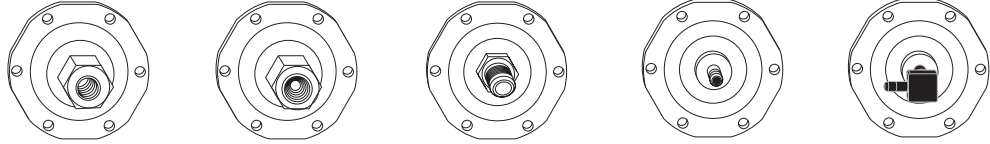

Adjustable range of switching point
Contacts open on rising pressure

Differential	Adjustable				
Fluid connections	1/8" NPSF internal	1/4" NPSF internal	1/4" NPT external	1/4" Bayonet (barbed)	90 ° Elbow 1/4" Bayonet
References					
NEMA Type 1, IP20	9013FYG1	9013FYG2	9013FYG9	9013FYG10	9013FYG20
NEMA Type 3R ■	9013FYW1	9013FYW2	9013FYW9	9013FYW10	9013FYW20
Fluids controlled	Water	Water	Water	Water	Water
Pressure range					
Cut-Out PSIG (bar)	25-80 (1.7-5.5)	25-80 (1.7-5.5)	25-80 (1.7-5.5)	25-80 (1.7-5.5)	25-80 (1.7-5.5)
Cut-In PSIG (bar)	5-60 (0.3-4.1)	5-60 (0.3-4.1)	5-60 (0.3-4.1)	5-60 (0.3-4.1)	5-60 (0.3-4.1)
Weight lbs (kg)	0.75 lbs (0.340)	0.75 lbs (0.340)	0.75 lbs (0.340)	0.75 lbs (0.340)	0.75 lbs (0.340)

Complementary characteristics not shown under general characteristics

Differential PSIG (bar)	20-30 (1.4-2.1)
Maximum permissible pressure PSIG (bar)	80 (5.5)
Mechanical life	300, 000 operating cycles
Cable entry	2 cable entries 0.88" (22.4mm) with 0.84" (21.3mm) across flat.
Pressure switch type	Diaphragm

Ordering Information

- 1 Specify Class 9013 Type FYG.
- 2 Select pressure code and add code designation to end of type number. Be sure that pressure code falls within the limits of the device as shown in the device listings.
- 3 If special features are desired, add the appropriate Form letter to the Class and Type. Arrange Form letters in alphabetical sequence when ordering more than one special feature.
- 4 Place packaging code at end of sequence with other forms when ordering. If no packaging code is indicated, devices will be shipped individually packaged.
For standard pack of 20 devices per box C20
Example: 9013FYG2J21C20

Pressure Codes

Below is the pressure code table.
Existence of a code does not imply that the code is available for any or all devices.

Settings	Code
5-21 PSI	J15
8-20 PSI	J16
20-40 PSI	J20
20-50 PSI	J18
30-50 PSI	J21
40-60 PSI	J24
50-70 PSI	J33
55-85 PSI	J34
60-80 PSI	J25
Specify pressure setting	J99

- Must be mounted in vertical position to maintain enclosure rating.

Commercial Pressure Switches

Electromechanical Square D Brand 9013

For power circuits, FYG
2-pole 2 N/C contacts
Degree of protection IP20, NEMA Type 1

Flange Style

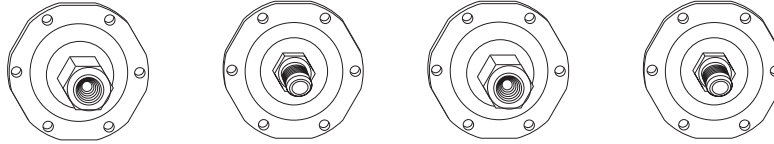

Adjustable range of switching point
Contacts open on rising pressure

Differential	Adjustable				
Fluid connections	1/4" NPSF internal	1/4" NPT external	1/4" NPSF internal	1/4"NPT external	
References					
NEMA Type 1, IP20	9013FYG22	9013FYG29	9013FYG42	9013FYG49	9013FYG1 - 20 FYG20 with M4 ♦
NEMA Type 3R ■	9013FYW22	9013FYW29	9013FYW42	9013FYW49	
Fluids controlled	Water	Water	Water	Water	Water
Pressure range					
Cut-Out PSIG (bar)	25-50 (1.7-3.5)	20-60 (1.4-4.1)	9-40 (0.6-2.8)	9-40 (0.6-2.8)	39-80 (2.1-5.5)
Cut-In PSIG (bar)	10-30 (0.7-2.1)	10-45 (0.7-3.1)	3-10 (0.2-0.7)	3-10 (0.2-0.7)	19-60 (1.3-4.1)
Weight lbs (kg)	0.75 lbs (0.340)	0.75 lbs (0.340)	0.75 lbs (0.340)	0.75 lbs (0.340)	0.75 lbs (0.340)

Complementary characteristics not shown under general characteristics

Differential PSIG (bar)	10-30 (0.7-3.1)	10-30 (0.7-3.1)	6-20 (0.4-1.4)	6-20 (0.4-1.4)	20-30 (1.4-2.1)
Maximum permissible pressure PSIG (bar)	50 (3.5)	60 (4.1)	40 (2.8)	40 (2.8)	80 (5.5)
Mechanical life (operating cycles)	300,000				
Cable entry	2 cable entries 0.88" (22.4mm) with 0.84" (21.3mm) across flat.				
Pressure switch type	Diaphragm				

Modifications

Descripton	Applies to:	Form Letter
Standard pack of 20 devices per box	All Type F	C20
Maintained manual cut-out lever (AUTO-OFF)	FSG, FYG	M1
Low pressure cut-off (AUTO-START-OFF) operates at approximately 10 PSIG below cut-in and will turn off the pump	FSG, FYG (Type 1-20 only)	M4
Pulsation plug (standard on FYG4)	FYG2, 9	P ♦
Salt water flange (¼ NPSF Internal only)	All Type F	Q
Plastic flange (max. temp 120 F / max. pressure 80 psi)	FRG, FSG, FYG ¼ NPSF internal only	Q8
½" conduit bushing - ½" long thread - on left	All type F	T
½" conduit bushing - ½" long thread - on right	All type F	T1
Slip-on connectors (load side terminals only)	FSG, FYG	U
Slip-on connectors (line and load terminals)	FSG, FYG	U2
Black cover	FSG, FYG	Z22

- ♦ Nylon pulsation plug can be field installed on types having 1/4" NPSF internal connector. Part number 1530S6G1 is one bag of 50 plugs.
- Must be mounted in vertical position to maintain enclosure rating.

Commercial Pressure Switches

Electromechanical Square D Brand 9013
For power circuits, FRG
1 or 2-pole 2 N/O contacts
Degree of protection IP20, NEMA Type 1

Flange Style

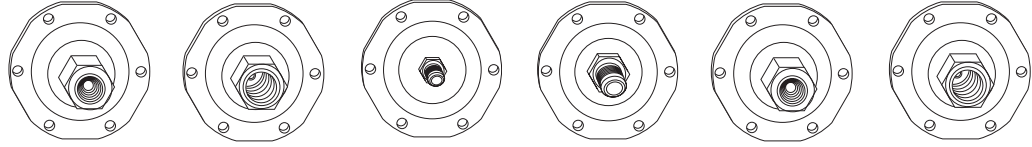

Adjustable range of switching point
Contacts open on falling pressure

Differential	Adjustable					
Fluid connections	1/4" NPSF internal	3/8" NPSF internal	1/4" Flare	1/4" NPT external	1/4" NPSF internal	3/8" NPSF internal
References						
NEMA Type 1, IP20 1 pole	9013FRG12	9013FRG13	9013FRG18	9013FRG19	9013FRG32	9013FRG33
NEMA Type 1, IP20 2 pole	9013FRG2	9013FRG3	9013FRG8	9013FRG9	9013FRG22	9013FRG23
Fluids controlled	Water	Water	Water	Water	Water	Water
Pressure range						
Cut-Out PSIG (bar)	8-45 (0.6-3.1)	8-45 (0.6-3.1)	8-45 (0.6-3.1)	8-45 (0.6-3.1)	4-25 (0.3-1.7)	4-25 (0.3-1.7)
Cut-In PSIG (bar)	23-65 (1.6-4.5)	23-65 (1.6-4.5)	23-65 (1.6-4.5)	23-65 (1.6-4.5)	10-45 (0.7-3.1)	10-45 (0.7-3.1)
Weight lbs (kg)	0.75 lbs (0.340)	0.75 lbs (0.340)	0.75 lbs (0.340)	0.75 lbs (0.340)	0.75 lbs (0.340)	0.75 lbs (0.340)

Complementary characteristics not shown under general characteristics

Differential PSIG (bar)	15-30 (1.0-2.1)	15-30 (1.0-2.1)	15-30 (1.0-2.1)	15-30 (1.0-2.1)	6-20 (0.4-1.4)	6-20 (0.4-1.4)
Maximum permissible pressure PSIG (bar)	65 (4.5)	65 (4.5)	65 (4.5)	65 (4.5)	45 (3.1)	45 (3.1)
Mechanical life	300,000 operating cycles					
Cable entry	2 cable entries 0.88" (22.4mm) with 0.84" (21.3mm) across flat.					
Pressure switch type	Diaphragm					

Ordering Information

- 1 Specify Class 9013 Type FRG.
- 2 Select pressure code and add code designation to end of type number. Be sure that pressure code falls within the limits of the device as shown in the device listings.
- 3 If special features are desired, add the appropriate Form letter to the Class and Type. Arrange Form letters in alphabetical sequence when ordering more than one special feature.
- 4 Place packaging code at end of sequence with other forms when ordering. If no packaging code is indicated, devices will be shipped individually packaged.
For standard pack of 20 devices per box C20
Example: 9013FRG19M3J23C20

Pressure Codes

Below is the pressure code table.
Existence of a code does not imply that the code is available for any or all devices.

Settings	Code
8.5-5.5 PSI	J17
10-5 PSI	J36
22-12 PSI	J22
22-16 PSI	J19
35-20 PSI	J70
40-20 PSI	J23
50-30 PSI	J35
80-60 PSI	J32
100-80 PSI	J51
150-120	J64
Specify pressure setting	J99

Commercial Pressure Switches

Electromechanical Square D Brand 9013

For power circuits, FRG

1 or 2-pole 2 N/O contacts Degree of protection IP20,
NEMA Type 1

Flange Style

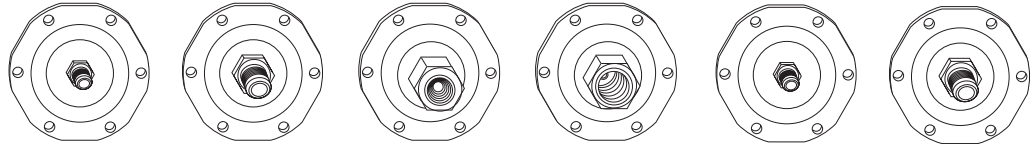

Adjustable range of switching point
Contacts open on falling pressure

Differential	Adjustable			Non-adjustable		
Fluid connections	1/4" Flare	1/4" NPT external	1/4" NPSF internal	3/8" NPSF internal	1/4" Flare	1/4" NPT external
References						
NEMA Type 1, IP20 1 pole	9013FRG38	9013FRG39	9013FRG52 ▶	9013FRG53 ▶	9013FRG58 ▶	9013FRG59 ▶
NEMA Type 1, IP20 2 pole	9013FRG28	9013FRG29	9013FRG42 ▶	9013FRG43 ▶	9013FRG48 ▶	9013FRG49 ▶
Fluids controlled	Water	Water	Water	Water	Water	Water
Pressure range						
Cut-Out PSIG (bar)	4-25 (0.3-1.7)	4-25 (0.3-1.7)	1-11 (0.1-0.8)	1-11 (0.1-0.8)	1-11 (0.1-0.8)	1-11 (0.1-0.8)
Cut-In PSIG (bar)	10-45 (0.7-3.1)	10-45 (0.7-3.1)	6-14 (0.4-1.0)	6-14 (0.4-1.0)	6-14 (0.4-1.0)	6-14 (0.4-1.0)
Weight lbs (kg)	0.75 lbs (0.340)	0.75 lbs (0.340)	0.75 lbs (0.340)	0.75 lbs (0.340)	0.75 lbs (0.340)	0.75 lbs (0.340)

Complementary characteristics not shown under general characteristics

Differential PSIG (bar)	6-20 (0.4-1.4)	6-20 (0.4-1.4)	5 (0.3)	5 (0.3)	5 (0.3)	5 (0.3)
Maximum permissible pressure PSIG (bar)	45 (3.1)	45(3.1)	14 (1.0)	14 (1.0)	14 (1.0)	14 (1.0)
Mechanical life (operating cycles)	300,000					
Cable entry	2 cable entries 0.88" (22.4mm) with 0.84" (21.3mm) across flat.					
Pressure switch type	Diaphragm					

Modifications

Descripton	Applies to:	Form Letter
Standard pack of 20 devices per box	All Type F	C20
One normally open / One normally closed contact	FRG (2 pole only)	H
Momentary manual cut-in lever (AUTO-START)	FRG2-59 only	M3
Maintained manual cut-in lever (AUTO-ON)	FRG2-59 only	M5
Pulsation plug	FRG2, 9	P ♦
Salt water flange (¼ NPSF Internal only)	All Type F	Q
Plastic flange (max. temp 120 F / maz. pressure 80 psi)	FRG, FSG, FYG ¼ NPSF internal only	Q8
½" conduit bushing - ½" long thread - on left	All type F	T
½" conduit bushing - ½" long thread - on right	All type F	T1
Black cover	FSG, FYG, FRG	Z22

♦ Nylon pulsation plug can be field installed on types having 1/4" NPSF internal connector. Part number 1530S6G1 is one bag of 50 plugs.

Commercial Pressure Switches

Electromechanical Square D Brand 9013

For power circuits, FRG
1 or 2-pole 2 N/O contacts Degree of protection IP20,
NEMA Type 1

Flange Style

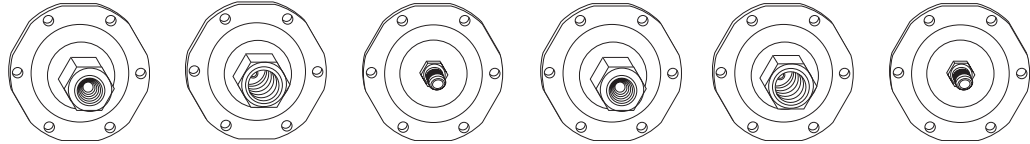

Adjustable range of switching point
Contacts open on falling pressure

Differential	Adjustable					
Fluid connections	1/4" NPSF internal	3/8" NPSF internal	1/4" Flare	1/4" NPSF internal	3/8" NPSF internal	1/4" Flare
References						
NEMA Type 1, IP20 1 pole	9013FRG72	9013FRG73	9013FRG78	9013FRG92	9013FRG93	9013FRG98
NEMA Type 1, IP20 2 pole	9013FRG62	9013FRG63	9013FRG68	9013FRG82	9013FRG83	9013FRG88
Fluids controlled	Water	Water	Water	Water	Water	Water
Pressure range						
Cut-Out PSIG (bar)	20-75 (1.4-5.2)	20-75 (1.4-5.2)	20-75 (1.4-5.2)	35-120 (2.4-8.3)	35-120 (2.4-8.3)	35-120 (2.4-8.3)
Cut-In PSIG (bar)	40-100 (2.8-6.9)	40-100 (2.8-6.9)	40-100 (2.8-6.9)	65-150 (4.5-10.3)	65-150 (4.5-10.3)	65-150 (4.5-10.3)
Weight lbs (kg)	0.75 lbs (0.340)	0.75 lbs (0.340)	0.75 lbs (0.340)	0.75 lbs (0.340)	0.75 lbs (0.340)	0.75 lbs (0.340)
Complementary characteristics not shown under general characteristics						
Differential PSIG (bar)	20-30 (1.4-2.1)	20-30 (1.4-2.1)	20-30 (1.4-2.1)	30-45 (2.1-3.1)	30-45 (2.1-3.1)	30-45 (2.1-3.1)
Maximum permissible pressure PSIG (bar)	100 (6.9)	100 (6.9)	100 (6.9)	150 (10.3)	150 (10.3)	150 (10.3)
Mechanical life	300, 000 operating cycles					
Cable entry	2 cable entries 0.88" (22.4mm) with 0.84" (21.3mm) across flat.					
Pressure switch type	Diaphragm					

Ordering Information

Pressure Codes

- Specify Class 9013 Type FRG.
- Select pressure code and add code designation to end of type number. Be sure that pressure code falls within the limits of the device as shown in the device listings.
- If special features are desired, add the appropriate Form letter to the Class and Type. Arrange Form letters in alphabetical sequence when ordering more than one special feature. If no packaging code is indicated, devices will be shipped individually packaged.
- Place packaging code at end of sequence with other forms when ordering.
For standard pack of 20 devices per box C20
For individual packaged devices leave blank
Example: 9013FRG72J23C20

Below is the pressure code table.
Existence of a code does not imply that the code is available for any or all devices.

Settings	Code
8.5-5.5 PSI	J17
10-5 PSI	J36
22-12 PSI	J22
22-16 PSI	J19
35-20 PSI	J70
40-20 PSI	J23
50-30 PSI	J35
80-60 PSI	J32
100-80 PSI	J51
150-120	J64
Specify pressure setting	J99

Commercial Pressure Switches

Electromechanical Square D Brand 9013

For power circuits, FRG
1 or 2-pole 2 N/O contacts Degree of protection IP20,
NEMA Type 1

Flange Style

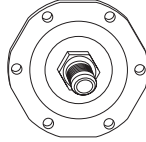

Adjustable range of switching point

Contacts open on falling pressure

Differential	Adjustable
Fluid connections	1/4" NPT external

References

NEMA Type 1, IP20 1 pole	9013FRG99
NEMA Type 1, IP20 2 pole	9013FRG89
Fluids controlled	Water
Pressure range	
Cut-Out PSIG (bar)	35-120 (2.4-8.3)
Cut-In PSIG (bar)	60-150 (4.14-10.3)

Weight lbs (kg)	0.75 lbs (0.340)
-----------------	------------------

Complementary characteristics not shown under general characteristics

Differential PSIG (bar)	30-45 (2,1-3.1)
Maximum permissible pressure PSIG (bar)	150 (10.3)
Mechanical life (operating cycles)	300,000
Cable entry	2 cable entries 0.88" (22.4mm) with 0.84" (21.3mm) across flat.
Pressure switch type	Diaphragm

Modifications

Descriptor	Applies to:	Form Letter
Standard pack of 20 devices per box	All Type F	C20
One normally open / One normally closed contact	FRG (2 pole only)	H
Momentary manual cut-in lever (AUTO-START)	FRG2-59 only	M3
Maintained manual cut-in lever (AUTO-ON)	FRG2-59 only	M5
Pulsation plug	FRG2, 9	P ♦
Salt water flange (¼ NPSF Internal only)	All Type F	Q
Plastic flange (max. temp 120 F / max. pressure 80 psi)	FRG, FSG, FYG ¼ NPSF internal only	Q8
½" conduit bushing - ½" long thread - on left	All type F	T
½" conduit bushing - ½" long thread - on right	All type F	T1
Black cover	FSG, FYG	Z22

♦ Nylon pulsation plug can be field installed on types having 1/4" NPSF internal connector. Part number 1530S6G1 is one bag of 50 plugs.

Commercial Pressure Switches

Electromechanical Square D Brand 9013
For power circuits FHG, Compressor
2-pole 2 N/C contacts
Degree of protection IP20, NEMA Type 1

Flange Style

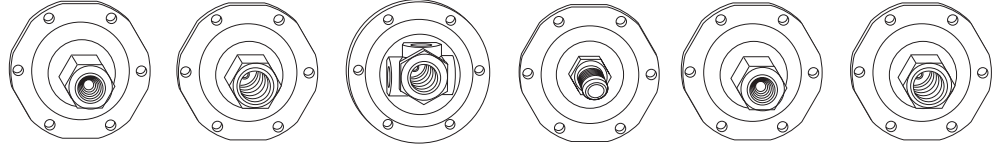

Adjustable range of switching point
Contacts open on rising pressure

Differential	Non-adjustable					
Pressure connections	1/4" NPSF internal	3/8" NPSF internal	1/4" 4 way flange	1/4" NPT external	1/4" NPSF internal	3/8" NPSF internal
References						
NEMA Type 1, IP20 - 2 pole - Lower hp	9013FHG2	9013FHG3	9013FHG44	9013FHG9	9013FHG12	9013FHG13
NEMA Type 1, IP20 - 2 pole -Higher hp	9013FHG22	—	9013FHG24	9013FHG29	9013FHG32	9013FHG33
Controls	Air	Air	Air	Air	Air	Air
Pressure range						
Adjustable Cut-Out PSIG (bar)	40-100 (2.8-6.9)	40-100 (2.8-6.9)	40-100 (2.8-6.9)	40-100 (2.8-6.9)	70-150 (4.8-10.3)	70-100 (4.8-10.3)
Weight lbs (kg)	0.75 lbs (0.340)	0.75 lbs (0.340)	0.75 lbs (0.340)	0.75 lbs (0.340)	0.75 lbs (0.340)	0.75 lbs (0.340)

Complementary characteristics not shown under general characteristics

Differential PSIG (bar) Non-adjustable	20 (1.4)	20 (1.4)	20 (1.4)	20 (1.4)	30 (2.1)	30 (2.1)
Maximum permissible pressure PSIG (bar)	100 (6.9)	100 (6.9)	100 (6.9)	100 (6.9)	150 (10.3)	150 (10.3)
Mechanical life	300, 000 operating cycles					
Cable entry	2 cable entries 0.88" (22.4mm) with 0.84" (21.3mm) across flat.					
Pressure switch type	Diaphragm					

Ordering Information

Pressure Codes

Below is the pressure code table.
Existence of a code does not imply that the code is available for any or all devices.

- Specify Class 9013 Type FHG.
- Select pressure code and add code designation to end of type number. Be sure that pressure code falls within the limits of the device as shown in the device listings.
- If special features are desired, add the appropriate Form letter to the Class and Type. Arrange Form letters in alphabetical sequence when ordering more than one special feature. If no packaging code is indicated, devices will be shipped individually packaged.
- Place packaging code at end of sequence with other forms when ordering.
For standard pack of 20 devices per box C20
Example: 9013FHG19J52MIXC20

Settings	Code
Off at 100 PSI	J27
Off at 110 PSI	J37
Off at 115 PSI	J38
Off at 120 PSI	J69
Off at 125 PSI	J52
Off at 135 PSI	J39
Off at 140 PSI	J68
Off at 150 PSI	J55
Off at 155 PSI	J40
Off at 175 PSI	J59
Specify pressure setting	J99

Commercial Pressure Switches

Electromechanical Square D Brand 9013
For power circuits FHG, Compressor
2-pole 2 N/C contacts
Degree of protection IP20, NEMA Type 1

Flange Style

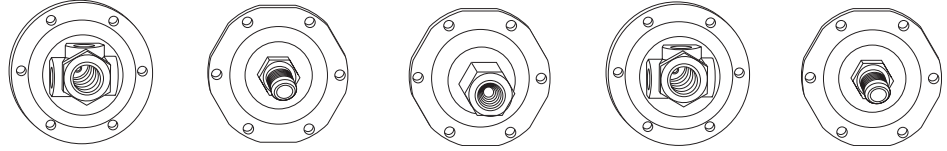

Adjustable range of switching point
Contacts open on rising pressure

Differential	Non-adjustable				
Pressure connections	Four way flange	1/4" NPT external	1/4" NPSF internal	Four way flange	1/4" NPT external
References					
NEMA Type 1, IP20 - 2 pole - Lower hp	9013FHG14	9013FHG19	9013FHG42	9013FHG44	9013FHG49
NEMA Type 1, IP20 - 2 pole - Higher hp	9013FHG34	9013FHG39	9013FHG52	9013FHG54	9013FHG59
Controls	Air	Air	Air	Air	Air
Pressure range					
Adjustable Cut-Out PSIG (bar)	70-150 (4.8-10.3)	70-150 (4.8-10.3)	100-200 (6.9-13.8)	100-200 (6.9-13.8)	100-200 (6.9-13.8)
Weight lbs (kg)	0.75 lbs (0.340)	0.75 lbs (0.340)	0.75 lbs (0.340)	0.75 lbs (0.340)	0.75 lbs (0.340)
Complementary characteristics not shown under general characteristics					
Differential PSIG (bar) Non-adjustable	30 (2.1)	30 (2.1)	40 (2.8)	40 (2.8)	40 (2.8)
Maximum permissible pressure PSIG (bar)	150 (10.3)	150 (10.3)	200 (13.8)	200 (13.8)	200 (13.8)
Mechanical life (operating cycles)	300,000				
Cable entry	2 cable entries 0.88" (22.4mm) with 0.84" (21.3mm) across flat.				
Pressure switch type	Diaphragm				

Modifications

Descripton	Form Letter
Standard pack of 20 devices per box	C20
Addition of a second ground screw	G4
Maintained manual cut-out lever (AUTO-OFF)	M1
Pulsation plug (copper)	P (not field installable)
1/2" conduit bushing - 1/2" long thread - on left	T
1/2" conduit bushing - 1/2" long thread - on right	T1
Slip-on connections (load side terminals only)	U
Slip-on connectors (line and load terminals)	U2
Factory sealed range stud	W
Two-way pressure release valve	X
Quick connect two-way pressure release valve (for use with Polyflow Tubing)	X1
Black cover	Z22

Commercial Pressure Switches

Electromechanical Square D Brand 9013
For power circuits, G
2-pole 2 N/C contacts
Degree of protection IP20, NEMA Type 1, 3R, 7 & 9

Flange Style

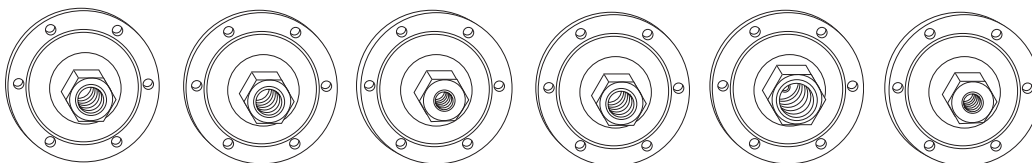

Adjustable range of switching point
Contacts open on rising pressure
2 Pole

Fluid connections	1/4" NPSF internal	1/4" NPSF internal	1/8" NPSF internal	1/4" NPSF internal	3/8" NPSF internal	1/8" NPSF internal
--------------------------	--------------------	--------------------	--------------------	--------------------	--------------------	--------------------

References

NEMA Type 1, IP20	9013GMG2		9013GSG1	9013GSG2	9013GSG3	
NEMA Type 3R ■		9013GSB2				
NEMA Type 7, NEMA Type 9						9013GSR1
Fluids / Pressure controlled	Water or Air	Water or Air	Water or Air	Water or Air	Water or Air	Water or Air
Pressure range						
Cut-Out PSIG (bar)	10-35 (0.7-2.4)	20-80 (1.4-5.5)	20-80 (1.4-5.5)	20-80 (1.4-5.5)	20-80 (1.4-5.5)	20-80 (1.4-5.5)
Cut-In PSIG (bar)	5.5-30.5 (0.4-2.1)	5-60 (0.4-4.1)	5-60 (0.4-4.1)	5-60 (0.4-4.1)	5-60 (0.4-4.1)	5-50 (0.4-4.1)
Weight lbs (kg)	2 lbs (0.91)	2 lbs (0.91)	2 lbs (0.91)	2 lbs (0.91)	2 lbs (0.91)	8 lbs (3.62)

Complementary characteristics not shown under general characteristics

Differential PSIG (bar)	4-8 (0.3-0.6)	15-30 (1.0-2.1)	15-30 (1.0-2.1)	15-30 (1.0-2.1)	15-30 (1.0-2.1)	20-40 (1.4-2.8)
Maximum permissible pressure PSIG (bar)	35 (2.4)	80 (5.5)	80 (5.5)	80 (5.5)	80 (5.5)	80 (5.5)
Mechanical life	300, 000 operating cycles					
Cable entry	3 Conduit 1/2" Knockouts	3 Conduit 1/2" Knockouts	3 Conduit 1/2" Knockouts	3 Conduit 1/2" Knockouts	3 Conduit 1/2" Knockouts	2 3/4"-14NPT
Pressure switch type	Diaphragm					

Ordering Information

Pressure Codes

Below is the pressure code table.
Existence of a code does not imply that the code is available for any or all devices.

Settings	Code
20-40 PSI	J20
30-50 PSI	J21
40-20 PSI	J23
40-60 PSI	J24
60-80 PSI	J25
70-90 PSI	J26
70-100 PSI	J28
75-100 PSI	J29
80-100 PSI	J30
90-120 PSI	J31
100-80 PSI	J51
100-125 PSI	J53
110-125 PSI	J54
110-150 PSI	J56
120-150 PSI	J57
125-150 PSI	J58
125-175 PSI	J60
130-175 PSI	J61
140-170 PSI	J66
140-175 PSI	J62
145-175 PSI	J63
150-120 PSI	J64
150-175 PSI	J67
215-250 PSI	J65
Specify pressure setting	J99

- 1 Specify Class 9013 Type G.
- 2 Select pressure code and add code designation to end of type number. Be sure that pressure code falls within the limits of the device as shown in the device listings.
- 3 If special features are desired, add the appropriate Form letter to the Class and Type. Arrange Form letters in alphabetical sequence when ordering more than one special feature.
- 4 Place packaging code at end of sequence with other forms when ordering. If no packaging code is indicated, devices will be shipped individually packaged.
For standard pack of 10 devices per box C10
Available on GHB, GHG, GSB, and GSG

See page 23 for Form C10.

■ Must be mounted in vertical position to maintain enclosure rating.

Commercial Pressure Switches

Electromechanical Square D Brand 9013

For power circuits, G

2-pole 2 N/C contacts

Degree of protection IP20, NEMA Type 3R, 4, 7 & 9

Flange Style

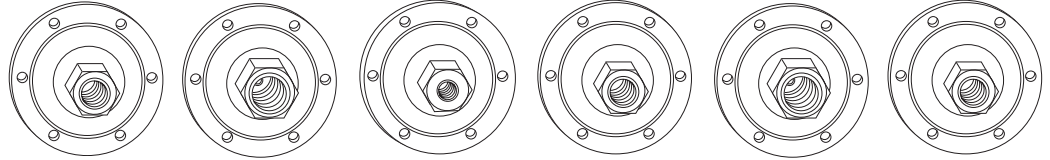

Adjustable range of switching point
Contacts open on rising pressure

Fluid connections	1/4" NPSF internal	3/8" NPSF internal	1/8" NPSF internal	1/4" NPSF internal	3/8" NPSF internal	1/4" NPSF internal
References						
NEMA Type 3R						9013GHB2
NEMA Type 4			9013GSW1	9013GSW2	9013GSW3	
NEMA Type 7, NEMA Type 9	9013GSR2	9013GSR3				
Fluids / Pressure controlled	Water or Air	Water or Air	Water or Air	Water or Air	Water or Air	Water or Air
Pressure range						
Cut-Out PSIG (bar)	20-80	20-80	20-80	20-80	20-80	60-200
Cut-In PSIG (bar)	5-50	5-50	5-50	5-50	5-50	40-170
Weight lbs (kg)	8 lbs (3.62)	8 lbs (3.62)	8 lbs (3.62)	8 lbs (3.62)	8 lbs (3.62)	2 lbs (0.91)
Complementary characteristics not shown under general characteristics						
Differential PSIG (bar)	20-40 (1.4-2.8)	20-40 (1.4-2.8)	20-40 (1.4-2.8)	20-40 (1.4-2.8)	20-40 (1.4-2.8)	20-40 (1.4-2.8)
Maximum permissible pressure PSIG (bar)	80 (5.5)	80 (5.5)	80 (5.5)	80 (5.5)	80 (5.5)	200 (13.8)
Mechanical life (operating cycles)	300,000					
Cable entry	2 3/4"-14 NPT	2 3/4"-14 NPT	2 3/4"-14 NPT	2 3/4"-14 NPT	2 3/4"-14 NPT	3 Conduit 1/2" Knockouts
Pressure switch type	Diaphragm					

Modifications

Description	Applies to:	Form Letter
Standard pack of 10 devices per box	GHB, GHG, GSB, GSG	C10
3-Way lever (On-Auto-Off) not compatible with Form X	GHG, GMG, GSG	E
One normally open / One normally closed contact	All type G	H ●
Pulsation plug (copper)	All type G	P (not field installable)
Reverse action / Two normally open contacts	All type G	R ●
Slip-on connectors (load side terminals only)	All type G	U
Slip-on connectors (line and load terminals)	All type G	U2
2-Way pressure release valve (not compatible with Form E)	GHB, GMG, GSB, GHG, GSG, GHR, GHW, GSR, GSW	X
1/4" Male pipe thread on pressure connection	All type G	Z
1/2" - 14 NPT external	All type G	Z16
1/4" - 18 NPT internal		
3/8" Male pipe thread on pressure connection	All type G	Z23

● Cannot order Form R when ordering Form H

Commercial Pressure Switches

Electromechanical Square D Brand 9013
For power circuits G
2-pole 2 N/C contacts
Degree of protection IP20, NEMA Type 1, 7 & 9

Flange Style

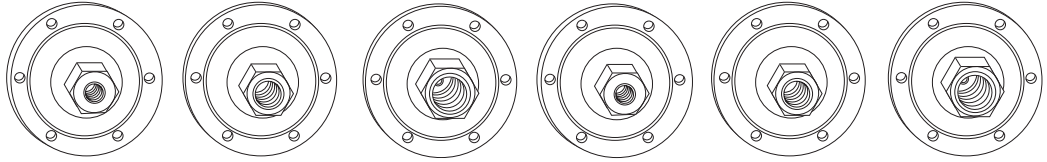

Adjustable range of switching point

Contacts open on rising pressure

2 Pole

Fluid connections	1/8" NPSF internal	1/4" NPSF internal	3/8" NPSF internal	1/8" NPSF internal	1/4" NPSF internal	3/8" NPSF internal
-------------------	--------------------	--------------------	--------------------	--------------------	--------------------	--------------------

References

NEMA Type 1, IP20	9013GHG1	9013GHG2	9013GHG3			
NEMA Type 7, NEMA Type 9				9013GHR1	9013GHR2	9013GHR3
Fluids / Pressure controlled	Water or Air	Water or Air	Water or Air	Water or Air	Water or Air	Water or Air
Pressure range						
Cut-Out PSIG (bar)	60-200	60-200	60-200	65-200	65-200	65-200
Cut-In PSIG (bar)	40-170	40-170	40-170	35-150	35-150	35-150
Weight lbs (kg)	2 lbs (0.91)	2 lbs (0.91)	2 lbs (0.91)	8 lbs (3.62)	8 lbs (3.62)	8 lbs (3.62)

Complementary characteristics not shown under general characteristics

Differential PSIG (bar)	20-40 (1.4-2.8)	20-40 (1.4-2.8)	20-40 (1.4-2.8)	30-50 (2.1-3.5)	30-50 (2.1-3.5)	30-50 (2.1-3.5)
Maximum permissible pressure PSIG (bar)	80 (5.5)	80 (5.5)	80 (5.5)	80 (5.5)	80 (5.5)	200 (13.8)
Mechanical life	300,000 operating cycles					
Cable entry	3 Conduit 1/2" Knockouts	3 Conduit 1/2" Knockouts	3 Conduit 1/2" Knockouts	2 3/4"-14 NPT	2 3/4"-14 NPT	2 3/4"-14 NPT
Pressure switch type	Diaphragm					

Ordering Information

Pressure Codes

Below is the pressure code table.
Existence of a code does not imply that the code is available for any or all devices.

Settings	Code
20-40 PSI	J20
30-50 PSI	J21
40-20 PSI	J23
40-60 PSI	J24
60-80 PSI	J25
70-90 PSI	J26
70-100 PSI	J28
75-100 PSI	J29
80-100 PSI	J30
90-120 PSI	J31
100-80 PSI	J51
100-125 PSI	J53
110-125 PSI	J54
110-150 PSI	J56
120-150 PSI	J57
125-150 PSI	J58
125-175 PSI	J60
130-175 PSI	J61
140-170 PSI	J66
140-175 PSI	J62
145-175 PSI	J63
150-120 PSI	J64
150-175 PSI	J67
215-250 PSI	J65
Specify pressure settings	J99

- Specify Class 9013 Type G.
- Select pressure code and add code designation to end of type number. Be sure that pressure code falls within the limits of the device as shown in the device listings.
- If special features are desired, add the appropriate Form letter to the Class and Type. Arrange Form letters in alphabetical sequence when ordering more than one special feature.
- Place packaging code at end of sequence with other forms when ordering. If no packaging code is indicated, devices will be shipped individually packaged.
For standard pack of 10 devices per box C10
Available on GHG, GHG, GSB, and GSG

See page 25 for Form C10.

Commercial Pressure Switches

Electromechanical Square D Brand 9013

For power circuits, G
2-pole 2 N/C contacts
Degree of protection IP20, NEMA Type 1, 3R, & 4

Flange Style

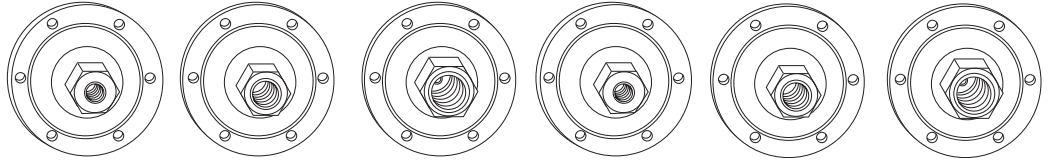

Adjustable range of switching point

Contacts open on rising pressure

2 Pole

Fluid connections	1/8" NPSF internal	1/4" NPSF internal	3/8" NPSF internal	1/4" NPSF internal	1/8" NPSF internal	1/4" NPSF internal
-------------------	--------------------	--------------------	--------------------	--------------------	--------------------	--------------------

References

NEMA Type 1, IP20					9013GHG4	9013GHG5
NEMA Type 3R				9013GHB5		
NEMA Type 4	9013GHW1	9013GHW2	9013GHW3			
Fluids / Pressure controlled	Water or Air	Water or Air	Water or Air	Water or Air	Water or Air	Water or Air
Pressure range						
Cut-Out PSIG (bar)	65-200 (4.5-13.8)	65-200 (4.5-13.8)	65-200 (4.5-13.8)	80-250 (5.5-17.2)	80-250 (5.5-17.2)	80-250 (5.5-17.2)
Cut-In PSIG (bar)	35-150 (2.4-10.3)	35-150 (2.4-10.3)	35-150 (2.4-10.3)	32-215 (2.2-14.8)	32-215 (2.2-14.8)	32-215 (2.2-14.8)
Weight lbs (kg)	8 lbs (3.62)	8 lbs (3.62)	8 lbs (3.62)	2 lbs (0.91)	2 lbs (0.91)	2 lbs (0.91)

Complementary characteristics not shown under general characteristics

Differential PSIG (bar)	30-50 (2.1-3.5)	30-50 (2.1-3.5)	30-50 (2.1-3.5)	25-45 (1.7-3.1)	25-45 (1.7-3.1)	25-45 (1.7-3.1)
Maximum permissible pressure PSIG (bar)	200 (13.8)	200 (13.8)	200 (13.8)	250 (17.2)	250 (17.2)	250 (17.2)
Mechanical life (operating cycles)	300,000					
Cable entry	2 3/4"-14 NPT	2 3/4"-14 NPT	2 3/4"-14 NPT	3 Conduit 1/2" Knockouts	3 Conduit 1/2" Knockouts	3 Conduit 1/2" Knockouts
Pressure switch type	Diaphragm					

Modifications

Description	Applies to:	Form Letter
Standard pack of 10 devices per box	GHB, GHG, GSB, GSG	C10
3-Way lever (On-Auto-Off) not compatible with Form X	GHG, GMG, GSG	E
One normally open / One normally closed contact	All type G	H ●
Pulsation plug (copper)	All type G	P (not field installable)
Reverse action / Two normally open contacts	All type G	R ●
Slip-on connectors (load side terminals only)	All type G	U
Slip-on connectors (line and load terminals)	All type G	U2
2-Way pressure release valve (not compatible with Form E)	GHB, GMG, GSB, GHG, GSG, GHR, GHW, GSR, GSW	X
1/4" Male pipe thread on pressure connection	All type G	Z
1/2" - 14 NPT external	All type G	Z16
1/4" - 18 NPT internal		
3/8" Male pipe thread on pressure connection	All type G	Z23

● Cannot order Form R when ordering Form H

Commercial Pressure Switches

Electromechanical Square D Brand 9013
For power circuits, G
2-pole 2 N/C contacts
Degree of protection IP20, NEMA Type 1, 4, 7 & 9

Flange Style

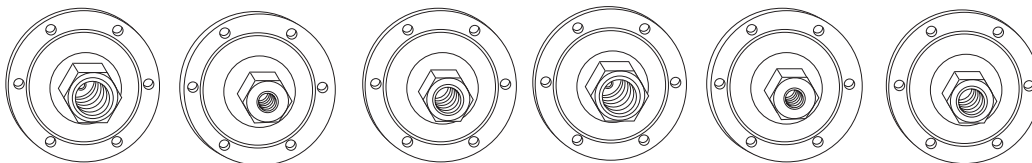

Adjustable range of switching point
Contacts open on rising pressure
2 Pole

Fluid connections	3/8" NPSF internal	1/8" NPSF internal	1/4" NPSF internal	3/8" NPSF internal	1/8" NPSF internal	1/4" NPSF internal
--------------------------	--------------------	--------------------	--------------------	--------------------	--------------------	--------------------

References

NEMA Type 1, IP20	9013GHG6					
NEMA Type 4					9013GHW4	9013GHW5
NEMA Type 7, NEMA Type 9		9013GHR4	9013GHR5	9013GHR6		
Fluids / Pressure controlled	Water or Air	Water or Air	Water or Air	Water or Air	Water or Air	Water or Air
Pressure range						
Cut-Out PSIG (bar)	80-250 (5.5-17.2)	80-250 (5.5-17.2)	80-250 (5.5-17.2)	80-250 (5.5-17.2)	80-250 (5.5-17.2)	80-250 (5.5-17.2)
Cut-In PSIG (bar)	32-215 (2.2-14.8)	30-190 (2.0-13.1)	30-190 (2.0-13.1)	30-190 (2.0-13.1)	30-190 (2.0-13.1)	30-190 (2.0-13.1)
Weight lbs (kg)	2 lbs (0.91)	8 lbs (3.62)	8 lbs (3.62)	8 lbs (3.62)	8 lbs (3.62)	8 lbs (3.62)

Complementary characteristics not shown under general characteristics

Differential PSIG (bar)	25-45 (1.7-3.1)	40-60 (2.8-4.1)	40-60 (2.8-4.1)	40-60 (2.8-4.1)	40-60 (2.8-4.1)	40-60 (2.8-4.1)
Maximum permissible pressure PSIG (bar)	250 (17.2)	250 (17.2)	250 (17.2)	250 (17.2)	250 (17.2)	250 (17.2)
Mechanical life	300, 000 operating cycles					
Cable entry	3 Conduit 1/2" Knockouts	2 3/4"-14NPT	2 3/4"-14 NPT	2 3/4"-14 NPT	2 3/4"-14 NPT	2 3/4"-14 NPT
Pressure switch type	Diaphragm					

Ordering Information

Pressure Codes

Below is the pressure code table.
Existence of a code does not imply that the code is available for any or all devices.

Settings	Code
20-40 PSI	J20
30-50 PSI	J21
40-20 PSI	J23
40-60 PSI	J24
60-80 PSI	J25
70-90 PSI	J26
70-100 PSI	J28
75-100 PSI	J29
80-100 PSI	J30
90-120 PSI	J31
100-80 PSI	J51
100-125 PSI	J53
110-125 PSI	J54
110-150 PSI	J56
120-150 PSI	J57
125-150 PSI	J58
125-175 PSI	J60
130-175 PSI	J61
140-170 PSI	J66
140-175 PSI	J62
145-175 PSI	J63
150-120 PSI	J64
150-175 PSI	J67
215-250 PSI	J65
Specify pressure settings	J99

- 1 Specify Class 9013 Type G.
- 2 Select pressure code and add code designation to end of type number. Be sure that pressure code falls within the limits of the device as shown in the device listings.
- 3 If special features are desired, add the appropriate Form letter to the Class and Type. Arrange Form letters in alphabetical sequence when ordering more than one special feature.
- 4 Place packaging code at end of sequence with other forms when ordering. If no packaging code is indicated, devices will be shipped individually packaged.
For standard pack of 10 devices per box C10
For individual packaged devices leave blank
Available on GHB, GHG, GSB, and GSG

Commercial Pressure Switches

Electromechanical Square D Brand 9013
For power circuits, G
2-pole 2 N/C contacts
Degree of protection IP20, NEMA Type 4, 7, & 9

Flange Style

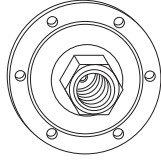

Adjustable range of switching point
Contacts open on rising pressure
2 Pole

Fluid connections	3/8" NPSF internal				
References					
NEMA Type 4	9013GHW6				
NEMA Type 7, NEMA Type 9					
Fluids / Pressure controlled	Water or Air				
Pressure range					
Cut-Out PSIG (bar)	80-250 (5.5-17.2)				
Cut-In PSIG (bar)	30-190 (2.0-13.1)				
Weight lbs (kg)	8 lbs (3.62)				
Complementary characteristics not shown under general characteristics					
Differential PSIG (bar)	40-60 (2.8-4.1)				
Maximum permissible pressure PSIG (bar)	250 (17.2)				
Mechanical life (operating cycles)	300,000				
Cable entry	2 3/4"-14 NPT				
Pressure switch type	Diaphragm				

Modifications

Descripton	Applies to:	Form Letter
Standard pack of 10 devices per box	All Type G	C10
3-Way lever (On-Auto-Off) not compatible with Form X	GHG, GMG, GSG	E
One normally open / One normally closed contact	All type G	H ◉
Pulsation plug (copper)	All type G	P (not field installable)
Reverse action	All type G	R ◉
Slip-on connectors (load side terminals only)	All type G	U
Slip-on connectors (line and load terminals)	All type G	U2
2-Way pressure release valve (not compatible with Form E)	GHB, GMG, GSB, GHG, GSG, GHR, GHW, GSR, GSW	X
1/4" Male pipe thread on pressure connection	All type G	Z
1/2" - 14 NPT external	All type G	Z16
1/4" - 18 NPT internal		
3/8" Male pipe thread on pressure connection	All type G	Z23

◉ Cannot order Form R when ordering Form H

Replacement contacts and diaphragms

Descripton	9998 Type:
Repl. Contact Kit 9013GHG, GSG, GHR, GSR, GMG Series C, All except Forms H & R	PC205
Repl. Contact Kit 9013GHG, GSG, GSR, GMG; 9036GG, GR, GW; 9037GG, GR, GW Series C, Form H only; 9016GVG, Form H	PC206
Repl. Contact Kit 9013GHG, GSG, GHR, GSR, GMG; 9036GR, GW Series C, Form R only; 9016GVG	PC207
Convuluted Diaphragm Assy. 9013GHG, GSG Series C	PC208
Diaphragm Assy. 9013GMG Series C	PC209
Diaphragm Assy. 9013GHW, GSW, GSR, GHR Series C	PC211
Diaphragm Assy. 9013GHG, GSG	PC252
Repl. Contact Kit 9013FSG	PC241 ❖
Repl. Contact Kit 9013FYG	PC242 ❖
Repl. Contact Kit 9013FRG (2 pole)	PC288 ❖
Repl. Contact Kit 9013FRG (1 pole)	PC289 ❖
Repl. Contact Kit 9013FRG (Form H)	PC290 ❖

❖ Diaphragm is included.

Commercial Pressure Switches

Electromechanical Square D Brand 9013
Compressor and Water Pump Pressure
Switches

Type F PUMPTROL® Compressor and Water Pump Pressure Switches

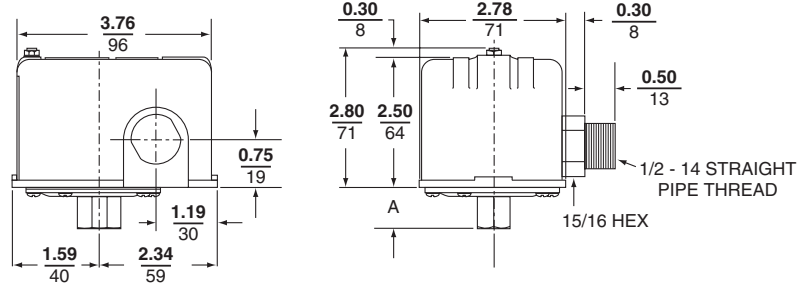

A Dimension

Switch Type

- FSG1, FYG1
- FHG2, 12, 22, 32, 42, 52, FRG2, FSG2, FYG2
- FHG3, 13, 33, FRG3, FSG3, FYG3
- FHG9, 19, 29, 39, 49, 59, FSG9, FYG9

Inches

mm

1 1/32	26
29/32	23
1 9/32	33
1 3/32	28

Type G Compressor and Water Pump Pressure Switches

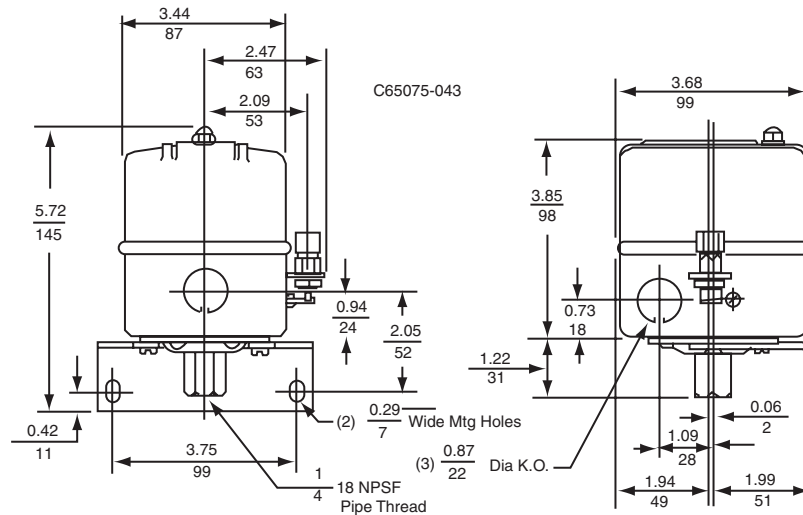

NOTE: Mounting Bracket shown is available as a Class 9049 Type A-52 Kit

Switch Type

- GHG, GSG - With or Without Form X

Commercial Pressure Switches

Electromechanical Square D Brand 9013
Commercial, Light Industrial Pressure Switches

Type G Compressor and Water Pump Pressure Switches

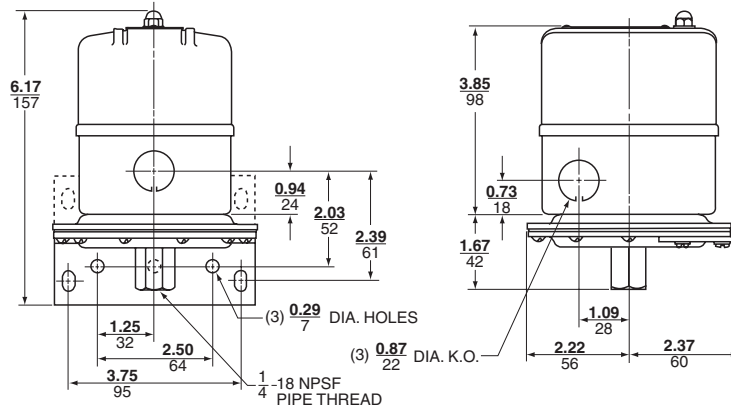

NOTE: MOUNTING BRACKET SHOWN IS AVAILABLE AS A CLASS 9049 TYPE A-53 KIT.

Switch Type
GMG

Numerics		
9013GHB223	
9013GSR122	
90133GSR223	
9013FHG220	
9013FHG1220	
9013FHG1320	
9013FHG1421	
9013FHG1921	
9013FHG2220	
9013FHG2420	
9013FHG2920	
9013FHG3220	
9013FHG3320	
9013FHG3320	
9013FHG3421	
9013FHG3921	
9013FHG4221	
9013FHG4420	
9013FHG4421	
9013FHG4921	
9013FHG5221	
9013FHG5421	
9013FHG5921	
9013FHG920	
9013FRG1216	
9013FRG1316	
9013FRG1816	
9013FRG1916	
9013FRG216	
9013FRG2216	
9013FRG2316	
9013FRG2817	
9013FRG2917	
9013FRG316	
9013FRG3216	
9013FRG3316	
9013FRG3817	
9013FRG3917	
9013FRG4217	
9013FRG4317	
9013FRG4817	
9013FRG4917	
9013FRG5217	
9013FRG5317	
9013FRG5817	
9013FRG5917	
9013FRG6218	
9013FRG6318	
9013FRG6818	
9013FRG7218	
9013FRG7318	
9013FRG7818	
9013FRG816	
9013FRG8218	
9013FRG8318	
9013FRG8818	
9013FRG8919	
9013FRG916	
9013FRG9218	
9013FRG9318	
9013FRG9818	
9013FRG9919	
9013FSG110	
9013FSG1010	
9013FSG1-20 w M4	.11	
9013FSG210	
9013FSG2010	
9013FSG2211	
9013FSG2911	
9013FSG4211	
9013FSG4911	
9013FSG910	
9013FSW110	
9013FSW1010	
9013FSW210	
9013FSW2010	
9013FSW2211	
9013FSW2911	
9013FSW4211	
9013FSW4911	
9013FSW910	
9013FTG112	
9013FTG1012	
9013FTG212	
9013FTG2012	
9013FTG2213	
9013FTG2913	
9013FTG4213	
9013FTG4913	
9013FTG912	
9013FTW112	
9013FTW1012	
9013FTW212	
9013FTW2012	
9013FTW2213	
9013FTW2913	
9013FTW4213	
9013FTW4913	
9013FTW912	
9013FYG114	
9013FYG1-20 w M4	.15	
9013FYG1014	
9013FYG214	
9013FYG2014	
9013FYG2215	
9013FYG2915	
9013FYG4215	
9013FYG4915	
9013FYG914	
9013FYW114	
9013FYW1014	
9013FYW214	
9013FYW2014	
9013FYW2215	
9013FYW2915	
9013FYW4215	
9013FYW4915	
9013FYW914	
9013GHB525	
9013GHG124	
9013GHG224	
9013GHG324	
9013GHG425	
9013GHG525	
9013GHG626	
9013GHR124	
9013GHR224	
9013GHR324	
9013GHR426	
9013GHR526	
9013GHR626	
9013GHW125	
9013GHW225	
9013GHW426	
9013GHW526	
9013GHW627	
9013GMG222	
9013GSB222	
9013GSG122	
9013GSG222	
9013GSG322	
9013GSR323	
9013GSW123	
9013GSW223	
9013GSW323	
9013GWW325	

Schneider Electric Industries SAS

Headquarters

89, bd Franklin Roosevelt
F - 92506 Rueil Malmaison Cedex

<http://www.schneider-electric.com>

9013CT9701R6/06

© 2006 Schneider Electric. All Rights Reserved.

Owing to changes in standards and equipment, the characteristics given in the text and images in this document are not binding until they have been confirmed with us.

Production : Schneider Electric Industries
Photos : Schneider Electric Industries
Printed by :



January 2007