

Centrifugal Pump Performance Curves and Technical Information

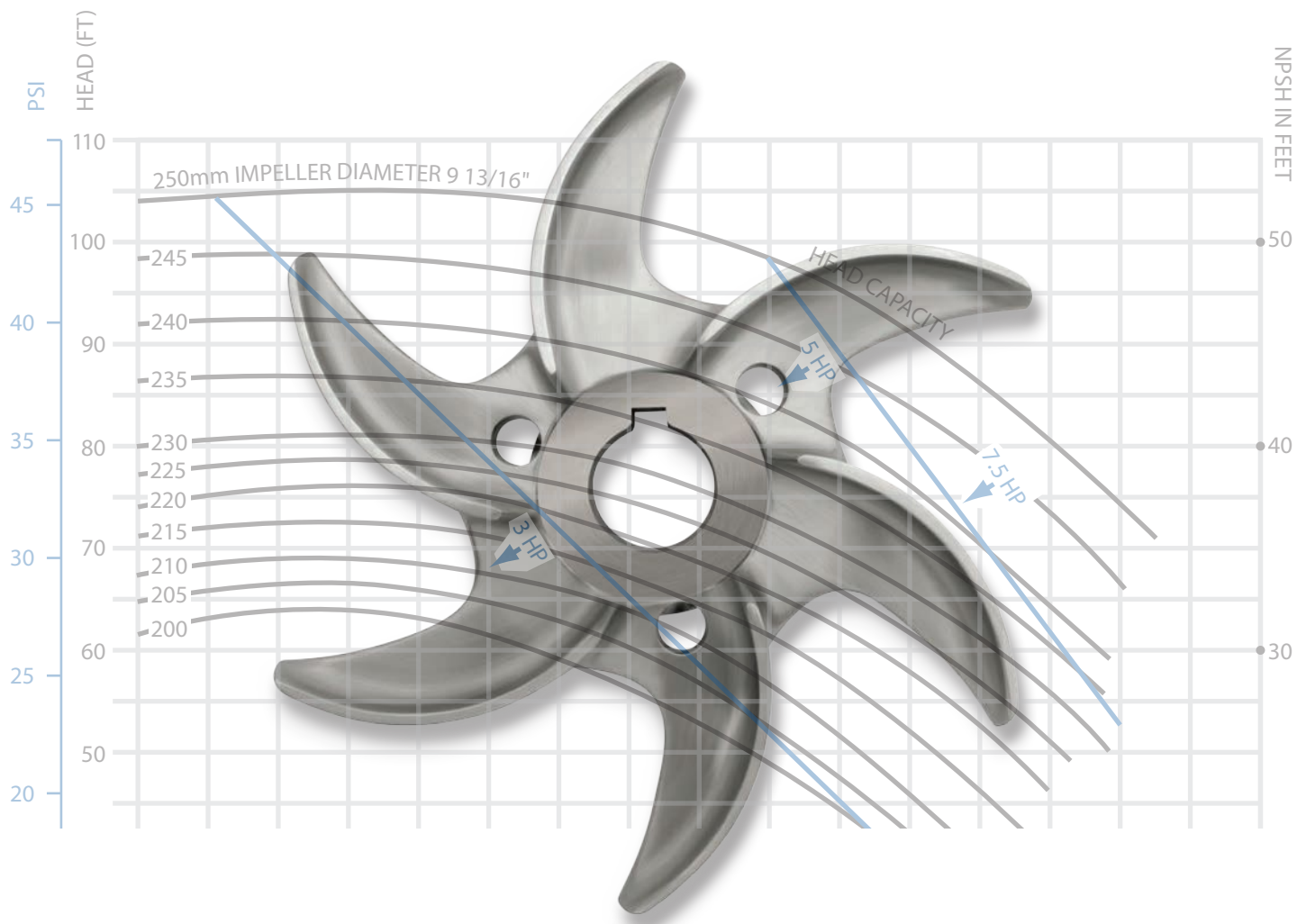

Table of Contents

Introduction	2
Pump basics	4
Selecting a pump	5
Pump inquiries application data sheet	7
How to calculate required pressure	8
Determining net positive suction head (NPSH)	8
Specific gravity and viscosity chart	9
Conversion factors	10
Vapor pressure chart	10
Tubing friction loss chart	11
Fristam centrifugal pump options	12
Pharmaceutical options	13
Pump Performance Curves: 1750 RPM	
FP/FPX Composites	14
FPR Composites	16
701	18
711	19
721	20
3521	21
731	22
3531	23
741	24
1741	25
3541	26
751	27
3451	28
3551	29
1051	30
1151	31
1161	32
4001	34
Pump Performance Curves: 3500 RPM	
FP/FPX Composite	35
FPR Composites	36
702	38
712	39
722	40
3522	41
732	42
1732	43
3532	44
742	45
1742	47
3542	49
752	50
3452	51
3552	52
Dimensional Drawings	
FP Single Flange	54
FP Double Flange	55
FPX Single Flange	56
FPX Double Flange	57
FPR Single Flange	58
FPR Double Flange	59
FPR 4001 Double Flange	60

Fristam Pride

Fristam is a global manufacturer of sanitary centrifugal and positive displacement pumps, mixers and blenders respected for unmatched performance, reliability, and technical superiority.

Fristam manufactured its first pump in 1931. Today, Fristam equipment is used by many of the world's top dairy, beverage, brewing, bio-pharmaceutical, and food processing companies.

High Lifetime Value

The solid design, precise machining, and robust construction of a Fristam pump ensures efficiency and operational reliability. Fristam pumps simply run better and last longer.

Quality Control

Fristam Pumps USA designs, manufactures, and assembles its pumps in the United States. Each component is carefully checked from raw material through final assembly.

The result of this effort is a pump worthy of the valuable product your company produces. To achieve the highest level of quality, Fristam offers the most comprehensive testing and documentation packages in the sanitary pump industry.



**Designed, Manufactured &
Assembled in Middleton, WI**

Experience and Expertise

Over the past 100 years, Fristam has built its reputation with experience, attention to detail, and a willingness to adapt to changing needs. Fristam's strong applications engineering capabilities make it the most reliable source for straight, smart answers to process needs.

Fast Delivery, New Solutions

Manufacturing in the United States ensures Fristam customers receive prompt delivery, not lead times measured in months.

Additionally, if a new production challenge arises, Fristam is responsive and able to develop new solutions quickly.

Dedicated Support

Fristam's dedication and quality service do not end with your initial purchase. An international network of manufacturing facilities, sales offices and distribution supports Fristam's commitment to customer satisfaction.

Why Customers Choose Fristam

"simply better pumps"

"reliable, dependable"

"high standard for sanitization and performance"

"knowledgeable people who help solve problems"

Pump Basics: Background Information

Pump Series – FP, FPX, or FPR

The FP, FPX, and FPR Series pumps are manufactured of 316L stainless steel and have the same pump head. The FP incorporates a heavy-duty pedestal flange between the motor and pump head. The FPX is a motor mounted pump used for standard duties. The FPR has a front-loading seal for easy changeout and may be used in place of either the FP or FPX. Double seals are only available in the FP and FPR. The FP is used for vacuum withdrawal, high temperature, high viscosity, aseptic processes and other demanding applications.

Pump Model/Housing Size

Fristam offers both volute and non-volute (circular) housings in many sizes to best match different process needs. The 700 and 1700 series pumps are non-volute and designed for lower capacities. Their shorter, steeper curves provide better efficiencies on low flows and superior accuracy when used with control devices. The 1050, 1150, 3400 and 3500 series pumps are volute high capacity pumps. Their long, flat curves provide greater capacity and an ability to provide steady discharge pressure over a wide flow range.

Speed

Pumps are sized using two standard speeds, 1750 and 3500 RPM. Speed selection is determined when selecting a housing. The last digit of the Fristam model number indicates the speed. All models ending in 1 are 1750 RPM. All models ending in 2 are 3500 RPM.

Efficiency

The efficiency of centrifugal pumps varies over the individual curve. The most efficient point of two curves is illustrated in Figure 1. When sizing, it is helpful to select a pump whose curve puts the duty point as close to this bend in the curve as possible.

Impeller Size

Within a given housing, the impeller diameter will determine the flow and pressure produced. Pressure results from the velocity achieved within the pump. The highest velocity occurs at the tip of the impeller and is directly proportional to the square of the impeller diameter. At a given speed, a larger diameter impeller will impart more velocity and produce more pressure.

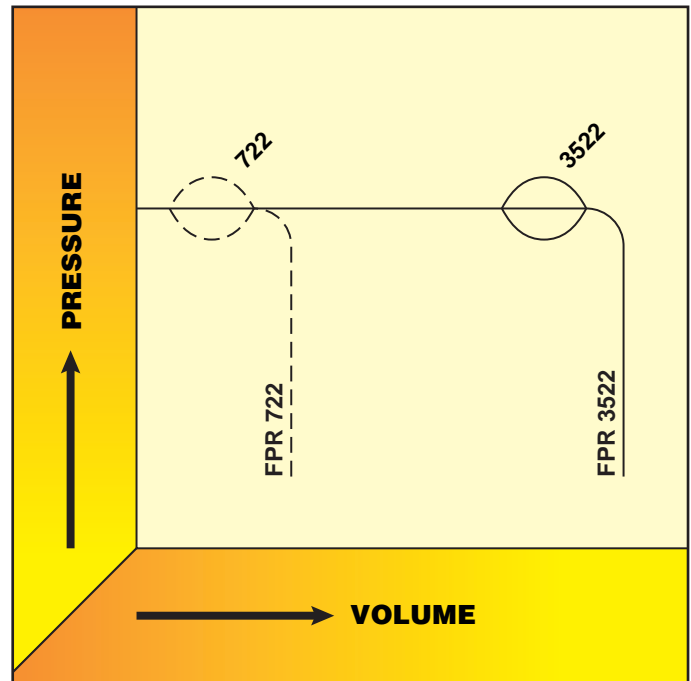

Figure 1

Horsepower

Horsepower must be matched to a given duty or duties. The requirements are determined by individual curves. Enough horsepower must be supplied to handle the most demanding duty, often the duty requiring the most flow, pressure or the pumping of the heaviest product.

Net Positive Suction Head (NPSH)

Product must be forced into a centrifugal pump for it to function properly. This force is called NPSH. Your process must have sufficient NPSH available to meet or exceed the NPSH required.

Seals

Fristam offers a wide selection of seals. Most processes require a standard single seal of chrome oxide coated stainless steel on carbon. More difficult applications will require harder seal materials such as silicon carbide. Double seals are used when a flush is required, where abrasion or stickiness is a problem, for vacuum withdrawal or if a sterile barrier is required between the process and atmosphere.

Selecting a Fristam Pump: A Step by Step Guide

Special Considerations

All curves are based on 70°F water. If your process involves products under vacuum, with high viscosity, high specific gravity, high temperatures, undissolved solids or entrained air there are special considerations which affect pump selection. In such cases, please consult Fristam Pumps or your local Fristam distributor.

Selecting a Pump Model From the Composite Curves

Composite curves appear at the beginnings of the low- and high-speed sections. To select the correct pump model from the composite curves, find the desired flow rate along the bottom scale and the desired pressure on the left-hand vertical scale. Find the point where the vertical line from the flow rate and a horizontal line from the pressure intersect. The curve immediately above this point will be most suitable.

Example

As an example, size a pump to pump 50 gallons per minute and generate 135 feet of head. In the composite shown in Figure 2, find the intersection point of 50 GPM on the bottom of the graph and 135 feet on the side. The pump curve directly above the duty point is the 722. In this example, model 742 (the next size larger) might also be considered. A quick review of the duty point on their individual curves reveals the 722 will be more efficient than the 742.

Considering Speed and Efficiency

If both pumps are the same speed, consider which will be more efficient based on the information discussed in Figure 1. If both a high and low speed pump can handle the duty, the high speed will generally be more economical, but the low speed model may have a lower NPSH requirement.

Figure 2

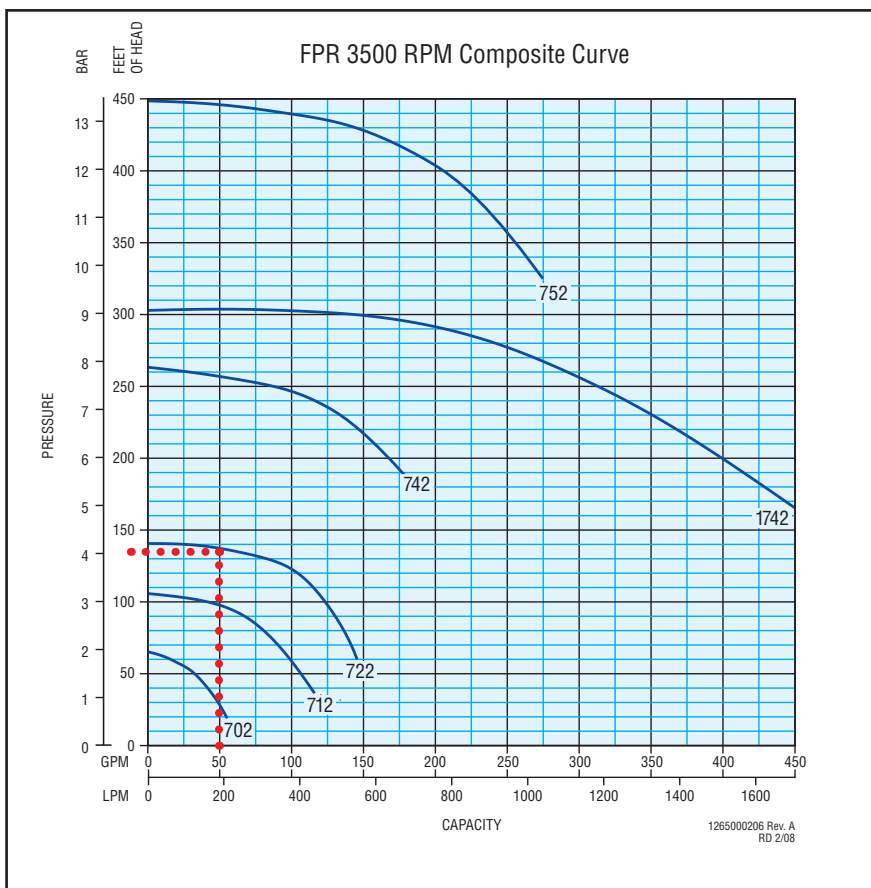

Choosing Impeller Size and Horsepower

Having chosen a pump model based on the first two steps, find the specific curve for the pump model chosen. To determine the impeller diameter and horsepower move vertically from the flow and horizontally from the pressure or head desired. Find the intersecting point.

The next higher curve indicates the correct impeller diameter. The diagonal line immediately to the right of the intersection identifies the motor horsepower required.

Example

Using our previous example of 50 gallons per minute and 135 feet of head, we can determine from Figure 3 that the impeller diameter should be 145 millimeters (5.7 inches). The motor required is 5 horsepower.

Checking NPSH (Net Positive Suction Head)

To assure there is sufficient product pressure at the inlet of the pump the suction conditions need to be checked. The NPSH required can be determined by finding the point on the individual pump curve where the vertical line from the desired flow rate intersects the NPSH curve. From this point, a horizontal line to the right will intersect the NPSH scale at the net positive suction head required.*

The procedure for determining the NPSH available is described in the “How To Calculate Required Pressure” section of this book. When the NPSH available is determined, it must meet or exceed the NPSH required for the pump to function properly. If the NPSH available is insufficient, a change to the inlet conditions, an enlarged inlet or another pump selection may be required.

Example

A 722 pumping 50 GPM against 135 feet of head will require 6 feet or more of NPSH. The installation must provide at least 6 feet of head.

Elastomers

Viton is the standard seal elastomer and BUNA is standard for the cover gasket. Other materials and combinations are available to meet your application or process needs.

Seal Selection: Single or Double

Many applications require only single seals. Double seals are recommended for applications involving:

- Abrasive products
- Sticky products
- Vacuum >14” Hg
- Temperature regulation

Seal Selection: Materials

Recommended seal material configurations:

- Simple transfer applications: FR-N-(K)*
 - Sticky applications: FR-C-(N)*
 - Pharmaceutical applications, chlorine, brine: C-C-(N)*
- * rotating seal, stationary seal, (flush/double seal)

N = Carbon

C = Silicon Carbide

FR = Chrome Oxide Coated Stainless Steel

K = Ceramic

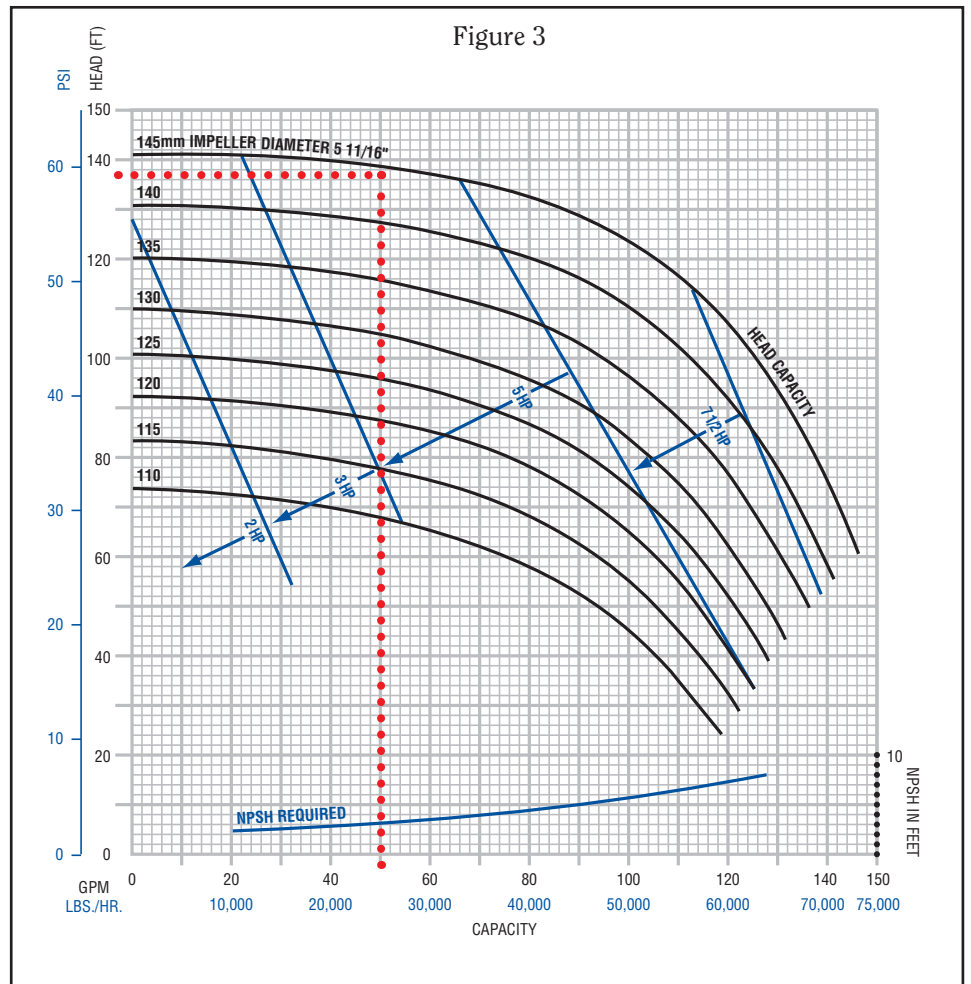

*Please note that the NPSH values shown are for full size impellers. Smaller impellers may require somewhat greater NPSH.

Pump Inquiry Application Data Sheet

The following information is required to properly process an inquiry:

Requested by _____ Date _____

Customer _____

Address _____

Telephone _____ Fax _____ Email _____

Description of product to be pumped _____

Temperature _____ Specific Gravity _____ or Density _____ lb./gal.

Viscosity _____ Centipoise (CPS) or other

Desired Flow Rate _____ GPM or lb./hr.

*Discharge Head _____ ft. or PSI

Suction Conditions

Is the pump withdrawing from a vacuum? _____ Yes _____ No

If so, how much? _____ in. Hg.

Is the product level on the inlet side of the pump above or below the center line of the pump inlet?

Above _____ Below _____ By how much? _____ in. or ft.

Tubing _____ in. Diameter _____ Length _____ No. of elbows _____ No. of tees

Tubing _____ in. Diameter _____ Length _____ No. of elbows _____ No. of tees

No. of size of valves in suction piping:

_____ No. _____ Size (in.)

_____ No. _____ Size (in.)

Other equipment in the suction piping _____

*If you do not know the desired discharge head, please provide the following:

Discharge Conditions

Is the final destination of the pump above or below the center line of the pump inlet?

Above _____ Below _____ By how much? _____ in. or ft.

Tubing _____ in. Diameter _____ Length _____ No. of elbows _____ No. of tees

Tubing _____ in. Diameter _____ Length _____ No. of elbows _____ No. of tees

Tubing _____ in. Diameter _____ Length _____ No. of elbows _____ No. of tees

No. and size of valves in discharge piping:

_____ No. _____ size (in.)

_____ No. _____ size (in.)

_____ No. _____ size (in.)

Other equipment and the drop or pressure requirement (PSI) in the discharge piping _____

How To Calculate Required Pressure

Example:

Find the head under these conditions: Pump is drawing from an open tank to discharge through a heat exchanger into an open tank that is 20 ft. above the pump. The supply is 8 ft. above the pump. 50 GPM flow is required.

Solution:

1. Height to be pumped is 20 ft. minus 8 ft. =12.0 ft.
2. Friction loss from pipe is
(8 ft. + 10 ft. + 20 ft. + 299.2 ft. = 337.2 ft.)
337.2 x .25 ft./ft. =84.3 ft.
3. Friction loss from 3 elbows is = 0.6 ft. = 0.6 ft.
4. *Heat Exchanger loss 2.31 times 16.5 PSI =38.1 ft.

The Total Head Loss is 135.0 ft.

*Heat Exchanger information supplied by manufacturer.

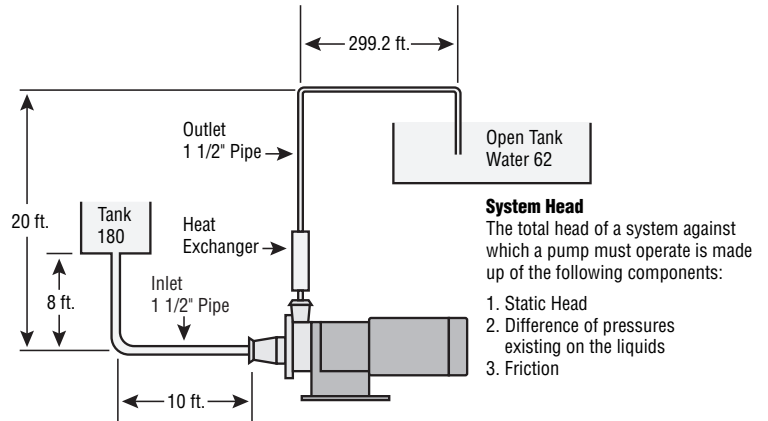

Determining Net Positive Suction Head (NPSH)

Fristam pumps are well known for requiring less net positive suction head (NPSH) available than other sanitary centrifugal pumps. However, due to the hydraulic principles involved, some level of NPSH is still required in order for the pump to run efficiently and without cavitating.

The NPSH required for each Fristam pump model has been determined by careful testing. The results of these tests are illustrated by the NPSH curve under the performance curves for each pump model.

To determine the NPSH available, first add the physical height of the liquid above the centerline of the pump inlet to the pressure above the liquid (in an open tank this is atmospheric pressure). From this total, subtract the friction losses of the line and fittings on the suction side and the vapor pressure of the liquid at the operating temperature. The remainder is the NPSH available. This number must meet or exceed the NPSH required in order for the pump to function properly. As an example, figure the NPSH available and required to pump 50 GPM and generate 135 feet water column of pressure.

The pump model required is a 722 with a 145 mm impeller (see “Selecting a Fristam Pump”). From the actual pump curve or from the example in “Selecting a Fristam Pump,” we see that the NPSH required is 3 feet.

Assuming 10 feet of 1 1/2 inch line and one elbow in the suction line, 8 feet of height of liquid above the pump center line and pumping 180°F water from an open tank, we can compute the NPSH available.

NPSH available = Physical height of liquid + atmospheric pressure - friction losses - vapor pressure (see “Vapor Pressure Chart”).

$$\text{NPSH available} = 8 \text{ ft.} + 33.9 \text{ ft.} - 4.7\text{ft.} - 17.3 \text{ ft.} = 19.9 \text{ ft.}$$

Since the NPSH available of 19.9 feet is greater than the NPSH required 3 feet, the pump has sufficient NPSH available to run properly.

Specific Gravity and Viscosity for Various Liquids

Product	SP. Gr.	Visc. (cps)	Temp °F	Condition
Acetone	0.80	1	70	
Acid:				
Acetic	1.01	1	100	5%
Citric	1.02	1	140	10%
Lactic	1.10	1	140	
Nitric	1.02	18	70	
Alcohol:				
Ethyl	0.82	1.4	70	
Methyl	0.79	0.6	70	
Alum	1.33	80	40	50% Conc.
Barbecue Sauce	1.10	150	70	33° Brix
Beer	1.02	1	40	
Beverage Concentrate	1.26	80	80	
Blood	1.00	5	20	
Brine	1.10 to 1.20	1	40	Sodium Chloride 1.20
Butter—Melted	0.95	90	90	
Buttermilk	1.04	20	40	
Carbon Tetrachloride	1.59	1	70	
Catsup	1.15	100	60	
Chocolate Bar Coating	1.08	65	120	
Cream	0.99	20	40	40% Fat
Dye, Water Base	1.10	10	70	
Egg—Whole	1.04	68	40	
Egg Yolk	1.12	400	68	
		200	86	
Ethylene Glycol	1.10	18	70	
Fat—Animal Melted	0.90	43	110	
Glaze—Donut	1.22	55	120	
Honey	1.30	230	100	81.2° Brix
		1500	70	
Ice Cream Mix	1.15	300	40	Varies
Ink, Printer's	1.20	520	130	
Juice—Single Strength:				
Apple, Clear	1.05	20	140	
Cranberry	1.03	10	140	
Grape	1.05	25	140	
Orange	1.05	20	140	
Tomato	1.03	180	140	
Juice—Concentrate:				
Apple	1.36	600	50	Thixotropic
Cranberry	1.03	250	100	Thixotropic
Grapefruit		1000	38	Thixotropic
Orange	1.32	5000	38	Thixotropic
Liqueurs	1.15	10	70	
Margarine	0.93	50	120	
Milk—Whole		1.03	1	40% TS
Milk—Concentrated	1.10	1000	50	40% TS
	1.30	100	131	75% TS
Milk—Concentrated	1.20	20	110	45% TS
Skim	1.10	95	70	30% TS
Milk—Evaporated	1.17	60	70	48% TS
Milk—Skim Condensed	1.20	20	110	45% TS

Detailed information is available on viscosity correction factors. Contact Fristam Pumps for details. The following viscosities may vary, depending upon products, formulas, and processes used by processors.

Product	SP. Gr.	Visc. (cps)	Temp °F	Condition
Milk—Sweetened	1.25	2000	50	
Condensed		500	150	
Milk of Magnesia	1.08	200	70	
Oils:				
Butter	0.90	40	70	
Corn	0.93	150	60	
Frying	0.90	10	400	
Lard	0.96	165	80	
Mineral	0.93	150	70	
Olive	0.92	110	60	
Peanut	0.92	100	60	
Soybean	0.93	95	60	
Vegetable	0.92	40	100	
Paint Solvents	0.90	10	70	
Paper Coatings	1.05	400	70	35% TS
Paraffin	0.90	9	140	
Pear Puree	1.30	4000	160	Thixotropic
Perfume	0.95	1	70	
Pie Filling	1.20	200	140	
Propylene Glycol	1.02	20	30	50%
Sauce—Apple		2000	71	
		800	190	
Salad Dressing	0.96	5000	75	
Shampoo	1.00	350	70	
Sorbitol	1.30	150	70	75%
Soup, Clear	1.00	20	160	
Spaghetti Sauce	1.10	200	140	
Syrups:				
Corn	1.39	240	180	40° Be
Dextrose	1.35	280	180	77° Brix
HFCS 42	1.35	160	70	42% TS
HFCS 55	1.35	800	70	55% TS
Invert	1.38	800	80	76° Brix
Maple	1.37	600	68	
Sugar	1.33	220	80	68° Brix
Soft Drink	1.26	80	80	
Toulene	0.87	1	70	
Tomato Paste	1.14	150	75	11% TS
	1.14	100	180	11% TS
	1.14	1500	200	17% TS
Varnish	0.90	125	100	
Vinegar	1.01	1	70	
Water	1.00	1	70	Includes WFI
Wax, Liquid	1.00	75	70	
Whey:				
Acid/Sweet	1.06	2	100	
Condensed	1.11	20	100	27% TS
	1.20	800	40	40% TS
	1.20	400	130	50% TS
	1.20	550	65	50% TS
	1.24	1500	65	60% TS
Sweetened	1.20	900	55	50% TS
	1.24	600	145	60% TS
Salt	1.06	2	80	
Wort	1.05	100	150	
Yeast—Brewer's				
Fermenting	1.10	150	40	20% TS
Yeast Slurry	1.10	270	45	35% TS
Yogurt Mix	1.03	20	40	

Conversion Factors

Length

Meters	x	3.281	= Feet
Centimeters	x	0.394	= Inches
Millimeters	x	0.0394	= Inches

Mass

Kilograms	x	2.2	= Lbs.
Gallons Of Water	x	8.34	= Lbs.
Cubic Feet of Water	x	62.4	= Lbs.
Pounds	x	0.454	= Kilograms

Volume

Liter	x	0.264	= Gallon
Cubic Feet	x	7.48	= Gallon
Lbs. Of Water	x	0.119	= Gallon
Imperial Gallon (British)	x	1.2	= Gallon (U.S.)
U.S. Gallon	x	3.785	= Liter

Pressure

Feet of Water	x	0.433	= PSI
Inches of Hg.	x	0.491	= PSI
Atmosphere	x	14.7	= PSI
Meters of Water	x	1.42	= PSI
Kilograms/sq. Centimeter	x	14.22	= PSI
Bar	x	14.7	= PSI

Pressure (continued)

Atmosphere	x	33.9	= Feet of Water
PSI	x	2.31	= Feet of Water
Inches of Hg.	x	1.13	= Feet of Water

Flow

Lbs. Of Water/Hour	x	0.002	= GPM
Lbs. Of Fluid/Hour	x	0.002	= GPM
Specific Gravity			
Cu. Meter/Hour	x	4.4	= GPM
Kg. Of Water/Minute	x	0.264	= GPM
Liters/Minute	x	0.264	= GPM
GPM	x	3.785	= Liters/Minute

Power

$$\text{Liquid HP} = \frac{\text{GPM} \times \text{Head ft.} \times \text{Specific Gravity}}{3960}$$

$$\text{BHP} = \frac{\text{GPM} \times \text{Head ft.} \times \text{Specific Gravity}}{3960 \times \text{Pump Efficiency}}$$

Viscosity

$$\frac{\text{Centipoise}}{\text{Specific Gravity}} = \text{Centistokes}$$

$$\text{Centistokes} \times 4.64 = \text{SSU (Approx.)}$$

Temperature

$$(1.8 \times ^\circ\text{C}) + 32 = ^\circ\text{F}$$

$$.555 (^{\circ}\text{F} - 32^{\circ}) = ^\circ\text{C}$$

$$\text{Degrees Kelvin} - 273.2 = \text{Degrees Centigrade}$$

Vapor Pressure Chart

VAPOR PRESSURE OF WATER

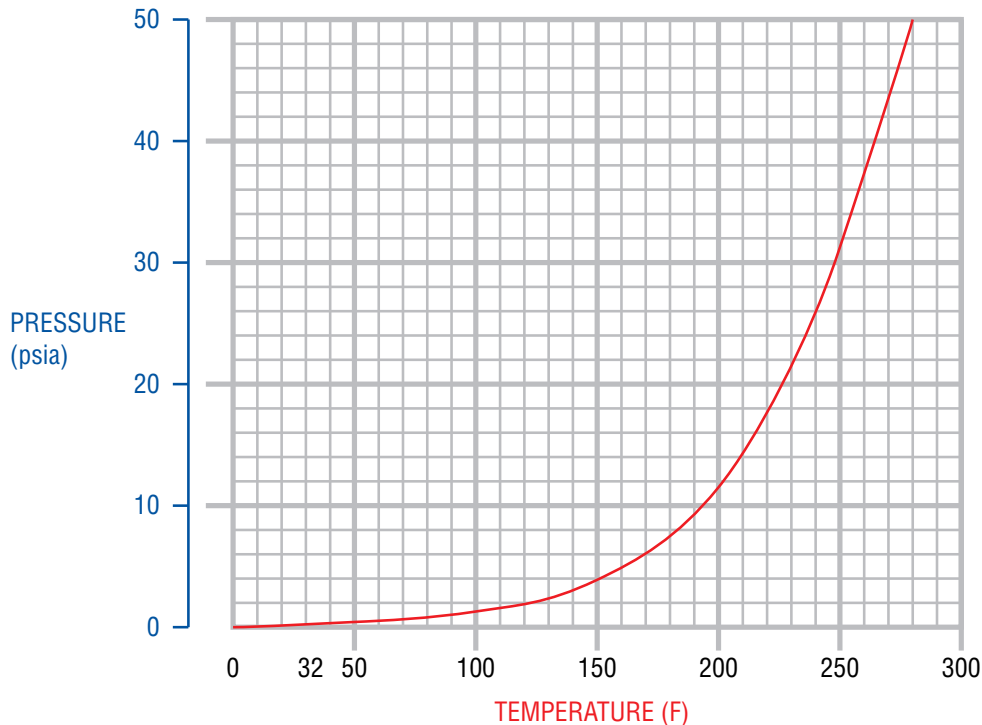

Loss of Head Due to Friction in Feet per Foot of Stainless Steel Tubing and in Feet for Sanitary Fittings

Notes:

1. Flow Elbows—R/D = 1.5
2. Flow Through Tees—Flow A to B Port C capped off.
3. Test Medium—Water at 70°F
4. 16 gauge tubing was used for the measurements when the outer diameter (O.D.) was between 1" - 3" and 14 gauge tubing was used with the 4" O.D. measurement.

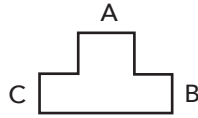

*Calculated data for estimating purposes only. Consult your tubing manufacturer with specific questions.

Capacity in U.S. G.P.M.	O.D. - 1" I.D. - .870"			O.D. - 1.5" I.D. - 1.370"			O.D. - 2" I.D. - 1.870"			O.D. - 2.5" I.D. - 2.370"			O.D. - 3" I.D. - 2.870"			O.D. - 4" I.D. - 3.834"		
	Tubing	Elbow	Tee	Tubing	Elbow	Tee	Tubing	Elbow	Tee	Tubing	Elbow	Tee	Tubing	Elbow	Tee	Tubing	Elbow	Tee
2	.01	.01	.1															
4	.025	.02	.2															
5	.035	.025	.25															
10	.12	.06	.4	.02	.01	.15	.005	.015	.1									
15	.25	.1	.8	.04	.02	.25	.013	.02	.15									
20	.43	.22	1.5	.06	.03	.3	.02	.025	.2	.005	.02	.1	.003	.02	.06			
25	.66	.4	2.3	.08	.04	.4	.025	.03	.25	.006	.03	.15	.004	.03	.08			
30	.93	.7	3.3	.105	.06	.55	.035	.05	.3	.008	.05	.2	.005	.04	.1			
35	1.22	1.25	5.2	.135	.09	.8	.04	.06	.4	.011	.06	.25	.006	.05	.13			
40				.17	.11	1.0	.05	.08	.5	.015	.07	.3	.007	.06	.15			
45				.21	.16	1.3	.063	.1	.6	.02	.09	.35	.008	.065	.18			
50				.25	.2	1.6	.073	.12	.7	.022	.1	.4	.01	.07	.2			
60				.34	.35	2.2	.1	.18	.9	.03	.12	.45	.015	.08	.25			
80				.57	.76	3.7	.16	.3	1.5	.05	.15	.55	.02	.1	.4			
100				.85	1.35	5.8	.23	.44	2.3	.075	.18	.6	.03	.11	.5	.008	.04	.1
120				1.18	2.05	9.1	.32	.64	3.3	.105	.21	1.0	.04	.13	.6	.01	.05	.15
140							.42	.85	4.5	.14	.23	1.25	.05	.16	.8	.013	.06	.2
160							.54	1.13	5.8	.17	.28	1.6	.07	.2	1.1	.015	.07	.25
180							.67	1.45	7.4	.205	.31	2.0	.08	.21	1.3	.02	.08	.3
200							.81	1.82	9.0	.245	.35	2.5	.1	.26	1.6	.025	.09	.4
220							.95	2.22	11.0	.29	.41	3.0	.12	.3	1.9	.028	.1	.5
240							1.10	2.63	13.5	.34	.48	3.7	.14	.33	2.2	.035	.11	.55
260										.39	.53	4.5	.165	.39	2.5	.04	.115	.6
280										.45	.61	5.3	.19	.42	2.8	.045	.12	.65
300										.515	.7	6.2	.22	.5	3.1	.05	.13	.7
350										.68	1.05	8.5	.28	.67	4.1	.07	.15	.9
400										.86	1.55	11.0	.36	.88	5.2	.085	.18	1.2
450										1.05	2.25	13.5	.44	1.1	6.6	.105	.2	1.5
500													.54	1.4	8.0	.13	.23	1.75
550													.64	1.7	9.5	.15	.27	2.1
600													.75	2.05	10.2	.175	.3	2.5
650													.87	2.41	13.0	.2	.34	2.8
700													1.0	2.8	15.0	.23	.4	3.4
750																.26	.43	3.8
800																.3	.5	4.4
850																.33	.56	5.0
900																.37	.62	5.7
950																.41	.7	6.3
1000																.45	.8	7.0
1100																.53	1.06	8.6

Fristam Centrifugal Options and Ordering Matrix

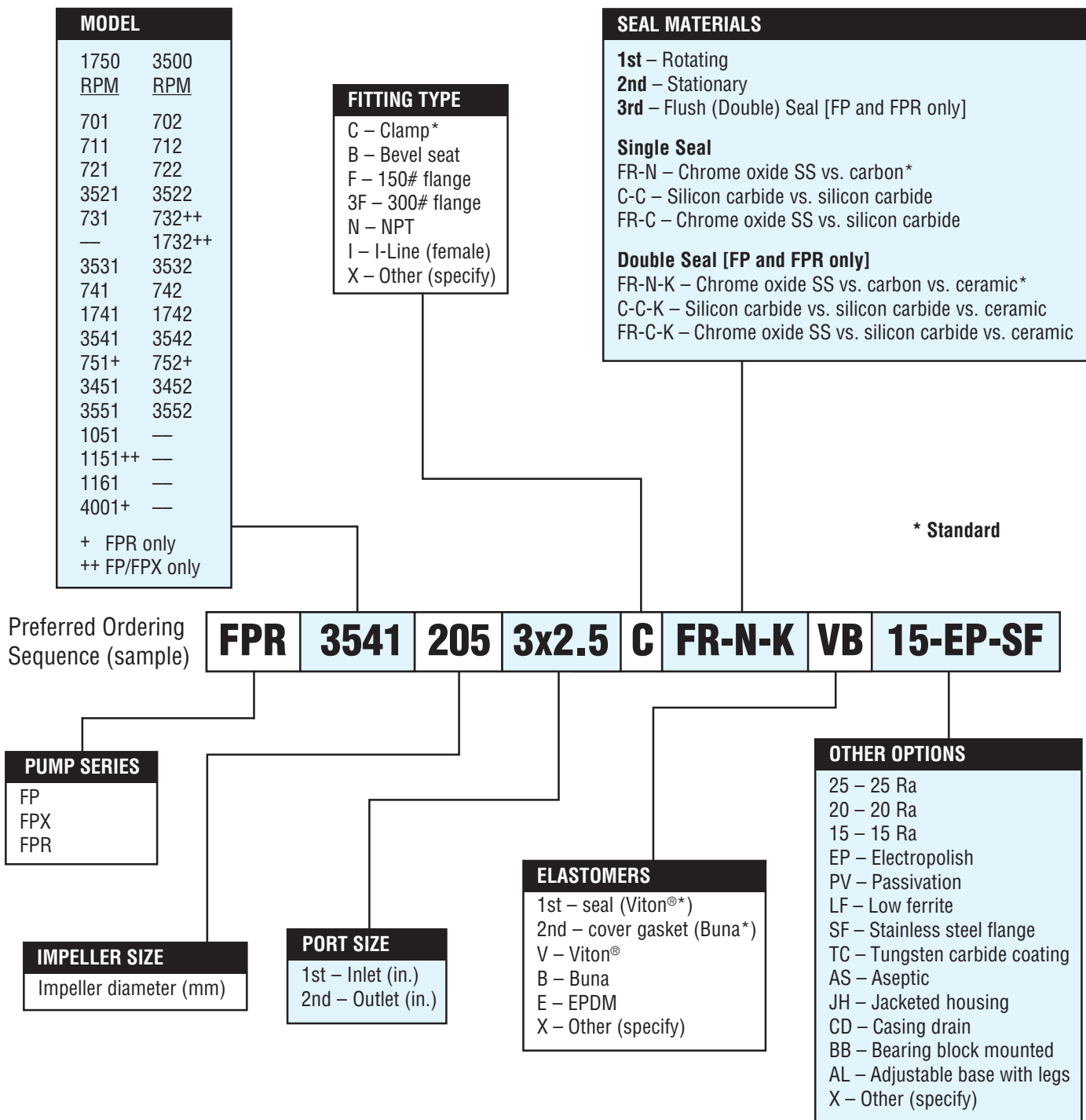

Fristam Centrifugal Specialty Pumps

- Water for Injection
- Aseptic
- Jacketed Housing

Pharmaceutical Options

All standard stainless steel components are 316L. Special castings are available in low-ferrite stainless steel or high-performance alloys such as Hastelloy® and AL-6XN®. Class VI elastomers are standard for pharmaceutical applications. Seal materials include ceramic and silicon carbide.

Electropolishing and enhanced internal surface finishes to 15 Ra are available on most products.

Casing drain and mounting options provide complete drainability critical for long-term system cleanliness. Pumps can be easily configured for steam-in-place sterilization, with no external cooling devices required.

Water For Injection (WFI) Pumps

Fristam is the industry leader for WFI and other high-purity service. Fristam WFI centrifugal pumps are a precision adaptation of our FP, FPX, and FPR pumps. They feature an advanced seal design that protects product sterility, saves valuable product and provides for long seal life.

Fristam pioneered a pressurized double seal flush system that ensures product sterility and saves valuable product by maintaining positive pressure in the critical seal area. The internal seal design provides extra cooling and lubrication on the front seal face to significantly extend seal life and provide for more system uptime.

Numerous seal and piping configurations, including single seal piping, are available to meet your processing requirements.



Comprehensive Documentation Options

- Certified Drawings
- Mill Certification
- Physical Certifications
- Material Verification
- Certificate of Conformance
- Warranty Statement
- Certified Finish
- Passivation of Pump
- Stainless Steel Tag
- Certified Welding
- Hydrostatic Test
- Dynamic Seal Test
- Short Run Test
- Performance Test
- NPSH Test
- Witness Test
- Vibration Test
- Ferrite Test
- Saline Test
- Seismic Calculation

FP/FPX Performance Curves
Models: 1750 RPM (Composite A)

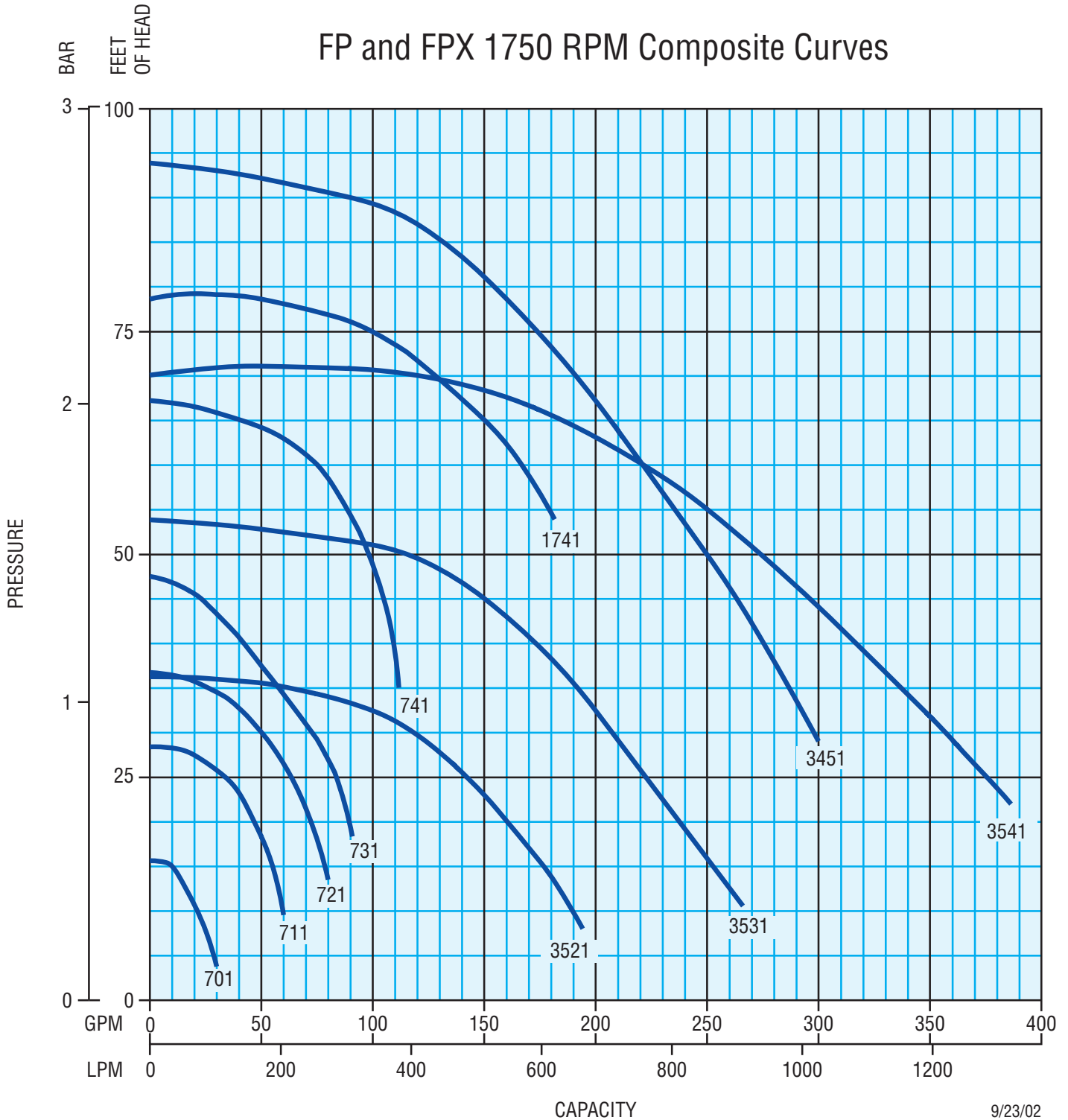

9/23/02
 1265000074
 RD 2/08

Performance curve based on tests using 70°F water and 0 psig inlet pressure. A tolerance of ± 5% applies to all figures. Actual performance may vary by application product. Please contact Fristam for different conditions.

FP/FPX Performance Curves

Models: 1750 RPM (Composite B)

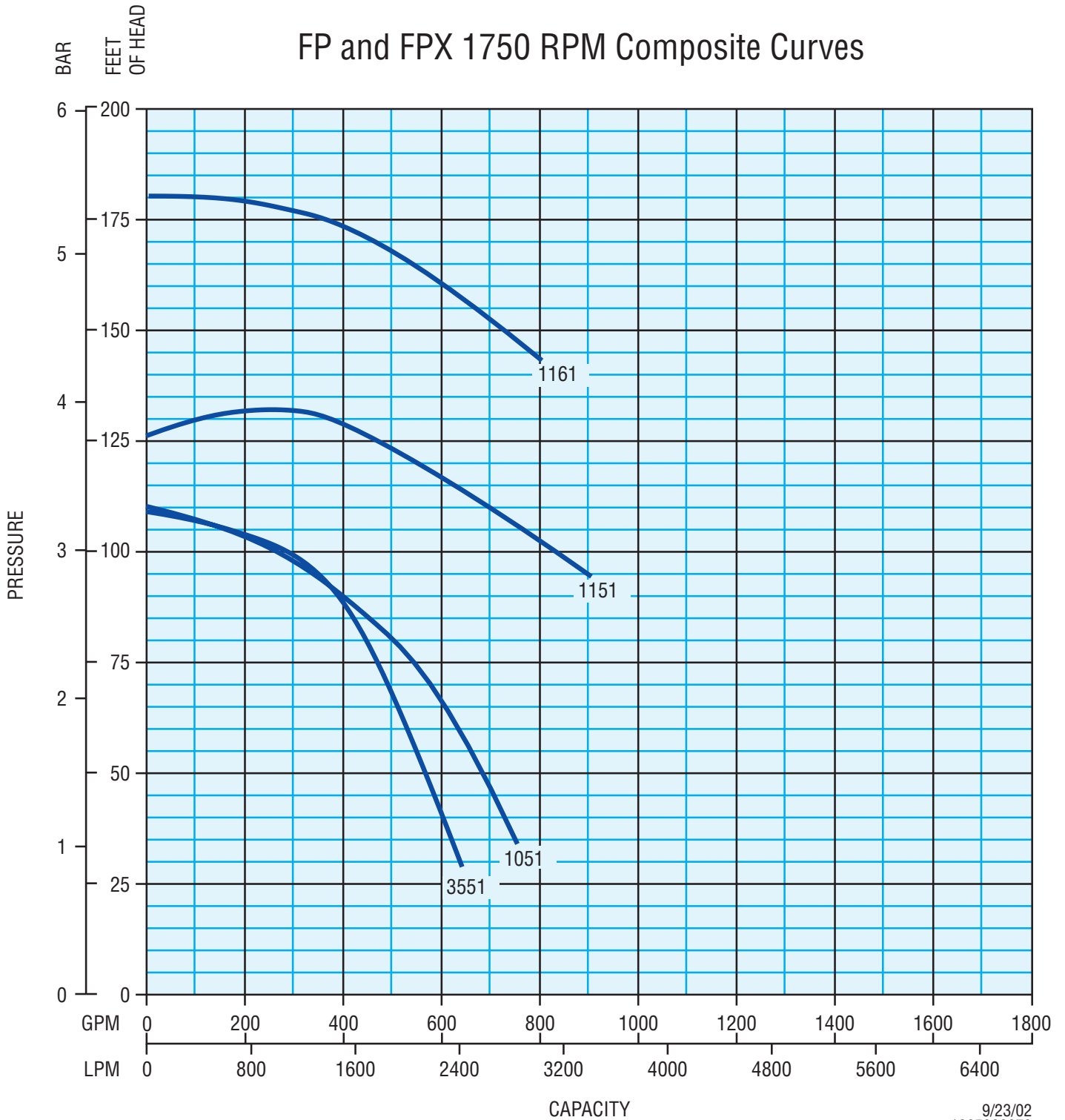

9/23/02
1265000073
RD 2/08

Performance curve based on tests using 70°F water and 0 psig inlet pressure. A tolerance of ± 5% applies to all figures. Actual performance may vary by application product. Please contact Fristam for different conditions.

FPR Performance Curves

Models: 1750 RPM (Composite A)

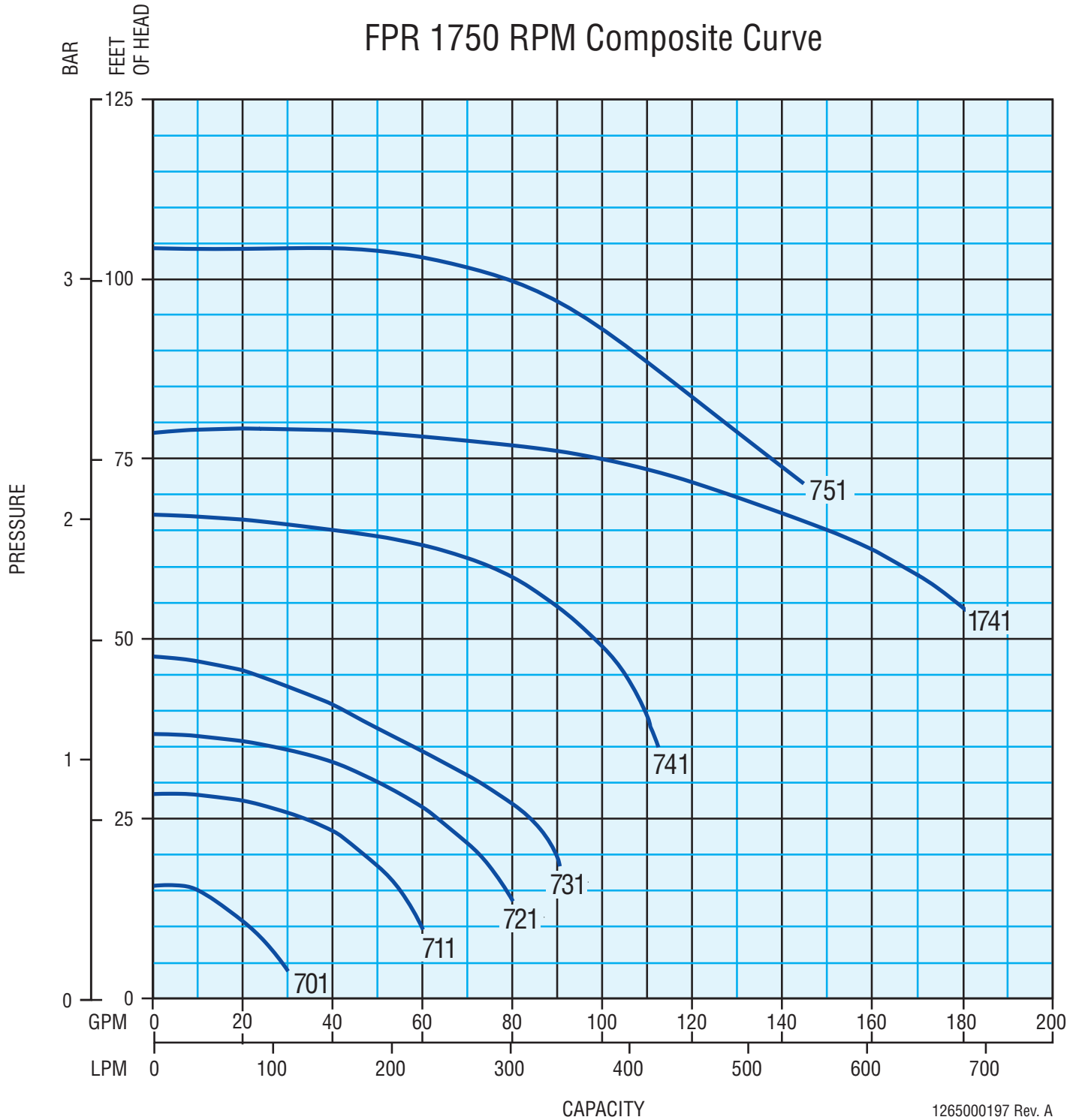

Performance curve based on tests using 70°F water and 0 psig inlet pressure. A tolerance of ± 5% applies to all figures. Actual performance may vary by application product. Please contact Fristam for different conditions.

FPR Performance Curves

Models: 1750 RPM (Composite B)

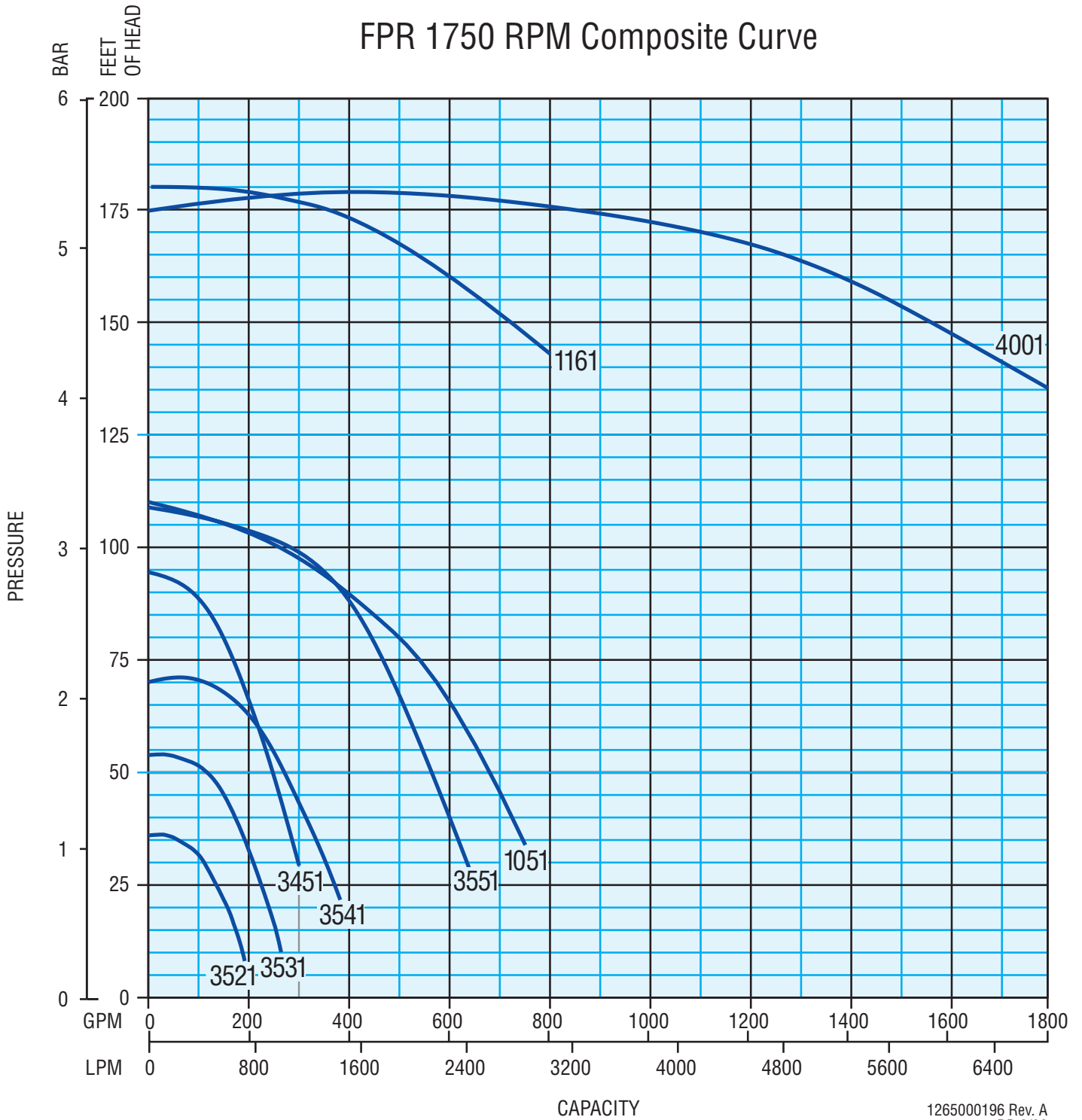

Performance curve based on tests using 70°F water and 0 psig inlet pressure. A tolerance of ± 5% applies to all figures. Actual performance may vary by application product. Please contact Fristam for different conditions.

FP/FPX/FPR Performance Curves
Model: 701 (1750 RPM, Inlet 1.5", Outlet 1.5")

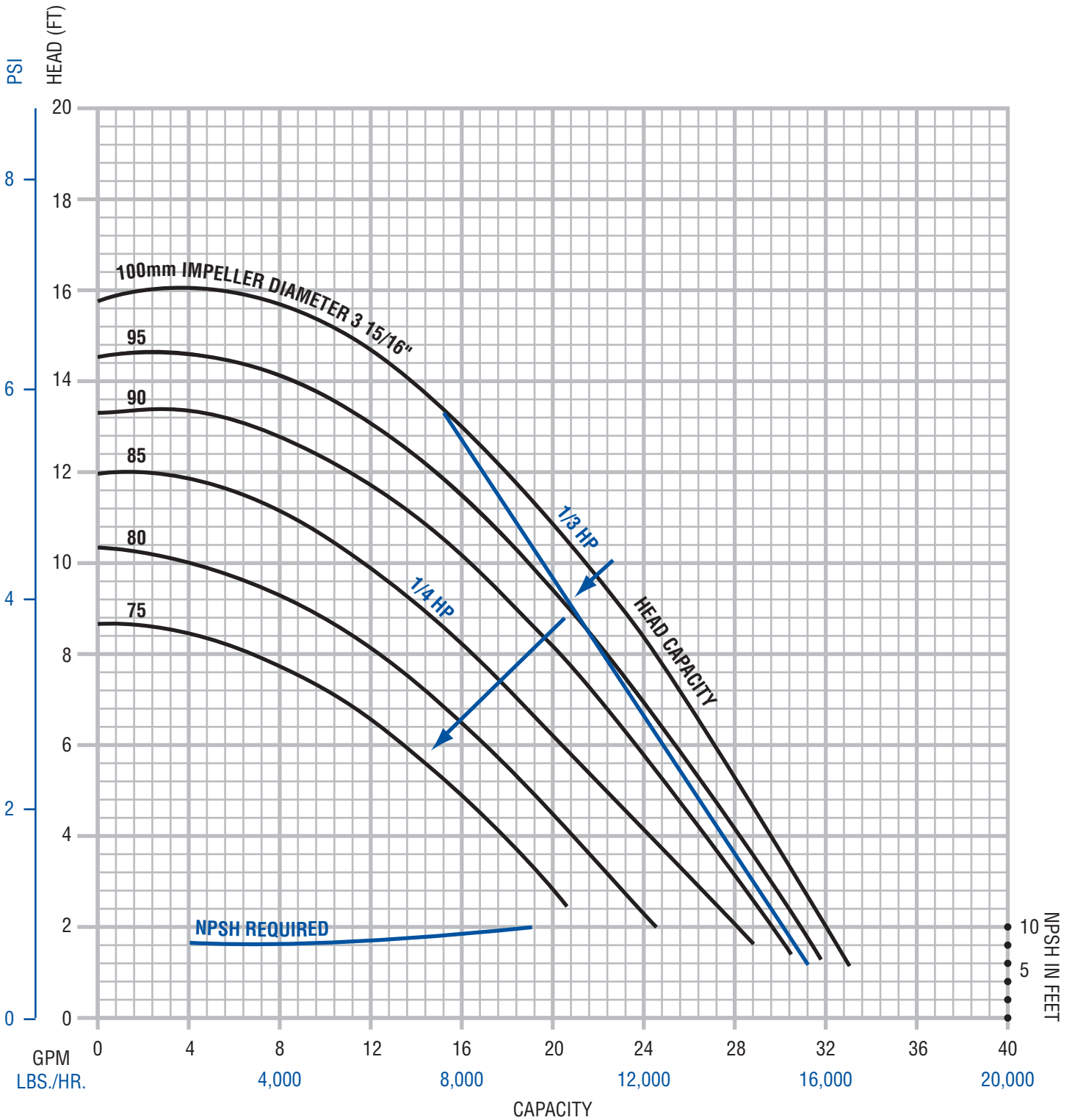

Performance curve based on tests using 70°F water and 0 psig inlet pressure. A tolerance of ± 5% applies to all figures. Actual performance may vary by application product. Please contact Fristam for different conditions.

FP/FPX/FPR Performance Curves

Model: 711 (1750 RPM, Inlet 2", Outlet 1.5")

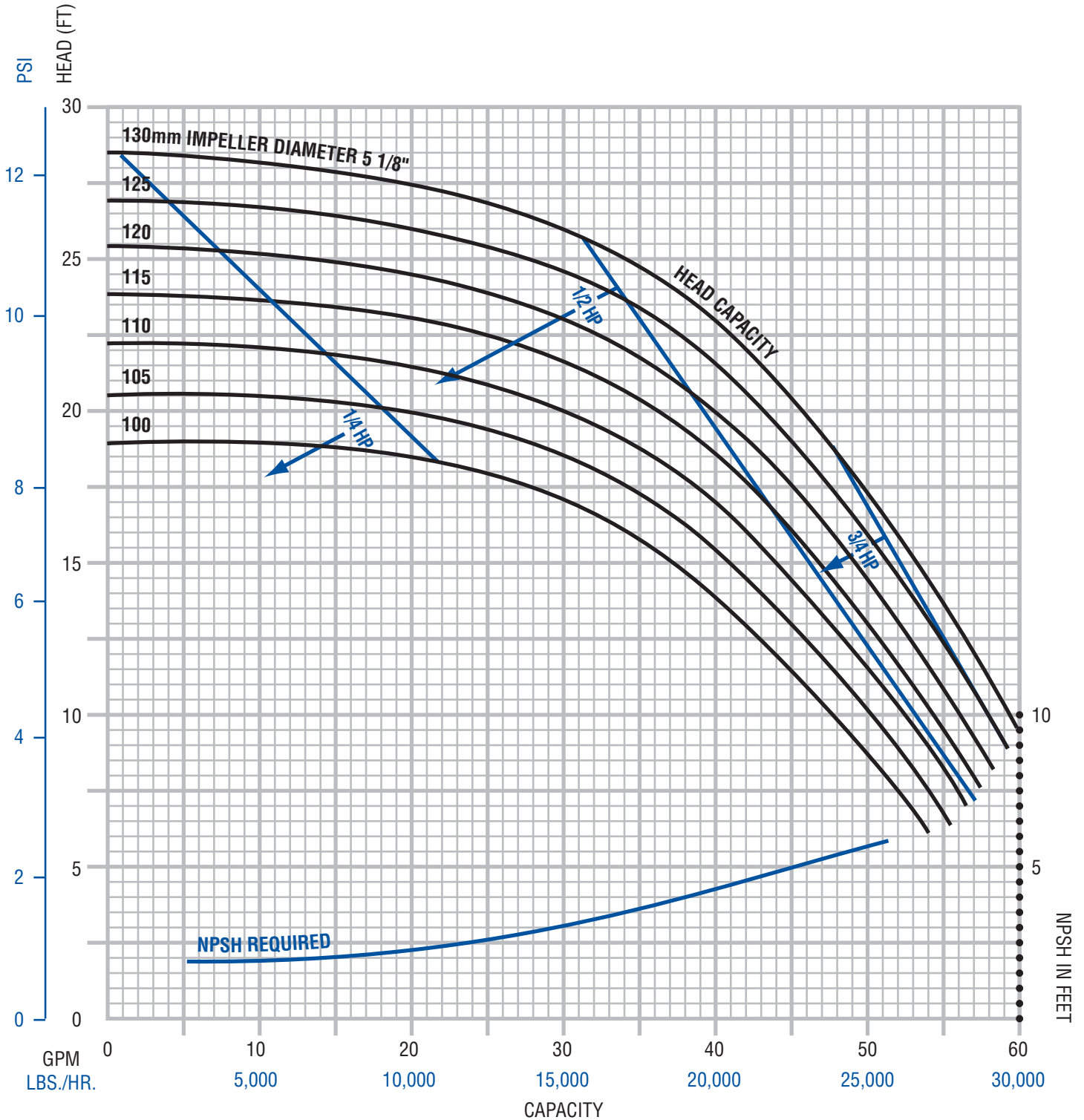

Performance curve based on tests using 70°F water and 0 psig inlet pressure. A tolerance of ± 5% applies to all figures. Actual performance may vary by application product. Please contact Fristam for different conditions.

FP/FPX/FPR Performance Curves
Model: 721 (1750 RPM, Inlet 2", Outlet 1.5")

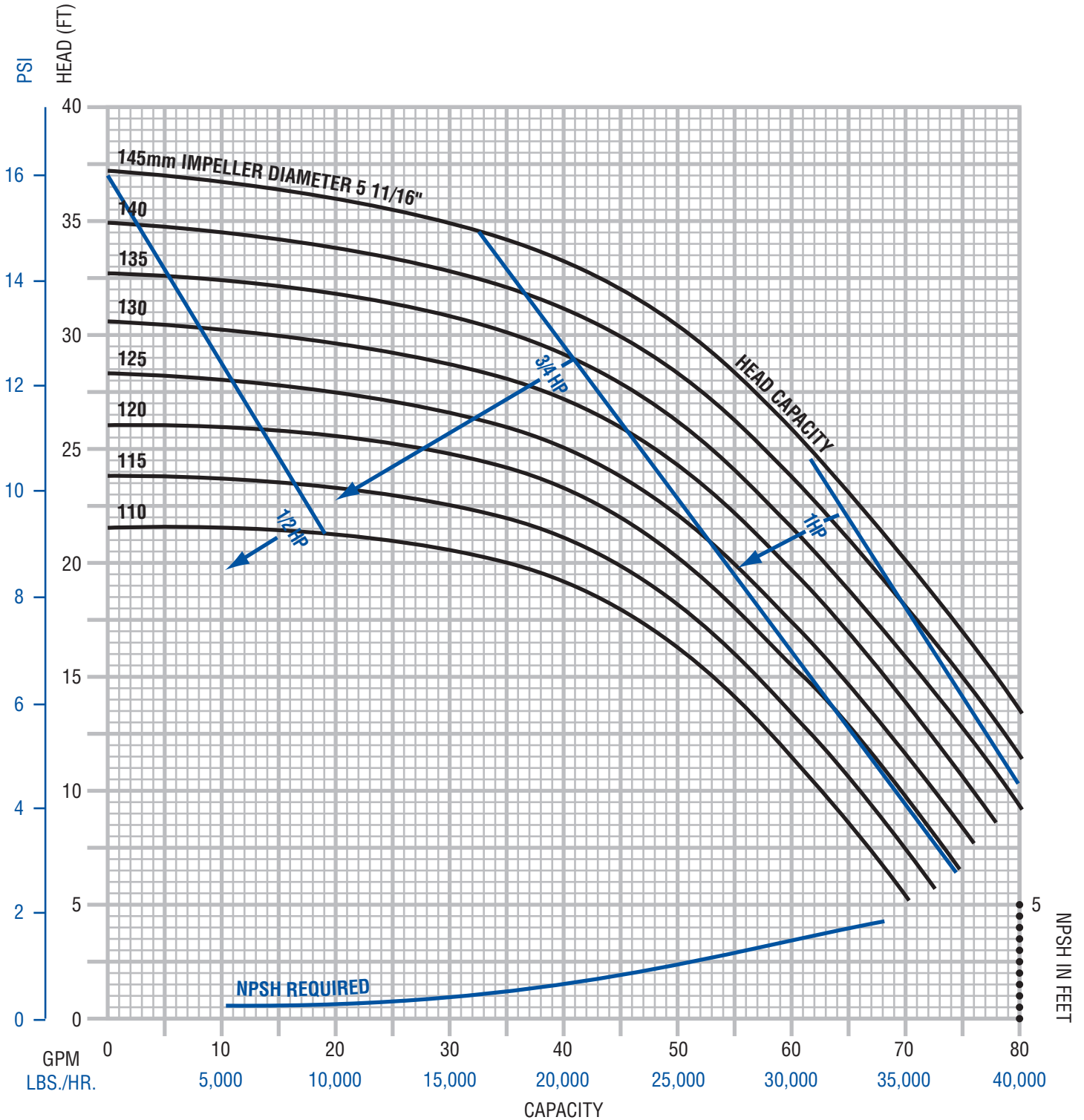

Performance curve based on tests using 70°F water and 0 psig inlet pressure. A tolerance of ± 5% applies to all figures. Actual performance may vary by application product. Please contact Fristam for different conditions.

FP/FPX/FPR Performance Curves
Model: 3521 (1750 RPM, Inlet 2.5", Outlet 2")

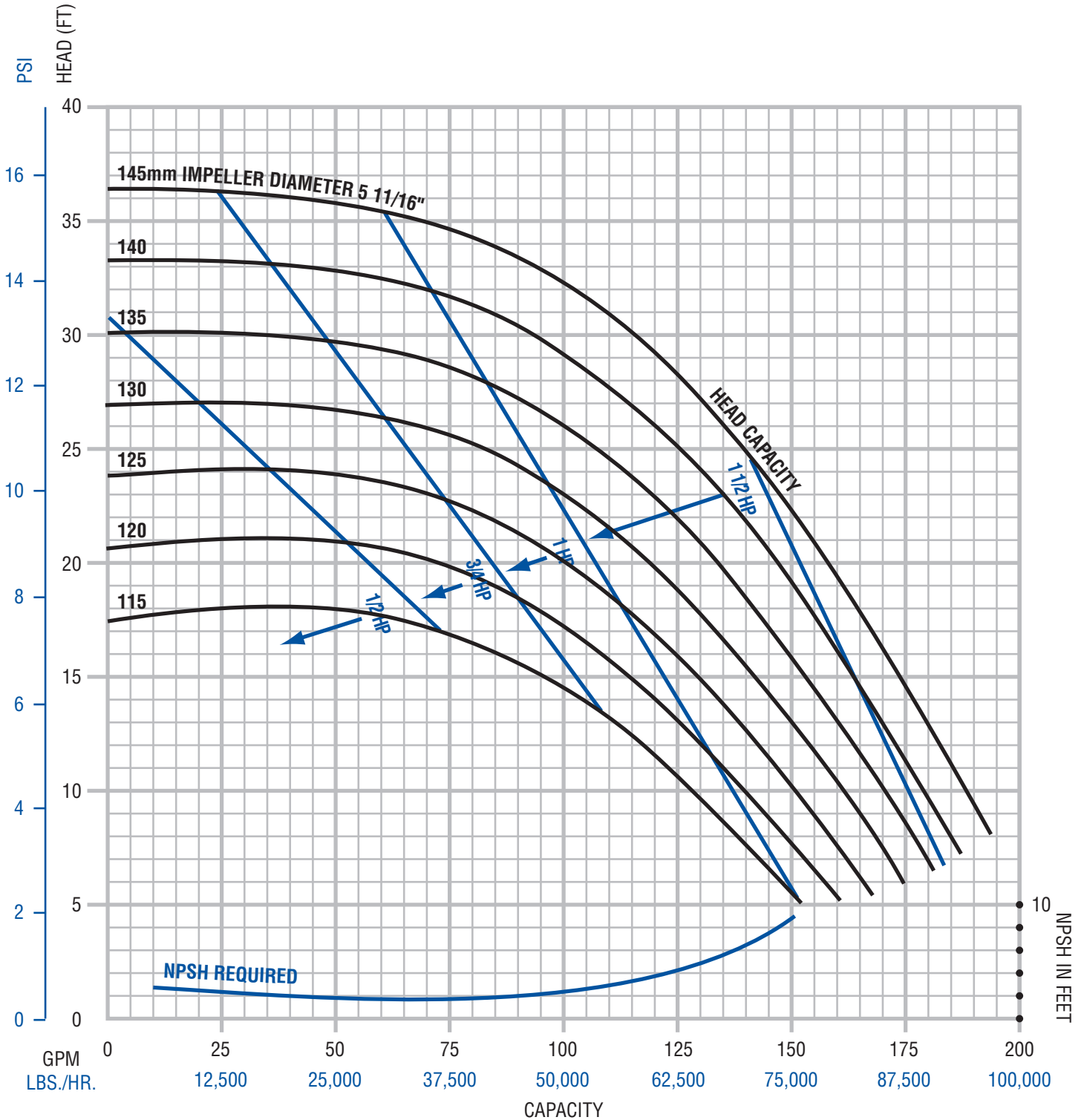

Performance curve based on tests using 70°F water and 0 psig inlet pressure. A tolerance of ± 5% applies to all figures. Actual performance may vary by application product. Please contact Fristam for different conditions.

FP/FPX/FPR Performance Curves

Model: 731 (1750 RPM, Inlet 2", Outlet 1.5")

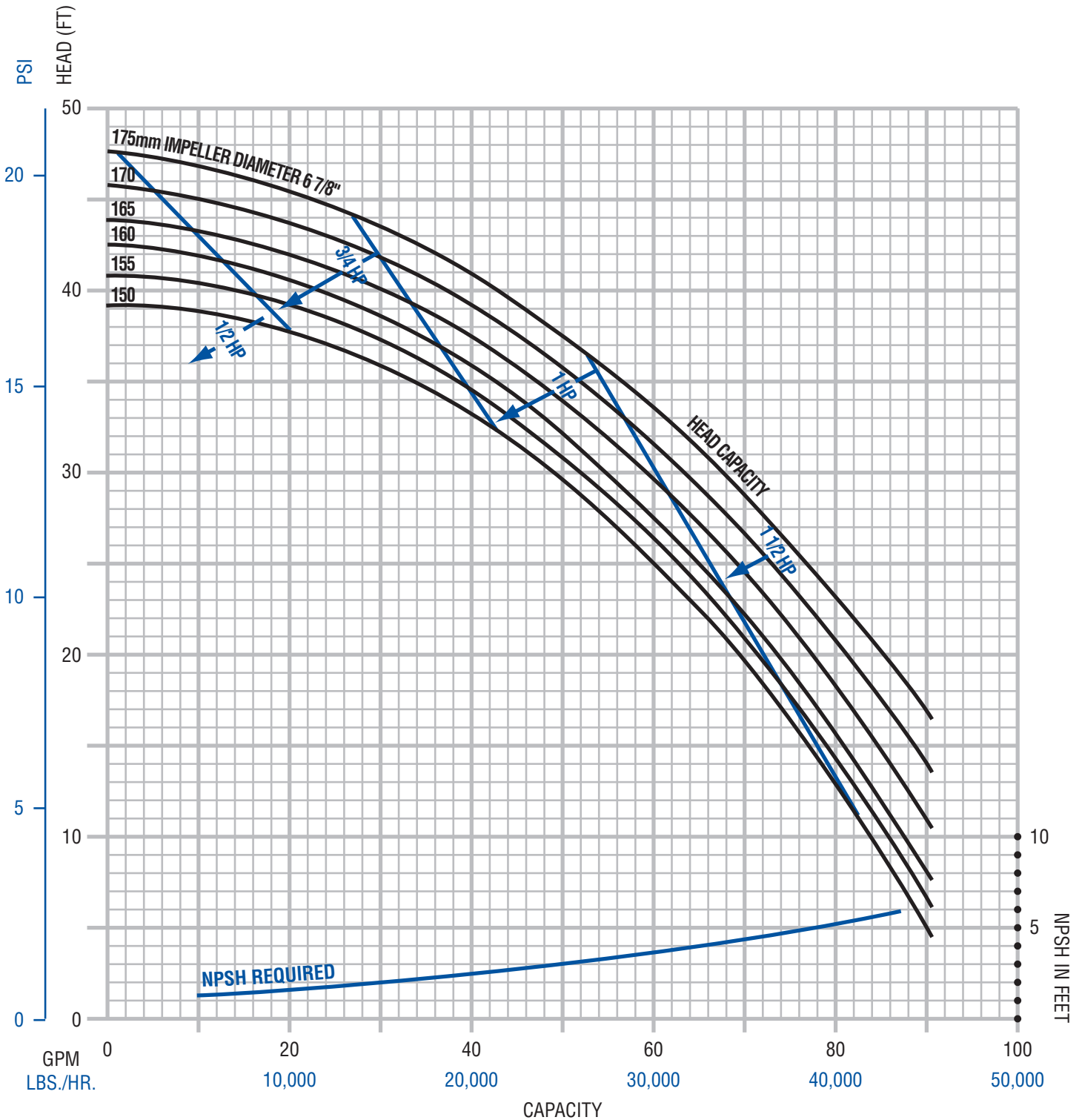

Performance curve based on tests using 70°F water and 0 psig inlet pressure. A tolerance of ± 5% applies to all figures. Actual performance may vary by application product. Please contact Fristam for different conditions.

FP/FPX/FPR Performance Curves
Model: 3531 (1750 RPM, Inlet 2.5", Outlet 2")

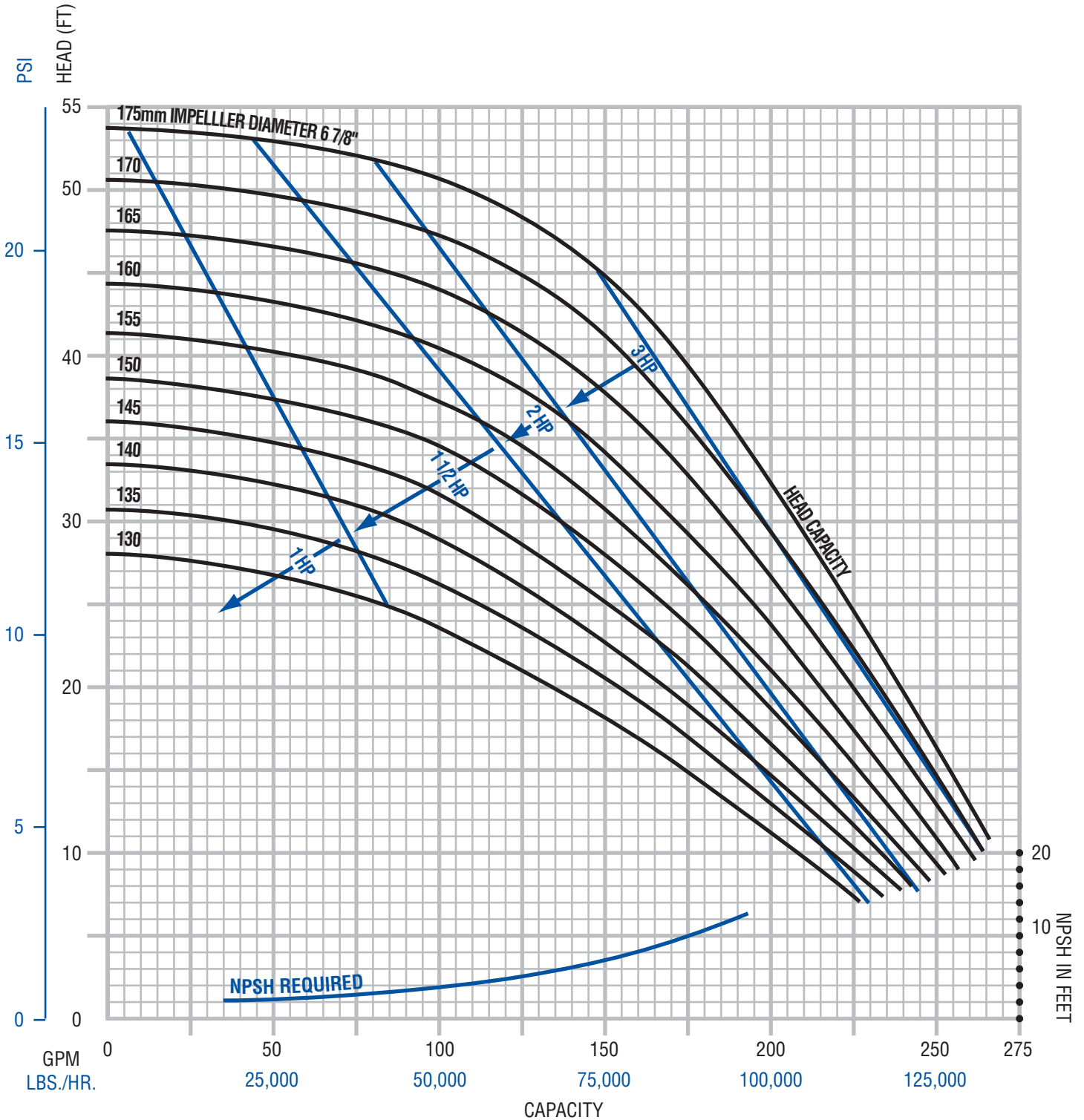

Performance curve based on tests using 70°F water and 0 psig inlet pressure. A tolerance of ± 5% applies to all figures. Actual performance may vary by application product. Please contact Fristam for different conditions.

FP/FPX/FPR Performance Curves
Model: 741 (1750 RPM, Inlet 2.5", Outlet 2")

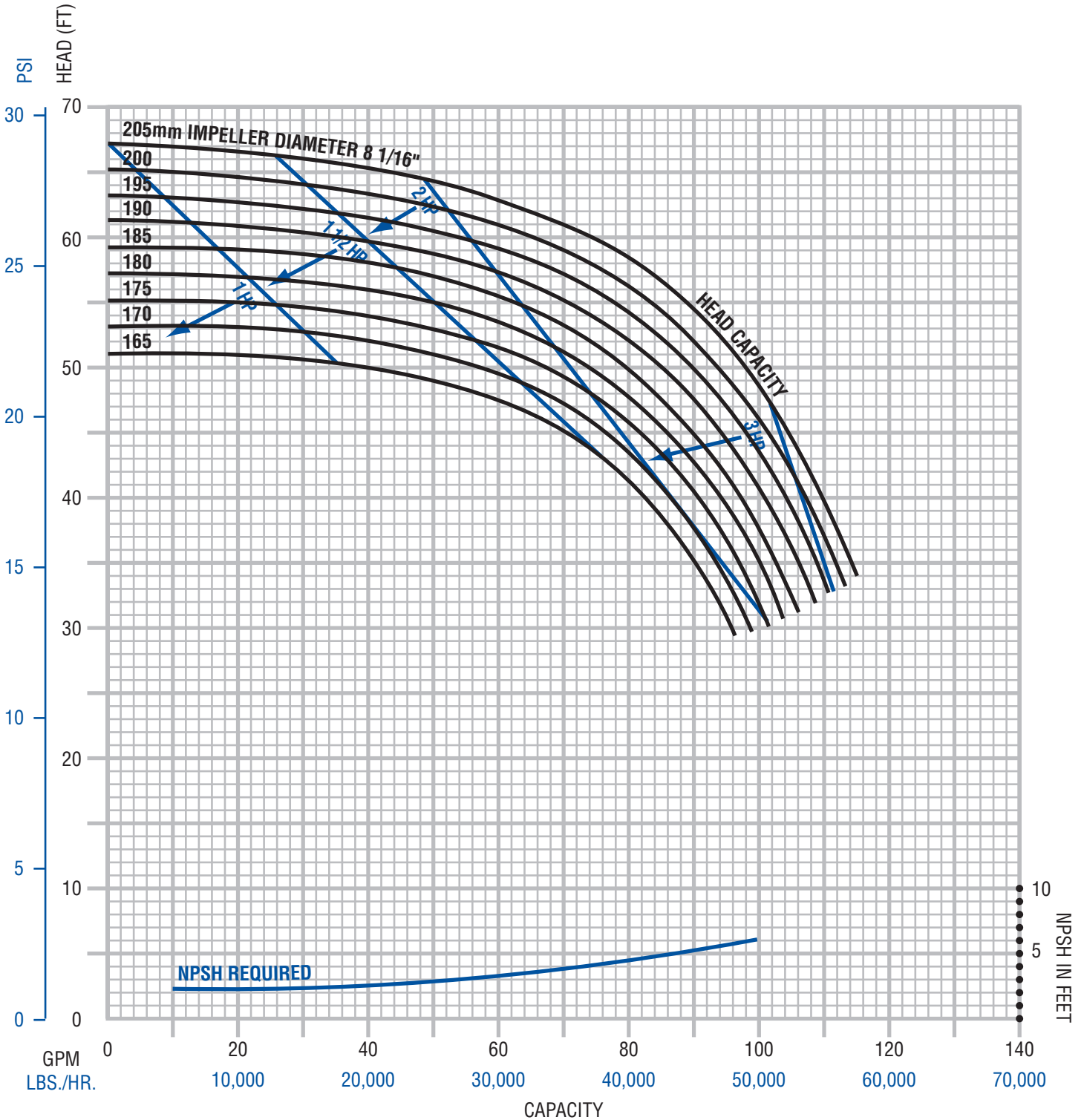

Performance curve based on tests using 70°F water and 0 psig inlet pressure. A tolerance of ± 5% applies to all figures. Actual performance may vary by application product. Please contact Fristam for different conditions.

FP/FPX/FPR Performance Curves
Model: 1741 (1750 RPM, Inlet 2.5", Outlet 2")

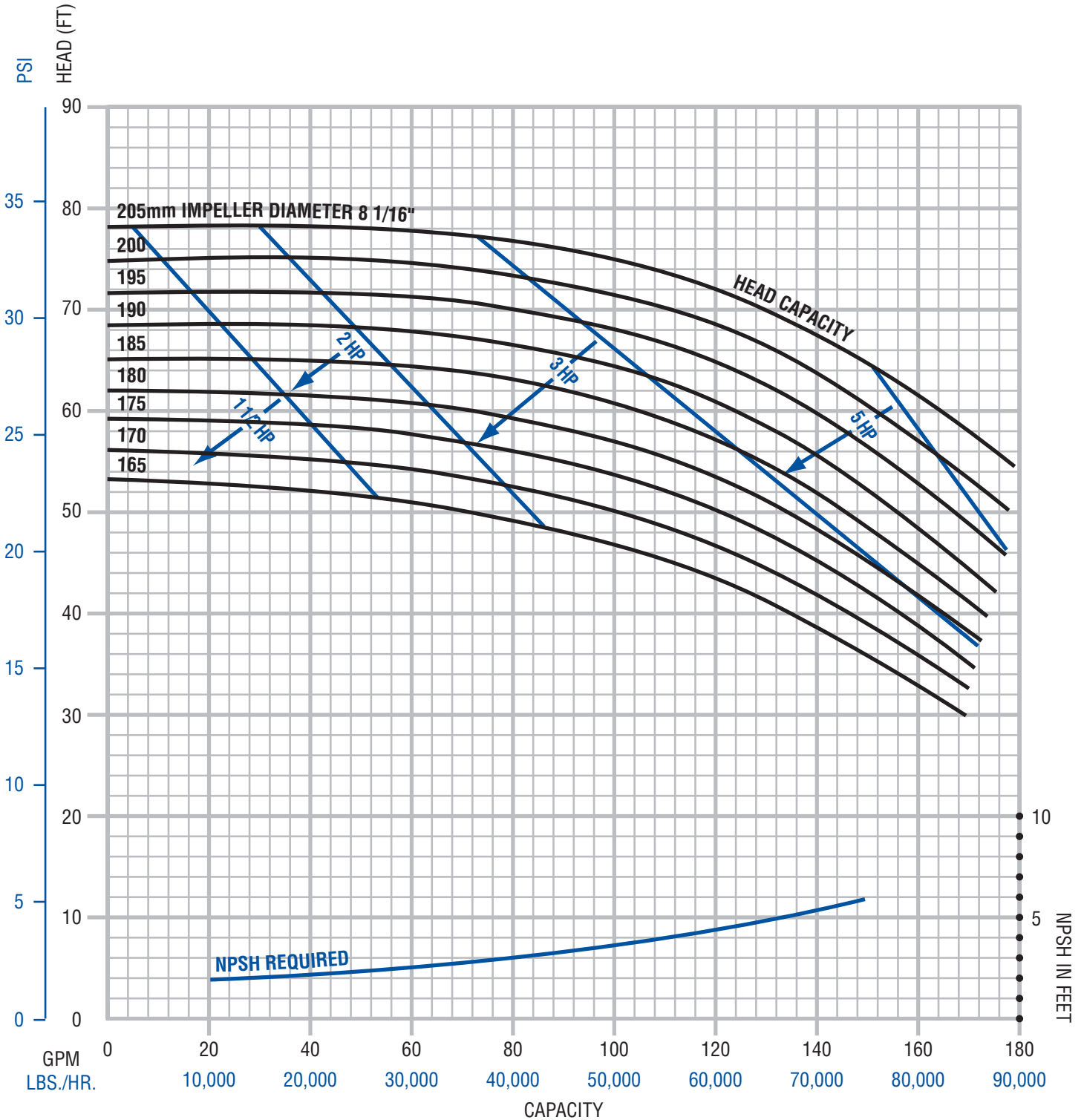

Performance curve based on tests using 70°F water and 0 psig inlet pressure. A tolerance of ± 5% applies to all figures. Actual performance may vary by application product. Please contact Fristam for different conditions.

FP/FPX/FPR Performance Curves
Model: 3541 (1750 RPM, Inlet 3", Outlet 2.5")

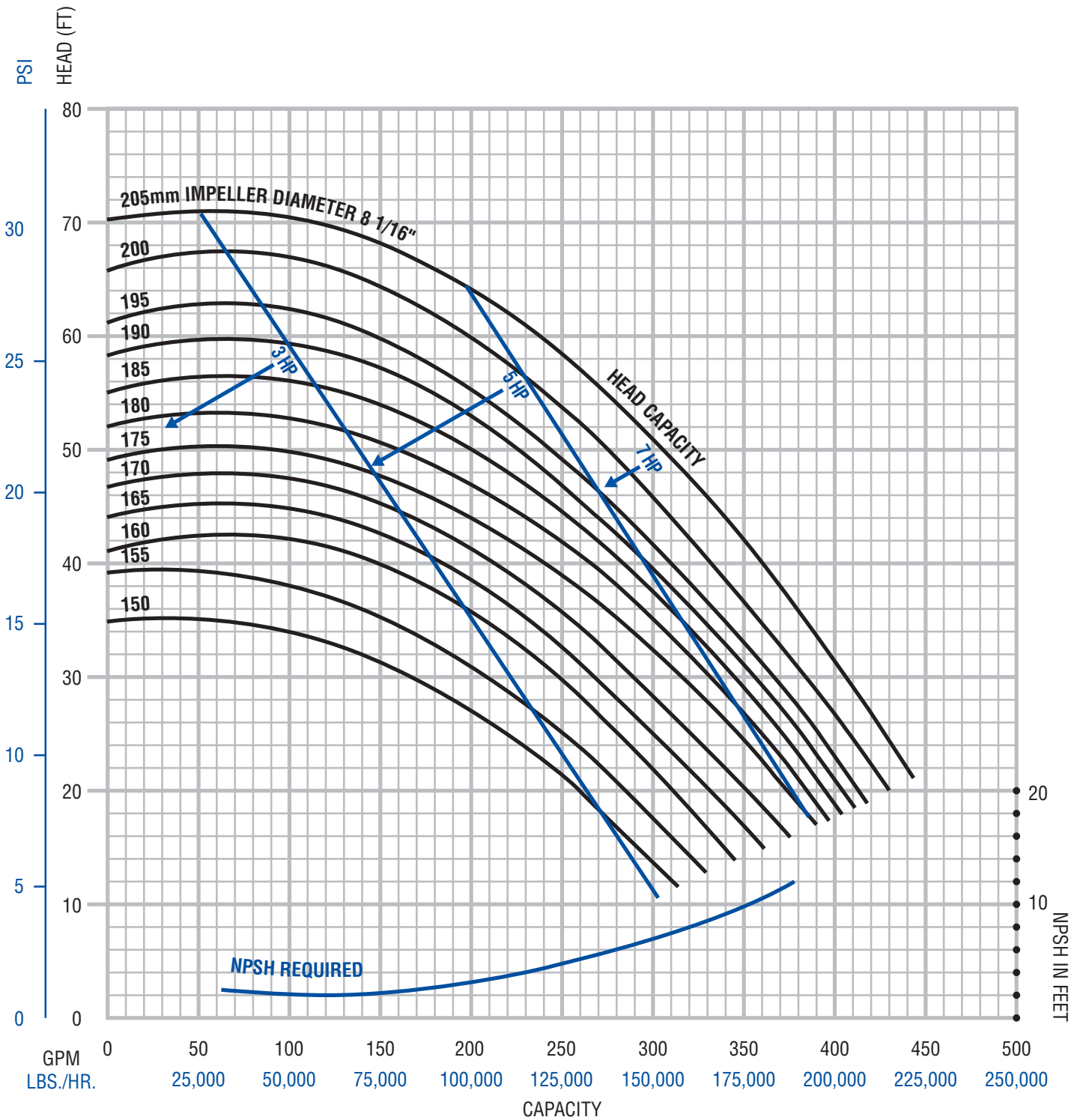

Performance curve based on tests using 70°F water and 0 psig inlet pressure. A tolerance of ± 5% applies to all figures. Actual performance may vary by application product. Please contact Fristam for different conditions.

FPR Performance Curves

Model: 751 (1750 RPM, Inlet 3", Outlet 2")

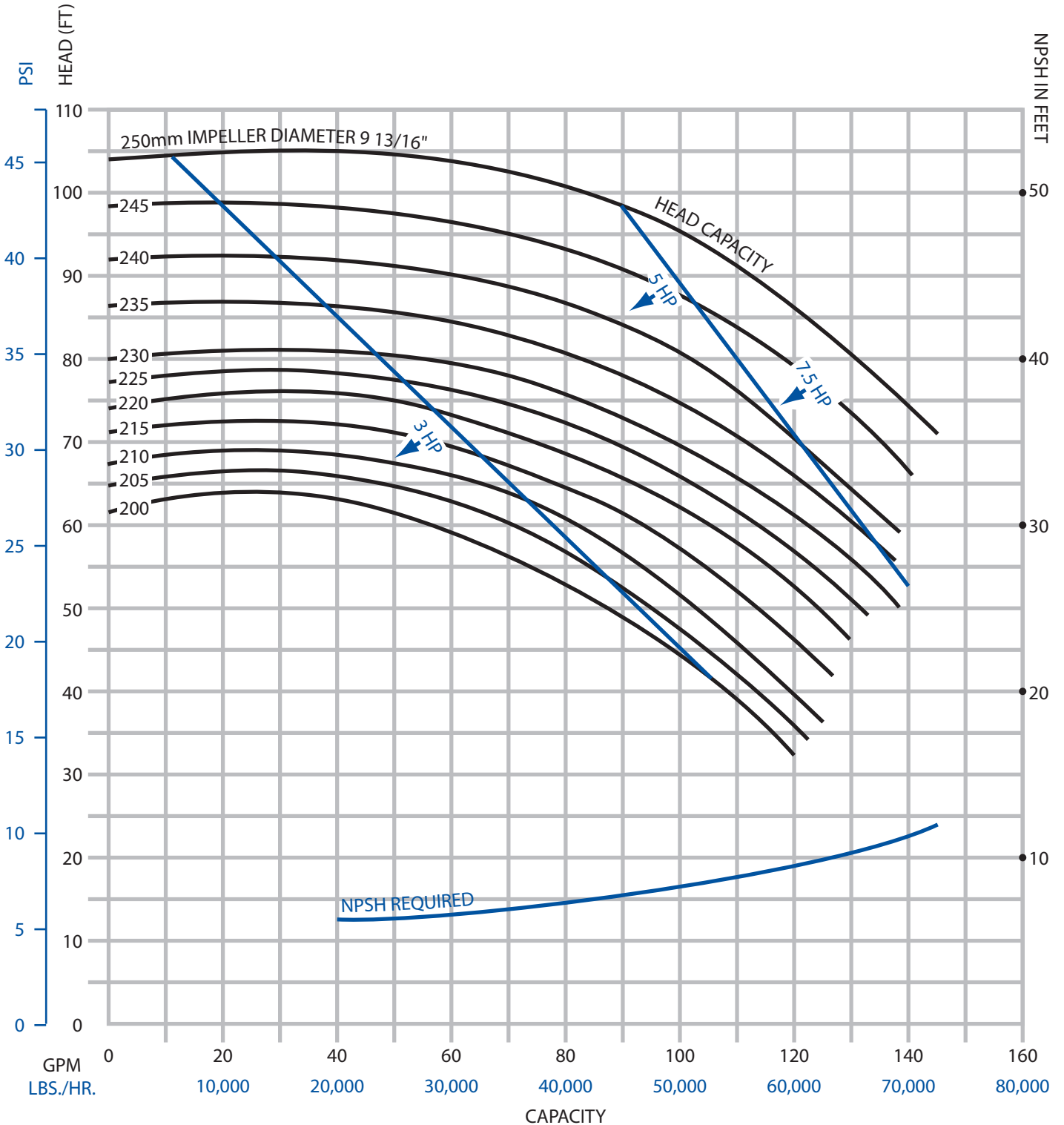

Performance curve based on tests using 70°F water and 0 psig inlet pressure. A tolerance of $\pm 5\%$ applies to all figures. Actual performance may vary by application product. Please contact Fristam for different conditions.

FP/FPX/FPR Performance Curves

Model: 3451 (1750 RPM, Inlet 3", Outlet 2")

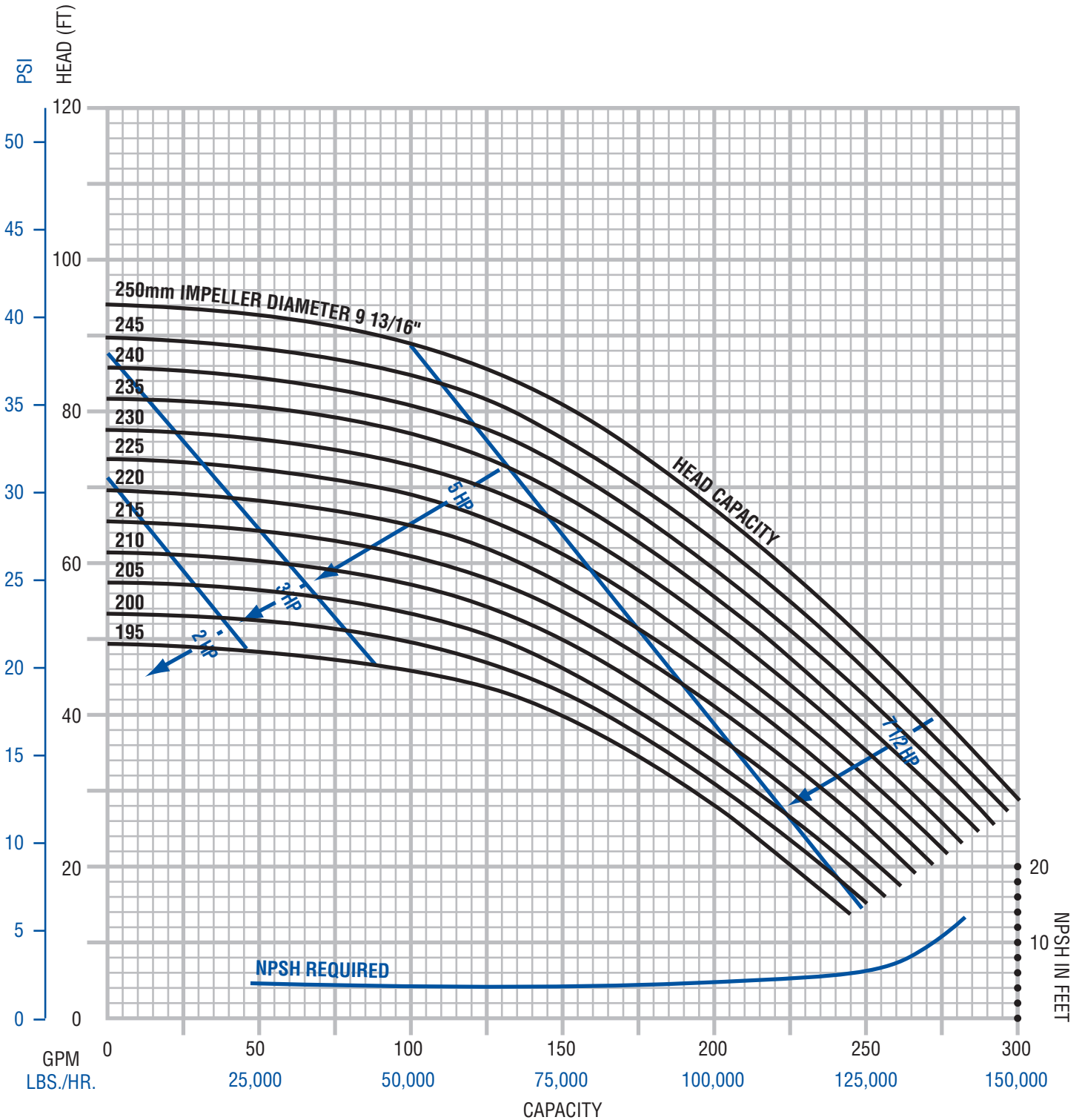

Performance curve based on tests using 70°F water and 0 psig inlet pressure. A tolerance of ± 5% applies to all figures. Actual performance may vary by application product. Please contact Fristam for different conditions.

FP/FPX/FPR Performance Curves
Model: 3551 (1750 RPM, Inlet 3", Outlet 2.5")

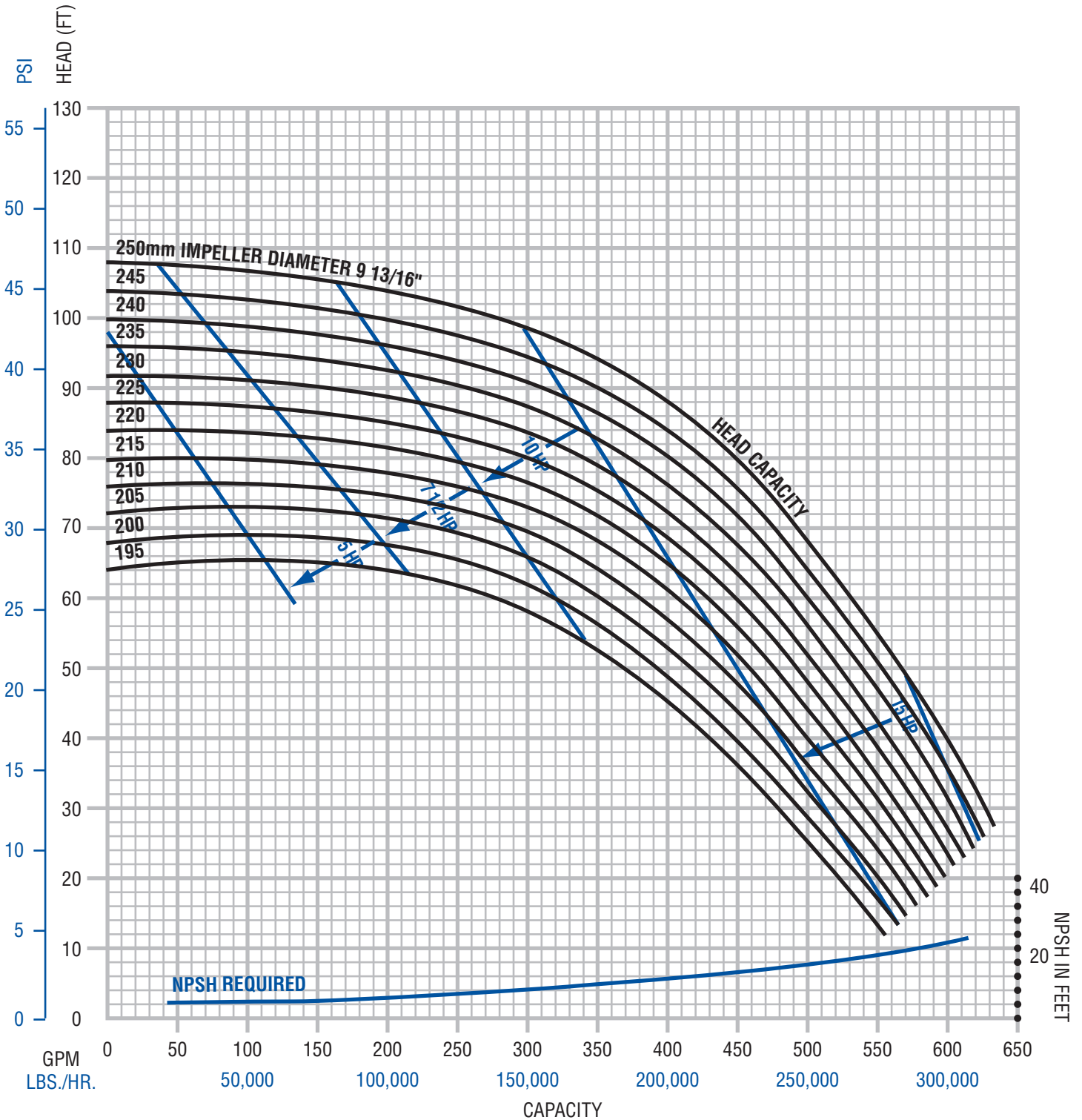

Performance curve based on tests using 70°F water and 0 psig inlet pressure. A tolerance of ± 5% applies to all figures. Actual performance may vary by application product. Please contact Fristam for different conditions.

FP/FPX/FPR Performance Curves

Model: 1051 (1750 RPM, Inlet 4", Outlet 4")

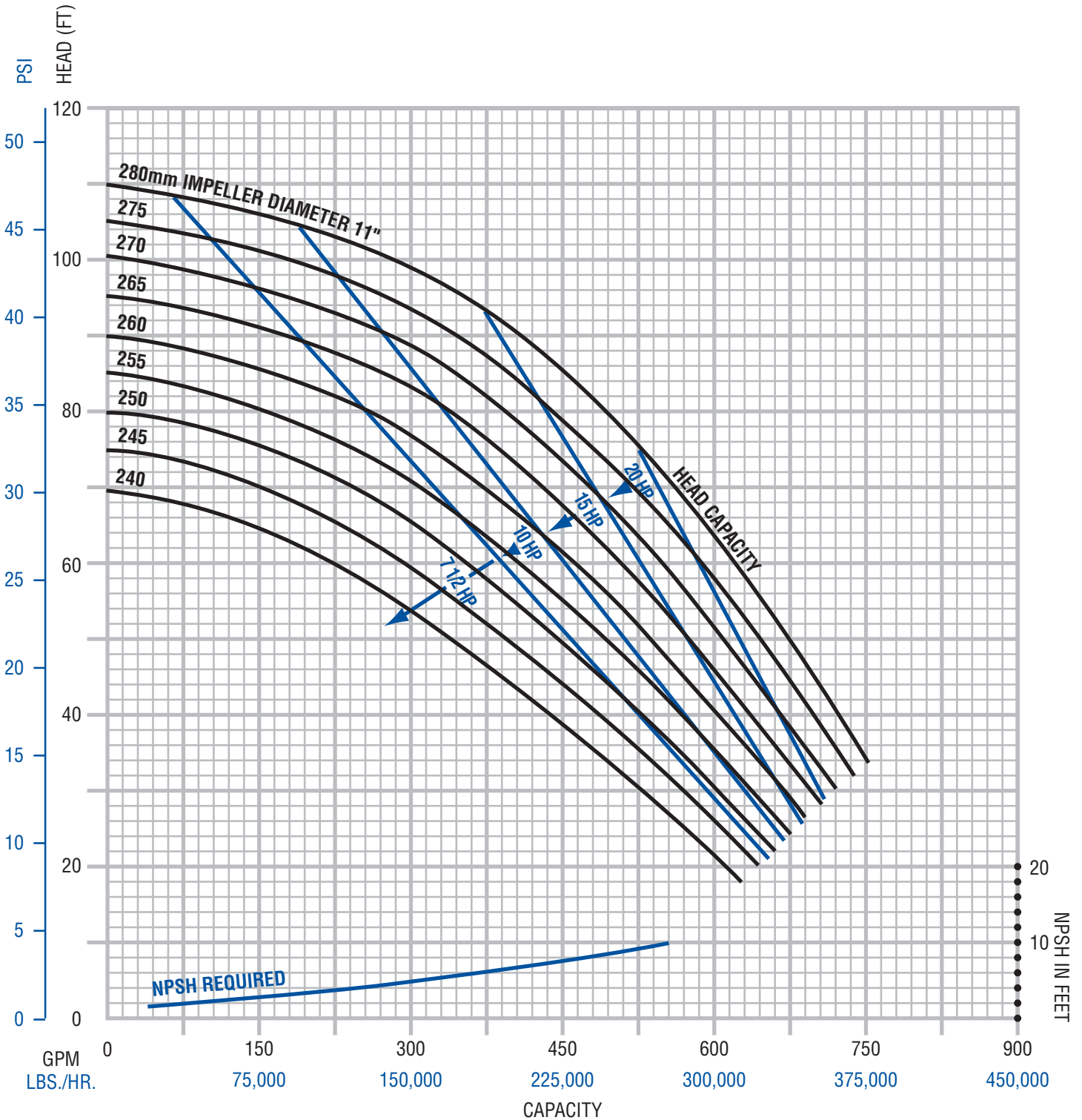

Performance curve based on tests using 70°F water and 0 psig inlet pressure. A tolerance of ± 5% applies to all figures. Actual performance may vary by application product. Please contact Fristam for different conditions.

FP/FPX Performance Curves
Model: 1151 (1750 RPM, Inlet 4", Outlet 4")
FPR model 1161 covers the range of both the FP/FPX 1151 and 1161

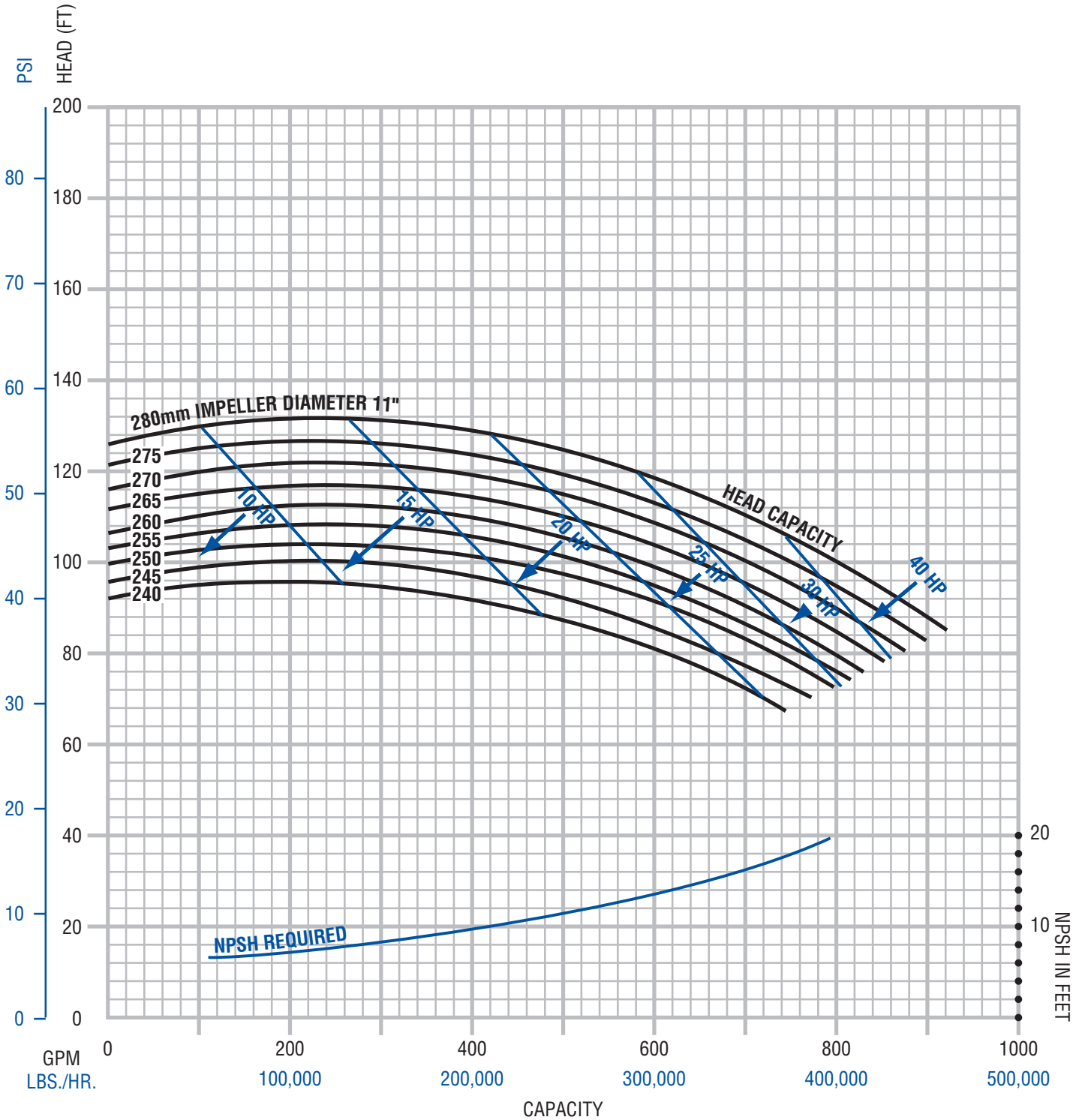

Performance curve based on tests using 70°F water and 0 psig inlet pressure. A tolerance of ± 5% applies to all figures. Actual performance may vary by application product. Please contact Fristam for different conditions.

FP/FPX Performance Curves
Model: 1161 (1750 RPM, Inlet 4", Outlet 4")
FPR model 1161 covers the range of both the FP/FPX 1151 and 1161

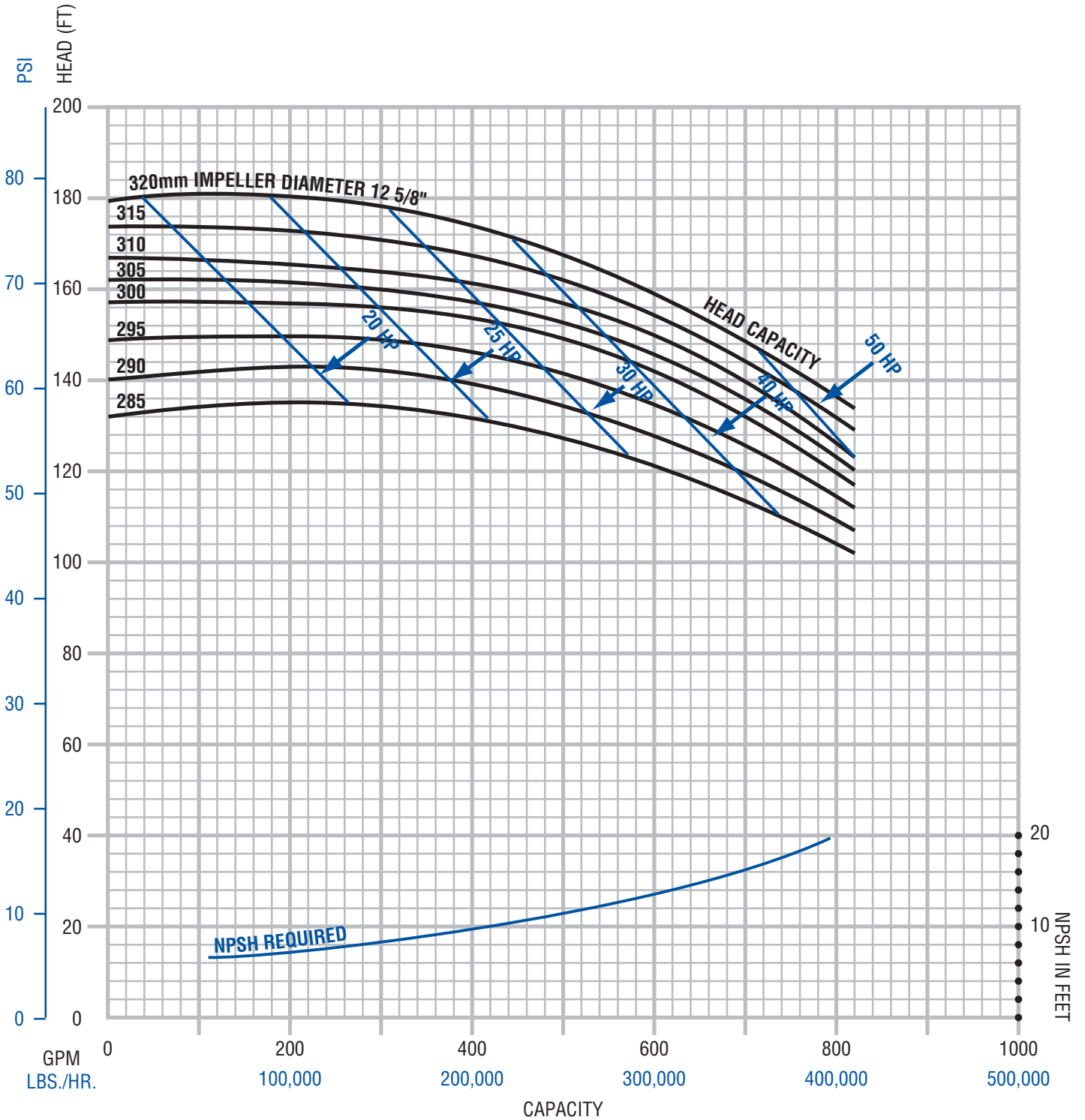

Performance curve based on tests using 70°F water and 0 psig inlet pressure. A tolerance of ± 5% applies to all figures. Actual performance may vary by application product. Please contact Fristam for different conditions.

FPR Performance Curves

Model: 1161 (1750 RPM, Inlet 4", Outlet 4")

FPR model 1161 covers the range of both the FP/FPX 1151 and 1161

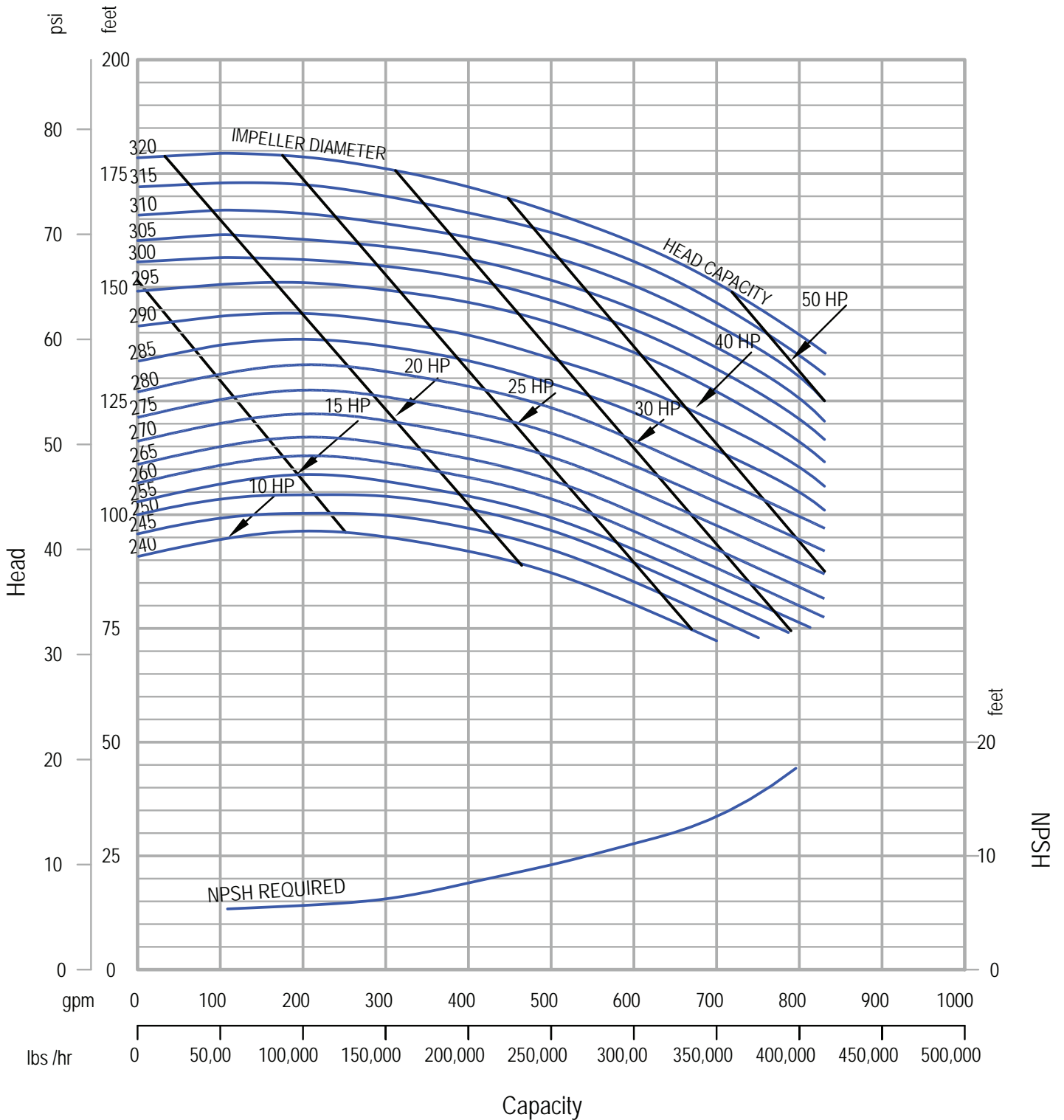

1265000208
Rev. A

Performance curve based on tests using 70°F water and 0 psig inlet pressure. A tolerance of ± 5% applies to all figures. Actual performance may vary by application product. Please contact Fristam for different conditions.

FPR Performance Curves

Model: 4001 (1750 RPM, Inlet 6", Outlet 4")

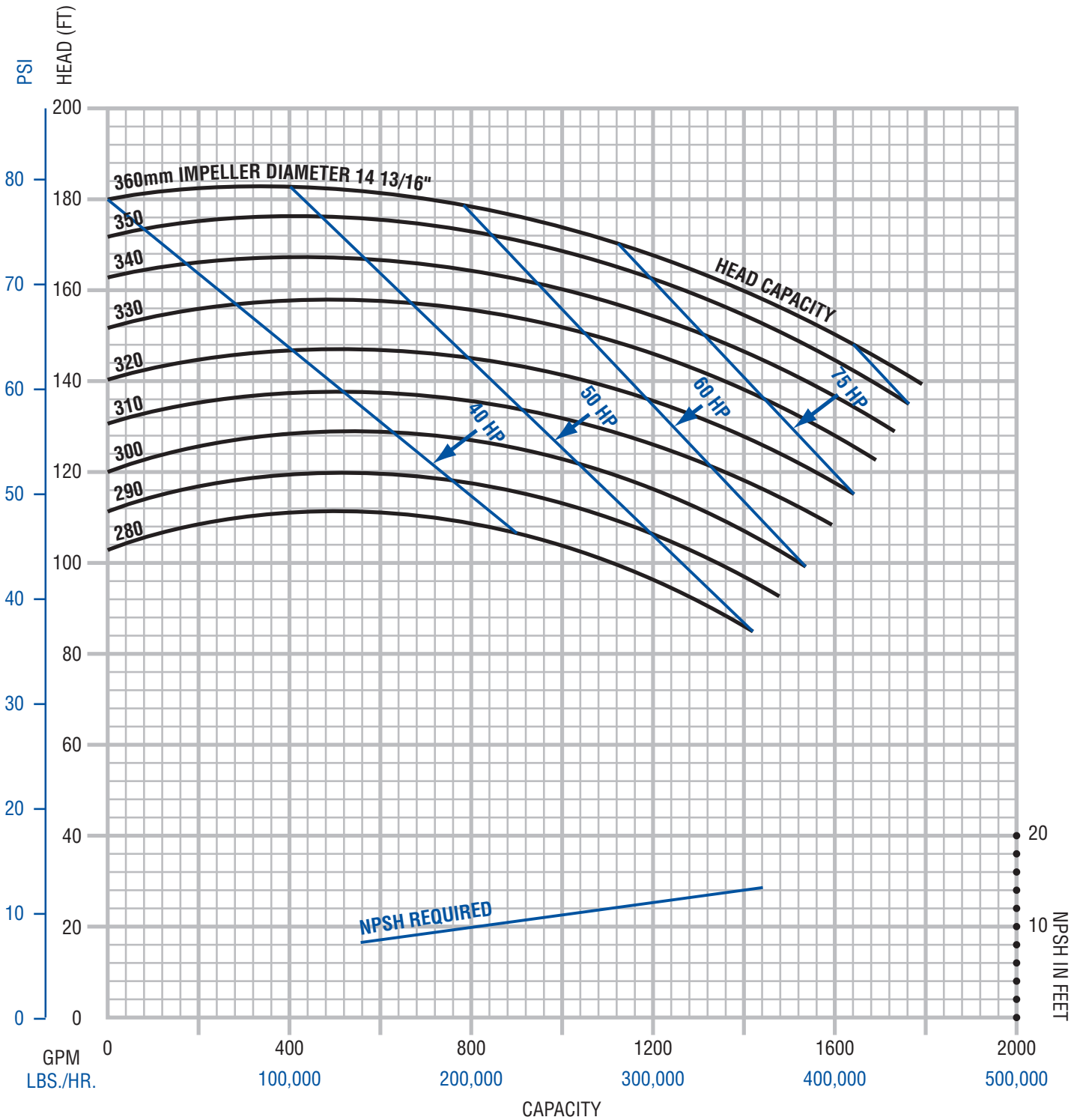

Performance curve based on tests using 70°F water and 0 psig inlet pressure. A tolerance of ± 5% applies to all figures. Actual performance may vary by application product. Please contact Fristam for different conditions.

FP/FPX Performance Curves
Models: 3500 RPM (Composite)

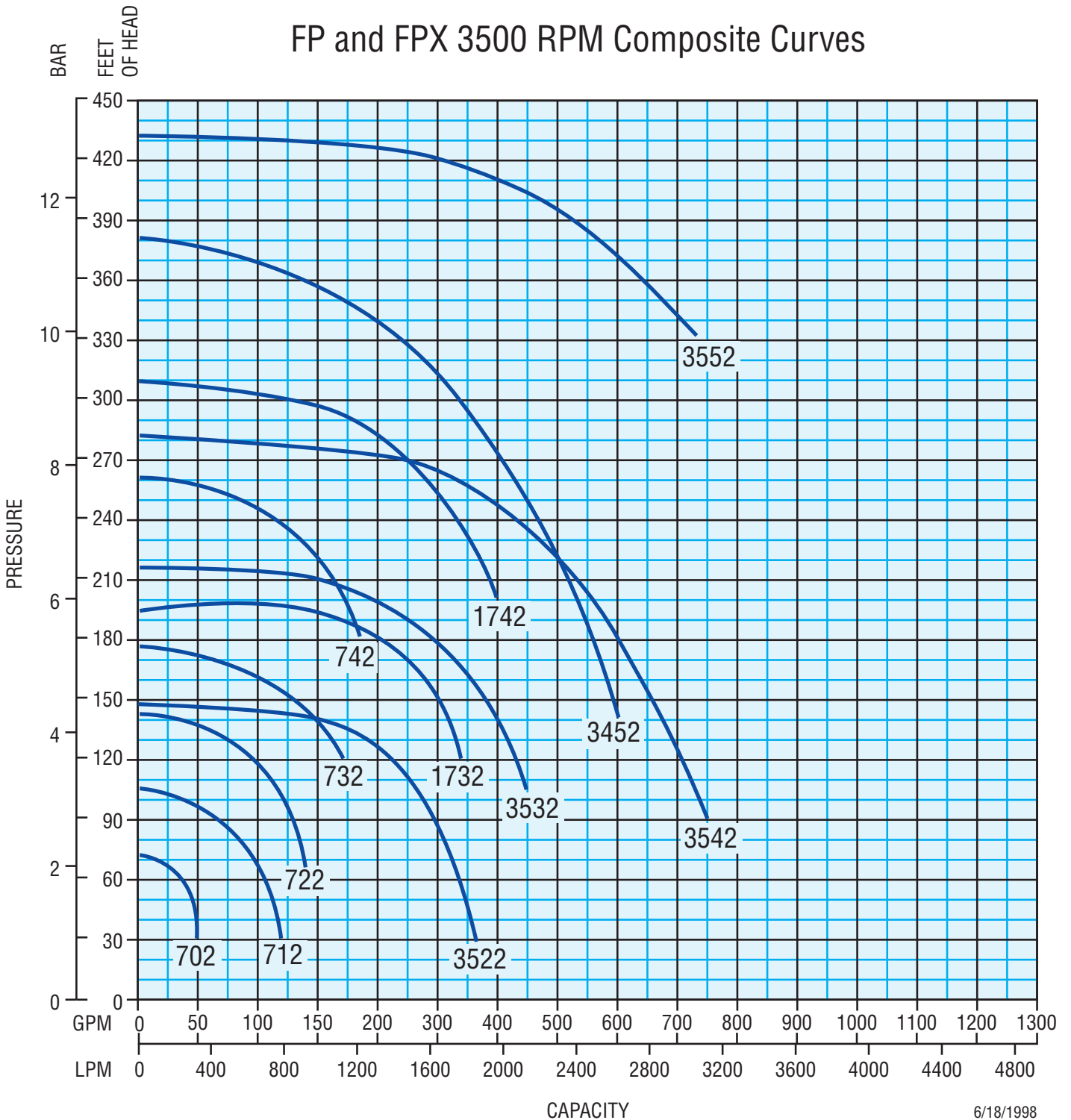

6/18/1998
 il-0364.eps
 RD 2/08

Performance curve based on tests using 70°F water and 0 psig inlet pressure. A tolerance of ± 5% applies to all figures. Actual performance may vary by application product. Please contact Fristam for different conditions.

FPR Performance Curves

Models: 3500 RPM (Composite A)

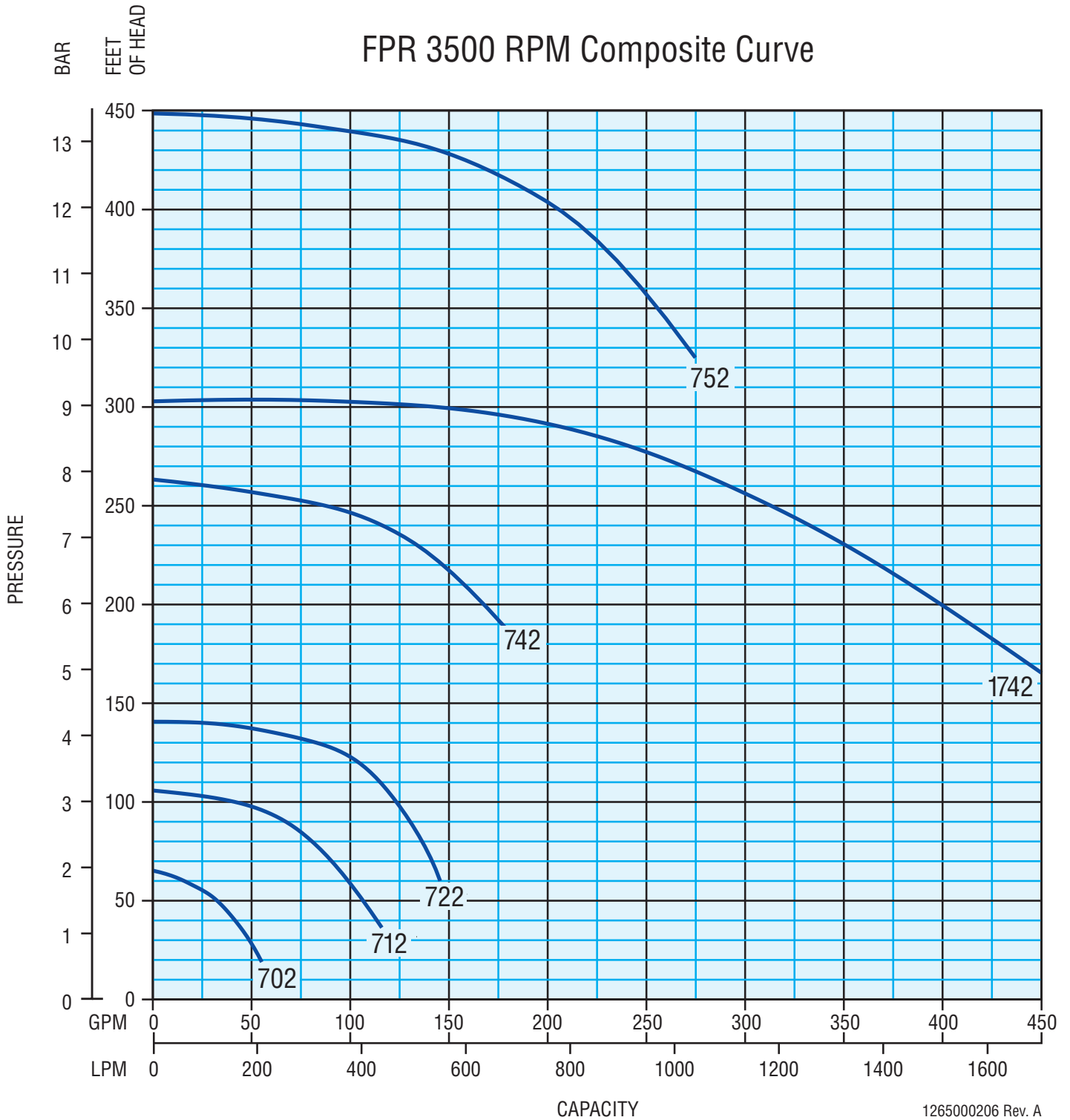

Performance curve based on tests using 70°F water and 0 psig inlet pressure. A tolerance of ± 5% applies to all figures. Actual performance may vary by application product. Please contact Fristam for different conditions.

FPR Performance Curves

Models: 3500 RPM (Composite B)

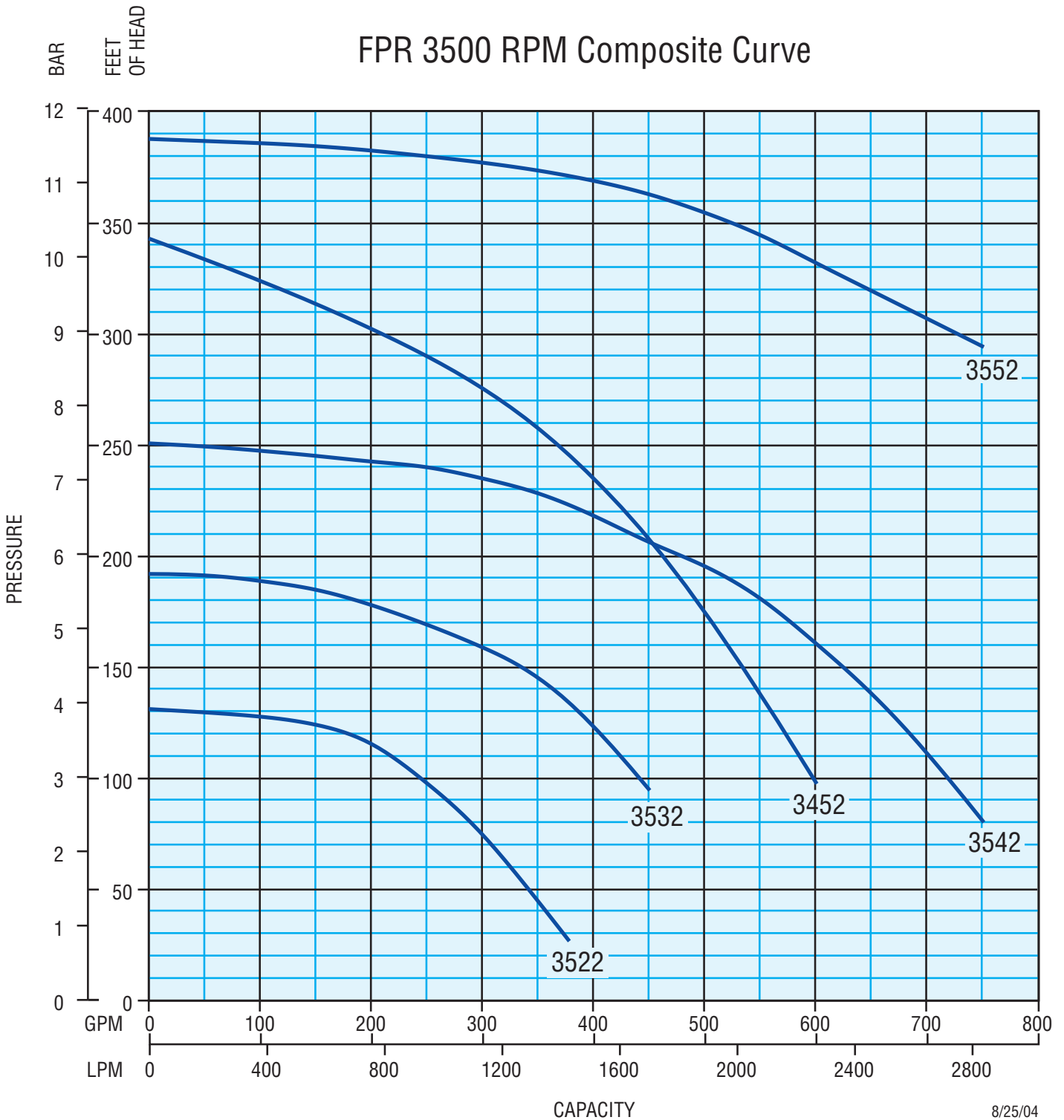

8/25/04
1265000205
RD 2/08

Performance curve based on tests using 70°F water and 0 psig inlet pressure. A tolerance of ± 5% applies to all figures. Actual performance may vary by application product. Please contact Fristam for different conditions.

FP/FPX/FPR Performance Curves

Model: 702 (3500 RPM, Inlet 1.5", Outlet 1.5")

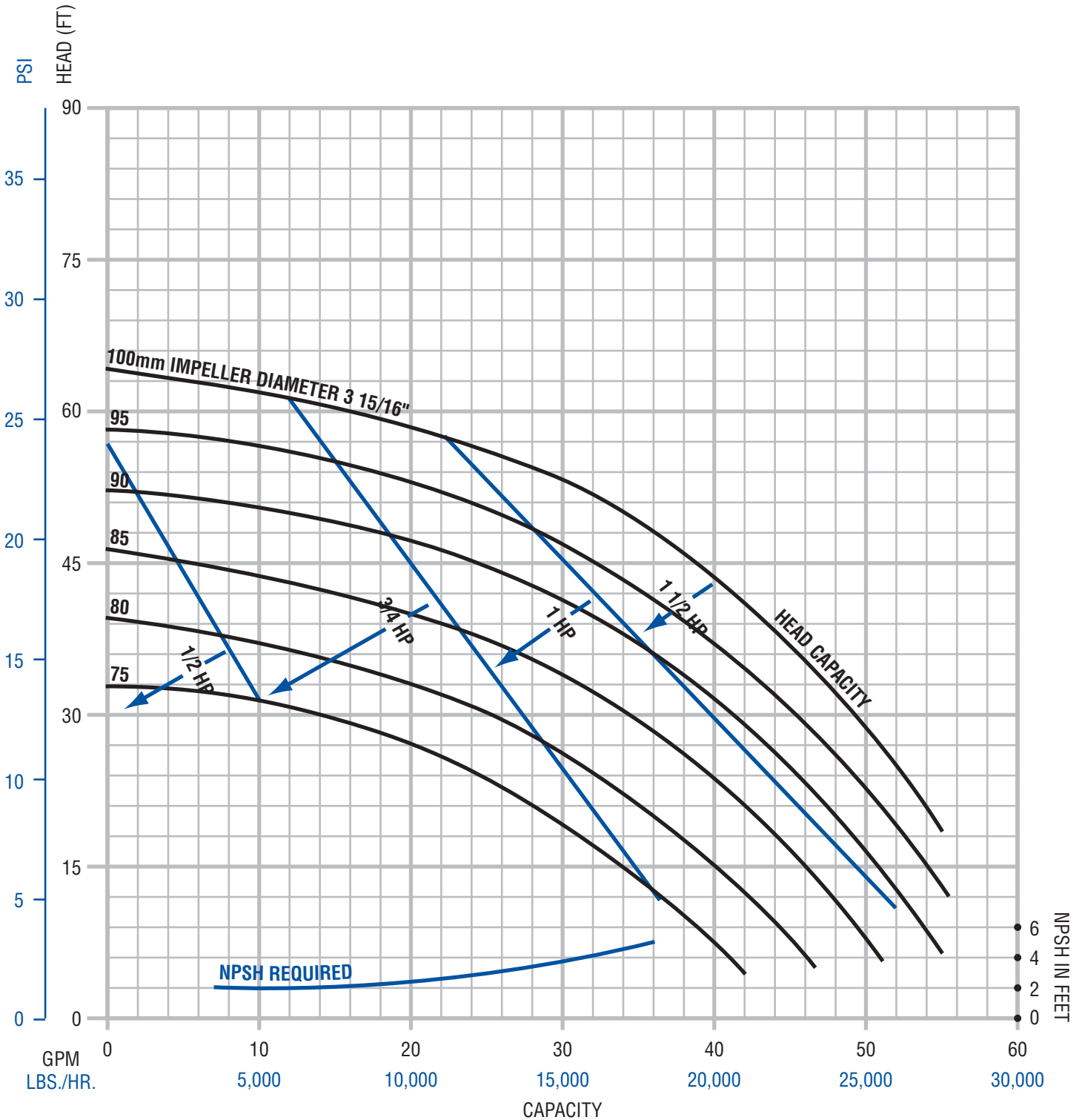

Performance curve based on tests using 70°F water and 0 psig inlet pressure. A tolerance of ± 5% applies to all figures. Actual performance may vary by application product. Please contact Fristam for different conditions.

FP/FPX/FPR Performance Curves

Model: 712 (3500 RPM, Inlet 2", Outlet 1.5")

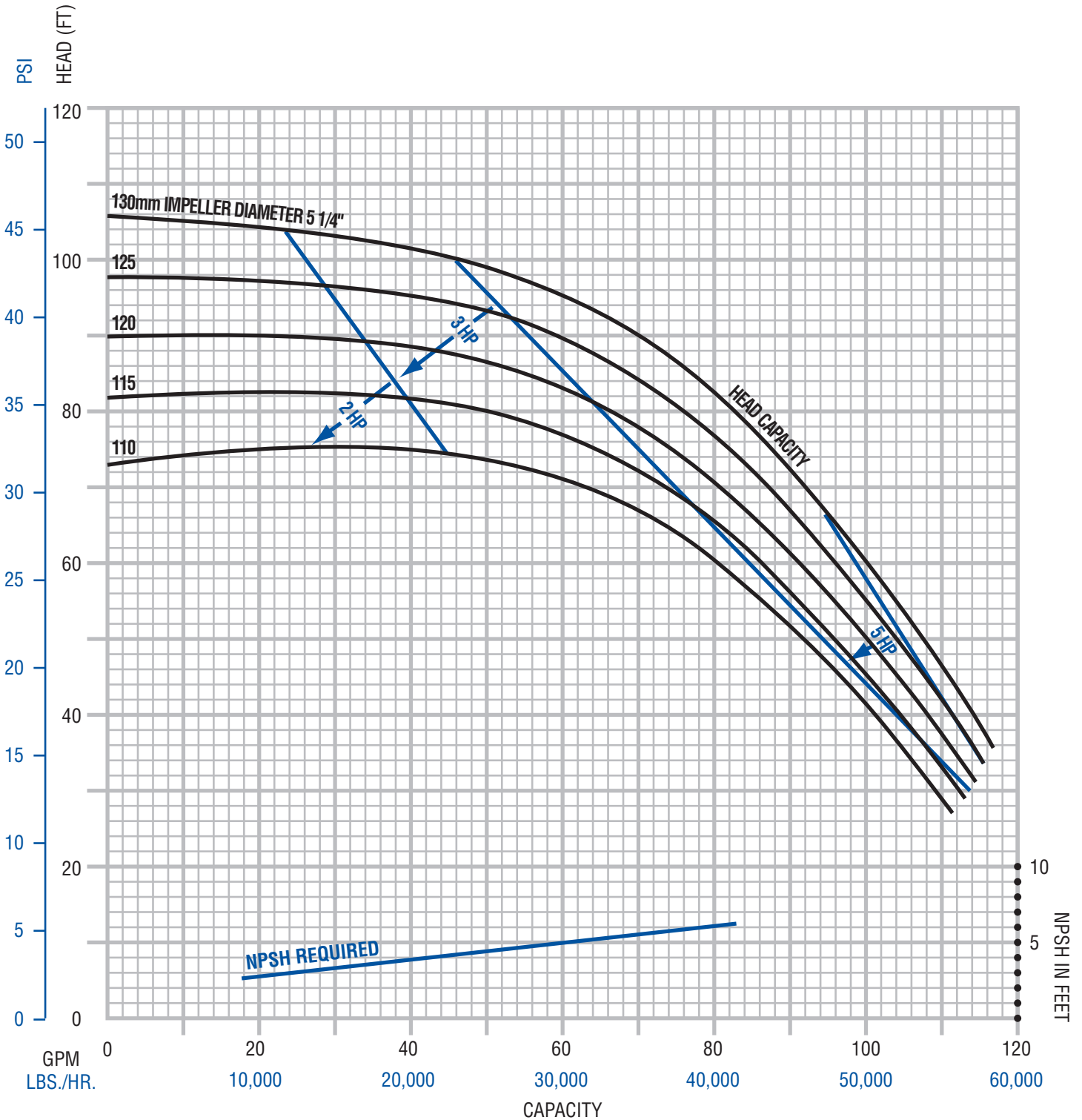

Performance curve based on tests using 70°F water and 0 psig inlet pressure. A tolerance of ± 5% applies to all figures. Actual performance may vary by application product. Please contact Fristam for different conditions.

FP/FPX/FPR Performance Curves

Model: 722 (3500 RPM, Inlet 2", Outlet 1.5")

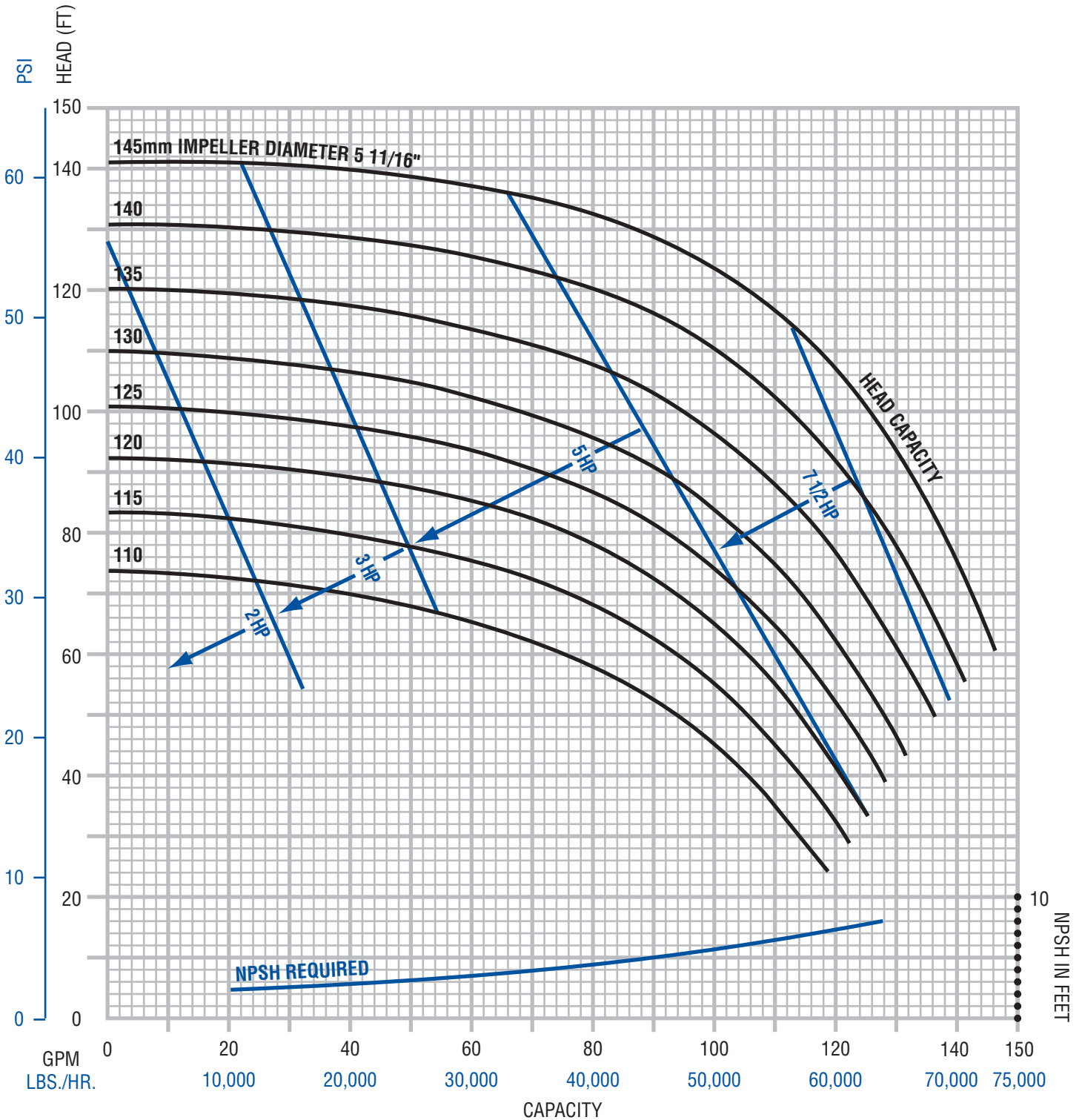

Performance curve based on tests using 70°F water and 0 psig inlet pressure. A tolerance of ± 5% applies to all figures. Actual performance may vary by application product. Please contact Fristam for different conditions.

FP/FPX/FPR Performance Curves
Model: 3522 (3500 RPM, Inlet 2.5", Outlet 2")

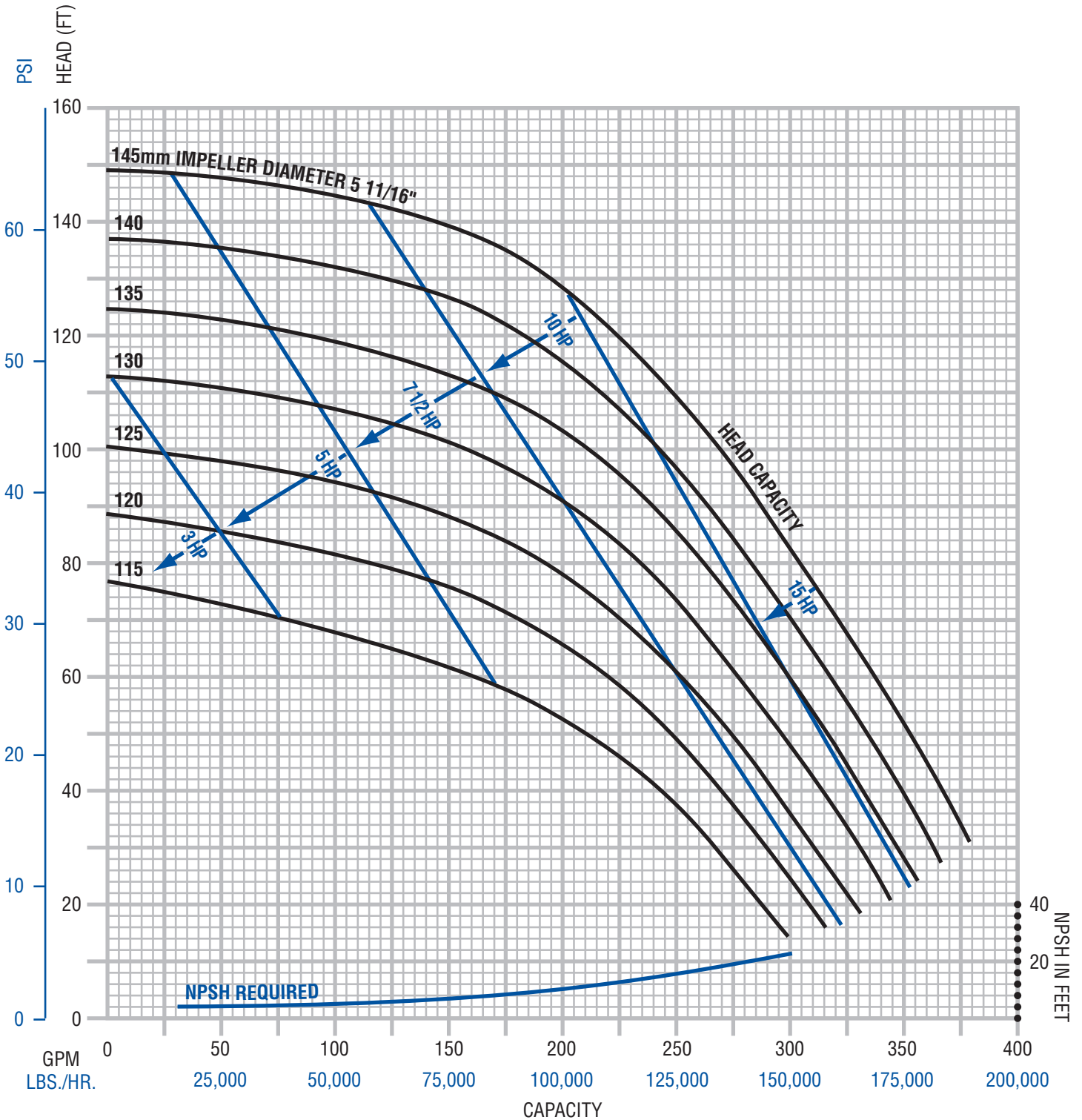

Performance curve based on tests using 70°F water and 0 psig inlet pressure. A tolerance of ± 5% applies to all figures. Actual performance may vary by application product. Please contact Fristam for different conditions.

FP/FPX Performance Curves

Model: 732 (3500 RPM, Inlet 2.5", Outlet 2")

FPR model 742 covers the range of both the FP/FPX 732 and 742

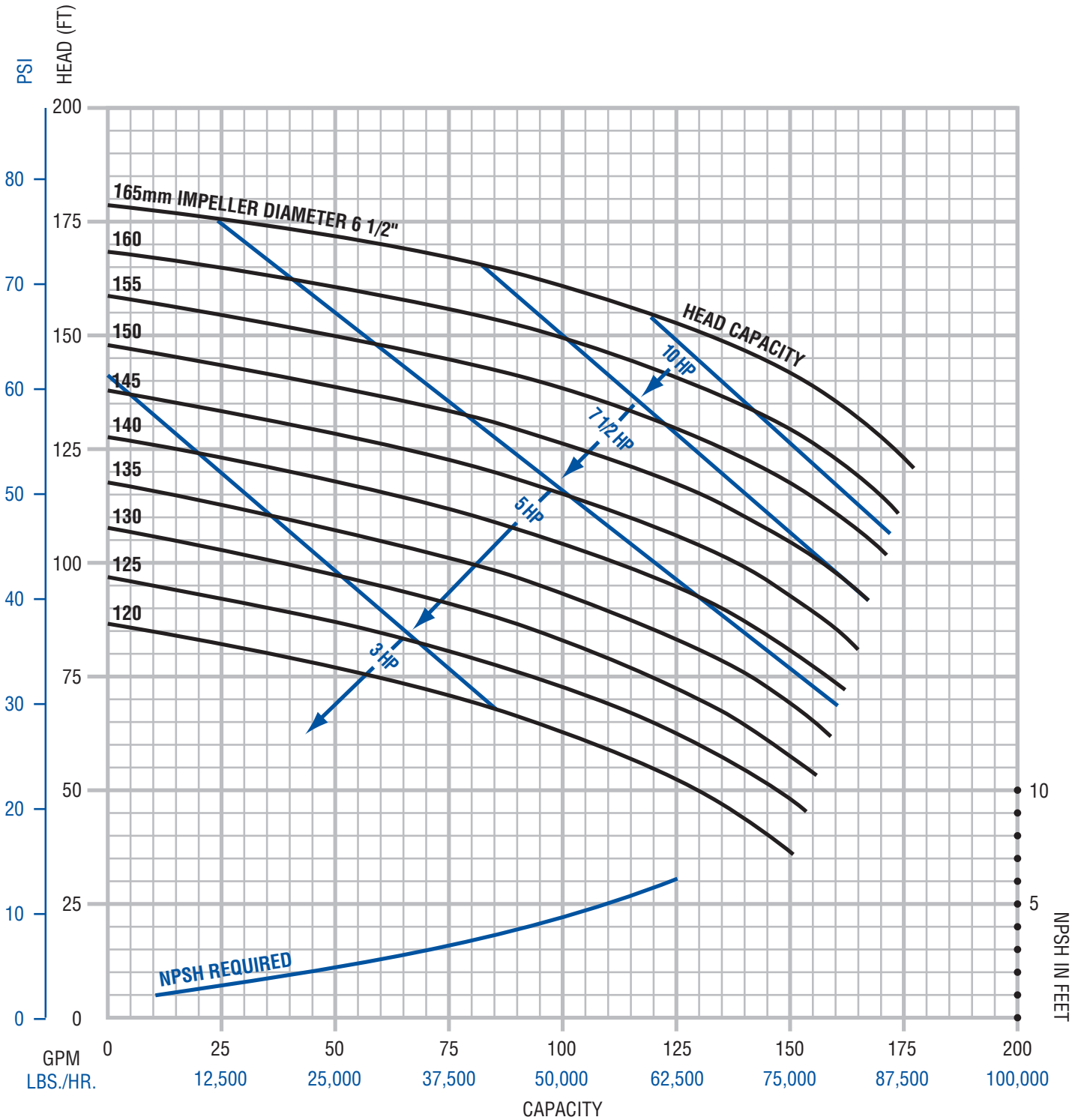

Performance curve based on tests using 70°F water and 0 psig inlet pressure. A tolerance of ± 5% applies to all figures. Actual performance may vary by application product. Please contact Fristam for different conditions.

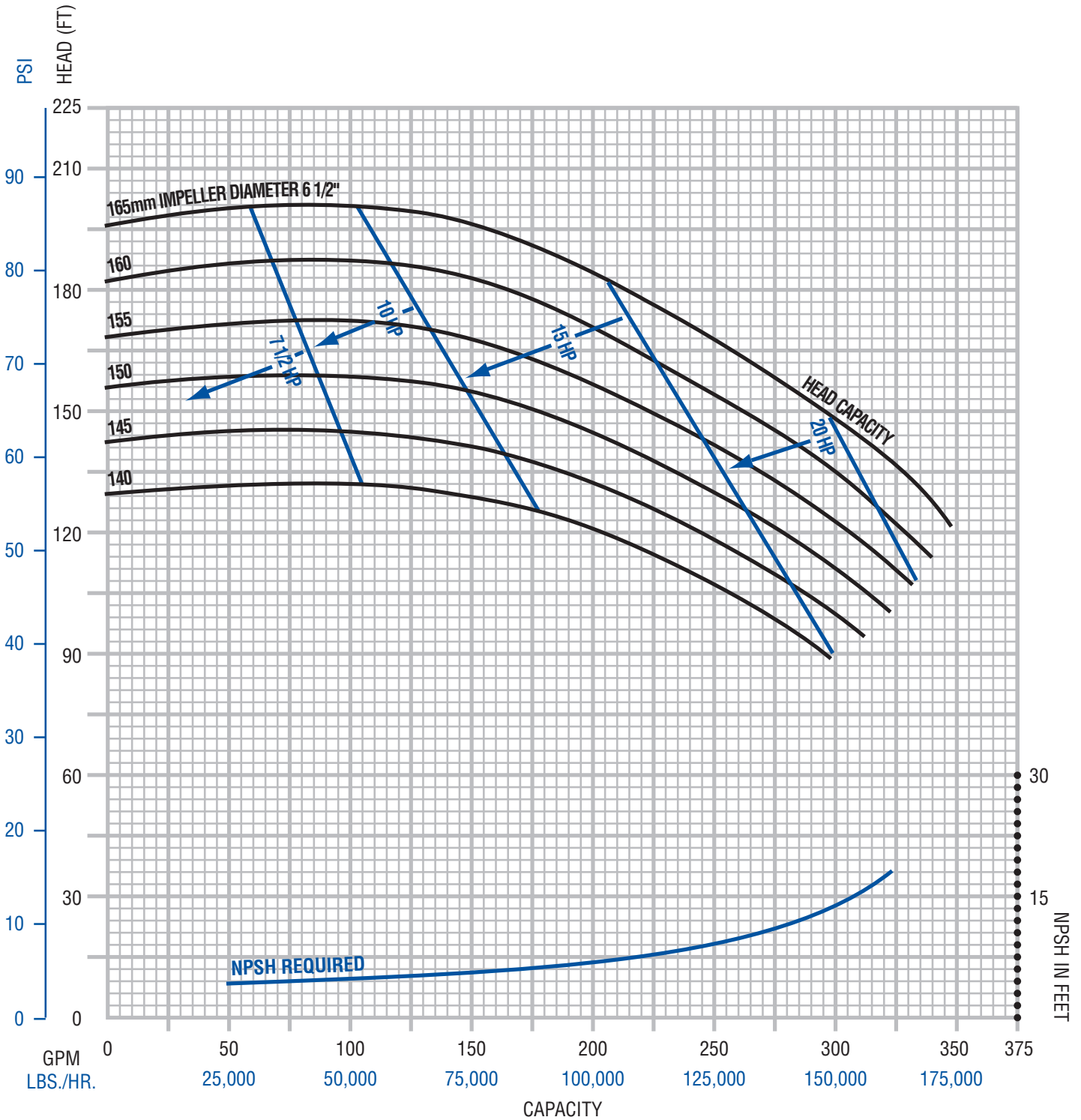

Performance curve based on tests using 70°F water and 0 psig inlet pressure. A tolerance of ± 5% applies to all figures. Actual performance may vary by application product. Please contact Fristam for different conditions.

FP/FPX/FPR Performance Curves
Model: 3532 (3500 RPM, Inlet 2.5", Outlet 2")

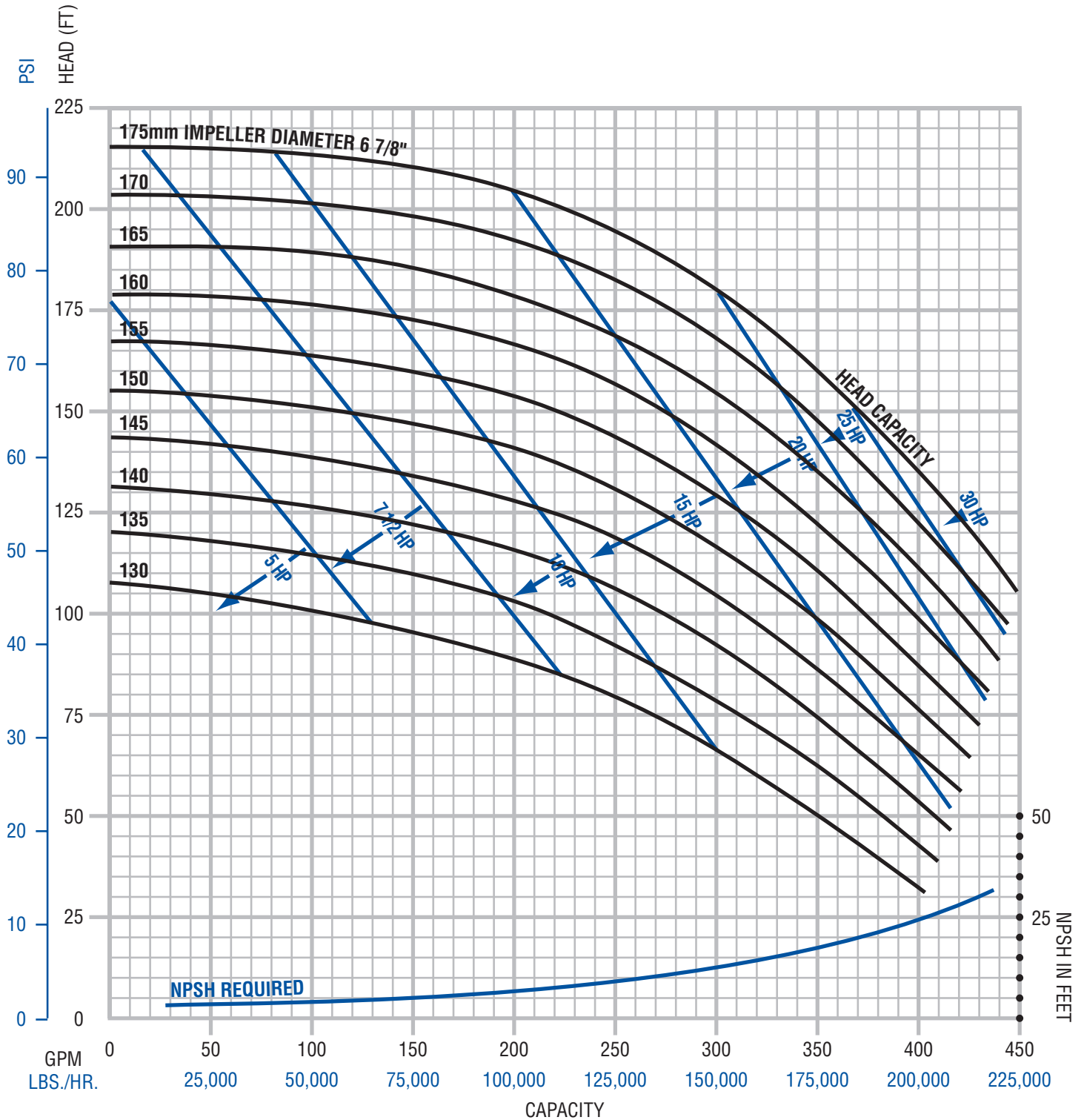

Performance curve based on tests using 70°F water and 0 psig inlet pressure. A tolerance of ± 5% applies to all figures. Actual performance may vary by application product. Please contact Fristam for different conditions.

FP/FPX Performance Curves

Model: 742 (3500 RPM, Inlet 2.5", Outlet 2")
FPR model 742 covers the range of both the FP/FPX 732 and 742

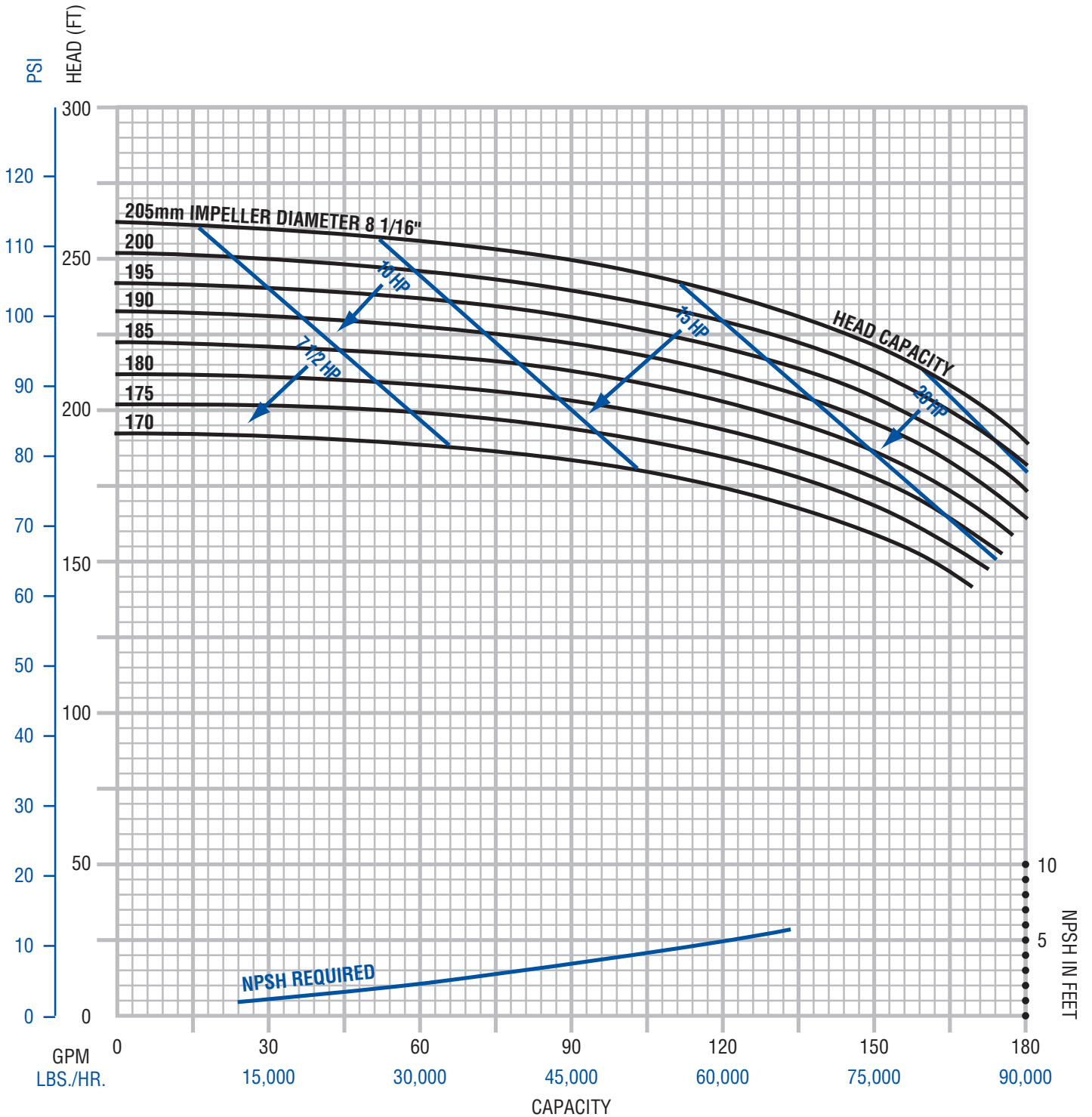

Performance curve based on tests using 70°F water and 0 psig inlet pressure. A tolerance of ± 5% applies to all figures. Actual performance may vary by application product. Please contact Fristam for different conditions.

FPR Performance Curves

Model: 742 (3500 RPM, Inlet 2.5", Outlet 2")

FPR model 742 covers the range of both the FP/FPX 732 and 742

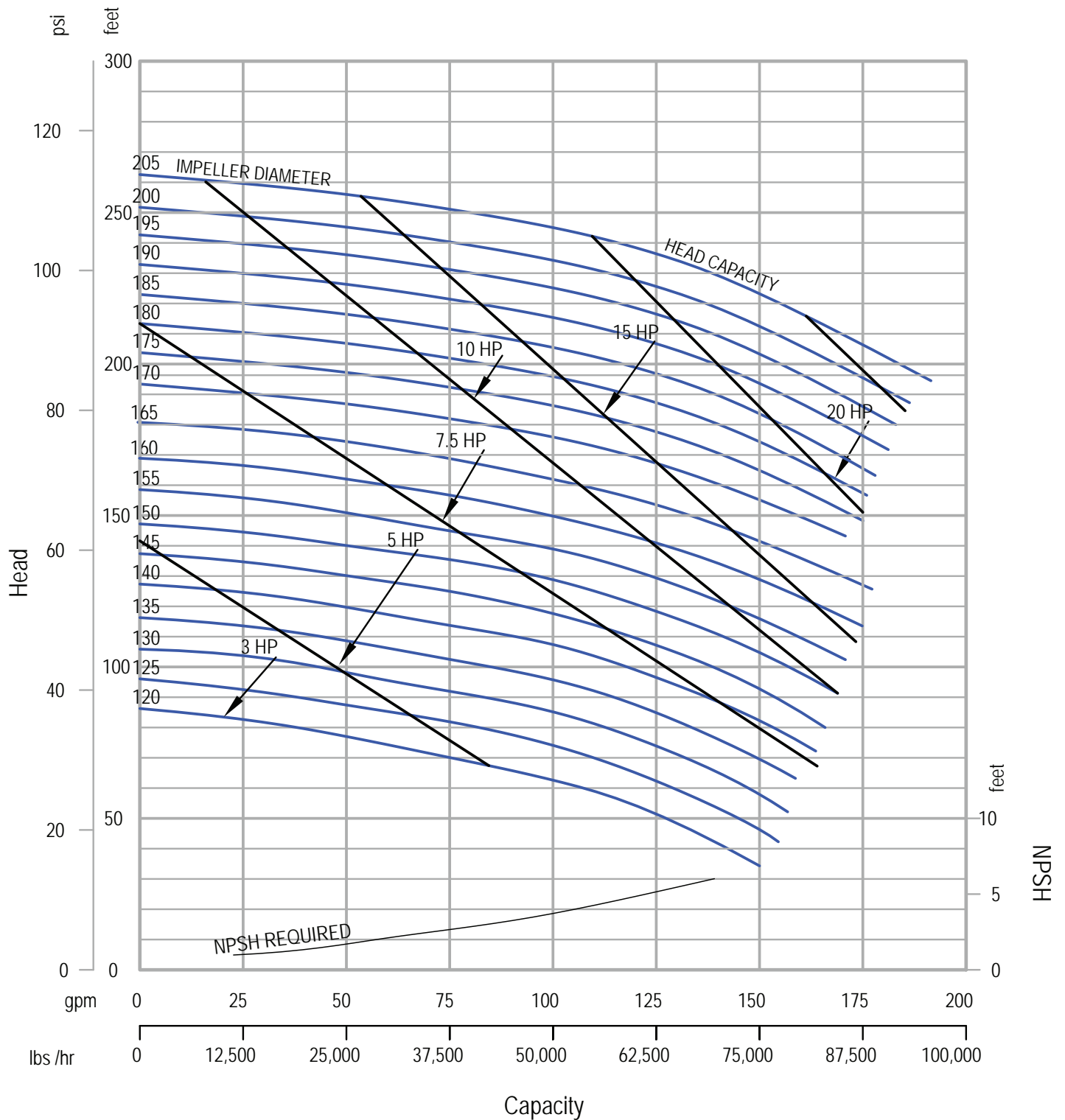

8/25/04
1265000207

Performance curve based on tests using 70°F water and 0 psig inlet pressure. A tolerance of ± 5% applies to all figures. Actual performance may vary by application product. Please contact Fristam for different conditions.

FP/FPX Performance Curves

Model: 1742 (3500 RPM, Inlet 2.5", Outlet 2")

FPR model 1742 covers the range of both the FP/FPX 1732 and 1742

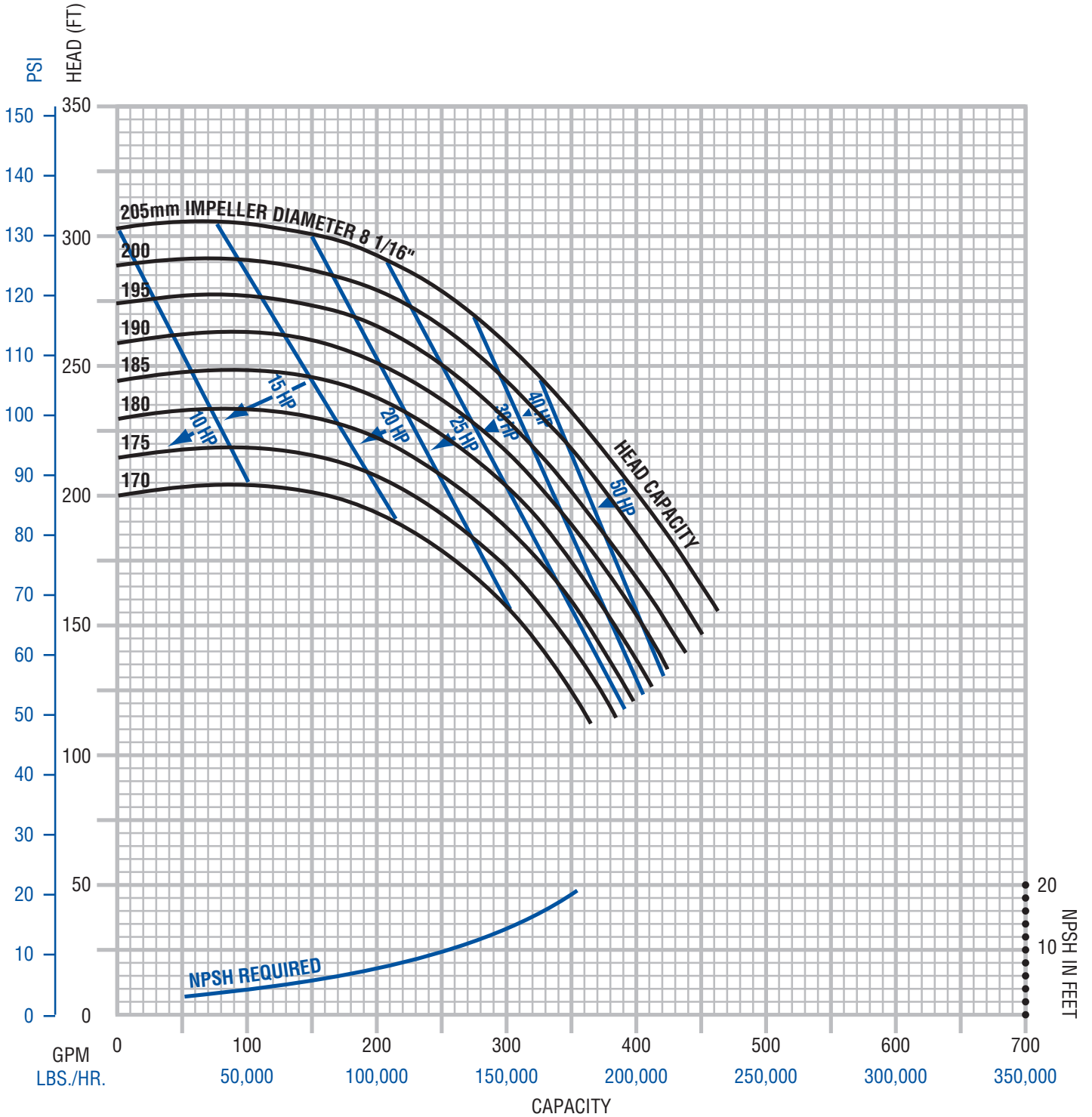

Performance curve based on tests using 70°F water and 0 psig inlet pressure. A tolerance of ± 5% applies to all figures. Actual performance may vary by application product. Please contact Fristam for different conditions.

FPR Performance Curves

Model: 1742 (3500 RPM, Inlet 2.5", Outlet 2")

FPR model 1742 covers the range of both the FP/FPX 1732 and 1742

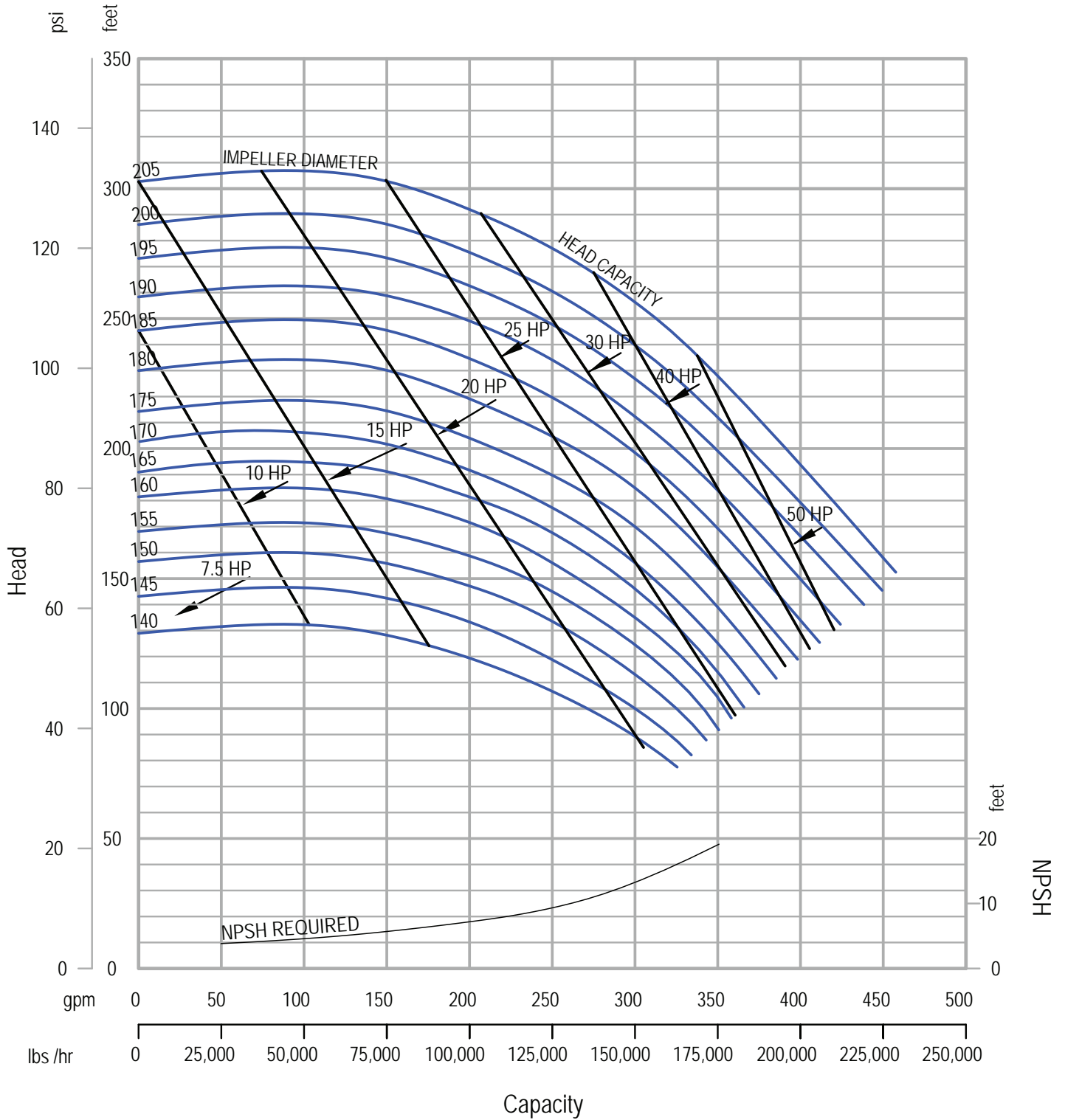

8/26/04
1265000209

Performance curve based on tests using 70°F water and 0 psig inlet pressure. A tolerance of $\pm 5\%$ applies to all figures. Actual performance may vary by application product. Please contact Fristam for different conditions.

FP/FPX/FPR Performance Curves
Model: 3542 (3500 RPM, Inlet 3", Outlet 2.5")

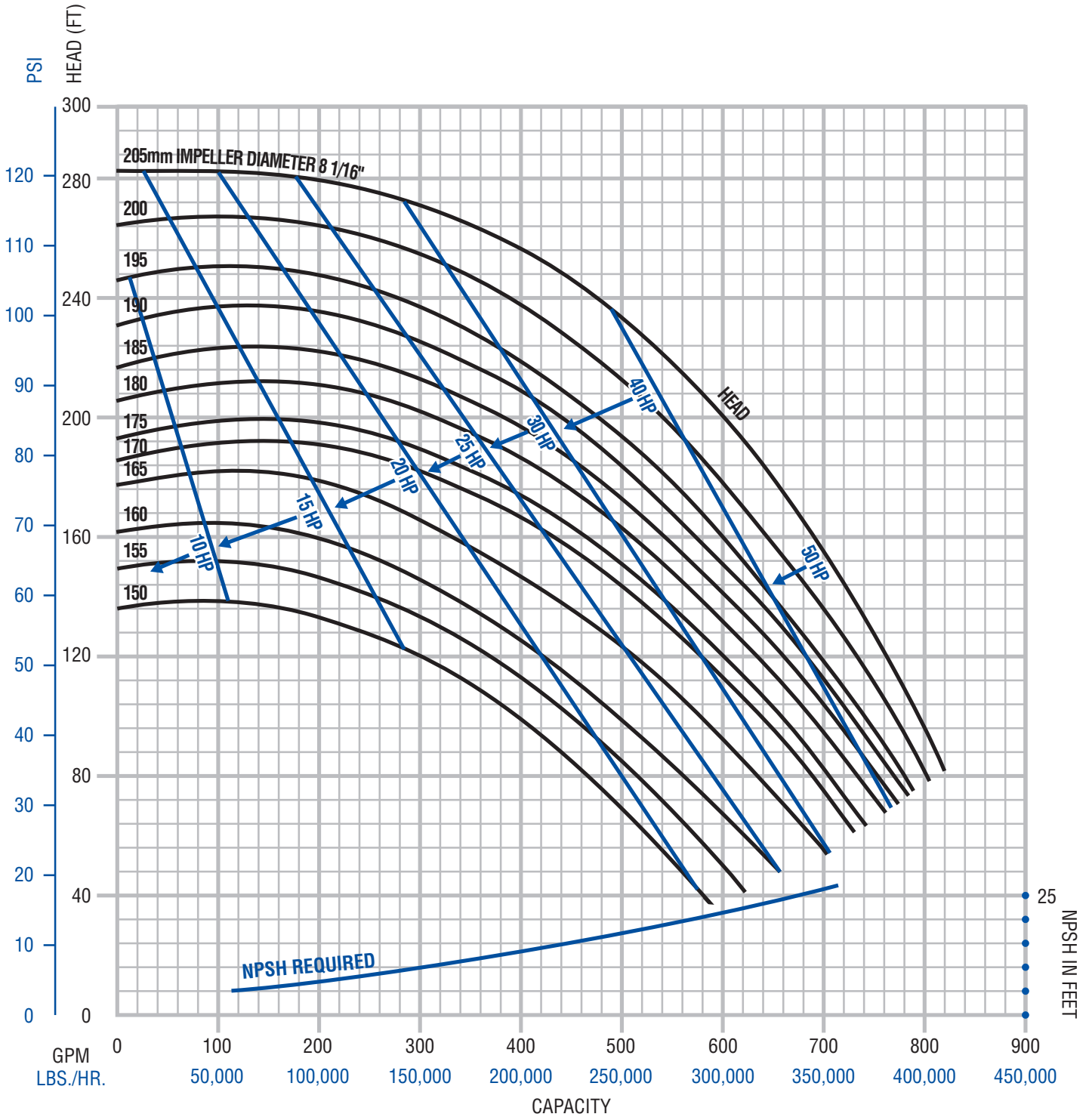

Performance curve based on tests using 70°F water and 0 psig inlet pressure. A tolerance of ± 5% applies to all figures. Actual performance may vary by application product. Please contact Fristam for different conditions.

FPR Performance Curves

Model: 752 (3500 RPM, Inlet 3", Outlet 2")

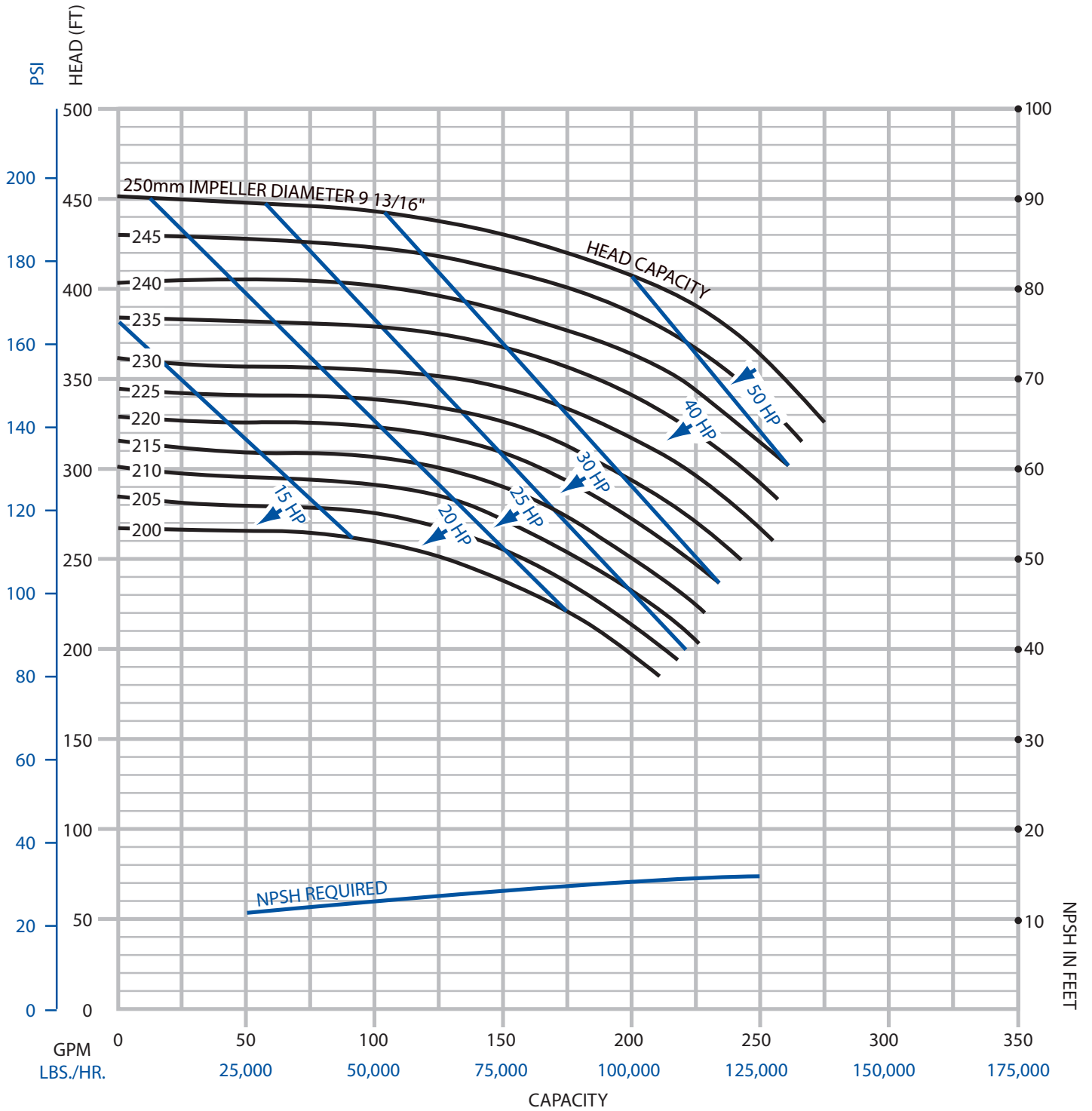

Performance curve based on tests using 70°F water and 0 psig inlet pressure. A tolerance of ± 5% applies to all figures. Actual performance may vary by application product. Please contact Fristam for different conditions.

FP/FPX/FPR Performance Curves
Model: 3452 (3500 RPM, Inlet 3", Outlet 2")

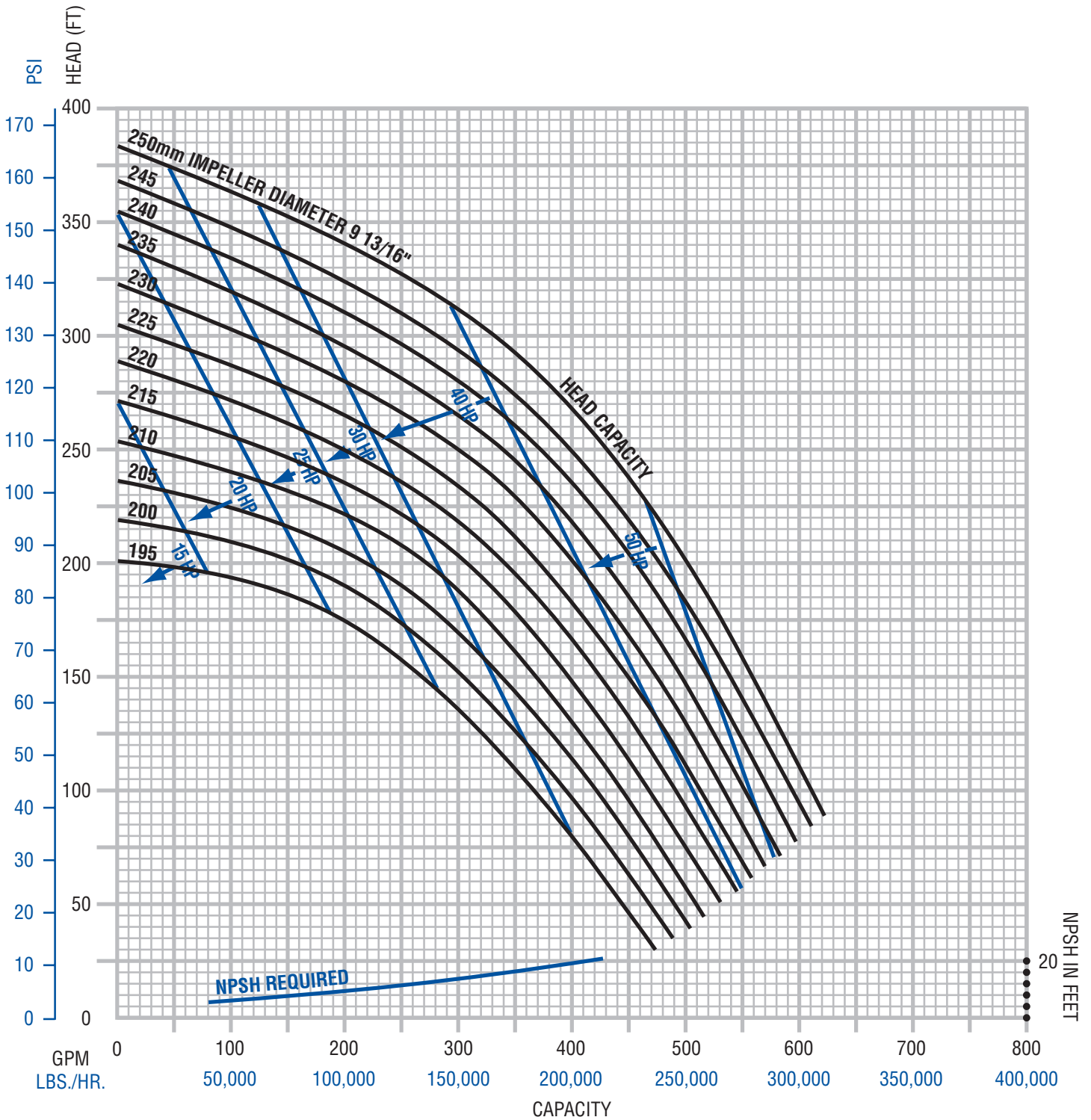

Performance curve based on tests using 70°F water and 0 psig inlet pressure. A tolerance of ± 5% applies to all figures. Actual performance may vary by application product. Please contact Fristam for different conditions.

FP/FPX/FPR Performance Curves
Model: 3552 (3500 RPM, Inlet 3", Outlet 2.5")

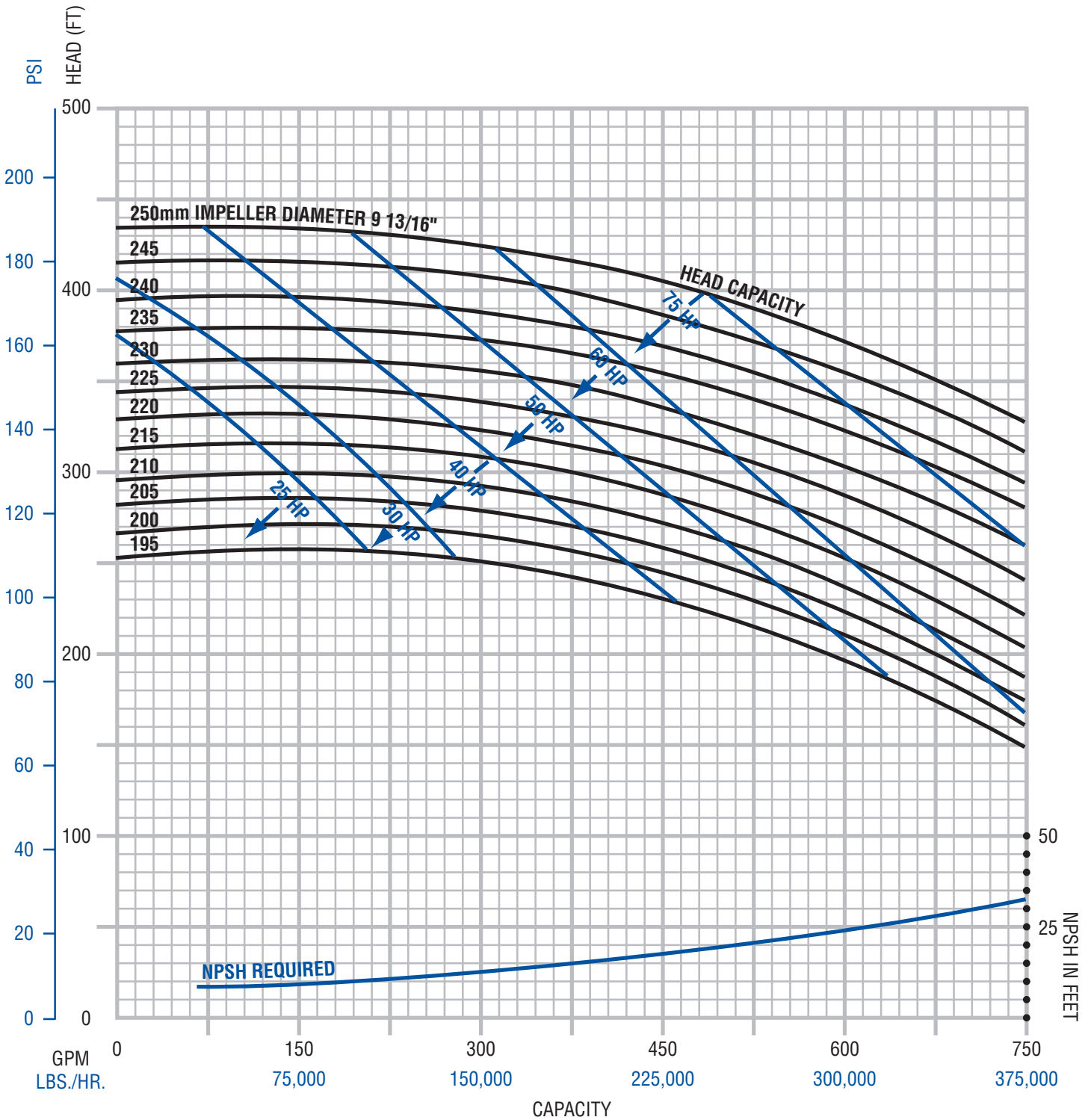

Performance curve based on tests using 70°F water and 0 psig inlet pressure. A tolerance of ± 5% applies to all figures. Actual performance may vary by application product. Please contact Fristam for different conditions.

FP Single Flange Dimensional Drawing

All pump dimensions are in millimeters (inches). Dimensions are based on clamp fittings. Motor dimensions may vary by manufacturer.

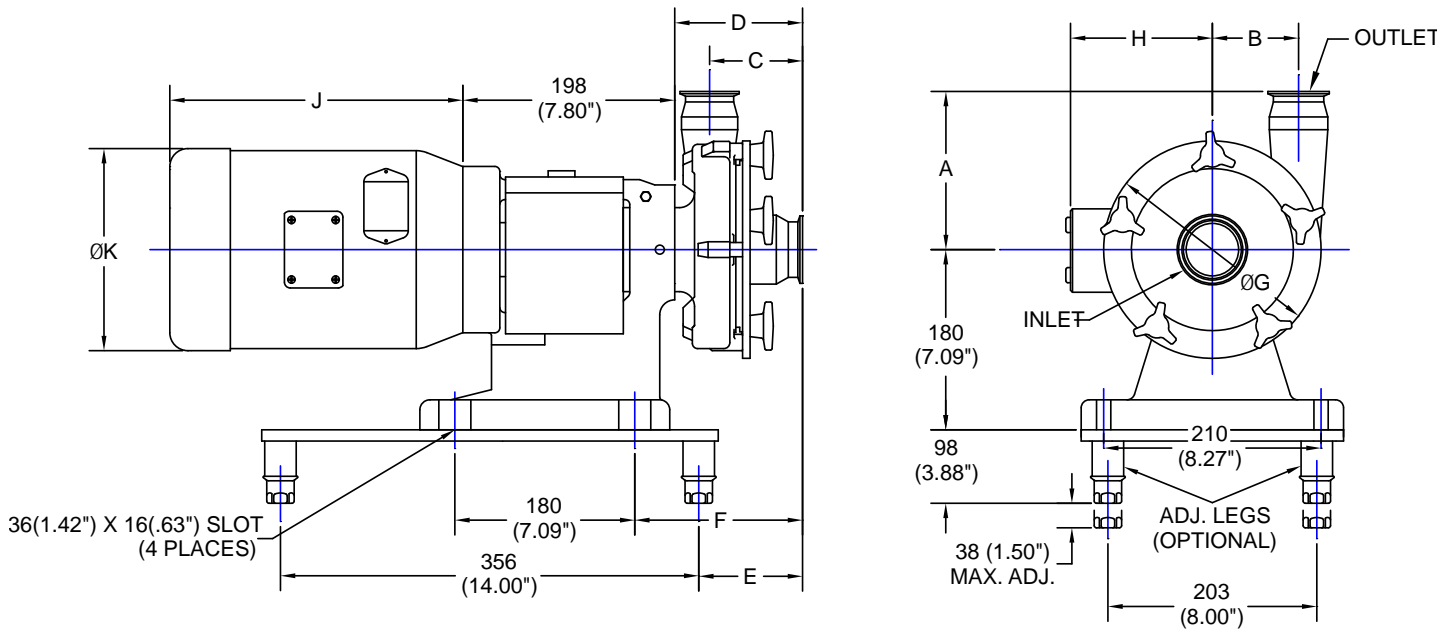

1265000384 REV-

PUMP MODEL	INLET	OUTLET	DIMENSIONS IN MILLIMETERS (INCHES)						
			A	B	C	D	E	F	ØG
FP 701 / 702	1.5"	1.5"	108 (4.25")	44.5 (1.75")	108.5 (4.27")	146.5 (5.77")	154.5 (6.08")	186.5 (7.34")	150 (5.90")
FP 711 / 712	2"	1.5"	144 (5.67")	58 (2.28")	113 (4.45")	150 (5.90")	158 (6.22")	190 (7.48")	185 (7.28")
FP 721 / 731 / 722	2"	1.5"	170 (6.69")	79 (3.11")	113 (4.45")	150 (5.90")	158 (6.22")	190 (7.48")	230 (9.06")
FP 741 / 732 / 742	2.5"	2"	195 (7.68")	96 (3.78")	101 (3.98")	141 (5.55")	149 (5.87")	181 (7.13")	270 (10.63")
FP 1741 / 1732 / 1742	2.5"	2"	200 (7.87")	91 (3.58")	104 (4.09")	150.5 (5.93")	158.5 (6.24")	190.5 (7.50")	270 (10.63")
FP 3521 / 3522	2.5"	2"	190 (7.48")	80 (3.15")	118 (4.64")	162 (6.38")	170 (6.69")	202 (7.95")	230 (9.06")
FP 3531 / 3532	2.5"	2"	191 (7.52")	95 (3.74")	115.5 (4.55")	162 (6.38")	170 (6.69")	202 (7.95")	260 (10.24")
FP 3541 / 3542	3"	2.5"	211 (8.31")	115 (4.53")	118 (4.64")	162 (6.38")	170 (6.69")	202 (7.95")	290 (11.42")
FP 3451 / 3452	3"	2"	211 (8.31")	140 (5.51")	114 (4.49")	158 (6.22")	166 (6.54")	198 (7.80")	350 (13.78")

MOTOR HP	MOTOR FRAME	DIMENSIONS IN MILLIMETERS (INCHES)		
		H	J	ØK
1750 RPM	3500 RPM			
0.5 HP	56C	115 (4.53")	236 (9.29")	157 (6.19")
0.75 HP	0.75 HP	115 (4.53")	236 (9.29")	157 (6.19")
1 HP	1 HP	115 (4.53")	236 (9.29")	157 (6.19")
1.5 HP	1.5 HP	115 (4.53")	252 (9.94")	157 (6.19")
1.5 HP	145TC	133 (5.22")	259 (10.19")	183 (7.19")
2 HP	2 HP	133 (5.22")	284 (11.19")	183 (7.19")
2 HP	145TC	133 (5.22")	284 (11.19")	183 (7.19")
3 HP	3 HP	133 (5.22")	284 (11.19")	183 (7.19")
3 HP	182TC	133 (5.23")	313 (12.31")	216 (8.50")
5 HP	5 HP	152 (6.00")	348 (13.68")	216 (8.50")
5 HP	184TC	152 (6.00")	386 (15.18")	216 (8.50")
7.5 HP	7.5 HP	189 (7.46")	388 (15.27")	263 (10.34")
7.5 HP	213TC	189 (7.46")	388 (15.27")	263 (10.34")
10 HP	10 HP	189 (7.46")	388 (15.27")	263 (10.34")
10 HP	15 HP	189 (7.46")	416 (16.40")	263 (10.34")
10 HP	215TC	189 (7.46")	416 (16.40")	263 (10.34")

1265000385 REV-

FP Double Flange Dimensional Drawing

All pump dimensions are in millimeters (inches). Dimensions are based on clamp fittings. Motor dimensions may vary by manufacturer.

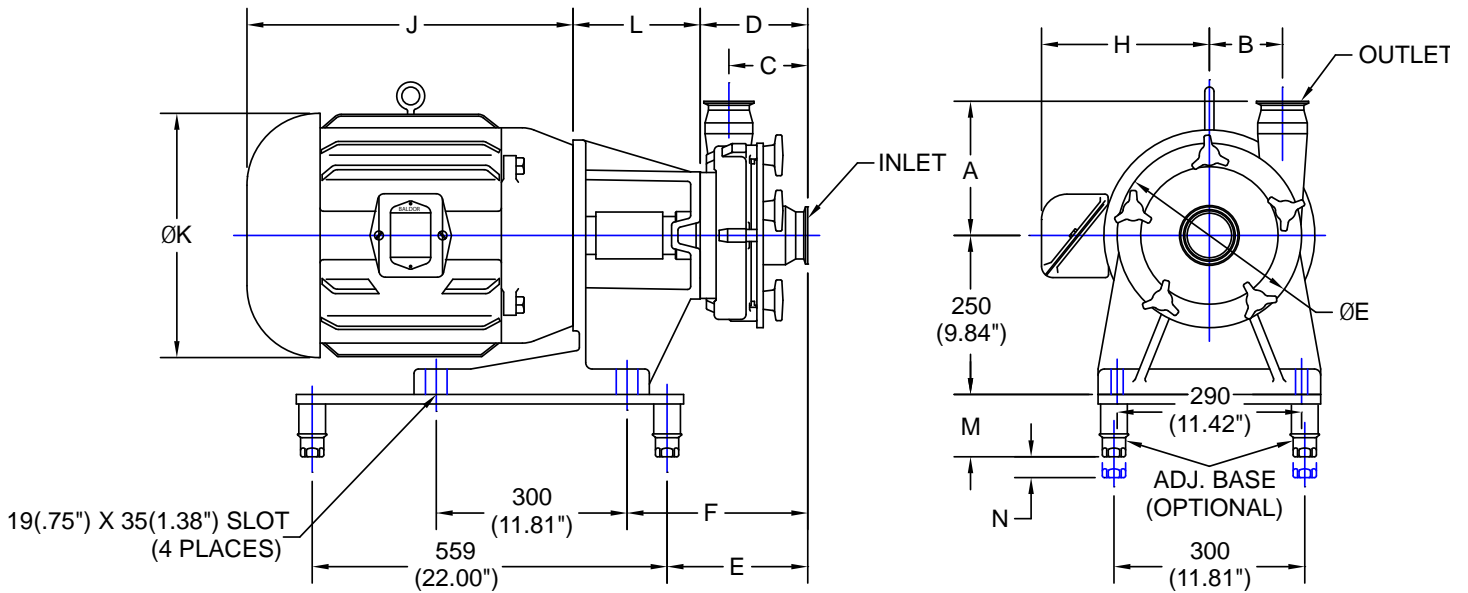

1265000386 REV-

PUMP MODEL	INLET	OUTLET	DIMENSIONS IN MILLIMETERS (INCHES)						
			A	B	C	D	E	F	ØG
FP 1051	4"	4"	250 (9.84")	170 (6.69")	167 (6.57")	202.5 (7.97")	254 (10.00")	317.5 (12.50")	406 (15.98")
FP 1151	4"	4"	250 (9.84")	170 (6.69")	110.5 (4.35")	146 (5.75")	197.5 (7.78")	261 (10.28")	406 (15.98")
FP 1161	4"	4"	250 (9.84")	170 (6.69")	110.5 (4.35")	146 (5.75")	197.5 (7.78")	261 (10.28")	406 (15.98")
FP 1161	6"	4"	250 (9.84")	170 (6.69")	111 (4.37")	146 (5.75")	197.5 (7.78")	261 (10.28")	406 (15.98")
FP 742	2.5"	2"	195 (7.68")	96 (3.78")	101 (3.98")	143.5 (5.65")	195 (7.68")	258.5 (10.18")	270 (10.63")
FP 1732 / 1742	2.5"	2"	200 (7.87")	91 (3.58")	104 (4.09")	153 (6.02")	204.5 (8.05")	268 (10.55")	270 (10.63")
FP 3532	2.5"	2"	191 (7.52")	95 (3.74")	115.5 (4.55")	164.5 (6.48")	216 (8.50")	279.5 (11.00")	260 (10.24")
FP 3542	3"	2.5"	211 (8.31")	115 (4.53")	118 (4.64")	164.5 (6.48")	216 (8.50")	279.5 (11.00")	290 (11.42")
FP 3452	3"	2"	211 (8.31")	140 (5.51")	114 (4.49")	160.5 (6.32")	212 (8.35")	275.5 (10.85")	350 (13.78")
FP 3551 / 3552	3"	2.5"	231 (9.09")	140 (5.51")	119 (4.68")	170.5 (6.71")	222 (8.74")	285.5 (11.24")	350 (13.78")

MOTOR HP	MOTOR FRAME	DIMENSIONS IN MILLIMETERS (INCHES)					
		H	J	ØK	L	M	N
1750 RPM	3500 RPM						
+3 HP	182TC	133 (5.23")	313 (12.31")	216 (8.50")	200 (7.87")	117 (4.62")	44.5 (1.75")
+5 HP	213TC	189 (7.46")	388 (15.27")	263 (10.34")	200 (7.87")	117 (4.62")	44.5 (1.75")
**7.5 HP	213TC	189 (7.46")	388 (15.27")	263 (10.34")	200 (7.87")	117 (4.62")	44.5 (1.75")
**10 HP	215TC	189 (7.46")	416 (16.40")	263 (10.34")	200 (7.87")	117 (4.62")	44.5 (1.75")
15 HP	254TC	220 (8.67")	415 (16.33")	263 (10.34")	200 (7.87")	98*** (3.88")	38**** (1.50")
20 HP	256TC	239 (9.42")	499 (19.66")	336 (13.25")	200 (7.87")	98*** (3.88")	38**** (1.50")
20 HP	256TC	225 (8.88")	491 (19.34")	263 (10.34")	200 (7.87")	98 (3.88")	38 (1.50")
25 HP	284TC	333 (13.12")	588 (23.13")	395 (15.56")	200 (7.87")	117 (4.62")	44.5 (1.75")
25 HP	284TSC	333 (13.12")	588 (23.13")	395 (15.56")	200 (7.87")	98 (3.88")	38 (1.50")
30 HP	286TC	333 (13.12")	588 (23.13")	395 (15.56")	200 (7.87")	117 (4.62")	44.5 (1.75")
30 HP	286TSC	333 (13.12")	588 (23.13")	395 (15.56")	200 (7.87")	98 (3.88")	38 (1.50")
40 HP	324TSD	333 (13.12")	588 (23.13")	395 (15.56")	220 (8.66")	117 (4.62")	44.5 (1.75")
40 HP	324TSD	333 (13.12")	588 (23.13")	395 (15.56")	220 (8.66")	117 (4.62")	44.5 (1.75")
50 HP	326TSD	333 (13.12")	588 (23.13")	395 (15.56")	220 (8.66")	117 (4.62")	44.5 (1.75")
50 HP	326TSD	333 (13.12")	588 (23.13")	395 (15.56")	220 (8.66")	117 (4.62")	44.5 (1.75")

* 3551 ONLY
 ** 3551, 1051 & 1151 ONLY
 *** 117 (4.62") FOR 1051, 1151 & 1161
 **** 44.5 (1.75") FOR 1051, 1151 & 1161

1265000387 REV-

FPX Single Flange Dimensional Drawing

All pump dimensions are in millimeters (inches). Dimensions are based on clamp fittings. Motor dimensions may vary by manufacturer.

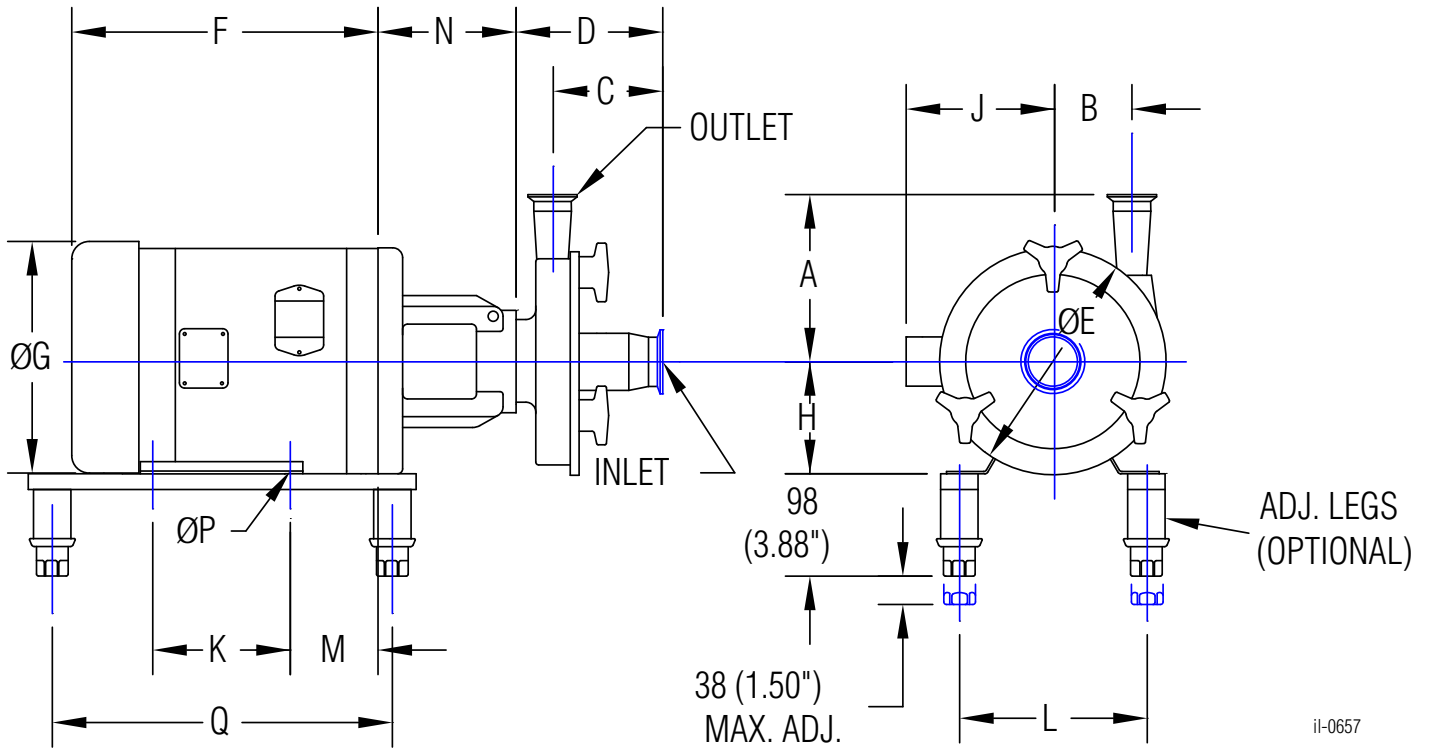

il-0657

PUMP MODEL	INLET	OUTLET	DIMENSIONS IN MILLIMETERS (INCHES)				
			A	B	C	D	ØE
FPX 701 / 702	1.5"	1.5"	108 (4.25)	44.5 (1.75)	108.5 (4.27)	146.5 (5.77)	150 (5.90)
FPX 711 / 712	2"	1.5"	144 (5.67)	58 (2.28)	113 (4.45)	150 (5.90)	185 (7.28)
FPX 721 / 731 / 722	2"	1.5"	170 (6.69)	79 (3.11)	113 (4.45)	150 (5.90)	230 (9.06)
FPX 741 / 732 / 742	2.5"	2"	195 (7.68)	96 (3.78)	101 (3.98)	141 (5.55)	270 (10.63)
FPX 1741 / 1732 / 1742	2.5"	2"	200 (7.87)	91 (3.58)	104 (4.09)	150.5 (5.93)	270 (10.63)
FPX 3521 / 3522	2.5"	2"	190 (7.48)	80 (3.15)	118 (4.64)	162 (6.38)	230 (9.06)
FPX 3531 / 3532	2.5"	2"	191 (7.52)	95 (3.74)	115.5 (4.55)	162 (6.38)	260 (10.24)
FPX 3541 / 3542	3"	2.5"	211 (8.31)	115 (4.53)	118 (4.64)	162 (6.38)	290 (11.42)
FPX 3451 / 3452	3"	2"	211 (8.31)	140 (5.51)	114 (4.49)	158 (6.22)	350 (13.78)
FPX 3551	3"	2.5"	231 (9.09)	140 (5.51)	119 (4.68)	168 (6.61)	350 (13.78)

MOTOR HP	MOTOR	FRAME	DIMENSIONS IN MILLIMETERS (INCHES)												
			F	ØG	H	J	K	L	M	N	ØP	Q			
1750 RPM	3500 RPM														
1 HP	1.5 HP	143TC	281 (11.06)	183 (7.19)	89 (3.50)	133 (5.22)	102 (4.00)	140 (5.50)	70 (2.75)	120 (4.72)	8.7 (11/32)	356 (14.00)			
1.5 HP		145TC	281 (11.06)	183 (7.19)	89 (3.50)	133 (5.22)	102 (4.00)	140 (5.50)	70 (2.75)	120 (4.72)	8.7 (11/32)	356 (14.00)			
2 HP	2 HP	145TC	281 (11.06)	183 (7.19)	89 (3.50)	133 (5.22)	102 (4.00)	140 (5.50)	70 (2.75)	120 (4.72)	8.7 (11/32)	356 (14.00)			
	3 HP	182TC	313 (12.31)	183 (7.19)	114 (4.50)	132 (5.21)	140 (5.50)	191 (7.50)	89 (3.50)	140 (5.53)	10.3 (13/32)	356 (14.00)			
3 HP		182TC	348 (13.69)	183 (7.19)	114 (4.50)	132 (5.21)	140 (5.50)	191 (7.50)	89 (3.50)	140 (5.53)	10.3 (13/32)	356 (14.00)			
	5 HP	184TC	347 (13.68)	216 (8.50)	114 (4.50)	152 (5.97)	140 (5.50)	191 (7.50)	89 (3.50)	140 (5.53)	10.3 (13/32)	356 (14.00)			
5 HP		184TC	386 (15.18)	216 (8.50)	114 (4.50)	152 (5.97)	140 (5.50)	191 (7.50)	89 (3.50)	140 (5.53)	10.3 (13/32)	356 (14.00)			
	7.5 HP	184TC	386 (15.18)	216 (8.50)	114 (4.50)	152 (5.97)	140 (5.50)	191 (7.50)	89 (3.50)	140 (5.53)	10.3 (13/32)	356 (14.00)			
7.5 HP		213TC	388 (15.27)	263 (10.34)	133 (5.25)	189 (7.46)	140 (5.50)	216 (8.50)	108 (4.25)	140 (5.53)	10.3 (13/32)	356 (14.00)			
10 HP	10 HP	215TC	388 (15.27)	263 (10.34)	133 (5.25)	189 (7.46)	140 (5.50)	216 (8.50)	108 (4.25)	140 (5.53)	10.3 (13/32)	356 (14.00)			
	15 HP	215TC	436 (17.15)	263 (10.34)	133 (5.25)	189 (7.46)	140 (5.50)	216 (8.50)	108 (4.25)	140 (5.53)	10.3 (13/32)	356 (14.00)			
15 HP		254TC	447 (17.59)	263 (10.34)	159 (6.25)	225 (8.88)	210 (8.25)	254 (10.00)	121 (4.75)	169 (6.65)	13.5 (17/32)	406 (16.00)			
	20 HP	256TC	491 (19.34)	263 (10.34)	159 (6.25)	225 (8.88)	254 (10.00)	254 (10.00)	121 (4.75)	169 (6.65)	13.5 (17/32)	406 (16.00)			
20 HP		256TC	499 (19.66)	336 (13.25)	159 (6.25)	239 (9.42)	254 (10.00)	254 (10.00)	121 (4.75)	169 (6.65)	13.5 (17/32)	406 (16.00)			

1265000540

FPX Double Flange Dimensional Drawing

All pump dimensions are in millimeters (inches). Dimensions are based on clamp fittings. Motor dimensions may vary by manufacturer.

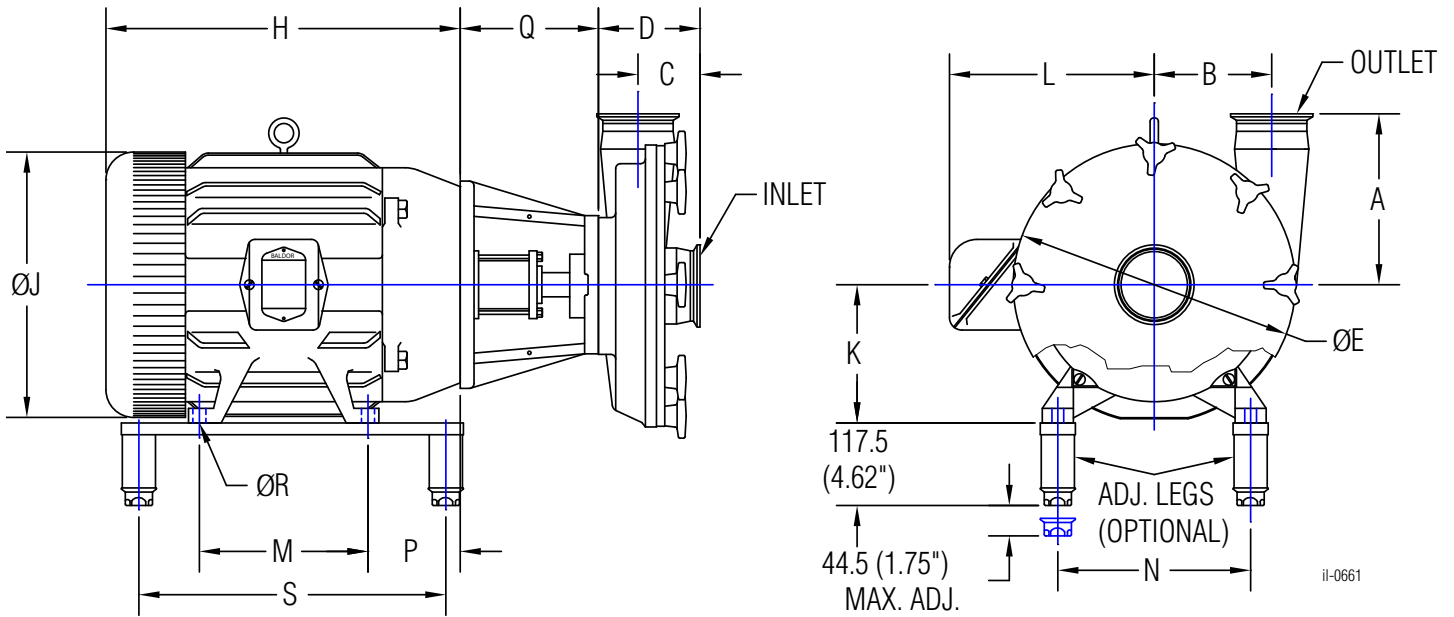

PUMP MODEL	INLET	OUTLET	DIMENSIONS IN MILLIMETERS (INCHES)				
			A	B	C	D	ØE
FPX 1051	4"	4"	250 (9.84")	170 (6.69")	167 (6.57")	202.5 (7.97")	406 (15.98")
FPX 1151	4"	4"	250 (9.84")	170 (6.69")	110.5 (4.35")	146 (5.75")	406 (15.98")
FPX 1161	4"	4"	250 (9.84")	170 (6.69")	110.5 (4.35")	146 (5.75")	406 (15.98")
FPX 1161	6"	4"	250 (9.84")	170 (6.69")	111 (4.37")	146 (5.75")	406 (15.98")
FPX 1742	2.5"	2"	200 (7.87")	91 (3.58")	104 (4.09")	153 (6.02")	270 (10.63")
FPX 3532	2.5"	2"	191 (7.52")	95 (3.74")	115.5 (4.55")	164.5 (6.48")	260 (10.24")
FPX 3542	3"	2.5"	211 (8.31")	115 (4.53")	118 (4.64")	164.5 (6.48")	290 (11.42")
FPX 3452	3"	2"	211 (8.31")	140 (5.51")	114 (4.49")	160.5 (6.32")	350 (13.78")
FPX 3552	3"	2.5"	231 (9.09")	140 (5.51")	119 (4.68")	170.5 (6.71")	350 (13.78")

MOTOR HP	MOTOR FRAME	DIMENSIONS IN MILLIMETERS (INCHES)											
		1750 RPM	3500 RPM	H	ØJ	K	L	M	N	P	Q	ØR	S
7.5 HP	213TC			388 (15.27")	263 (10.34")	133 (5.25")	189 (7.46")	140 (5.50")	216 (8.50")	108 (4.25")	200 (7.87")	10.3 (13/32")	470 (18.50")
10 HP	215TC			416 (16.40")	263 (10.34")	133 (5.25")	189 (7.46")	178 (7.00")	216 (8.50")	108 (4.25")	200 (7.87")	10.3 (13/32")	470 (18.50")
15 HP	254TC			447 (17.59")	270 (10.62")	159 (6.25")	226 (8.88")	210 (8.25")	254 (10.00")	121 (4.75")	200 (7.87")	13.5 (17/32")	444 (17.50")
20 HP	256TC			499 (19.66")	320 (12.60")	159 (6.25")	239 (9.42")	254 (10.00")	254 (10.00")	121 (4.75")	200 (7.87")	13.5 (17/32")	470 (18.50")
25 HP	284TC			588 (23.13")	367 (14.44")	178 (7.00")	333 (13.11")	241 (9.50")	279 (11.00")	121 (4.75")	200 (7.87")	13.5 (17/32")	444 (17.50")
	25 HP			588 (23.13")	367 (14.44")	178 (7.00")	333 (13.11")	241 (9.50")	279 (11.00")	121 (4.75")	200 (7.87")	13.5 (17/32")	444 (17.50")
30 HP	286TC			588 (23.13")	367 (14.44")	178 (7.00")	333 (13.11")	279 (11.00")	279 (11.00")	121 (4.75")	200 (7.87")	13.5 (17/32")	444 (17.50")
	30 HP			588 (23.13")	367 (14.44")	178 (7.00")	333 (13.11")	279 (11.00")	279 (11.00")	121 (4.75")	200 (7.87")	13.5 (17/32")	444 (17.50")
40 HP	324TC			636 (25.00")	413 (16.25")	203 (8.00")	371 (14.62")	267 (10.50")	318 (12.50")	133 (5.25")	216 (8.50")	16.7 (21/32")	470 (18.50")
	40 HP			636 (25.00")	413 (16.25")	203 (8.00")	371 (14.62")	267 (10.50")	318 (12.50")	133 (5.25")	216 (8.50")	16.7 (21/32")	470 (18.50")
50 HP	326TC			636 (25.00")	413 (16.25")	203 (8.00")	371 (14.62")	305 (12.00")	318 (12.50")	133 (5.25")	216 (8.50")	16.7 (21/32")	470 (18.50")
	50 HP			636 (25.00")	413 (16.25")	203 (8.00")	371 (14.62")	305 (12.00")	318 (12.50")	133 (5.25")	216 (8.50")	16.7 (21/32")	470 (18.50")

ii-0660

FPR Single Flange Dimensional Drawing

All pump dimensions are in millimeters (inches). Dimensions are based on clamp fittings. Motor dimensions may vary by manufacturer.

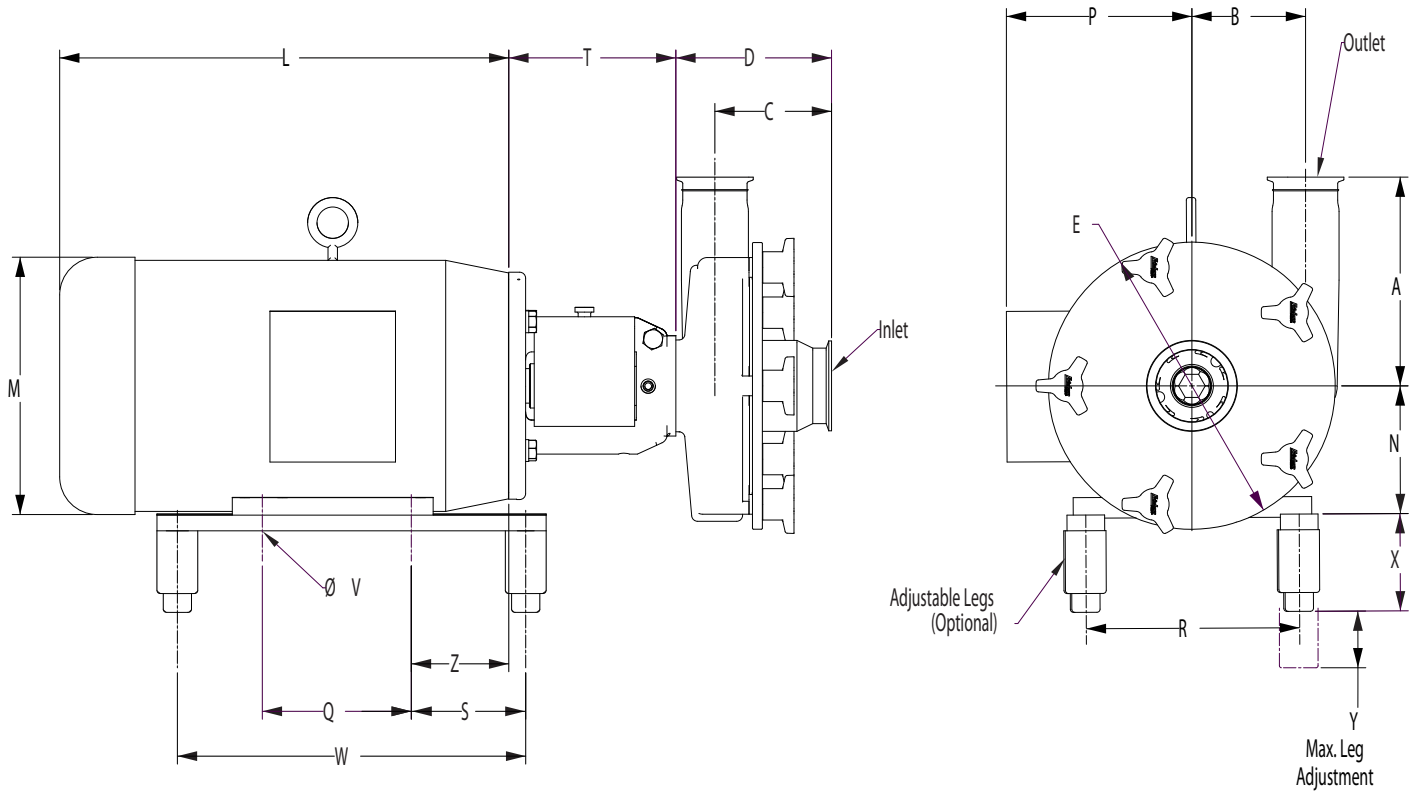

MOTOR HP		MOTOR FRAME	L	M	N	P	Q	R	S	T	V	W	X	Y	Z
1750 RPM	3500 RPM														
1 HP	1.5 HP	143TC	284 11.18"	175 6.89"	89 3.5"	133 5.25"	101.6 4"	140 5.5"	127 5"	120 4.72"	8.7 0.34"	356 14"	98 3.86"	38 1.5"	57.2 2.25"
1.5 HP		145TC	284 11.18"	175 6.89"	89 3.5"	133 5.25"	127 5"	140 5.5"	127 5"	120 4.72"	8.7 0.34"	356 14"	98 3.86"	38 1.5"	57.2 2.25"
2 HP	2 HP	145TC	284 11.18"	175 6.89"	89 3.5"	133 5.25"	127 5"	140 5.5"	127 5"	120 4.72"	8.7 0.34"	356 14"	98 3.86"	38 1.5"	57.2 2.25"
	3 HP	182TC	340 13.39"	221 8.7"	114 4.5"	149 5.87"	114 4.5"	191 7.5"	108 4.25"	169 6.65"	10.3 0.41"	356 14"	98 3.86"	38 1.5"	69.9 2.75"
3 HP		182TC	354 13.94"	221 8.7"	114 4.5"	149 5.87"	114 4.5"	191 7.5"	108 4.25"	169 6.65"	10.3 0.41"	356 14"	98 3.86"	38 1.5"	69.9 2.75"
	5 HP	184TC	354 13.94"	221 8.7"	114 4.5"	149 5.87"	140 5.5"	191 7.5"	108 4.25"	169 6.65"	10.3 0.41"	356 14"	98 3.86"	38 1.5"	69.9 2.75"
5 HP		184TC	354 13.94"	221 8.7"	114 4.5"	149 5.87"	140 5.5"	191 7.5"	108 4.25"	169 6.65"	10.3 0.41"	356 14"	98 3.86"	38 1.5"	69.9 2.75"
	7.5 HP	184TC	423 16.65"	221 8.7"	114 4.5"	149 5.87"	140 5.5"	191 7.5"	108 4.25"	169 6.65"	10.3 0.41"	356 14"	98 3.86"	38 1.5"	69.9 2.75"
7.5 HP		213TC	403 15.87"	260 10.25"	133 5.25"	187 7.38"	140 5.5"	216 8.5"	108 4.25"	169 6.65"	10.3 0.41"	356 14"	98 3.86"	38 1.5"	88.9 3.5"
	10 HP	215TC	403 15.87"	260 10.25"	133 5.25"	187 7.38"	178 7"	216 8.5"	108 4.25"	169 6.65"	10.3 0.41"	356 14"	98 3.86"	38 1.5"	88.9 3.5"
10 HP		215TC	416 16.38"	260 10.25"	133 5.25"	187 7.38"	178 7"	216 8.5"	108 4.25"	169 6.65"	10.3 0.41"	356 14"	98 3.86"	38 1.5"	88.9 3.5"
	15 HP	215TC	515 20.28"	260 10.25"	133 5.25"	187 7.38"	178 7"	216 8.5"	108 4.25"	169 6.65"	10.3 0.41"	356 14"	98 3.86"	38 1.5"	88.9 3.5"
15 HP		254TC	499 19.65"	327 12.87"	159 6.25"	244 9.63"	210 8.25"	254 10"	102 4"	169 6.65"	13.5 0.53"	406 16"	98 3.86"	38 1.5"	108.0 4.25"
	20 HP	256TC	499 19.65"	327 12.87"	159 6.25"	244 9.63"	254 10"	254 10"	102 4"	169 6.65"	13.5 0.53"	406 16"	98 3.86"	38 1.5"	108.0 4.25"
20 HP		256TC	499 19.65"	327 12.87"	159 6.25"	244 9.63"	254 10"	254 10"	102 4"	169 6.65"	13.5 0.53"	406 16"	98 3.86"	38 1.5"	108.0 4.25"
	25 HP	284TSC	588 23.15"	371 14.63"	178 7"	333 13.13"	241 9.5"	279 11"	121 4.75"	179 7.05"	13.5 0.53"	445 17.5"	118 4.63"	45 1.75"	120.7 4.75"
25 HP		284TC	588 23.15"	371 14.63"	178 7"	333 13.13"	241 9.5"	279 11"	121 4.75"	179 7.05"	13.5 0.53"	445 17.5"	118 4.63"	45 1.75"	120.7 4.75"
	30 HP	286TSC	588 23.15"	371 14.63"	178 7"	333 13.13"	279 11"	279 11"	121 4.75"	179 7.05"	13.5 0.53"	445 17.5"	118 4.63"	45 1.75"	120.7 4.75"
30 HP		286TC	588 23.15"	371 14.63"	178 7"	333 13.13"	279 11"	279 11"	121 4.75"	179 7.05"	13.5 0.53"	445 17.5"	118 4.63"	45 1.75"	120.7 4.75"
	40 HP	324TSC	636 25.04"	419 16.5"	203 8"	359 14.13"	267 10.5"	318 12.5"	121 4.75"	179 7.05"	16.7 0.66"	470 18.5"	118 4.63"	45 1.75"	133.4 5.25"
40 HP		324TC	636 25.04"	419 16.5"	203 8"	359 14.13"	267 10.5"	318 12.5"	121 4.75"	179 7.05"	16.7 0.66"	470 18.5"	118 4.63"	45 1.75"	133.4 5.25"
	50 HP	326TSC	636 25.04"	419 16.5"	203 8"	359 14.13"	305 12"	318 12.5"	121 4.75"	179 7.05"	16.7 0.66"	470 18.5"	118 4.63"	45 1.75"	133.4 5.25"
50 HP		326TC	636 25.04"	419 16.5"	203 8"	359 14.13"	305 12"	318 12.5"	121 4.75"	179 7.05"	16.7 0.66"	470 18.5"	118 4.63"	45 1.75"	133.4 5.25"

PUMP MODEL	INLET	OUTLET	A	B	C	D	E
FPR 701/702	1.5"	1.5"	108 4.25"	44.5 1.75"	106.5 4.19"	139.5 5.49"	150 5.91"
FPR 711/712	2"	1.5"	144 5.67"	58 2.28"	113 4.45"	145 5.71"	185 7.28"
FPR 721/731/722	2"	1.5"	170 6.69"	79 3.11"	113 4.45"	145 5.71"	230 9.06"
FPR 741/742	2.5"	2"	195 7.68"	96 3.78"	101 3.98"	136 5.35"	270 10.63"
FPR 1741/1742	2.5"	2"	200 7.87"	91 3.58"	104 4.09"	145.5 5.73"	270 10.63"
FPR 3521/3522	2.5"	2"	190 7.48"	80 3.15"	118 4.65"	157.5 6.2"	230 9.06"
FPR 3531/3532	2.5"	2"	191 7.52"	95 3.74"	115.5 4.55"	157.5 6.2"	260 10.24"
FPR 3541/3542	3"	2.5"	211 8.31"	115 4.53"	118 4.65"	157.5 6.2"	290 11.42"

1265000463

FPR Double Flange Dimensional Drawing

All pump dimensions are in millimeters (inches). Dimensions are based on clamp fittings. Motor dimensions may vary by manufacturer.

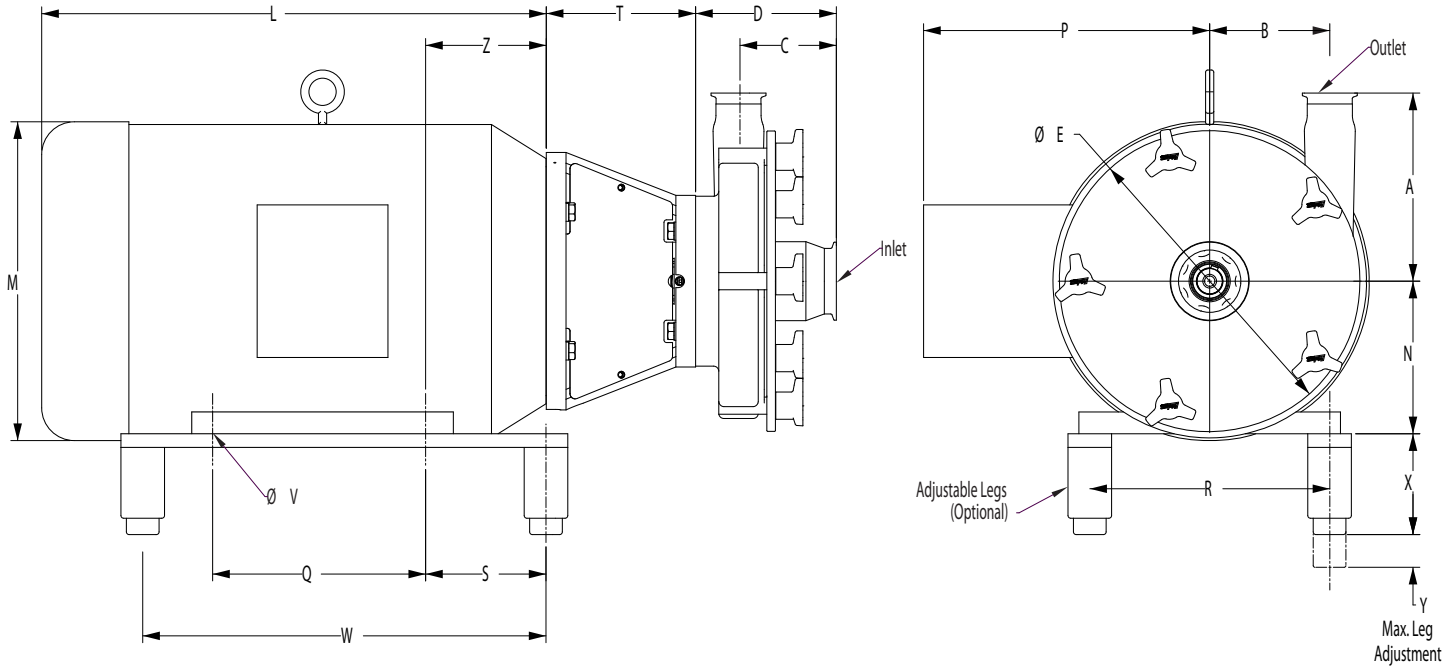

1265000203 Rev C

MOTOR HP		MOTOR FRAME	L	M	N	P	Q	R	S	T	V	W	X	Y	Z
1750 RPM	3500 RPM														
3 HP	182TC	313	221	114	149	114	191	108	160	10.3	356	98	38	69.9	
	182TC	12.32"	8.7"	4.5"	5.87"	4.5"	7.5"	4.25"	6.3"	0.41"	14"	3.86"	1.5"	2.75"	
5 HP	184TC	348	221	114	149	114	191	108	160	10.3	356	98	38	69.9	
	184TC	13.7"	8.7"	4.5"	5.87"	4.5"	7.5"	4.25"	6.3"	0.41"	14"	3.86"	1.5"	2.75"	
7.5 HP	184TC	347	221	114	149	140	191	108	160	10.3	356	98	38	69.9	
	184TC	13.66"	8.7"	4.5"	5.87"	5.5"	7.5"	4.25"	6.3"	0.41"	14"	3.86"	1.5"	2.75"	
10 HP	213TC	386	221	114	149	140	191	108	160	10.3	356	98	38	69.9	
	213TC	15.28"	8.7"	4.5"	5.87"	5.5"	7.5"	4.25"	6.3"	0.41"	14"	3.86"	1.5"	2.75"	
15 HP	215TC	388	260	133	187	178	216	108	160	10.3	356	98	38	88.9	
	215TC	15.28"	10.25"	5.25"	7.38"	7"	8.5"	4.25"	6.3"	0.41"	14"	3.86"	1.5"	3.5"	
20 HP	254TC	436	260	133	187	178	216	108	160	10.3	356	98	38	88.9	
	254TC	17.17"	10.25"	5.25"	7.38"	7"	8.5"	4.25"	6.3"	0.41"	14"	3.86"	1.5"	3.5"	
25 HP	256TC	447	327	159	244	210	254	102	160	13.5	406	98	38	108	
	256TC	17.6"	12.87"	6.25"	9.63"	8.25"	10"	4"	6.3"	0.53"	16"	3.86"	1.5"	4.25"	
30 HP	284TC	491	327	159	244	254	254	102	160	13.5	406	98	38	108	
	284TC	19.33"	12.87"	6.25"	9.63"	10"	10"	4"	6.3"	0.53"	16"	3.86"	1.5"	4.25"	
40 HP	284TSC	499	327	159	244	254	254	102	160	13.5	406	98	38	108	
	284TSC	19.65"	12.87"	6.25"	9.63"	10"	10"	4"	6.3"	0.53"	16"	3.86"	1.5"	4.25"	
50 HP	286TC	588	371	178	333	241	279	121	174	13.5	445	118	45	121	
	286TC	23.15"	14.63"	7"	13.13"	9.5"	11"	4.75"	6.85"	0.53"	17.5"	4.63"	1.75"	4.75"	
60 HP	324TC	588	371	178	333	241	279	121	174	13.5	445	118	45	121	
	324TC	23.15"	14.63"	7"	13.13"	9.5"	11"	4.75"	6.85"	0.53"	17.5"	4.63"	1.75"	4.75"	
75 HP	364TC	588	371	178	333	279	279	121	174	13.5	445	118	45	121	
	364TC	23.15"	14.63"	7"	13.13"	11"	11"	4.75"	6.85"	0.53"	17.5"	4.63"	1.75"	4.75"	
100 HP	364TSC	636	419	203	359	267	318	121	209	16.7	470	118	45	133	
	364TSC	25.04"	16.5"	8"	14.13"	10.5"	12.5"	4.75"	8.23"	0.66"	18.5"	4.63"	1.75"	5.25"	
125 HP	365TC	636	419	203	359	305	318	121	209	16.7	470	118	45	133	
	365TC	25.04"	16.5"	8"	14.13"	12"	12.5"	4.75"	8.23"	0.66"	18.5"	4.63"	1.75"	5.25"	
150 HP	364TSC	685	470	229	383	286	356	89	209	16.7	508	127	45	149	
	364TSC	26.97"	18.5"	9"	15.06"	11.25"	14"	3.5"	8.23"	0.66"	20"	5"	1.75"	5.87"	
200 HP	365TSC	685	470	229	383	311	356	89	209	16.7	508	127	45	149	
	365TSC	26.97"	18.5"	9"	15.06"	12.25"	14"	3.5"	8.23"	0.66"	20"	5"	1.75"	5.87"	

PUMP MODEL	INLET	OUTLET	A	B	C	D	E
FPR 751/752	3"	2"	205	145	99	142	379
			8.07"	5.71"	3.9"	5.59"	14.92"
FPR 3451/3452	3"	2"	211	140	114	160.5	350
			8.31"	5.51"	4.49"	6.32"	13.78"
FPR 3551/3552	3"	2.5"	230	140	119	170	350
			9.06"	5.51"	4.69"	6.69"	13.78"
FPR 1051	4"	4"	250	170	167	202.5	406
			9.84"	6.69"	6.57"	7.97"	15.98"
FPR 1161	4"	4"	250	170	110.5	146	406
			9.84"	6.69"	4.35"	5.75"	15.98"

1265000463

FPR Double Flange Dimensional Drawing Model 4001

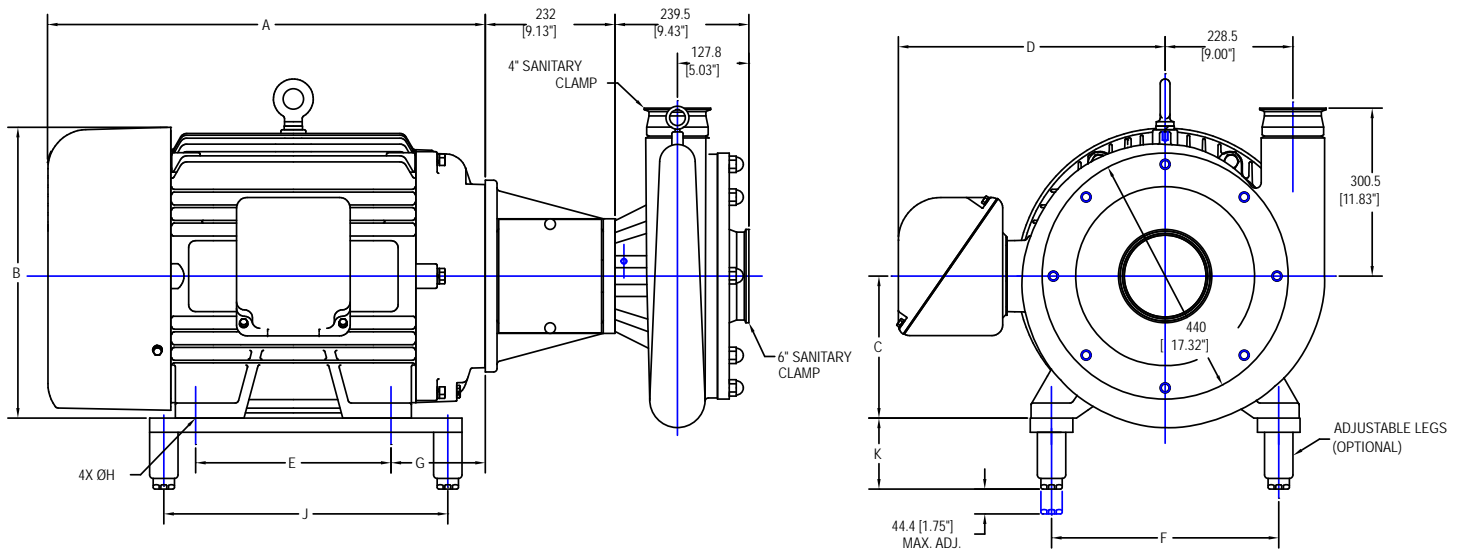

1265000053
8/19/02

MOTOR HP	MOTOR FRAME	A	B	C	D	E	F	G	ØH	J	K
40 HP	324TC	636 25"	418 16.5"	203 8"	371 14.6"	267 10.5"	317 12.5"	133 5.2"	16.7 0.7"	470 18.5"	117 4.6"
50 HP	326TC	636 25"	418 16.5"	203 8"	371 14.6"	305 12"	317 12.5"	133 5.2"	16.7 0.7"	470 18.5"	117 4.6"
60 HP	364TC	684 26.9"	470 18.5"	229 9"	380 15"	286 11.3"	355 14"	149 5.9"	16.7 0.7"	508 20"	127 5"
75 HP	365TC	684 26.9"	470 18.5"	229 9"	380 15"	311 12.2"	355 14"	149 5.9"	16.7 0.7"	508 20"	127 5"
100 HP	405TC	782 30.8"	520 20.5"	254 10"	477 18.8"	349 13.7"	406 16"	168 6.6"	20.6 0.8"	508 20"	127 5"

1265000054
1/28/2008



CENTRIFUGAL



POSITIVE DISPLACEMENT



MIXING & BLENDING