

Behaviour of Foundations and Structures

Comportement des Fondations et des Structures

J.B. BURLAND Head Geotechnics Div., Building Research Establishment, Garston, Herts, U.K.
B.B. BROMS Prof. of Soil and Rock Mech., Royal Institute of Technology, Stockholm, Sweden
V.F.B. DE MELLO Prof. of Soil Mech. and Found. Eng., Univ. of São Paulo, Brazil

INTRODUCTION

The title chosen for Session II embraces a vast range of topics and specialities and it has been necessary to restrict severely the scope of this Review. Although parts of the Review are applicable to a wide range of structures the General Reporter and his collaborators have decided to concentrate attention on the settlement of buildings and structures (ie silos, bridges and power stations, etc). Even within this restricted field the Authors are only too conscious of the very narrow coverage that they have given to the subject. For example, it has not been possible to discuss deep basements. Every effort has been made to cover recent advances in soil mechanics, but always with a view to aiding design decisions. The Review is aimed at practising engineers but a conscious effort has been made to avoid offering simple 'rules' as these often inhibit continued development whereas our aim is to encourage it.

CHAPTER 1 - PREAMBLE

1.1 ROUTINE FOUNDATION DESIGN

For a start we should note that a fairly high percentage of foundations are specified strictly on the basis of local routines or regulations in which the soil mechanics expert does not intervene. Moreover, the vast majority of these designs are sufficiently successful not to call for the specialist's advice on remedial measures. Although local practice often results in considerably over-designed foundations, there are also numerous cases where the 'educated guess' based on routine 'index' tests is likely to have at least the same certainty of success, in terms of economy and performance, as a more formal design based on quantitative soil testing and analysis. This all points to the fact that testing and computation form only one aspect of foundation design.

A close study of local practice or experience provides direct evidence of what can be achieved and sometimes of what cannot. To the experienced engineer the information can be of more direct value in design than accurately determined soil parameters

* The subject was covered at the Sixth European Conference on SM&FE, Vienna (1976) and the Institution of Structural Engineers, London (1975) have issued a comprehensive report on the Design and Construction of Deep Basements.

since it carries with it so many facets of the behaviour of the ground and structure which can never be calculated. More valuable still is local experience based on quantitative observations of performance. These offer the prospect of 'back analysis' followed by 'calibration' of the ground and the methods used in exploring it. The value of regional or local studies of this type will be discussed in Chapter 6. When properly interpreted they offer the best prospect of good routine design procedures.

We must now look at the limitations of this approach. The principal body of experience arises from box-like structures, of base to height ratio from one half to three, with regularly distributed columns so that column loadings vary by no more than approximately one half to twice the average. The dead load is applied slowly before the sensitive finishes. The real live loading is usually only 15 to 30 per cent of the dead load and is applied relatively slowly. The degree of empiricism in our foundation practices is immediately exposed when one examines under what conditions problems have arisen. Frequently they involve a significant departure from routine conditions of loading or type of structure (leaving aside unexpected ground conditions). Sometimes the problem arises because of a blank unawareness of the importance of the changed condition. However, there is a sufficient number of examples of problems where there was such an awareness to underline our inability to extrapolate too far from the limited universe of satisfactory routine experience.

In routine foundation design the actual loads are often significantly less than the design loads (because of codes and obvious limit analysis requirements). Thus it will be understood why foundation problems seem to be most frequently associated with tanks, silos and industrial units, all of which involve very high ratios of live to dead loads. In these cases the live loads reach their design values, are frequently applied rapidly and usually as 'soft loads' with no possibility of redistribution or attenuation as differential deformations develop. The difficulty of estimating settlements is emphasised by the fact that the majority of problems arise from buildings with greatly differentiated column loadings, or tall buildings which tilt excessively (eg Leonhardt 1973).

It is therefore necessary to caution the general practitioner against the expectation that routine prescriptions can be satisfactorily applied to unusual structures and conditions of loading. Predicted

settlements may be so significantly in error that damage may occur.

1.2 SITE INVESTIGATION

The prime requirement for successful foundation design is and always will be a good site investigation carried out with a knowledge of the requirements of the proposed structure. This entails:

(1) A knowledge of the soil profile and ground water conditions across the site set in the context of the local geology and tied in with local experience (eg Ohsaki and Sakaguchi, 1973; Johansson, 1970). This can usually only be achieved by visiting the site.

(2) A detailed and systematic description of the soil in each stratum in terms of its visual and tactile properties. This should preferably be coupled with routine in-situ indicator tests, such as the Standard Penetration Test (SPT) and the Static Cone Resistance (SCR), for ease of correlation with local experience and practice. Because of the empirical nature of the tests it is important that they are carried out in a standard manner and it is essential to calibrate the results against known ground conditions.

(3) An estimate or determination of the mechanical properties of the relevant strata.

Where appropriate, trial pits or shafts should be excavated and the soil examined and systematically described in-situ. If sampling is carried out every sample, whether it is tested or not, should be examined and described. Jennings et al (1973) have given valuable guidelines for routine soil description. The British Standards Institution have recently issued a draft revised standard Code of Practice for Site Investigations in which detailed guidance is given on the description of soils and rocks. Rowe (1972) has emphasised the importance of soil fabric in controlling its mass properties and outlines methods of recording it. A valuable manual on subsurface investigations has been published by the ASCE (Seviger, 1972) and reference should be made to the subsequent discussion.

Much effort has gone into attempting to establish correlations between the results of SPT and SCR tests and fundamental soil parameters and even soil types. This Review is hardly the place to discuss these matters which have been treated in depth by many authors (eg de Mello, 1971; Sanglerat, 1972; and at the European Symposium on Penetration Testing, Stockholm, 1974). However, two comments are perhaps in order. Firstly, the practising engineer should always use parameters derived in this manner with the greatest caution, bearing in mind the multiple correlations and wide scatter of results often involved. Secondly, there can be no doubt that the results of these and other in-situ indicator tests, when used in the context of well established local experience and proven ground conditions, have proved immensely successful - for example in Brazil (de Mello, 1971, 1975a).

It is probably not overstating the case to say that in 95 cases out of 100 the decisions as to the type and depth of foundations can be made primarily on the basis of (1) and (2) above. Moreover, the planning

of construction procedures depends heavily on this information. Of course, in most situations it is prudent to carry out tests and calculations to confirm the decision. Alternatively in his search for an economic solution the engineer will resort to detailed analysis to help him choose between various schemes.

No amount of laboratory testing or sophisticated calculations can compensate for a lack of knowledge about the soil profile. Yet, there is an increasing tendency to design on the basis of numbers contained in soil investigation reports in the mistaken belief that these are a faithful representation of the properties of the ground. There is no doubt that a sound understanding of the factors influencing the mechanical properties of the ground is essential. However, these must be coupled with an awareness of the limitations of theories and testing techniques based on experience in the field and an intimate knowledge of the conditions on a given site. Peck (1974) in the Second Nabor Carrillo Lecture outlines a number of case histories which underline the above remarks in a most instructive and challenging manner.

1.3 DEFORMATION PROPERTIES OF THE SOIL

The detailed properties of the ground and their determination is dealt with in Session I of the Conference. Our concern here is mainly with the reliability of such determinations and their application in analysis and design of foundations. It is very doubtful whether there have been significant changes in routine laboratory testing procedures in the last eight years, although the use of special testing methods (eg stress-path methods) are becoming more widespread.

What is becoming clearer is that the application of traditional undisturbed sampling and laboratory testing techniques is limited both in accuracy and in the range of types of ground that can be studied. The difficulty of accurate prediction on the basis of laboratory tests have been emphasised by Peck (1965), de Mello (1972), Lambe (1973), Burland (1973) and many others. One only has to examine a few exposures in materials such as residual soils, stiff fissured clays, tills, highly laminated mudstones or lacustrine deposits etc to appreciate the limited range of materials for which the mass in-situ deformation and consolidation properties can be realistically determined in the laboratory. The act of sampling such materials often so totally alters their structure and consistency that even a visual description can be grossly misleading. In certain circumstances the problems can be partially overcome by testing much larger samples (Rowe, 1972; Hansbo and Torstensson, 1971). In other cases resort to large in-situ tests (Burland and Lord, 1969; Marsland, 1971) or back analysis of existing structures is the only alternative if reasonably representative deformation parameters are required (Ward and Burland, 1973; Breth and Amann, 1974).

Even where undisturbed sampling and laboratory testing procedures are appropriate one has to question the accuracies of prediction that have sometimes been claimed. The methods are moderately expensive and time consuming so that usually insufficient tests are performed to permit adequate statistical treatment. Moreover, when one considers the precision which is required to predict the compression of a 5 m thick

compressible layer (say), and takes into account the difficulties of sampling, testing and inherent heterogeneity, the chances of the error being consistently less than 20 mm seem unrealistic. There is, therefore, a great need for a proper statistical and probabilistic treatment of test results coupled with objective comparisons with field measurements preferably on the basis of Class A predictions (Lambe, 1973).

One detects a feeling amongst many soil mechanics experts and academicians that it is necessary to convey to the structural engineer and client the same degree of apparent analytical precision which underlies much structural design (Burland, 1975). Such precision in structural engineering is usually more apparent than real (Peck, 1965; Golder, 1971). Moreover, it would probably be doing a service to the civil engineering profession if foundation engineers made a point of assessing objectively the bounds and confidence limits of their predictions without feelings of guilt or inferiority. They have, after all, to deal with by far the most complex and variable material composing the total structure and they have usually had no 'say' in its specification, manufacture or placement! Indeed such an attitude may do much to improve the total design of buildings and structures in terms of serviceability.

1.4 BEARING CAPACITY AND ALLOWABLE PRESSURES

Very few additional bearing capacity formulae have been published over the last few years. This may be interpreted as a wider recognition and demonstration that failure considerations are seldom the conditioning ones - particularly as loads and foundation areas get larger. It is only for a limited range of intermediate plasticity soil (de Mello, 1969) or hard brittle materials that bearing failure is likely to be the conditioning factor. At the extreme of cohesionless sands the very high stress required for bearing failure shifts the limiting condition to settlement (Peck, 1973) and at the extreme of higher plasticity soils the problems of large settlements are obviously conditioning.

The situation is rather different for many pile foundations where, because the loads are transmitted in shear to the soil and/or in bearing over a relatively small area the settlements approaching ultimate load are often quite small. This also applies to footings on brittle fissured materials. It is, of course, always necessary to exercise care in the classic situation in which footings or piles are founded in a stiff layer overlying a weak layer (Meyerhof, 1974b; Mitchell et al, 1972).

Golder (1969) has pointed out that from a strictly practical point of view enough is known to avoid bearing capacity failures for 'average' buildings on 'average' soils. It is probably true to say that the biggest problem confronting the practitioner is in the determination of the appropriate strength parameters. This problem becomes critical when considering structures operating at low factors of safety such as embankments and tanks on poor ground and which are outside the scope of the Report. However, as noted previously, particular care should be exercised for structures with high live-to-dead ratios (silos, bridges, water towers, etc), since it is around these that bearing capacity failures have concentrated in the past.

The difficulty of selecting appropriate strength parameters arises in part from the problem of testing a representative volume of soil. However, it is also due to the fact that recent theoretical and experimental studies have drawn attention to the importance of pre- and post-peak stress-strain behaviour in determining the collapse condition (eg Hoeg, 1972). It is natural therefore that we should expect a pause while workers switch their attention from the classic, highly idealised rigid-plastic limit equilibrium studies of stability to the more realistic, but much more difficult study of the influence of deformation on collapse. A number of recent symposia on the topic attest to the rapid developments taking place in this subject (Palmer, 1973; Valliappan et al, 1975; Desai, 1976).

Finally, it is important to emphasise that although settlement is usually the conditioning factor in the choice of foundation the detailed analysis of the magnitude and distribution of settlement is difficult and unreliable. Hence the preliminary sizing of individual footings and piers is best carried out using a simple approach such as a fixed allowable pressure (q_a), constant factor of safety (q_{ult}/q), or 'equal settlement' (Q/D) - see Burland and Wroth (1974, section 13) and Poulos (1974). A detailed analysis may then be carried out to check the distribution of settlements and if necessary adjust the sizes in critical areas.

1.5 THE BEHAVIOUR OF FOUNDATIONS AND STRUCTURES - A CHALLENGE

We have seen that in routine work the practitioner is not unduly concerned with the difficulties of estimating settlements and deformations provided he has satisfied himself that the ground conditions are in accordance with local experience. Homogeneity within a given stratum is usually much better than tests and numbers would indicate because deformations are, fortunately, dependent on the statistics of averages. Hence within a given foundation the behaviour is usually surprisingly reproducible and often permits a significant transfer of experience from one site to another. Moreover, as regards acceptable performance, the practitioner can normally ensure, on the basis of past experience, that undesirable damage will not occur. This is technically and statistically a much easier task than predicting what will occur (de Mello, 1975b).

It is when unusual or unique problems arise that the present inadequacies of soil mechanics are brought to light. Put in simple terms, present techniques do not allow the engineer to estimate, with the degree of certainty which present rules often demand, how much a building or structure will settle and what the distortion will be. Equally, neither the architect nor the structural engineer is able to predict with any greater degree of certainty how much distortion can be tolerated without unacceptable damage. Under these circumstances conservatism is both inevitable and prudent. It should be noted that it is easier to achieve agreement between predicted and observed settlements when both tend to zero.

Soil mechanics and foundation engineering must therefore face up to some important challenges:

- (1), The clear, concise and systematic description of the soil profile in terms of its visual and tactile

properties (including structure and fabric) must be given greater emphasis in teaching and in practice. How many new civil engineering graduates can adequately describe a soil profile?

(2) The reliable determination of the properties of many types of ground demands the development of accurate in-situ testing devices which must be robust and easy to use if they are to find widespread application.

(3) Whatever the method of test the successful application of test results urgently requires greater use of statistics and probability methods if the accuracies of the methods are to be assessed and objective confidence limits are to be placed on predictions.

(4) Successful and economic design and construction can only result if the building, including its foundations, structure and finishes, is treated as a whole. This requires a knowledge of the total behaviour of buildings and a realistic appraisal of accuracies that can be achieved in design and construction. The foundation engineer has an important role to play and may, indeed, have to force the issue by confronting the parties involved with the economic consequences of 'design in watertight compartments'. A fragmented approach to design usually leads to an uneconomic structure and is frequently a major contributing factor to failure (Techebotarioff, 1973 - page 17).

(5) Finally, progress in design and construction techniques and the accumulation of experience depends on the objective assessment of results. This requires frequent careful monitoring of the behaviour of foundations and structures - a subject which will be discussed in more detail in Chapter 6.

CHAPTER 2 - SERVICEABILITY, DAMAGE AND LIMITING SETTLEMENT

Compared with the literature on the prediction of foundation movements, the influence of such movements on the function and serviceability of structures and buildings has received little attention. Yet major and costly decisions are frequently taken on the design of the foundations purely on the basis of rather arbitrary limiting total and differential settlements. This Chapter is primarily concerned with serviceability, movements and damage of buildings. In the final Section empirical guides on limiting settlements are discussed. The analysis of differential settlements, taking account of soil-structure interaction, is dealt with in Chapter 5.

2.1 SERVICEABILITY

As pointed out by Burland and Wroth (1974) the problem of limiting settlements and soil-structure interaction is a part of the much wider problem of serviceability and structural interaction. Little progress has been made on this global problem for a number of reasons. Some of these are:

(1) Serviceability is very subjective and depends both on the function of the building, the reaction of the user and owner and economic factors such as value, insurance cover, and the importance of prime cost.

(2) Buildings vary one from another in such features as purpose, structural form, building materials, construction details and finishes.

(3) Buildings, including foundations, seldom perform as designed because of the many simplifying assumptions that have to be made regarding the properties of the ground and the total structure (see Section 5.1).

As well as depending on loading and settlement, deformation results from such factors as creep, shrinkage, temperature change and moisture change. A Conference on Design for Movement in Buildings* (1969) quotes many cases of damage which result from movements other than those of the foundations. It is clear that engineers are in no better position to estimate such movements than they are for calculating settlements (Budgen, 1969).

Another aspect of the problem which engineers may overlook is that a certain amount of cracking is often unavoidable if the building is to be economic (Peck, Deere and Capacete, 1956). Little (1969) has estimated that in the case of one particular type of building the cost of preventing cracking by limiting movements in the structure and foundations could easily exceed 10 per cent of the total building cost, i.e. more than the costs of the foundations themselves in many cases. It is interesting that in the Conference mentioned above, numerous examples are quoted of simple design and construction expedients which permit the accommodation of movement without damage. The majority of these are relatively inexpensive and it is probable that significant overall economies could be achieved, as well as improved serviceability, if buildings were designed with the accommodation of movement in mind. This approach also has the advantage that it avoids the problem of precisely estimating the magnitudes of movement.

An outstanding example of the benefits that can accrue when the foundation engineer, structural engineer and architect combine is the British CLASP system of industrialised building which was evolved to cope with mining subsidence (Lacey and Swain, 1957; Ward, 1974). The intriguing feature of the CLASP system, which is now widely used throughout Britain and Europe, is that it is no more expensive than traditional building methods on stable ground. Another useful example of such cooperation is cited by Cowley et al (1974) in which structural flexibility was simply and successfully incorporated in the structure of some cold stores thereby eliminating expensive piled foundations.

The foundation engineer has a responsibility to provide an economic foundation which will ensure that the structure fulfils its function. In doing so he must not only understand the properties of the ground but he also needs to know how the building will respond to deformation and what the consequences of such deformation will be to its function. There are signs that the problem of serviceability is receiving increasing attention (eg draft ISO 4356:1976) and the foundation engineer has an important role to play. Previous work has often suffered from a lack of clear definitions and because these are felt to be essential to future development some space is devoted to the definitions of ground movement and classification of damage.

* Design for Movement in Buildings - Concrete Society, London (1969).

2.2 DEFINITIONS OF GROUND AND FOUNDATION MOVEMENT

A study of the literature reveals a wide variety of confusing symbols and terminology describing foundation movements. Burland and Wroth (1974) proposed a consistent set of definitions based on the known (or predicted) displacements of a number of discrete points. Care was taken to ensure that the terms do not prejudice any conclusions about the distortions of the building itself since these depend on a large number of additional factors such as size, details of construction, materials, time, etc. The proposed terms are illustrated in Fig 1 for the settlement of a number of discrete points on a foundation. The details of the foundation and superstructure are deliberately not specified so as to emphasise the extent to which judgement and a knowledge of the structure is needed in interpreting settlement observations or predictions. The terms are defined in detail by Burland and Wroth (1974) and will only be discussed briefly here:

(i) Settlement ρ and differential or relative settlement $\delta\rho$ are illustrated in Fig 1(a). Upward movement is termed heave and denoted by ρ_h .

(ii) Rotation θ is the change in gradient of a line joining two reference points (eg AB in Fig 1(a)).

(iii) Angular strain is denoted by α . The angular strain at B is given by:

$$\alpha_B = \frac{\delta\rho_{BA}}{L_{AB}} + \frac{\delta\rho_{BC}}{L_{BC}}$$

It is positive if it produces 'sag' or upward concavity and negative if it produces 'hog' or downward concavity. Angular strain is particularly useful for predicting crack widths in buildings in which movement occurs at existing cracks or lines of weakness.

(iv) Relative deflection (relative sag or relative hog) Δ is the displacement relative to the line connecting two reference points a distance L apart (see Fig 1(b)). The sign convention is the same as in (iii).

(v) Deflection ratio (sagging ratio or hogging ratio) is denoted by Δ/L . When a smooth profile is drawn between a number of reference points considerable judgement is often needed in estimating the maximum value of Δ/L . It should be noted that when the deformed profile is approximately circular the curvature is given by $8\Delta/L^2$.

(vi) Tilt is denoted by ω and describes the rigid body rotation of the structure or a well defined part of it. Figure 1(c) shows how the tilt might be estimated if the points were located on a raft foundation. This might be quite inappropriate for a frame building on separate footings.

(vii) Relative rotation (angular distortion) β is the rotation of the line joining two reference points relative to the tilt (see Fig 1(c)). The term 'angular distortion' was defined by Skempton and MacDonald and is now widely used. However, its use implies shear distortion within the building and while this may be the case for frame buildings it is not necessarily the case for structures in general. For this reason the term 'relative rotation' is preferred

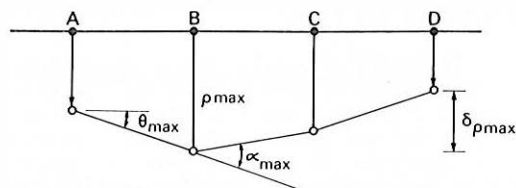

(a) Definitions of settlement ρ , relative settlement $\delta\rho$, rotation θ and angular strain α

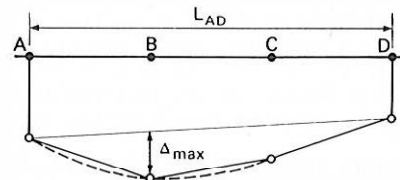

(b) Definitions of relative deflection Δ and deflection ratio Δ/L

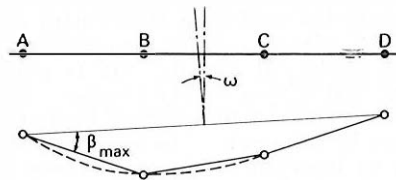

(c) Definitions of tilt ω and relative rotation (angular distortion) β

Fig 1 Definitions of foundation movement.

although 'angular distortion' might be retained for known cases of shear distortion. If a smooth profile is drawn between the reference points in Fig 1(c) the maximum relative rotation will be larger than indicated.

(viii) Horizontal displacement u can be of importance. A change of length δL over a length L gives rise to an average strain $\epsilon = \delta L/L$.

The above definitions only apply to 'in plane' deformation and no attempt has been made to define three-dimensional behaviour.

2.3 LIMITING MOVEMENTS AND DAMAGE

Golder (1971) posed a number of very important questions on limiting settlement, the most important perhaps being who does the limiting: The building code? The architect? The structural engineer? The foundation engineer? The client, owner or occupier? The insurance assessor or financing organisation? Zeevaert (1973) discusses the role of these parties and the engineer would do well to ponder them when settlement is an important consideration in foundation design.

There are basically three criteria which have to be satisfied when considering limiting movements: (i) visual appearance; (ii) serviceability or function; and (iii) stability. Skempton and MacDonald (1956) concluded that for the majority of buildings the allowable settlement is governed more by

architectural damage than by overstressing of the structure and in this Review we are concerned primarily with (i) and (ii).

2.3.1 Movements affecting visual appearance:

Visible deviation of members from the vertical or horizontal will often cause subjective feelings that are unpleasant and possibly alarming. Persons vary in their appraisal of relative movement and are often guided by neighbouring or adjacent buildings or members. There seems to be wide acceptance that general deviations from the vertical or horizontal in excess of about 1/250 are likely to be noticed. For horizontal members it is suggested that a local slope exceeding 1/100 would be clearly visible as would a deflection ratio Δ/L of more than about 1/250. Whether such movements become limiting depends on the function of the building (see Moretto, 1971).

2.3.2 Visible damage: As mentioned previously damage is difficult to quantify as it depends on subjective criteria. Moreover, damage which is acceptable in one region or one type of building might be quite unacceptable in another. Nevertheless, if progress is to be made in assessing limiting foundation movements and designing to criteria of serviceability it is necessary to develop some system for classifying degrees of damage. It is probable that if a simple system were widely adopted some of the more extreme reactions towards any form of visible damage might be assuaged. Jennings and Kerrich (1962), in an important study of the economic consequences of the heave of buildings on swelling clays, devised a simple classification of damage related principally to ease of repair. The U.K. National

Coal Board (1975) have published a simple classification of subsidence damage which is based on wide experience. MacLeod and Littlejohn (1974) proposed a classification which is based on the Coal Board's recommendations.

Table I has been developed from the above work. A five-point classification has been adopted: very slight, slight, moderate, severe and very severe. Following Jennings and Kerrich (1962) emphasis is laid on ease of repair. Approximate crack widths are listed and are intended merely as an additional indicator rather than a direct measure of the degree of damage. The widths are based on the views of engineers who have had experience in the observation of building performance and the reaction of occupants. It must be emphasised that the classification in Table I relates only to visible or aesthetic damage. In situations where cracking may permit corrosion or allow penetration or leakage of liquids or gases the criteria are, of course, much more stringent as are those for reinforced concrete (Nawy, 1968).

2.3.3 Movements affecting function: Often the particular function of the building or one of its services will dictate limiting movements, eg overhead cranes, lifts, precision machinery, drains, etc. The engineer should question very deeply such limiting movements as they are sometimes stipulated arbitrarily and if adhered to can have a profound influence on the cost of foundations (Peck, 1965). Alternatively the provision of simple adjustments will often overcome the difficulties.

TABLE I - Classification of visible damage to walls with particular reference to ease of repair of plaster and brickwork or masonry.

Degree of damage	Description of typical damage [†] (Ease of repair is underlined)	Approximate crack width mm
1. Very slight	Hairline cracks of less than about 0.1 mm are classed as negligible. <u>Fine cracks which can easily be treated during normal decoration.</u> Perhaps isolated slight fracture in building. Cracks in external brickwork visible on close inspection.	1 *
2. Slight	<u>Cracks easily filled. Re-decoration probably required.</u> Several slight fractures showing inside of building. Cracks are visible externally and <u>some re-pointing may be required externally</u> to ensure weathertightness. Doors and windows may stick slightly.	5 *
3. Moderate	<u>The cracks require some opening up and can be patched by a mason. Recurrent cracks can be masked by suitable linings. Repointing of external brickwork and possibly a small amount of brickwork to be replaced.</u> Doors and windows sticking. Service pipes may fracture. Weathertightness often impaired.	5 to 15 * or a number of cracks ≥ 3
4. Severe	<u>Extensive repair work involving breaking-out and replacing sections of walls, especially over doors and windows.</u> Windows and door frames distorted, floor sloping noticeably. Walls leaning or bulging noticeably, some loss of bearing in beams. Service pipes disrupted.	15 to 25 * but also depends on number of cracks
5. Very severe	<u>This requires a major repair job involving partial or complete re-building.</u> Beams lose bearing, walls lean badly and require shoring. Windows broken with distortion. Danger of instability.	usually > 25 * but depends on number of cracks

[†]In assessing the degree of damage account must be taken of its location in the building or structure.
*Crack width is only one aspect of damage and should not be used on its own as a direct measure of it.

2.4 PREVIOUS WORK ON LIMITING DEFORMATIONS OF BUILDINGS

Most of the recent contributions to the subject of allowable deformations of structures have emphasised that it is impossible to lay down specific guidelines for limiting differential displacements in relation to damage and that each structure must be treated on its merits (eg Feld, 1965; Moretto, 1971; and Wroth, 1976a). Nevertheless the engineer has to rely heavily on simple guidelines based on previous case histories. In doing so it is important that he should be aware of the types of buildings studied, the criteria used in assessing performance and the variability of the data on which the guidelines are based.

The best known study leading to recommendations on allowable differential settlements of structures is that of Skempton and MacDonald (1956) and guidance for design has been based largely on this work. It was concluded that the limiting value of relative rotation (angular distortion) β to cause cracking in walls and partitions is $1/300$ and that values in excess of $1/500$ should be avoided. The limiting value of β to cause structural damage is $1/150$. Subsequently Bjerrum (1963) supplemented these recommendations by relating the magnitude of relative rotation to various serviceability limits.

Skempton and MacDonald's work is undoubtedly a milestone in the development of the subject and is still referred to widely. However, there is a tendency to follow the guidelines blindly with little or no account being taken of the limited range of structures studied or the criteria that were used to define limiting deformations. Five important points should be noted about Skempton and MacDonald's studies:

1. They were limited to traditional steel and reinforced concrete frame buildings and to a few load-bearing brick wall buildings. Moreover, the direct evidence is based on seven frame buildings (five undamaged and two damaged) and seven load-bearing brick wall buildings (six of them quoted by Terzaghi, 1935) and only one of which was damaged. The remaining data are based on indirect evidence in which (i) settlement damage is reported but not specified in detail, or (ii) so far as is known no settlement damage had occurred. Indirect evidence is given for only five load-bearing brick wall buildings - all of them damaged. The limitations of the data and the tentative nature of the conclusions were emphasised by Skempton and MacDonald in their paper but these qualifications are seldom emphasised in text books and design recommendations. It is evident that the data for load-bearing walls is particularly limited.
2. The criterion used for limiting deformation is the maximum relative rotation (angular distortion) β . As noted previously this choice implies that damage results from shear distortion within the building which is not necessarily the case. Ward (1956) questioned the use of this criterion.
3. No classification of degree of damage was used other than 'architectural', 'functional' and 'structural'.
4. Although it is the cladding and finishes that were generally damaged the quoted values of relative rotation β are total values and not necessarily those

occurring subsequent to the application of the finishes. For load-bearing walls the total values of β are the relevant values. However, for frame buildings the finishes will usually not be applied until some settlement has occurred. In many cases therefore the limiting values of β may be significantly less than the total values.

5. The limiting values of relative rotation β for structural damage in frame buildings are for structural members of average dimensions. They do not apply to exceptionally large and stiff beams or columns where the limiting values of angular distortion may be much less and must be evaluated by structural analysis.

Polshin and Tokar (1957) discussed the question of allowable deformations and settlements and defined three criteria (using the terminology defined in this paper): relative rotation β ; deflection ratio Δ/L ; average settlement. The limiting values of these three quantities adopted by the 1955 Building Code of the USSR were then listed. It is of particular interest to note that frame structures were treated separately from continuous load-bearing brick-wall buildings. Recommended maximum relative rotations vary from $1/500$ for steel and concrete frame infilled structures to $1/200$ where there is no infill or no danger of damage to cladding. These values are clearly in line with Skempton and MacDonald's recommendations.

Much stricter criteria were laid down for load-bearing brick walls. For ratios of length L to height H less than 3 the maximum deflection ratio Δ/L are 0.3×10^{-3} and 0.4×10^{-3} for sand and soft clay respectively. For L/H ratios greater than 5 the corresponding deflection ratios are 0.5×10^{-3} and 0.7×10^{-3} . In their paper, Polshin and Tokar made use of two important concepts: (i) the L/H ratio of the building or wall, and (ii) the concept of limiting tensile strain before cracking. Using a limiting tensile strain of 0.05 per cent the limiting relationship between L/H and deflection ratio Δ/L was presented and was shown to be in good agreement with a number of cracked and uncracked brick buildings. The above recommendations for load-bearing brick walls are based on a requirement for no cracking so that if adhered to the degree of damage would be unlikely to exceed 'very slight' (see Table I).

It is noteworthy that Meyerhof (1953) also treated framed buildings and load-bearing brick walls separately. He recommended limiting relative rotations of $1/300$ for open frames, $1/1000$ for infilled frames and $\Delta/L = 1/2000$ for load-bearing walls or continuous brick cladding.

Grant, Christian and Vanmarcke (1974) carried out a literature survey aimed at up-dating Skempton and MacDonald's work. Data for 68 frame buildings, many of modern construction, were added to the original data and appear to confirm that a relative rotation $\beta = 1/300$ is a reasonable damage limit. Only five additional load-bearing wall buildings were included and four of these were damaged. Hence the conclusion by Grant et al that the damage limit of $\beta = 1/300$ is confirmed for load-bearing walls must be treated with caution - particularly in view of Polshin and Tokar's much more conservative recommendations.

2.5 RECENT WORK ON FUNDAMENTAL DAMAGE CRITERIA

The limiting damage criteria discussed in the previous section may be useful general guides but are unsatisfactory for a number of reasons. They are based on observations and are therefore essentially empirical and can offer no insight into the cause of damage. They cannot be used for unusual structures or unusual materials. Perhaps most important of all they do not encourage the engineer to examine the details of the structure and finishes with a view to checking serviceability.

2.5.1 Limiting tensile strain: With these limitations in mind Burland and Wroth (1974) suggested that a more fundamental criterion for damage was required and put forward the idea that a criterion related to visible cracking would be useful since tensile cracking is so often associated with settlement damage. Following the work of Polshin and Tokar (1957) they assumed that the onset of visible cracking in a given material was associated with a limiting tensile strain ϵ_{lim} (Burland and Wroth used the symbol ϵ_{crit}).

Leaving aside for the time being the question of what values to assign to it, the application of the concept of limiting tensile strain can be illustrated by applying it to the cracking of a simple beam (which may be thought of as representing a building - see Fig 2a). It is assumed that the deflected shape of the beam is known. The problem is to define the deflection criteria for initial cracking when the limiting tensile strain is reached at some point within the beam. Two possible extreme modes of deformation, bending only and shearing only, are shown in Figs 2b and 2c. It is immediately obvious that the limiting deflection for initial cracking of a simple beam will depend on the ratio of L/H and on the relative stiffness of the beam in shear and in bending.

It can be shown that for a given deflection Δ the maximum tensile strains are not very sensitive to the precise form of loading. Timoshenko (1957) gives the expression for the central deflection of a centrally loaded beam of unit thickness in both shear and bending as:

$$\Delta = \frac{P}{48} \cdot \frac{L^3}{EI} \left[1 + \frac{18}{L^2} \cdot \frac{I}{H} \cdot \frac{E}{G} \right] \dots\dots (2.1)$$

where E is Young's modulus; G is the shear modulus; and I is the moment of inertia.

Equation (2.1) may be written in terms of the maximum extreme fibre strain $\epsilon_{b(max)}$ as follows:

$$\frac{\Delta}{L} = \epsilon_{b(max)} \cdot \frac{L}{12y} \left[1 + \frac{18}{L^2} \cdot \frac{I}{H} \cdot \frac{E}{G} \right] \dots (2.2)$$

Similarly for the maximum diagonal strain $\epsilon_{d(max)}$ eq. (2.1) becomes:

$$\frac{\Delta}{L} = \epsilon_{d(max)} \left[1 + \frac{L^2}{18} \cdot \frac{H}{I} \cdot \frac{G}{E} \right] \dots (2.3)$$

By setting $\epsilon_{(max)} = \epsilon_{(lim)}$ equations (2.2) and (2.3) define the limiting values of Δ/L for cracking of simple beams in bending and in shear. It is evident that for a given value of ϵ_{lim} the limiting value Δ/L (whichever is the lowest from eqns (2.2) and (2.3)) depends on L/H , E/G and the position of the neutral

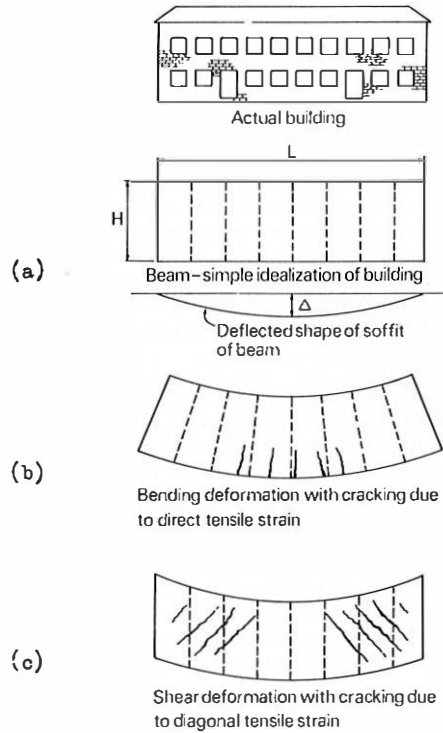

Fig 2 Cracking of a simple beam in bending and in shear.

axis (and hence I).

For an isotropic beam ($E/G \approx 2.5$) with neutral axis in the middle the limiting relationship between $\Delta/L \cdot \epsilon_{lim}$ and L/H is given by curve 1 in Fig 3.

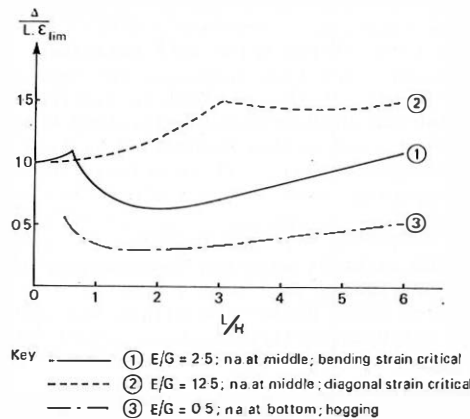

Fig 3 Influence of E/G on the cracking of a simple rectangular beam.

For a beam which has a relatively low stiffness in shear ($E/G = 12.5$) the limiting relationship is given by curve 2. A particularly important case is that of a beam which is relatively weak in bending and which is subjected to hogging such that its neutral axis is at the bottom. Curve 3 shows the limiting relationship for such a beam ($E/G = 0.5$). These curves serve to illustrate that even for simple beams the limiting deflection ratio causing cracking can vary over wide limits.

Burland and Wroth carried out a preliminary survey of data for cracking of infill frames and masonry walls and concluded that the range of values of average tensile strain at the onset of visible cracking for a variety of common building materials was remarkably small. For brickwork and blockwork set in cement mortar ϵ_{lim} lies between 0.05 and 0.1 per cent, while for reinforced concrete having a wide range of strengths the values lie between 0.03 and 0.05 per cent.

In order to assess the potential value of the limiting tensile strain approach in estimating the onset of cracking in buildings, Burland and Wroth compared the limiting criteria obtained from the analysis of simple beams with observations of the behaviour of a number of buildings - many of them of modern construction. For this comparison a value of limiting tensile strain $\epsilon_{lim} = 0.075$ per cent was used. The buildings were classified as frame, load-bearing wall undergoing sagging and load-bearing wall undergoing hogging. Figures 4(a), (b) and (c) show the comparison with curves (2), (1) and (3) respectively from Fig 3. Also shown is the criterion of limiting relative rotation $\beta = 1/300$ and the limiting relationship proposed by Polshin and Tokar for load-bearing walls. In spite of its simplicity the analysis based on tensile strain reflects the major trends in the observations. In particular the prediction is borne out that load-bearing walls, especially when subjected to hogging, are more susceptible to damage than frame buildings which are relatively flexible in shear. Clearly there is scope for more realistic analysis of actual structures using numerical methods of analysis. It is hoped that the success of the present over-simplified approach will stimulate further work along these lines.

At this point it is necessary to emphasise that limiting tensile strain is not a fundamental material property like tensile strength. Mainstone (1974) has pointed out that local strains during the early stages of crack development are much smaller than the values of ϵ_{lim} used by Burland and Wroth. Hence 'limiting tensile strain' should be regarded as a measure of serviceability which, when used in conjunction with an elastic analysis, aids the engineer in deciding whether his building is likely to develop visible cracks and where the critical localities might be. The advantages of the approach over traditional empirical rules limiting deformations are:

- (1) It can be applied to complex structures employing well established stress analysis techniques;
- (2) It makes explicit the fact that damage can be controlled by paying attention to the modes of deformation within the building structure and fabric;
- (3) The limiting value can be varied to take account of differing materials and serviceability limit states, e.g. Girault (1964) has pointed out that the use of

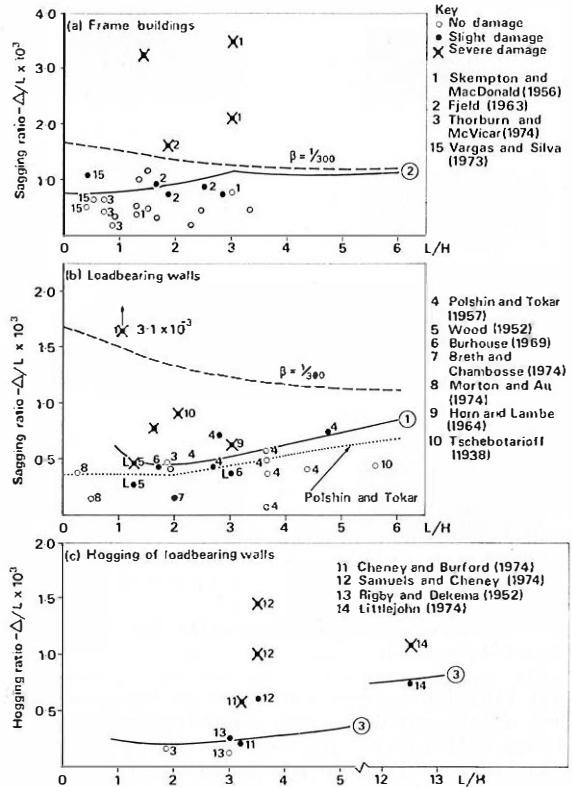

Fig 4 Relationship between Δ/L and L/H for buildings showing various degrees of damage - points without numbers refer to data given by Grant et al, 1972; Burland and Wroth, 1974).

soft bricks and lean mortar can substantially reduce cracking, as it raises the value of ϵ_{lim} .

Limiting strain is preferred to a 'notional' tensile strength as its value does not appear to vary a great deal for a wide range of types and strengths of common building materials. Moreover it retains a physical significance after cracking which 'strength' does not.

2.5.2 Crack propagation: The onset of visible cracking does not necessarily represent a limit of serviceability. Provided the cracking is controlled, as in a reinforced concrete beam, it may be acceptable to allow deformation to continue well beyond the initiation of cracking. Cases where the propagation of initial cracks may be fairly well controlled are framed structures with panel walls and reinforced load-bearing structures. Unreinforced load-bearing walls undergoing sagging under the restraining action of the foundations may also fall into this category. However, Ward (1956) has drawn attention to such a case where slip along the bitumen damp proof course resulted in extensive cracking in the overlying brickwork.

An important mode of deformation where uncontrolled cracking can occur is that of hogging of unreinforced load-bearing walls. Once a crack forms at the top of the wall there is nothing to stop it propagating downwards. The difference in cracking due to hogging and sagging is illustrated in Fig 5 where the two model walls have experienced similar magnitudes of relative deflection.

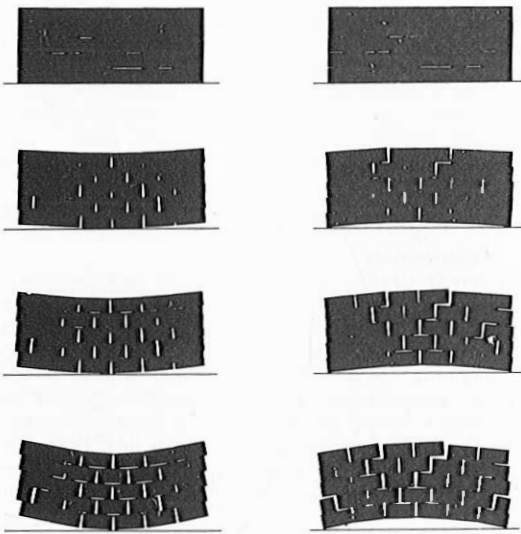

Fig 5 Cracking of model brick walls due to sagging and hogging.

Kerisel (1975) has drawn attention to the growing problem of old buildings near tunnels, excavations or new heavy buildings. The examples he quotes emphasise the vulnerability of old buildings to the convex deformations that occur. He suggests that the critical radius of curvature for old buildings subject to hogging is four times that for framed buildings. This is in agreement with the results given in Fig 4. D'Appolonia (1971), Döllerl et al (1976) and Burland and Hancock (1977) give detailed measurements of convex deformations alongside deep excavations. In these circumstances tensile strains in the ground may be just as significant in contributing to damage.

Recently Green, MacLeod and Stark (1976) successfully analysed cracking of brick structures employing a finite element method incorporating a brittle limiting tension material. While such an approach is far too complex for routine design purposes, it offers a useful adjunct to future research on the relationships between movement and damage in buildings. Littlejohn (1974) describes some important experiments on the cracking of brick walls subject to mining subsidence. Such studies are essential to a proper understanding of the mechanisms of cracking due to foundation movement.

2.5.3 Discussion: The studies referred to in this section have served to emphasise the complexity of the problem of allowable movements and associated damage. The simple analogue of a uniform rectangular beam demonstrates that the limiting relative deflection will depend on the brittleness of the building material, the length to height ratio, the relative stiffness in shear and bending and the mode of deformation (sagging or hogging). In addition the propagation of cracks will depend on the degree of tensile restraint built into the structure and its foundation. All these factors point to frame buildings with panel walls being able to sustain much larger relative deflections without severe damage than unreinforced load-bearing walls. The evidence presented in Fig 4 supports these conclusions.

One of the most obvious facts facing anyone attempting to work in this important subject is the almost total lack of really well-documented case histories of damage. Until a number of such case histories become available for a variety of building types the temptation to lay down definitive rules on limiting deformation should be resisted as these will tend to inhibit future developments. It is much more important that the basic factors are identified and appreciated by engineers. In Section 6.4 of this Review a few case histories are given to illustrate various aspects of the problem.

2.6 ROUTINE GUIDES ON LIMITING SETTLEMENT

The assessment of limiting settlements of structures is even more complex than that of limiting deformation as it brings in the behaviour of the ground and its interaction with the structure. The problem is essentially one of estimating the maximum relative deflections and rotations likely to be experienced by the structure and analytical methods of doing this are discussed in Chapter 5. Nevertheless, the practising engineer needs to know when it is reasonable for him to proceed in a routine manner and for this he uses simple guidelines based on previous experience.

All too often such guidelines are interpreted as providing rigid rules for 'allowable maximum settlements'. Terzaghi (1956) issued a stern warning against such proposals. The problem is to provide safe simple guides without inhibiting the search for optimum solutions when appropriate. It is therefore suggested that the term 'Routine Limits' be used when such guidelines are proposed.

Following Terzaghi and Peck (1948), foundations on sand will be treated separately from those on clayey soils. Such a division does, of course, leave out a wide range of types of ground for which the engineer must use his judgement and experience.

2.6.1 Sands: Terzaghi and Peck (1948) suggested that for footings on sand the differential settlement is unlikely to exceed 75 per cent of the maximum settlement and since most ordinary structures can withstand 20 mm of differential settlement between adjacent columns, a limiting maximum settlement of about 25 mm was recommended. For raft foundations the limiting maximum settlement was increased to 50 mm.

Skempton and MacDonald (1956) correlated measured maximum relative rotation (angular distortion) β with total and differential settlement for eleven buildings founded on sand. They concluded that for a safe limit of $\beta = 1/500$ the limiting maximum differential settlement is about 25 mm and the limiting total settlements are about 40 mm for isolated foundations and 40 mm to 65 mm for raft foundations. The following features should be noted:

- (1) In sands settlement takes place rapidly under load. Hence for frame buildings, where often a significant proportion of the load is applied prior to the application of the cladding and finishes, the above guides may be conservative.
- (2) No cases of damage to buildings founded on sand were reported by Skempton and MacDonald* or Grant et

* An extreme case of a building which settled 630 mm was presented, but this appears to be quite exceptional (Terzaghi, 1956).

al (1972).

(3) Terzaghi (1956) stated that he knew of no building founded on sand that had settled more than 75 mm. Of the 37 settlement results reported by Bjerrum (1963) only one exceeded 75 mm and the majority were less than 40 mm. None of the cases reported by Meyerhof (1965), or Schultze and Sherif (1973) exceeded 35 mm.

Therefore few problems should be encountered with routine buildings founded on deep layers of sand. Difficulties have occurred when vibration has taken place due to machinery and traffic or due to nearby construction. Also significant settlements can occur due to large fluctuations in load as with silos (Nonveiller, 1963). Finally, it should be noted that even small quantities of organic matter or silt and clay increase the compressibility, and its variability, significantly.

2.6.2 Clayey soils: Using similar procedures to those described previously Skempton and MacDonald concluded that for foundations on clay the design limit for maximum differential settlement is about 40 mm. The recommended design limits for total settlements are about 65 mm for isolated foundations and 65 mm to 100 mm for rafts. These recommendations were criticized by Terzaghi on the grounds that the relationship between maximum relative rotation β and maximum settlement in clays is dependent on too many factors for a single value to be assigned to it. Grant, Christian and Vanmarcke have added a number of case records to the original data. These confirm that there is no simple correlation between maximum relative rotation and maximum settlement in clays. Nevertheless, we must consider whether Skempton and MacDonald's recommendations are acceptable as routine limiting values.

Figure 6 shows the maximum differential settlements $\delta \rho_{max}$ plotted against maximum settlements ρ_{max} for: (a) frame buildings on isolated foundations and (b) buildings with raft foundations. Much of the data have been taken from Skempton and MacDonald (1956) and Grant et al (1972) and the remainder from recent papers. As far as possible cases have been excluded where the thickness of the compressible strata varied or where the loading intensity was significantly non-uniform. A distinction has been drawn between buildings founded directly on clayey soils and those founded on a stiff layer overlying the clay stratum. In Fig 6(b) (raft foundations) frame buildings are distinguished from buildings of load-bearing wall construction. The figures against some of the points refer to the number of storeys. Buildings showing slight to moderate damage are indicated by full points and those showing severe damage by crosses. Figure 6 is similar to one given by Bjerrum (1963) and his suggested upper limit curves for flexible structures and rigid structures have been incorporated. The following features are particularly noteworthy:

(1) In both Figs 6(a) and 6(b) the ratio between maximum differential settlement and the maximum settlement ($\delta \rho_{max} / \rho_{max}$) is less for buildings founded on a stiff overlying layer than for those founded directly on clay.

(2) Bjerrum's upper limit curves for flexible and rigid structures appear to be confirmed for undamaged

buildings, but it is of interest to note that many of the results for damaged buildings lie above the curve.

(3) In Fig 6(a) some cases of slight damage to buildings on isolated foundations are reported for differential settlements in excess of 50 mm and total settlements in excess of 150 mm.

(4) In contrast damage to buildings on rafts (Fig 6b) has not been reported for differential settlements and total settlements less than 125 mm and 250 mm respectively. Even these are not truly representative as one building is reported as being founded on fill and the Charity Hospital has distinctly non-uniform loading. What is very clear from Fig 6(b) is that many buildings on rafts have undergone substantial total settlements with no reported damage.

It must be emphasised that the diagrams are based on limited data for uniformly loaded buildings founded on uniform clayey strata. They indicate some of the factors influencing performance for these conditions. The full arrows represent the design limits suggested by Skempton and MacDonald (1956). The dashed arrows indicate some maximum average settlements permitted by the 1962 USSR Building Code (see Tschebotarioff, 1973 - Table 4-4). It is not the purpose of this Review to suggest alternative guides. What is clear from Figure 6 is that there are a number of examples of undamaged buildings that have settled more than the limits given by Skempton and MacDonald and the USSR Building Code. The recommendations made by Skempton and MacDonald, particularly as regards differential settlements, are probably reasonable as 'routine limits'. However, provided it can be demonstrated that the deflection ratios Δ/L or relative rotation β (see Section 2.2) will be within tolerable limits there appears to be no reason why larger total and differential settlements should not be accepted. Methods of calculating Δ/L , making due allowance for the stiffness of the superstructure, are discussed in Chapter 5. For many stiff buildings on uniform ground the limiting settlements are likely to be governed more by considerations of tilt, damage to services entering the building or the influence on adjacent structures than of damage to the building itself.

2.6.3 General remarks: The discussion has only covered limiting settlements on sand and uniform clayey soils. Clearly this leaves out the majority of ground conditions, including alluvia, silts, loess, fill, peat and a wide range of residual soils. For most of these soils there is no short cut to estimating the probable maximum distortions of the structure. Estimates have to be made of the degree of heterogeneity of the ground and its influence on the structure using such techniques as are expedient to the job in hand including past experience, borings, probing, in-situ and laboratory testing and analysis, detailed settlement analysis and the influence of structural stiffness. It is also necessary to take account of the proposed foundation construction method, particularly if excavation is envisaged, as it will often radically affect the compressibility of the underlying ground. Cases of damage have resulted from the induced vertical stresses in the ground locally exceeding the preconsolidation pressure (eg Vargas, 1955). A case history of such an instance is given in Section 6.4. In such cases the stiffness and strength of the structure must be sufficient to resist the local increase in compressibility of the ground.

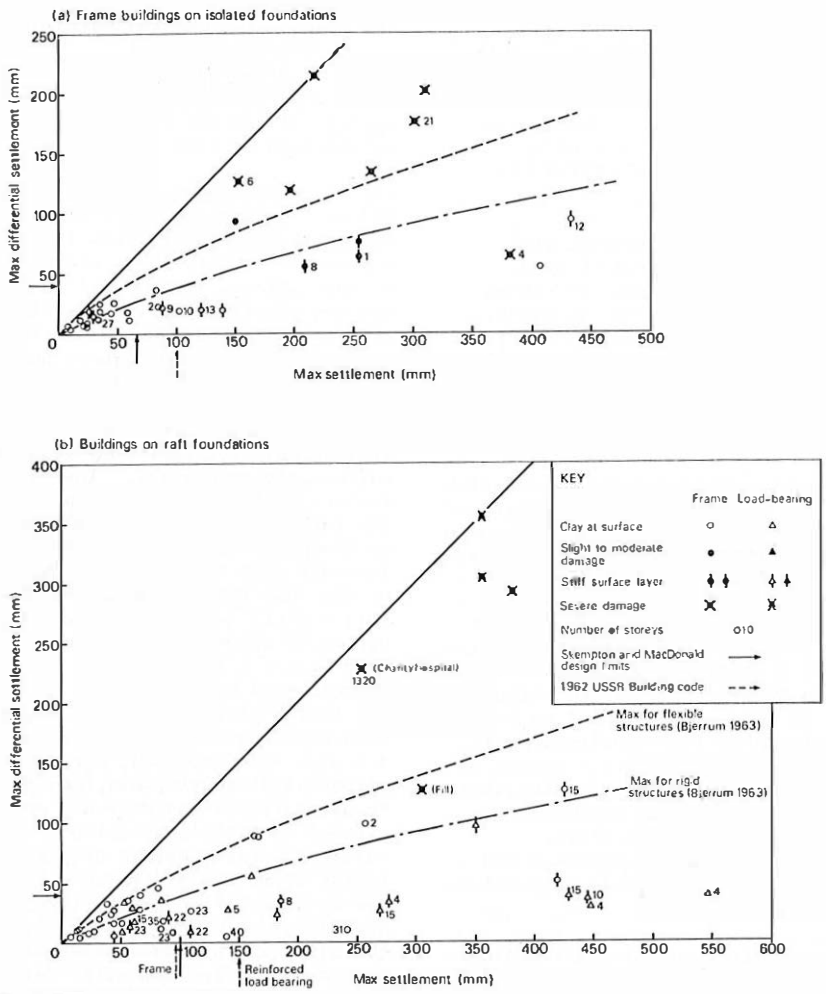

Fig 6 Performance of buildings on clayey soils

This discussion on limiting settlements has also been confined to simple routine structures. The routine guides described above should never be applied indiscriminately to buildings and structures which are in any way out of the ordinary or for which the loading intensity is markedly non-uniform. Finally, it must always be borne in mind that the foundations & underlying ground are a part of the structure and often an economic solution to a differential settlement problem can be found by suitable design and detailing of the structural members and finishes. This applies particularly to bridges, where a high percentage of the total cost of the structure (often over 50 per cent) can go into foundations designed to satisfy stringent differential settlement criteria. For each new structure the engineer is well advised to consider the questions listed in Section 2.3 as to who is limiting the settlements and why.

CHAPTER 3 - SETTLEMENT PREDICTION

In 1974 the British Geotechnical Society organised a Conference on the Settlement of Structures at Cambridge University. Besides containing a wealth of information in the papers and discussions the Proceedings contain very comprehensive state of the art

reviews on settlement in granular soils (Sutherland, 1974), normally consolidated and lightly overconsolidated cohesive materials (Simons, 1974), heavily overconsolidated cohesive materials (Butler, 1974) and rocks (Hobbs, 1974). This Chapter will deal with the more theoretical problems of settlement analyses drawing on the above work where necessary. The object of this Chapter is to demonstrate that simple traditional settlement calculations are usually adequate for practical purposes provided the appropriate in-situ soil properties have been obtained.

3.1 CURRENT METHODS

In this Review attention is devoted to foundations for normal buildings and structures where the factor of safety against general bearing capacity failure is greater than about 2.5. The analysis of the behaviour of footings and embankments for lower factors of safety present special problems which fall outside the scope of this Review.

The total settlement is defined as ρ_t and for saturated clays (neglecting secondary settlements for the present) is made up of an undrained component ρ_u and a consolidation component ρ_c such that:

$$\rho_t = \rho_u + \rho_c \dots\dots\dots (3.1)$$

The situation for unsaturated soils can be complex as changes in moisture content subsequent to construction may give rise to heave or additional settlement. However, provided the soil moisture suction is not high conventional methods can be used to estimate ρ_t .

For the classical one-dimensional method (Terzaghi, 1943) the vertical strain $\delta \epsilon_v$ in each successive layer δh beneath the foundation is calculated from the expression: $\delta \epsilon_v = m_v \cdot \Delta \sigma'_z$ where m_v is the coefficient of volume compressibility for the range in vertical effective pressure σ'_{z0} to $\sigma'_{z0} + \Delta \sigma'_z$. The total settlement is then obtained by summation to give:

$$\rho_{od} = \sum m_v \cdot \Delta \sigma'_z \cdot \delta h \quad \dots (3.2)$$

where ρ_{od} (the one-dimensional settlement)* is assumed equal to the total settlement ρ_t . Many authors have remarked that the use of one-dimensional methods for thick beds of compressible soils is inaccurate since substantial lateral displacements can occur. Skempton, Peck and MacDonald (1955) recognised that the undrained settlement ρ_u could be significant and by accepting that $\rho_t = \rho_{od}$ suggested that the consolidation settlement was given by:

$$\rho_c = \rho_{od} - \rho_u \quad \dots (3.3)$$

where ρ_u is calculated from elastic displacement theory. Meyerhof (1956) and Alderman (1956) suggested that it was more accurate to set $\rho_c = \rho_{od}$.

Skempton (1957) indicated that eq.(3.3) was only a rough and ready method. In the same year Skempton and Bjerrum (1957) proposed a new method of estimating ρ_c by applying a correction factor μ to ρ_{od} to take account of the magnitude of the pore pressure set up beneath the foundation during undrained loading and which is dissipated during consolidation. The total settlement is therefore given by:

$$\rho_t = \rho_u + \mu \cdot \rho_{od} \quad \dots (3.4)$$

This method is widely used and curves of μ versus the pore pressure coefficient A for circular and strip footings are given in most modern text books.

Skempton (1957) suggested that in due course settlement analysis would probably be carried out by means of triaxial tests in which appropriate principal stresses are applied first under undrained conditions and then allowing drainage. This is the basis of the stress-path method of testing (Lambe, 1964). The vertical strains are measured during the undrained stages and enough tests are carried out to permit the summation of the vertical strains over an appropriate depth to give the initial and total settlements.

A variation of this method has been proposed by Davis and Poulos (1963) and (1968) with similar approaches by Kerisel and Quatre (1968), Egorov et al (1957) and Sulkje and Sovino (1963). The measured vertical and volumetric strains are interpreted in terms of equivalent undrained and drained elastic constants E_u , ν_u , E^* and ν^* . The initial and total settlements are then obtained by summing the vertical strain as follows:

* ρ_{od} is preferred to ρ_{oad} as the one-dimensional settlement can be predicted using other methods besides the oedometer test.

$$\rho = \sum \delta \epsilon_v \times \delta h = \sum \frac{1}{E} [\sigma_z - \nu (\sigma_x + \sigma_y)] \delta h \quad \dots (3.5)$$

using the appropriate undrained or drained values of E and ν . Alternatively the constants are used in conjunction with elastic displacement theory. Simons and Som (1969) have used a sophisticated form of stress path testing to evaluate the settlement of foundations on London Clay.

Gorbunov-Ponadov and Davydov (1973) give a detailed account of the approach to settlement prediction in the USSR. Extensive use is made of the theory of elasticity employing a modulus of deformation often determined by means of in-situ plate tests. In order to simplify the calculations many authors have sought to develop elastic displacement methods using an 'equivalent' homogeneous layer to represent the real situation in which the displacements die away rapidly with depth due to self-weight, non-linear stress-strain behaviour and threshold stress effects.

The advent of powerful numerical methods of analysis, in particular the finite element method, has made it possible to solve a wide range of boundary value problems given the appropriate constitutive relationships. The methods can handle complicated geometry and loading conditions, the influence of self-weight and complex material properties, including anisotropy, non-homogeneity and non-linearity. The methods are finding increased use in settlement analysis.

When faced with such a wide range of alternative approaches to settlement analysis the average practising engineer can be forgiven for feeling somewhat confused. Although the subject appears to have made progress over the last few years there is really no yardstick against which to judge the reliability of the various methods. One thing is clear, as the methods of analysis have become more sophisticated so too have the testing procedures which are needed to supply the soil parameters. From a purely practical point of view one must ask whether such sophistication is necessary and, indeed, whether greater accuracy is in fact achieved.

There is a growing need for objective assessments to be made of the accuracy of the various methods of settlement analysis under rigorous conditions. One of the difficulties in the past has been that the methods of testing have been intimately linked with the analytical method so that it has been difficult to isolate inaccuracies in sampling and testing from the limitations of the analyses. In recent years sufficient progress has been made with the development of analytical techniques and realistic constitutive relationships to attempt here a preliminary assessment of the accuracy of current analytical methods. To the practical engineer much of this may appear somewhat academic. However, the conclusions, which are given at the end of the Chapter are of practical significance. The main conclusion is that the errors introduced by the simple classical methods of analysis are small compared with those that can occur during sampling and testing. Hence the emphasis should be on the accurate determination of simple parameters, such as one-dimensional compressibility, coupled with simple calculations.

3.2 STRESS DISTRIBUTION

A pre-requisite for accurate settlement (or indeed

any displacement) prediction is a knowledge of the initial and subsequent stresses. Most texts on soil mechanics and foundation engineering outline methods of calculating changes in vertical stress using linear, homogeneous, isotropic elastic theory. An obvious and important question is the extent to which the departure of real soils from such ideal behaviour influences the stress distributions beneath foundations. Many soils patently do not satisfy the assumptions of simple linear elasticity and engineers feel uneasy about applying a method which, at first sight, appears to rest on such poor assumptions. As a result of recent analytical and experimental work we are in a better position to assess the errors involved.

3.2.1 Non-linearity: Morgenstern and Phukan (1968) studied the stress changes in a homogeneous non-linear elastic foundation. They noted that the vertical stress changes are essentially independent of the stress-strain relation used in the analysis as shown in Fig 7. However the horizontal stress changes proved very sensitive to non-linearity. Hög, Christian and Whitman (1968) reached similar conclusions for an elastic-perfectly plastic material which conforms to the classic plastic flow laws during yield.

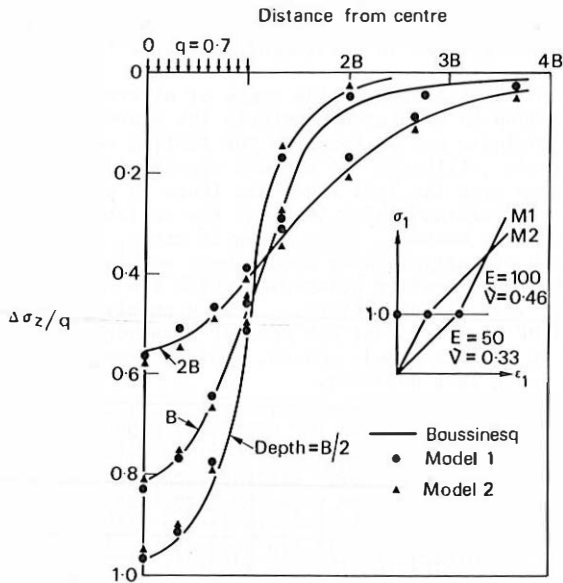

Fig 7 Vertical stress distribution for three stress-strain relations (Morgenstern & Phukan, 1968).

3.2.2 Non-homogeneity: Another important assumption that is frequently made is that of homogeneity. Clearly this is a poor assumption for many practical situations where the soils are frequently layered and have stiffness properties which vary markedly with depth or in plan. Sovinc (1961) and many others have shown that the presence of an underlying rigid layer tends to concentrate the stresses somewhat beneath the loaded area, but the effect is not very pronounced. The horizontal stress changes are more sensitive to the presence of a rigid stratum, particularly for high Poisson's ratios.

Many solutions exist for the stress distributions within multi-layer systems and their main application

has been in pavement design where extreme forms of non-homogeneity exist. Poulos and Davis (1974) summarise the results of Fox, L (1948) for a two-layer system which provide a useful insight into the influence of layer thickness and relative stiffness on the distribution of stress. Reductions in stiffness near the surface do not greatly influence the vertical stresses (Giroud, 1970). However, the presence of a stiff upper layer has a marked influence on the distribution of vertical stress. Figure 8 shows the vertical and horizontal distribution of stress beneath the centre of a circular load for three thicknesses of the upper layer when $E_1/E_2 = 10$. It is evident that the vertical stress distributions differ significantly from Boussinesq. Although approximate methods exist to allow for this (Palmer and Barber 1940) the value of E_1/E_2 is difficult to assess so that, in practice, the calculated vertical stress changes may be significantly in error.

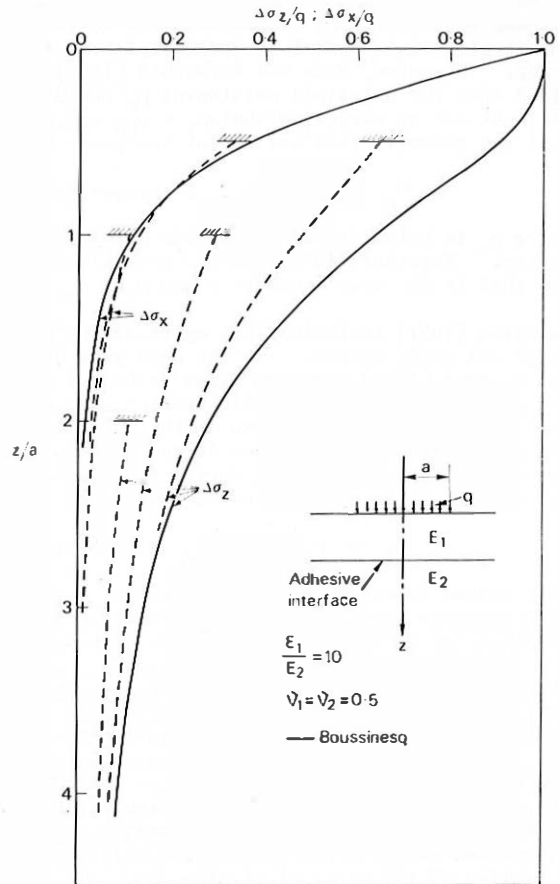

Fig 8 Influence of a stiff upper layer (uniform circular load).

A common form of heterogeneity, and one that has only recently received detailed attention, is that in which the stiffness increases continuously with depth. Gibson (1974) presents an extensive bibliography dealing with this topic. Figure 9 shows the stress distribution for a uniform strip load on an elastic isotropic half space of constant Poisson's ratio and Young's modulus increasing linearly with depth from zero at the surface (Gibson and Sills, 1971). The vertical stresses can be seen to be slightly dependent on Poisson's ratio whereas the horizontal stresses are

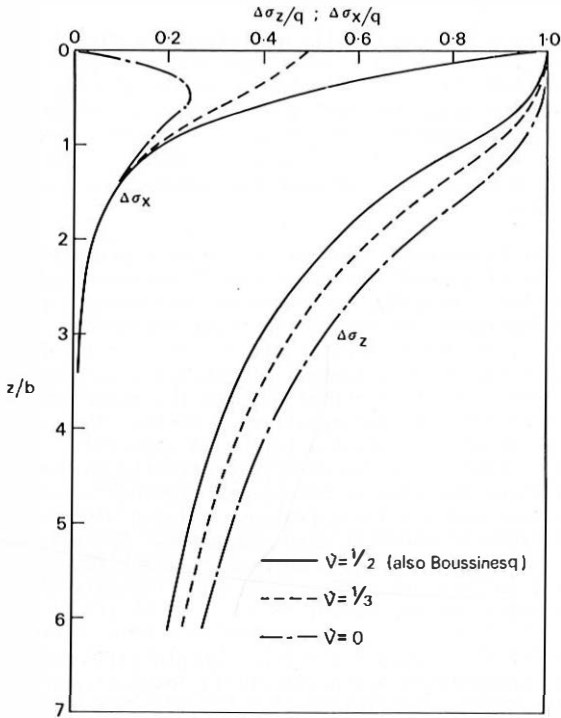

Fig 9 Stress distribution beneath uniform strip load on non-homogeneous half space (Gibson and Sills, 1971).

extremely sensitive to Poisson's ratio. This can be contrasted with the homogeneous case where the stresses are independent of Poisson's ratio.

3.2.3 **Anisotropy:** Gerrard and Harrison (1970a and b) have made a major contribution to the study of foundations on cross-anisotropic materials, providing complete solutions to a wide range of loading conditions for strip and circular footings. The solutions are in mathematical form and are somewhat cumbersome.

A cross-anisotropic material is characterised by the following five elastic parameters:

- E_V, E_H = Young's modulus in vertical and horizontal planes
- ν_{VH} = Poisson's ratio for effect of vertical strain on horizontal strain
- ν_{HH} = Poisson's ratio for effect of horizontal strain on complementary horizontal strain
- G_{VH} = Shear modulus in vertical plane.

In addition it is convenient to define:

$$n = \frac{E_H}{E_V} \left(= \frac{\nu_{HV}}{\nu_{VH}} \right) \dots\dots\dots (3.6)$$

$$\text{and } m = \frac{G_{VH}}{E_V} \dots\dots\dots (3.7)$$

(for an isotropic material $m = \frac{1}{2(1+\nu)}$).

It is noteworthy that G_{VH} is a completely independent variable apart from being non-negative (see for example Hooper, 1976).

Figure 10 shows the distribution of vertical stress

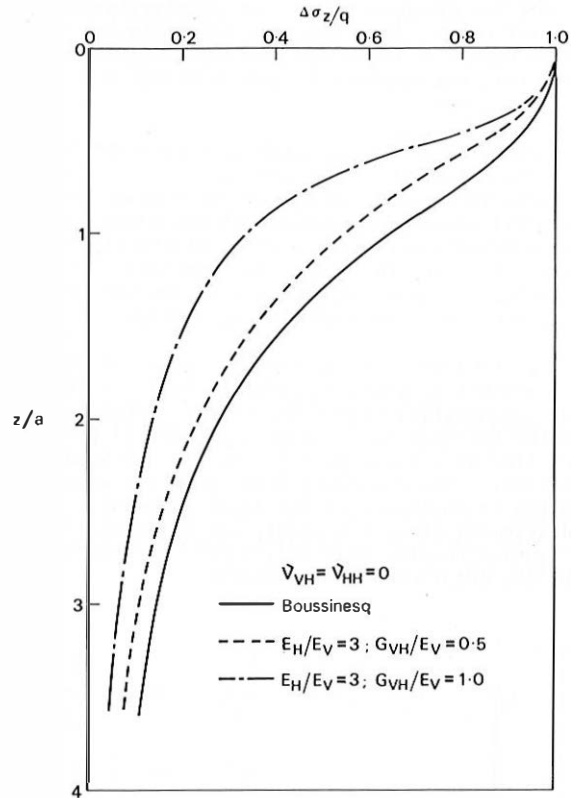

Fig 10 Influence of anisotropy on vertical stresses (uniform circular load)

change beneath the centre of a uniform circular load on a homogeneous cross-anisotropic elastic material where, for simplicity, $\nu_{VH} = \nu_{HH} = 0$. For an isotropic material $E_H/E_V = 1$ and $G_{VH}/E_V = \frac{1}{2}$ (for $\nu = 0$) and this is represented by the full line (Boussinesq). The dotted line is for a fairly extreme value of $E_H/E_V = 3$ but maintaining $\nu_{VH}/E_V = \frac{1}{2}$. The chain dotted line is for $E_H/E_V = 3$ and $G_{VH}/E_V = 1$. It is evident that changes in the shear modulus G_{VH} , which is a completely independent parameter, have a greater influence on the vertical stresses than do variations in horizontal stiffness E_H . Yet G_{VH} is seldom measured and we have little knowledge of the range of values of G_{VH}/E_V that might be expected for soils.

3.2.4 **Discussion:** In this section we have examined briefly the influence of such factors as non-linearity, non-homogeneity and anisotropy on the distribution of stress induced by simple surface loads. With the advent of the finite element method it would be simple to carry out much more exhaustive studies. However, for practical purposes enough has been done to demonstrate that for many ground conditions the Boussinesq equations give a reasonably accurate distribution of vertical stress changes. We note, however, that the vertical changes are difficult to estimate accurately for a stiff layer overlying a more compressible layer and there is some uncertainty for cross-anisotropic soils where the distribution of vertical stress is sensitive to variations in G_{VH} .

The situation is by no means so straight forward for the horizontal stresses. It is well known that the

horizontal stress change is dependent on Poisson's ratio and the presence of non-homogeneity increases this sensitivity. Moreover, non-linearity has a profound influence. Hence the Boussinesq equations are unlikely to give accurate estimates of changes in horizontal stress.

These conclusions are supported by Morgan and Gerrard (1971) who summarise the results of model circular loading tests on sand carried out by a number of workers. The results of vertical stress measurements are surprisingly well predicted by simple elastic theory. However, the radial and tangential stresses show a wide variation in measured values and may be grossly over- or underestimated by theory.

Finally, although emphasis has been given to surface loads, attention should be given to loads at the base of open excavations (Leonards, 1968). Figure 11 shows the increase in vertical stresses beneath the centre line of a strip load at the base of an open excavation. The departure from the Boussinesq distribution is analogous to the depth correction factor for settlement (Fox, E N 1948), but the open excavation is more complex (Burland, 1969b) and has received the detailed study it merits.

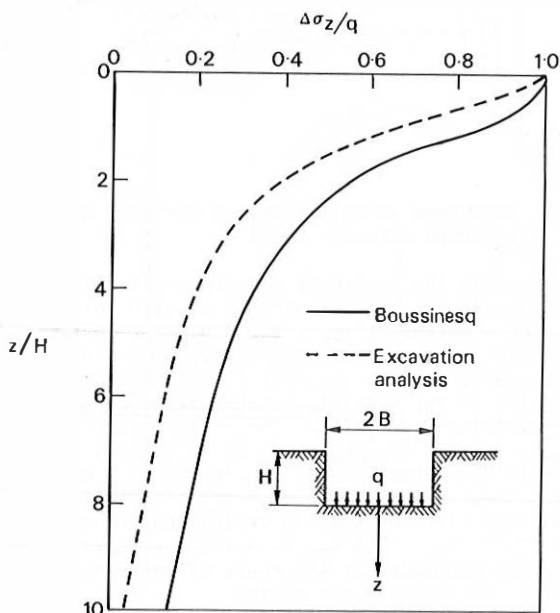

Fig 11 Vertical stresses beneath strip load at base of excavation ($B/H = 1$).

3.3 STRESS-STRAIN THEORIES

In order to assess the accuracy of current theoretical methods of estimating settlement we must first look briefly at some of the assumptions that are made about the stress-strain behaviour of soils.

Frequently elastic formulations are assumed. Inherent in any elastic formulation, whether linear or non-linear, are the assumptions: (i) that the behaviour is stress-path independent; and (ii) that the orientation of the axes of the increments of principal strain is a function only of the orientation and magnitude of the increments of principal stress and is

independent of the total stress.

In contrast for non-elastic materials (eg plastic, viscous, etc): (i) the behaviour is stress-path dependent and (ii) the orientation of the principal strain increments is usually dependent on both the stress increments and the total stress. The orientation of the principal strains is of importance when significant rotations of principal stress are likely to occur.

For most foundations the initial in-situ principal stresses will usually be near enough vertical and horizontal unless the ground is sloping steeply or the depositional or tectonic history is complex. Moreover, for vertically loaded foundations the directions of the major principal stress-increments appear to remain sensibly vertical beneath the major portion of the loaded area irrespective of whether the material is elastic or plastic (eg Majid and Craig, 1971). Hence, for the case of vertically loaded foundations the axes of stress and strain are usually coincident and a major difference between elastic and other types of material does not arise. The situation is clearly very much more complex for foundations subject to inclined loads, where significant rotations of principal stress occur.

Therefore the stress conditions beneath vertically loaded foundations are particularly 'simple' and relatively simple constitutive laws are adequate to represent soil behaviour. Apart from the quantitative relationships between stress and strain the question of whether the soil is stress-path dependent is perhaps the most important characteristic that needs to be considered.

During the last two decades work has been going on at many centres to develop constitutive relationships for soils using the concepts of elasticity and plasticity. We will now examine the accuracy of current theoretical methods for settlement prediction first for elastic materials and secondly for plastic materials.

3.4 TOTAL SETTLEMENT ON ELASTIC SOILS

In the light of the above and in the context of settlement calculations 'elastic soils' are those whose response to a given change in effective stress is, for practical purposes, independent of the stress-path over the range of stresses encountered. Hence non-linear or irrecoverable behaviour does not necessarily preclude the use of elastic stress-strain formulations. An important corollary is that the total settlement on an elastic soil is the same for slow 'drained' loading as for undrained loading followed by consolidation. Wroth (1971) was able to demonstrate that the shear modulus G of undisturbed specimens of London Clay, while being a function of the mean normal stress and the overconsolidation ratio, is the same for drained and undrained tests. It is probable that a wide range of overconsolidated soils can be treated as 'elastic' for predicting settlements of foundations at normal factors of safety.

3.4.1 Homogeneous isotropic case: For an elastic isotropic soil skeleton the stress-strain behaviour in terms of effective stresses is fully defined by the effective Young's modulus E' and effective Poisson's ratio ν' . A drained one-dimensional test (eg oedometer test) on the material gives the volumetric compressibility:

$$m_v = \frac{1}{E^*} \left(1 - \frac{2\nu^*}{1-\nu^*} \right) \dots\dots\dots (3.8)$$

We can now examine the accuracy of the conventional one-dimensional method for calculating the total settlement of a uniform circular load* of radius a and intensity q, on a homogeneous isotropic elastic half space. The exact total settlement of the centre is:

$$\rho_{t(\text{exact})} = 2 q a \left(\frac{1-\nu^*}{E^*} \right) \dots\dots\dots (3.9)$$

For the conventional one-dimensional method:

$$\rho_{od} = \int_0^\infty m_v \cdot \Delta \sigma_z \cdot dh = 2 q a \cdot m_v \dots\dots (3.10)$$

Comparing the one-dimensional method with the exact method we get:

$$\frac{\rho_{od}}{\rho_{t(\text{exact})}} = \frac{1-2\nu^*}{(1-\nu^*)^2} \dots\dots\dots (3.11)$$

It is evident that $\rho_{od}/\rho_t > 0.9$ for $\nu^* < 0.25$. Davis and Poulos (1968) have extended the above analysis to soil layers of various depths and their results are shown in Fig 12. For most practical cases the conventional one-dimensional method will give total settlements which are within 10 per cent of the exact solution provided ν^* is less than about 0.3. There is considerable evidence to show that for many over-consolidated clayey soils, soft rocks and cohesionless materials $\nu^* < 0.3$ for the stress ranges involved (eg Wroth, 1971; Burland and Lord, 1969; Wong and Mitchell, 1975; Charles, 1976).

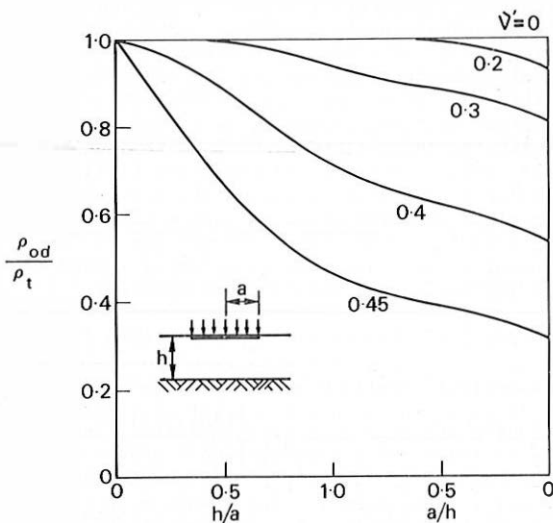

Fig 12 Relationship between ρ_{od}/ρ_t and a/h for a uniform circular load on an isotropic 'elastic' soil (Poulos and Davis, 1968).

3.4.2 Homogeneous cross-anisotropic elastic soil:

A legitimate criticism of much settlement theory is that it neglects the influence of anisotropy. Recent publications by Gerrard and Harrison (1970a and b)

*The conclusion also holds for other shapes of loaded area.

have given exact solutions for a variety of loading conditions on strips and circular areas on the surface of anisotropic soils. Hooper (1975) has presented a useful summary of the settlement of circular loaded areas on a cross-anisotropic medium.

As for the isotropic case we can examine the accuracy of the conventional one-dimensional analysis for estimating the total settlement of the centre of a uniform circular load on the surface of a cross-anisotropic half space (refer to Section 3.2.3 for the definition of the elastic parameters).

The exact total settlement is given by Hooper (1975):

$$\rho_t = 2 q a \frac{(1-\nu_{VH}^*)}{E_V^*} \cdot I_w \dots\dots\dots (3.12)$$

where I_w is a settlement influence factor. The expression for I_w is a complicated function of E_H^*/E_V^* , G_{VH}/E_V^* , ν_{VH}^* and ν_{HH}^* and will not be given here.

The relationships between I_w and E_H^*/E_V^* for various values of G_{VH}/E_V^* are plotted in Fig 13 for $\nu_{VH}^* = \nu_{HH}^* = 0$. The black square represents the isotropic condition.

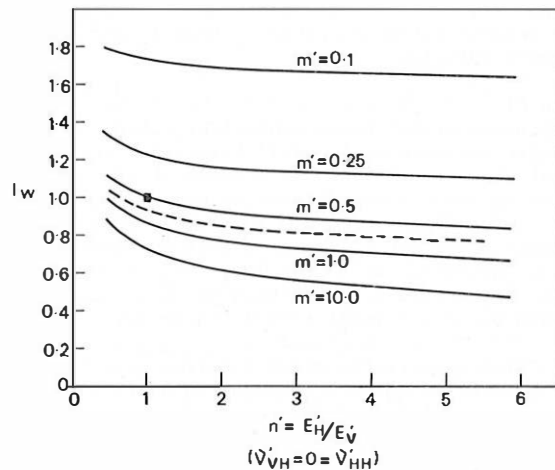

Fig 13 Settlement influence factor I_w for a uniform circular load on a cross-anisotropic 'elastic' soil.

It is evident that I_w is sensitive not only to E_H^*/E_V^* but also to G_{VH}/E_V^* . Values of E_H^*/E_V^* for soils appear to lie in the range of 0.5 to 5.0. However, as pointed out previously, there is almost no information on G_{VH}/E_V^* . I_w is also sensitive to Poisson's ratio. The dotted line in Fig 13 corresponds to $\nu_{VH}^* = 0.2$ and $\nu_{HH}^* = -0.25$ (with $m' = 0.5$) which are thought to be extreme values for London Clay (Hooper, 1975).

The conventional one-dimensional analysis based on the vertical Boussinesq stress distribution remains as given in equation (3.10). However, the volume compressibility from a drained one-dimensional test is:

$$m_v = \frac{1}{E_V^*} \left(1 - 2\nu_{VH}^* \cdot \frac{n'}{1-\nu_{HH}^*} \right) \dots\dots\dots (3.13)$$

Figure 14 shows the accuracy of various methods of calculating the total settlement. Curves (1) and (2)

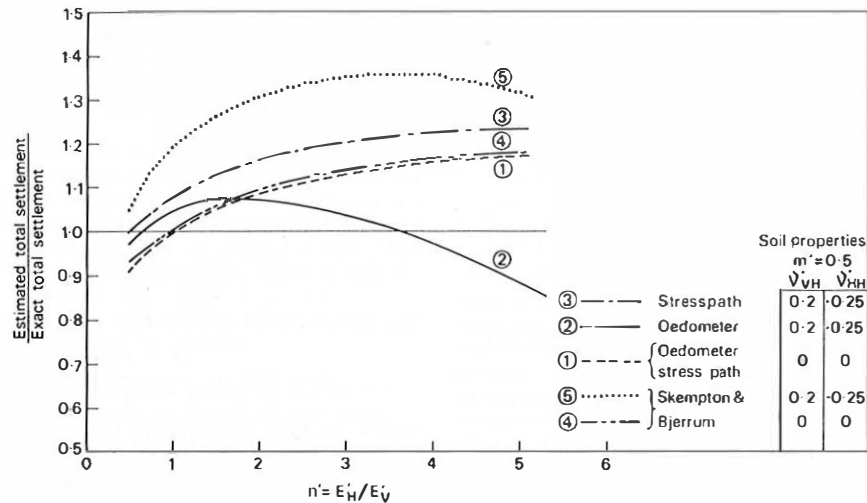

Fig 14 Accuracy of various methods of settlement analysis for a uniform circular load on a cross-anisotropic 'elastic' soil.

represent the relationship between ρ_{gd}/ρ_t for (i) $v_{VH}^e = v_{HH}^e = 0$, and (ii) $v_{VH}^e = 0.2$ and $v_{HH}^e = -0.25$, both for $m' = 0.5$. It is interesting to note that for $0.5 < n^e < 5$ the one-dimensional method gives results which are always within 15 per cent of the exact solution.

Curves (1) and (3) correspond to the simple elastic displacement method using equivalent values of the isotropic parameters E^e and ν^e determined from theoretical stress-path tests at a depth of $z/a = 1$ (following the recommendations of Davis and Poulos, 1968). For $v_{VH}^e = v_{HH}^e = 0$ the stress path method is almost identical to the classical one-dimensional method. However, for $v_{VH}^e = 0.2$, $v_{HH}^e = -0.25$ (curve 3) the stress path method is much less accurate than the one-dimensional method (curve 2).

We may also compare the exact solution with the prediction using Skempton's and Bjerrum's method. This requires a knowledge of the pore pressure parameter A which is given by the expression:

$$A = \frac{1 - 2 \nu_{VH}^e}{1 - 4 \nu_{VH}^e + (1 - \nu_{HH}^e)/n^e} \dots\dots\dots (3.14)$$

Knowing the relationship between μ and A (eg Scott, 1963 - Fig 6.15) the estimated values for the consolidation settlement $\rho_c (= \mu \cdot \rho_{od})$ are easily obtained. The estimated total settlement requires a knowledge of the undrained settlement ρ_u which is normally calculated using isotropic elastic displacement theory with the appropriate equivalent value of E_u (the undrained value of Young's modulus). Curves (4) and (5) in Fig 14 compare the estimated total settlements using the Skempton and Bjerrum method with the exact solutions. Like the stress-path method, the Skempton and Bjerrum method is less accurate than the classical one-dimensional method and tends to overpredict the total settlement. All the comparisons

* Curves 2, 3 and 5 give overestimates of settlement when $E_H^e/E_V^e = 1$ because the Poisson's ratios are anisotropic.

given in Fig 14 are for $G_{VH}/E_V^e = 0.5$. If, as seems likely, G_{VH}/E_V^e increases with E_H^e/E_V^e the overprediction of settlement by all the methods would be worse, but the classical one-dimensional method would still give the most accurate result.

3.4.3 Non-homogeneous elastic soil: In Section 3.2.2 it was concluded that non-homogeneity in the form of increasing stiffness with depth had only a minor influence on the vertical stress distribution. The reverse is true for settlement. For a given vertical stress the vertical strain at any depth is primarily dependent on E_V^e and G_{VH}^e . Hence unless the distribution of stiffness with depth is known, particularly near the underside of the foundation, there is little hope of accurate settlement prediction. A common form of non-homogeneity is one in which the stiffness increases linearly with depth such that $E^e = E^e + kz$. Carrier and Christian (1973) give the results of a parametric study of the settlement of a smooth rigid circular plate on such a material. Butler (1974) gives useful influence curves for the settlement of the corner of a uniformly loaded rectangle on the surface of this type of material.

The accuracy of the one-dimensional method for the above material may be assessed by comparing it with some numerical results obtained by Hooper (1975). Table II gives the calculated total settlements of the centre of a circular area of 15 m radius, loaded uniformly to 100 kN/m² and resting on a cross-anisotropic non-homogeneous elastic layer 97.5 m deep for which $E_V^e = 6.7 + 4.44z$ MN/m². The values of ρ_{od} were obtained using the Boussinesq vertical stress distribution.

TABLE II

$\frac{E_H^e}{E_V^e}$	$\frac{G_{VH}^e}{E_V^e}$	ν_{VH}^e	ν_{HH}^e	ρ_t (mm)	ρ_{od} (mm)
1	0.5	0	0	67.5	58.2
1	0.385	0.3	0.3	53.6	43.2
2.5	0.77	0	-0.35	62.8	58.2

It is evident that the classical one-dimensional analysis tends to underestimate the total settlement but is acceptable for practical purposes. An equivalent stress-path analysis or Skempton and Bjerrum analysis was not considered practical because of the number of layers that would have to be analysed to adequately account for the variation of stiffness with depth.

3.4.4 Conclusion: For soils which are approximately elastic in their response to monotonically increasing stresses, total settlements obtained from the classical one-dimensional method of analysis compare very favourably with values obtained from more sophisticated methods.

3.5 PROPORTION OF IMMEDIATE TO TOTAL SETTLEMENT ON ELASTIC SOIL

As pointed out by Burland and Wroth (1974) it is important to establish what proportion of the total settlement will occur before the finishes are applied to a building since it is usually the finishes which are damaged by settlement.

It is customary to use undrained elastic displacement theory to estimate the immediate settlements. Since we are only concerned with normal factors of safety the question of local yield will not usually need to be considered (Davis and Poulos (1968); D'Appolonia, et al (1971)). The accurate measurement of the undrained stiffness of a soil presents many problems. Moreover, it is difficult to take account of such features as non-homogeneity and anisotropy in any simple undrained analysis.

For elastic materials there are clearly defined relationships between the drained and undrained parameters which can be used to estimate the proportion of immediate to total settlement ρ_u/ρ_t . We will investigate this proportion for various conditions.

3.5.1 Homogeneous isotropic elastic soil: The shear modulus G is independent of the drainage condition so that:

$$\frac{E_u}{1 + \nu_u} = \frac{E_u}{1.5} = 2G = \frac{E^*}{1 + \nu^*} \dots\dots\dots (3.15)$$

Hence for any deep homogeneous layer the proportion ρ_u/ρ_t of any loaded area is:

$$\frac{\rho_u}{\rho_t} = \frac{1}{2(1 - \nu^*)} \dots\dots\dots (3.16)$$

Davis and Poulos (1968) have extended the analysis for uniformly loaded circular areas on soil layers of various depths and their results are given in Fig 15. Clearly ρ_u/ρ_t is dependent on the geometry of the problem. Similar results may be obtained for other shapes of loaded area.

3.5.2 Homogeneous cross-anisotropic elastic soil: The relationships between the drained and undrained parameters for a cross-anisotropic soil are much more complex than for the isotropic case and are given in full by Hooper (1975). For the special case of $\nu_{VH}^* = 0 = \nu_{HH}^*$ it can be shown that ρ_u/ρ_t for a uniformly loaded circular area on a deep layer is given by:

$$\frac{\rho_u}{\rho_t} = \frac{1}{[(1 + n^*)(1 + 2m^*/n^{*2})]^{1/2}} \dots\dots (3.17)$$

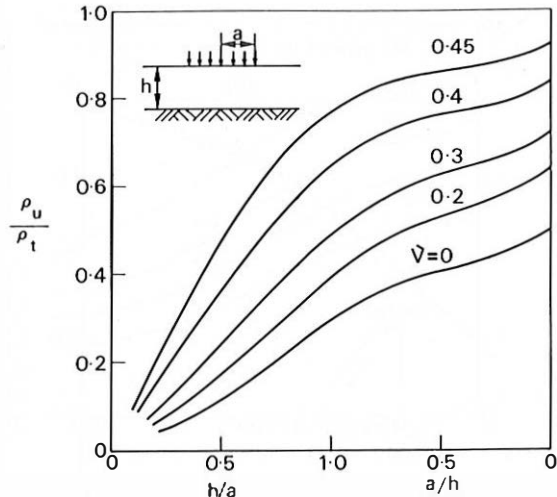

Fig 15 Relationship between ρ_u/ρ_t and a/h for a uniform circular load on an isotropic 'elastic' soil (Poulos and Davis, 1968).

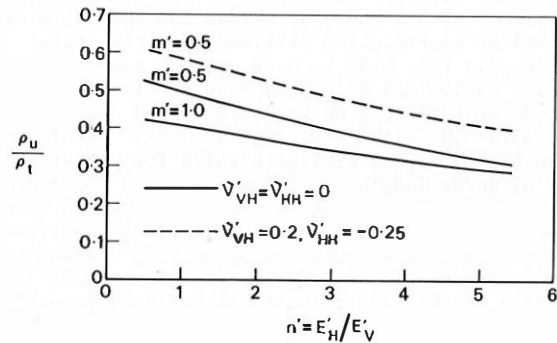

Fig 16 Relationship between ρ_u/ρ_t and E'_H/E'_V for a uniform circular load on a cross-anisotropic 'elastic' soil.

(See Section 3.2.3 for definitions). Figure 16 shows the relationship between ρ_u/ρ_t and n^* for $m^* = 0.5$ and $m^* = 1.0$. The dotted line is for $\nu_{VH}^* = 0.2$, $\nu_{HH}^* = -0.25$ and $m^* = 0.5$ (London Clay). It is evident that the effect of increasing anisotropy is to reduce ρ_u/ρ_t .

3.5.3 Non-homogeneous elastic soil: Burland and Wroth (1974) have studied the influence of increasing stiffness with depth on the ratio ρ_u/ρ_t for a rigid circular footing. Figure 17 shows the relationship between ρ_u/ρ_t and the measure of non-homogeneity E'_0/kD for various values of ν^* . As E'_0/kD decreases so does the value of ρ_u/ρ_t . It is of interest to note that the value of E'_0/kD for an average high-rise block of flats on London Clay appears to be about 0.1.

3.5.4 Discussion: For deep layers of overconsolidated soils the ratio ρ_u/ρ_t is unlikely to exceed about 0.7. For increasing non-homogeneity and anisotropy the ratio will decrease and may be as low as 0.25 in extreme cases. The ratio will also decrease as the relative thickness of the compressible layer decreases.

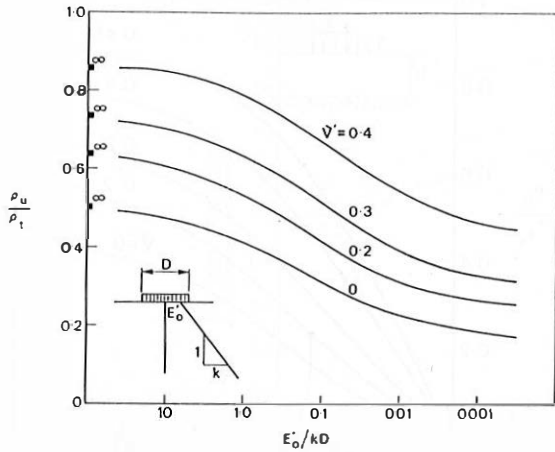

Fig 17 Relationship between ρ_u/ρ_t and E_o/kD for a rigid circular load on a non-homogeneous 'elastic' soil.

Simons and Som (1970) analysed 12 case records of settlement of major structures on overconsolidated clays and quoted a range of values for the ratio of the end of construction settlements to the total settlements from 0.32 to 0.74 with an average of 0.58. Morton and Au (1974) have studied eight case records of buildings on London Clay and quote a range of 0.4 to 0.82 with an average of 0.63. Breth and Amann (1974) report similar results for Frankfurt Clay as do De Jong et al (1971 and 1974) for a dense till. For most of these cases consolidation took place rapidly and the end of construction settlements ρ_i probably include some consolidation. These and many other data for stiff clayey soils support the findings of the elastic analyses outlined here.

3.6 THEORETICAL SETTLEMENTS ON SOFT YIELDING SOILS

For soft normally consolidated soils the elastic assumptions of stress-path independent behaviour are clearly not valid. Over the last two decades considerable progress has been made at Cambridge University and other centres on the development of constitutive relationships for soft clays using the concepts of work hardening plasticity. The detailed constitutive relationships for these ideal 'Cam-Clay' models are given by Schofield and Wroth (1968), Roscoe and Burland (1968) and Burland (1971) and will not be repeated here.

Figure 18(a) illustrates the behaviour of a sample of lightly overconsolidated 'ideal' clay undergoing one-dimensional compression. In keeping with classical soil mechanics the slopes AB and BC are characterised by the swelling index C_s and the compression index C_c respectively in the 'ideal' models. Attention should be drawn to the point B' in Fig 18(b) which corresponds to the preconsolidation pressure or 'yield' point B in Fig 18(a). B' lies on a 'yield locus' J'B'K' and provided the stress changes applied to the soil at its initial state A' do not fall outside J'B'K', the strains will be small. The existence of such a yield locus in natural soft clays is strikingly illustrated by Mitchell (1970) and Crooks and Graham (1976) and also by the well-defined values of p_c obtained from many careful investigations on the compressibility of soft clays.

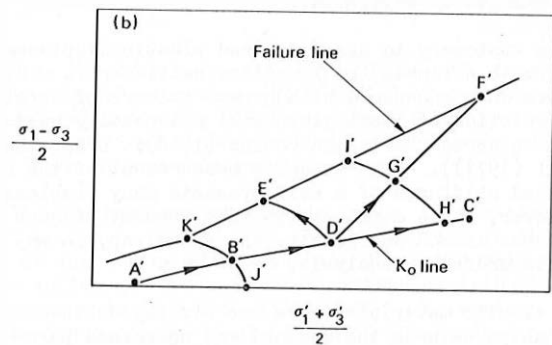
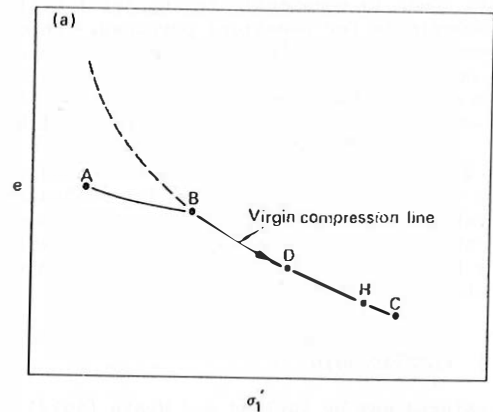

Fig 18

Bjerrum (1972) has discussed the existence of a 'critical' shear stress which governs when the structure of the clay starts to break down causing large settlements. There can be little doubt that he had in mind a form of 'yield locus' which is central to the 'Cam-Clay' model. Once the stresses cross the 'yield locus' large irrecoverable strains occur and the soil is said to be 'yielding'.

The model can be used for predicting strains and pore pressures developed during 'yielding'. For example, the stress-path A'B'C' in Fig 18(b) corresponds to the one-dimensional compression test and the ideal model gives reasonable predictions of the 'at rest' pressure coefficient K_o (and, of course, recovers the $e v \sigma'_1$ curve in Fig 18(a)). The stress-paths D'E' and H'I' correspond to predicted undrained tests following one-dimensional consolidation to D' and H' respectively. Voids ratio changes are obtained using the approach first outlined by Rendulic (1936) and shear strains are obtained from the incremental flow laws of plasticity. Thus for any known effective stress path (eg D'G'F') the volumetric and shear strains can be evaluated. The Cam-Clay model can be completely defined by the three parameters C_c , C_s and ϕ' , although it can be improved with additional parameters.

Simpson (1971), Naylor and Zienkiewicz (1971) and Ohta et al (1975) have illustrated the use of the model using the finite element method. Burland (1971) has successfully used the model to predict

pore pressures and vertical and lateral displacements beneath embankments on soft natural clays. Wroth and Simpson (1972) and Wroth (1976b) have successfully used the model to estimate the deformations and stability of embankments on soft natural clays. It appears that the Cam-Clay models provide a self-consistent and realistic idealization of many natural soft clays, at least for predicting pore pressures and displacements beneath vertically loaded areas.

Predicted values of consolidation settlement ρ_c obtained from the Cam-Clay model and ρ_{od} from the classical one-dimensional analysis have been found to be in good agreement for undrained factors of safety in excess of three (Burland, 1969a; Ohta and Hata, 1973). Experimental support for the conclusion that ρ_{od} is approximately equal to ρ_c for normally consolidated clay is provided by some model tests described by Burland (1971). Figure 19 shows the relationship between settlement and average footing pressure for two model strip footings. The results are compared with the one-dimensional analysis and 'Cam-Clay' predictions. For undrained factors of safety greater than about 3 the one-dimensional predictions are within 10 per cent of the measured settlements. Penman and Watson (1963) obtained very similar results from a tank test on soft silty clay.

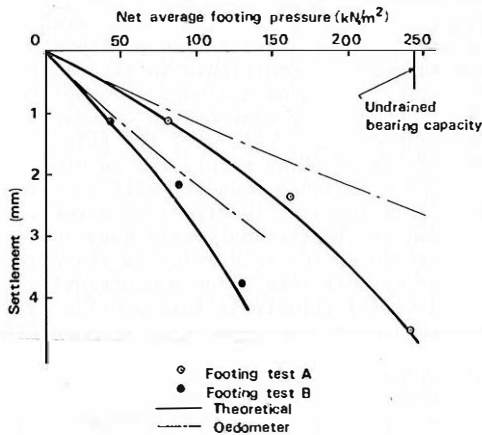

Fig 19 Predicted and observed consolidation settlements for model footings (Burland, 1971).

The explanation for this behaviour lies in the fact that as the soil is in a state of 'yield' it will tend to continue to deform one-dimensionally under the dominant influence of the in-situ 'at rest' pressures when the footing pressures are relatively low. It is of interest to note that, following large initial horizontal displacements, consolidation beneath the test embankment at Skå Edeby described by Holtz and Lindskog (1972) appears to be taking place approximately one-dimensionally.

So far we have considered 'elastic' soils and 'plastic' soils separately. However, the majority of soft soils exhibit a 'preconsolidation effect' (Bjerrum, 1972). Naylor (1971) has carried out a finite element settlement analysis for such a case using a Cam-Clay (critical state) model. Figure 20 shows the result of the analysis. It can be seen that prior to 'yield' the one-dimensional method is in excellent agreement with the analytical result and subsequently, during 'yield', tends to underpredict the settlement as noted previously.

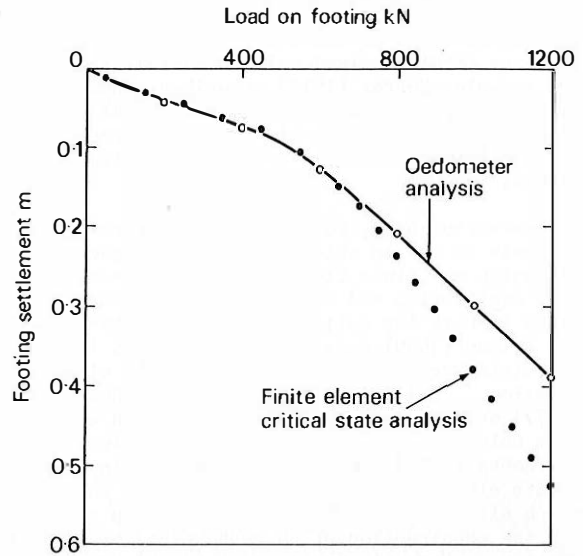

Fig 20 Predicted consolidation settlements of a lightly overconsolidated clay (Naylor 1971).

It will be noted that whereas for elastic materials we find that $\rho_{od} \approx \rho_t$ for yielding materials $\rho_{od} \neq \rho_c$. In order to calculate ρ_u it is necessary to measure the undrained stiffness E_u and Simons (1974) has stressed the difficulties of making an accurate determination. He also shows that resort to empirical correlations with the undrained strength c_u is unreliable since values of E_u/c_u have been found to lie between 40 and 3000 (see also D'Appolonia et al, 1971). From a practical point of view the difficulty of estimating ρ_u will not normally be of great concern because generally it will be only a small proportion of the total settlement.

Simons and Som (1970) have reviewed nine case histories of buildings on normally consolidated clays and find ratios of the settlement during construction to the total settlement ranging from 0.077 to 0.212 with an average of 0.156. Since significant consolidation may well have taken place during construction it is probable that the value of ρ_u/ρ_t will normally be less than 0.1 for soft clays.

3.7 RATE OF SETTLEMENT

The time-settlement behaviour of foundations has been thoroughly treated by a number of authors particularly at the previous two Conferences of this International Society (Scott and Ko, 1969; de Mello, 1969; Poorooshasb, 1969; and Gorbunov-Possadov, 1973). It is outside the scope of this Review to attempt to deal with this question in detail.

As regards the prediction of consolidation settlements the solutions given by Davis and Poulos (1972) and Schiffman and Gibson (1964) are sufficient for most routine practical purposes. For more complex non-homogeneous or non-linear problems resort must often be made to some form of numerical analysis.

Schiffman et al (1969) discuss alternative forms of analysis and give numerous references to specific problems. The simpler type of solution is one in

which the equations governing the diffusion of the pore fluid are not coupled to the equations governing the deformations of the soil. Solutions of this type are readily solved using numerical techniques. For example, Murray (1973) describes a numerical method for predicting the two-dimensional consolidation of multi-layered soils for a wide range of loading conditions and non-linear consolidation parameters.

The more realistic, but much more difficult, type of analysis is one in which the equations governing deformation and fluid flow are linked in such a way that equilibrium and continuity are satisfied at all times in both the solid and the fluid phases. Sandhu and Wilson (1969) were amongst the first to propose a satisfactory three-dimensional finite element formulation. Following these procedures Hwang et al (1971) obtained excellent agreement with some closed form solutions for a porous elastic medium. Smith and Hobbs (1976) have developed a non-linear elastic finite element program, based on Biot's equations, which allows for simultaneous changes in geometry (eg the construction of an embankment) and soil properties. Recently Small et al (1976) have developed a finite element method of analysing an elasto-plastic permeable material with cohesion and friction. The method is used to study the behaviour of a strip footing loaded to failure at different rates.

These developments are exciting and offer valuable insight into the mechanisms of behaviour during consolidation. However, inspite of the rapid theoretical developments taking place the reliability of predictions of the rate of settlement of foundations is poor. The main source of error is in the determination of the in-situ permeability of the soil. Frequently measured rates of settlement of structures are very much higher than predicted even when two- and three-dimensional theories are used.

Rowe (1968 and 1972) demonstrates that the permeability of a deposit is significantly dependent on its fabric. Thin layers of sand and silt, roots and fissures can result in the overall in-situ permeability being many times greater than that measured on routine samples in the laboratory. Disturbance of the soil during sampling may further reduce its natural permeability.

Rowe and Barden (1966) developed an hydraulic oedometer to enable more reliable measurements of the permeability k and coefficient of consolidation c_v to be made. The use of in-situ permeability tests coupled with laboratory values of compressibility appear to give reasonable values of c_v . Lewis et al (1976) compare observed consolidation histories of seven embankments with predictions using this approach and obtain remarkably good agreement when predictions based on routine laboratory tests overestimate the time by up to a factor of 20. Reference should be made to the proceedings of the Conference on In-Situ Investigations in Soils and Rocks, London, 1970, for a full discussion on the in-situ determination of the consolidation characteristics of soils.

Simons (1974) has discussed the problem of secondary compression at some length and referred to the most recent work on the topic. Mesri (1973) has discussed many of the factors influencing the coefficient of secondary compression. From a practical viewpoint there is as yet little that can be added to the

traditional highly empirical procedures of determining the coefficient of secondary consolidation c_{α} from oedometer time-settlement curves. Crawford and Sutherland (1971) give details of one of the longest records of building settlements known to exist and obtain good correlation between the observed secondary settlement and those computed from laboratory tests. Leonards (1973) draws attention to some of the implicit assumptions made in achieving this correlation.

Progress is being made on the theoretical aspects of secondary compression and consolidation. An instructive paper by Hawley and Borin (1973) should help to clarify certain misconceptions about secondary compression. It is important to distinguish between 'compression' and 'consolidation'; compression being a property of the soil skeleton and consolidation resulting from the flow of fluid through the voids of the soil. Any tendency for the soil skeleton to compress whether it is due to the action of increased effective pressure or creep in the skeleton will cause the pore fluid to be expelled thereby creating a pore pressure gradient.

In the past 'secondary consolidation' has often been described as compression that continues after the excess pore pressures have dissipated. This can be misleading. Secondary compression can clearly take place in the presence of an excess pore pressure gradient and indeed will contribute to its cause. For thin laboratory specimens drainage takes place rapidly and little secondary compression occurs during 'primary' compression. However, for thick layers of clay drainage takes place slowly and an element some distance from a drainage boundary will experience a relatively slow increase in effective stress. If the soil skeleton is significantly rate dependent secondary compression of the same order as the primary compression may well take place concurrently. Berre and Iversen (1972) illustrate this process with some excellent laboratory experiments on Drammen clay.

Mathematical models have been developed to handle one-dimensional consolidation involving time-dependent and rate sensitive compression (Suklje, 1963 and 1969; Garlanger, 1972; Berry and Poskitt, 1972; Hawley and Borin, 1973). Garlanger (1972) has developed a numerical procedure for handling the time dependent compression of the types described by Bjerrum (1967). The method gives remarkable agreement with the overall strains and mid-plane pore pressures measured by Berre and Iversen (1972) and Garlanger further obtains good estimates of the settlement-time histories of three buildings on Drammen clay.

Inspite of these developments the engineer is still faced with a difficult problem in attempting to estimate the amount of secondary compression. It is by no means certain, indeed it is most unlikely, that all soft clays have similar characteristics to the Drammen clay (Leonards, 1972). A laboratory determination of a preconsolidation pressure which is significantly greater than the previous maximum overburden pressure is no guarantee that the soil will exhibit large delayed compressions. Simons (1974) concludes that the best guide to the form and magnitude of secondary compression is still local experience.

3.8 SETTLEMENT OF GRANULAR MATERIALS

The engineer is presented with a dilemma when estimating settlements on granular materials. Over the last decade a number of procedures have been developed and it is a difficult task for the general practitioner to decide which one to use. Current techniques are based on plate loading tests, Standard Penetration Tests or Static Cone Tests. No attempt will be made to summarise all the methods as this has been done very thoroughly by Sutherland (1974). However, it seems appropriate to make a few general observations.

At the present time no reliable method appears to exist for extrapolating the settlement of a standard plate to the settlement of a prototype footing (D'Appolonia et al, 1968; Sutherland, 1974). However the use of plate tests at various depths to evaluate the stiffness profile, though expensive, is likely to be more successful (Sohmertmann, 1970; Janbu, 1973). The development of these and other direct methods of measuring compressibility at depth is an important task.

The interpretation of penetration test results has a number of inherent difficulties. In the first place they do not readily reflect the stress-history (and hence the in-situ stresses) of the site - a factor which has a major influence on compressibility (de Mello, 1971 and 1975; Rowe, 1974 and Leonards, 1974). Moreover, penetration tests give notoriously erratic results as do small plate loading tests. Hence any attempt at correlation requires rigorous statistical analysis (de Mello, 1971). Yet few authors do more than plot representative values of one variable against representative values of the other often without even stating how these representative values were obtained (ie mean, lower limit etc). A notable exception is the paper by Schultze and Sherif (1973). Their very thorough analysis of settlement data certainly deserves close study.

The present unsatisfactory 'state of the art' is adequately portrayed in Simons and Menzies' (1975) book in which various methods are used to calculate the settlement for a simple illustrative example. The six most up-to-date procedures give settlements ranging from 5 mm to 28 mm even when the representative penetration results are stipulated. Presumably the range would be even wider in practice where the engineer has, in addition, to interpret the data from the penetration tests.

In these circumstances it seems appropriate to go back to the available field measurements of settlement to see whether a simpler picture emerges which is less dependent on quantitative correlations with erratic penetration tests.

Adopting this very simple approach the results of a large number of settlement observations on footings and rafts have been plotted in Fig 21 as settlement per unit pressure (ρ/q) against B. In each case the sand is broadly classified as loose, medium dense or dense either on the basis of a visual description or the average SPT value. The following references were used in assembling the data: Bjerrum and Eggestad (1963), Parry (1971), Davisson and Salley (1972), Garga and Quin (1974), Morton (1974) and Schultze and Sherif (1973). The points in Fig 21 which are connected by thin full lines are for different sizes of

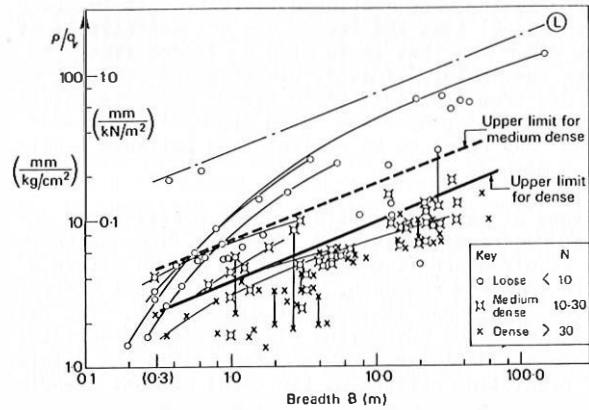

Fig 21 Observed settlement of footings on sand of various relative densities.

foundation at the same site - all of them quoted by Bjerrum and Eggestad.* No account has been taken of such factors as the water table, depth of loaded area and geometry. These factors, which are included by Schultze and Sherif together with Meigh's (1975) suggestion that the settlement is influenced by grain size and grading, probably contribute to the spread of results.

As is to be expected there are no clear boundaries between the three relative densities. Nevertheless, it is possible to draw reasonably well defined empirical upper limits for dense sands and medium dense sands as shown by the full line and dotted line respectively in Fig 21. It would be unwise to attempt to define equivalent 'average' relationships as the data are probably not representative. However the spread of the results should aid the engineer in deciding what proportion of the upper limit settlements he will use for a particular analysis or design. For example, when calculating a 'probable' settlement he may elect to work to half the upper limit values in which case the likely maximum settlement will not normally exceed about 1.5 times the 'probable' value. The assumption that ρ is proportional to q is often surprisingly accurate but engineers using the method should ensure that the pressures do not exceed the limit of proportionality.

Considering the wide variety of sources and quality of data the scatter of the results, particularly for the medium dense and dense materials, is remarkably small. It would be premature to treat the uppermost curve (marked L) in Fig 21 as an 'upper limit' line for loose sands. Much of the data relate to a fine slightly organic sand with a porosity of 45 per cent (Bjerrum and Eggestad, 1963), which is certainly very loose. Such a material would not normally be used for founding a building on without treatment. Curve L may be useful in the preliminary assessment of the settlement of structures such as storage tanks on loose sand.

The difficulties of extrapolating the settlement of a standard plate (0.3 m) to the settlement of a proto-

* Case 2 from Bjerrum and Eggestad's paper is described as 'dense', but this is thought to be anomalous as the results are in such good agreement with others described as 'loose'.

type footing were mentioned earlier. It is clear from Fig 21 that the trends are not established at $B = 0.3$ m and that tests with $B = 1$ m are likely to be more successful. Indeed, plotting the measured value of ρ/q from a plate test on Fig 21 and extrapolating the constant proportion to an appropriate 'trend' line* may prove to be a simple and reliable prediction method.

Figure 21 may prove useful to the practitioner engaged on routine design. If a more rigorous analysis is required Schultze and Sherif's method offers a more complete approach. Their statistical analysis gives confidence limits of ± 40 per cent. The following remarks by Sutherland (1974) seem appropriate: 'Before a designer becomes entangled in the details of predicting settlement (in sand) he must clearly satisfy himself whether a real problem actually exists and ascertain what advantages and economies can result from refinements in settlement prediction'.

It will be noted that little has been said about silts. There can be no question that loose silts are difficult foundation materials and Terzaghi and Peck (1967) remark that they are even less suitable for supporting footings than soft normally consolidated clay. For medium and dense silts the procedure recommended by Terzaghi and Peck is to treat the non-plastic types in the same way as for sands and those with plasticity as for clays.

3.9 CONCLUDING REMARKS

The main object has been to examine the accuracy of the traditional simple methods of settlement analysis for foundations having a factor of safety ≥ 2.5 against general bearing capacity failure. The detailed discussion has been of a theoretical nature as it has been necessary to deal with complex material behaviour. However the conclusions are simple and practical:

(1) For a wide range of conditions including non-homogeneity, non-linearity and anisotropy the changes in vertical stress are given with sufficient accuracy by the Boussinesq equations. The stresses may however be grossly in error when there is a stiff overlying layer or for anisotropic properties in which G_{VH}/E_V differs significantly from the isotropic value. Stress distributions for open excavations and lateral non-homogeneity require further study.

(2) Horizontal stress changes are very sensitive to a number of variables and are difficult to estimate reliably.

(3) For soils which are approximately 'elastic' in their response to vertical loads (ie the total settlement is stress-path independent - see Sections 3.3 and 3.4) the simple classical one-dimensional method of analysis can be used to calculate the total settlements as accurately as many of the more sophisticated current methods. For these soils the undrained settlement will usually be between $2/3$ and $1/3$ the total settlement.

* It is possible that the initially steeper 'trend' lines relate to normally consolidated sands, while the flatter, straighter ones relate to overconsolidated sands.

(4) For soft 'yielding' soils it appears that the classical one-dimensional method of analysis can be used to calculate the consolidation settlements with sufficient accuracy. The undrained settlements are difficult to estimate but in any case they are unlikely to exceed 10 to 15 per cent of the total settlement.

(5) It will be noted that we have been concerned with analysis and not testing procedures which is outside the scope of this Review. Nevertheless, the two are intimately linked and it can be concluded that testing should be aimed at establishing accurately the simple in-situ parameters. The most important appear to be the one-dimensional compressibility m_v or the equivalent effective vertical Young's modulus E'_v and the variation with depth. There can be little hope of obtaining an accurate estimate of total settlement without this information.

(6) Although the use of simple parameters is recommended their determination may be difficult and complex. Compressibility is usually very sensitive to the in-situ stress condition, stress changes and sample disturbance. For soft clays Bjerrum (1972) has outlined procedures for carrying out oedometer tests.

(7) For stiff materials the situation is far from clear as it is very difficult to obtain undisturbed samples and the in-situ stress conditions are difficult to estimate accurately. Moreover in Section 3.4.2 it was shown that the value of G_{VH} , which is seldom measured, is at least as important in its influence on settlement as E_H . In these circumstances there appear to be many advantages in developing in-situ methods of determining the deformation parameters. For example, in-situ plate loading tests carried out at various depths include the influence of the in-situ stresses and of G_{VH} and E_H and this may be an important factor in explaining why such tests often give much higher values of E'_v than laboratory determinations* (eg Marsland, 1971; Gorbunov-Possadov and Davydov, 1973; Burland, 1973) - see also Section 6.3 of this Review.

(8) For granular materials there is a need to re-appraise present methods of settlement prediction based on probing tests employing rigorous statistical methods. The work of Schultze and Sherif (1973) is promising in this respect. For large projects methods based on the direct measurement of compressibility (eg loading tests or large plate tests) are probably the most reliable. For routine work the use of the empirical results assembled in Fig 21 is simple and probably accurate enough.

CHAPTER 4 - PILE FOUNDATIONS

4.1 DESIGN PRINCIPLES

Chapter 4 is concerned with methods of calculating settlements of single piles and pile groups at applied loads which are less than half to one-third the ultimate bearing capacity. The ultimate bearing capacity

* Preliminary analysis of in-situ measurements suggest that in London Clay G_{VH}/E_V is significantly greater than the equivalent isotropic value (Cooke, 1976 - Private communication).

of piles is not dealt with in this Review. Neither is the behaviour of piles under lateral load which was dealt with at the 5th European Conference in Madrid (1972). It should perhaps be emphasised in passing that in many cases where pile supported structures have been damaged the cause can be traced to faulty workmanship during installation. For example cast-in-situ piles have been damaged by necking of the concrete during the withdrawal of the protective casing. Spliced timber piles have in several cases separated due to the heave caused by the driving of adjacent piles (Massarch, 1976). Similarly heave has also lifted driven piles so that settlements occurred when the structure was erected.

Many pile groups are still designed today (1977) as if the piles act individually as struts with little or no allowance for the contribution made by the soil between the piles. The settlement is normally calculated from the assumption that end bearing piles are rigidly supported at the toe and that floating piles are rigidly supported at the centre or the lower third point.

Part of the reluctance of the designer to utilize the soil between the piles in a pile group has been the limited knowledge of the interaction of the individual piles in a pile group and the soil enclosed by the piles and how consolidation and creep etc in the soil affects this interaction. It is well known that the remoulding of the soil that takes place during driving in particularly sensitive clay or the compaction caused by pile driving in cohesionless soils can have a pronounced effect on the behaviour of friction piles as pointed out, for example, by Meyerhof (1959).

In the design of pile foundations it is important to know the properties of the soil both above and below the foundation level. The properties above the foundation level are important because of the difficulties which can be encountered during installation (for example the driving of steel, timber and precast concrete piles). Dynamic and static penetrometers are used extensively, particularly in Europe, to determine the length and the bearing capacity of end bearing piles and of friction piles. In cohesionless soils it is also possible with dynamic penetration tests, to get an indication of the driving resistance of piles. Vane tests are commonly used to determine the bearing capacity of friction piles in fine-grained cohesive soils. For large diameter bored piles plate load and pressiometer tests are used frequently to predict the settlements because of the high bearing capacity of such piles and the high costs of a load test. The bearing capacity of driven piles is frequently checked with load tests as discussed by Pellenius (1975).

4.2 PILES AS 'SETTLEMENT REDUCERS'

In many situations the decision to use piles is taken, not because of a lack of bearing capacity in the near surface strata, but because the settlements of footings or rafts are deemed to be too large. The purpose of such a piled foundation is to decrease settlements to tolerable amounts and they may therefore be termed 'settlement reducing piles'. Frequently it is only necessary to reduce the settlements slightly or locally to avoid damage to the superstructure as pointed out by Simons (1976). In these circumstances the settlements will often be sufficient to mobilize the full load-carrying capacity of a pile. Hence, in

order for piles to act economically as 'settlement reducers' their load-settlement behaviour should be such that relatively large settlements can be accepted without a significant reduction in load carrying capacity, ie their behaviour should be 'ductile'.

The ductility of piles which have been driven to a stratum such as bedrock or dense gravel is low, especially if the piles are of prestressed concrete, as the compressive strength of the pile material (pile failure) will probably be exceeded if the pile is forced to settle significantly. However, the ultimate bearing capacity of floating piles is normally governed by the strength of the surrounding soil (soil failure) and the load-carrying capacity does not usually decrease sharply even when the settlement of the pile is large. In this case it should be possible to carry a substantial part of the vertical applied load from a pile cap or raft in the soil between the piles. It is however essential that there should be suitable factors of safety against failure of the pile section and failure of the pile cap or superstructure in case the soil has a greater shear strength than predicted.

The number of piles which are required to reduce the settlements to an acceptable level will often be relatively small and hence the spacing of the piles within a given pile group can in that case be large. The group action will be less pronounced compared with a conventional pile foundation where the spacing of the piles is relatively small.

Traditionally engineers engaged in pile group design have asked themselves 'How many piles are required to carry the weight of the building?'. When settlement is the conditioning factor in the choice of piles designers should perhaps be asking the question: 'How many piles are required to reduce the settlements to an acceptable amount?' The number of piles in answer to the second question is invariably significantly less than in answer to the first question, provided it is accepted that the load-carrying capacity of each pile will probably be fully mobilized.

This design approach using piles as settlement reducers still has to be fully developed and will not be pursued further in this Review. Besides the prospect of considerable savings it has the merit of encouraging the engineer to examine closely the basis of a decision to use piles. The use of piles as settlement reducers should also help to resolve the difficult problem of pile design at the base of excavations (Simons, 1976).

4.3 SETTLEMENT OF PILES - GENERAL CONSIDERATIONS

Several methods have been developed to calculate the settlement of single piles and of pile groups. The settlement and load distribution of structures supported by end bearing piles is often calculated from the assumption that the soil located above the pile point does not affect the settlements or contribute to the bearing capacity. The settlement of groups made up of friction piles is often calculated using traditional methods in which the stress increase is determined from elastic theory and the compressibility of the soil is evaluated from laboratory or in-situ tests. The axial deformation required to mobilize the shaft resistance of a single pile is small (a few millimetres) compared with the end resistance. Therefore the settlement of a single friction pile

will often be small compared with an end bearing pile at the same relative load (Q/Q_{ult}). The settlement ratio (the settlement of the pile group compared with the settlement of a single pile for a given load per pile) will on the other hand be larger for friction piles than for end bearing piles.

The settlement of single piles and of pile groups can be analysed (Poulos, 1974 a) by methods based on:

- theory of elasticity (Mindlin, 1936);
- step integration using data from load tests (Coyle and Reese, 1966);
- finite element analysis (eg Ellison and d'Appolonia, 1971; Naylor and Hooper, 1975).

In the elastic methods based on Mindlin's equations it is assumed that the soil behaves as an ideal elastic material with a constant modulus of elasticity and a high tensile strength. This approach has been used by eg d'Appolonia and Romualdi (1963), Thurman and d'Appolonia (1965), Poulos and Davis (1968), Mattes and Poulos (1969) and Poulos and Mattes (1969). These methods normally do not take into account the slip that can take place along the shaft even at relatively low load levels or the low tensile strength of the soil as pointed out by Ellison et al (1971) and Boulon et al (1976). Both factors affect the stress distribution in the soil and thus the soil-pile interaction. The group effect is as a result overestimated. The real settlement of the pile group will normally be less than that estimated from load tests on single piles and extrapolated using the group settlement ratio calculated from elastic theory.

The step integration method by Seed and Reese (1957) and by Coyle and Reese (1966) is based on the assumption that the movement of a point at the surface of a pile depends only on the shear stress at that particular point and that the stresses elsewhere do not affect the movement (Poulos, 1974).

In the finite element method non-linear and time-dependent stress-strain relationships can be considered. For routine work it is today (1977) only practical to solve two-dimensional or axially-symmetric problems due to the high costs of three-dimensional programs.

The method used for the installation of the piles will have a pronounced effect on the settlements. Pile driving and excavation affect the initial stress conditions in the ground as well as the compressibility of the soil. Also the construction sequence is important. Heave and the settlement will be reduced if piles are installed before the excavation (Butler, 1974). It is necessary to consider these changes when the settlements are calculated. The settlement of pile groups is sometimes evaluated from load tests on single piles. Such load tests can sometimes be misleading since the settlement of a pile group is affected by the load transfer along the piles. The group settlement factor is also affected by soil type, size and shape of the pile group and the method of construction as pointed out by Leonards (1972). The present knowledge about the effects of these and other factors is very limited. Further studies of particularly well instrumented full size pile groups are needed (Koizumi and Ito, 1967).

4.4 SINGLE PILES

The settlement ρ_s of a single pile in an elastic

medium can according to Poulos and Davis (1968) be evaluated from the relationship:

$$\rho_s = \frac{Q}{LE_s} I_p \dots\dots\dots (4.1)$$

where L is the pile length; E_s is the modulus of elasticity of the soil; and I_p is an influence factor which is a function of the relative pile length L/D . An average value of 1.8 can be used for routine estimates. The deflection will thus decrease with increasing pile length. Poulos (1974) points out that the load-settlement relationship is substantially linear up to 50 to 70 per cent of the failure load when the L/D ratio is larger than 20. It should be emphasised that the shear stress is not uniformly distributed along the pile and that the shear strength of the soil can locally be exceeded even when the applied load is relatively low.

Numerical methods have also been developed where the stress-strain properties determined by triaxial tests are used in the analysis (Coyle and Reese, 1966). Also the results from pressiometer tests have been used to calculate the settlements of single piles (Gambin, 1963; Cassan, 1966 and 1968).

The shape of a pile affects its settlement. The settlement of a bored pile with an enlarged base will be larger at the same relative load (Q/Q_{ult}) than that for a pile without an enlarged base as pointed out by Whitaker and Cooke (1966). At the same applied load the settlement will decrease with increasing diameter of the base. This effect decreases with increasing pile length. The effect is small when the L/D ratio is larger than about 25 as has been shown by Poulos and Davis (1968) and by Mattes and Poulos (1968). For a given degree of mobilization of the shaft resistance the settlement increases with the shaft diameter. The shear resistance is mobilized fully when the settlement is 0.5 to 1.0 per cent of the shaft diameter. The settlement, when the base resistance is fully mobilized, corresponds to 10 to 15 per cent of the base diameter.

The settlement for bored piles with enlarged bases can be estimated from the following semi-empirical relationship:

$$\rho_s = \frac{0.02 q_b D_b}{q_{ult}} \dots\dots\dots (4.2)$$

where q_b is the contact pressure at the base and D_b is the base diameter (Burland et al, 1966; Burland and Cooke, 1974). It has been assumed that the pile length is at least six times the diameter of the base. Normally the settlement is large enough to fully mobilize the shaft resistance. The given relationship represents an upper limit. With good supervision and workmanship the settlement can be reduced to about half of that calculated from eq (4.2).

4.5 PILE GROUPS IN COHESIVE SOILS

The settlement of a pile group in clay will generally be much larger than the settlement of a single pile at the same pile load. The initial settlement of a pile group is often calculated from elastic theory using a modulus of elasticity, which is either constant or varies linearly with depth.

For a driven pile high excess pore water pressures develop in soft normally consolidated clays during

driving. These pore water pressures can locally exceed the total overburden pressure close to a pile. The local excess pore water pressures dissipate rapidly with time due to the local radial cracks which develop around the piles as reported by d'Appolonia and Lambe (1971) and by Massarsch (1976). The radial cracks close when the pore water pressure corresponds to the total initial lateral pressure in the soil.

The undrained shear strength of the clay around the driven piles increases gradually with time as the water content gradually decreases. Piles in soft normally consolidated clay will with time be surrounded by a shell of medium to stiff clay which increases the effective diameter of the piles and reduces both the initial and the time dependent settlements. The reconsolidation of the soil is normally completed after 1 to 3 months for precast concrete piles and after about one month for timber piles. Considerably shorter time is generally required for overconsolidated clays. The disturbance caused by pile driving extends only a few pile diameters below the pile points. When the group effect is calculated the properties of the undisturbed soil below the pile group should be used in the analysis.

The initial settlement of friction piles in a deep layer of normally or slightly overconsolidated clay is generally small in comparison with the time dependent settlement (often less than 25 per cent of the total settlement). The initial settlement for overconsolidated clays can on the other hand exceed 75 per cent of the total settlement of a pile group. Calculations based on elastic theory indicate that even for a large pile group the initial settlement is between 60 and 70 per cent of the total settlement (Poulos, 1968). This has been substantiated by measurements reported by Morton and Au (1974).

The time-dependent settlements due to consolidation of the soil mainly below the pile group occur rapidly when the soil is overconsolidated. However, Booker and Poulos (1976) suggest that the time dependent settlement due to creep can be large even when the settlement due to consolidation is small.

4.5.1 The use of the settlement ratio: The initial settlement of a pile group in clay is often predicted by means of settlement ratios obtained from methods based on the theory of elasticity (Davis and Poulos, 1968 and 1972; Poulos, 1968; Mattes and Poulos, 1969; Butterfield and Banerjee, 1971a, and 1971b; and by Banerjee, 1975, 1976). Poulos (1968) found that the settlement of a single pile in an elastic medium at $L/D = 25$ is increased by about 45 per cent by an adjacent pile at the same depth when the pile spacing is $5D$ and by about 65 per cent at $2D$ as shown in Fig 22. The settlement of a pile group can therefore be calculated by superposition. Doroshkevich and Bartolomey (1965) have used Mindlin's solution to analyse the settlement of six pile-supported structures in the USSR. The agreement between measured and calculated settlements was good. The authors did not describe how the different parameters were evaluated which were used in the analysis. On the other hand load tests on two carefully instrumented piles in London Clay (Cooke and Price, 1973; Cooke, 1974) indicate that the group effect is considerably less than that calculated by the homogeneous elastic method. The spacing of the piles was three pile diameters. The settlement ratio was

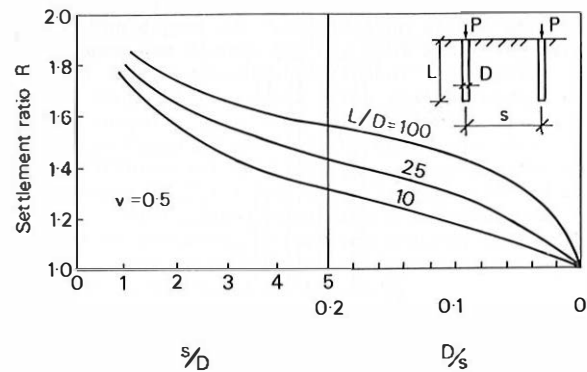

Fig 22 Settlement ratio for pile groups (Poulos, 1968)

approximately 1.2 compared with a calculated value of 1.6. Cooke (1974) pointed out that the theoretical analysis tends to overestimate the interaction between the piles.

Two cases are normally considered when the settlement of a pile group is calculated. In the first case the load on all the piles is equal (flexible pile cap). The settlement of the different piles can then be calculated from Fig 22. The second case is when the settlement of all the piles is equal (rigid pile cap) and a number of simultaneous equations then have to be solved. The settlement determined from a load test on a single pile cannot strictly be used in the calculations because the settlement of a single pile is mainly governed by the deformation properties of the disturbed zone around a pile and by local slip while the group effect is mainly governed by the deformation properties of the undisturbed soil around and below the pile group. Hence considerable caution is needed in applying the results of tests on single piles.

The settlement of a pile group at a given total load depends mainly on the width of the pile group. The settlement ratio increases with decreasing pile spacing, with increasing number of piles in the pile group and with increasing pile length. For pile groups with more than about 16 piles the settlement ratio will increase approximately with n , where n is the number of piles in the pile group at a given pile spacing. An analysis indicates that the stiffness of the piles and of the pile cap as well as the number of piles in the pile group has only a small effect on the settlement ratio. In order to decrease the settlements, it is better to increase the spacing of the piles and the pile length than to increase the number of piles without changing the size of the pile cap.

4.5.2 Consolidation settlements: The time dependent settlements are normally calculated as indicated in Fig 23. It is generally assumed in the calculations that the load in the pile group is transferred to the underlying soil at the lower third point and that the load is distributed uniformly over an area enclosed by the pile group. The load distribution below the third point is often calculated by the Boussinesq's equation or by the 1:2-method. The soil below the lower third point is divided into layers. The compression of each layer is then calculated separately. The total settlement corresponds to the sum of the settlement of the different layers. The

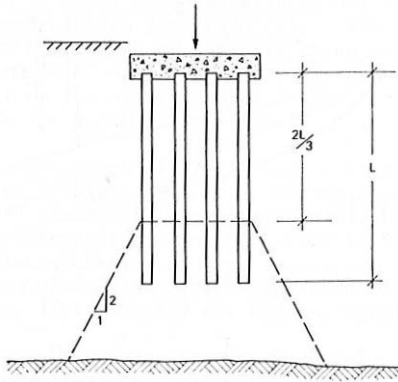

Fig 23 Calculation of the time-dependent settlements

compressibility of the soil below the pile group will thus have a large effect on the settlements. If a compressible layer is located below the piles the settlement of the pile group can be even larger than that of a spread footing located at the ground surface.

Bjerrum et al (1957) and Yu et al (1965) report that the actual settlements have exceeded the settlements calculated by the method described above. The agreement improved when the applied load was assumed to be transferred to the bottom of the pile group. Similar results have also been reported by Girault (1972) for several buildings in Mexico City. Clearly the mechanism of load transfer to the surrounding soil depends on the soil profile. For pile groups where the individual piles have been driven through a layer of soft normally consolidated clay (say) into a layer of stiff clay most of the load will be carried by the stiff clay close to the bottom of the piles. A similar load distribution will be obtained when the compressibility of the soil decreases with depth or the thickness of the compressible layer below the pile group is small (less than the width of the pile group or the length of the piles). For small pile groups where the width is less than the pile length and the compressibility of the soil is approximately constant with depth, the load in the piles will be transferred to the surrounding soil more uniformly with depth.

Davis and Poulos (1972) show that the settlement of a pile group is affected by the pile cap. Calculations by Butterfield and Banerjee (1971b) assuming elastic behaviour indicate that 20 to 60 per cent of the applied load will normally be transferred from the pile cap to the soil between the piles. The part carried by the soil between the piles will increase with increasing size of the pile group and with increasing pile spacing.

Hightand Green (1976) report that for a 70 m high office building in London which is partly supported on a raft and partly on cast-in-place bored piles in the London Clay that about 65 per cent of the dead load was carried by the piles and 35 per cent by the soil between the piles. Similar results have also been reported by Hooper (1973a, 1973b) for another office building in London. Hansbo et al (1973) found for a pile-supported raft in a soft normally consolidated clay in Sweden that the applied load on the raft was mainly transferred to the underlying soil through the raft by direct contact.

4.5.3 Rate of settlement: The settlement rate can in general only be estimated approximately because of the difficulty of establishing the local drainage conditions. There are indications that radial cracks form in the soil around the piles during pile driving which increases the consolidation rate of the soil (Massarsch, 1976).

The settlement of a pile group in normally consolidated clays with low permeability is frequently estimated from the assumption that the drainage effect of timber piles is equivalent to that of a pervious layer located at the lower third point of the pile group (Torstensson, 1971). A similar effect is expected for concrete piles.

The permeability of most soils is higher in the horizontal than in the vertical direction. For the normally consolidated clays which are common in Sweden the ratio of the permeability in the horizontal and vertical directions is typically 2 to 5. The remoulding of the soil by the driving reduces the difference of the permeability.

4.5.4 Differential settlements: One important function of friction piles in clay is to reduce the differential settlements. Morton and Au (1975) report that for cast-in-place piles in stiff fissured clay the differential settlements were about 25 per cent of the maximum settlements. This effect can be estimated as indicated in Fig 24. The maximum angular distortion of the soil along the perimeter of the pile group can be estimated from the following relationship based on elastic theory (Broms, 1976):

$$\beta = \frac{s_{av}}{G_s} = \frac{2(1 + \nu) s_{av}}{E_s} \dots\dots\dots (4.3)$$

where s_{av} is the average shear stress along the perimeter of the pile group, E_s and G_s = the modulus of elasticity and the shear modulus respectively of the soil and ν is Poisson's ratio. The angular distortion will thus depend on the average shear stress along the perimeter of the pile group and on the load distribution within the pile group. Immediately after loading the largest part of the applied load will be carried by the surrounding soil along the perimeter of the pile group and only a small part will be transferred to the underlying soil at the bottom of the pile group. The part transferred through the bottom of the block reinforced with piles will increase with increasing depth of the pile group and with decreasing axial stiffness of the piles. Approximate calculations based on elastic theory indicate that about 80 to 90 per cent of the applied load will be carried by skin friction along the perimeter of a pile with $D/B = 1.0$ and $\nu = 0.5$. For design purposes it is suggested that the average shear stress should be calculated from the assumption that the total load is transferred to the soil along the perimeter of the pile group.

In Fig 25 the settlements of two areas with and without piles have been compared. The piles consisted in this case of 6 m long lime columns, 0.5 m diameter which were installed at a spacing of 1.4 m. The total thickness of the soft normally consolidated clay at the test site was about 15 m. The surface settlements outside the area reinforced with lime piles was large compared with the reference area. These large surface settlements indicate that a large part of the applied load was transferred to the

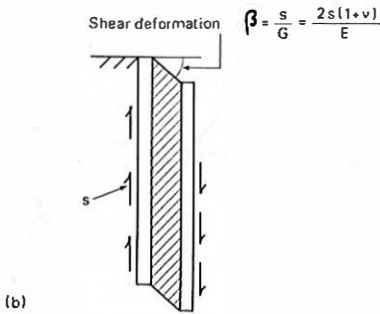
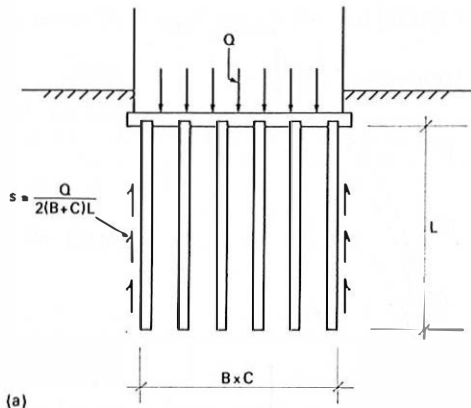

Fig 24 Differential settlements of a pile group (Broms, 1976)

surrounding soil along the perimeter of the pile group. The degree of consolidation of the area with lime columns was almost 100 per cent after two years while the degree of consolidation of the reference area was about 25 per cent. The maximum change of slope of the area with lime piles after two years was about 10 per cent of that of the reference area. The maximum differential settlements corresponded to a shear modulus (G_s) for the normally consolidated clay of $100 c_u$. The reduction of the total settlements was about 50 per cent. The lime columns had in this case a much larger effect on the differential settlements than on the total settlements.

Equation (4.3) can be rewritten as:

$$s_{av}/c_u = \frac{\beta E_s}{2 c_u (1 + \nu)} \dots\dots\dots (4.4)$$

At $E_s = 300 c_u$, $\nu = 0.5$ and $\beta = 1/300$, then $s_{av}/c_u = 0.33$. By limiting the average shear stress along the perimeter to $0.33 c_u$ the maximum angle change will be less than $1/300$. For a building this will be influenced by the stiffness of the superstructure as well. The differential and total settlements are to a large extent affected by the construction procedure. For example, the settlements can be reduced appreciably if the piles are driven before the soil above the foundation level has been excavated. The piles will then restrict the bottom heave during the unloading. Also the order of the driving of the piles is important. The soil is pushed in the direction of the driving. The remoulding of the soil and the decrease of the shear strength will thus be the largest around and in front of the piles that are driven

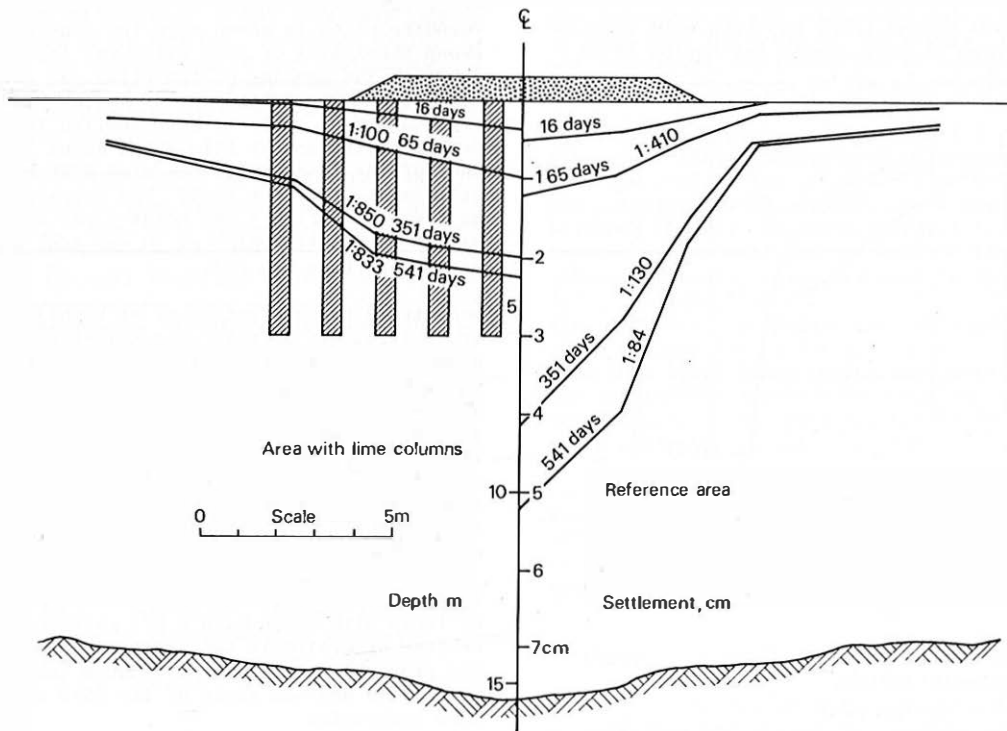

Fig 25 Settlements of two areas with and without lime columns (Broms, 1976).

last. The earth pressure in the soil may even correspond to passive earth pressure when the pile group is large.

4.6 COHESIONLESS SOILS

The compaction that takes place in loose sand during pile driving has a large effect on the bearing capacity and settlements of pile groups as pointed out by Meyerhof (1959, 1976). There is a substantial difference in settlements between buried and driven piles. Vesic (1969) reports, for example, that the settlements of driven piles were less than 1/10th of those of buried piers when the relative density of the sand was low. When the relative density was 80 per cent the ratio was about eight. The initial settlement of a pile group in sand is generally large in comparison with the time dependent settlement which is normally neglected in calculations.

Semi-empirical methods have been proposed to calculate the settlements of pile groups in sand. Large deviations can be expected when the conditions at a particular site deviate from those at which the method was derived.

Methods based on the theory of elasticity (Mindlin's solution) have been proposed to calculate the initial settlements of pile groups in sand. Koerner and Partes (1974) have compared calculated and observed settlements of a structure supported on Franki-type cased piles using elastic theory. The soil modulus was evaluated from drained triaxial tests on recomacted samples. The agreement between calculated and measured values was satisfactory, however, Kovacs and Leonards (1975) point out in a discussion to the article that the evaluation of the elastic constants which are used in the analysis are very uncertain.

The finite element method (FEM) has been used to analyse the settlement of pile groups but Boulon et al

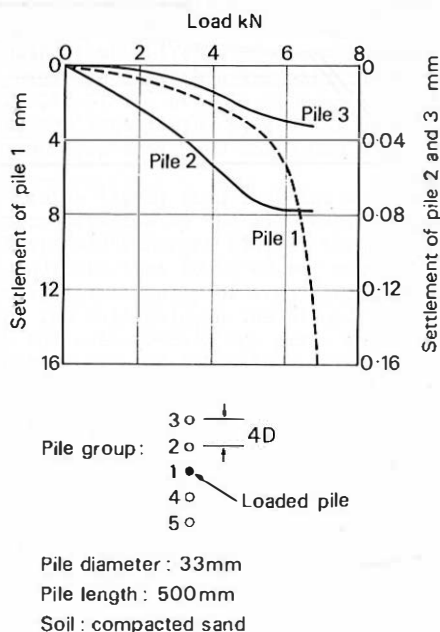
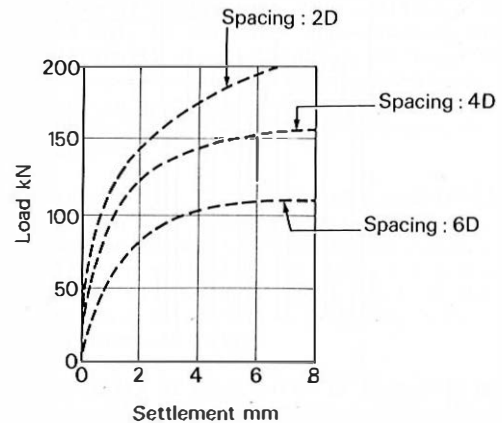

Fig 26 Settlement of piles adjacent to a load test in sand (Kezdi, 1960)



Pile group: □□
Width: 100mm
Pile length: 2000mm
Soil: fine sand

Fig 27 Settlement of pile groups in sand (Kezdi, 1957)

(1976) have pointed out that the local slip between the piles and the surrounding soil has an important effect.

Comparisons with available test data indicate that often the calculated settlement of a pile group will be too large when a modulus of elasticity which is constant with depth is used in the analysis. It should be pointed out that results from only a few well instrumented load tests on pile groups in sand are available. In Fig 26 the settlements of the surrounding piles is shown when the centre pile of a pile group consisting of five piles was loaded (Kezdi, 1960). The spacing of the piles was 4D. At low load levels the settlement of the unloaded piles increased almost linearly with applied load. The observed settlement of Pile 2 was about 3 per cent of that of the loaded pile compared with a calculated settlement of 40 per cent. The corresponding measured settlement of Pile 3 was about 1 per cent compared with a calculated value of 30 per cent based on elastic theory (see Fig 22).

Load tests by Berezantzev et al (1961) indicate that the settlements of pile groups in fine sand will increase almost linearly with the equivalent width given by the square root of the loaded area. It is thus assumed that the settlement of a pile group is independent of the spacing and the diameter of the piles. Vesic (1968, 1969) found from an analysis of data reported by Berezantzev et al (1968) and from his own investigations that the settlement of a pile group is approximately proportional to $\sqrt{B/D}$, where B is the width of the pile group and D is the pile diameter.

Vesic (1975) points out that this equation is based on tests with piles with a L/D ratio of 14. The scatter of available test data is, however, large. The proposed relationships between the group settlement ratio and the width of the pile group is therefore uncertain.

Skempton (1953) has found that the settlement of a pile group in sand is mainly affected by the width of

the pile group as expressed by the following equation

$$\frac{\rho_{\text{group}}}{\rho_s} = \left[\frac{4B + 3}{B + 4} \right]^2 \dots\dots\dots (4.5)$$

where B is the width of the pile group in metres. Meyerhof (1959) has modified this relationship to take account of the spacing of the piles:

$$\frac{\rho_{\text{group}}}{\rho_s} = \frac{s/D (5 - s/3D)}{1 + 1/r} \dots\dots\dots (4.6)$$

where s is the spacing of the piles, D is the pile diameter and r is the number of rows in the pile group.

The compaction that takes place in loose sand during the driving affects the ultimate bearing capacity and the settlement as indicated by test data reported by Kezdi (1957), Sowers et al (1961) and Berezantzev et al (1961). It can be seen from Fig 27 that the settlement of a pile group consisting of four piles at the same total load decreases with decreasing pile spacing and that this decrease is mainly caused by an increase of the ultimate strength with decreasing pile spacing. Model tests carried out by Hanna (1963) indicate that the settlement ratio decreases with increasing load level and with decreasing length/width ratio of the pile group.

Available test data seem to indicate that the settlements of a pile group can be overestimated by the methods mentioned above when the piles have been driven through a layer of soft clay into an underlying layer of sand or gravel and the applied load is mainly carried by the pile point rather than the skin friction (Broms, 1967, 1972 and 1976). Similar conclusions have also been drawn by Leonards (1972) and Vesio (1975) from an analysis of the test data reported by Berezantzev et al (1961). Leonards (1972) points out that the correlation of the settlement ratio with pile geometry can be misleading if information of the relative load transfer (shaft and point resistance) is not available.

The settlements of pile groups in cohesionless soils can also be calculated from the results from static penetration tests. The pile group is assumed to be equivalent to a raft located at the lower third point of the piles. The soil below the equivalent raft is divided into layers and the compression of each layer is calculated separately. Alternatively the approximate empirical method shown in Fig 21 can be used. The compressibility index of the soil is evaluated from the relationship (DeBeer and Martens, 1957):

$$C_c = 1.5 q_o/p_o^* \dots\dots\dots (4.7)$$

where q_o is the average penetration resistance of the different layers and p_o^* is the effective overburden pressure at the centre of the layer. Comparisons with test data indicate that the total settlements as calculated by this method will be two to three times larger than the actual settlement. However Parker and Bayliss (1970) have used this method to check the settlements of four sugar silos and the agreement between calculated and measured settlements was satisfactory.

Vesio (1968) has suggested from a comparison with test data that the value of E to be used in calculating settlements of buried piles is 6 to 9

times the static penetration resistance. For driven or jacked piles, the value of E will be 25 to 50 times the static penetration resistance.

The settlement of a pile group in sand can be estimated conservatively from the results of Standard Penetration Tests (SPT). The following relationship can be used (Meyerhof, 1974 a, 1976):

$$\rho_{\text{group}} = \frac{0.9 q \sqrt{B} I}{N} \dots\dots\dots (4.8)$$

where ρ_{group} is the settlement of the pile group in mm, B is the width of the pile group in m, q is the net foundation pressure in kPa and N is the average corrected standard penetration resistance (blows/300 mm) down to a depth which is equal to the width of the pile group below the bottom of the pile group. I is an influence factor which can be evaluated by the expression:

$$I = (1 - D^*/8B) \geq 0.5 \dots\dots\dots (4.9)$$

For silty sand the settlement is expected to be equal to twice the settlement calculated by the equation given above. A comparison with test data indicates that the settlement estimated by eq (4.8) will be somewhat larger than the actual settlement.

The settlements can also be estimated from static penetration tests (Meyerhof, 1974)

$$\rho_{\text{group}} = \frac{q BI}{2 q_c} \dots\dots\dots (4.10)$$

where q_c is the average cone resistance down to a depth equal to the width of the pile group (the seat of the settlements). If the sand is overconsolidated the settlements of the pile group will be overestimated by eq (4.10) as well as in the case when the thickness of the sand layer below the pile group is less than the width of the group. In that case the calculated settlement may be reduced in proportion to the thickness of the compressible layer.

Considerable uncertainty is connected with the calculations of the settlements of pile groups in cohesionless soils. The presently available methods are not satisfactory as pointed out by Kovacs and Leonards (1975). The main difficulties are the evaluation of the soil properties from the field and laboratory tests, which are used in the different design methods, the changes of the soil properties that take place during driving or excavation and how these changes can be taken into account. The compaction that takes place during pile driving will reduce the settlements appreciably compared with those for bored piles. With presently available methods only rough estimates of this reduction can be made.

Only a few investigations have been concerned with the differential settlements of pile groups. Test data suggest that friction piles will have a larger effect on the differential settlements than on the total settlements.

CHAPTER 5 - SOIL/STRUCTURE INTERACTION

So far in this Review we have dealt with the behaviour of buildings and structures (Chapter 2) and the behaviour of foundations and the underlying ground (Chapters 3 and 4). It is the interaction between the two which ultimately determine the success or otherwise

of the total structure. The subject was discussed briefly in Chapter 2 when routine limiting settlements were considered. In this Chapter some analytical aspects of soil/structure interaction will be presented briefly. However, in discussing a subject of this complexity it is essential that the idealizations that are being made should be thoroughly understood. Reference should also be made to a valuable discussion on this topic by Peck (1965).

5.1 IDEALIZATION AND REALITY

Analytical methods have been developing so rapidly over the last few years that it will soon be possible to solve most boundary value problems in structural mechanics given (i) the geometry; (ii) the material properties and (iii) the loading. Yet even with unlimited analytical power at their disposal engineers would not be very much better off than at present when attempting to design for soil-structure interaction. It is worth considering briefly some of the idealizations that have to be made under the above three headings, dealing first with the soil and secondly with the superstructure:

5.1.1 Soil geometry: Every foundation problem entails a site investigation and on the basis of very limited data judgements and idealizations have to be made about the continuity and thickness of the various strata. In most cases the cost of drilling sufficient boreholes to adequately define the geometry of the ground is prohibitive and it is seldom that the engineer has more than an approximate model.

5.1.2 Soil properties: The difficulties of obtaining reasonable in-situ values of compressibility, undrained stiffness and permeability have been emphasized in this Review. Such 'simple' properties may be adequate for settlement calculations but detailed behaviour, such as local pressure distributions and relative displacements, is much more sensitive to the form of the stress-strain-time properties of the soil and their local variations. The task of accurately ascertaining realistic in-situ constitutive relations of most natural soils and the variations with depth and plan is formidable.

5.1.3 Resultant foundation loads: The resultant loads (as opposed to their distribution) acting on a foundation are usually reasonably well defined. The greatest difficulties arise for structures subject to dynamic forces, eg waves, earthquakes, etc. For routine buildings the largest uncertainty is the precise order in which the loads are applied, eg the method of excavation or order of construction.

5.1.4 Structural geometry: The final geometry is usually accurately specified. However, there are two important areas of uncertainty. The first is the geometry at any given time during construction - this will have a significant influence on the distribution of forces. The second is the way the various elements are connected together. In practice the degree of fixity at joints is uncertain and cladding and infill panels have varying degrees of fit. The overall stiffness of a structure is therefore difficult to assess with any accuracy.

5.1.5 Structural loading: Unlike the resultant foundation loads the structural loading usually cannot be ascertained accurately. Individual members

have to be designed to withstand any likely magnitude and distribution of loads. Often all the attention in structural design is devoted to the sizing of individual members with little or no analysis of the overall structure.

5.1.6 Structural properties: The materials composing the building or structure are probably somewhat easier to model than the ground. Nevertheless, the stress deformation properties of the various components that make up a building are complex, particularly with regard to creep, thermal and moisture effects. Moreover the actual properties 'as built' undoubtedly differ significantly from those that are specified.

It is evident from the foregoing that even if engineers were in possession of unlimited analytical power the uncertainties in both the soil and the superstructure are so great that precision in the prediction of behaviour would be unlikely to improve significantly. As in so many fields of engineering, analysis is only one of the many tools required in designing for soil-structure interaction. In most circumstances the real value of analysis will be in assisting the engineer to place bounds on likely overall behaviour or in assessing the influence of various detailed construction features, eg a local stiffening due to a deep beam or a shear wall (say).

5.2 THE CONSTRUCTION SEQUENCE

Figure 28 is a simple diagrammatic representation of the net loading and settlements of a simple frame building founded on a raft during and subsequent to construction. During excavation some uplift of the soil will occur. The raft will then be constructed and will be influenced by the differential settlements thereafter. As the structural load is applied short-term settlements take place, the part of the structure in existence distorts and the overall stiffness gradually increases. The cladding is then added and this may substantially increase the stiffness of the building. Finally, the live load is applied. It will be noted that not all the components of the building are subject to the same relative deflections. The relative deflections experienced by the raft will

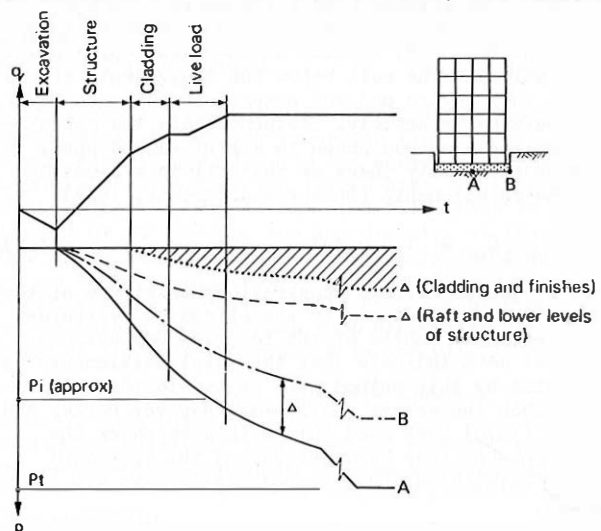

Fig 28 Settlements and relative deflections during and subsequent to construction.

be the largest. Those experienced by the structural members will vary with location and level in the building. The shaded portion in Fig 28 represents the relative deflections affecting the cladding, partitions and finishes and are therefore the cause of any architectural damage.

It is evident from Fig 28 that the likelihood of damage will diminish the larger the proportion of immediate to long-term settlement ρ_i/ρ_t , the smaller the ratio of live to dead load and the later the stage at which the finishes etc are applied. It should be noted that the proportion of immediate to long-term settlement is influenced by the net increase in effective stress and the amount of consolidation taking place during construction as well as the factors discussed in Section 3.4. It is frequently stated that the building materials are less prone to damage when distortions develop over a long period and this appears reasonable, although Grant et al (1972) found little direct evidence to support it.

5.3 THE INFLUENCE OF NON-HOMOGENEITY

In Section 3.2.2 the influence of varying stiffness with depth was discussed. This type of non-homogeneity has a very important influence on the form and extent of the 'settlement bowl' around a loaded area. For example, Terzaghi (1943, p 426) shows that an underlying rigid stratum concentrates the surface movements around the loaded area. Gibson (1967, 1974) noted a similar effect for increasing stiffness with depth. Conversely a stiff overlying layer will disperse the settlements further from the loaded area. In Section 6.3 some field observations confirming these findings are presented. The sensitivity of surface settlements to non-homogeneity clearly has to be taken into account in any soil-structure interaction analysis. Lateral variations of compressibility are clearly significant, but surprisingly little work has been done on the influence of this form of non-homogeneity on stress distributions beneath loaded areas.

5.4 ANALYSIS OF SOIL/STRUCTURE INTERACTION

It is important to distinguish between two broad objectives in carrying out soil-structure interaction analyses: Firstly, and perhaps of most concern to the general practitioner, is the need to estimate the form and magnitude of the relative deflections. This information is used to assess the likelihood of damage and to investigate the merits of alternative foundation and structural solutions. Second, the much more specialised requirement of calculating the distribution of forces and stresses within the structure.

The second requirement entails a degree of sophistication and complexity many times greater than the first.

5.4.1 Relative deflections of equivalent raft foundations In 1969 Golder pointed out that engineers can estimate the settlements for a perfectly flexible load or they can estimate the average settlement of a rigid load, but in between these limits the foundation engineer can say nothing. During the last eight years progress has been made but simple practical techniques are urgently required for filling this gap. Until this is done the knowledge that is being accumulated on the observed behaviour

of buildings will be difficult to apply. De Mello (1969) has emphasised the lack of logic in relating such information to computed differential settlements which neglect the stiffness of the structures.

A first approach is to represent the building by a simple equivalent raft having a similar overall stiffness. Gorbunov-Possadov and Davydov (1973) and Fraser (1976) have summarised the development of the study of beams and rafts on elastic foundations. With the advent of electronic digital computers considerable progress has been made in the study of beams and rafts on elastic and inelastic ground. An important factor is the stiffness of the raft in relation to the stiffness of the ground and this ratio is denoted by K_r . It can be shown that for a simple rectangular raft of length L and breadth B resting on a homogeneous elastic half space the relative stiffness:

$$K_r \propto \frac{E_r I_r (1 - \nu_s^2)}{E_s B^3} \dots \dots \dots (5.1)$$

$$\propto \frac{E_r}{E_s} \cdot \left(\frac{t}{B}\right)^3 \cdot (1 - \nu_s^2) \dots \dots \dots (5.2)$$

where the subscripts r and s refer to the raft and soil respectively, I_r is the moment of inertia of the raft per unit length and t is the thickness of the raft. It is important to note that various expressions for relative stiffness differ in the choice of proportionality constant. In general 'B' may be thought of as a characteristic dimension. When referring to a specific value of relative stiffness it is always necessary to define K_r .

Brown (1969a, b and 1974) has studied the case of a uniformly loaded circular raft in frictionless contact with an elastic half space. Hooper (1974, 1975) has used the finite element method to study the same problem for the case of adhesive contact and parabolic loading as well as uniform loading. These authors present the results as curves of total and differential settlement and bending moment against relative stiffness K_r which is defined as:

$$K_r = \frac{E_r (1 - \nu_s^2)}{E_s} \left(\frac{t}{a}\right)^3 \dots \dots \dots (5.3)$$

where 'a' is the radius. A notable feature revealed by these studies is the fairly small range of K_r values for which the raft changes from being very flexible to very stiff. Thus from Brown's results it appears that for $K_r \leq 0.08$ the raft is for practical purposes flexible, whereas for $K_r \geq 5.0$ the raft is rigid. A result of this type is of considerable practical value as it can be used to assess the likely significance of the stiffness of the superstructure in evaluating the relative settlements.

Non-circular rafts of varying stiffness can be handled by the method first outlined by Cheung and Zienkiewicz (1965) in which the raft is idealised by means of finite elements which are in contact with an elastic continuum. Cheung and Zienkiewicz used the Boussinesq equation to derive the stiffness of the soil. Cheung and Nag (1968) and Svec and Gladwell (1973) describe refinements to the approach. The method has been extended by Wood and Larnach (1974, 1975) to include non-homogeneity, anisotropy and non-linearity of the soil based on the assumption that the stress distribution within the soil is the same as for a homogeneous half space. In Section 3.2 this

was shown to be a reasonable assumption for the vertical stresses, except for stiff surface layers overlying soft layers. Hence some care is needed when applying the method to this case. Hooper and Wood (1976) obtained satisfactory agreement with exact values over a wide range of soil heterogeneity.

Wardle and Fraser (1974) use a more precise procedure based on the exact stress distribution within a layered anisotropic elastic soil. Using this method Fraser and Wardle (1976) examine the behaviour of smooth uniformly loaded rectangular rafts of any rigidity resting on a homogeneous elastic layer underlain by a rough rigid base. Graphical solutions are presented of the vertical displacements at the centre, mid-edges and corner of the raft and the maximum bending moment in the raft.

Some typical results of relative deflections are given in Fig 29 for a raft with $L/B = 2$ on a semi-infinite half space. The stiffness factor is defined by:

$$K_r = \frac{4}{3} \frac{E_r (1 - \nu_s^2)}{E_s (1 - \nu_r^2)} \frac{t^3}{B^3} \dots\dots\dots (5.4)$$

The settlements are given by:

$$\rho = q \cdot B \frac{1 - \nu_s^2}{E_s} \cdot I \dots\dots\dots (5.5)$$

where I is an influence factor obtained from Fig 29. ρ and I can have the following subscripts:

- A, B, C and D - associated with settlement of the point
- AB, AC, etc - associated with the differential settlement between the two points.

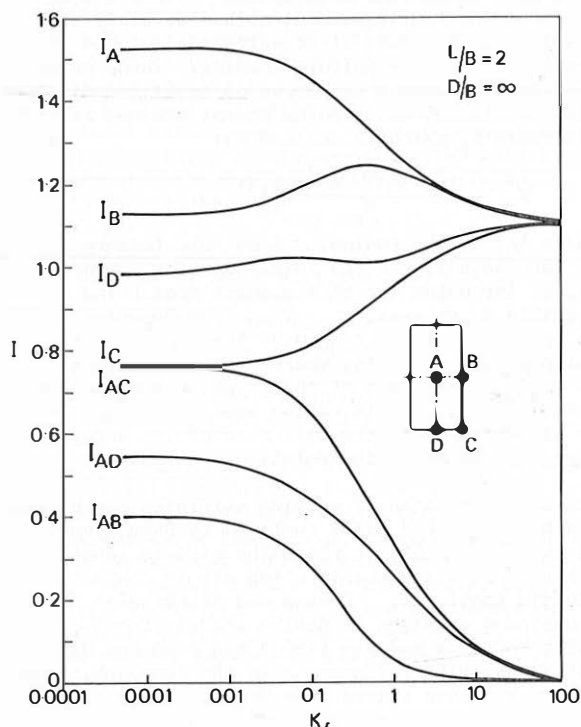

Fig 29 Settlement and differential settlement influence factors for a rectangular raft on an elastic half space (Fraser and Wardle, 1976)

It can be seen from Fig 29 that the most rapid changes in performance is in the range of $0.05 < K_r < 1$ for I_{AB} and $0.1 < K_r < 10$ for I_{AC} and I_{AD} . Wardle and Fraser include charts which allow for the depth of the elastic layer. They also outline approximate methods for dealing with a multi-layered soil system by means of a simple equivalent layer.

Charts of the type developed by Fraser and Wardle should prove valuable for routine design purposes or for preliminary design prior to a complete analysis. The stiffness of the superstructure can be included in this type of simple analysis using the approximate methods outlined by Meyerhof (1953) for estimating the equivalent flexural rigidity of a frame superstructure including panels and shear walls. This method was endorsed by the American Concrete Institute, Committee No 436 in its report 'Suggested procedures for combined footings and mats' (de Simone, 1966).

The value of a simple approach of this type is illustrated by the results of very complete settlement observations on four buildings in the city of Santos, Brazil, presented by Machado (1961). The buildings were of reinforced concrete frame construction 12 to 14 storeys in height founded on sand overlying a soft clay layer. Detailed estimates of the total and differential settlements were made using traditional methods assuming a flexible loaded area. Figure 30 shows the predicted and observed settlement profiles along the major and minor axes of three of the buildings. It is evident that the predicted average total settlements are in fair agreement with the observed values, but the differential settlements are seriously overestimated.

Comparison of the predicted values of deflection Δ/L with routine limits (eg Fig 4(a)) would have led to the conclusions that serious damage would occur. However, the measured deflection ratios were all within tolerable limits. Unfortunately the structural details of the buildings were not given by Machado so that estimates of the relative stiffnesses cannot be made with any accuracy (Tsytoich, 1961). However, simple calculations suggest that the relative stiffnesses K_r neglecting cladding must have been at least 0.5 which, from Fig 29, would lead to reductions of Δ/L across the breadth of the buildings of at least a factor of 4. In all probability considerably larger reductions would have been calculated if account were taken of the stiff upper sand layer, cladding etc. Further field studies of this type are required to study the influence of superstructure stiffness on relative deflections (eg Rabinovici, 1970).

For more complex conditions such as non-homogeneous ground, buildings which are non-rectangular in plan or non-uniform loadings, computer programs of the type developed by Larnach and Wood (1974) and Fraser and Wardle (1974) can be used to carry out simplified calculations to estimate the deflection ratios. The deformed profiles can then be used to: (i) locate areas of high tensile strain (see Section 2.5), or (ii) compare directly with field evidence of the type given in Fig 4, or (iii) compare with routine limiting values of the type discussed in Section 2.4.

5.4.2 Detailed analysis: As mentioned previously a higher order of sophistication is required if detailed analysis of forces and stresses acting on foundations and structural members is required. Numerous

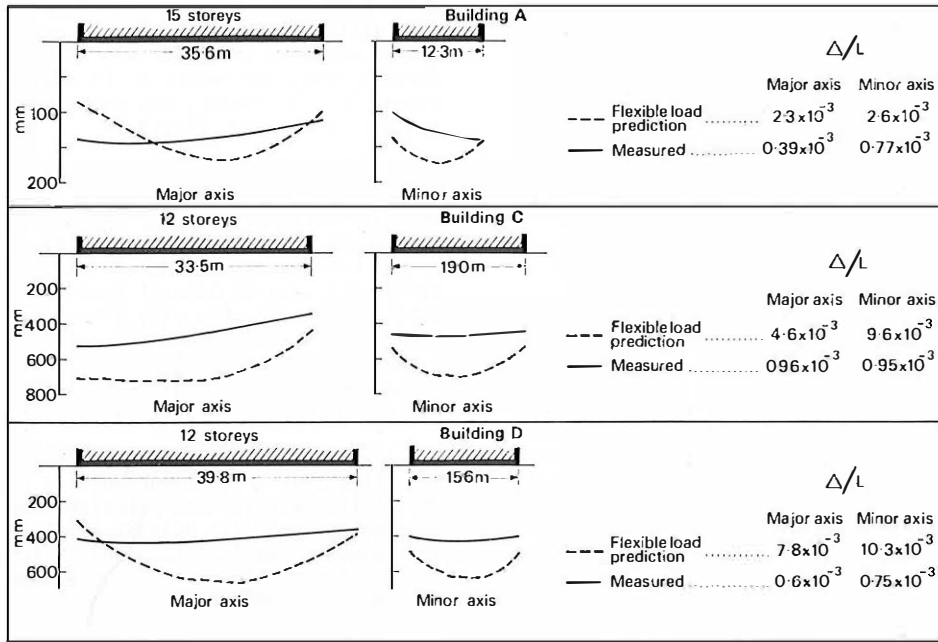

Fig 30 Observed settlement profiles of three buildings in Santos, Brazil (Machado, 1961) compared with predictions using flexible loads.

studies of this type have been carried out often using springs to represent the soil but more recently using more realistic models. The finite element idealization is particularly suited to the solution of plane or axisymmetric problems (eg Smith, 1970; Hooper, 1973). However, only the simplest of structures can be analysed in this way and resort must usually be made to a three-dimensional analysis. Recent examples are given by King and Chandrasekaran (1974a and b) and Majid and Cunnell (1976), who have studied the influence of soil-structure interaction on the bending moments in frame structures.

The use of half-space or layer theory coupled with a suitable idealization of the structure offers many advantages (Fraser and Wardle, 1976). Meyerhof (1947) obtained results for a simple plane frame using this approach and recently studies of increasing sophistication have been reported including time effects, non-linearity and change of stiffness during construction (eg Sommer, 1965; Heil, 1969; Larnach, 1970; De Jong and Morgenstern, 1971; Larnach and Wood, 1972; Klepikov et al, 1973; Binder and Ortigosa, 1975; and Brown, 1975b). Very general computer programs have been written employing these methods (Wardle and Fraser, 1975; Larnach and Wood, 1974) which can handle rafts and footings of arbitrary shape and rigidity and superstructures made up of plate and beam elements. It is to be hoped that in the near future the influence of pile groups will be included perhaps by means of equivalent rafts which include shear deformations as well as bending.

Programs of this type should prove very useful to the engineer wishing to investigate special soil-structure interaction problems in detail. However, in doing so he should always bear in mind the limitations in knowledge about the ground and structure listed at the beginning of the Chapter. Whenever possible, sensitivity studies should be carried out so that realistic upper and lower bounds can be

placed on the problem. So often papers are published showing pressure distributions or bending moment distributions with no indication of the sensitivity of these to the various assumptions. It is not infrequent that a foundation which is expected to 'sag' actually experiences 'hogging' and an example of such a case is given in Section 6.4 (see also Erb, 1963).

CHAPTER 6 - MONITORING THE BEHAVIOUR OF FOUNDATIONS AND STRUCTURES

Instrumentation of earth structures has become accepted practice. Indeed, field instrumentation is now so widely and extensively carried out that Peck (1973) felt it necessary to warn against carrying it to excess. However, in contrast to most other types of structure the instrumentation of buildings has been very restricted apart from simple settlement observations. The explanation is undoubtedly that the relative cost of instrumentation is much greater for a building than for a dam (say). Nevertheless, in most countries the overall investment in building construction is at least as great as in major civil engineering works. A better understanding of the behaviour of the ground and its interaction with foundation and structure must lead to better design and the prospect of reductions in overall expenditure.

6.1 INSTRUMENTS

It goes without saying that successful field measurements can only be made if the instruments are adequate. They should be simple, reliable, stable, cheap and easy to install and use and above all robust and durable. The measurements require careful planning, preferably at the design stage, so that all the parties involved are fully aware of what is being done. One person should be responsible for the ordering, acceptance, installation, reading and maintenance of the equipment. Having made all the

plans, success depends on the dedication and perseverance of the staff carrying out the work.

6.1.1 Measurement of vertical movement: There can be no argument that the precise level is an essential instrument for field measurements. The techniques and organisation of settlement measurements have been discussed by Cheney (1973) who also describes simple and unobtrusive levelling stations and datums. The provision of deep datums is very expensive and is not always necessary. In many cases levelling stations on nearby structures which are founded below the depth of seasonal influence and have been in existence for a number of years are adequate, but at least two and preferably three such datums should be used.

The evaluation of the underlying soil properties from surface settlements is not straight forward and Lambe (1973) has gone so far as to state that such measurements are often of little or no value. The value of settlement observations is greatly enhanced if the compression of various discrete layers beneath the foundation is also measured. Not only is the principal seat of movement revealed but also an accurate calculation of the in-situ compressibility of the various strata can be made. Examples of field measurements of this type are given by Gegerov and Nichiporovich (1961), Ward et al (1968), Dalmatov et al (1973), Kriegel and Wiesner (1973), Egorov et al (1974) and Breth and Amann (1974). When combined with pore pressure measurements the in-situ consolidation properties of the ground at various depths can also be determined.

A wide variety of instruments are used for measurement of settlement at depth and can take the form of rods (or concentric tubes) anchored at various depths and extending to the surface in sleeved boreholes or multi-point extensometer tubes. The latter are less prone to damage and can be used to great depths. Various forms of simple and precise multi-point borehole extensometer have been described by Burland et al (1972), Marsland and Quarterman (1974) and Smith and Burland (1976). Multi-point borehole extensometers can be used both as deep datums and as movement points at various depths beneath a foundation (Fig 31a and b). They are well suited to the measurement of heave at various depths beneath excavations as the upper measuring points can be located in ground which

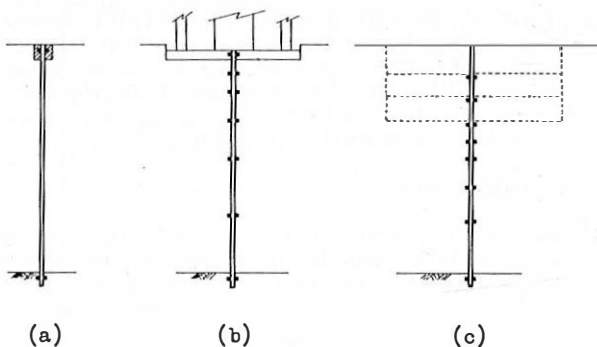

Fig 31 Application of multipoint extensometers as (a) deep datum, (b) settlement points and (c) heave points.

is to be excavated while the lower points are safe from disturbance (Fig 31c). Recent examples of the use of borehole extensometers in deep excavations are given by Simm and Busbridge (1976), Parkinson and Fenoux (1976), Tomono, Kakurai and Okada (1976) and Burland and Hancock (1977).

6.1.2 Measurement of horizontal movement: The importance of horizontal movement in foundation performance is often overlooked. Relative horizontal displacements of the ground are particularly significant around excavations, areas of subsidence, and foundations subjected to lateral load. Burland and Moore (1973) and Littlejohn (1973) have described techniques for the measurement of horizontal displacements. As for vertical movement the value of the results is greatly enhanced if horizontal movements are measured at various depths as well as at the surface.

6.1.3 Measurement of load: Measurements of loads are clearly of great importance in any soil/structure interaction study. The principal techniques of load measurement are well understood, but the very hostile environments and long time scales involved with monitoring of foundations often make such measurements difficult and expensive. Load cells have to be exceptionally stable and immune from the effects of moisture, rust and chemical attack. Hanna (1973) describes the basic features of a number of load cells which have apparently been used successfully in foundation instrumentation. It would appear that load cells involving vibration wire strain gauges (eg Cooling and Ward (1953), Sutherland and Lindsay (1961) offer the best prospects of long-term stability coupled with a reasonable chance of successful insulation from environmental attack. The direct measurement of load in the superstructure does not normally present the same environmental and access difficulties. However, the interpretation of strain gauges embedded in concrete members is far from straight forward as corrections have to be made for temperature, creep and shrinkage effects (see for example Swamy and Potter, 1976; Bate and Lewsley, 1969 and Elvery, 1966).

If accurate assessments of loads coming onto foundations are to be made it is preferable to introduce load cells into the members at foundation level. There is a need for the development of a simple load cell that measures shear, bending and axial load and which can be introduced into a concrete column at its base. The measurement of loads in steel members does not present the same difficulties (Wood and Mainstone 1955).

6.1.4 Measurement of pressure: The measurement of pressure is still one of the most difficult undertakings in soil mechanics and the reliable determination of foundation pressures is no exception. The presence of a rigid boundary presents special problems and pressure cells developed for embedment in fill may not be the most suitable (Arthur, 1973; Green, 1973). Particular attention must be given to mounting and calibrating such cells which are very sensitive to pressure distribution across the active face. In general load cells which measure the total resultant force through a stiff face acting on a 'piston' are thought to be preferable to softer diaphragm or hydraulic cells and Hooper (1973) describes the successful use of such load cells. Eden et al (1973) appear to have had considerable success with the use of hydraulic cells to measure contact

pressures below a foundation raft. Hight and Green (1976) refer to the uncertainties in the calibration of such cells. Gerrard et al (1971) outline a very comprehensive scheme for instrumenting a number of buildings in Perth, Australia, using a wide range of instruments.

6.1.5 Movements in buildings: An important aspect of the measurement of the behaviour of structures is the recording of damage. This is best done by high quality photographs and by making detailed notes and sketches of the crack patterns showing crack widths. The monitoring of changes in crack width can be carried out using simple Demeo gauges (Morice and Base, 1953), or by mounting transducers across the cracks. The precise measurement of long-term movements within buildings is difficult and very few examples of such measurements appear to exist (Budgen, 1969).

6.2 REGIONAL STUDIES OF FOUNDATION BEHAVIOUR

Early examples of regional studies of the settlements of buildings are those carried out in Sao Paulo, Brazil (Pichler, 1948; Rios and Pacheco Silva, 1948; Vargas, 1948 and 1955). These papers are notable for the very thorough treatment given to the geology of the region. The 1955 paper by Vargas was particularly significant as it drew attention to the importance of the pre-consolidation pressure, p_c , or 'yield point' as Vargas called it, in determining the magnitude of settlements on clays. Further outstanding examples of very complete studies are given by Teixeira (1959) and Machado (1961) for the settlement of buildings in Santos, Brazil.

One of the best known regional studies is that described by Bjerrum (1967). He demonstrated conclusively that careful measurements of the behaviour of buildings in a given region can guide the future design of structures in that region and provide the necessary stimulus for research on the in-situ properties of the ground. Bjerrum was able to relate the magnitude and rate of settlements of buildings on Drammen Clay to the ratio $\Delta p' / (p'_c - p'_o)$ where $\Delta p'$ is the net increase in effective pressure, p'_c is the initial in-situ vertical effective pressure and p'_o is the preconsolidation pressure measured in the oedometer. Foss (1969) has described the application of Bjerrum's results to the settlement analysis of three buildings in Drammen.

The difficulty of applying the concepts developed for one region to another region is emphasised by the fact that Nordin and Swenson (1974) observed the settlement of structures in Sweden which gave a completely different pattern of behaviour from the Drammen Clay in that even at values of $\Delta p' / (p'_c - p'_o)$ approaching unity the drained settlements were small and took place rapidly.

Resendiz et al (1967) describe a valuable field study of the elastic properties of saturated clays in Mexico City. Simons (1974) has concluded that for normally and lightly overconsolidated clays at the present time laboratory studies alone will not allow accurate settlement predictions to be made. Long-term regional studies are vitally necessary to determine in particular: (1) whether in the field primary consolidation and/or secondary settlement will develop over a long period of time; and (2) whether a threshold level exists above which large and potentially dangerous settlements will be experienced.

Butler (1974) analysed 29 case histories of settlement of buildings founded on stiff clays in southern Britain. He used a simple drained elastic analysis with $\nu = 0.1$ and included the influence of increasing stiffness with depth. By setting Young's modulus $E = 130 c_u$ ($\approx 1/m_v$) he obtained predicted total settlements varying from approximately 70 per cent to 125 per cent of the observed settlements. There is usually a wide scatter of c_u values for stiff fissured clays and considerable judgement is needed in obtaining representative values. It is essential in future studies of this type that the statistical procedures used for obtaining the representative values are clearly specified.

A particularly important conclusion to be drawn for the stiff clays studied by Butler is that consolidation settlements take place much more rapidly than predicted from oedometer tests. As a general rule it appears that 95 per cent of the settlement is complete after about 10 years and frequently it takes place more rapidly than this. In contrast there is some evidence to show that swelling of the London Clay due to reduction in load takes place over much longer periods (Ward and Burland, 1973).

Breth and Amann (1974) have assembled settlement data from a study of eight buildings on Frankfurt Clay. The material is very similar in its behaviour to the stiff British clays. The relationships between net bearing pressure and settlement are almost identical (Sullivan, 1974), the immediate settlements are between 45 per cent and 70 per cent of the total settlements, and 95 per cent of the total settlement is usually achieved within about 3 years of completion of a building. Steinfeld (1968) has referred to the value of case records in Hamburg.

Measurements of the heave and settlement of tall buildings on dense sandy clay till in Edmonton, Alberta, have been reported by De Jong et al (1971) and (1973). The studies show that: (i) over 80 per cent of the heave and settlement response occurs during the construction period; (ii) settlement is practically complete after approximately one year; (iii) deduced values of E decrease from 7380 kg/cm² to 2110 kg/cm² as the bearing pressures increase from 1.2 kg/cm² to 11.5 kg/cm²; and (iv) values of compressibility determined from laboratory tests overpredict settlements by between 10 and 30 times.

Weak rock often represents a sort of twilight zone between soils and hard rock and quantitative information on them has been notably lacking. Meigh (1976) gives a wealth of information arising out of studies of the settlement of major structures on the soft Triassic rocks in Britain. These studies emphasise the difficulties of making accurate settlement predictions in weak rocks. The best prospects for success appear to lie first in developing an understanding of the depositional environment and subsequent geological history of the material; secondly, in a careful visual examination and logging of the complete profile and thirdly, in carrying out in-situ tests (or laboratory tests if all else fails) on suspect strata. As experience of the settlement of structures develops in a region, particularly if it is based on these three principles, less reliance has to be placed on expensive quantitative tests. Experience on the Chalk in Britain has developed along the above lines over the last decade (Hobbs, 1974; Burland, 1976) with the result that considerable economies have been

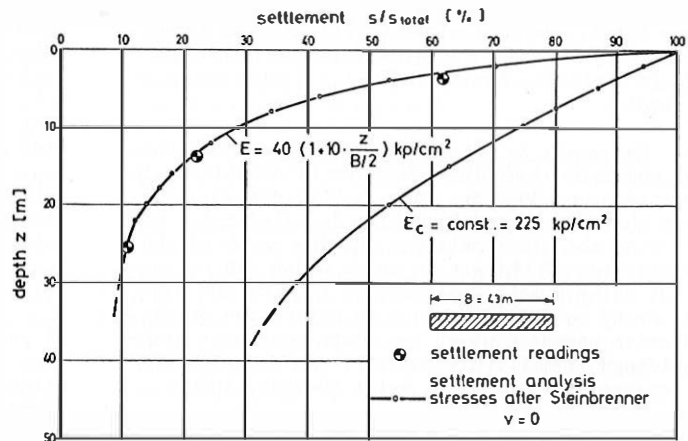
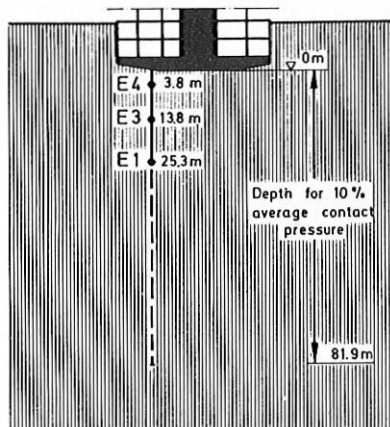

Fig 32 Location of anchor points and settlement distribution beneath AFE building, Frankfurt (Breth and Amann, 1974, and Breth, 1974)

made in the cost of foundations.

6.3 STUDIES OF SOIL DISPLACEMENTS BENEATH AND AROUND FOUNDATIONS

Breth (1974) presents the measured settlements at various depths beneath a nuclear reactor with a 60 m diameter raft founded on granular materials extending to great depth. The measured distribution of settlement with depth revealed that the compression of the sand was concentrated almost entirely in the top 20 m. A similar distribution of vertical strain is indicated by the measurements made by Dunn (1974). These measured strain distributions differ from that adopted by Schmertmann (1970) who assumes it to be zero at the surface, increasing to a maximum at a depth equal to half the width of the foundation. More observations of settlement at depth beneath foundations of various sizes are required on sand to identify the correct strain distributions and their dependence on foundation size.

Breth and Amann (1974) measured the distribution of settlement with depth beneath the AFE building on Frankfurt Clay. The distribution is shown in Fig 32 and it can be seen that the settlements reduce very much more rapidly with depth than for the homogeneous elastic case. Moreover, the observed settlement distribution corresponds closely to a linearly increasing stiffness with depth. Measurements of this type will be valuable in the future design of structures on Frankfurt Clay and can be used not only for estimating settlements, but also for deciding on suitable depths and types of foundation. The measurements were originally undertaken because of the difficulty of making reliable laboratory measurements on the material.

Cole and Burland (1972) back analysed the variation of E_u with depth for London Clay from measurements of retaining wall movements around a deep excavation. The deduced stiffness profile has been successfully used in the design of other deep excavations in the London Clay, the most notable being the deep underground car park at the Houses of Parliament (Burland

and Hancock, 1977) where it was necessary to make accurate estimates of the movements of the ground surface outside the excavation.

Measurements of settlement at depth are invaluable for checking the accuracy of laboratory or in-situ determinations of compressibility (Nikitin et al, 1970; Kriegel and Wiesner, 1973). Bauer et al (1976) present measurements of displacement at various depths beneath footings on a fissured clay. They also conducted a programme of undrained triaxial tests of various types, vertical and horizontal plate bearing tests and pressuremeter tests. It is evident from the results that the values of undrained deformation, E_u , obtained from the laboratory tests were between 0.2 and 0.5 times the values obtained from a test footing. The corresponding ratios for pressuremeter tests and for plate loading tests were 0.3 to 0.5 and 0.5 to 0.7 respectively. It was also found that the values of compressibility deduced from the standard oedometer test grossly overestimated the consolidation settlements. These findings are consistent with the general body of experience on overconsolidated clays and weak rocks which indicate that the stiffnesses obtained from routine laboratory tests can be very much lower than the true in-situ values and that more reliable values can be obtained from plate loading tests. The observations that the major settlements are often concentrated immediately beneath the foundations over a depth of approximately $B/2$ suggest that much more emphasis should be placed on measuring the soil properties in this region.

Often the major damage occurring during construction takes place in adjacent buildings. Hence studies of the movement of the ground around foundations are needed. As mentioned in Section 5.3, the effect of increasing stiffness with depth is to localize the ground surface settlements around the loaded area much more than the simple Boussinesq theory predicts. Burland et al (1973) provide field evidence to support this. Breth and Amann (1974) comment that in the Frankfurt Clay, which exhibits marked increasing stiffness with depth, the settlement depression is very localised.

For a stiff layer overlying more compressible layers surface movements will extend further away from the loaded area than predicted by the Boussinesq theory. Dalmatov et al (1973) present the results of measurements of vertical displacement beneath and around footings founded on a layer of sand overlying soft soils. The analysis of the settlement observations suggest that the sand was five to ten times stiffer than the overlying soil. The measured surface settlements died away much less rapidly with distance from the loaded area than predicted

6.4 TWO CASE RECORDS OF DAMAGE

Although a number of settlement records exist in which damage has been reported there are few studies in which the development of the damage with increasing foundation movement has been accurately recorded. In this Section two recent case histories will be described with a view to demonstrating the value of such studies. Observations for which damage does not occur are, of course, important but, fortunately, there are a number of such records and the lessons to be learned from them are not so explicit as when damage is recorded.

6.4.1 Cracking of silo columns: Burland and Davidson (1976) give a detailed case history of damage to some silos due to differential foundation movements. The four silos were founded on 20 m diameter rafts, 1.2 m thick, resting on soft chalk. This material has a rather similar behaviour to a highly permeable, lightly overconsolidated clay in that it exhibits a 'yield point' under increasing vertical pressure (Burland and Lord, 1969). Figure 33 shows a typical pressure-settlement relationship for one of the silos and it can be seen that the applied pressure exceeded the yield point. Even so, the total settlement is by no means excessive. Figure 34 shows a cross-section through the supporting structure of the silos, together with the deflected shapes of the rafts. All the silos showed distinct hogging; Silo 1 also underwent some tilting. The investigation showed that hairline cracks developed in many of the columns at a deflection ratio $\Delta/L = 0.45 \times 10^{-3}$ and by the time Δ/L had increased to 0.6×10^{-3} the cracking was severe enough (taking account of the large loads carried by the columns) for the engineers to install temporary props. The maximum deflection ratio was 1.07×10^{-3} and Fig 35 shows a sketch of one of the damaged columns corresponding to this value of Δ/L . Even though these relative deflections

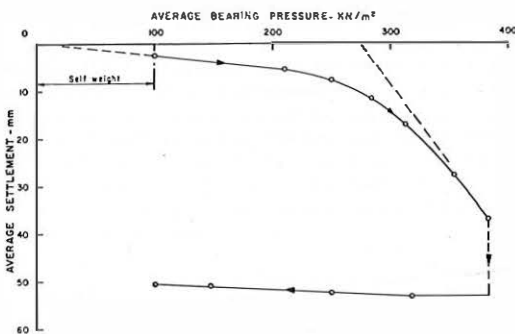

Fig 33 Relationship between bearing pressure and average settlement for a silo on soft chalk (Burland and Davidson, 1976).

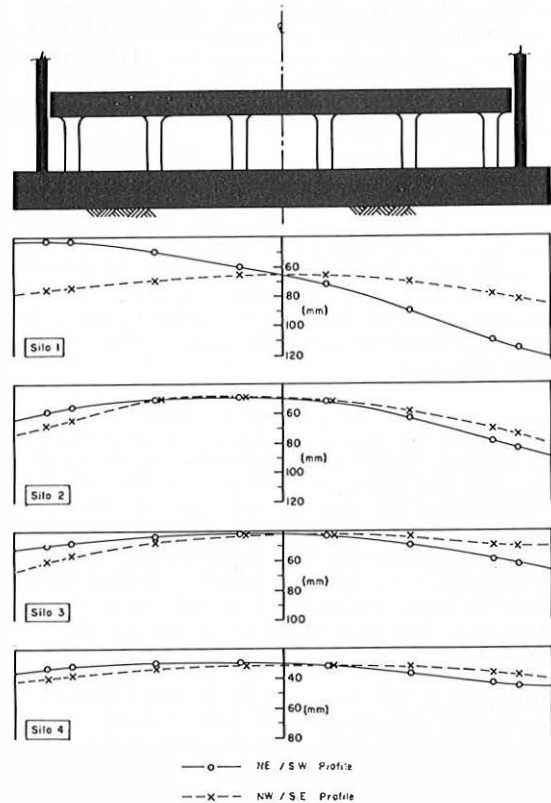

Fig 34 Deflected shapes of raft foundations normal to and parallel to axis of silo complex (Burland and Davidson, 1976).

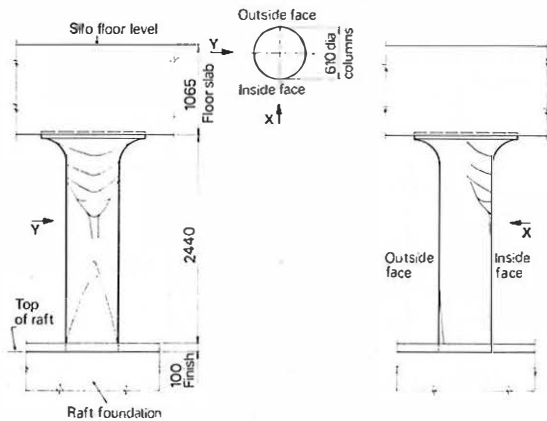

Fig 35 Typical cracked column in Silo 2 (Burland and Davidson, 1976).

are within currently accepted limits the damage was considered severe enough to warrant expensive remedial measures.

A simple analysis of the structure reveals that it had a low relative stiffness (see Section 5.4.1). On the other hand it is evident from Fig 34 that the

short large diameter reinforced concrete columns made the structure 'brittle' and sensitive to differential settlement. Thus the structure has little inherent stiffness to resist differential settlements and at the same time no 'ductility' to absorb the deformations without damage.

In Chapter 1 attention was drawn to the rather special nature of silos. Nevertheless, there are important lessons to be learned from the case history, particularly as this type of design for silos is common throughout the world. (Deere and Davisson (1961) and Colombo and Ricceri (1973) have reported cracking in reinforced concrete columns supporting some silos and the General Reporter has come across other cases of similar damage.)

Having recognised the problem a number of solutions are possible for future designs. In principle these could involve limiting settlements (eg using piles), increasing the relative stiffness of the structure (eg thickening the raft or introducing shear walls) or reducing the sensitivity of the structure to relative displacements (eg use steel columns or incorporate hinges). It appears that for ground conditions similar to those encountered in this case the most satisfactory approach would be to modify the structural design rather than resort to a more expensive foundation solution. Although more conventional buildings will not normally be as sensitive to differential settlement this case history emphasises the care that must be exercised when stiff or brittle elements (particular if they are load-bearing) are introduced into an otherwise flexible structure.

6.4.2 Cracking in brickwork due to hogging: Cheney and Burford (1974) describe an interesting case of damage to a three-storey office building of load-bearing brick which was subjected to both hogging and sagging modes of deformation due to a swelling clay subsoil. Careful records of foundation displacements

and cracking have been maintained over 17 years since the start of construction.

Figure 36 shows an elevation of one side of the building with the foundation movements plotted beneath it. The left hand end of the building has been subjected to a hogging mode of deformation whereas the right hand end has undergone sagging. The maximum hogging ratio is 0.84×10^{-3} and the maximum sagging ratio is 0.38×10^{-3} . Damage is confined exclusively to the portion of the building undergoing hogging and takes the form of cracks radiating outwards and upwards from the region of maximum curvature of the foundations. The crack widths are greatest at roof level. The damage was classified as 'slight' to 'moderate' according to Table I. Some disruption of electrical conduits occurred, concrete floors cracked and internal repairs were necessary.

The broken line at the bottom of Fig 36 corresponds to the movements when the building occupants on the top storey began to complain of drafts, leaks and broken windows. The hogging ratio at this stage was 0.65×10^{-3} . The hogging ratio corresponding to maximum crack widths in the upper storey of about 5.0 mm (slight damage) was 0.40×10^{-3} . It should be noted that no visible cracking had occurred for a sagging ratio of 0.38×10^{-3} which provides field evidence confirming that load-bearing walls are more sensitive to hogging than to sagging.

The main benefits of detailed studies of this type are that they provide information on the way damage develops in a building, they allow correlations between degrees of damage and magnitudes of relative displacement and they draw attention to unsuspected weaknesses in design and detailing.

6.5 PRESENTATION AND PUBLICATION OF CASE HISTORIES

In this Chapter some of the benefits to be had from

East elevation - horizontal component of crack widths (mm) at March 1974

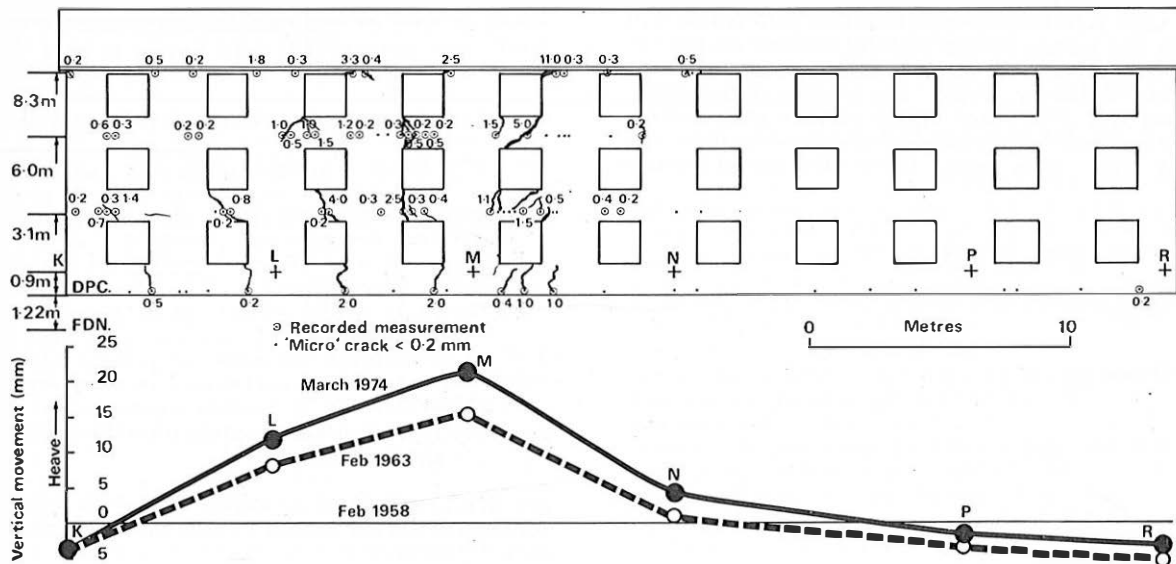

Fig 36 Foundation movements and corresponding cracking in a three-storey office building (Cheney and Burford, 1974)

field studies have been discussed. The importance of publishing comprehensive case records cannot be overstated. They provide the means of assessing the reliability of prediction methods, they give guidance to practitioners who are faced with the design of foundations and structures in similar circumstances, they can be used to develop an understanding of how structures interact with the ground and draw attention to weaknesses in design and construction. In short, well documented case studies provide the recorded precedents which are so valuable in developing the art of foundation engineering.

The value of published case histories is often diminished because vital information is missing. The following information that should be included in any report or publication whenever possible is:

- (1) A detailed profile of the ground and groundwater conditions and the variations underlying the structure. A detailed description of the soil including consistency, structure, fabric, Atterburg limits etc.
- (2) The results of penetrometer and other routine in-situ index tests.
- (3) A description of sampling equipment and methods.
- (4) Laboratory results giving details of test procedures. Typical stress-strain curves and if 'average' results are given the spread of the data should also be given in statistical terms.
- (5) Detailed results of in-situ tests.
- (6) Details of all instrumentation, methods of calibration and an objective assessment of accuracy.
- (7) Details of the structure and foundations including plans, cross-section, loads (design and actual) and construction sequence.
- (8) Displacement, pressure and load measurements, including closing errors and discrepancies between datums. As well as presenting this information in the form of curves it is helpful to tabulate the results.
- (9) A detailed record should be kept of the performance of the structure and finishes. This can best be done by highgrade photography and carefully annotated sketches.

The question arises as to what buildings are worth instrumenting. There is a strong case for specifying simple levelling stations to be installed as a routine on all buildings. The habit of monitoring the performance of buildings needs to be established as this is the one sure way of keeping design assumptions continually under review and developing a realistic appreciation of the confidence limits that can be placed on predictions. The following may serve as a guide on the types of structure for which it is worth making special efforts:

- (i) Large structures for which there will be particularly comprehensive soils investigations.
- (ii) Structures that are simple in plan or that are founded on uniform ground as this makes for ease of interpretation and comparison with test results.

(iii) Structures founded in soil strata for which there is little or no previous experience in the region.

(iv) Structures for which there are local high concentrations of load where differential settlement might be troublesome.

(v) Structures that are subject to large fluctuations in load.

(vi) Existing structures that may be adversely affected by proposed works nearby.

(vii) Structures where movement has already taken place and where there is reason to suspect that movement is continuing and may lead to some measure of failure.

(viii) Often the adequacy of foundations is brought into question after they have been constructed. The possibility of carrying out a full-scale loading test should always be considered. These can be quicker and cheaper than extensive soil tests and the case history described by Leonarda (1972) attests their value.

In all these cases efforts should be made not only to measure foundation movements but also movements at depth and around the structure. Although some civil engineering and building contractors may well be interested in carrying out the work themselves, continuity and expertise will be more readily available from organisations such as local authorities, consultants and research or teaching establishments. Any organisation of this type which sets out to assemble detailed case histories in a given locality or region will be rendering the profession a great service.

CHAPTER 7 - MAIN CONCLUSIONS

The subject dealt with in this Review is exceptionally wide ranging and the Authors are all too conscious of the many omissions both in coverage and in references to notable work. Nevertheless it is hoped that the Review gives at least a flavour of the existing state of the art and broad indications of future developments. A few of the most important conclusions are listed as follows:

- (1) A prime requirement for successful foundation design and construction will always be a knowledge of the soil profile and groundwater conditions across the site. No amount of detailed laboratory testing or sophisticated analysis can compensate for a lack of such knowledge (cf Section 1.2).
- (2) There are many reasons as to why accurate prediction of the settlement of foundations is normally not possible. It is more important that realistic confidence limits should be placed on predictions. More attention should therefore be given to the use of statistics in handling and reporting test results. There are all too many examples of empirical correlations (eg $E_u = 500 c_u$; $1/m_v = 140 c_u$ etc) where nothing is stated about the spread of the data, the conditions under which the parameters were determined or the degree of correlation (cf Sections 1.3 and 3.7).
- (3) Settlement damage is only one aspect of the

wider problem of serviceability of buildings. The problem of coping with differential settlement, as with creep, shrinkage and structural deflections, may frequently be solved by designing the building, and in particular the cladding and partitions, to accommodate movements rather than to resist them. Successful and economic design and construction of the total structure require cooperation between foundation engineer, structural engineer and architect from the earliest stages of planning (cf Sections 1.5 and 2.1).

(4) Progress in the study of the behaviour of foundations and structures will be aided by adopting clear definitions of foundation movements and simple classifications of degrees of damage. The schemes outlined in Sections 2.2 and 2.3 are offered as a basis for discussion with a view to further development.

(5) The concept of limiting tensile strain is introduced in Section 2.5 as a means of gaining insight into some of the factors influencing limiting deflections in buildings. It is demonstrated by means of a simple illustrative analysis and a number of observations of the performance of buildings that the limiting relative deflections are significantly dependent on (i) the length to height ratio; (ii) relative stiffness in shear and in bending; (iii) the degree of tensile restraint built into the structure; and (iv) the mode of deformation (eg hogging or sagging).

(6) Chapter 3 contains a theoretical study of the accuracy of settlement calculations. It is concluded that for factors of safety greater than about 2.5 the errors introduced by the simple classical one-dimensional method of calculating total settlement are usually small compared with those that can occur during sampling and testing. Hence the emphasis should be on the accurate determination of simple parameters, such as one-dimensional compressibility, at a number of depths. There is a continuing and urgent need for the development and improvement of laboratory and in-situ procedures for measuring the representative in-situ properties of the ground in the mass.

REFERENCES

- ALDERMAN, J K (1956): Discussion on paper by Skempton et al "Settlement analysis of six structures in Chicago and London". Proc Instn Civ Engrs, 5, 1, pp 168-170.
- ARTHUR, J R F (1973): General Report - Session 1. Symp Field Instrumentation, Butterworths, London, pp 510-516.
- BATE, S C C and C S LEWISLEY (1969): Environmental changes, temperature creep and shrinkage in concrete structures. Symp Design for Movement in Buildings, Conore Soc, London.
- BANERJEE, P K (1975): Effect of the pile cap on the load-displacement behaviour of pile groups when subjected to eccentric vertical loads. Proc 2 Austral New Zealand Conf on Geomechanics, Brisbane, July 1975.
- BANERJEE, P D (1976): Analysis of vertical pile groups embedded in non-homogeneous soil. Proc 6 European Conf Soil Mech & Found Eng, vol 1.2, pp

(7) When designing pile groups purely to reduce settlements to tolerable amounts, consideration should be given to using the fully mobilized load carrying capacity of piles. If this approach is adopted care must be taken to ensure that the load-settlement characteristics of the piles are 'ductile' and that there is a suitable factor of safety against failure of the pile material (of Section 4.2).

(8) Friction pile groups designed by conventional methods can be very effective in reducing differential settlements (of Section 4.5.4).

(9) Present methods of evaluating settlements of footings, rafts and pile groups on cohesionless soils are not satisfactory due to difficulties in evaluating the in-situ properties and in assessing the influence of pile driving etc. However, settlements take place rapidly and for medium dense to dense sands will usually be fairly small (of Sections 3.8 and 4.6).

(10) The many assumptions and idealizations that have to be made in a soil-structure interaction analysis are listed in Section 5.1. Interactive analysis can be used at a relatively humble level to improve estimates of differential settlement or at a much more sophisticated level to calculate load and pressure distributions within structures. The former can be achieved by representing the structure and its finishes by a simple equivalent raft (of Section 5.4.1). Techniques are now available for carrying out more detailed interactive analysis but this should be undertaken with considerable caution because of the severe limitations of knowledge about the properties of the ground and structure.

(11) The Review has underlined the dependence of the engineer on field observations for his understanding of the behaviour both of the ground and of structures. The importance of regional studies of settlement has been amply demonstrated. A better understanding of soil-structure interaction requires detailed measurements of ground behaviour beneath and around foundations coupled with careful observations of the behaviour of the superstructure. Examples of such studies are given in Chapter 6.

345-350.

- BAUER, G E et al (1976): Predicted and observed footing settlements in a fissured clay. Conf Perf Build Struct, Glasgow, Pentech Press, London, pp 287-302.
- BEREZANTZEV, V G, V S KHRISTOFOROV and V N GOLUBKOV, (1961): Load bearing capacity and deformation of piled foundations. Proc 5 Int Conf Soil Mech & Found Eng, vol 2, pp 11-15.
- BERRE, T and K IVERSEN (1972): Oedometer tests with different specimen heights on a clay exhibiting large secondary compression. Geotechnique, 22, 1, pp 53-70.
- BERRY, P L and T J POSKITT (1972): The consolidation of peat. Geotechnique, 22, 1, pp 27-52.
- BINDER, K and P de Ortigosa (1975): Influencia de asentamientos diferenciales en un marco espacial: parte II. Revista del IDIEM, vol 14, 1, pp 1-26.

- BJERRUM, L (1963): Discussion Proc Eur Conf SM&FE, Wiesbaden, vol 2, p 135.
- BJERRUM, L (1967): Engineering geology of Norwegian normally consolidated marine clays as related to settlements of buildings. 7th Rankine Lecture, Geotechnique, 17, pp 81-118.
- BJERRUM, L (1972): Embankments on soft ground. Proc Spec Conf on Performance of Earth and Earth-supported Structures, Purdue, vol 2, pp 1-54.
- BJERRUM, L and A EGGESTAD (1963): Interpretation of loading tests on sand. Eur Conf SM&FE, Wiesbaden, vol 1, pp 199-204.
- BJERRUM, L, W JÖNSON and C OSTENFELD, (1957): The settlement of a bridge abutment on friction piles. Proc 4 Int Conf SM&FE, vol 2, pp 14-18.
- BOBRICKY, G and S KLEPIKOV (1975): Effectivnyj metod zadaci vzaimodejstvija fundamenta s nadfundamentnoj konstrukcijej. Osnov Fund Mech Grunt, 17, 1, pp 9-12.
- BOOKER, J R and H G POULOS (1976): Analysis of creep settlement of pile foundations. Jnl Geotech Eng Div, Proc ASCE, vol 102, no GT1, pp 1-14.
- BOULON, M et al (1976): Tassements et force portante limite des pieux en milieu ulverulent. Proc 6th Eur Conf SM&FE, vol 1.2, pp 377-382.
- BRETH, H and P AMANN (1974): Time-settlement and settlement distribution with depth in Frankfurt clay. Proc Conf on Settlement of Structures, Cambridge, Pentech Press 1975, pp 141-154.
- BRETH, H and G CHAMBOSSÉ (1974): Settlement behaviour of buildings above subway tunnels in Frankfurt clay. Proc Conf Settlement of Structures, Cambridge. Pentech Press, London, pp 329-336.
- BROMS, B (1967): Bearing capacity of pile groups (in Swedish). Swedish Geotech Inst, reprints and preliminary reports no 18, 35 pp.
- BROMS, B B (1972): Settlement of pile groups. Proc of Spec Conf on Performance of Earth and Earth-supported Structures, Purdue Univ, June 11-14, 1972 vol 3, pp 181-199.
- BROMS, B B (1976): Pile foundations - Pile groups. Proc 6 European Conf SM&FE, vol 2.1, pp 103-132.
- BROWN, P T (1969a): Numerical analyses of uniformly loaded circular rafts on elastic layers of finite depth. Geotechnique, 19, 2, pp 301-306.
- BROWN, P T (1969b): Numerical analyses of uniformly loaded circular rafts on deep elastic foundations. Geotechnique, 19, 3, pp 399-404.
- BROWN, P T (1974): Influence of soil inhomogeneity on raft behaviour. Soils and Foundations, 14, 1, pp 61-70.
- BROWN, P T (1975a): Strip footing with concentrated loads on deep elastic foundations. Geotechnical Engg, 6, 1, pp 1-13.
- BROWN, P T (1975b): The significance of structure-foundation interaction. Proc 2nd Austr-New Zealand Conf on Geomechanics, Brisbane, pp 79-82.
- BRITISH STANDARDS INSTITUTION (1976): Draft Standard Code of Practice for Site Investigations. Document 76/11937 DC.
- BUDGEN, W E J (1969): Loading - dead, live and wind. Proc Symp Design for Movement in Buildings. The Concrete Soc, London.
- BURHOUSE, P (1969): Composite action between brick panel walls and their supporting beams. Proc Instn Civ Engrs, vol 43, pp 175-194.
- BURLAND, J B (1969a): Deformation of soft clay beneath loaded areas. Proc 7th Int Conf SM&FE, Mexico, 1, pp 55-63.
- BURLAND, J B (1969b): Discussion on Session A. Proc Conf In-situ Investigations in Soils and Rocks. Brit Geotech Soc, London, p 62.
- BURLAND, J B (1971): A method of estimating the pore pressures and displacements beneath embankments on soft natural clay deposits. Proc Roscoe Mem Symp. Foulis, pp 505-536.
- BURLAND, J B (1973): Discussion - Session 1. Proc 8th Int Conf SM&FE, Moscow, vol 4.2, pp 12-14.
- BURLAND, J B (1975): Some examples of the influence of field measurements on foundation design and construction. Guest Lecture. Proc 6th Reg Conf Africa SM&FE, Durban, 2, pp 267-284.
- BURLAND, J B, F G BUTLER and P DUNICAN (1966): The behaviour and design of large bored piles in stiff clay. Proc Large Bored Piles. Instn Civ Engrs, London, pp 51-71.
- BURLAND, J B and R W COOKE (1974): The design of bored piles. Ground Engg, vol 7, no 4, July 1974, pp 28-30, 33-35.
- BURLAND, J B and W DAVIDSON (1976): A case study of cracking of columns supporting a silo due to differential foundation settlement. Proc Conf on Performance of Building Structures, Glasgow, Pentech Press London.
- BURLAND, J B and R J R HANCOCK (1977): Geotechnical aspects of the design for the underground car park at the Palace of Westminster, London. The Struct Engr (in the press).
- BURLAND, J B and J A LORD (1969): The load-deformation behaviour of Middle Chalk at Mundford, Norfolk: a comparison between full-scale performance and in-situ laboratory measurements. Proc Conf In-Situ Investigations in Soils and Rocks, London 1970.
- BURLAND, J B and J F A MOORE (1973): The measurement of ground displacement around deep excavations. Symp on Field Instrumentation, Butterworths, London, pp 70-84.
- BURLAND, J B, J F A MOORE and P D K SMITH (1972): A simple and precise borehole extensometer. Geotechnique, 22, pp 174-177.
- BURLAND, J B, G C SILLS and R E GIBSON (1973): A

- field and theoretical study of the influence of non-homogeneity on settlement. Proc 8th Int Conf SM&FE, Moscow, vol 1.3, pp 39-46.
- BURLAND, J B and C P WROTH (1974): Settlement of buildings and associated damage. State-of-the-Art Review. Proc Conf Settlement of Structures, Cambridge, Pentech Press, London, pp 611-654.
- BUTLER, F G (1974): Heavily overconsolidated cohesive materials. State of the Art Review. Conf Settlement of Structures, Cambridge. Pentech Press, London pp 531-578.
- BUTTERFIELD, R and P K BANERJEE (1971a): Elastic analysis of compressible piles and pile groups. Geotechnique, vol 21, no 1, pp 43-60.
- BUTTERFIELD, R and P K BANERJEE (1971b): Problem of pile group-pilecap interaction. Geotechnique, vol 21, no 2, pp 135-142.
- CARRIER, W D and J T CHRISTIAN (1973): Rigid circular plate resting on a non-homogeneous elastic half space. Geotechnique, vol 23, pp 67-84.
- CASSAN, M (1966): Le tassement des pieux; Synthese des recherches recentes et essais comparatifs. Sols:Soils, vol 5, no 18-19, pp 43-58.
- CASSAN, M (1968): Le tassement des pieux; Synthese des recherches recentes et essais comparatifs. Sols:Soils, vol 6, no 20, pp 23-38.
- CHARLES, J A (1976): The use of one-dimensional compression tests and elastic theory in predicting deformations of rockfill embankments. Can Geotech Jnl, 13, 3, pp 189-200.
- CHENEY, J E (1973): Techniques and equipment using the surveyor's level for accurate measurement of building movement. Symp on Field Instrumentation, Butterworths, London, pp 85-99.
- CHENEY, J E and D BURFORD (1974): Damaging uplift to a three-storey office block constructed on a clay soil following removal of trees. Proc Conf Settlement of Structures, Cambridge. Pentech Press, London pp 337-343.
- CHEUNG, Y K and D K NAG (1968): Plates and beams on elastic foundations - linear and non-linear behaviour. Geotechnique, vol 18, no 2, pp 250-260.
- CHEUNG, Y K and O C ZIENKIEWICZ (1965): Plates and tanks on elastic foundations - an application of finite element method. Int Jnl Solids Struct, vol 1 no 4, pp 451-461.
- COLE, K W and J B BURLAND (1972): Observation of retaining wall movements associated with a large excavation. Proc 5th Eur Conf SM&FE, Madrid, vol 1, pp 445-453.
- COLOMBO, P and G RICCERI (1973): Behaviour of structures and allowable settlements. Proc 8th Int Conf SM&FE, vol 1.3, pp 47-53.
- COOKE, R W (1974a): Piled foundations: A survey of research at the Building Research Station. Building Research Establishment Current Paper CP24/74, 10 pp.
- COOKE, R W (1974b): The settlement of friction pile foundations. Proc Conf Tall Buildings, Kuala Lumpur, Dec 1974, no 3, pp 7-19.
- COOKE, R W and G PRICE (1973): Strains and displacements around friction piles. Proc 8th Int Conf SM&FE, Moscow, vol 2.1, pp 53-60.
- COOLING, L F and W H WARD (1953): Measurements of loads and strains in earth supporting structures. Proc 3rd Int Conf SM&FE, Zurich, pp 162-166.
- COWLEY, B E, E G HAGGAR and W J LARNACH (1974): A comparison between the observed and estimated settlements of three large cold stores in Grimsby. Proc Conf Settlement of Structures, Cambridge. Pentech Press, London, pp 79-90.
- COYLE, H M and L C REESE (1966): Load transfer for axially loaded piles in clay. Proc ASCE, vol 92, no SM2, pp 1-26.
- CRAWFORD, C B and J G SUTHERLAND (1971): The Empress Hotel, Victoria, British Columbia. Sixty-five Years of Foundation Settlements. Canad Geotech Jnl, vol 8, pp 77-93.
- CROOKS, J H A and J GRAHAM (1976): Geotechnical properties of the Belfast estuarine deposits. Geotechnique, vol 26, no 2, pp 293-315.
- DALMATOV, B I et al (1973): Investigation of soil deformation in foundation beds of structures. Proc 8th Int Conf SM&FE, Moscow, vol 1.3, pp 55-60.
- D'APPOLONIA, D J (1971): Effects of foundation construction on nearby structures. Proc 4th Panam Conf SM&FE, vol 1, pp 189-236.
- D'APPOLONIA, D J, E D'APPOLONIA and R F BRISETTE (1968): Settlement of spread footings on sand. Proc ASCE, Jnl Soil Mech Found Div, no SM3, pp 735-760.
- D'APPOLONIA, D J and T W LANBE (1971): Performance of four foundations on end-bearing piles. Jnl Soil Mech Found Div, Proc ASCE, vol 97, no SM1, pp 77-93.
- D'APPOLONIA, H G POULOS and C C LADD (1971): Initial settlement of structures on clay. Jnl Soil Mech Found Div, ASCE, vol 97, no SM10, pp 1359-1377.
- D'APPOLONIA, E and J P ROMUALDI (1963): Load transfer in end-bearing steel H-piles. Jnl Soil Mech Found Div, Proc ASCE, vol 93, no SM2, pp 1-25.
- DAVIS, E H and H G POULOS (1963): Triaxial testing and three dimensional settlement analysis. Proc 4th Austr-New Zealand Conf SM&FE, Adelaide, pp 233-243.
- DAVIS, E H and H G POULOS (1968): The use of elastic theory for settlement prediction under three dimensional conditions. Geotechnique, vol 18, no 1, pp 67-91.
- DAVIS, E H and H G POULOS (1972): Rate of settlement under three-dimensional conditions. Geotechnique, vol 22, no 1, pp 95-114.
- DAVISSON, M T (1972): Settlement histories of two pile supported grain silos. Proc Conf on Performance Earth-Supported Structures, Purdue Univ, vol 1 part 2, pp 1155-1167.

- DAVISSON, M T and J R SALLEY (1972): Settlement histories of four large tanks on sand. Proc Spec Conf Perf Earth and Earth-Supported Structures, Purdue, ASCE, pp 981-996.
- de BEER, E E and A MARTEENS (1957): Method of computation of an upper limit for the influence of the heterogeneity of sand layers on the settlement of bridges. Proc 4th Int Conf SM&FE, vol 1, pp 275-282.
- DEERE, D U and M T DAVISSON (1961): Behaviour of grain elevator foundations subjected to cyclic loading. Proc 5th Int Conf SM&FE, vol 1, pp 629-633.
- DE JONG, J and M C HARRIS (1971): Settlements of two multistorey buildings in Edmonton. Can Geotech Jnl, vol 8, no 2, pp 217-235.
- DE JONG, J and N R MORGENSTERN (1971): The influence of structural rigidity on the foundation loads of the CN tower, Edmonton. Canad Geotech Jnl, vol 8, no 4, pp 527-537.
- DE JONG, J and N R MORGENSTERN (1973): Heave and settlement of two tall building foundations in Edmonton, Alberta. Canad Geotech Jnl, vol 10, no 2, pp 261-281.
- de MELLO, V F B (1969): Foundations of buildings in clay. State of the art report. Proc 7th Int Conf SM&FE, Mexico, Special vol, pp 49-136.
- de MELLO, V F B (1971): The Standard Penetration Test. State of the art review. Proc 4th Panam Conf SM&FE, Puerto Ric, vol 1, pp 1-86.
- de MELLO, V F B (1972): Thoughts on soil engineering applicable to residual soils. Proc 3rd Southeast Asian Conf on Soil Eng, Hong Kong, pp 5-40.
- de MELLO, V F B (1975a): Discussion - Session 3. Proc 6th Regional Conf for Africa SM&FE, vol 2, pp 105-106.
- de MELLO, V F B (1975b): The philosophy of statistics and probability applied in soil mechanics - General Report. Proc 2nd Int Conf on Statistics and Probability Applied to Civil Engineering. Stuttgart.
- DESAI, C S (1976): Editor 2nd Int Conf Num Methods in Geomechanics, Blacksburg, ASCE, New York.
- de SIMONE, S V (1966): Suggested design procedures for combined footings and mats. Jnl Am Concr Inst, Oct 1966, pp 1041-1057.
- de SIMONE, S V and J P GOULD (1972): Performance of two mat foundations on Boston Blue Clay. Proc Spec Conf on Performance of Earth and Earth-Supported Structures, Purdue, vol 1.2, pp 953-980.
- DOLLERL, A, A HONDL and E PROKSCH (1976): Der U-Bahn Bau und die Massnahmen zum Schutz des Stephansdomes. Proc 6th Eur Conf SM&FE, vol 1.1, pp 119-126.
- DOROSHEVICH, N M and BARPOLOMEY, AA (1965): Discussion. Proc 6th Int Conf SM&FE, vol 3, pp 484-485.
- DUNN, C S (1974): Settlement of a large raft foundation on sand. Conf Settlement of Structures, Cambridge, Pentech Press, London, pp 14-21.
- EDEN, W J, G C McROSTIE and J S HALL (1973): Measured contact pressures below raft supporting a stiff building. Canad Geotech Jnl, vol 10, pp 180-192.
- EGOROV, K E, O V KITAJKINA and A N CHERVJAKO (1974): Investigation of layer by layer deformation of soils. Proc 4th Danube Conf SM&FE, vol 1, pp 161-167.
- EGOROV, K E, P G KUZMIN, and B P POPOV (1957): The observed settlements of buildings as compared with preliminary calculation. Proc 4th Int Conf SM&FE, London, vol 1, pp 291-296.
- ELLISON, R D, E D'APLONIA and G R THIERS (1971): Load deformation mechanism for bored piles. Jnl Soil Mech Div, ASCE, vol 97, no SM4, pp 661-678.
- ELVERY, R H (1966): Problems associated with the field measurement of stresses in concrete structures. Conf Stresses in Service, Inst Civ Engrs, London, pp 43-55.
- ERB, Ch (1963): Setzungsmessungen an einem Hochhaus. Proc Eur Conf SM&FE, Wiesbaden, vol 1, pp 241-243.
- FELD, J (1965): Tolerance of structures to settlement. Jnl SM Div, ASCE, May, pp 63-77.
- FELLENBIUS, B H (1975): Test loading of piles and new proof testing procedure. Jnl Geotech Div, Proc ASCE vol 101, no GT9, pp 855-869.
- FJELD, S (1963): Settlement damage to a concrete-framed structures. Proc Europ Conf SM&FE, Wiesbaden vol 1, p 391.
- FOSS, I (1969): Secondary settlements of buildings on Drannan, Norway. Proc 7th Int Conf SM&FE, vol 2, pp 99-106.
- FOX, E N (1948): The mean elastic settlement of uniformly loaded area at a depth below ground surface. Proc 2nd Int Conf SM&FE, Rotterdam, vol 1, p 129.
- FOX, L (1948): Computation of traffic stresses in a simple road structure. Proc 2nd Int Conf SM&FE, vol 2, pp 236-246.
- FRASER, R A (1976): Outline of solutions available for the design of raft foundations. Div App Geomechanics Tech Paper no 25, CSIRO, Australia.
- FRASER, R A and L J WARDLE (1976): Numerical analysis of rectangular rafts on layered foundations. Geotechnique, vol 26, no 4, pp 613-630.
- GAMBIN, M Ph (1963): Calcul du tassement d'une fondation profonde en fonction de resultats pressiometriques. Sols:Soils, vol 2, no 7, pp 11-31.
- GARGA, V K and J T QUINN (1974): An investigation on settlements of direct foundations on sand. Proc Conf Settlement of Structures, Cambridge, Pentech Press, London, pp 22-36.
- GARLANGER, J E (1972): The consolidation of soils exhibiting creep under constant effective stress.

- Geotechnique, vol 22, no 1, pp 71-78.
- GERRARD, C M and W J HARRISON (1970a): Circular loads applied to a cross-anisotropic half space. CSIRO Australia, Div App Geomech, Tech Paper no 8.
- GERRARD, C M and W J HARRISON (1970b): Stresses and displacements in a loaded orthorhombic half-space. CSIRO Australia, Div App Geomech, Tech Paper no 9.
- GERRARD, C M, M KURZEME, D C ANDREWS and R TOPP (1971): Instrumentation of raft foundations in Perth. Proc 1st Aus-New Zealand Conf Geomechanics, vol 1, pp 361-368.
- GIBSON, R E (1967): Some results concerning displacements and stresses in a non-homogeneous elastic half-space. Geotechnique, vol 17, no 1, pp 58-67.
- GIBSON, R E (1974): The analytical method in soil mechanics. 14th Rankine Lecture. Geotechnique, vol 24, no 2, pp 115-139.
- GIBSON, R E and G C SILLS (1971): Some results concerning the plane deformation of a non-homogeneous elastic half-space. Proc Roscoe Mem Symp, Cambridge Foulis, pp 564-572.
- GIRAULT, P (1964): Discussion on a paper: 'Tolerance of structures to settlement' by J Feld. ASCE Conf on Design of Foundations for Control of Settlement, Evanston.
- GIRAULT, P (1972): Settlement of some piled foundations in Mexico. Proc Spec Conf Performance of Earth and Earth-Supported Structures, Purdue Univ, June 11-14, vol 1, part 2, pp 1185-1205.
- GIROUD, J P (1970): The problem of elasticity in settlement calculation for foundation design. Proc 4th Congr Brazil Soc SM&FE, Rio de Janeiro, vol 1, no 2, V-1-V-9.
- GOLDER, H Q (1969): Panel Discussion - Session 2. Proc 7th Int Conf SM&FE, Mexico, vol 3, pp 227-230.
- GOLDER, H Q (1971): The allowable settlement of structures. State of the art review. Proc 4th Panman Conf SM&FE, Puerto Rico, vol 1, pp 171-187.
- GORBUNOV-POSSADOV, M I and S S DAVYDOV (1973): Interaction of soil bases and structures. Proc 8th Int Conf SM&FE, Moscow, vol 2, pp 41-92.
- GRANT, R, J T CHRISTIAN and E H VANMARCKE (1972): Tolerance of buildings to differential settlements. Soils Publication no 315, Dept of Civ Eng, MIT.
- GRANT, R, J T CHRISTIAN and E H VANMARCKE (1974): Differential settlement of buildings. Proc ASCE, vol 100, no GP9, pp 973-991.
- GREEN, G E (1973): General Report - Session 2. Symp Field Instrumentation, Butterworths, London, pp 517-526.
- GREGERSEN, O S, G AAS, and E DI BIAGIO (1973): Load tests on friction piles in loose sand. Proc 8th Int Conf SM&FE, vol 2.1, Moscow, pp 109-117.
- HANNA, T H (1963): Model studies of foundation groups in sand. Geotechnique, vol 13, pp 334-351.
- HANNA, T H (1973): Foundation instrumentation. Trans Tech Pub, USA.
- HANSBO, S, E HOFMANN and J MOESSON (1973): Östra Nordstaden, Gothenburg. Experiences concerning a difficult foundation problem and its unorthodox solution. Proc 8th Int Conf SM&FE, vol 2.2, pp 105-110.
- HANSBO, S and B A TORSTENSSON (1971): Sättningar vid grundläggning på morän. Byggnästaren, vol 50, no 4, pp 8-14.
- HAWLEY, J G and D L BORIN (1973): A unified theory for the consolidation of clays. Proc 8th Int Conf SM&FE, Moscow, vol 1.3, pp 107-119.
- HELL, H (1969): Studies on the structural rigidity of reinforced concrete building frames on clay. Proc 7th Int Conf SM&FE, Mexico, vol 2, pp 115-121.
- HIGHT, D W and P A GREEN (1976): The performance of a piled-raft foundation for a tall building in London. Proc 6th Europ Conf SM&FE, vol 1.2, pp 467-472.
- HOBBS, N B (1974): The factors affecting the prediction of the settlements of structures on rock - State of the Art Review. Conf Settlement of Structures, Cambridge, Pentech Press, London, pp 579-610.
- HOEG, K (1972): Finite element analysis of strain-softening material. Proc ASCE, Jnl GF Div, vol 98, No SM1, pp 43-58.
- HOEG, K, J T CHRISTIAN and R V WHITMAN (1968): Settlement of strip load on elastic-plastic soil. Jnl Soil Mech Found Div ASCE, vol 94, pp 431-446.
- HOLTZ, R D and G LINDSKOG (1972): Soil movements below test embankment. Proc Spec Conf on Performance of Earth and Earth-Supported Structures, Purdue vol 1.1, pp 273-284.
- HOLTZER, T L, K HOEG and K ARULANANDAN (1973): Excess pore pressures during undrained clay creep. Canad Geotech Jnl, vol 10, no 1, pp 12-24.
- HOOPER, J A (1973): Observations on the behaviour of a piled-raft foundation on London Clay. Proc Inst Civ Engrs, vol 55, pp 855-877.
- HOOPER, J A (1973a): Field instrumentation for long-term measurement of pile load and raft contact pressure. Civ Eng & Pub Wks Rev, May 1973, pp 438-446.
- HOOPER, J A (1973b): Observations on the behaviour of a piled-raft foundation on London Clay. Proc Instn Civ Engrs, vol 55, part 2, Dec, pp 855-877.
- HOOPER, J A (1974): Analysis of a circular raft in adhesive contact with a thick elastic layer. Geotechnique, vol 24, no 4, pp 561-580.
- HOOPER, J A (1975): Elastic settlement of a circular raft in adhesive contact with a transversely isotropic medium. Geotechnique, vol 25, no 4, pp 691-711.
- HOOPER, J A (1976): Reply to discussion on paper 'Elastic settlement of a circular raft in adhesive contact with a transversely isotropic medium'.

- Geotechnique, vol 26, no 3, pp 541.
- HOOPER, J A and L A WOOD (1976): Foundation analysis of a cross-wall structure. Proc Conf Perf of Buildg Structures, Glasgow, Pentech Press, pp 229-248.
- HORN, H M and T W LAMBE (1964): Settlement of buildings on the MIT Campus. Proc ASCE, vol 90, no SM5, pp 181-195.
- HWANG, C T, N R MORGENSTERN and D W MURRAY (1971): On solutions of plane strain consolidation problems by finite element methods. Canad Geotech Jnl, vol 8 pp 109-118.
- JANBU, N and K SENNESET (1973): Field compressometer - principles and applications. Proc 8th Int Conf SM&FE, Moscow, vol 1.1, pp 191-198.
- JENNINGS, J E, A B A BRINK and A A B WILLIAMS (1973): Revised guide to soil profiling for civil engineering purposes in Southern Africa. Trans SA Inst Civ Engrs, vol 15, no 1, pp 3-12.
- JENNINGS, J E and J E KERRICH (1962): The heaving of buildings and the associated economic consequences, with particular reference to the Orange Free State Goldfields. The Civ Engr in Sth Africa, 5:5:122.
- JOHANSSON, B (1970) Markproblem i Storstockhahn-sområdet. Byggnästaren, vol 49, no 6, pp 7-14.
- KERISEL, J (1975): Old structures in relation to soil conditions. 15th Rankine Lecture. Geotechnique, vol 25, no 3, pp 433-483.
- KERISEL, J and M QUATRE (1968): Settlements under foundations. Civ Eng Pub Wks Rev, May-June.
- KEZDI, A (1957): Bearing capacity of piles and pile groups. Proc 4th Int Conf SM&FE, vol 2, pp 46-51.
- KEZDI, A (1960): Bemerkungen zur Frage der Tragfähigkeit von Pfahlgruppen. Symp on Pile Foundatns, Stockholm, pp 89-96.
- KING, G J W and V S CHANDRASEKARAN (1974a): Interactive analysis of a rafted multistorey space frame resting on an inhomogeneous clay stratwn. Proc Conf FE Meth Engg, Univ NSW, pp 493-509.
- KING, G J W and V S CHANDRASEKARAN (1974b): An assessment of the effects of interaction between a structure and its foundation. Conf Settlement of Structures, Cambridge, Pentech Press, London, pp 368-383.
- KISHIDA, H (1967): Ultimate bearing capacity of piles driven into loose sand. Soils and Foundations, vol 7, no 3, pp 20-29.
- KLEPIKOV, S N et al (1973): Analysis of the foundation slabs and upper structure interaction. Proc 8th Int Conf SM&FE, Moscow, vol 1.3, pp 127-132.
- KOERNER, R M and A PARTOS (1974): Settlement of building on pile foundation in sand. Jnl Geot Div, ASCE, vol 100, no GT3, pp 265-278.
- KOIZUMI, Y and K ITO (1967): Field tests with regard to pile driving and bearing capacity of piled foundations. Soils and Foundations, vol 7, no 3, pp 30-53.
- KOVACS, W D and G A LEONARDS (1975): Settlement of buildings on pile foundation in sand. Jnl Geot Div Proc ASCE vol 101, no GT2, pp 209-211.
- KRIEGEL, H J and H H WIESNER (1973): Problems of stress-strain conditions in subsoil. Proc 8th Int Conf SM&FE, vol 1.3, pp 133-141.
- LACEY, W D and H T SWAIN (1957): Design for mining subsidence. Architects Jnl, vol 126, pp 557-570.
- LAMBE, T W (1964): Methods of estimating settlement. Jnl Soil Mech Found Div, ASCE, vol 90, no SM5, pp 43-67.
- LAMBE, T W (1973): Predictions in soil engineering. Geotechnique, vol 23, pp 151-202.
- LARNACH, W J (1970): Computation of settlements in building frames. Civ Engg Pub Wks Rev, vol 65, pp 1040-1043.
- LARNACH, W J and L A WOOD (1972): The effect of soil-structure interaction on settlements. Int Symp Comp Design, Dept Eng, Warwick Univ.
- LEONARDS, G A (1968): Predicting settlement of buildings on clay soils. Soil Mech Lecture Ser, Foundation Eng, Evanston, Illinois.
- LEONARDS, G A (1972): Settlement of pile foundations in granular soil. Proc Spec Conf Performance of Earth and Earth-Supported Structures, Purdue Univ, vol 1, part 2, pp 1169-1184.
- LEONARDS, G A (1972): Discussion on Shallow Foundations. Proc Spec Conf On Performance of Earth and Earth-Supported Structures, Purdue, vol 3, pp 169-173.
- LEONARDS, G A (1973): Discussion on paper by Crawford and Sutherland (1971): Canad Geotech Jnl, vol 10, pp 120-122.
- LEONARDS, G A (1974): Discussion - Session 1. Proc Conf Settlement of Structures, Cambridge, Pentech Press, London, p 669.
- LEONARDT, G (1973): Setzungskorrekturen an einem im Frankfurter Ton gegründeten Hochhaus. Dt Ges Erd-u Grundb, Essen, pp 211-218.
- LEWIS, W A, R T MURRAY and I F SYMONS (1976): Settlements and stability of embankments constructed on soft alluvial soils. Proc Instn Civ Engrs, part 2, vol 59, pp 571-593.
- LITTLE, W E R (1969): Discussion - Session 6. Proc Symp on Design for Movement in Buildings. The Concrete Soc, London.
- LITTLEJOHN, G S (1973): Monitoring foundation movements in relation to adjacent ground. Ground Eng, vol 6, no 4, pp 17-22.
- LITTLEJOHN, G S (1974): Observations of brick walls subjected to mining subsidence. Proc Conf on Settlement of Structures, Cambridge, Pentech Press, London, pp 384-393.

- MACHADO, J (1961): Settlement of structures in the city of Santos, Brazil. Proc 5th Int Conf SM&FE, Paris, vol 1, pp 719-725.
- MACLEOD, I A and G S LITTLEJOHN (1974): Discussion on Session 5. Conf Settlement of Structures, Cambridge, Pentech Press, London, pp 792-795.
- MAINSTONE, R J (1974): Discussion - Session 5. Proc Conf Settlement of Structures, Cambridge, Pentech Press, London, p 771.
- MAJID, K I and J S CRAIG (1971): An incremental finite element analysis of structural interaction with soil of non-linear properties. Proc Symp Int of Struct and Found, Birmingham, pp 131-145.
- MAJID, K I and M D CUNNELL (1976): A theoretical and experimental investigation into soil-structure interaction. Geotechnique, vol 26, no 2, pp 331-350.
- MANSUR, C I and A H HUNTER (1970): Pile tests - Arkansas River Project. Jnl Soil Mech Found Div, ASCE, no SM5, pp 1545-1582.
- MARSLAND, A (1971): Large in-situ tests to measure the properties of stiff fissured clays. Proc 1st Austr-New Zealand Conf on Geomechanics, Melbourne, pp 180-189.
- MARSLAND, A and R QUARTERMAN (1974): Further developments of multipoint magnetic extensometers for use in highly compressible ground. Geotechnique vol 24, pp 429-433.
- MASARSCH, K R (1976): Soil movements caused by pile driving in clay. Commission on Pile Res, Royal Swedish Acad of Eng Sci, Report 51, Stockholm, 261 pp.
- MATFES, N S and H G POULOS (1969): Settlement of single compressible pile. Jnl Soil Mech Found Div, Proc ASCE, vol 95, no SM1, pp 189-207.
- MEIGH, A C (1975): Soil Mechanics. Civ Eng Ref Book, Chapter 8, Newnes-Butterworths, London.
- MEIGH, A G (1976): The Triassic rocks, with particular reference to predicted and observed performance of some major foundations. 16th Rankine Lecture. Geotechnique, vol 26, no3, pp 391-452.
- MESRI, G (1973): Coefficient of secondary compression. Jnl Soil Mech Found Div, ASCE, vol 99, no SM1, pp 123-137.
- MEYERHOF, G (1947): The settlement analysis of building frames. Struct Engr, vol 25, pp 369-409.
- MEYERHOF, G G (1953): Some recent foundation research and its application to design. Struct Engr, vol 31, pp 151-167.
- MEYERHOF, G G (1956): Discussion on paper by Skempton et al 'Settlement analysis of six structures in Chicago and London'. Proc Instn Civ Engrs vol 5, no 1, p 170.
- MEYERHOF, G G (1959): Compaction of sand and bearing capacity of piles. Jnl Soil Mech Found Div, Proc ASCE, vol 85, no SM6, pp 1-30.
- MEYERHOF, G G (1965): Shallow foundations. Jnl Soil Mech Found Div, ASCE, vol 91, no SM2, pp 21-31.
- MEYERHOF, G G (1974a): Penetration testing in countries outside Europe. Proc European Symp Penetration Testing, Stockholm, vol 2.1, pp 40-48.
- MEYERHOF, G G (1974b): Ultimate bearing capacity of footings on sand layer overlying clay. Canad Geot Jnl, vol 11, no 2, pp 223-229.
- MEYERHOF, G G (1976): Bearing capacity and settlement of pile foundations. Jnl Geot Div, Proc ASCE, vol 102, no GT3, pp 197-228.
- MINDLIN, R D (1936): Force at a point in the interior of a semi-infinite solid. Physics, vol 7, May 1936, pp 195-202.
- MITCHELL, R J (1970): On the yielding and mechanical strength of Leda clay. Canad Geotech Jnl, vol 7, pp 297-312.
- MITCHELL, R J, D A SANGREY and G S WEBB (1972): Foundations in the crust of sensitive clay deposits. Proc Spec Conf Performance of Earth and Earth-Supported Structures, Purdue, vol 1.2, pp 1051-1072.
- MORETTO, O (1971): Discussion - Session 3. Proc 4th Panam Conf SM&FE, Puerto Rico, vol 3, pp 156-166.
- MORICE, P B and G D BASE (1953): The design and use of a demountable mechanical strain gauge for concrete structures. Mag Concr Res, vol 5, no 13, pp 37-42.
- MORGAN, J R and C M GERRARD (1971): Behaviour of sands under surface loads. Proc ASCE, vol 97, no SM6,
- MORGENSTERN, N R and A L T PHUKAN (1968): Stresses and displacements in a homogeneous non-linear foundation. Proc Int Symp Rock Mech, Madrid, pp 313-320.
- MORTON, K (1974): Discussion - Session 1. Proc Conf Settlement Structures, Cambridge, Pentech Press, London, pp 664-665.
- MORTON, K and E, AU (1974): Settlement observations on eight structures in London. Proc Conf Settlement of Structures, Cambridge, Pentech Press, London, pp 183-203.
- MURRAY, R T (1973): Computer program for multi-layer soil settlement. Civ Eng Pub Wks Rev, vol 68 pp 809; 1086-1097.
- NATIONAL COAL BOARD (1975): Subsidence Engineers Handbook. National Coal Board Production Dept, UK.
- NAYLOR, D J (1971): Discussion - Session 5. Proc Roscoe Mem Symp, Cambridge, Foulis, pp 611-617.
- NAYLOR, D J and J A HOOPER (1975): An effective Stress finite element analysis to predict the short and long-term behaviour at a piled raft foundation on London Clay. Conf Settlement of Structures, Pentech Press, pp 394-402.
- NAYLOR D J and O C ZIENKIEWICZ (1971): Settlement analysis of a strip footing using a critical state

- model in conjunction with finite elements. Proc Symp Int Struct and Found, Birmingham, pp 93-107.
- NAWY, E G (1968): Crack control in reinforced concrete structures. ACI Jnl, Oct 1968, pp 825-836.
- NIKITIN, N V, A I MUHALCUK and V I TRAVUS (1970): Issledovanie osadok fundamenta televizionnoj basni v Ostakino. Osnov Fund Mech Grunt, vol 12, no 2, pp 32-35.
- NONVEILLER, E (1963): Settlement of a grain silo on fine sand. Eur Conf SM&FE, Wiesbaden, vol 1, p 285.
- NORDIN, O and L SVENSSON (1974): Settlement of buildings founded on lightly overconsolidated clay in western Sweden. Conf Settlement of Structures, Cambridge, Pentech Press, London, pp 116-122.
- OHSAKI, Y and O SAKAGUCHI (1973): Major types of soil deposits in urban areas in Japan. Soils and Foundations, vol 13, no 2, pp 49-65.
- OHTA, H and S HATA (1973): Immediate and consolidation deformations of clay. Proc 8th Int Conf SM&FE Moscow, vol 1.3, pp 193-196.
- OHTA, H, S YOSHITANI and S BATA (1975): Anisotropic stress-strain relationship of clay and its application to finite element analysis. Soils and Foundations, vol 15, no 4, pp 61-79.
- PALMER, A C (1973): Editor. Proc Symp on the Role of Plasticity in Soil Mechanics. Cambridge Univ.
- PALMER, L A and E S BARBER (1940): Soil displacement under a circular loaded area. Proc High Res Board, vol 20, pp 279-286; 319-332.
- PARKER, A S and F V S BAYLISS (1970): The settlement behaviour of a group of large silos on piled foundations. Proc Conf Behaviour of Piles, Instn Civ Engrs, pp 59-69.
- PARKINSON, J J and G Y FENOUX (1976): Bottom heave of excavation in urban site. Proc 6th Eur Conf SM&FE, vol 1.2, pp 641-646.
- PARRY, R H G (1971): A direct method of estimating settlements in sands from SPT values. Proc Symp Int Struct and Found, Birmingham, pp 29-37.
- PECK, R B (1965): Bearing capacity and settlement: Certainties and uncertainties. Proc Symp Bearing Capacity and Settlement of Foundations, Duke Univ, pp 3-8.
- PECK, R B (1969): Deep excavations and tunnelling in soft ground: state of the art report. Proc 7th Int Conf SM&FE, Mexico, Spec vol, pp 225-290.
- PECK, R P (1973): Presidential Address. 8th Int Conf SM&FE, Moscow, vol 4.1, pp 156-159.
- PECK, R (1974): The selection of soil parameters for the design of foundations. Second Nabor Carrillo Lecture. Sociedad Mexicana de Mecanica de Suelos.
- PECK, R B, D U DEERE and J L CAPACENTE (1956): Discussion on paper by Skempton, A W and Macdonald, D H 'The allowable settlements of buildings'. Proc Instn Civ Engrs, part 3, vol 5, p 778.
- PENMAN, A D M and G H WATSON (1963): Settlement observations on an oil tank. Proc Eur Conf SM&FE, Wiesbaden, vol 1, pp 163-171.
- PICHLER, E (1948): Regional study of the soils from Sao Paulo, Brazil. Proc 2nd Int Conf SM&FE, vol 3, p 222.
- POLSHIN, D E and R A TOKAR (1957): Maximum allowable non-uniform settlement of structures. Proc 4th Int Conf SM&FE, vol 1, p 402.
- POOROOSHAB, H P (1969): Advances in consolidation theories for clays. Proc 7th Int Conf SM&FE, vol 3, pp 491-497.
- POULOS, H G (1968): Analysis of the settlement of pile groups. Geotechnique, vol 18, no 4, pp 449-471.
- POULOS, H G (1972): Load-settlement prediction for piles and piers. Jnl Soil Mech Found Div, ASCE, vol 98, no SM9, pp 879-897.
- POULOS, H G (1974a): Some recent developments in the theoretical analysis of pile behaviour. Soil Mechanics - New Horizons, K Lee, ed. Newnes-Butterworths London, pp 237-279.
- POULOS, H G (1974b): Settlement analysis of structural foundation systems. Univ of Sydney, School of Civ Eng, Res Report R248.
- POULOS, H G and E H DAVIS (1968): The settlement behaviour of single axially loaded piles and piers. Geotechnique, vol 18, no 3, pp 351-371.
- POULOS, H G and E H DAVIS (1974): Elastic solutions for soil and rock mechanics. J Wiley & Sons, New York.
- POULOS, H G and N S MATTES (1969): The behaviour of axially loaded end-bearing piles. Geotechnique, vol 19, pp 285-300.
- RABINOVICI, A (1970): Action reciproque entre la structure et le sol de fondation. Bull Techn Suisse Rom, vol 96, no 9, pp 131-137.
- REESE, L C (1964): Load versus settlement for an axially loaded pile. Proc Symp on Bearing Capacity of Piles, Central Bldg Res Inst, Roorkee, India, part 2, pp 18-38.
- Rendulic, L (1936): Relation between void ratio and effective principal stresses for a remoulded silty clay. Proc 1st Int Conf SM&FE, vol 3, pp 48-51.
- RESENDIZ, D, J A NIETO and J FIGUEROA (1967): The elastic properties of saturated clays from field and laboratory measurements. Proc 3rd Panam Conf SM&FE, Venezuela, vol 1, pp 443-466.
- RIGBY, C A and DEKEMA (1952): Crack-resistant housing. Pub Wks of South Africa, vol 2, no 95.
- RIOS, L and F PACHECO SILVA (1948): Foundations in Downtown, Sao Paulo, Brazil. Proc 2nd Int Conf SM&FE, vol 4, p 69.
- RIVKIN, S (1974): Issledovanie vzaimodejstvija svjazevogo karkasa zdanija, fundamentnoj plity i gruntovogo osnovanija. Osnov Fund Mech Grunt, 16, 6-9.

- ROSCOE, K H and J B BURLAND (1968): On the generalised stress-strain behaviour of 'wet' clay. Symp Eng Plasticity, Cambridge, pp 535-610.
- ROWE, P W (1968): The influence of geological features of clay deposits on the design and performance of sand drains. Proc Instn Civ Engrs, Supplement, pp 1-72.
- ROWE, P W (1972): The relevance of soil fabric to site investigation practice. 12th Rankine Lecture. Geotechnique, vol 22, no 2, pp 195-300.
- ROWE, P W (1974): Discussion - Session 1. Proc Conf Settlement of Structures, Cambridge, Pentech Press, London, p 670.
- ROWE, P W and L BARDEN (1965): A new consolidation cell. Geotechnique, vol 16, pp 162-170.
- SAMUELS, S G and J E CHENEY (1974): Long-term heave of a building on clay due to tree removal. Proc Conf Settlement of Structures, Cambridge, Pentech Press, London, 212-220.
- SANDHU, R S and E L WILSON (1969): Finite element analysis of seepage in elastic media. Proc ASCE, vol 95, no EM3, pp 641-652.
- SANGLERAT, G (1972): The penetrometer and soil exploration. Elsevier-North Holland, 464 pp.
- SCHMERMANN, J H (1970): Static cone to compute static settlement over sand. Jnl Soil Mech Found Div, ASCE, vol 96, no SM3, pp 1011-1043.
- SCHOFIELD, A N and C P WROTH (1968): Critical State Soil Mechanics. McGraw-Hill, London.
- SCHULTZE, E and G SHERIF (1973): Prediction of settlements from evaluated settlement observations for sand. Proc 8th Int Conf SM&FE, vol 1.3, pp 225-230.
- SCOTT, R F (1963): Principles of Soil Mechanics. Addison-Wesley Pub Co.
- SCOTT, R and H Y KO (1969): Stress deformation and strength characteristics - State of the Art Report. Proc 7th Int Conf SM&FE, Mexico, Spec vol, pp 1-47.
- SCHIFFMAN, R L, A T CHEN and J C JORDAN (1969): An analysis of consolidation theories. Proc ASCE, Jnl Soil Mech Found Div, vol 95, pp 285-312.
- SCHIFFMAN, R and R GIBSON (1964): Consolidation of non-homogeneous clay layers. Proc ASCE, Jnl Soil Mech Found Div, vol 90, no SM5, pp 1.
- SEED, H B and L C REESE (1957): The action of soft clay along friction piles. Trans ASCE, vol 122, pp 731-754.
- SIAM, K F and J R BUSBRIDGE (1976): 31 m deep excavation for construction of Barton anchorage of Humber Bridge. Proc 6th Eur Conf SM&FE, Vienna, vol 1.2, pp 651-656.
- SIMONS, N E (1974): Normally consolidated and lightly over-consolidated cohesive materials: State of the Art Review. Conf Settlement of Structures, Cambridge, Pentech Press, London, pp 500-530.
- SIMONS, N (1976): Discussion. The Structural Engr, vol 54, no 8, p 301.
- SIMONS, N E and B K MENZIES (1975): A short course in foundation engineering. IPC Science and Tech Press.
- SIMONS, N E and N N SOM (1969): The influence of lateral stresses on the stress deformation characteristics of London Clay. Proc 7th Int Conf SM&FE, Mexico, vol 1, pp 369-377.
- SIMONS, N E and N N SOM (1970): Settlement of structures on clay with particular emphasis on London Clay CIRIA Report 22, London.
- SIMPSON, B (1971): Discussion - Session 5. Proc Roscoe Mem Symp, Cambridge. Foulis, pp 609-611.
- SKEMPTON, A W (1953): Discussion on piles and pile foundations. Proc 3rd Int Conf SM&FE, vol 3, p 172.
- SKEMPTON, A W (1957): Discussion - Session 5. Proc 4th Int Conf SM&FE, vol 3, pp 159-150.
- SKEMPTON, A W and L BJERRUM (1957): A contribution to the settlement analysis of foundations on clay. Geotechnique, vol 7, no 4, pp 168-178.
- SKEMPTON, A W and D H MacDONALD (1956): Allowable settlement of buildings. Proc Instn Civ Engrs, part 3, vol 5, pp 727-768.
- SKEMPTON, A W, R B PECK and D H MacDONALD (1955): Settlement analyses of six structures in Chicago and London. Proc Instn Civ Engrs, vol 4, no 4, p 525.
- SMALL, J C, J R BOOKER and E H DAVIS (1976): Elastoplastic consolidation of soil. Int Jnl Solids Structures, vol 12, pp 431-448.
- SMITH, I M (1970): A finite element approach to elastic soil-structure interaction, Canad Geotech Jnl, vol 7, no 2, pp 95-105.
- SMITH, I M and R HOBBS (1976): Biot analysis of consolidation beneath embankments. Geotechnique, vol 26, no 1, pp 149-171.
- SMITH, P D K and J B BURLAND (1976): Performance of a high precision multi-point borehole extensometer in soft rock. Canad Geotech Jnl, vol 13, no 2, pp 172-176.
- SOMMER, H (1965): A method for the calculation of settlements, contact pressures, and bending moments in a foundation including the influence of the flexural rigidity of the super-structure. Proc 6th Int Conf SM&FE, Montreal, vol 2, pp 197-201.
- SOVINC, I (1961): Stresses and displacements in a limited layer of uniform thickness, resting on a rigid base and subjected to a uniformly distributed flexible load of rectangular shape. Proc 5th Int Conf SM&FE, vol 1, pp 823-827.
- SOWERS, G F, C B MARTIN, L L WILSON and M FAU-SOLD (1961): The bearing capacity of friction pile groups in homogeneous clay from model studies. Proc 5th Int Conf SM&FE, vol 2, pp 155-159.
- STEINFELD, K (1968): Zur Gründung von 60-geschossigen Hochhäusern in Hamburg. Dt Ges Erd- u Grundb,

- Essen, pp 35-103.
- SUKIJE, L (1957): The analysis of the consolidation process by the isotache method. Proc 4th Int Conf SM&FE, London, vol 1, pp 200-206.
- SUKIJE, L (1969): Rheological aspects of soil mechanics. Wiley-Interscience, London.
- SUKLE, L and I SOVINC (1963): An applied analysis of distortional displacements of normally consolidated clays. Proc Eur Conf SM&FE, Wiesbaden, vol 1, pp 193-198.
- SULLIVAN, A (1974): Discussion - Session 3. Conf Settlement of Structures, Cambridge, Pentech Press, London, pp 733-734.
- SUTHERLAND, H B (1974): Granular materials - State of the Art Report. Proc Conf Settlement of Structures, Cambridge, Pentech Press, London, pp 473-499.
- SUTHERLAND, H and J A LINDSAY (1961): The measurement of load distribution under two adjacent column footings. Proc 5th Int Conf SM&FE, Paris, vol 1, pp 829-835.
- SVEC, O J and G M L GLADWELL (1973): A triangular plate bending element for contact problems. Int Jnl Solids Struct, vol 9, pp 435-446.
- SWAMY, R N and M M A POTTER (1976): Long-term movements in an eight-storey reinforced concrete structure. Conf Perf Building Structures, Glasgow, Pentech Press, London, pp 420-429.
- SWIGER, W F (1972): Subsurface investigations for design and construction of foundations of buildings. Task Committee for Foundation Design Manual of the Soil Mech and Foundations Div. Jnl SM Div, ASCE, vol 98, nos SM5-SM8.
- TEIXEIRA, A H (1959): Typical subsoil conditions and settlement problems in Santos, Brazil. 1st Panam Conf SM&FE, Mexico, vol 1, pp 149-215.
- TEJCHMAN, A F (1973): Model investigations of pile groups in sand. Jnl Soil Mech Found Div ASCE, vol 99 no SM2, pp 199-217.
- TERZAGHI, K (1935): The actual factor of safety in foundations. Struc Eng, vol 13, p 126.
- TERZAGHI, K (1943): Theoretical Soil Mechanics. John Wiley and Sons, New York.
- TERZAGHI, K (1956): Discussion on paper by Skempton and MacDonald 'The allowable settlements of buildings'. Proc Instn Civ Engrs, part 3, vol 5, p 775.
- TERZAGHI, K and R B PECK (1967): Soil Mechanics in Engineering Practice. Wiley, New York.
- THURMAN, A G and E D'APPOLONIA (1965): Computed movement of friction and end-bearing piles embedded in uniform and stratified soils. Proc 6th Int Conf SM&FE, Montreal, vol 2, pp 323-327.
- TIMOSHENKO, S (1957): Strength of Materials - Part 1 D van Nostrand Co Inc, London.
- THORBURN, S and R S L MOVICAR (1974): The performance of buildings founded on river alluvium. Proc Conf Settlement of Structures, Cambridge, Pentech Press, London, pp 425-442.
- TOMONO, M, M KAKURAI and M OKADA (1976): Ground and structure behaviour observed during the period of construction of a large underground structure by reverse process. Takenaka Tech Res Report no 15, Takenaka Komuten Co Ltd, Osaka.
- TORSTENSSON, B A (1971): Settlements of structures founded on floating piles. Byggnadstaren, vol 50, no 5, pp 10-17, Stockholm.
- TSCHBOTARIOFF, G P (1940): Settlement studies of structures in Egypt. Proc ASCE, pp 519-972.
- TSCHBOTARIOFF, G P (1973): Foundations, Retaining and Earth Structures. McGraw Hill Book Co.
- TSYTOVICH, N A (1961): General Report - Division 3/A Proc 5th Int Conf SM&FE, vol 2, pp 824-835.
- VALLIAPPAN, S, S HAIN and I K LEE (1975): Editors. Soil Mechanics - Recent Developments. Univ New South Wales, Australia.
- VARGAS, M (1948): Building settlement observations in Sao Paulo. Proc 2nd Int Conf SM&FE, vol 4, p 13.
- VARGAS, M (1955): Foundation of structures on over-consolidated clay layers in Sao Paulo. Geotechnique vol 5, pp 253-266.
- VARGAS, M and F P SILVA (1973): Settlement of tall buildings in Sao Paulo and Santos. Proc Panam Reg Con On Tall Buildings, Porto Alegre.
- VESIC, A S (1973): Contribution to discussion - Session 2. Proc 8th Int Conf SM&FE, vol 4.2, pp 51-52.
- VESIC, A S (1968): Load transfer, lateral loads and group action of deep foundations. Symp on Perf of Deep Foundations, Spec Tech Pub 44, ASTM, pp 5-14.
- VESIC, A S (1969): Experiments with instrumented pile groups in sand. ASTM Spec Pub no 444, pp 177-222.
- VESIC, A S (1975): Principles of pile foundation design. Duke Univ, Soil Mech Series no 38, 46 pp.
- WARD, W H (1956): Discussion on paper by Skempton and MacDonald 'The allowable settlement of buildings' Proc Instn Civ Engrs, part 3, vol 5, pp 782.
- WARD, W H (1974): Discussion on Session 5. Conf on Settlement of Structures, Cambridge, Pentech Press, London, pp 795-796.
- WARD, W H, J B BURLAND and R W GALLOIS (1968): Geotechnical assessment of a site at Mundford, Norfolk, for a large proton accelerator. Geotechnique, vol 18, pp 399-431.
- WARD, W H and J B BURLAND (1973): The use of ground strain measurements in civil engineering. Phil Trans Roy Soc, London A, vol 274, pp 421-428.
- WARDLE, L J and R A FRASER (1974): Finite element analysis of a plate on a layered cross-anisotropic

- foundation. Conf Finite Element Methods in Eng, Univ NSW, pp 565-578.
- WHITAKER, T and R W COOKE (1966): An investigation of the shaft and base resistance of large bored piles in London Clay. Proc Large Bored Piles, Instn Civ Engrs, London, pp 7-50.
- WONG, P K K and R J MITCHELL (1975): Yielding and plastic flow of sensitive cemented clay. Geotechnique, vol 25, no 4, pp 763-782.
- WOOD, L A and W J LARNACH (1974): The effects of soil-structure interaction on raft foundations. Proc Conf Settlement of Structures, Cambridge, Pentech Press, London, pp 460-470.
- WOOD, L A and W J LARNACH (1975): The interactive behaviour of a soil-structure system and its effect on settlement. Symp Analysis Soil Behaviour and its Application to Geotechnical Structures. Univ NSW.
- WOOD, R H (1952): Studies in composite construction. Part 1, National Building Studies, Res paper 13, London HMSO.
- WOOD, R H and R J MAINSTONE (1955): Stress measurements in the steel frame of the new Government Offices, Whitehall Gardens. Proc Conf on the Correlation between Calc and Obs Stresses and Disp in Structures. Instn Civ Enrs, London, pp 74-106.
- WROTH, C P (1971): Some aspects of the elastic behaviour of overconsolidated clay. Proc Roscoe Mem Symp, Foulis, pp 347-361.
- WROTH, C P (1976a): General Report to Session 3/A. Conf Performance of Building Structures, Glasgow, Pentech Press, London.
- WROTH, C P (1976b): The predicted performance of soft clay under a trial embankment loading based on the Cam-clay model. *Finite Elements in Geomechanics* editor G Gudehus, J Wiley & Son Ltd.
- WROTH, C P and B SIMPSON (1972): An induced failure at a trial embankment: Part 2: Finite Element Computations. Proc Spec Conf on Performance of Earth and Earth-Supported Structures, Purdue, vol 1.1, pp 65-79.
- YEGOROV, K E and A NICHIPOROVICH (1961): Research on the deflection of foundations. Proc 5th Int Conf SM&FE, Paris, vol 1, pp 861-866.
- YU, T M, W Y SHU and Y X TONG (1965): Settlement analysis of pile foundations in Shanghai. Proc 6th Int Conf SM&FE, vol 2, pp 356-359.
- ZEEVAERT, L (1973): Foundation Engineering for Difficult Subsoil Conditions. van Nostrand Reinhold Co, New York.