

Codification through the 2012 Legislative session
Subchapters 1, 3, 9, 10 & 15; Appendix C
Board adoption - February 24, 2012
Gubernatorial approval - April 16, 2012
Legislative approval - May 2, 2012
Effective date - July 1, 2012

**TITLE 252. DEPARTMENT OF ENVIRONMENTAL QUALITY
CHAPTER 641. INDIVIDUAL AND SMALL PUBLIC ON-SITE SEWAGE
TREATMENT SYSTEMS**

Subchapter	
1. General Provisions.....	252:641-1-1
3. Soil Tests.....	252:641-3-1
5. Building Sewer and Collection Systems.....	252:641-5-1
7. Septic Tanks.....	252:641-7-1
9. Pump Tanks.....	252:641-9-1
10. Aerobic Treatment Systems.....	252:641-10-1
11. Subsurface Systems [REVOKED].....	252:641-11-1
12. Dispersal Fields.....	252:641-12-1
13. Aerobic Systems [REVOKED].....	252:641-13-1
15. Lagoons.....	252:641-15-1
17. Alternative Systems [REVOKED].....	252:641-17-1
19. [RESERVED].....	252:641-19-1
21. Certification for On-Site Sewage Treatment System Installers.....	252:641-21-1
22. Certification for Persons Who Perform Soil Profile Descriptions.....	252:641-22-1
23. Fees.....	252:641-23-1
Appendix A.	System Options with Minimum Vertical Separation Distances and Minimum Lot Size Requirements
Appendix B.	Soil Groups
Appendix C.	Pipe Specifications for On-Site Sewage Treatment Systems
Appendix D.	Sampling Frequency & Testing Requirements for On-Site Sewage Application of Treated Sewage [REVOKED]
Appendix E.	Horizontal Separation Distance Requirements for On-Site Sewage Treatment Systems
Appendix F.	Estimated Average Daily Flow for Small Public On-Site Sewage Treatment Systems
Appendix G.	Minimum Trench Length for Subsurface Absorption Systems [REVOKED]
Appendix H.	Size Charts for On-Site Sewage Treatment Systems
Appendix I.	Example of the Requirements for a Septic Tank
Appendix J.	Example of the Requirements for Pump Tank
Appendix K.	Example Layouts of Conventional Subsurface Absorption Systems, Low Pressure Dosing Systems and ET/A Systems
Appendix L.	Examples of Retention and Distribution Structures
Appendix M.	Examples of Trench Installation
Appendix N.	Examples of Chambers Being Used for Storage and Disposal
Appendix O.	Examples of Lagoon Installation

SUBCHAPTER 1. GENERAL PROVISIONS

Section

- 252:641-1-1. Purpose, authority and applicability
- 252:641-1-2. Definitions
- 252:641-1-2.1 Authorizations and permits for on-site sewage treatment systems
- 252:641-1-3. General requirements for on-site sewage treatment systems
- 252:641-1-4. Operation, repairs and maintenance
- 252:641-1-5. Enforcement

252:641-1-1. Purpose, authority and applicability

(a) **Purpose.** The purpose of this Chapter is to ensure that sewage is properly treated in order to protect the waters of the State, the public health and the environment. This Chapter establishes requirements for the design, construction, installation and operation of individual and small public on-site sewage treatment systems. This Chapter also establishes requirements for persons seeking certification as installers of on-site sewage treatment systems and for persons seeking certification to perform soil profile descriptions to be used to design on-site sewage treatment systems.

(b) **Authority.** This Chapter is authorized by 27A O.S. §§ 2-2-101, 2-2-201, 2-6-402 and 403; and 59 O.S. § 1158.

(c) **Applicability.** The rules in this Chapter apply to:

(1) Any person who owns, designs, constructs, installs, modifies, repairs or operates an on-site sewage treatment system;

(2) Any person who seeks certification from the DEQ to install, modify or repair on-site sewage treatment systems; and/or

(3) Any person who seeks certification from the DEQ to perform soil profile descriptions to be used to design on-site sewage treatment systems.

(d) **Disclaimer.** The design standards contained in this Chapter are established as minimum criteria and do not guarantee a system's performance.

(e) **Appendices.** All references to appendices are appendices to this Chapter.

252:641-1-2. Definitions

In addition to the definitions contained in the Environmental Quality Code (27A O.S. § 2-1-101 *et seq.*), the following words, terms and acronyms, when used in this Chapter, shall have the following meaning, unless the context clearly indicates otherwise:

"Aerobic treatment unit" means a treatment unit that provides digestion of organic matter through oxidation and has been tested and certified by an ANSI accredited certifier as meeting the most current ANSI/NSF Standard 40, whether or not it includes nitrogen reduction..

"Alternative system" means an on-site sewage treatment system that varies from the requirements of on-site sewage treatment systems described in this Chapter.

"ANSI" means the American National Standards Institute.

"ASTM" means the American Society for Testing and Materials.

"Certified installer" means a person in the business of installing or constructing on-site sewage treatment systems who has been certified by the DEQ to inspect and approve his/her own installations.

"Certified soil profiler" means a person who has been certified by the DEQ to perform soil profile descriptions to be used to design on-site sewage treatment systems.

"Chamber" means a molded rigid plastic, arch shaped, hollow structure with an open bottom area and sidewalls that are designed to allow effluent to flow into the surrounding soil while preventing soil from migrating into the chamber.

"Conventional subsurface absorption field" means a gravity-fed subsurface dispersal field, which may be preceded by a lift station, that provides treatment through soil absorption in media-filled (e.g., gravel, polystyrene, chamber, etc.) trenches. This does not include ET/A or shallow extended dispersal fields.

"CSA" means the Canadian Standards Association.

"DEQ" means the Department of Environmental Quality.

"Designer" means the person who conducts the soil test and/or completes the DEQ Form 641-581P or 641-581SP for submission to the DEQ.

"Dispersal site" means the ten-thousand-square-foot (10,000 ft²) rectangular area that contains the test holes used to design the dispersal field.

"Distribution structure" means a watertight concrete or plastic compartment, box, or solid piping that allows the distribution of sewage at the same elevation throughout the subsurface treatment field.

"Drip irrigation" means the use of pressure to distribute aerobically treated effluent to a subsurface dispersal field using small diameter tubing equipped with pressure compensating emitters.

"Evapotranspiration/absorption (ET/A)" means the subsurface dispersal of sewage for treatment through evaporation, transpiration and absorption.

"Flow equalization tank" means a storage reservoir that contains an automatically controlled pump that is capable of delivering sewage to an on-site sewage treatment system at a specific hourly rate.

"IAPMO" means the International Association of Plumbing and Mechanical Officials.

"Individual on-site sewage treatment system" means an on-site sewage treatment system that treats sewage from one individual residence or a duplex with one owner.

"Installer" means any person who installs an on-site sewage treatment system or who is in the business of contracting to install or furnishing labor to install on-site sewage treatment systems.

"Level" means within a four-inch range of the same elevation.

"Lift station" means a short-term storage reservoir, containing an automatically controlled pump, that pumps sewage to a higher elevation for treatment.

"Low pressure dosing" means the use of pressure to distribute effluent evenly throughout the dispersal field through small diameter perforated piping.

"Major earth fill area" means any area where soil has been added to change the elevation from the original ground level by more than one (1) foot.

"Modification" means the expansion or relocation of any part of an existing on-site sewage treatment system, which does not fall under the definition of new installation.

"New installation" means the installation of a new on-site sewage treatment system. This includes the replacement of an existing lagoon, aerobic treatment unit and/or dispersal field, even when the existing septic tank is not replaced.

"NSF" means the National Sanitation Foundation.

"On-site sewage treatment system" means an individual or small public on-site sewage treatment system as defined in this Chapter.

"Redoximorphic soil features" means soil that, due to wetness, contains features that exhibit a color of less than or equal to two (2) chroma and greater than or equal to four (4) value in concentrations greater than five percent (5%) in two (2) consecutive intervals.

"Repair" means the repair of any part of an existing on-site sewage treatment system or the replacement of any part of an existing on-site sewage treatment system as long as the replacement part is placed in the exact same location that the original part had been located. Repair does not include excavation and replacement of a subsurface absorption trench.

"Retention structure" is a sealed concrete or plastic structure that retains sewage until it reaches a depth of ten inches (10") and then allows it to flow to another trench.

"Rock fragments" means unattached pieces of rock two millimeters (2 mm) in diameter or larger that are resistant to rupture (strongly cemented or extremely hard).

"Scenic river corridor" means the two-mile wide area surrounding each scenic river as designated in 82 O.S. § 1452, with the center of each scenic river being the center of the corridor.

"Sewage" means wastewater that generally originates as human waste from certain activities including using toilet facilities, washing, bathing, preparing foods and washing laundry, excluding industrial wastewater.

"Small public on-site sewage treatment system" means an on-site sewage treatment system,

except one that serves an individual residence or duplex, that has an average daily flow of five thousand (5,000) gallons or less.

"Soil profile description" means the identification and characterization of soil at a specific site.

"Soil texture" means the percent by weight of sand, silt, and clay for particles smaller than two millimeters (2 mm) in diameter.

"Storage media" means a natural or manufactured material that provides void spaces for storage and dispersal of effluent in the trenches of a subsurface treatment system.

"Water body" means any reservoir or stream listed in either the most current "Lakes of Oklahoma" or "Water Quality in Oklahoma Integrated Report."

"Water body protection area" means the land area around a water body comprised of Zone 1 and Zone 2.

"Water saturated soil" means soil characterized by either the presence of groundwater or redoximorphic soil features.

"Zone 1" means the land within six hundred sixty feet (660') of the highest normal pool elevation established for a reservoir or within six hundred sixty feet (660') of a stream bed.

"Zone 2" means the land within one thousand three hundred twenty feet (1320') of the highest normal pool elevation established for a reservoir or within one thousand three hundred twenty feet (1320') of a stream bed.

252:641-1-2.1. Authorizations and permits for on-site sewage treatment systems

(a) **Requirement for authorizations and permits.** Before installing a new or modifying an existing on-site sewage treatment system, the installer shall first obtain either:

- (1) DEQ authorization to construct an on-site sewage treatment system under the general permit, the terms of which are the rules of this Chapter; or
- (2) an individual permit to construct an alternative on-site sewage treatment system.

(b) **Applying for authorizations; necessity for permit.**

(1) An installer seeking an authorization to construct a new or modify an existing on-site sewage treatment system shall submit a completed and signed:

- (A) DEQ Form 641-575, "Request for Authorization/Permit to Construct an On-Site Sewage Treatment System" along with the appropriate fee(s) [see 252:641-23 (relating to fees)] to DEQ's Oklahoma City office;
- (B) DEQ Form 641-581P or 641-581SP "Report for On-Site Sewage" to the local DEQ office. The detail needed varies with each system design; guidance will be provided by the local DEQ office; and
- (C) DEQ Form 641-581Cert "Certification Documentation Form" to the local DEQ office.

(2) Any construction or modification design that deviates from the rules in this Chapter will require the installer to apply for an individual permit to construct a new or modify an existing alternative system.

(c) **Applying for permits for alternative systems.** Installers seeking an individual permit to construct a new or modify an existing alternative on-site sewage treatment system shall submit a completed and signed:

- (1) DEQ Form 641-575, "Request for Authorization/Permit to Construct an On-Site Sewage Treatment System" along with the appropriate fee(s) [see 252:641-23 (relating to fees)] to DEQ;
- (2) DEQ Form 641-581P or 641-581SP "Report for On-Site Sewage" to the local DEQ office;
- (3) DEQ Form 641-581Sup., "Supplemental Application for an Alternative On-Site Sewage Treatment System" to the local DEQ office for DEQ's review and approval; and
- (4) DEQ Form 641-581Cert "Certification Documentation Form" to the local DEQ office.

252:641-1-3. General requirements for on-site sewage treatment systems

(a) **Inspections.** All new installations of, modifications to and/or repairs to on-site sewage treatment systems shall be inspected and approved by the DEQ, or installed, self-inspected and approved by a certified installer before new installations, modifications or repairs can be backfilled and/or before

the system may be placed into operation. The installer shall be responsible for requesting any required DEQ inspections.

(b) **Treatment.** On-site sewage treatment systems shall only be used for treatment of sewage, as defined in 252:641-1-2. All sewage must be treated and dispersed according to the rules in this Chapter.

(c) **Ownership.** An on-site sewage treatment system shall be located only where:

(1) all components of the on-site sewage treatment system, which includes tanks, pumps, dispersal fields and collection line(s), are or will be located on property that is:

(A) owned by the owner of the on-site sewage treatment system; and/or

(B) dedicated in a recorded easement for the installation and operation of the on-site sewage system to the owner of the on-site sewage treatment system; or

(2) all components of an on-site sewage treatment system, excluding service lines, are or will be located on property that is:

(A) owned by a municipality, rural water district, rural sewer district or federally recognized tribe; and/or

(B) dedicated to a municipality, rural water district, rural sewer district or federally recognized tribe in a recorded easement for the installation and operation of the on-site sewage system.

(d) **Minimum lot size.** The designer and installer shall comply with the minimum lot size requirements as set forth in Appendix A, Figure 3. Plats recorded before January 1, 1974, are not subject to minimum lot size requirements but systems built in those platted areas must meet the construction requirements of this Chapter.

(e) **Requirement for a dispersal field or lagoon.** All on-site sewage treatment systems shall utilize one of the dispersal fields described in Subchapter 12 or a lagoon described in Subchapter 15.

(f) **Average daily flow.**

(1) Individual on-site sewage treatment systems. The average daily flow for an individual on-site sewage treatment system shall be based on an average water usage of two hundred (200) gallons per day for a residence of two (2) bedrooms or less, with an additional sixty-six (66) gallons per day for each additional bedroom.

(2) **Small public on-site sewage treatment systems.** The average daily flow for small public on-site sewage treatment systems shall be calculated using the estimated average daily flows listed in Appendix F, unless actual flow data or a more accurate estimation method is available or there is seasonal flow variation. When there is seasonal flow variation, the average daily flow shall be calculated using the highest monthly flow in the previous twelve (12) months divided by the number of days in that month.

(g) **Sizing.** All dispersal fields and lagoons shall be sized based on average daily flow using the charts in Appendix H. The size of on-site sewage treatment systems should be increased if the actual or anticipated water usage exceeds the above-stated average.

(h) **Separation distances.** The designer and the installer shall comply with the required vertical separation distances in Appendix A, Figures 1 and 2, and the horizontal separation distances listed in Appendix E.

(i) **Pipe specifications.** All pipe used in on-site sewage treatment systems shall meet or exceed the minimum specifications listed in Appendix C.

(j) **Water body restrictions.** No dispersal field may be installed within Zone 1 of a water body protection area unless it is preceded by a nitrogen reduction system that has been tested and certified by an ANSI accredited third party certifier as meeting the most current ANSI/NSF Standard 245.

252:641-1-4. Operation, repairs and maintenance

(a) **Proper operation.** The owner of an on-site sewage treatment system shall ensure that the system is maintained and operated properly so that:

(1) sewage or effluent from the system is properly treated and does not surface, pool, flow across the ground or discharge to surface waters;

(2) septic tanks, lift stations, low pressure dosing tanks, flow equalization tanks, aerobic treatment units and lagoons shall be maintained so that they do not leak or overflow; and

(3) the required security measures are intact (e.g., required fences are intact, septic tank lids are intact, manhole covers are properly secured).

(b) **Malfunctioning systems.** If an on-site sewage treatment system malfunctions, the person owning or otherwise responsible for the system shall take prompt action to repair the malfunctioning system, prevent further violations and remediate the site.

252:641-1-5. Enforcement

Violations of this Chapter are subject to enforcement actions and penalties set forth in 27A O.S. §§ 2-3-502, 2-3-504 and 2-6-206.

SUBCHAPTER 3. SOIL TESTS

Section

- 252:641-3-1. General provisions
- 252:641-3-2. Percolation test method
- 252:641-3-3. Linear feet requirements [REVOKED]
- 252:641-3-4. Soil profile description test method

252:641-3-1. General provisions.

(a) **Requirement for soil test.** A soil test, performed in accordance with this Subchapter, shall be used to identify the dispersal site for all modifications to on-site sewage treatment systems and/or to identify the dispersal site and size the dispersal field for new installations of on-site sewage treatment systems except for:

- (1) lagoons; and
- (2) aerobic treatment systems that utilize spray irrigation when sized for Group 5 soil in the corresponding net evaporation zone.

(b) **Required credentials.** Soil tests may only be performed by Professional Engineers, Professional Land Surveyors, Professional Sanitarians or Professional Environmental Specialists registered to practice in Oklahoma or Soil Scientists as defined in 27A O.S. § 3-1-103(20). Additionally, an individual performing soil profile descriptions must also be either:

- (1) an Environmental Specialist for the DEQ and authorized by DEQ to perform soil profile descriptions; or
- (2) certified by the DEQ to perform soil profile descriptions.

(c) **Submission of soil test results to the DEQ.** When a soil test is required, the results shall be submitted to the local DEQ office on DEQ Form 641-581P or 641-581SP or in a format approved by the DEQ.

(d) **Verification of design.** If there is reason to believe soil test results submitted to DEQ are inaccurate or that there is water saturated soil or soil impervious to boring in any of the test holes at any depth up to thirty-six inches (36"), the system design may be verified by the DEQ. If the results of the verification contradict the proposed design of the system, the DEQ may perform a soil profile description to design the system. Soil tests conducted by DEQ shall supercede the results of any prior soil test completed in the same proposed dispersal site.

(e) **Fill areas and excavation.** If there has been a fill of more than six inches (6") of soil or any excavation over an identified dispersal site, the local DEQ office must be contacted to determine if an additional soil test is needed. Soil tests shall not be performed in major earth fill areas.

252:641-3-2. Percolation test method

(a) **Use of percolation tests.** A percolation test may only be used to identify dispersal sites for conventional subsurface absorption fields. Percolation tests, including pre-existing ones, may not be used to identify dispersal sites for on-site sewage systems:

- (1) in scenic river corridors, unless documentation that the site is not located within the scenic river watershed is provided to DEQ; and
- (2) in Zone 2 of a water body protection area.

(b) **Test hole requirements.** The following test hole requirements shall be met for percolation tests:

(1) **Configuration.** Three test holes shall be placed in the proposed dispersal site at the approximate corners of an isosceles triangle having two (2) sides fifty feet (50') long and one side seventy-five feet (75') long. If the dispersal field will cover an area larger than ten thousand square feet (10,000 ft²), then one additional test hole shall be used for each additional five thousand square feet (5,000 ft²). Additional test holes shall not be placed within fifty feet (50') of any other test hole and shall be located between fifty to seventy-five feet (50'-75') from one of the other test holes. The DEQ may approve or require alternative configurations.

(2) **Size.** Test holes shall be dug or bored, four to twelve inches (4"-12") in diameter with vertical sides to a depth of at least twenty-four inches (24") and no more than thirty-six inches (36"). All test holes in the proposed dispersal site shall be the same depth. Test holes shallower than twenty-four inches (24") may be used to design conventional subsurface absorption fields under the alternative system approval process.

(3) **Soil surfaces.** The bottoms and sides of the test holes shall be scratched with a sharp-pointed instrument to relieve any smeared soil surfaces. Loose material shall be removed from the hole prior to commencing the presoak.

(4) **Prohibitions.** Test holes dug through animal burrows, root channels or soil that is cracked due to dry weather conditions shall not be used.

(c) **Presoak period.** The presoak period shall commence no earlier than twenty-four (24) hours prior to the start of the percolation test procedure. Each test hole shall be presoaked by filling them with water and refilling them as necessary to maintain a water depth of at least twelve inches (12") for at least four (4) hours. When it is impossible to maintain a water depth of at least twelve inches (12") during the entire presoak period due to an excessive percolation rate, then the hole is deemed unacceptable and may not be:

(1) used to calculate the percolation rate for the dispersal site; and

(2) located in the dispersal site for a conventional subsurface absorption field.

(d) **Calculating the percolation rate for each hole.** At the completion of the presoak, the depth of the water shall be adjusted to ten inches (10") above the bottom of each test hole. A fixed reference point shall be established at or above the initial water level. Using the fixed reference point, the level of the water in each hole shall be measured and recorded. After seventy-five (75) minutes, the number of inches the water level has dropped in each hole shall be measured and recorded. To calculate the percolation rate for each individual hole, divide seventy-five (75) minutes by the number of inches the water level has dropped. Any hole that exhibits a percolation rate of greater than seventy-five (75) minutes per inch is deemed unacceptable and may not be:

(1) used to calculate the percolation rate for the dispersal site; and

(2) located in the dispersal site for a conventional subsurface absorption field.

(e) **Calculating the percolation rate for the dispersal site.** If the rates of any two (2) test holes in the proposed dispersal site vary by more than fifteen (15) minutes, the percolation rate for the dispersal site shall be considered the rate of the slowest test hole. Otherwise, the percolation rate for the dispersal site shall be determined by averaging the percolation rates for the three (3) test holes and then rounding the result to the nearest whole number. If there are more than three (3) test holes in the proposed dispersal site, then the percolation rate must be calculated using the three (3) slowest percolation rates.

(f) **Sizing the dispersal field.** The percolation rate for the dispersal site shall be used in conjunction with the charts in Appendix H, Figures 1 and 4 to size the conventional subsurface absorption field. The chart in Appendix H, Figure 2 may be used to size conventional subsurface absorption fields utilizing chambers when designed using a percolation test.

(g) **Information to be reported.** The following information must be reported to the DEQ on DEQ Form 641-581P, "Report for On-Site Sewage Treatment" or in a format approved by the DEQ:

(1) Property owner's name(s);

(2) Address or finding directions for property;

(3) Legal description of property, including lot and block number when available;

(4) Lot size in square feet or acres;

(5) Whether the system will be an individual or small public on-site sewage treatment system;

(6) The estimated or actual average daily flow for the system as certified on DEQ Form 641-

- 581Cert "Certification Documentation Form";
- (7) Whether the water supply for the property is public or private;
 - (8) The location of each test hole (identified from two fixed reference points);
 - (9) The depth and percolation rate, along with the depth to groundwater if encountered, for all test holes in the proposed dispersal field;
 - (10) The percolation rate for the dispersal site;
 - (11) The size of the septic tank, the minimum length of the conventional subsurface absorption field, and the minimum and maximum depth of the trenches;
 - (12) The name and signature of the person performing the pre-soak;
 - (13) The name, signature and registration number of the person conducting the percolation test; and
 - (14) The date the percolation test was conducted.

252:641-3-3. Linear feet requirements [REVOKED]

252:641-3-4. Soil profile description test method

(a) **Test hole requirements.** Test holes may be augered borings, continuous core borings, or excavated pits.

(1) **Borings.** If borings are used, three test holes shall be placed in the proposed dispersal site at the approximate corners of an isosceles triangle having two (2) sides fifty feet (50') long and one side seventy-five feet (75') long. If the dispersal field will cover an area larger than ten thousand square feet (10,000 ft²), then one additional test hole shall be used for each additional five thousand square feet (5,000 ft²). Additional test holes shall not be placed within fifty feet of any other test hole and shall be located between fifty to seventy-five feet (50'-75') from one of the other test holes. The DEQ may approve or require alternative configurations. Borings shall allow for the classification of the soil in six-inch intervals and shall be bored to a minimum depth of forty-eight inches (48") or until one of the following is encountered first:

- (A) a layer that is impervious to boring;
- (B) a six-inch interval classified as a Group 5 soil; or
- (C) water saturated soil.

(2) **Pits.** If excavated pits are used, three (3) pits shall be placed in the proposed dispersal site at the approximate corners of an isosceles triangle having two (2) sides fifty feet (50') long and one side seventy-five feet (75') long. If the dispersal field will cover an area larger than ten thousand square feet (10,000 ft²), then one additional test hole shall be used for each additional five thousand square feet (5,000 ft²). Additional test holes shall not be placed within fifty feet of any other test hole and shall be located between fifty to seventy-five feet (50'-75') from one of the other test holes. The DEQ may approve or require alternative configurations. Pits shall:

- (A) have a depth of a minimum of forty-eight inches (48"), unless rock or water saturated soil is encountered at a shallower depth;
- (B) be a minimum of thirty-six inches (36") wide and sixty inches (60") long; and
- (C) have one end sloped or stepped to allow for entry.

(b) **Identification of limiting layers.** The shallowest limiting layer encountered in the test holes shall be the limiting layer for the entire dispersal site. The following are considered limiting layers and shall be identified by depth on DEQ Form 641-581SP, "Report for On-Site Sewage Treatment:"

- (1) a layer that is impervious to boring;
- (2) a six-inch interval classified as a Group 5 soil; and
- (3) water saturated soil.

(c) **Verifying limiting layers using pits.** Limiting layers may be verified using an excavated pit. The results of the pit(s) shall override the results of borings completed in the same proposed dispersal site.

(d) **Classifying soil intervals.** For each test hole, the soil group for each six-inch interval between the surface and the bottom of the test hole shall be identified using the guidelines found in the "DEQ/OSU Soil Classification Manual" and classified as one of the soil groups in Appendix B.

(e) **Determining the soil group for the separation range.** The soil group for the separation range

establishes the required vertical separation between the dispersed effluent and the limiting layer. The separation range consists of the three (3) six-inch intervals above the interval containing a limiting layer or, if no limiting layer was identified, the separation range shall be the three (3) six-inch intervals above the bottom of the test hole. To determine the soil group for the separation range:

(1) Select the test hole in the dispersal site with the lowest clay content in the separation range; and

(2) Identify and record the most prevalent soil group in the separation range for that test hole.

(f) **Identifying dispersal field options.** Based on the soil group identified in (e) of this Section, use Appendix A, Figure 1 to identify suitable dispersal fields along with their minimum separations distances from the limiting layer.

(g) **Sizing the dispersal field(s).** Each suitable dispersal field shall be sized as follows:

(1) **Determining sizing range.** Select the test hole in the dispersal site with the highest clay content in the sizing range for the chosen dispersal field. The applicable sizing range for each type of dispersal field is as follows:

(A) **Conventional subsurface absorption fields.** The sizing range for conventional subsurface absorption fields is the three (3) six-inch intervals between twelve inches (12") and thirty inches (30").

(B) **Low pressure dosing fields.** The sizing range for low pressure dosing fields is the three (3) six-inch intervals between twelve inches (12") and thirty inches (30").

(C) **ET/A fields.** The sizing range for ET/A fields is the three (3) six-inch intervals between twelve inches (12") and thirty inches (30").

(D) **Shallow extended subsurface absorption fields.** The sizing range for shallow extended subsurface absorption fields is the three (3) six-inch intervals between six inches (6") and twenty-four inches (24").

(E) **Drip irrigation fields.** The sizing range for drip irrigation fields is the three (3) six-inch intervals between ground level and eighteen inches (18").

(F) **Spray irrigation fields.** The sizing range for spray irrigation fields is the three (3) six-inch intervals between ground level and eighteen inches (18").

(2) **Identifying soil group in sizing range.** Determine the most prevalent soil group in the sizing range for the test hole selected in (1) of this subsection;

(3) **Sizing dispersal field.** Based on the soil group identified in (2) of this subsection, size the dispersal field using the charts in Appendix H, Figures 3 and 5-22; and

(4) **Sizing additional dispersal field options.** Repeat (1) through (3) of this subsection for each dispersal field option.

(h) **Information to be reported.** The following information must be reported to DEQ on DEQ Form 641-581SP, "Report for On-Site Sewage Treatment":

(1) Property owner's name(s);

(2) Address or finding directions for property;

(3) Legal description of property including block and lot number when available;

(4) Lot size in square feet or acres;

(5) Whether the system will be an individual or small public on-site sewage treatment system;

(6) The estimated or actual average daily flow for the system as certified on DEQ Form 641-581 Cert "Certification Documentation Form";

(7) Whether the water supply for the property is public or private;

(8) The location of each test hole (identified from two fixed reference points);

(9) The soil group for each six-inch interval between ground level and the bottom of each test hole in the proposed dispersal field;

(10) The depth and description of any soil impervious to boring or water saturated soil layer in each test hole located in the proposed dispersal field;

(11) Depth of limiting layer for entire dispersal field;

(12) The test hole number used to identify the separation range and the soil group of the separation range in the proposed dispersal field;

(13) For each suitable dispersal fields or system(s) identified provide the following:

(A) the test hole number used to determine the sizing range;

- (B) the soil group of the sizing range; and
- (C) the minimum sizing and installation criteria for the dispersal field or system;
- (14) The name, signature and registration number of the person conducting the soil profile description;
- (15) The date the soil profile description was conducted; and
- (16) Check box indicating whether or not dispersal field will be located in Zone 1 of a water body protection area.

SUBCHAPTER 5. BUILDING SEWER AND COLLECTION SYSTEMS

Section

- 252:641-5-1. General provisions
- 252:641-5-2. Installation

252:641-5-1. General provisions

- (a) The pipe used for building sewer and collection lines shall comply with the pipe specifications as set forth in Appendix C.
- (b) The joints of all solid pipe shall be sealed to be watertight.

252:641-5-2. Installation

- (a) **Minimum fall.** The following minimum fall requirements shall be met:
 - (1) **Three-inch and four-inch pipe.** Pipe having a diameter of three inches (3") or four inches (4") that delivers sewage to a septic tank or a trash tank shall be installed with a minimum fall of one-eighth inch (1/8") per foot.
 - (2) **Six-inch pipe.** Pipe having a diameter of six inches (6") that delivers sewage to a septic tank or a trash tank shall be installed with a minimum fall of one-sixteenth inch (1/16") per foot.
- (b) **Cleanouts.** For all pipe located upstream of a septic tank, a two-way cleanout or two-way cleanout assembly shall be installed:
 - (1) Within five feet (5') from where the plumbing stubs out of the building or appurtenance to the building;
 - (2) Within five feet (5') after each change in direction of more than forty-five degrees (45°);
 - (3) For each one-hundred-foot interval of straight pipe.

Nothing in this paragraph shall require the installation of more than one (1) two-way cleanout or two-way cleanout assembly per one-hundred-foot (100') section of straight pipe. For purposes of this paragraph, straight pipe is pipe that does not have any change of direction of more than forty-five degrees (45°).

SUBCHAPTER 7. SEPTIC TANKS

Section

- 252:641-7-1. General provisions
- 252:641-7-2. Types of tanks
- 252:641-7-3. Design
- 252:641-7-4. Liquid capacity

252:641-7-1. General provisions

- (a) Once installed, the tops of septic tanks shall have no more than one inch (1") variation in elevation from side to side and end to end.
- (b) Septic tanks shall be constructed to prevent sewage from leaking out of the tank and to prevent the infiltration of water into the tank.
- (c) Appendix I illustrates the requirements for a septic tank.

252:641-7-2. Types of tanks

- (a) **Concrete tanks.** Concrete tanks shall be reinforced with rebar or fiber, and constructed of a mix

which demonstrates a twenty-eight-day compressive strength of four (4) thousand pounds per square inch (4,000 psi). They may be poured in place or precast, but, in either case, shall be monolithically poured and mechanically vibrated.

(b) **Fiberglass and plastic tanks.** Fiberglass and plastic tanks shall meet either IAPMO or CSA standards for septic tanks and shall be installed according to the manufacturer's recommendations. If the tank does not bear the IAPMO or CSA mark, then DEQ will require the installer to submit documentation from IAPMO or CSA stating the tank meets the above standards.

252:641-7-3. Design

(a) **Compartments.** A septic tank may consist of one (1) or two (2) compartments. All septic tanks shall have a removable lid or a manhole opening of at least twenty inches (20") in diameter or, if rectangular, having no side less than twenty inches (20") in length over each compartment. All lids and manholes shall be sealed to prevent leakage.

(b) **Two-compartment tanks.** The passage in the common wall of two-compartment tanks shall be located below the liquid level and between twenty percent (20%) to forty percent (40%) of the liquid depth. There shall be a vent through the common wall.

(c) **Inlets and outlets.** The outlet of the septic tank shall be two inches (2") lower than the inlet of the septic tank. Baffles for inlets and outlets shall be constructed and located as follows:

(1) **Construction.** Baffles shall be used on all inlet and outlet lines. Cleanout openings shall be located directly above the inlet and outlet baffles. Inlets and outlets shall have a watertight seal.

(2) **Location.** All baffles shall extend to within two inches (2") of the top of the septic tank.

(A) **Inlet.** Inlet baffles shall extend at least six inches (6") below the liquid depth of the septic tank.

(B) **Outlet.** Outlet baffles shall extend below the liquid level by twenty percent (20%) to forty percent (40%) of the liquid depth.

(d) **Precast concrete tanks.** Precast concrete tanks shall have a minimum:

(1) wall thickness of two and one-half inches (2-1/2");

(2) bottom thickness of three inches (3"); and

(3) cover thickness of three and one-half inches (3-1/2").

(e) **Poured-in-place concrete tanks.** Poured-in-place concrete tanks shall have a minimum:

(1) wall thickness of six inches (6");

(2) bottom thickness of three inches (3"); and

(3) cover thickness of four inches (4").

252:641-7-4. Liquid capacity

(a) **Individual on-site sewage treatment system.** A septic tank used in an individual on-site sewage treatment system for a residential unit with four (4) or fewer bedrooms shall have a liquid capacity of at least one thousand (1,000) gallons. An additional two hundred and fifty (250) gallons of capacity must be added for each additional bedroom.

(b) **Small public sewage system.** The liquid capacity for a septic tank used in a small public sewage system shall be equal to or greater than the average daily flow plus fifty percent (50%), but in no case shall it be less than one thousand (1,000) gallons.

(c) **Two-compartment tanks.** The capacity of the influent compartment of a two-compartment tank shall not be less than one-half (1/2) nor more than two-thirds (2/3) of the total required liquid capacity of the tank.

(d) **All septic tanks.** All septic tanks shall be designed to have:

(1) a liquid depth of at least three feet (3') but not more than six and one-half feet (6-1/2'); and

(2) an air space of eight inches (8") or more inside the tank.

SUBCHAPTER 9. PUMP TANKS

Section

252:641-9-1. General provisions

252:641-9-2. Sizing

252:641-9-3. Pump controls

252:641-9-4. Dosing requirements [AMENDED AND RENUMBERED TO 252:641-9-3]

252:641-9-1. General provisions

(a) **Primary settling.** All sewage entering a pump tank (i.e., a lift station, a flow equalization tank or a low pressure dosing tank) must first pass through a septic tank or a trash tank for primary settling.

(b) **Pump tank design and construction.** Pump tanks shall:

(1) be constructed to prevent sewage from leaking out of the tank and to prevent the infiltration of water into the tank;

(2) when made of concrete, meet the requirements of 252:641-7-2(a);

(3) have a manhole opening of at least twenty inches (20") in diameter or, if rectangular, having no side less than twenty inches (20") in length. The manhole cover shall have a lock, locking bolt, or some type of fastener that requires tools for removal. The manhole opening shall extend a minimum of two inches (2") above ground elevation;

(4) have a threaded union installed in the discharge line located within eighteen inches (18") of the manhole opening so that the pump can be removed without entering the pump tank; and

(5) have a check valve installed in the discharge line after the threaded union. The check valve shall be the same diameter as the discharge line.

(c) **Pump design.** Pumps shall be:

(1) designed to pump sewage or other liquid containing fine particles/suspended solids;

(2) rated to pump at least the average daily flow the required distance and elevation; and

(3) when used as a low pressure dosing pump, rated to pump at least fifty (50) gallons per minute with no more than eight feet (8') of head pressure.

(d) **Prevention of back siphonage.** Pump discharges shall flow through a structure or device that prevents the back siphonage of wastewater to the pump tank.

(e) **Example.** Appendix J illustrates the requirements for a pump tank.

252:641-9-2. Sizing

Pump tanks shall be sized as follows:

(1) **Lift stations.** The lift station pump tank shall have a minimum liquid storage capacity of one thousand (1,000) gallons.

(A) **Daily flow over 500 gallons.** For systems with average daily flows over five hundred (500) gallons, the liquid capacity of the pump tank shall be at least twice the highest daily flow.

(B) **Daily flow over 2,000 gallons.** For systems with an average daily flow over two thousand (2,000) gallons, the liquid capacity of the pump tank may be reduced to one-half (1/2) of the average daily flow, if a backup pump is available on site.

(2) **Flow equalization tanks.** The flow equalization pump tank shall have a minimum liquid storage capacity of one thousand (1,000) gallons. If the daily flow is greater than five hundred (500) gallons, the liquid capacity of the pump tank shall be at least twice the highest daily flow.

(3) **Low pressure dosing tanks.** The low pressure dosing pump tank shall be sized to have a minimum liquid capacity of at least one and one-half (1-1/2) times the average daily flow.

252:641-9-3. Pump controls.

The pump controls shall be set as follows:

(1) **Lift stations.** The following control settings apply to lift stations:

(A) **Never more than 1/2 full.** The pump controls shall be set so that the pump tank is never more than one-half (1/2) full.

(B) **Alarm.** There shall be an alarm set to activate and alert the owner/operator if the pump tank becomes more than one-half (1/2) full.

(2) **Flow equalization tanks.** The following control settings apply to flow equalization tanks:

(A) **Never more than 1/2 full.** The pump controls shall be set so that the pump tank is never more than one-half (1/2) full.

(B) **Alarm.** There shall be an alarm set to activate and alert the owner/operator if the pump tank becomes more than one-half (1/2) full.

(C) **Regulating pumping rate.** The pumping of wastewater to the treatment system shall be regulated by timers, float switches or by piping and valves that allow excess pumped effluent to be returned to the flow equalization tank. The pumping of wastewater to the treatment system shall not exceed:

- (i) one-fourth (1/4) of the design capacity of the treatment system in a one-hour period; and
- (ii) the daily treatment capacity of the treatment system in any given twenty-four-hour period.

(3) **Low pressure dosing tanks.** The following control settings apply to low pressure dosing tanks:

(A) **Alarm.** There shall be an alarm set to activate and alert the owner/operator if the reserve volume of the pump tank falls below one day's flow.

(B) **Regulating pumping rate.** The pumping of wastewater to the dispersal field shall be regulated by timers, float switches or by piping and valves that allow excess pumped effluent to be returned to the low pressure dosing pump tank. The pump controls shall be set so that the pumping of wastewater to the dispersal field shall:

- (i) occur at least four (4) times per day; and
- (ii) not exceed one-fourth (1/4) of the daily flow per dosing event.

252:641-9-4. Dosing requirements [AMENDED AND RENUMBERED TO 252:641-9-3]

SUBCHAPTER 10. AEROBIC TREATMENT SYSTEMS

Section

252:641-10-1. Residential sewage treatment only

252:641-10-2. Design and installation

252:641-10-3. Responsibility for maintenance

252:641-10-1. Residential sewage treatment only

Aerobic treatment systems shall only be used for treatment of sewage from residential units and cannot be used when the average daily flow is less than one hundred (100) gallons per day or greater than one thousand five hundred (1,500) gallons per day.

252:641-10-2. Design and installation

(a) **Fluctuating flows.** If the daily flow fluctuates so that the flow on any given day during the week exceeds the aerobic treatment unit's daily capacity, then an aerobic treatment system may not be used unless a flow equalization tank, which meets the requirements of 252:641-9, is installed between the trash tank and the aerobic treatment unit.

(b) **Components of aerobic treatment systems.** Aerobic treatment systems shall be comprised of the following components:

(1) **Trash tank.** There shall be a trash tank that meets the requirements of ANSI/NSF Standard 40 or 252:641-7-2. The trash tank shall:

(A) be constructed to prevent sewage from leaking out of the tank and to prevent the infiltration of water into the tank;

(B) have a minimum liquid capacity of three hundred (300) gallons or the average daily flow, whichever is greater, except that the minimum liquid capacity shall not be less than what was used in the ANSI/NSF certification process;

(C) have a removable lid or a manhole opening of sufficient size to allow for maintenance. The lid or manhole shall be sealed to prevent leakage and extend a minimum of two inches (2") above ground elevation. The cover for the opening shall have a lock, locking bolt or some type of fastener, or require a tool for removal; and

(D) have baffles installed at its inlet and the outlet. The baffles shall extend to within two

inches (2") of the top of the trash tank.

(i) **Inlet.** Inlet baffles shall extend at least six inches (6") below the liquid depth of the trash tank.

(ii) **Outlet.** Outlet baffles shall extend below the liquid level by twenty percent (20%) to forty percent (40%) of the liquid depth.

(2) **Aerobic treatment unit.** There shall be a aerobic treatment unit that:

(A) has been tested and certified by an ANSI accredited third party certifier as meeting the most current ANSI/NSF Standard 40 and when required by waterbody restrictions ANSI/NSF Standard 245;

(B) is constructed to prevent sewage from leaking out of the tank and to prevent the infiltration of water into the tank

(C) is rated at or above the design daily flow;

(D) produces effluent clear enough that the bottom of the pump tank is visible when it is full; and

(E) has an opening of sufficient size to allow for maintenance that extends a minimum of two inches (2") above ground elevation. The cover for the opening shall have a lock, locking bolt or some type of fastener, or require a tool for removal.

(3) **Method of disinfection.** If spray irrigation is used as the type of dispersal, then there shall be a method to disinfect the effluent that has been tested and certified by an ANSI accredited third party certifier as meeting the most current ANSI/NSF Standard 46, between the aerobic treatment unit and the pump tank (or in the pump tank). If chlorination is used as the disinfection method, a free chlorine residual of two tenths of a milligram per liter (0.2 mg/l) must be maintained in the pump tank. All other methods of disinfection shall effectively reduce the fecal coliform count to less than two hundred colonies per one hundred milliliters (200/100 ml).

(4) **Pump tank.** There shall be a pump tank, which shall:

(A) meet the requirements of ANSI/NSF Standard 40 or 252:641-7-2;

(B) have a minimum liquid capacity of seven hundred (700) gallons or, for systems with an average flow over three hundred fifty (350) gallons per day, have a liquid capacity of at least twice the average daily flow;

(C) have a sampling port in the pump tank at the discharge outlet or in the treated effluent line following the pump tank;

(D) have a float in the pump tank set so that the pump tank is never more than one-half (1/2) full;

(E) have a high-water alarm set to activate and alert the owner/operator if the pump tank becomes more than one-half (1/2) full; and

(F) have an opening of sufficient size to allow for maintenance that extends a minimum of two inches (2") above ground elevation. The cover for the opening shall have a lock, locking bolt or some type of fastener, or require a tool for removal.

(5) **Dispersal field.** Effluent treated by an aerobic treatment unit shall be dispersed as described in Subchapter 12 of this Chapter.

(c) **Level.** Once installed, the top of each tank (i.e., trash tank, aerobic treatment unit and pump tank) shall have no more than one inch (1") variation in elevation from side to side and end to end.

(d) **Depth of aerobic treatment system components.** The top of all components of the aerobic treatment system, excluding the trash tank and dispersal field, shall be covered with no more than twenty-four inches (24") of soil.

(e) **Solid pipe.** The solid pipe used to connect the components of an aerobic treatment system must meet the minimum specifications listed in Appendix C.

(f) **Fall.** Unless a lift pump is utilized, there shall be fall between:

(1) the trash tank and the aerobic treatment unit; and

(2) the aerobic treatment unit and the pump tank.

(g) **Manufacturer's specification.** All aerobic treatment systems shall be installed in accordance with the manufacturer's specifications.

252:641-10-3. Responsibility for maintenance

(a) **Mandatory two year maintenance period.** The installer of any aerobic treatment system including those providing nitrogen reduction shall maintain the aerobic treatment system for a period of two years following the date the system was installed at no additional cost to the owner. During the two-year mandatory maintenance period, the installer shall be responsible for the following:

- (1) repairing, adjusting or replacing any broken or malfunctioning parts;
- (2) when spray dispersal is used, testing and recording the free chlorine residual of the effluent in the pump tank at least once every six (6) months;
- (3) measuring and recording the depth of the sludge in the trash tank at least once every six (6) months;
- (4) measuring and recording the volume of the sludge in forced-air aerobic treatment units at least once every six (6) months;
- (5) when pump tanks are used, conducting a clarity test and recording the results as passing or failing once every six (6) months. A passing clarity test is one where an eight-inch disk with alternating black and white quadrants is visible when placed on the bottom of the pump tank when the tank is at least one-third (1/3) full;
- (6) notifying the owner of the system in writing of:
 - (A) the type and date of any repairs, adjustments or replacements performed on the system;
 - (B) the results of the free chlorine residual test if required and, when applicable, the need to add chlorine and how to do it;
 - (C) the depth of the accumulation of sludge in the trash tank and the need to have it pumped so that the depth of the sludge is never more than forty percent (40%) of the overall depth;
 - (D) the volume of the sludge in the aerobic treatment unit and the need to have it pumped so that the volume of the sludge in the aerobic treatment unit is never more than forty percent (40%); and
 - (E) the results of the clarity test and, if it fails the test, what the installer did or the homeowner has to do to correct it; and
- (7) documenting all maintenance and testing performed on the system and maintaining those records at his/her business for a period of three (3) years following the date of service.

(b) **Exclusions from maintenance.** The installer shall not be responsible for repairing aerobic treatment systems when the owner/operator is the sole cause of the damage to the system or the system's malfunction (e.g., sprinkler heads that properly retract into the ground but are nevertheless damaged by careless actions of the homeowner, excessive water usage, introduction of harmful items into septic system, etc.).

(c) **Owner responsible after two year period ends.** After the expiration of the two-year mandatory maintenance period, the owner of the aerobic treatment system shall be solely responsible for maintaining or hiring someone to maintain the system so that it operates as designed.

SUBCHAPTER 11. SUBSURFACE SYSTEMS [REVOKED]

AGENCY NOTE: The revoked language in this Subchapter has been relocated to new Subchapter 12.

Section

- 252:641-11-1. General provisions [REVOKED]
- 252:641-11-2. Subsurface treatment fields [REVOKED]
- 252:641-11-3. Retention and distribution structures [REVOKED]
- 252:641-11-4. Exceptions [REVOKED]

252:641-11-1. General provisions [REVOKED]

252:641-11-2. Subsurface treatment fields [REVOKED]

252:641-11-3. Retention and distribution structures [REVOKED]

252:641-11-4. Exceptions [REVOKED]

SUBCHAPTER 12. DISPERSAL FIELDS

Section

- 252:641-12-1. General provisions
- 252:641-12-2. Conventional subsurface absorption fields
- 252:641-12-3. Shallow extended subsurface absorption fields
- 252:641-12-4. Low pressure dosing fields
- 252:641-12-5. Evapotranspiration/absorption (ET/A) fields
- 252:641-12-6. Drip irrigation fields
- 252:641-12-7. Spray irrigation fields

252:641-12-1. General provisions

- (a) **Primary settling.** Prior to being conveyed to a dispersal field, all sewage must first pass through a septic tank or trash tank for primary settling.
- (b) **Delivery method.** All sewage shall be conveyed to the dispersal field through solid pipe, which shall meet the specifications listed in Appendix C.
- (c) **Surface water.** Surface water shall be diverted around or away from the dispersal field.
- (d) **Types of dispersal fields.** The following are the allowed types of dispersal fields:
 - (1) Conventional subsurface absorption fields;
 - (2) Shallow extended subsurface absorption fields;
 - (3) Evapotranspiration/absorption (ET/A) fields;
 - (4) Low pressure dosing fields;
 - (5) Drip irrigation fields; and
 - (6) Spray irrigation fields.
- (e) **Specifications for storage media.** Storage media shall meet the following requirements:
 - (1) **Storage capacity.** All storage media shall provide a storage capacity of:
 - (A) at least five (5) gallons per linear foot in the bottom ten inches (10") of a twenty-four inch-wide trench in a conventional subsurface absorption field or ET/A field; or
 - (B) at least three and one-half (3-1/2) gallons per linear foot in the bottom six inches (6") of a twenty-four-inch-wide trench in a low pressure dosing field or a shallow extended subsurface absorption field.
 - (2) **Media size.** Storage media shall be one-half to two and one-half inches (1/2" to 2-1/2") in diameter with no more than ten percent (10%) by weight passing through a one-half inch (1/2") screen.
 - (3) **Media with specific gravity of less than 1.0.** If the specific gravity of the storage media is less than 1.0, it shall be bundled with a netting sleeve.
 - (4) **Resistant to degradation.** The storage media shall be non-degradable by septic tank effluent.
 - (5) **Hardness of natural media.** Natural materials (e.g., rock, etc.) used as storage media shall have a Mohs hardness of at least 3.0.
 - (6) **Deflection rate for manufactured media.** Manufactured materials (e.g., glass, plastic, polystyrene, etc.) used as storage media shall have a deflection rate of ten percent (10%) or less when subjected to a minimum of ten (10) psi for ninety-six (96) hours (ASTM D2221-01).

252:641-12-2. Conventional subsurface absorption fields

- (a) **Location.** All conventional subsurface absorption fields shall be:
 - (1) located in the identified dispersal site; and
 - (2) installed more than five feet (5') from the septic tank or aerobic treatment unit.
- (b) **Fall.** Unless a pump is utilized, there shall be a minimum fall of two inches (2") from the bottom of the outlet of the septic tank to the:
 - (1) highest point of the storage media in the conventional subsurface absorption field; or
 - (2) highest point of the sidewall openings of a chamber in the conventional subsurface

absorption field.

(c) **Minimum linear length.** All conventional subsurface absorption fields must meet the minimum length requirements set forth in Appendix H, Figures 1-5. If perforated pipe is used between distribution structures and installed in accordance with the trench requirements of this Section, it may be counted as part of the overall required length of the conventional subsurface absorption field.

(d) **Trench length limitation.** Conventional subsurface absorption fields shall be constructed so that no sewage flows through more than a total of one hundred fifty linear feet (150') of perforated pipe or chambers in any given path.

(e) **Trench spacing.** The trenches in a conventional subsurface absorption field shall be spaced at least eight feet (8') apart, center to center.

(f) **Trench width.** All trenches in a conventional subsurface absorption field shall be twenty-four inches (24") wide.

(g) **Trench depth.** Each trench in a conventional subsurface absorption field shall have a uniform depth of at least eighteen inches (18"), and no more than thirty inches (30"). The bottom of the trenches shall be level.

(h) **Dispersal and storage.** Each trench in a conventional subsurface absorption field shall contain a zone for the dispersal and storage of effluent comprised of either perforated pipe and storage media, or chambers.

(1) **Perforated pipe with storage media.** When perforated pipe and storage media are used to disperse and store effluent throughout the trenches, the following requirements shall apply:

(A) **Perforated pipe.** The perforated pipe shall:

- (i) meet the minimum specifications listed in Appendix C.
- (ii) extend the entire length of the trenches.

(B) **Storage Media.** The storage media shall:

- (i) be at least ten inches (10") deep and at least twenty-four inches (24") wide the entire length of the trench;
- (ii) be installed with at least two inches (2") of storage media above and two inches (2") of storage media below the perforated pipe;
- (iii) be level:
 - (I) in each trench; and
 - (II) across the dispersal field, unless installed in trenches of different elevations.

(2) **Chambers.** When chambers are used to disperse and store effluent throughout the trenches, the chambers shall:

- (A) have a minimum bottom width of twenty-two inches (22");
- (B) have a minimum sidewall height of ten inches (10") with the sidewalls having evenly distributed open space. If the sidewall height is less than ten inches (10"), then the trench shall be backfilled with storage media to meet the ten-inch height requirement;
- (C) meet the IAPMO PS 63-2005 standard;
- (D) extend the entire length of the trenches;
- (E) be level:
 - (i) in each trench; and
 - (ii) across the dispersal field, unless installed in trenches of different elevations.

(i) **Retention structure.** Retention structures must be used between trenches of different elevations in conventional subsurface absorption fields. When a retention structure is used:

- (1) the top of the outlet pipe of a retention structure or the top of the outlet pipe of a chamber being used as a retention structure shall be fourteen inches (14") above the trench bottom; and
- (2) the line from the outlet of a retention structure to the next distribution point shall be constructed of solid pipe and shall be backfilled with compacted native soil.

(j) **Backfill.** For conventional subsurface absorption fields:

- (1) the depth of the backfill shall be consistent and shall not vary more than four inches (4"); and
- (2) the backfill shall consist of at least eight inches (8") of topsoil.

(k) **Layout examples.** There are examples of conventional subsurface system layouts in Appendix K, Figures 1, 2, and 4; examples of retention and distribution structures in Appendix L; examples of trench installation in Appendix M, Figures 1 and 2; and examples of chambers installed in

trenches in Appendix N.

252:641-12-3. Shallow extended subsurface absorption fields

- (a) **Location.** All shallow extended subsurface absorption fields shall be:
 - (1) located in the identified dispersal site; and
 - (2) installed more than five feet (5') from the septic tank or aerobic treatment unit.
- (b) **Fall.** Unless a pump is utilized, there shall be a minimum fall of two inches (2") from the bottom of the outlet of the septic tank to the:
 - (1) highest point of the storage media in the shallow extended subsurface absorption field; or
 - (2) highest point of the sidewall openings of a chamber in the shallow extended subsurface absorption field.
- (c) **Minimum linear length.** All shallow extended subsurface absorption fields must meet the minimum length requirements set forth in Appendix H, Figures 6 and 7. If perforated pipe is used between distribution structures and installed in accordance with the trench requirements of this Section, it may be counted as part of the overall required length of the shallow extended subsurface absorption field.
- (d) **Trench length limitation.** Shallow extended subsurface absorption fields shall be constructed so that no sewage flows through more than a total of one hundred fifty linear feet (150') of perforated pipe or chambers in any given path.
- (e) **Trench spacing.** The trenches in a shallow extended subsurface absorption field shall be spaced at least eight feet (8') apart, center to center.
- (f) **Trench width.** All trenches in a shallow extended subsurface absorption field shall be twenty-four inches (24") wide.
- (g) **Trench depth.** Each trench in a shallow extended subsurface absorption field shall have a uniform depth of at least fourteen inches (14"), and no more than thirty inches (30"). The bottom of the trenches shall be level.
- (h) **Dispersal and storage.** Each trench in a shallow extended subsurface absorption field shall contain a zone for the dispersal and storage of effluent comprised of either perforated pipe and storage media, or chambers.
 - (1) **Perforated pipe with storage media.** When perforated pipe and storage media are used to disperse and store effluent throughout the trenches, the following requirements shall apply:
 - (A) **Perforated pipe.** The perforated pipe shall:
 - (i) meet the minimum specifications listed in Appendix C.
 - (ii) extend the entire length of the trenches.
 - (B) **Storage Media.** The storage media shall:
 - (i) be at least six inches (6") deep and at least twenty-four inches (24") wide the entire length of the trench;
 - (ii) be installed with at least one inch (1") of storage media above and one inch (1") of storage media below the perforated pipe;
 - (iii) be level:
 - (I) in each trench; and
 - (II) across the dispersal field, unless installed in trenches of different elevations.
 - (2) **Chambers.** When chambers are used to disperse and store effluent throughout the trenches, the chambers shall:
 - (A) have a minimum bottom width of twenty-two inches (22");
 - (B) have a minimum sidewall height of six inches (6") with the sidewalls having evenly distributed open space;
 - (C) meet the IAPMO PS 63-2005 standard;
 - (D) extend the entire length of the trenches;
 - (E) be level:
 - (i) in each trench; and
 - (ii) across the dispersal field, unless installed in trenches of different elevations.
- (i) **Retention structure.** Retention structures must be used between trenches of different elevations in shallow extended subsurface absorption fields. When a retention structure is used:

- (1) the top of the outlet pipe of a retention structure or the top of the outlet pipe of a chamber being used as a retention structure shall be ten inches (10") above the trench bottom; and
- (2) the line from the outlet of a retention structure to the next distribution point shall be constructed of solid pipe and shall be backfilled with compacted native soil.

(j) **Backfill.** For shallow extended subsurface absorption fields:

- (1) the depth of the backfill shall be consistent and shall not vary more than four inches (4"); and
- (2) the backfill shall consist of at least eight inches (8") of topsoil.

252:641-12-4. Low pressure dosing fields

(a) **Location.** All low pressure dosing fields shall be:

- (1) located in the identified dispersal site;
- (2) installed more than five feet (5') from the septic tank or aerobic treatment unit; and
- (3) preceded by a low pressure dosing tank.

(b) **Header line.** The header pipe (i.e., the pipe between the pump tank and the manifold) shall:

- (1) have a diameter the same as the diameter of the outlet of the low pressure dosing pump; and
- (2) be no longer than thirty feet (30').

(c) **Total linear length.** All low pressure dosing fields shall meet the total linear length requirements set forth in Appendix H, Figures 8 and 9.

(d) **Trench length.** Each trench in a low pressure dosing field shall be forty feet (40') long.

(e) **Trench spacing.** The trenches in a low pressure dosing field shall be spaced six feet (6') apart, center to center.

(f) **Trench width.** All trenches in a low pressure dosing field shall be twenty-four inches (24") wide.

(g) **Trench depth.** Each trench in a low pressure dosing field shall have a uniform depth of at least fourteen inches (14") and no more than thirty inches (30"). The bottom of the trenches shall be level.

(h) **Dispersal and storage.** Each trench in a low pressure dosing field shall contain a zone for the dispersal and storage of effluent comprised of low pressuring dosing pipe and storage media.

(1) **Low pressure dosing pipe.** Low pressure dosing pipe shall:

- (A) meet the minimum specifications listed in Appendix C;
- (B) have one-fourth inch (1/4") diameter holes spaced five feet (5') apart the entire length of the pipe;
- (C) extend the entire length of the trenches; and
- (D) have all of the joints glued.

(2) **Storage media.** The storage media shall:

- (A) be at least six inches (6") deep and at least twenty-four inches (24") wide the entire length of the trench;
- (B) be installed with at least two inches (2") of the storage media above and two inches (2") of storage media below the low pressure dosing pipe; and
- (C) be level:
 - (i) in each trench; and
 - (ii) across the low pressure dosing field.

(i) **Retention structures prohibited.** Retention structures may not be used in low pressure dosing fields.

(j) **Backfill.** For low pressure dosing fields:

- (1) the depth of the backfill shall be consistent and shall not vary more than four inches (4"); and
- (2) the backfill shall consist of at least eight inches (8") of topsoil.

(k) **Layout examples.** There are layout examples located in Appendix K, Figure 3, and Appendix M, Figure 3.

252:641-12-5. Evapotranspiration/absorption (ET/A) fields

(a) **Location.** All ET/A fields shall be:

- (1) located in the identified dispersal site; and
- (2) installed more than five feet (5') from the septic tank or aerobic treatment unit.

(b) **Fall.** Unless a pump is utilized, there shall be a minimum fall of two inches (2") from the bottom

of the outlet of the septic tank to the highest point of the storage media in the ET/A field.

(c) **Minimum linear length.** All ET/A fields must meet the minimum length requirements set forth in Appendix H, Figures 10 and 11. If perforated pipe is used between distribution structures and installed in accordance with the trench requirements of this Section, it may be counted as part of the overall required length of the ET/A field.

(d) **Trench length limitation.** ET/A fields shall be constructed so that no sewage flows through more than a total of one hundred fifty linear feet (150') of perforated pipe in any given path.

(e) **Trench spacing.** The trenches in an ET/A field shall be spaced at least eight feet (8') apart, center to center.

(f) **Trench width.** All trenches in an ET/A field shall be twenty-four inches (24") wide.

(g) **Trench depth.** Each trench in an ET/A field shall have a uniform depth not to exceed twenty-four inches (24"). The bottom of the trenches shall be level.

(h) **Dispersal and storage.** Each trench in an ET/A field shall contain a zone for the dispersal and storage of effluent comprised of perforated pipe and storage media.

(1) **Perforated pipe.** The perforated pipe shall:

(A) meet the minimum specifications listed in Appendix C; and

(B) extend the entire length of the trenches.

(2) **Storage media.** The storage media used shall:

(A) be at least ten inches (10") deep and at least twenty-four inches (24") wide the entire length of the trench;

(B) be installed with at least two inches (2") of the storage media above and two inches (2") of storage media below the perforated pipe;

(C) be level:

(i) in each trench; and

(ii) across the ET/A field, unless installed in trenches of different elevations.

(i) **Retention structure.** Retention structures must be used between trenches of different elevations in ET/A fields. When a retention structure is used:

(1) the top of the outlet pipe of a retention structure shall be fourteen inches (14") above the trench bottom; and

(2) the line from the outlet of a retention structure to the next distribution point shall be constructed of solid pipe and shall be backfilled with compacted native soil.

(j) **Backfill.** For ET/A fields:

(1) the trenches shall be backfilled with clean sand to within two inches (2") of the ground level;

(2) the sand used to backfill the trenches shall be separated from the storage media by material that allows the flow of water but prevents the flow of sand; and

(3) after a trench is backfilled with sand, two to four inches (2"-4") of sandy loam soil shall be mounded over the trench.

(k) **Layout examples.** There are layout examples located in Appendix K, Figures 1, 2, and 4, Appendix L, and Appendix M, Figure 2.

252:641-12-6. Drip irrigation fields

(a) **Location.** All drip irrigation fields shall be:

(1) preceded by an aerobic treatment unit;

(2) preceded by a filter capable of filtering particles larger than one hundred (100) microns; and

(3) located in the identified dispersal site.

(b) **Components.** All components used in the drip irrigation field shall be designed and manufactured specifically for use in wastewater treatment systems.

(c) **Pump.** The pump shall:

(1) be set to distribute no more than one fourth (1/4) of the designed daily flow to the drip irrigation pipe during each pumping interval;

(2) when in operation, maintain a minimum pressure of ten (10) psi and a maximum pressure of forty-five (45) psi throughout the drip irrigation pipe; and

(3) have a high-water alarm set to activate and alert the owner/operator if the pump tank becomes more than one-half (1/2) full.

- (d) **Minimum linear length.** All drip irrigation fields shall meet the minimum length requirements set forth in Appendix H, Figure 12.
- (e) **Drip irrigation pipe.** The pipe used in drip irrigation fields shall be designed and manufactured for the purpose of distributing wastewater and comply with the minimum specifications in Appendix C.
- (f) **Installation of pipe.** The pipe used in drip irrigation fields shall be:
 - (1) installed eight to ten inches (8-10") deep;
 - (2) installed according to the manufacture's specifications; and
 - (3) equipped with emitters spaced:
 - (A) one foot (1') apart in soil groups 1, 4, and 5; and
 - (B) two feet (2') apart in soil groups 2, 2a, 3, and 3a.
- (g) **Emitters.** The emitters shall be set to wet four square feet (4 ft²) and be pressure compensating to deliver uniform distribution regardless of the pressure entering the drip line.
- (h) **Prevent backflow.** To prevent backflow, at least one (1) vacuum relief valve, located in a valve box lined with gravel, shall be located at the highest point on both the supply manifold and the return manifold.
- (i) **Back flush.** There shall be a method to flush the drip irrigation pipe. The flush water shall be returned to the trash tank, aerobic treatment unit or pump tank.

252:641-12-7. Spray irrigation fields

- (a) **Location.** All spray irrigation fields shall:
 - (1) be preceded by an aerobic treatment unit;
 - (2) be located in the identified dispersal site, when a soil profile test is used to sized the irrigation field;
 - (3) utilize at least two sprinkler heads to disperse the treated effluent; and
 - (4) be vegetated and landscaped, and/or terraced to prevent runoff.
- (b) **Sizing.** The spray irrigation field shall be sized according to Appendix H, Figures 13-22. When calculating the overall area of the spray irrigation field, areas of overlap may only be counted once.
- (c) **Sprinklers.** The sprinklers shall be designed to:
 - (1) provide uniform distribution of treated effluent over the entire spray irrigation field without misting; and
 - (2) have a trajectory of no more than fifteen-degrees (15°) to keep the spray stream low to the ground surface.
- (d) **Spray irrigation.** The spray irrigation shall be:
 - (1) adjusted and maintained at a rate to prevent runoff; and
 - (2) controlled by a timing device to take place daily between 1:00 a.m. and 6:00 a.m.

SUBCHAPTER 13. AEROBIC SYSTEMS [REVOKED]

AGENCY NOTE: The revoked language in this Subchapter has been relocated to new Subchapters 10 and 12.

Section

- 252:641-13-1. General provisions [REVOKED]
- 252:641-13-2. Applications [REVOKED]
- 252:641-13-3. Acceptable application surfaces [REVOKED]
- 252:641-13-4. Surface application [REVOKED]

252:641-13-1. General provisions [REVOKED]

252:641-13-2. Applications [REVOKED]

252:641-13-3. Acceptable application surfaces [REVOKED]

252:641-13-4. Surface application [REVOKED]

SUBCHAPTER 15. LAGOONS

Section

- 252:641-15-1. General provisions
- 252:641-15-2. Lagoon design
- 252:641-15-3. Bottom construction
- 252:641-15-4. Dikes
- 252:641-15-5. Lagoon inlet line and septic tank outlet
- 252:641-15-6. Fence

252:641-15-1. General provisions

- (a) **Primary settling.** All sewage entering a lagoon must first pass through a septic tank for primary settling.
- (b) **Total retention.** All lagoons shall be total retention.
- (c) **Location.** Installers shall not locate lagoons where vegetation, timber, or terrain could interfere with prevailing wind action or shade the lagoon during daylight hours.
- (d) **Prohibitions.** The owner/operator shall not dispose or store wastes or contaminants other than sewage in the lagoon. The owner/operator shall not discharge or dispose of sludge from the lagoon prior to obtaining approval from the DEQ.
- (e) **Closure.** The DEQ may, when public health or safety issues arise, require the owner/operator to properly close a lagoon when it is no longer in use.
- (f) **Examples.** Refer to Appendix O, "Examples of Lagoon Installation" for examples.

252:641-15-2. Lagoon design

- (a) **Sizing.** The lagoon shall be designed according to Appendix H, Figures 23 and 24. No lagoon shall have bottom dimensions smaller than ten feet (10') by ten feet (10') or, for round lagoons, have a diameter smaller than fifteen feet (15').
- (b) **Uniform shape.** The shape of the lagoon shall be essentially square or round with no islands or peninsulas.
- (c) **Total Depth.** The total depth of the lagoon shall be at least seven feet (7').

252:641-15-3. Bottom construction

The bottom of the lagoon shall meet the following requirements:

- (1) **Level bottom.** The bottom of the lagoon shall be level.
- (2) **Compacted clay.** The bottom of the lagoon and the interior slope of the dike shall be constructed of homogeneous clay soil and shall be compacted thoroughly.
- (3) **Leakage test required.** During the final inspection, a leakage test shall be conducted on the lagoon.
 - (A) **Leakage test procedure.** The leakage test shall be performed in a manner approved by the DEQ or by:
 - (i) digging one (1) hole in the bottom of the lagoon and four (4) equally spaced holes on the interior slope of the dike at the four-foot water elevation line of the lagoon. The test holes shall be six inches (6") deep;
 - (ii) presoaking the holes by filling them with water and refilling them as necessary to maintain a water depth of six inches (6") in each hole for at least four (4) hours. The presoak shall commence no earlier than twenty-four (24) hours prior to the start of the leakage test procedure; and
 - (iii) after completing the presoak, filling each hole with water and then recording the drop in the water level in sixty (60) minutes or the time it takes until one inch (1") of water has percolated into the soil.
 - (B) **Failing leakage test.** If the leakage rate in any of the test holes exceeds one inch (1") in sixty (60) minutes, the lagoon shall be lined with twelve inches (12") of compacted clay

(Group 5 soil) or bentonite, or a synthetic liner in accordance with OAC 252:656. The lagoon shall be retested after installation of a clay or bentonite liner and may not be approved until the leakage rate is less than or equal to one inch (1") in sixty (60) minutes.

252:641-15-4. Dikes

Dikes shall be constructed as follows:

- (1) **Topsoil.** Before construction, all vegetation and topsoil shall be removed in the area of the dikes.
- (2) **Lifts.** Dikes shall be constructed of homogenous clay in six to nine inch (6"-9") compacted lifts.
- (3) **Slope.** Dikes shall be constructed with a slope of no more than one foot (1') vertical rise per three feet (3') horizontal run (1:3) with a minimum top width of four feet (4'). The top of dikes shall be uniformly graded with no depressions or mounds that would hinder maintenance.
- (4) **Gravity flow systems.** For gravity flow systems, the top of the dike shall be at least six inches (6") below the lowest floor elevation of any building served.
- (5) **Surface runoff.** The top of the dike shall be at least one foot (1') above the surrounding terrain to divert surface runoff.

252:641-15-5. Lagoon inlet line and septic tank outlet

(a) **Lagoon inlet line.** The lagoon inlet line shall:

- (1) be made of solid pipe that complies with the minimum specifications listed in Appendix C;
- (2) terminate in the center of the lagoon;
- (3) be anchored and supported; and
- (4) discharge onto a concrete structure that is a minimum of one (1) square foot.

(b) **Septic tank outlet.** For gravity flow systems, the outlet of the septic tank shall be at least one foot (1') above the designed five-foot (5') maximum liquid depth of the lagoon.

252:641-15-6. Fence

(a) **Fence required.** In order to prevent unauthorized access to the lagoon, the lagoon area shall be surrounded with a fence unless the entire property is fenced and access is controlled.

(b) **Specifications.** The fence shall:

- (1) be, at a minimum, four feet (4') high and provide protection equivalent to the protection afforded by a woven wire or equally-spaced five (5) wire fence. Lagoons that fall within the definition of a small public sewage system and that are located within three hundred fifty feet (350') of existing or platted residential areas or that are in public access areas shall be surrounded by a six-foot (6') woven wire fence or equivalent.
- (2) have a gate that provides access to the lagoon for mowing equipment and maintenance needs.
- (3) not interfere with wind action to the lagoon's surface or shade the lagoon.

(c) **DEQ authority to require more stringent fencing requirements.** In order to protect public health and safety, the DEQ may require more stringent fencing requirements, even when the entire property is fenced.

SUBCHAPTER 17. ALTERNATIVE SYSTEMS [REVOKED]

Section

252:641-17-1. General provisions [REVOKED]

252:641-17-2. Applications [REVOKED]

252:641-17-1. General provisions [REVOKED]

252:641-17-2. Applications [REVOKED]

SUBCHAPTER 19. [RESERVED]

SUBCHAPTER 21. CERTIFICATION FOR ON-SITE SEWAGE TREATMENT SYSTEM INSTALLERS

Section

- 252:641-21-1. General provisions
- 252:641-21-2. Prerequisites for new certifications and renewals
- 252:641-21-2.1 New certification application requirements
- 252:641-21-3. Certification renewal requirements
- 252:641-21-4. Approved training courses [REVOKED]
- 252:641-21-5. Examinations [REVOKED]
- 252:641-21-6. Record-keeping [REVOKED]
- 252:641-21-7. Identification credentials [REVOKED]
- 252:641-21-8. Classifications [REVOKED]
- 252:641-21-9. Class C requirements [REVOKED]
- 252:641-21-10. Class B requirements [REVOKED]
- 252:641-21-11. Class A requirements [REVOKED]
- 252:641-21-12. Duties and responsibilities
- 252:641-21-13. Certification suspension and revocation
- 252:641-21-14. Reciprocity [REVOKED]

252:641-21-1. General provisions

(a) **Applicability.** Persons may become certified by DEQ to install on-site sewage treatment systems by complying with the requirements of this Subchapter.

(b) **Inspections.** Certified installers may self-inspect and approve only systems they install, modify, or repair within the category(ies) for which they are certified. Certified installers may self-inspect and approve any lift-stations or flow equalization tanks they install. However, certified installers may not self-inspect and approve any:

- (1) small public sewage system that has a design flow greater than one thousand, five hundred (1,500) gallons per day; or
- (2) alternative system.

(c) **Compliance.** Certified installers shall comply with all the rules in this Chapter.

(d) **Certification period.** Certifications shall be effective from February 1 or the day of certification, through January 31, unless modified by an Administrative Proceeding.

(e) **Specified dates.** If any date specified in this Subchapter falls on a weekend or holiday, the date of the following working day shall be the effective date.

(f) **Application time frame.** Applications will become void if the applicant fails to meet all certification requirements within one hundred eighty (180) days of being notified of any deficiencies. All fees paid are non-refundable when an application is voided.

(g) **Categories of certification.** The following are the categories of certification for which an installer may become certified:

(1) **Conventional/Shallow Extended/ET/A (CSE).** The "CSE" category includes all systems that utilize conventional subsurface absorption fields, shallow extended subsurface absorption fields, or ET/A fields described in Subchapter 12 of this Chapter.

(2) **Lagoon.** The "Lagoon" category includes all systems that utilize a lagoon described in Subchapter 15 of this Chapter.

(3) **Aerobic-Spray.** The "Aerobic-Spray" category includes all aerobic treatment systems, which are described in Subchapter 10 of this Chapter, that utilize a spray irrigation field described in Subchapter 12 of this Chapter.

(4) **Aerobic-Drip.** The "Aerobic-Drip" category includes all aerobic treatment systems, which are described in Subchapter 10 of this Chapter, that utilize a drip irrigation field described in Subchapter 12 of this Chapter.

(5) **Low Pressure Dosing (LPD).** The "LPD" category includes all systems that utilize a low pressure dosing field described in Subchapter 12 of this Chapter.

252:641-21-2. Prerequisites for new certifications and renewals

Before being eligible for certification or renewal, an applicant must:

- (1) be an individual,
- (2) be eighteen (18) years of age or older,
- (3) owe no outstanding fees or fines to the DEQ,
- (4) be in compliance with the income tax and immigration laws of this state, and
- (5) be in compliance with all DEQ rules and final orders.

252:641-21-2.1. New certification application requirements

An applicant may become certified in any category of certification by doing the following:

(1) **Application.** The applicant must submit to DEQ a completed and signed DEQ Form 641-002, "Certified Installer Application". If the applicant is not currently certified in at least one category of certification, then the applicant must also pay the annual certification fee and submit documentation that the applicant has done the following:

(A) **Installation experience.** The installer must have installed at least five (5) on-site sewage treatment systems in Oklahoma that meet or exceed the rules in this Chapter as determined by an inspection performed by DEQ. These systems must have been installed within the two-year time period preceding the date of certification and may not include any joint inspections required in (5) of this subsection;

(B) **Approval percentage rate.** The installer must have had at least ninety percent (90%) of the systems he/she installed within the last year approved upon the initial inspection, with any disapproved systems only requiring minor changes; and

(C) **Financial assurance.** The installer must document financial assurance by submitting to DEQ one of the following:

(i) **Surety bond.** The applicant may document financial assurance by submitting to DEQ a surety bond guaranteeing payment or performance in the amount of Ten Thousand Dollars (\$10,000) with the following stipulations:

(I) The applicant must be named as the principal of the bond and DEQ must be named as obligee of the bond;

(II) The bond must be effective before the certification can be granted by DEQ and must remain in effect as long as the installer is certified. Upon notification to DEQ that a bond is no longer in effect, DEQ may immediately begin the process to suspend the installer's certification(s); and

(III) Payments made under the terms of the bond shall be made by the surety directly to DEQ. DEQ shall establish an account with these funds from which DEQ may pay for the repair or replacement of a faulty or improperly installed system along with DEQ's costs associated with its response and oversight.

(ii) **Affidavit for tribal and governmental installers.** The applicant may document financial assurance by submitting to DEQ an affidavit that:

(I) the installer is working solely for a federally recognized tribe or a governmental entity; and

(II) the entity will pay for the repair or replacement of faulty or improperly installed systems.

(2) **Training.** The applicant must complete the required DEQ training for the category of certification sought;

(3) **Examination.** The applicant must pass the examination for the category of certification sought with a score of at least seventy percent (70%). Any applicant found cheating on an examination will not be certified, will be subject to having any current certifications revoked, and shall be prohibited from applying for any certifications for a period of twelve (12) months;

(4) **Examination fee.** The applicant must pay to the DEQ the appropriate examination fee; and

(5) **Joint inspections.** The applicant must complete at least two (2) joint field inspections with the DEQ. The systems inspected must:

(A) have been installed by the installer seeking certification; and

(B) be in the category of certification sought.

252:641-21-3. Certification renewal requirements

(a) **Renewal.** A certified installer may renew unexpired certifications by submitting to DEQ the following by January 15:

- (1) a completed renewal application provided by the DEQ;
- (2) the required annual certification fee; and
- (3) documentation that the applicant completed approved renewal training for that certificate year. Renewal training credit may be granted for courses or workshops of four (4) hours or more that have been approved in writing by the DEQ in advance.

(b) **Late renewals.** The applicant shall pay a Fifty-Dollar (\$50.00) late fee for renewal applications postmarked or received by the DEQ after January 15.

(c) **Failure to renew.** Any certification that has not been renewed within twelve (12) months of expiring may not be renewed. Such applicants must apply for a new certification.

252:641-21-4. Approved training courses [REVOKED]

252:641-21-5. Examinations [REVOKED]

252:641-21-6. Record-keeping [REVOKED]

252:641-21-7. Identification credentials [REVOKED]

252:641-21-8. Classifications [REVOKED]

252:641-21-9. Class C requirements [REVOKED]

252:641-21-10. Class B requirements [REVOKED]

252:641-21-11. Class A requirements [REVOKED]

252:641-21-12. Duties and responsibilities

(a) **Systems installed.** For each new installation, modification or repair self-inspected and approved a certified installer shall comply with the following:

(1) **Notify DEQ.** The installer must give DEQ an opportunity to inspect a portion of the system to ascertain that the certified installer continues to meet certification requirements. The certified installer shall notify the local DEQ office, before construction begins, of the time, date and location that an on-site sewage treatment system will be installed, modified or repaired. The installer shall pay DEQ a Fifty-Dollar (\$50.00) fee each time the installer fails to notify the DEQ prior to commencing construction.

(2) **Submittals to DEQ.** Within fifteen (15) working days after the work has been completed, the certified installer shall submit an accurate, completed DEQ Form 641-576A or 641-576S to the local DEQ office. The installer shall pay DEQ a Thirty Dollar (\$30.00) fee each time the installer fails to submit a completed DEQ Form 641-576A or 641-576S within fifteen (15) days of completing the work.

(b) **Record keeping.** Certified installers are responsible for maintaining their own records for:

- (1) each system installed; and
- (2) all training classes completed.

(c) **Identification.** Each certified installer shall present their identification card to DEQ personnel upon request.

252:641-21-13. Certification suspension and revocation

(a) **Reasons for suspension or revocation.** After notice and opportunity for hearing, the DEQ may suspend or revoke an installer's certification(s) for:

- (1) procedural violations such as allowing the bond to expire, failing to pay fees, failing to complete continuing education requirements or other related procedural issues;

- (2) gross inefficiency or incompetence;
 - (3) any violation of the Environmental Quality Code, this Chapter, or any final DEQ order; or
 - (4) dishonesty, fraud or misrepresentation to DEQ.
- (b) **Suspension.** Any person whose certification(s) is suspended by the DEQ:
- (1) may not self-inspect and approve any on-site sewage treatment systems until their certification(s) has been reinstated or they have received a new certification(s).
 - (2) may not apply to become certified in any additional category(ies) during the suspension period.
 - (3) may apply for reinstatement of their certification(s) at any time during the twelve (12) months following the date of their suspension by:
 - (A) correcting any deficiency(ies);
 - (B) paying any outstanding fees or fines owed to DEQ including the reinstatement fee of Fifty Dollars (\$50.00);
 - (C) meeting the renewal requirements of 252:641-21-3 if the reinstatement takes place during the following certification period; and
 - (D) being in compliance with all final DEQ rules and orders.
- (c) **Revocation.** Any individual who has had their certification(s) revoked by the DEQ:
- (1) may not self-inspect and approve any on-site sewage treatment system; and
 - (2) must wait at least one (1) year from the date of revocation before filing an application for a new certification(s), unless a final order states otherwise.

252:641-21-14. Reciprocity [REVOKED]

SUBCHAPTER 22. CERTIFICATION FOR PERSONS WHO PERFORM SOIL PROFILE DESCRIPTIONS

Section

- 252:641-22-1. General provisions
- 252:641-22-2. Prerequisites for new certifications and renewals
- 252:641-22-3. New certification application requirements
- 252:641-22-4. Certification renewal requirements
- 252:641-22-5. Duties and responsibilities
- 252:641-22-6. Certification suspension and revocation

252:641-22-1. General provisions

- (a) **Applicability.** Any person who performs a soil profile description to be used to design an on-site sewage treatment system must first be certified by the DEQ. Persons can become certified by the DEQ to perform soil profile descriptions by complying with the requirements of this Subchapter.
- (b) **Compliance.** Certified soil profilers shall comply with all the rules in this Chapter.
- (c) **Certification Period.** Certifications shall be effective from February 1 or the day of certification, through January 31, unless modified by an Administrative Proceeding.
- (d) **Specified dates.** If any date specified in this Subchapter falls on a weekend or holiday, the date of the following working day shall be the effective date.
- (e) **Application time frame.** Applications will become void if the applicant fails to meet all certification requirements within one hundred eighty (180) days of being notified of any deficiencies. All fees paid are non-refundable when an application is voided.

252:641-22-2. Prerequisites for new certifications and renewals

Before being eligible for certification or renewal, an applicant must:

- (1) be an individual,
- (2) be eighteen (18) years of age or older,
- (3) be a Professional Engineer, Professional Land Surveyor, Professional Sanitarian or Professional Environmental Specialist registered to practice in Oklahoma or Soil Scientist as defined in 27A O.S. § 3-1-103(20),

- (4) owe no outstanding fees or fines to the DEQ,
- (5) be in compliance with the income tax and immigration laws of this state, and
- (6) be in compliance with all DEQ rules and final orders.

252:641-22-3. New certification application requirements

An applicant may, at any time, apply to become a certified soil profiler by doing the following:

- (1) **Application.** The applicant must submit to the DEQ a completed and signed DEQ Form 641-011, "Certified Soil Profiler Application";
- (2) **Training.** The applicant must complete the required DEQ training;
- (3) **Examination and fee.** The applicant must pay the examination fee and pass the examination for becoming a soil profiler. Any applicant found cheating on an examination will not be certified and shall be prohibited from applying for certification for a period of twelve (12) months;
- (4) **Joint profiles.** The applicant must complete at least four (4) joint soil profile descriptions with the DEQ;
- (5) **Annual fee.** The applicant must pay to the DEQ the annual certification fee; and
- (6) **Financial assurance.** The applicant must document financial assurance by providing DEQ with one of the following:

(A) **Surety bond.** The applicant may document financial assurance by submitting to DEQ a copy of a surety bond guaranteeing payment or performance in the amount of Ten Thousand Dollars (\$10,000.00) with the following stipulations:

- (i) The applicant must be named as the principal of the bond and DEQ must be named as obligee of the bond.
- (ii) The bond must be effective before the certification can be granted by DEQ and must remain in effect as long as the soil profiler is certified. Upon notification to DEQ that a bond is no longer in effect, DEQ may immediately begin the process to suspend the profiler's certification.
- (iii) Payments made under the terms of the bond shall be made by the surety directly to DEQ. DEQ shall establish an account with these funds to cover the costs:
 - (I) to bring an on-site sewage treatment system into compliance when the system was improperly designed using an inaccurate soil profile description; and
 - (II) for DEQ's response and oversight.

(B) **Affidavit for tribal and governmental soil testers.** The applicant may document financial assurance by submitting to DEQ an affidavit that:

- (i) the soil profiler is working solely for a federally recognized tribe or a governmental entity; and
- (ii) the entity will pay for the repair or replacement of improperly designed systems.

252:641-22-4. Certification renewal requirements

(a) **Renewal.** A certified soil profiler may renew an unexpired certification by doing the following by January 15:

- (1) **Application.** The soil profiler must submit to DEQ a completed renewal application provided by the DEQ;
 - (2) **Annual fee.** The soil profiler must pay to DEQ the required annual certification fee;
 - (3) **Renewal training.** The soil profiler must submit to DEQ documentation that the applicant completed approved renewal training for that certificate year. Renewal training credit may be granted for courses or workshops of four (4) hours or more that have been approved in writing by the DEQ in advance;
 - (4) **Texturing samples.** The soil profiler must complete the analysis of any soil samples issued to them by the DEQ for texturing. All results must be submitted to DEQ on DEQ Form 641-006, "Soil Texturing Worksheet" within fourteen (14) days of receiving the soil samples; and
 - (5) **Annual texturing test.** The soil profiler shall pass the annual texturing test.
- (b) **Late fees.** The soil profiler shall pay a Fifty-Dollar (\$50.00) late fee for renewal applications postmarked or received by the DEQ after January 15.
- (c) **Failure to renew.** Any certification that has not been renewed within twelve (12) months of

expiring may not be renewed. Such applicants must apply for a new certification.

252:641-22-5. Duties and responsibilities

- (a) **Soil profile descriptions.** For each soil profile description performed, the soil profiler shall notify the local DEQ office the day the soil profile description will be performed to allow the DEQ the opportunity to corroborate the results. The soil profiler shall pay DEQ a Fifty-Dollar (\$50.00) fee each time the soil profiler fails to notify the DEQ prior to commencing the soil profile description.
- (b) **Record keeping.** Certified soil profilers are responsible for maintaining their own records for:
 - (1) each soil profile description performed; and
 - (2) all training classes completed.
- (c) **Identification.** Each certified soil profiler shall present their identification card to DEQ personnel upon request.

252:641-22-6. Certification suspension and revocation

- (a) **Reasons for suspension or revocation.** After notice and opportunity for hearing, the DEQ may suspend or revoke certification for:
 - (1) procedural violations such as allowing the bond to expire, failing to pay fees, failing to complete continuing education requirements or other related procedural issues;
 - (2) gross inefficiency or incompetence;
 - (3) any violation of the Environmental Quality Code, this Chapter, or any final DEQ order; or
 - (4) dishonesty, fraud or misrepresentation to DEQ.
- (b) **Suspension.** Any person whose certification is suspended by the DEQ:
 - (1) may not perform soil profile descriptions for use in designing on-site sewage treatment systems until their certification has been reinstated or they have received a new certification.
 - (2) may apply for reinstatement of their certification at any time during the twelve (12) months following the date of their suspension by:
 - (A) correcting any deficiency(ies);
 - (B) paying any outstanding fees or fines owed to DEQ including the reinstatement fee of Fifty Dollars (\$50.00);
 - (C) meeting the renewal requirements of 252:641-22-4 if the reinstatement takes place during the following certification period; and
 - (D) being in compliance with all final DEQ rules and orders.
- (c) **Revocation.** Any individual whose certification has been revoked by the DEQ must wait one (1) year from the date of revocation before filing an application for a new certificate, unless a final order states otherwise.

SUBCHAPTER 23. FEES

Section

- 252:641-23-1. Requested services fees
- 252:641-23-2. Certified sewage treatment system installer fees
- 252:641-23-3. Certified soil profiler fees
- 252:641-23-4. Fee escalator based on consumer price index (CPI)

252:641-23-1. Requested services fees

- (a) **Fees.** The following fee schedule applies to services provided by the Environmental Complaints and Local Services Division (ECLS) of the DEQ.
 - (1) Soil profile description:
 - (A) When DEQ augers test holes -
 - (i) \$150.00 (Effective July 1, 2008)
 - (ii) \$175.00 (Effective July 1, 2009)
 - (iii) \$200.00 (Effective July 1, 2010)
 - (iv) \$225.00 (Effective July 1, 2011)
 - (v) \$250.00 (Effective July 1, 2012)

- (B) When pits are provided by applicant -
 - (i) \$60.00 (Effective July 1, 2008)
 - (ii) \$80.00 (Effective July 1, 2009)
 - (iii) \$100.00 (Effective July 1, 2010)
 - (iv) \$125.00 (Effective July 1, 2011)
 - (v) \$150.00 (Effective July 1, 2012)
- (2) DEQ authorization or permit to construct a new on-site sewage treatment system when the average daily flow is:
 - (A) less than or equal to one thousand five hundred (1,500) gallons and when the installer is:
 - (i) certified to self-inspect the system -
 - (I) \$150.00 (Effective July 1, 2008)
 - (II) \$175.00 (Effective July 1, 2009)
 - (III) \$200.00 (Effective July 1, 2010)
 - (IV) \$225.00 (Effective July 1, 2011)
 - (V) \$250.00 (Effective July 1, 2012)
 - (ii) not certified to self-inspect the system -
 - (I) \$250.00 (Effective July 1, 2008)
 - (II) \$275.00 (Effective July 1, 2009)
 - (III) \$300.00 (Effective July 1, 2010)
 - (IV) \$325.00 (Effective July 1, 2011)
 - (V) \$350.00 (Effective July 1, 2012)
 - (B) greater than one thousand five hundred (1,500) gallons -
 - (i) \$350.00 (Effective July 1, 2008)
 - (ii) \$375.00 (Effective July 1, 2009)
 - (iii) \$400.00 (Effective July 1, 2010)
 - (iv) \$425.00 (Effective July 1, 2011)
 - (v) \$450.00 (Effective July 1, 2012)
- (3) DEQ authorization to modify an existing on-site sewage treatment system when the installer is:
 - (A) certified to self-inspect the system -
 - (i) \$60.00 (Effective July 1, 2008)
 - (ii) \$80.00 (Effective July 1, 2009)
 - (iii) \$100.00 (Effective July 1, 2010)
 - (iv) \$125.00 (Effective July 1, 2011)
 - (v) \$150.00 (Effective July 1, 2012)
 - (B) not certified to self-inspect the system -
 - (i) \$160.00 (Effective July 1, 2008)
 - (ii) \$180.00 (Effective July 1, 2009)
 - (iii) \$200.00 (Effective July 1, 2010)
 - (iv) \$225.00 (Effective July 1, 2011)
 - (v) \$250.00 (Effective July 1, 2012)
- (4) Plan review of an alternative on-site sewage treatment system -
 - (A) \$100.00 (Effective July 1, 2008)
 - (B) \$125.00 (Effective July 1, 2009)
 - (C) \$150.00 (Effective July 1, 2010)
 - (D) \$175.00 (Effective July 1, 2011)
 - (E) \$200.00 (Effective July 1, 2012)
- (5) Existing system evaluation report -
 - (A) \$150.00 (Effective July 1, 2008)
 - (B) \$175.00 (Effective July 1, 2009)
 - (C) \$200.00 (Effective July 1, 2010)
 - (D) \$225.00 (Effective July 1, 2011)
 - (E) \$250.00 (Effective July 1, 2012)

(b) **Waiver of fees.**

(1) **Indigents and nonprofit organizations.** The DEQ may waive fees for indigents and nonprofit organizations. Requests for a waiver of fees under this paragraph shall be decided by the Director of the Environmental Complaints and Local Services Division of the DEQ.

(2) **Investigation of complaints.** The DEQ may perform a soil profile description as a part of an investigation of a system known to be malfunctioning or a system which is the subject of a complaint filed by a third party. No fee shall be charged as a part of this investigation.

252:641-23-2. Certified sewage treatment system installer fees

(a) **Certification fees.** The following are the fees associated with the installer certification program.

- (1) Annual certification fee -
 - (A) \$150.00
 - (B) \$175.00 (Effective July 1, 2010)
 - (C) \$200.00 (Effective July 1, 2012)
- (2) Examination fee for each category of certification -
 - (A) \$100.00
 - (B) \$125.00 (Effective July 1, 2010)
 - (C) \$150.00 (Effective July 1, 2012)
- (3) Late fee - \$50.00
- (4) Reinstatement fee - \$50.00
- (5) Failure to notify fee - \$50.00
- (6) Failure to submit paperwork timely fee - \$30.00

(b) **Nonrefundable.** Fees are nonrefundable.

252:641-23-3. Certified soil profiler fees

(a) **Certification fees.** The following are the fees associated with the soil profiler certification program.

- (1) Annual certification fee -
 - (A) \$150.00 (Effective July 1, 2008)
 - (B) \$175.00 (Effective July 1, 2010)
 - (C) \$200.00 (Effective July 1, 2012)
- (2) Examination fee -
 - (A) \$100.00 (Effective July 1, 2008)
 - (B) \$125.00 (Effective July 1, 2010)
 - (C) \$150.00 (Effective July 1, 2012)
- (3) Late fee - \$50.00
- (4) Reinstatement fee - \$50.00
- (5) Failure to notify fee - \$50.00

(b) **Nonrefundable.** Fees are nonrefundable.

252:641-23-4. Fee escalator based on consumer price index (CPI)

To assist in meeting rising costs to DEQ associated with the on-site sewage program, the fees set out in Subchapter 23 shall be automatically adjusted on July 1, 2013, and every year thereafter on July 1st, to correspond to the percentage, if any, by which the Consumer Price Index (CPI) for the most recent calendar year exceeds the CPI for the previous calendar year. DEQ may round the adjusted fees up to the nearest dollar. DEQ may waive collection of an automatic increase in a given year if it determines other revenues, including appropriated state general revenue funds, have increased sufficiently to make the funds generated by the automatic adjustment unnecessary in that year. A waiver does not affect future automatic adjustments.

(1) Any automatic fee adjustment under this subsection may be averted or eliminated, or the adjustment percentage may be modified, by rule promulgated pursuant to the Oklahoma Administrative Procedures Act. The rulemaking process may be initiated in any manner provided by law, including a petition for rulemaking pursuant to 75 O.S. § 305 and OAC 252:4-5-3 by any

person affected by the automatic fee adjustment.

(2) If the United States Department of Labor ceases to publish the CPI or revises the methodology or base years, no further automatic fee adjustments shall occur until a new automatic fee adjustment rule is promulgated pursuant to the Oklahoma Administrative Procedures Act.

(3) For purposes of this subsection, "Consumer Price Index" or "CPI" means the Consumer Price Index - All Urban Consumers (U.S. All Items, Current Series, 1982-1984=100, CUUR0000SA0) published by the United States Department of Labor. The CPI for a calendar year is the figure denoted by the Department of Labor as the "Annual" index figure for that calendar year.

APPENDIX A. SYSTEM OPTIONS WITH MINIMUM VERTICAL SEPARATION DISTANCES AND MINIMUM LOT SIZE REQUIREMENTS

Figure 1. Options and Vertical Separation Distances for Systems Designed Using a Soil Profile Description

PREVALENT SOIL GROUP IN SEPARATION RANGE	CONVENTIONAL AND SHALLOW EXTENDED SUBSURFACE ABSORPTION FIELD	LOW PRESSURE DOSING FIELD	ET/A FIELD	LAGOON	DRIP IRRIGATION FIELD PRECEDED BY AEROBIC TREATMENT UNIT	SPRAY IRRIGATION FIELD PRECEDED BY AEROBIC TREATMENT UNIT	
1	NOT ALLOWED	ALLOWED If at least 24" of separation between the trench bottom and the limiting layer	ALLOWED If installed in Group 5 soil with at least 6" of separation between the trench bottom and soil impervious to boring or water saturated soil. ET/A's are not allowed in Zone 1, see Appendix H, Figures 10 and 11. Requires lot size of at least 1 acre.	ALLOWED No applicable vertical separation range. Requires a lot size of at least 2 ½ acres. Lagoons are not allowed in Zone 1, see Appendix H, Figures 23 and 24. Lagoons are not acceptable in Zones 7-10 when the flow is less than 100 gpd.	ALLOWED If at least 18" of separation between the drip line and rock and/or water saturated soil	ALLOWED No applicable vertical separation range.	
2	ALLOWED If at least 24" of separation between the trench bottom and the limiting layer	ALLOWED If at least 16" of separation between the trench bottom and the limiting layer					ALLOWED If at least 14" of separation between the drip line and rock and/or water saturated soil
2a	ALLOWED If at least 21" of separation between the trench bottom and the limiting layer	ALLOWED If at least 14" of separation between the trench bottom and the limiting layer					ALLOWED If at least 12" of separation between the drip line and rock and/or water saturated soil
3	ALLOWED If at least 18" of separation between the trench bottom and the limiting layer	ALLOWED If at least 12" of separation between the trench bottom and the limiting layer					ALLOWED If at least 10" of separation between the drip line and rock and/or water saturated soil
3a	ALLOWED If at least 14" of separation between the trench bottom and the limiting layer	ALLOWED If at least 10" of separation between the trench bottom and the limiting layer					ALLOWED If at least 8" of separation between the drip line and rock and/or water saturated soil
4	ALLOWED If at least 10" of separation between the trench bottom and the limiting layer	ALLOWED If at least 6" of separation between the trench bottom and the limiting layer					ALLOWED If at least 6" of separation between the drip line and rock and/or water saturated soil
5	NOT ALLOWED	NOT ALLOWED					ALLOWED If at least 6" of separation between the drip line and rock and/or water saturated soil

Figure 2. Options and Vertical Separation Distances for Systems Designed Using a Percolation Test

PERCOLATION RATE	CONVENTIONAL SUBSURFACE ABSORPTION FIELD	SHALLOW EXTENDED SUBSURFACE ABSORPTION FIELD - LOW PRESSURE DOSING FIELD - ET/A FIELD	LAGOON	DRIP IRRIGATION FIELD PRECEDED BY AEROBIC TREATMENT UNIT	SPRAY IRRIGATION FIELD PRECEDED BY AEROBIC TREATMENT UNIT
0-75 mpi	ALLOWED If at least 6" of separation between the bottom of the trench and the bottom of the percolation test hole	NOT ALLOWED Has to be designed with a soil profile description	ALLOWED	NOT ALLOWED Has to be designed with soil profile description	ALLOWED If sized using Group 5 sizing criteria
>75 mpi	NOT ALLOWED				

Figure 3. Minimum Lot Size Requirements

TYPE OF TREATMENT/DISPERSAL FIELD	MINIMUM LOT SIZE [†]	
	<i>With private well</i>	<i>With public water</i>
Conventional or Shallow Extended Subsurface Absorption Field in Dispersal Site with: (a) Percolation rate of 30 minutes or less; or (b) Group 2, 2a or 3 soil classification	3/4 acre	1/2 acre
Conventional or Shallow Extended Subsurface Absorption Field in Dispersal Site with: (a) Percolation rate of more than 30 minutes; or (b) Group 3a or 4 soil classification	1 acre	1 acre
Low Pressure Dosing Field in Dispersal Site with Group 1 or 2 soil classification	3/4 acre	1/2 acre
Evapotranspiration/Absorption (ET/A) Field	1 acre	1 acre
Drip Irrigation Field	3/4 acre	1/2 acre
Spray Irrigation Field	3/4 acre	1/2 acre
Lagoon	2 1/2 acres	2 1/2 acres

[†] The minimum lot size excludes road easements.

APPENDIX B. SOIL GROUPS

SOIL GROUP	CORRESPONDING SOIL TEXTURES
1	<ul style="list-style-type: none"> • Coarse sand • Loamy coarse sand • All soils with a rock fragment content of > 35% by volume having continuous voids > 1 mm
2	<ul style="list-style-type: none"> • Sand • Loamy sand (not including coarse sand or loamy coarse sand)
2a	<ul style="list-style-type: none"> • Sandy loam
3	<ul style="list-style-type: none"> • Sandy clay loam • Loam • Silt loam with $\leq 20\%$ clay • Silt
3a	<ul style="list-style-type: none"> • Sandy clay without slickensides with moderate and strong soil structure • Silt loam with $>20\%$ clay
4	<ul style="list-style-type: none"> • Clay loam • Silty clay loam
5	<ul style="list-style-type: none"> • Sandy clay with slickensides or weak soil structure • Clay • Silty clay

APPENDIX C. PIPE SPECIFICATIONS FOR ON-SITE SEWAGE TREATMENT SYSTEMS

USE	PIPE SIZE	ACCEPTABLE MATERIALS
Building sewer and other solid pipe when used for single family residences only	Minimum 3" diameter	<i>Acrylonitrile Butadiene Styrene (ABS):</i> ASTM D2661 ASTM D2751 ASTM F628
Building sewer and other solid pipe when the average flow is 2,000 gpd or less	Minimum 4" diameter	<i>Polyvinyl Chloride (PVC):</i> ASTM D2665 ASTM D2949 ASTM 3033 ASTM 3034 ASTM F789
Building sewer and other solid pipe when the average flow is greater than 2,000 gpd	Minimum 6" diameter	
Discharge line from lift stations or other pressurized effluent waste water lines [†]	Minimum 1" diameter	
Low pressure dosing manifold pipe	3" diameter	<i>Polyvinyl Chloride (PVC):</i> ASTM D2846 ASTM F441 ASTM F442 Schedule 40
Low pressure dosing perforated pipe	1 ½" diameter	
Perforated pipe when used in a conventional subsurface absorption field or an ET/A field	Minimum 3" diameter	<i>Polyethylene (PE):</i> ASTM F405 ASTM F810 ASTM D3350 <i>Polyvinyl Chloride (PVC):</i> ASTM D2729 ASTM D3034 ASTM D3350

[†]All reclaimed, pressurized water piping shall be colored purple (Pantone 522) by the manufacturer.

APPENDIX D. SAMPLING FREQUENCY & TESTING REQUIREMENTS FOR ON-SITE SURFACE APPLICATION OF TREATED SEWAGE [REVOKED]

APPENDIX E. HORIZONTAL SEPARATION DISTANCE REQUIREMENTS FOR ON-SITE SEWAGE TREATMENT SYSTEMS

Required Horizontal Separation Distances in Feet

	Aerobic Treatment Unit, Flow Equalization Tank, Low Pressure Dosing Tank, Lift Station, Septic Tank & Trash Tank	Perforated Pipe, Chamber, or Drip Irrigation Line	Solid Pipe	Lagoons	Spray Irrigation Heads	Spray Irrigation Effluent
Private Well or Surface Water Supply	50 ¹	50 ¹	50 ³	50 ^{2,4}	50 ¹	25
Public Water Supply Well	300	300	50	300 ⁴	300	300
Building	5	5	N/A	50 ^{5,6}	N/A	N/A
Other Structure⁷	N/A ⁸	5	N/A ⁹	N/A	N/A	N/A
Waterline	5	15	10 ¹⁰	15 ⁴	15	N/A
Property Line	5	5	5	10 ⁵	15	15
Impoundment or Stream¹¹	15	15	N/A	15 ⁵	25	25
French Drain/ Curtain Drain	15	15	N/A	15 ⁵	15	15

¹Distances shall be one hundred feet (100') if the soil percolates one inch (1") in less than five (5) minutes or is classified as a Group 1 soil in the separation range.

²Distances shall be one hundred feet (100') if the ground slopes toward the water supply.

³Distances may be reduced up to ten feet (10') if, at a minimum, Schedule 40 pipe is used.

⁴The distance shall be measured horizontally from the center line of the nearest dike.

⁵The distance shall be measured from the outside base of the nearest dike.

⁶This only applies to residences that are not located on the owner's property.

⁷"Other structures" include but are not limited to driveways, parking lots and paved areas.

⁸If septic tanks are located under paved areas, access to all manhole/cleanout openings shall be provided.

⁹If solid pipe is installed under a roadway or a driveway, the pipe under the roadway/driveway and the ten feet (10') of pipe extending out from under the roadway/driveway on both sides shall be, at a minimum Schedule 40 pipe or sleeved with Schedule 40 pipe.

¹⁰Ten feet (10') horizontal or two feet (2') vertical separation shall be maintained between any water line and solid pipe. When proper horizontal and vertical separation cannot be obtained then the solid pipe shall be constructed of, at a minimum, Schedule 40 pipe and shall be installed so the joints of both the water line and the solid pipe are as far apart as possible.

¹¹This includes the top bank of any stream or the normal pool elevation of an impoundment that is not used for a surface water supply.

APPENDIX F. ESTIMATED AVERAGE DAILY FLOW FOR SMALL PUBLIC ON-SITE SEWAGE TREATMENT SYSTEMS

TYPE OF ESTABLISHMENT	FLOW UNIT	ESTIMATED AVERAGE DAILY FLOW In Gallons
Bar or Lounge	Per Seat	10
Boarding School	Per Room	50
Church w/o Kitchen	Per Sanctuary Seat	4
Church w/Kitchen	Per Sanctuary Seat	6
Condominiums, Apartments, Townhouses, Mobile Home Parks, and Housing Developments	Per Residence w/1 or 2 Bedrooms	200
	Each additional Bedroom	66
Construction Site	Per Worker	50
Country Club	Per Member	25
Daycare w/o Kitchen	Per Child	15
Daycare w/Kitchen	Per Child	25
Factory	Per Person Per Shift	15
Hospital	Per Bed	200
Hotel or Motel	Per Bed	75
Lounge	Per Seat	10
Movie Theater	Per Seat	5
Nursing Home	Per Bed	100
Office Building w/o Food Service	Per Occupant	5
Office Building w/Food Service	Per Occupant	10
Park w/o Bathhouse	Per Person	10
Park w/Bathhouse	Per Person	15
Laundry Mat	Per Machine	250
Restaurant-Fast Food	Per Seat	15
Restaurant-Full Service	Per Seat	35
RV Park	Per Space	50
School w/Food Service	Per Student	25
School w/o Food Service	Per Student	15
Service Station	Per Vehicle	10
Stores	Per Restroom	200
Swimming Pool Bathhouses	Per Person	10
Youth Camps	Per Camper	30

**APPENDIX G. MINIMUM TRENCH LENGTH FOR SUBSURFACE
ABSORPTION SYSTEMS [REVOKED]**

**APPENDIX H. SIZE CHARTS FOR ON-SITE
SEWAGE TREATMENT SYSTEMS**

Figure 1. Individual Conventional Subsurface Absorption Fields Designed Using a Percolation Test

Minimum Trench Length in Feet

PERCOLATION RATE FOR DISPERSAL SITE	NUMBER OF BEDROOMS IN RESIDENCE [†]			
	Two or Fewer	Three	Four	Each Additional Bedroom
0-15 minutes per inch	200	270	340	70
16-30 minutes per inch	310	410	510	100
31-45 minutes per inch	420	560	700	140
46-60 minutes per inch	590	790	990	200
61-75 minutes per inch	770	1,030	1,290	260
>75 minutes per inch	Prohibited			

[†] These figures are based on an average flow of 6,000 gallons per month for a two-bedroom residence with an additional 2,000 gallons per month added for each additional bedroom. The size of the system should be increased if the actual or anticipated water usage exceeds this average.

Figure 2. Individual Conventional Subsurface Absorption Fields Utilizing Chambers When Designed Using a Percolation Test

Minimum Trench Length in Feet

PERCOLATION RATE FOR DISPERSAL SITE	NUMBER OF BEDROOMS IN RESIDENCE [†]			
	Two or Fewer	Three	Four	Each Additional Bedroom
0-15 minutes per inch	160	215	270	55
16-30 minutes per inch	250	330	410	80
31-45 minutes per inch	340	450	560	110
46-60 minutes per inch	470	630	790	160
61-75 minutes per inch	620	830	1040	210
>75 minutes per inch	Prohibited			

[†] These figures are based on an average flow of 6,000 gallons per month for a two-bedroom residence with an additional 2,000 gallons per month added for each additional bedroom. The size of the system should be increased if the actual or anticipated water usage exceeds this average.

Figure 3. Individual Conventional Subsurface Absorption Fields Designed Using a Soil Profile Description

Minimum Trench Length in Feet

SOIL GROUP	NUMBER OF BEDROOMS IN RESIDENCE [†]			
	Two or Fewer	Three	Four	Each Additional Bedroom
1	Prohibited			
2	160	210	260	50
2a	250	330	410	80
3	340	450	550	100
3a	500	665	830	165
4	660	880	1,100	220
5	Prohibited			

[†] These figures are based on an average flow of 6,000 gallons per month for a two-bedroom residence with an additional 2,000 gallons per month added for each additional bedroom. The size of the system should be increased if the actual or anticipated water usage exceeds this average.

Figure 4. Small Public Conventional Subsurface Absorption Fields Designed Using a Percolation Test

Minimum Linear Feet Per Gallon per Day

PERCOLATION RATE FOR DISPERSAL SITE	LINEAR FEET PER GALLON PER DAY
0-15 minutes per inch	1.2
16-30 minutes per inch	1.5
31-45 minutes per inch	2
46-60 minutes per inch	2.5
61-75 minutes per inch	3.85
>75 minutes per inch	Prohibited

Figure 5. Small Public Conventional Subsurface Absorption Fields Designed Using a Soil Profile Description

Minimum Linear Feet per Gallon per Day

SOIL GROUP	LINEAR FEET PER GALLON PER DAY
1	Prohibited
2	0.8
2a	1.3
3	1.7
3a	2.5
4	3.3
5	Prohibited

Figure 6. Individual Shallow Extended Subsurface Absorption Fields Designed Using a Soil Profile Description

Minimum Trench Length in Feet

SOIL GROUP	NUMBER OF BEDROOMS IN RESIDENCE [†]			
	Two or Fewer	Three	Four	Each Additional Bedroom
1	Prohibited			
2	260	340	420	80
2a	400	530	660	130
3	540	720	900	180
3a	800	1,060	1,320	260
4	1,060	1,410	1,760	350
5	Prohibited			

[†] These figures are based on an average flow of 6,000 gallons per month for a two-bedroom residence with an additional 2,000 gallons per month added for each additional bedroom. The size of the system should be increased if the actual or anticipated water usage exceeds this average.

Figure 7. Small Public Shallow Extended Subsurface Absorption Fields Designed Using a Soil Profile Description

Minimum Linear Feet per Gallon per Day

SOIL GROUP	LINEAR FEET PER GALLON PER DAY
1	Prohibited
2	1.3
2a	2.1
3	2.7
3a	4.0
4	5.3
5	Prohibited

Figure 8. Individual Low Pressure Dosing Fields Designed Using a Soil Profile Description

Total Linear Trench Length in Feet

SOIL GROUP^{††}	NUMBER OF BEDROOMS IN RESIDENCE[†]			
	Two or Fewer	Three	Four	Five
1	120	160	200	240
2	160	200	240	280
2a, 3, 3a, 4, & 5	Prohibited			

[†] These figures are based on an average flow of 6,000 gallons per month for a two-bedroom residence with an additional 2,000 gallons per month added for each additional bedroom. The size of the system should be increased if the actual or anticipated water usage exceeds this average.

^{††} Low pressure dosing fields may be allowed in soil groups 2a, 3, 3a and 4 when designed and approved as an alternative on-site sewage treatment system.

Figure 9. Small Public Low Pressure Dosing Fields Designed Using a Soil Profile Description

Total Linear Trench Length in Feet

SOIL GROUP [†]	AVERAGE DAILY FLOW IN GALLONS			
	200	275	350	400 ^{††}
1	120	160	200	240
2	160	200	240	280
2a, 3, 3a, 4 & 5	Prohibited			

[†] Low pressure dosing fields may be allowed in soil groups 2a, 3, 3a and 4 when designed and approved as an alternative on-site sewage treatment system.

^{††} Low pressure dosing fields may be allowed for average daily flows over 400 gpd, but they will have to be designed and approved as an alternative on-site sewage treatment system.

Figure 10. Individual ET/A Fields Designed Using a Soil Profile Description - Soil Group 5 Only

Minimum Trench Length in Feet

ZONE [See Figure 25 in this Appendix (relating to net evaporation zones)]	NUMBER OF BEDROOMS IN RESIDENCE [†]			
	Two or Fewer	Three	Four	Each Additional Bedroom
1	2,059	2,745	3,432	686
2	1,872	2,496	3,120	624
3	1,647	2,196	2,745	549
4	1,471	1,961	2,451	490
5	1,373	1,830	2,288	457
6	1,144	1,525	1,907	381
7	958	1,277	1,596	319
8	792	1,056	1,320	264
9	675	900	1,125	225
10	580	773	967	193

[†] These figures are based on an average flow of 6,000 gallons per month for a two-bedroom residence with an additional 2,000 gallons per month added for each additional bedroom. The size of the system should be increased if the actual or anticipated water usage exceeds this average.

Figure 11. Small Public ET/A Fields Designed Using a Soil Profile Description - Soil Group 5 Only

Minimum Trench Length in Feet

AVERAGE DAILY FLOW In Gallons	ZONE									
	[See Figure 25 in this Appendix (relating to net evaporation zones)]									
	1	2	3	4	5	6	7	8	9	10
25	261	238	209	187	174	145	122	100	86	70
50	522	475	418	373	348	290	243	200	171	141
75	783	712	626	560	522	435	364	300	257	212
100	1,044	949	835	746	696	580	485	401	342	282
200	2,088	1,898	1,670	1,491	1,392	1,160	971	803	684	564
300	3,131	2,847	2,505	2,237	2,088	1,740	1,456	1,204	1,027	846
400	4,175	3,796	3,340	2,982	2,784	2,320	1,942	1,606	1,369	1,128
500	5,219	4,745	4,175	3,728	3,479	2,899	2,427	2,007	1,711	1,411
600	6,263	5,694	5,010	4,473	4,175	3,479	2,913	2,409	2,053	1,693
700	7,307	6,642	5,845	5,219	4,871	4,059	3,398	2,810	2,396	1,975
800	8,351	7,591	6,680	5,965	5,567	4,639	3,884	3,112	2,738	2,257
900	9,394	8,540	7,515	6,710	6,263	5,219	4,369	3,613	3,080	2,539
1,000	10,438	9,489	8,351	7,456	6,959	5,799	4,855	4,015	3,422	2,821
1,100	11,482	10,438	9,186	8,201	7,655	6,379	5,340	4,416	3,765	3,105
1,200	12,526	11,387	10,021	8,947	8,351	6,959	5,826	4,818	4,107	3,385
1,300	13,570	12,336	10,856	9,693	9,046	7,539	6,311	5,219	4,449	3,667
1,400	14,613	13,285	11,691	10,438	9,742	8,119	6,797	5,621	4,791	3,950
1,500	15,657	14,234	12,526	11,184	10,438	8,698	7,282	6,022	5,134	4,232
1,600	16,701	15,183	13,361	11,929	11,134	9,278	7,768	6,423	5,476	4,514
1,700	17,745	16,132	14,196	12,675	11,830	9,858	8,253	6,825	5,818	4,796
1,800	18,789	17,081	15,031	13,420	12,526	10,438	8,739	7,226	6,160	5,078
1,900	19,832	18,030	15,866	14,166	13,222	11,018	9,224	7,628	6,502	5,360
2,000	20,876	18,978	16,701	14,912	13,918	11,598	9,710	8,029	6,845	5,642
2,500	26,095	23,718	20,876	18,640	17,397	14,498	12,138	10,037	8,556	7,053
3,000	31,314	28,458	25,052	22,367	20,876	17,397	14,565	12,044	10,267	8,463
3,500	36,533	33,212	29,227	26,096	24,356	20,296	16,993	14,052	11,978	9,874
4,000	41,753	37,957	33,402	29,823	27,835	23,196	19,420	16,059	13,689	11,284
4,500	46,972	42,702	37,578	33,551	31,314	26,096	21,848	18,066	15,401	12,695
5,000	52,191	47,446	41,573	37,279	34,794	28,995	24,275	20,073	17,112	14,106

Figure 12. Individual Drip Irrigation Fields Designed Using a Soil Profile Description

Minimum Trench Length in Feet

SOIL GROUP	NUMBER OF BEDROOMS IN RESIDENCE [†]			
	Two or Fewer	Three	Four	Each Additional Bedroom
1	125	165	205	40
2	160	210	260	50
2a	250	330	410	80
3	340	450	550	100
3a	500	665	830	165
4	660	880	1,100	220
5	1,000	1,330	1,660	330

[†] These figures are based on an average flow of 6,000 gallons per month for a two-bedroom residence with an additional 2,000 gallons per month added for each additional bedroom. The size of the system should be increased if the actual or anticipated water usage exceeds this average.

Figure 13. Individual Spray Irrigation Fields Designed Using a Soil Profile Description – Net Evaporation Zone 1 [See Figure 25 in this Appendix (relating to net evaporation zones)]

Minimum Spray Irrigation Area in Square Feet

SOIL GROUP	NUMBER OF BEDROOMS IN RESIDENCE [†]			
	Two or Fewer	Three	Four	Each Additional Bedroom
1	7,282	9,709	12,137	2,427
2	8,010	10,680	13,350	2,670
2a	8,738	11,651	14,564	2,913
3	9,467	12,622	15,777	3,155
3a	10,195	13,593	16,991	3,398
4	10,923	14,564	18,205	3,641
5	14,564	19,418	24,273	4,854

[†] These figures are based on an average flow of 6,000 gallons per month for a two-bedroom residence with an additional 2,000 gallons per month added for each additional bedroom. The size of the system should be increased if the actual or anticipated water usage exceeds this average.

Figure 14. Individual Spray Irrigation Fields Designed Using a Soil Profile Description–Net Evaporation Zone 2 [See Figure 25 in this Appendix (relating to net evaporation zones)]

Minimum Spray Irrigation Area in Square Feet

SOIL GROUP	NUMBER OF BEDROOMS IN RESIDENCE [†]			
	Two or Fewer	Three	Four	Each Additional Bedroom
1	4,161	5,548	6,935	1,387
2	4,577	6,103	7,629	1,526
2a	4,993	6,658	8,322	1,665
3	5,409	7,212	9,016	1,803
3a	5,825	7,767	9,709	1,942
4	6,242	8,322	10,403	2,080
5	8,322	11,096	13,870	2,774

[†] These figures are based on an average flow of 6,000 gallons per month for a two-bedroom residence with an additional 2,000 gallons per month added for each additional bedroom. The size of the system should be increased if the actual or anticipated water usage exceeds this average.

Figure 15. Individual Spray Irrigation Fields Designed Using a Soil Profile Description–Net Evaporation Zone 3 [See Figure 25 in this Appendix (relating to net evaporation zones)]

Minimum Spray Irrigation Area in Square Feet

SOIL GROUP	NUMBER OF BEDROOMS IN RESIDENCE [†]			
	Two or Fewer	Three	Four	Each Additional Bedroom
1	2,913	3,884	4,855	971
2	3,204	4,272	5,340	1,068
2a	3,495	4,660	5,825	1,165
3	3,786	5,049	6,311	1,263
3a	4,078	5,437	6,796	1,359
4	4,369	5,825	7,282	1,456
5	5,825	7,767	9,709	1,942

[†] These figures are based on an average flow of 6,000 gallons per month for a two-bedroom residence with an additional 2,000 gallons per month added for each additional bedroom. The size of the system should be increased if the actual or anticipated water usage exceeds this average.

Figure 16. Individual Spray Irrigation Fields Designed Using a Soil Profile Description–Net Evaporation Zone 4 [See Figure 25 in this Appendix (relating to net evaporation zones)]

Minimum Spray Irrigation Area in Square Feet

SOIL GROUP	NUMBER OF BEDROOMS IN RESIDENCE [†]			
	Two or Fewer	Three	Four	Each Additional Bedroom
1	2,330	3,107	3,884	777
2	2,563	3,418	4,272	855
2a	2,796	3,728	4,660	932
3	3,029	4,039	5,049	1,010
3a	3,262	4,350	5,437	1,088
4	3,495	4,661	5,825	1,166
5	4,660	6,214	7,767	1,554

[†] These figures are based on an average flow of 6,000 gallons per month for a two-bedroom residence with an additional 2,000 gallons per month added for each additional bedroom. The size of the system should be increased if the actual or anticipated water usage exceeds this average.

Figure 17. Individual Spray Irrigation Fields Designed Using a Soil Profile Description–Net Evaporation Zone 5 [See Figure 25 in this Appendix (relating to net evaporation zones)]

Minimum Spray Irrigation Area in Square Feet

SOIL GROUP	NUMBER OF BEDROOMS IN RESIDENCE [†]			
	Two or Fewer	Three	Four	Each Additional Bedroom
1	1,821	2,428	3,034	607
2	2,003	2,670	3,337	667
2a	2,185	2,913	3,641	728
3	2,367	3,156	3,944	789
3a	2,549	3,399	4,248	850
4	2,731	3,641	4,551	910
5	3,641	4,855	6,068	1,214

[†] These figures are based on an average flow of 6,000 gallons per month for a two-bedroom residence with an additional 2,000 gallons per month added for each additional bedroom. The size of the system should be increased if the actual or anticipated water usage exceeds this average.

Figure 18. Individual Spray Irrigation Fields Designed Using a Soil Profile Description–Net Evaporation Zone 6 [See Figure 25 in this Appendix (relating to net evaporation zones)]

Minimum Spray Irrigation Area in Square Feet

SOIL GROUP	NUMBER OF BEDROOMS IN RESIDENCE [†]			
	Two or Fewer	Three	Four	Each Additional Bedroom
1	1,533	2,044	2,555	511
2	1,686	2,248	2,811	562
2a	1,840	2,453	3,066	613
3	1,993	2,657	3,322	664
3a	2,146	2,862	3,577	716
4	2,300	3,066	3,833	766
5	3,066	4,088	5,110	1,022

[†] These figures are based on an average flow of 6,000 gallons per month for a two-bedroom residence with an additional 2,000 gallons per month added for each additional bedroom. The size of the system should be increased if the actual or anticipated water usage exceeds this average.

Figure 19. Individual Spray Irrigation Fields Designed Using a Soil Profile Description–Net Evaporation Zone 7 [See Figure 25 in this Appendix (relating to net evaporation zones)]

Minimum Spray Irrigation Area in Square Feet

SOIL GROUP	NUMBER OF BEDROOMS IN RESIDENCE [†]			
	Two or Fewer	Three	Four	Each Additional Bedroom
1	1,324	1,766	2,207	442
2	1,456	1,942	2,427	486
2a	1,589	2,119	2,648	530
3	1,721	2,295	2,868	574
3a	1,854	2,472	3,089	618
4	1,986	2,648	3,310	662
5	2,648	3,531	4,413	883

[†] These figures are based on an average flow of 6,000 gallons per month for a two-bedroom residence with an additional 2,000 gallons per month added for each additional bedroom. The size of the system should be increased if the actual or anticipated water usage exceeds this average.

Figure 20. Individual Spray Irrigation Fields Designed Using a Soil Profile Description–Net Evaporation Zone 8 [See Figure 25 in this Appendix (relating to net evaporation zones)]

Minimum Spray Irrigation Area in Square Feet

SOIL GROUP	NUMBER OF BEDROOMS IN RESIDENCE [†]			
	Two or Fewer	Three	Four	Each Additional Bedroom
1	1,165	1,554	1,942	389
2	1,282	1,709	2,136	427
2a	1,398	1,864	2,330	466
3	1,515	2,020	2,525	505
3a	1,631	2,175	2,719	544
4	1,748	2,330	2,913	582
5	2,330	3,107	3,884	777

[†] These figures are based on an average flow of 6,000 gallons per month for a two-bedroom residence with an additional 2,000 gallons per month added for each additional bedroom. The size of the system should be increased if the actual or anticipated water usage exceeds this average.

Figure 21. Individual Spray Irrigation Fields Designed Using a Soil Profile Description–Net Evaporation Zone 9 [See Figure 25 in this Appendix (relating to net evaporation zones)]

Minimum Spray Irrigation Area in Square Feet

SOIL GROUP	NUMBER OF BEDROOMS IN RESIDENCE [†]			
	Two or Fewer	Three	Four	Each Additional Bedroom
1	1,041	1,387	1,734	346
2	1,145	1,526	1,907	381
2a	1,249	1,664	2,081	415
3	1,353	1,803	2,254	450
3a	1,457	1,942	2,428	485
4	1,561	2,081	2,601	520
5	2,081	2,774	3,468	693

[†] These figures are based on an average flow of 6,000 gallons per month for a two-bedroom residence with an additional 2,000 gallons per month added for each additional bedroom. The size of the system should be increased if the actual or anticipated water usage exceeds this average.

Figure 22. Individual Spray Irrigation Fields Designed Using a Soil Profile Description–Net Evaporation Zone 10 [See Figure 25 in this Appendix (relating to net evaporation zones)]

Minimum Spray Irrigation Area in Square Feet

SOIL GROUP	NUMBER OF BEDROOMS IN RESIDENCE [†]			
	Two or Fewer	Three	Four	Each Additional Bedroom
1	940	1,253	1,566	313
2	1,033	1,378	1,723	345
2a	1,127	1,504	1,879	377
3	1,221	1,629	2,036	408
3a	1,315	1,754	2,192	439
4	1,409	1,880	2,349	471
5	1,879	2,506	3,132	627

[†] These figures are based on an average flow of 6,000 gallons per month for a two-bedroom residence with an additional 2,000 gallons per month added for each additional bedroom. The size of the system should be increased if the actual or anticipated water usage exceeds this average.

Figure 23. Individual Lagoons

Length in Feet of Each Side of the Bottom of a Square Individual Lagoon

ZONE [See Figure 25 in this Appendix (relating to net evaporation zones)]	NUMBER OF BEDROOMS IN RESIDENCE [†]			
	Two or Fewer	Three	Four	Five
1	Contact your local DEQ office for assistance with sizing lagoons in Zones 1 and 2			
2				
3	40	50	60	65
4	35	45	55	60
5	30	40	50	55
6	25	35	45	50
7	20	30	35	45
8	20	25	30	35
9	15	20	25	30
10	10	15	20	25

Diameter in Feet of the Bottom of a Round Individual Lagoon

ZONE [See Figure 25 in this Appendix (relating to net evaporation zones)]	NUMBER OF BEDROOMS IN RESIDENCE [†]			
	Two or Fewer	Three	Four	Five
1	Contact your local DEQ office for assistance with sizing lagoons in Zones 1 and 2			
2				
3	50	60	70	80
4	45	55	65	75
5	40	50	60	70
6	35	45	50	60
7	30	40	45	55
8	25	30	40	45
9	20	30	35	40
10	15	25	30	35

[†] These figures are based on an average flow of 6,000 gallons per month for a two-bedroom residence with an additional 2,000 gallons per month added for each additional bedroom. The size of the system should be increased if the actual or anticipated water usage exceeds this average.

Figure 24. Small Public Lagoons

Length in Feet of Each Side of the Bottom of a Square Small Public Lagoon

AVERAGE DAILY FLOW In Gallons	ZONE [See Figure 25 of this Appendix (relating to net evaporation zones)]									
	1	2	3	4	5	6	7	8	9	10
100	Contact your local DEQ office for assistance with sizing lagoons in Zones 1 and 2		18	16	14	10	Prohibited			
200			38	35	32	27	22	17	14	11
300			54	49	46	40	34	28	24	20
400			67	61	58	51	44	37	32	27
500			78	72	69	60	52	45	39	34
600			88	82	78	69	60	52	46	40
700			98	91	87	77	68	59	52	46
800			107	99	95	84	74	65	58	51
900			115	107	102	91	81	71	63	56
1,000			123	114	110	97	87	76	68	61
1,100			130	122	116	104	92	81	73	65
1,200			138	128	123	110	98	86	77	69
1,300			144	135	129	115	103	91	82	73
1,400			151	141	135	121	108	95	86	77
1,500			157	147	141	126	113	100	90	81
1,600			163	153	147	131	117	104	94	85
1,700			169	158	152	136	122	108	98	88
1,800			175	164	157	141	126	112	101	92
1,900			181	169	162	146	131	116	105	95
2,000			186	174	167	150	135	120	108	98
2,500	212	198	190	171	154	137	125	114		
3,000	235	220	212	191	172	154	140	127		
3,500	256	240	231	209	188	168	153	140		
4,000	276	259	249	225	203	182	166	151		
4,500	295	276	266	240	218	195	178	163		
5,000	312	293	282	255	231	207	189	173		

Diameter in Feet of the Bottom of a Round Small Public Lagoon

AVERAGE DAILY FLOW In Gallons	ZONE [See Figure 25 of this Appendix (relating to net evaporation zones)]									
	1	2	3	4	5	6	7	8	9	10
100	Contact your local DEQ office for assistance with sizing lagoons in Zones 1 and 2		25	22	20	15	Prohibited			
200			47	43	40	34	29	23	20	16
300			65	59	56	49	42	35	31	26
400			79	73	70	61	53	45	40	35
500			92	85	81	72	63	54	49	43
600			104	96	92	81	72	62	56	50
700			114	106	102	90	80	69	63	56
800			124	116	111	99	88	76	70	62
900			134	125	119	106	95	82	76	68
1,000			143	133	128	114	102	89	81	73
1,100			151	141	135	121	108	94	87	78
1,200			159	149	143	128	114	100	92	83
1,300			167	156	150	134	120	105	97	88
1,400			174	163	156	140	126	110	102	92
1,500			181	170	163	146	131	115	106	96
1,600			188	176	169	152	136	120	111	100
1,700			195	183	175	158	142	125	115	104
1,800			202	189	181	163	147	129	119	108
1,900			208	195	187	168	151	133	124	112
2,000			214	201	193	173	156	138	128	116
2,500	243	228	219	197	178	157	146	133		
3,000	269	252	243	219	198	175	163	149		
3,500	293	275	265	239	216	192	178	163		
4,000	315	296	285	258	233	207	193	176		
4,500	336	316	304	275	249	221	206	189		
5,000	356	335	322	292	264	235	219	201		

Figure 25. Net Evaporation Zones

COUNTY	ZONE	COUNTY	ZONE	COUNTY	ZONE
Adair	1	Grant	9	Nowata	5
Alfalfa	9	Greer	9	Okfuskee	7
Atoka	6	Harmon	9	Oklahoma	8
Beaver	10	Harper	9	Okmulgee	6
Beckham	9	Haskell	3	Osage	7
Blaine	9	Hughes	6	Ottawa	2
Bryan	6	Jackson	9	Pawnee	7
Caddo	9	Jefferson	9	Payne	7
Canadian	9	Johnston	7	Pittsburg	5
Carter	7	Kay	8	Pontotoc	7
Cherokee	3	Kingfisher	9	Pottawatomie	7
Choctaw	2	Kiowa	9	Pushmataha	2
Cimarron	10	Latimer	2	Roger Mills	9
Cleveland	8	LeFlore	1	Rogers	5
Coal	6	Lincoln	7	Seminole	7
Comanche	9	Logan	8	Sequoyah	1
Cotton	9	Love	7	Stephens	8
Craig	4	McClain	8	Texas	10
Creek	7	McCurtain	1	Tillman	9
Custer	9	McIntosh	5	Tulsa	6
Delaware	2	Major	9	Wagoner	5
Dewey	9	Marshall	7	Washington	6
Ellis	9	Mayer	5	Washita	9
Garfield	9	Murray	7	Woods	9
Garvin	8	Muskogee	5	Woodward	9
Grady	9	Noble	8		

APPENDIX I. EXAMPLE OF THE REQUIREMENTS FOR A SEPTIC TANK

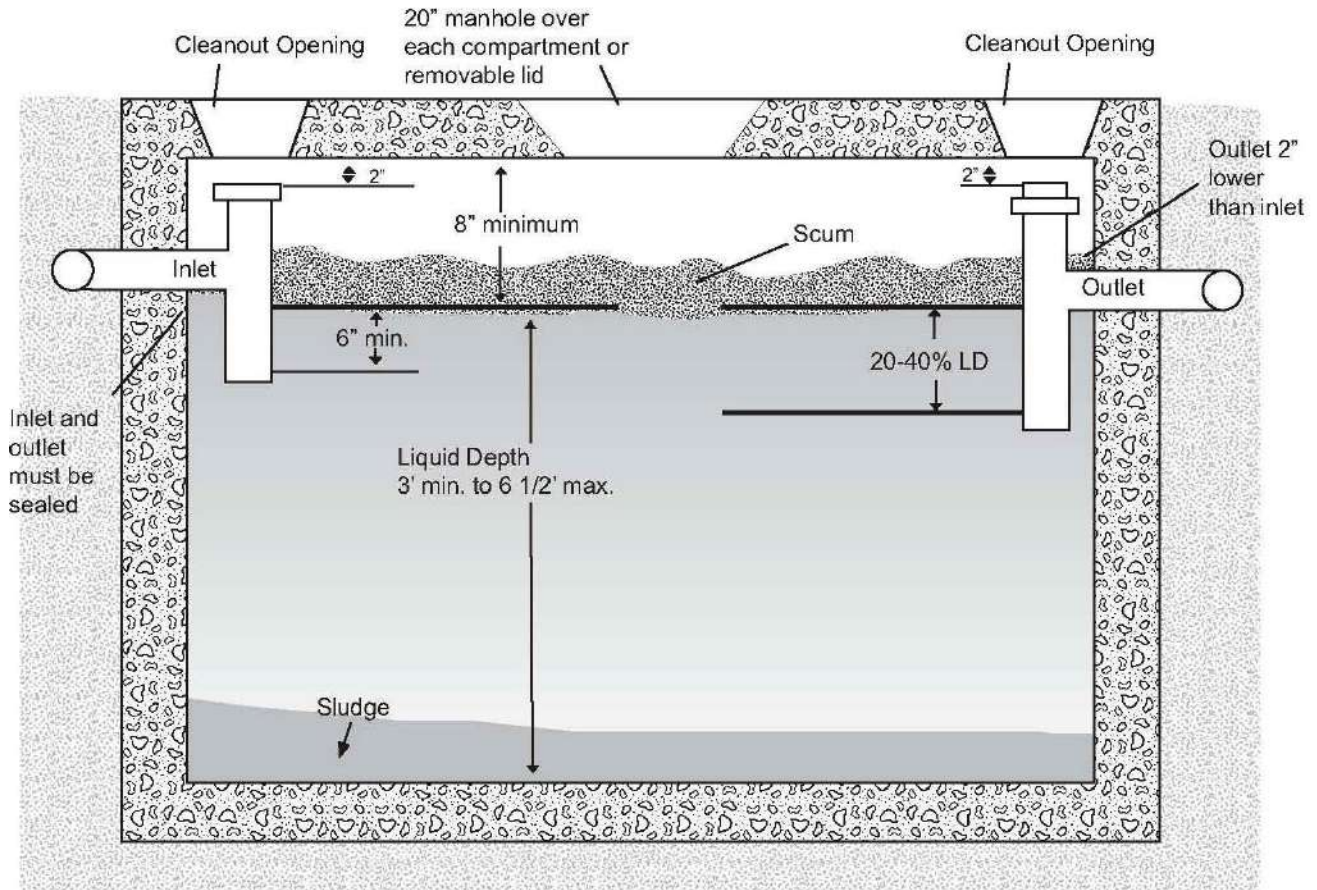

APPENDIX J. EXAMPLE OF THE REQUIREMENTS FOR A PUMP TANK

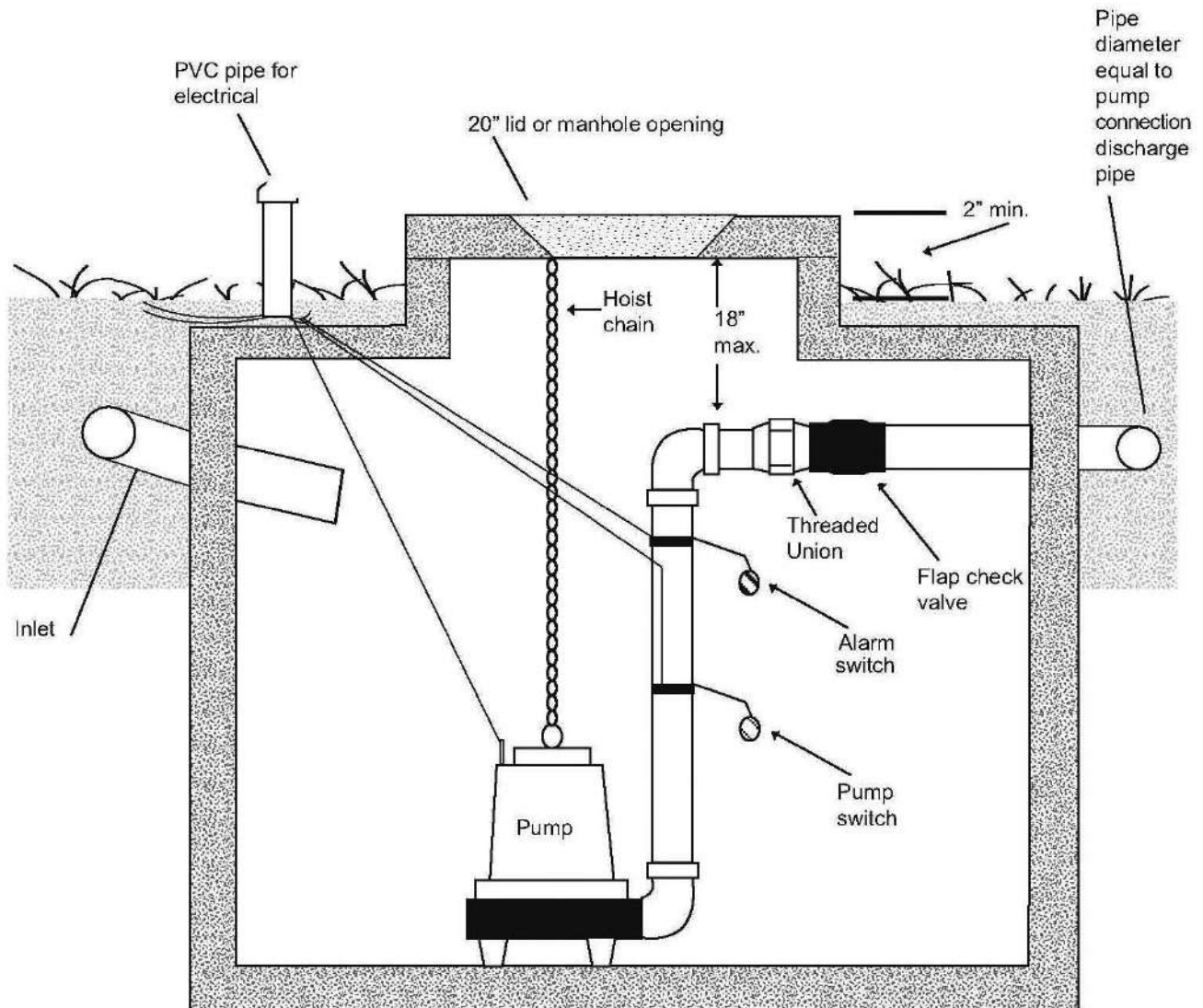

APPENDIX K. EXAMPLE LAYOUTS OF CONVENTIONAL SUBSURFACE ABSORPTION SYSTEMS, LOW PRESSURE DOSING SYSTEMS AND ET/A SYSTEMS

Figure 1. Level Systems (Top View)

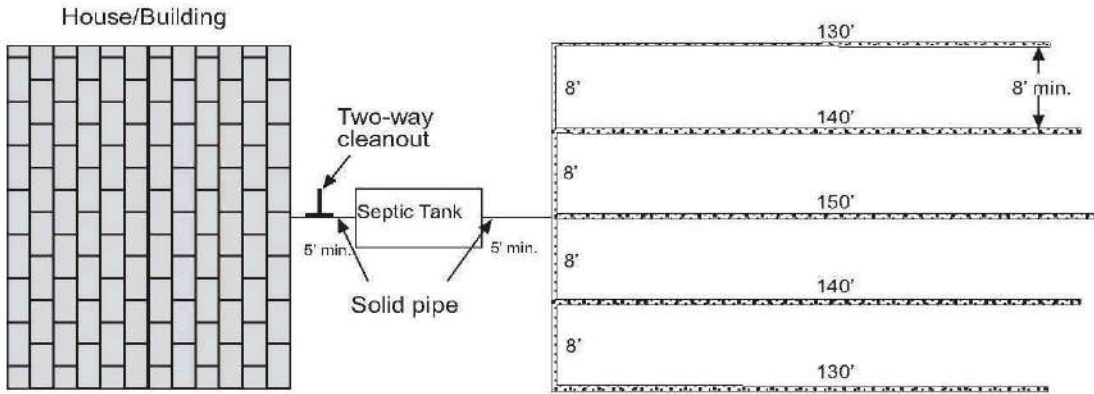

Figure 2. Level Systems (Side View)

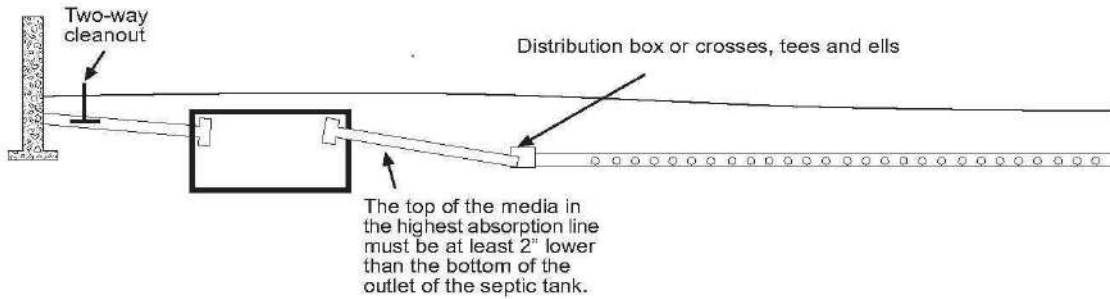

Figure 3. Low Pressure Dosing

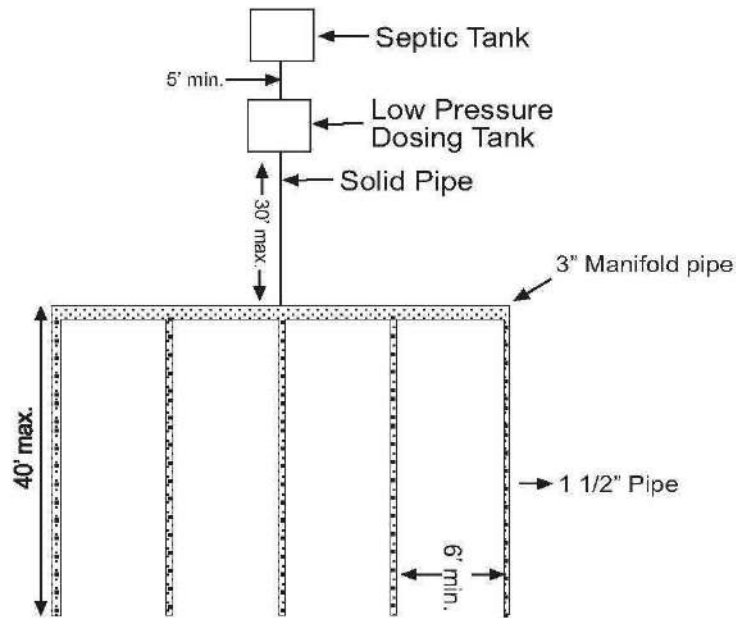

Figure 4. Retention Systems (Top View)

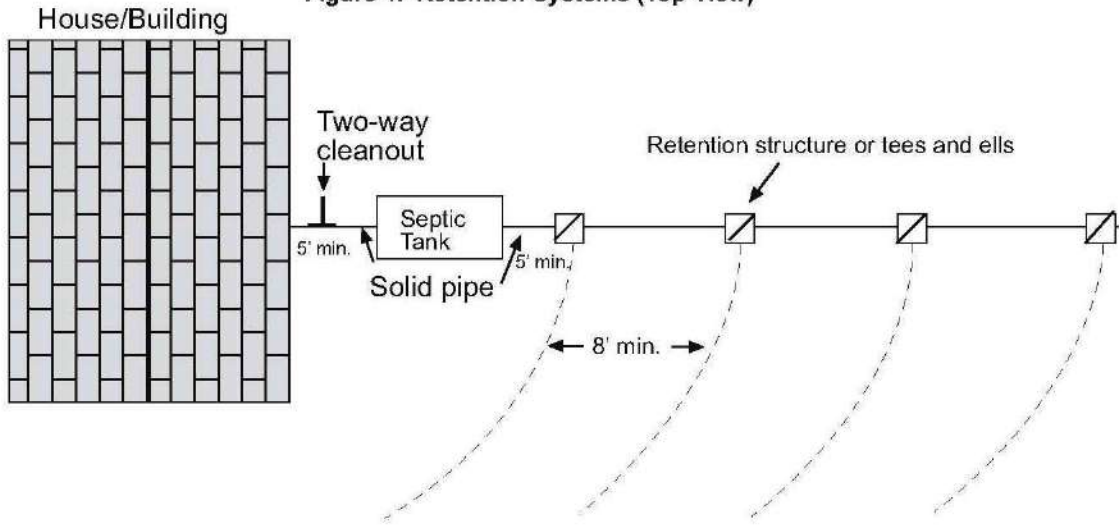
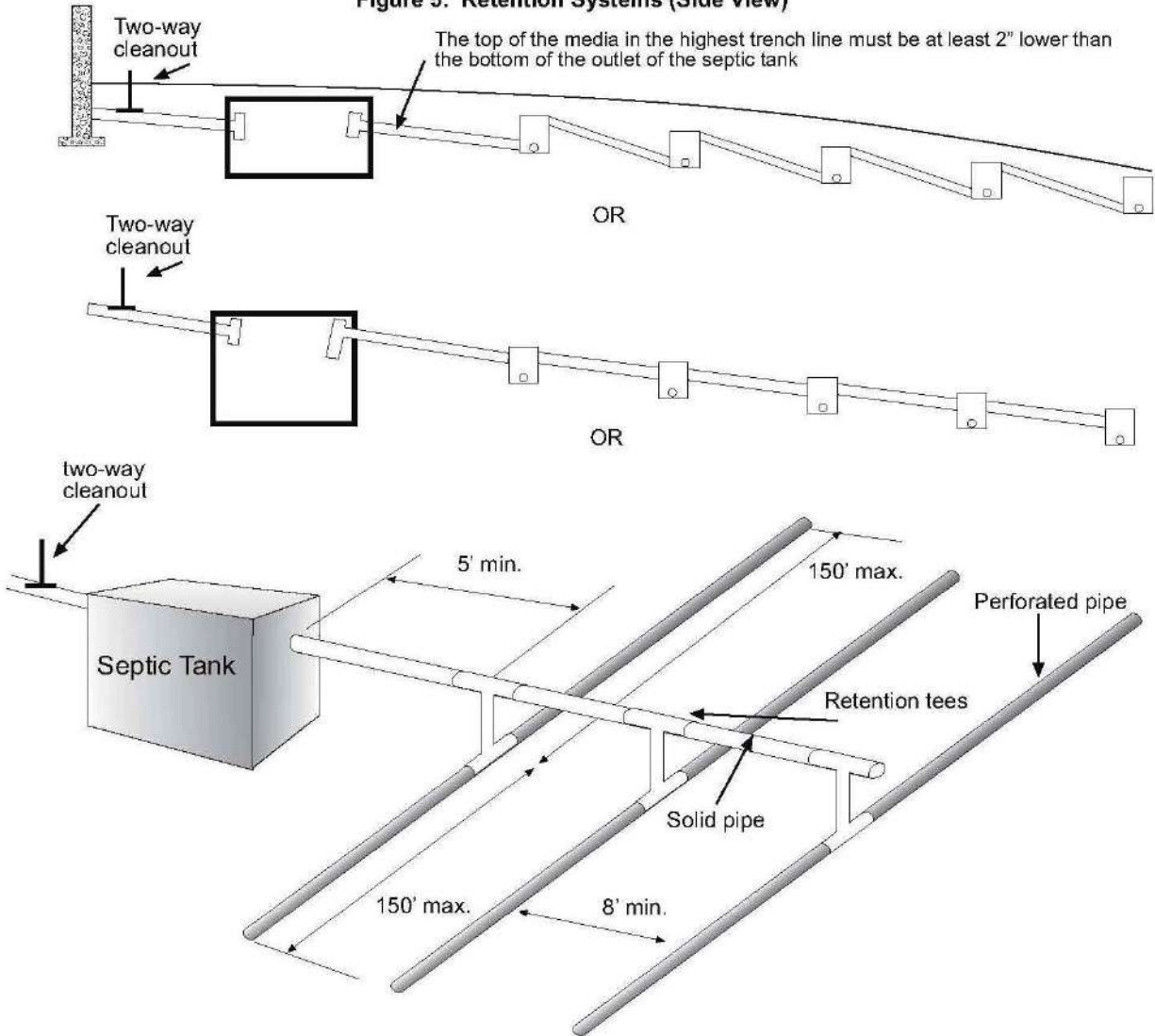

Figure 5. Retention Systems (Side View)



APPENDIX L. EXAMPLES OF RETENTION AND DISTRIBUTION STRUCTURES

Figure 1. Retention Structure (Box)

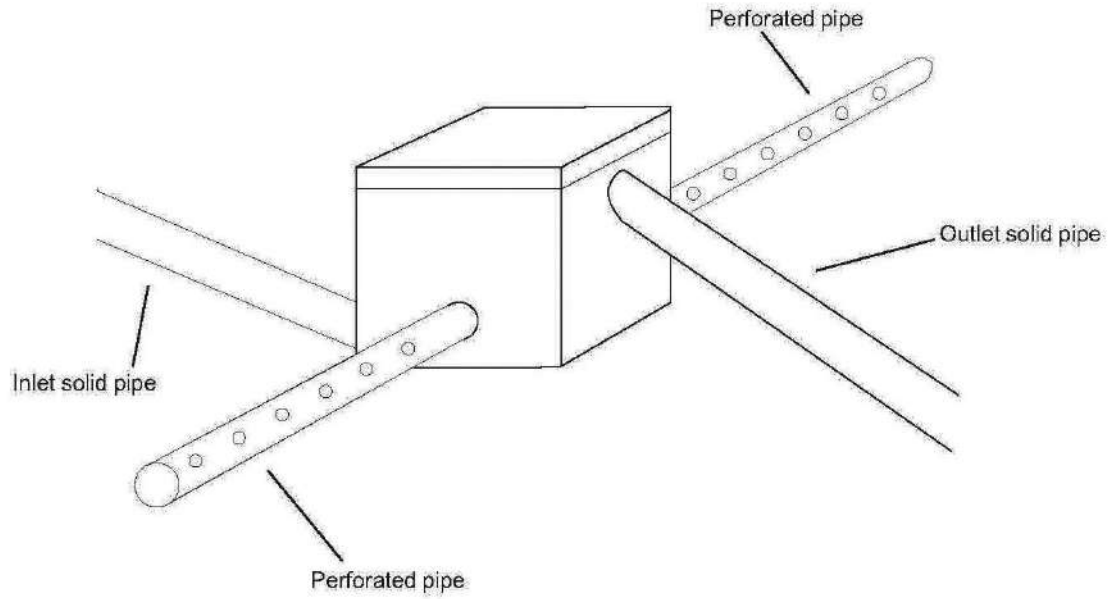
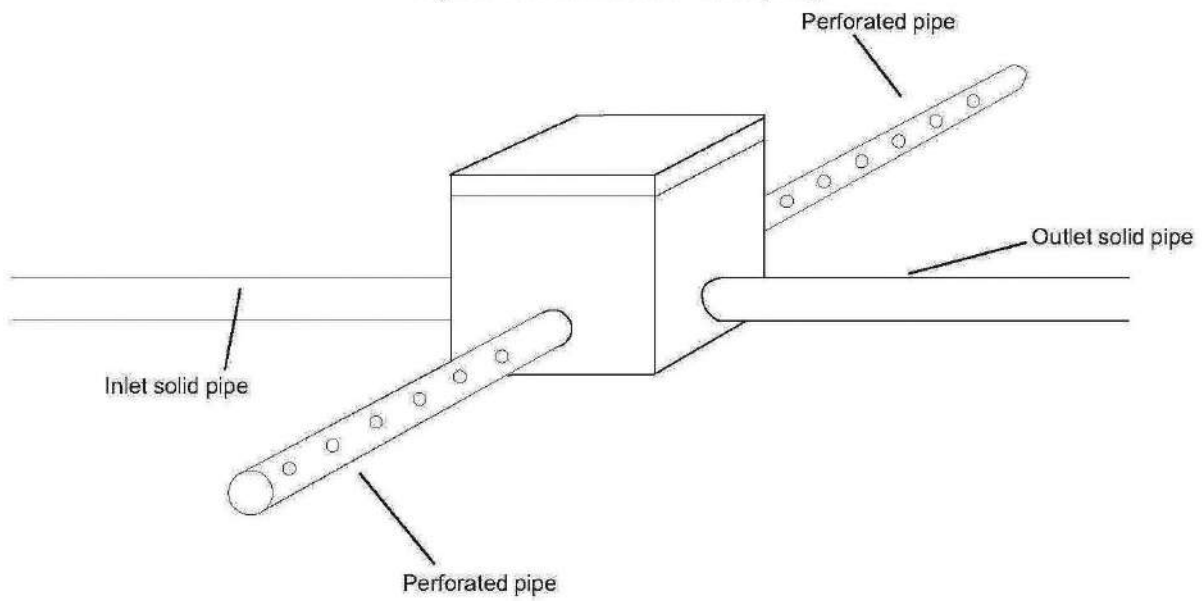

Figure 2. Distribution Structure (Box)



APPENDIX M. EXAMPLES OF TRENCH INSTALLATION

Figure 1. Cross-Section of Conventional Subsurface Absorption Trench

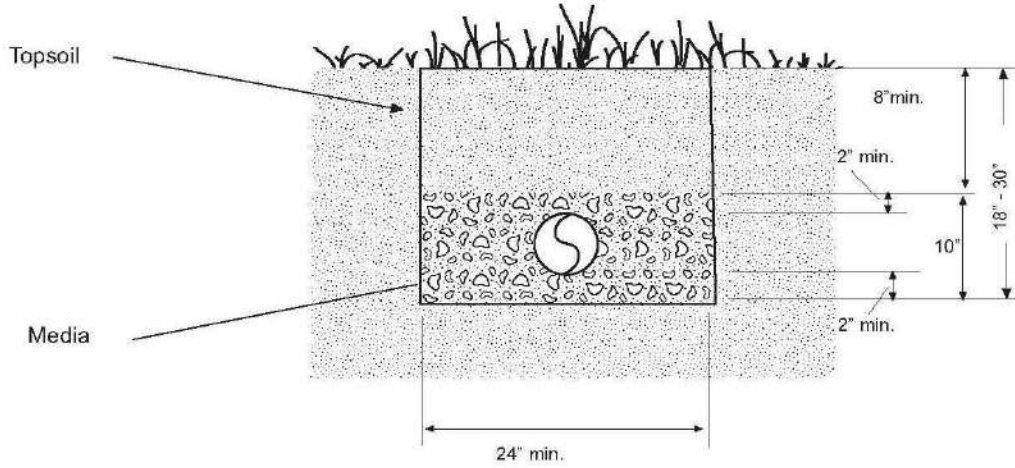

Figure 2. Cross-Section of ET/A Trench

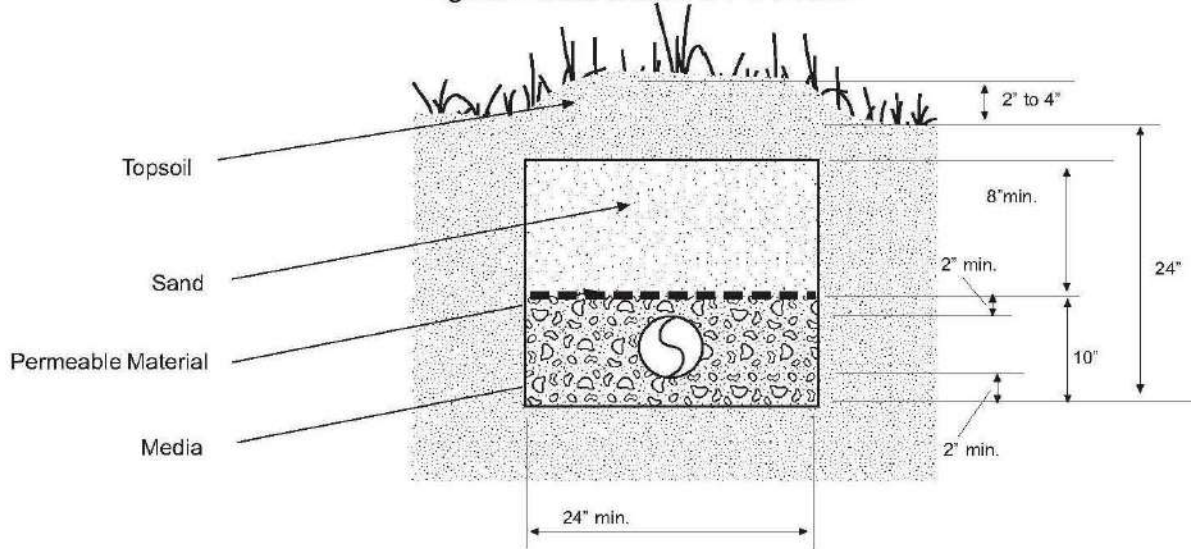
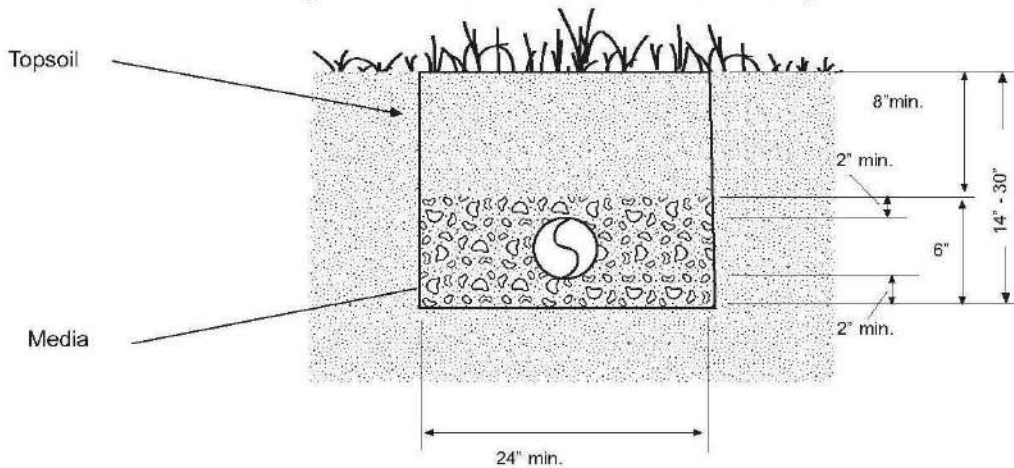
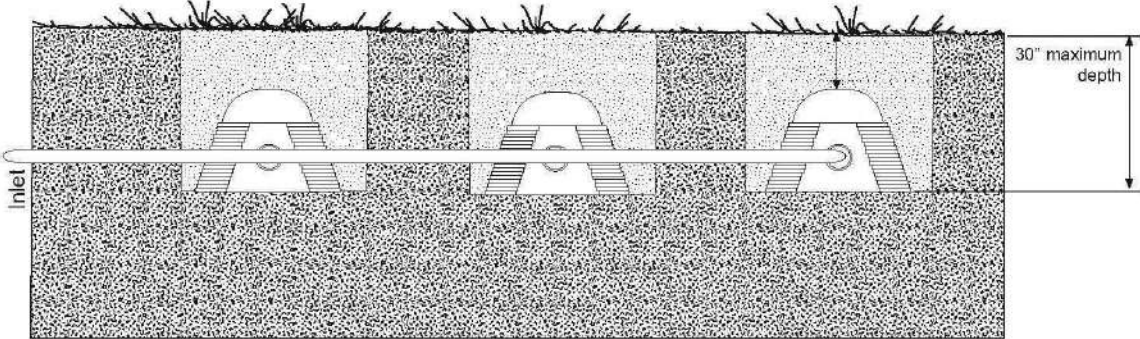

Figure 3. Cross-Section of Low Pressure Dosing



APPENDIX N. EXAMPLES OF CHAMBERS BEING USED FOR STORAGE AND DISPERSAL

Figure 1. Level Systems



The top of the louver in the highest trench line must be at least 2" lower than the bottom of the outlet of the septic tank.

Figure 2. Retention Systems

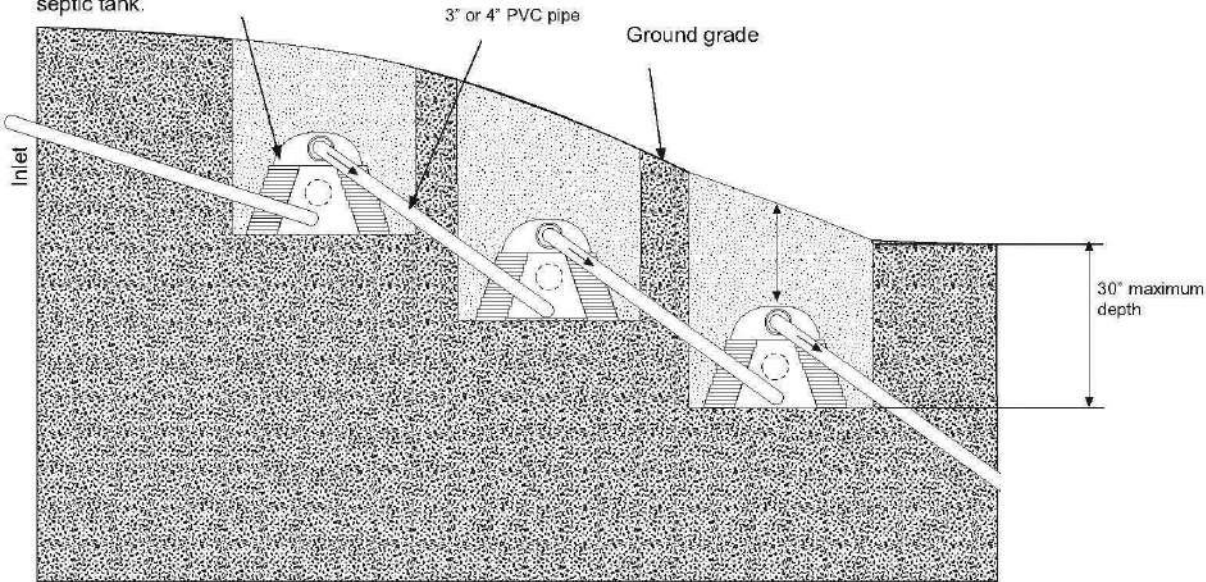

APPENDIX O. EXAMPLES OF LAGOON INSTALLATION

Figure 1. Lagoon (side view)

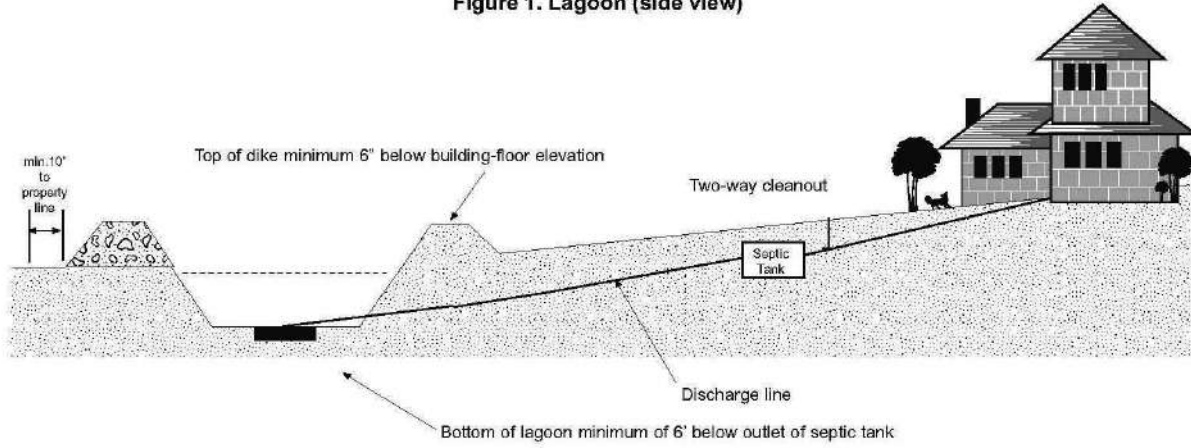
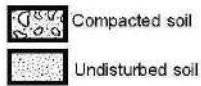
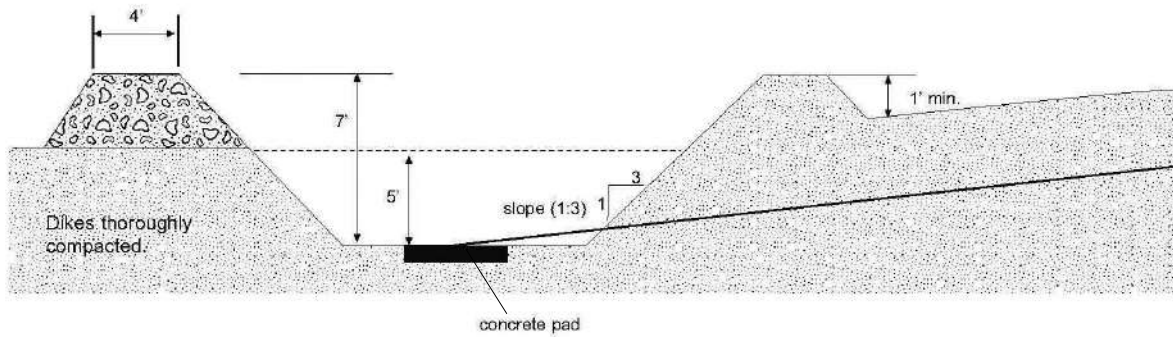

Figure 2. Lagoon Detail



The DEQ encourages seeding, sodding or sprigging dikes with perennial, low-growing grasses to prevent erosion.

Figure 3. Lagoons Constructed On Steep Slopes

Note: Drawings not to scale; slopes are to be 3 horizontal to 1 vertical.

Recommended: Maximum water level at or below original ground elevation.

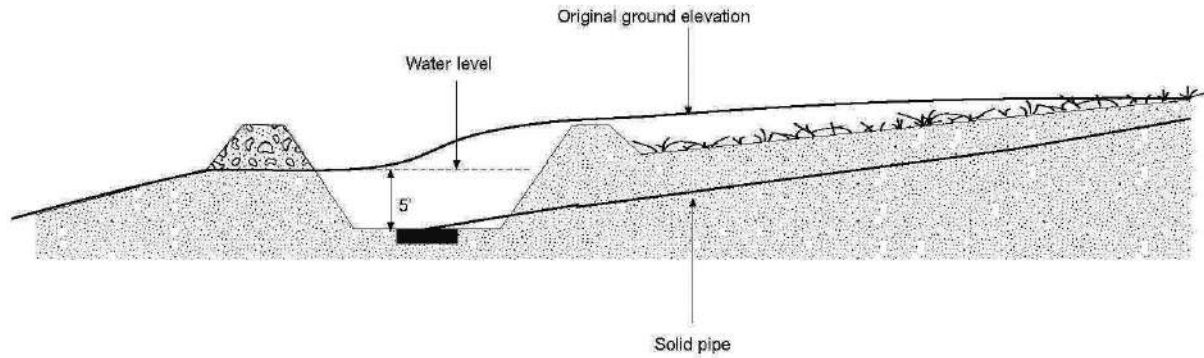

Not recommended: Maximum water level above original ground elevation.

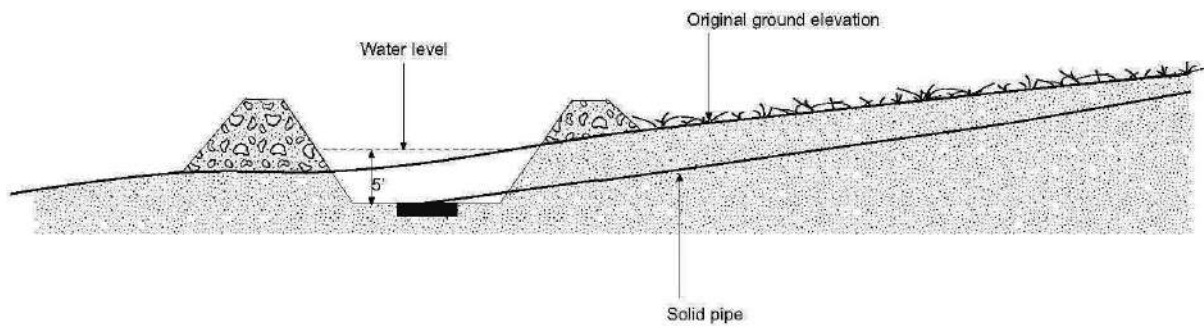

-  Compacted soil
-  Undisturbed soil

The DEQ encourages seeding, sodding or sprigging dikes with perennial, low-growing grasses to prevent erosion.