

## WARRANTY

- Visit [wavespas.com](http://wavespas.com)  
to register your free  
Warranty package.



wave™

CALIFORNIA



## INSTALLATION AND USER MANUAL

READ CAREFULLY AND  
KEEP IT FOR LATER REFERENCE

[www.wavespas.com](http://www.wavespas.com)

# IMPORTANT - PLEASE READ

## 1. Watch our WAVE videos

We know you can't wait to jump into your new Wave hot tub and get started, however before you do that, please check out our set-up videos for an easy step by step guide as to how to get started with your tub safely.

## 2. Read the manual

Next up, please read the manual! This will save you a lot of time and hassle by explaining the process every step of the way. There is a lot of crucial information in here that will help avoid damage to your spa when setting up and taking down.

## 3. Choose your site

Get your location right! First off make sure you are setting up your tub in an area where you have enough space surrounding the spa for you to comfortably perform your daily maintenance tasks. Secondly, ensure there is a power outlet nearby as extension cables should NOT be used. Thirdly, choose a site where you can drain the water easily! The site should be flat and completely free from sharp objects. The site where you choose to set up should also be strong enough to take the weight of your spa when it is fully filled and in use. The water capacity for 2-4-person spa is 800L and 4-6 person is 1000L.

The location in which you assemble and fill your spa must be the location you intend to use it, once the spa is full it is strongly advised against that you attempt to move it to another location. Doing so could cause injury to yourself or damage to your tub, which may result in voided warranty.

## 4. Open the box

Once you have opened the box that contains your new spa you should remove its contents and spread the protective ground sheet on the site where your tub will be assembled. You should then assemble the heater unit and the rest of the tub. Once you are done with the packaging and box you should remove all debris and packaging parts from the tub area to ensure nothing falls in and damages the liner.

## 5. Inflate the spa

Next step will be to inflate your spa! Connect the motor and heater system and once switched on, the spa can be inflated and ready to fill with water in about 5 minutes. You must NOT over inflate your spa.

## 6. Clean your spa

After inflating your spa, use a wet sponge or soft cloth to gently wipe the internal surface of your spa liner. Even though your spa is brand new, this is to ensure that any debris or dust that could contaminate the water is fully removed.

## 7. Filter and filter housing

After gently cleaning the internal liner of your new spa you should ensure that the filter and filter housing are fitted in the correct location (the lower port). Also ensure that the cap is not fitted on the upper port before filling with water.

## 8. Fill your spa with water

Now you can fill your spa with water! When filling your spa, try to avoid using an old hose as these carry a lot of old bacteria that could contaminate the water. If you are filling your tub using cold water, you should carry on filling until you are mid-way between the min and max filling lines. If you have the ability to fill your spa with hot/warm water this will mean your spa will heat up quicker and be more energy efficient. If you are planning to fill your spa with hot water, please begin using cold water and once you the water has risen above the filter, hot water can then be used.

## 9. Heat your spa water

Now to heat your spa! To do this you should press the heater button on the left side of your external unit (the sun symbol). A light will then be displayed and remain lit until the water has reached your selected temperature (38°C is the default temperature). Once the desired temperature is reached, the light will flash. Once the LCD display has flashed you will be able to adjust the water temperature using the up and down arrows to increase or decrease the temperature. It is possible for the water to be approximately 1-3°C different to the temperature selected.

The water in your spa heats up approximately 1°C per hour whilst the heater unit is switched on. The indicator on the screen corresponds to the current water temperature. For health and safety reasons the maximum temperature setting on the heater unit is 40°C. You should make sure you have turned on the filtration system before you start heating the water. Put your hot tub cover on to help the water heat up faster and retain heat for longer.

## 10. Chemical shock

Before you jump into your spa, you should first perform your spa chemical shock. When you set up your hot tub for the first time its always important to add your start up chemicals. You need to perform a hot tub shock to keep the water healthy and prevent foaming or cloudiness. Treating your water prolongs its life such that you will not need to keep draining and cleaning your hot tub after each use. Our Wave starter kit contains everything you need to get your spa up and running!

## 11. Guide on chemical shock

To chemical shock you should use either warm or cold water and when the water is higher than 25°C mix your chlorine (granules are better for shocking) in a jug with warm water. Put 5 teaspoons of granules into the jug of warm water and add this to the spa after mixing well. Activating the bubble settings whilst doing this will help to disperse the chlorine around the water quicker. After you have chlorinated your spa water, please leave the spa to sit for 24 hours before use. Remember to use your test strips before jumping into the spa as some levels may still need adjusting before use. Make sure alkalinity levels are right after checking the chlorine. pH can be altered as and when required.

## 12. Maintenance

Regular maintenance of your tub is essential, especially keeping the correct pH levels! The most ideal pH level is between 7.2 to 7.6 and the level should be tested two times a week whilst the tub is filled, and always before use. A heaped teaspoon holds approximately 8g of granules and adding a teaspoon of chlorine everyday will keep your spa water clean and healthy.

## 13. FINISH

Now all that is left is for you to enjoy your new spa! For any further questions please check the FAQ's on our website or contact a dedicated member of our customer service department using the live chat on our website [www.wavespas.com](http://www.wavespas.com).

# WARNING

## READ ALL INSTRUCTIONS AND SAFETY WARNINGS IN THIS MANUAL

Failure to follow the warnings and instructions in this manual may result in serious injury, drowning or electric shock.

The safety of children is left in the hands of the customer.  
Children aged 5 and below are at the most risk.

Always comply with the following instructions:

- Children should be under close and constant supervision
- Always designate a responsible person to manage pool and pool area
- For all users and children, wet the nape of the neck, chest and legs before entering the water
- Learn safety especially when specific to guidelines
- Prohibit diving and jumping
- Prohibit running, splashing games around the pool
- Ensure no unattended children, who cannot swim, use the pool without a life jacket
- Always keep the water treatment products out of reach of all children

If incident occurs remove the injured person or child from the pool and pool area  
Contact emergency services for advice and guidance on how to treat injured person or child

The hot tub's electrical connections must be installed in the electrical safety zones labelled 1, 2 or outside all safety zones. The measured zones are limited by walls and fixed partitions.

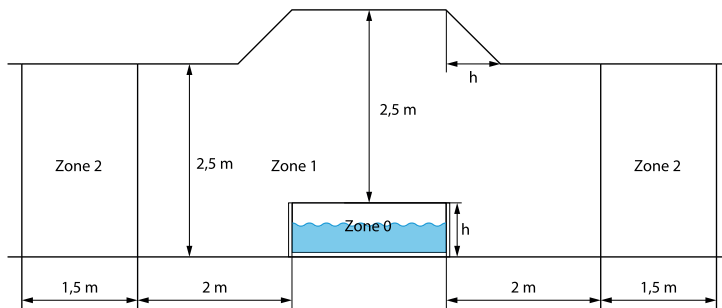

# IMPORTANT SAFETY INSTRUCTIONS

For your own safety and that of your product, Ensure you follow the safety precautions outlined below. Failure to follow the instruction may result in serious injury, property damage or death. Improper installation or operation will void the warranty.

Read, understand and follow all instructions:

## DANGER

### ● Risk of accidental drowning:

- Extreme caution must be exercised to prevent unauthorized access by children.
- Inspect the spa cover regularly for leak, premature wear and tear, damage or signs of deterioration. Never use a worn or damaged cover: it will not provide the level of protection required to prevent unsupervised access to the spa by a child.
- Always lock the spa cover after each use.

### ● Risk of injury:

If the supply cord is damaged, it must be replaced by the manufacturer, its service agent or similarly qualified persons in order to avoid a hazard.

### ● Risk of Electric Shock:

- Do not permit any electrical appliances, such as a light, telephone, radio or television within 1.5m (5 feet) of a spa tub.
- Do not use the spa when it is raining, thundering or lightning..

## WARNING

- To reduce the risk of electric shock, do not use an extension cord, timers, plug adapters or converter plugs to connect the unit to electric supply; provide a properly located outlet.
- The spa electrical appliance should be supplied through a residual current device (RCD) having a rated residual operating current not exceeding 10mA.
- Parts containing live parts, except parts supplied with safety extra-low voltage not exceeding 12V, must be inaccessible to occupants in the spa.
- Parts incorporating electrical components, except remote control devices, must be located or fixed so that they cannot fall into the spa.
- Residential electrical connection box must be located safely with a distance of at least 2m away from the spa.
- Electric installation should fulfill the local requirement or standards.
- This appliance can be used by children aged from 8 years and above and persons with reduced physical, sensory or mental capabilities or lack of experience and knowledge if they have been given supervision or instruction concerning use of the appliance in a safe way and understand the hazards involved. Children shall not play with the appliance. Cleaning and user maintenance shall not be made by children without supervision.
- To reduce the risk of injury, Children are not permitted to use this product unless they are closely supervised at all times.
- To reduce the risk of child drowning, supervise children all times. Attach and lock spa cover after each use.
- Make sure the floor is capable of supporting the expected load ( $\geq 500\text{kg/m}^2$ ).
- Adequate draining system must be provided around the spa to deal with overflow water.
- To avoid damage do not leave the appliance empty for an extended period.
- To avoid damage to the pump, the spa must never be operated unless the spa is filled with water.
- Immediately leave spa if uncomfortable or sleepy.
- To reduce the risk of injury :
  - Lower water temperatures are recommended for young children and when spa use exceeds 10 minutes.

# 1. SPECIFICATIONS

In order to avoid the possibility of hyperthermia (heat stress) occurring it is recommended that the average temperature of spa-pool water should not exceed 40°C (104°F).

- Since excessive water temperatures have a high potential for causing fetal damage during the early months of pregnancy, pregnant or possibly pregnant women should limit spa water temperatures to 38°C (100°F).
- Before entering a spa or hot tub the user should measure the water temperature with an accurate thermometer since the tolerance of water temperature regulating devices varies.
- The use of alcohol, drugs or medication before or during spa use may lead to unconsciousness with the possibility of drowning.
- The use of alcohol, drugs, or medication can greatly increase the risk of fatal hyperthermia in spas.

The causes and symptoms of hyperthermia may be described as follows:

Hyperthermia occurs when the internal temperature of body reaches a level several degrees above the normal body temperature 37°C (98.6°F). The symptoms of hyperthermia include an increase in the internal temperature of body, dizziness, lethargy, drowsiness, and fainting. The effect of hyperemia include failure to perceive heat; failure to recognize the need to exit spa; unawareness of impending hazard; fetal damage in pregnant women; physical inability to exit the spa; and unconsciousness resulting in the danger of drowning.

- Obese persons or persons with a history of heart disease, low or high blood pressure, circulatory system problem, or diabetes should consult a physician before using a spa.

- Persons using medication should consult a physician before using a spa since some medication may induce drowsiness while other medication may affect heart rate, blood pressure and circulation.

- Check with doctor before use if pregnant, diabetic, in poor health, or under medical care.

- People with infectious disease should not use a spa or hot tub.
- To avoid injury exercise care when entering or existing the spa or hot tub.
- Water temperature in excess of 40°C (104°F) may be harmful to your health.
- Never use a spa or hot tub alone or allow others to use the spa alone.
- Do not use a spa or hot tub immediately following strenuous exercise.
- Do not put the spa under 0°C (32°F) environment in order to avoid freezing if there is still water in the pool.
- Do not turn on the spa when the water is frozen.
- Never pour water with a temperature higher than 40°C(104°F) into the spa directly.
- Always unplug this product from the electrical outlet before removing, cleaning, servicing or making any adjustment to the product.
- Never jump or dive into a spa or any shallow body of water.
- Do not bury the electrical cord. Locate the cord where it will not be damaged by lawn mowers, hedge trimmers and other equipment.
- Do not attempt to plug in or unplug this product while standing in water or when your hands are wet.
- Do not use the spa if damaged in delivery and/or malfunctioning in any way.
- Keep all pets away from the spa to avoid any damage.
- Do not add bath oil or bath salt to the spa water.
- Do not leave an empty pool outside.
- To prevent resetting of the thermal cut out, this appliance must not be supplied through an external switching device, such as a timer, or connected to a circuit that is regularly switched on and off by the utility provider.

## 1.1. Specifications

	<b>4 persons</b>
Model	California
Capacity	4 persons
Dimension (outer)	57" × 27.6" 145 × 70 cm
Dimensions (inner)	53.1 " × 27.6" 135 × 70 cm
Water level Max	40 cm
Water capacity	800 L
Power supply	220-240 V,50 Hz, 2040W
Max heat temperature	40°C
Test certificate	CE
Heating efficiency Ambient temperature : 20°C	1.5 - 2.5°C/h



This appliance is marked according to the European directive 2012/19/EU on Waste Electrical and Electronic Equipment (WEEE). This symbol indicates that this appliance may not be treated as household waste. Instead it shall be handed over to the applicable collection point for the recycling of electrical and electronic equipment. Disposal of the appliance shall be carried out in accordance with the local environment regulations for waste disposal.



The CE mark indicates that the product complies with European directives in relation to 2014/35/CE (low voltage), 2014/30/CE (Compliance with the Electromagnetic Compatibility), 2011/65/UE (restriction of the use of certain hazardous substances in electrical and electronic equipment), 2009/125/CE (Ecodesign directive).

## 2. PACKAGE LIST

### 2.1. Package list

Ensure to check all parts are present:



liner



Pump unit



Top cover



ground sheet



RCD plug



wrench



Inflating hose



Pump unit connectors



Caps



Repair kit



Filter cartridge



Filtration cartridge support



hand pump

## 3. INSTALLATION

**WARNING** : Spa installed on inadequately level surfaces are subject to leaking, forming irregularities or may collapse, which can result in property damage or serious injury for those in or around the spa area!

**CAUTION** : Please choose your set-up area carefully as lawn and other desirable vegetation underneath the ground sheet (if applicable) will die. Furthermore, try to avoid setting the ground sheet in areas prone to aggressive plant and weed species, as they may grow through the ground sheet.

### 3.1. Site selection

**WARNING** : Before proceeding to install your spa, please ensure that the allocated location meets the following conditions :

- A level place in order to avoid any defect, hernia or leakage.
- Wide enough to support the pool and its pump unit.
- Able to support more than 500 kg/m<sup>2</sup>.
- Sheltered from the sun and bad weather.
- Clean and free from sharp objects.
- Devoid of aggressive vegetation on the ground.

Failure to comply with these rules may result in property damage or personal injury.

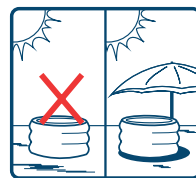

A place with an awning

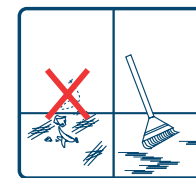

Clean the place



A level place

### 3.2. RCD test

**WARNING: The RCD plug must be tested before each use..  
Do not use if RCD test fails and see chapter 6.1.**



1. Insert the plug into the power outlet.



2. Press the «RESET» button, the indicator light turns red.



3. Press the «TEST» button, the indicator light turns off.



4. Press the «RESET» button, the indicator light turns red. The RCD works properly.

### Grounding

You are recommended to use the services of a qualified electrician to ensure that the spa is electrically grounded by using a copper conductor of at least 2.5 mm<sup>2</sup> cross section.

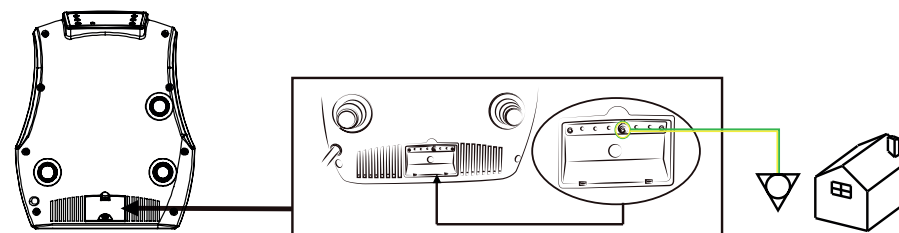

## 4. USAGE

### 3.3. Assembling



1) Unfold the inflatable spa over the base protector.



2) Before inflating, assemble connecting tube into SPA pool



3) Inspect spring inside valve in the upspring status



4) Connect the inflation hose to the pump on the socket .



5) Insert the inflation hose into the inflatable spa .



6) Connect the pump unit then press the button to inflate the spa.



7) Wait 60 seconds for SPA shaping



8) Make up air through a hand pump equipped.



9) Complete inflating and remove the inflate tube

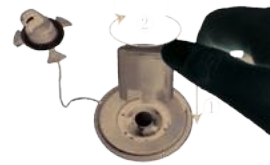

10) Insure valve tightened by tools.



11) Screw the cap firmly in place.



12) Connect the unit pump to the pool using the 3 connectors to screw. Ensure the icons on the pump and the pool match up.



13) Put the filter cartridge in the support then screw it onto the lower suction inside the basin. Cartridge location as shown.



14) Ensure that the drain caps are properly closed before before filling the spa.



15) Smooth wrinkles out of the bottom of the spa, then fill the spa to the level indicated. Your spa is ready.

### 4.1. Control panel

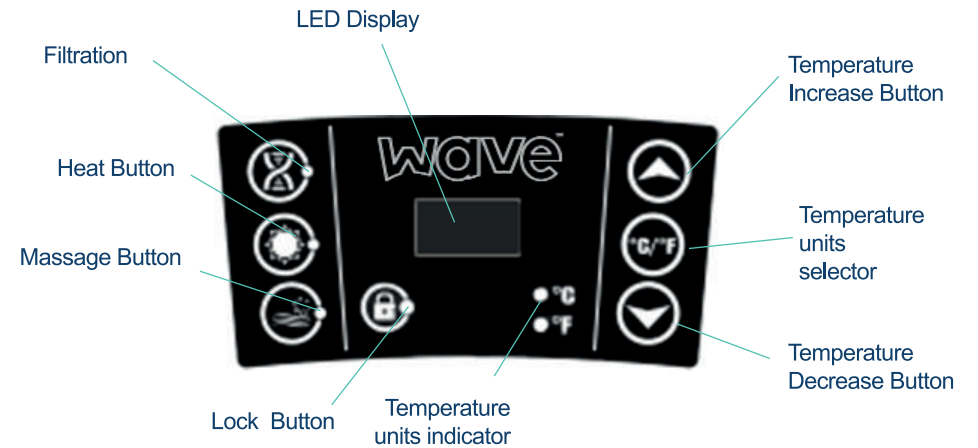

### 4.2. Functions

Once powered-up, the LED displays the current water temperature automatically.



The temperature units selector changes the temperature units from Celsius degrees to Fahrenheit degrees.



Press the temperature adjustment buttons, then the screen will flash. When it is flashing, you can set the desired temperature. The value will increase or decrease 1 degree at once. The temperature could be set between 30°C to 40°C (86°F to 104°F).



To lock or unlock the control panel, press the Lock button and hold 3 seconds. **Lock the control panel when you are away to prevent other people changing the settings...**



Press the massage button to activate the bubble massage system, the green indicator light turns on. It can be turned off by pressing it again.

Note :

- The massage system will stop automatically after 30 minutes of operation. Re-activate the massage function by pressing the massage button again.

- When filter button is on, pressing bubble button will exchange filter mode into massage mode: filter indicator light will turn off and massage indicator light turn on. If press the bubble button again, the massage mode will be changed back to filter mode.

## 5. MAINTENANCE



Press the filter button to activate the water filtration. The green indicator light will turn on when the filtration system is activated.

*Note:*

- If massage function is on, the filtration can't be activated.



Press the heating button to activate water heating and filtering system at the same time. The green indicator light of filter and red indicator light of heating will turn on at same time

The pump does not stop heating until the current water temperature reaches the set temperature; and the heating system will restart after the current water temperature drops 2°C below the set temperature automatically.

Maximum heating temperature: 40°C (104°F)

**Important :**

**After 150 cumulative hours of filtration operations, an audible alarm will sound and the LCD display will show the characters CHG, followed by FIL, to remind you to change or clean the filter. You can hold the filtering button 5 seconds to turn off the buzzing. The filtering system will turn off, you can press the button to activate the filtering system again.**

*Note :*

- With the heating system starting the filtration system will commence working together.
- After turning off the heating system, the filtration system will still work.
- If the massage function is active, the filtration and heating functions cannot be activated.

### 4.3. Pool cover and security

After each use, the control panel must be locked and the pool must be coated with its top cover and it must be attached to the base protector with the safety buckles.

Each safety buckles has a lock system ; closed buckle, the latch in up position locks the buckle, the latch in down position unlocks the buckle.

The top cover keeps the heat from the water and secures the pool.



### 5.1. Water maintenance

**WARNING : A bad pool water quality can harm your health.**

Depending on the frequency and conditions of use:

- The filter cartridge should be regularly cleaned (150 hours max.).
- The filter cartridge should be replaced every 1 to 2 month.
- The pool water should be changed every 15 to 30 days.

Use a water test kit to control the parameters of the water before using the spa, or at least once a week.

Use disinfection products for the spa. The treatment products should be used with caution and it is imperative to refer to instructions before use. Improper use may result in damage to the equipment.

Damage resulting from improper use of treatment products is not covered by warranty (overdose, shock treatment, ...).

#### 1. Water balance

The water balance (pH) must be maintained between 7 and 7.4.

#### 2. Water Sanitation

To sanitize the pool water, we suggest using an active oxygen-based treatment or bromine placed in a floating dispenser. (Dispenser sold separately).



### 5.2. Cleaning and replacing filter cartridge

Dirty filter cartridge may contaminate the pool water and cause damage to the heating function.

1. Unscrew the filter case by turning it counter-clockwise. Take out the filter cartridge from the case.
2. Rinse off the filter cartridge with a garden hose. If the filter cartridge remains dirty and discoloured, the filter cartridge should be replaced.
3. Put back the cleaned filter cartridge into his case and screw it to the pool.



Disinfection

Water Sanitation:

To sanitize the pool water, we suggest using an active oxygen-based treatment or bromine placed in a floating dispenser. (Dispenser sold separately)

If water is heavily polluted you should not use pool.

Clean pool with with specialist UV lighting equipment.

Seek professional advice and guidance before doing this, considering the above.

Attention:

Detergent residues and dissolved solids from bathing suits and chemicals may build up on the spa walls, Use soap and water to clean the walls and rinse thoroughly with a garden hose using a direct powerful waterspray

## 6. TROUBLE SHOOTING

### 5.3. Drainage and storage

#### Drainage

- 1 Check the stopper on the bottom of the pool and the drain cap.
- 2 Unscrew the drain cap.
- 3 Remove the stopper on the bottom of the pool. Completely drain all water from the spa pool.
- 4 Once empty, the pool can be cleaned with soap and water.



#### Storage

- 5 Press the bubbling button to blow out the water inside the jet holes. Unplug the pump, remove the filter cartridge from the inner wall of the pool.
- 6 Use a towel to wipe off the pool, dry for 24 hours
- 7 Push the valves to deflate the pool.
- 8 Fold the pool.

It is recommended that you store the SPA in its original package in a warm dry place.

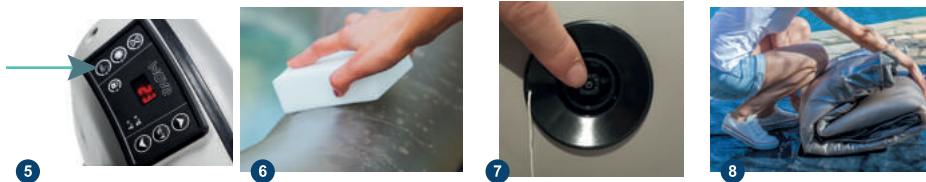

### 5.4. Repair kit

Small punctures or holes in the pool liner can be repaired with the repair kit included.

1. Find the leak.
2. Thoroughly clean the area surrounding the leak.
3. Cut a piece of repair material in round shape, which should be larger than the damaged area.
4. Apply adhesive to the underneath side of the patch and around the area to be repaired.
5. Put the patch on the damaged area and press down firmly. Allow 12 hours for repair to dry. After patch has dried, apply glue around the edges for a complete seal (dry 4 hours).

If air valve damages or leaks, please replace valve according to the steps followed.



Directly press down spring inside valve to deflate.



Use tools to unscrew air valve spindle.



Replace a new air valve spindle.



Tighten the air valve by tools.

### 6.1. Troubleshooting

Here are some useful tips to help you to diagnose and rectify common sources of trouble.

Problem	Cause	Solution
Control panel screen does not operate	Check power source	Power failure
		Reset the RCD plug / Check if the wiring system is adapted to the power of the pump unit (1540W)
		Call for service if it does not reset
SPA pump does not heat properly	Temperature set is too low	Set to a higher temperature
	Filter Cartridge is dirty	Clean or Replace the cartridge (see chapter 5.2)
	Too low water level	Fill water to minimum water level
Bubble massage system does not work	Heating element defective	Call for service
	Pump is overheating	Cut off the power and wait until the pump has cooled.
	Auto shut-down feature (30min) is activated	Press the bubble button to reactivate
Water filtration does not work	Malfunction of the pump unit	Call for service if it does not reset
	Filter Cartridge is dirty	Clean or Replace the cartridge (see chapter 5.2)
	Inlet and outlet blocked	Clean the inlet and outlet
Pump leakage	Air inside the pump	Fill water to minimum water level
	Adaptor seal improperly	Replace the seal in the right position
	Malfunction of the pump unit	Call for service if it does not reset
Spa pool leakage	Water leakage from pump body	Check the pump body, call for service
	Spa pool is torn or punctured	Use provided repair kit (see chapter 5.4)
Water is not clean	Insufficient filtering time	Increase the filtering time
	Filter Cartridge is dirty	Clean or Replace the cartridge (see chapter 5.2)
	Pool filled water quality	Change the pool water completely
	Improper water treatment	Refer to the chemical manufacturer's instructions



# 7. WARRANTY

## 7.1. Error code

If the screen displays an error code “Ex”, please refer to the table below.

Code	Situation	Problem	Causes	Solutions
E1	Not heating Not heating properly.	Wrong temperature control sensor.	Temperature control sensor short circuit or open circuit.	Contact service center.
E3	Not heating properly.	High water temperature indicator.	1. The filled water is over 45°C (113°F) 2. The filter cartridge was put on the wrong suction fitting (higher suction fitting).	1. Cut off the power, make sure the pool water is between 2°C~44°C(36°F~111°F). If this does not solve the problem, refer to the box below. 2. Put the filter cartridge on the lower suction fitting.
E4	All functions do not work, buzzing warning.	Low water temperature indicator.	The pool water is lower than 2°C (36°F).	· Cut off the power, make sure the pool water is between 2°C~44°C (36°F~111°F) · If this does not solve the problem, refer to the box below
E5	All functions do not work, buzzing warning.	High water temperature indicator.	The filled water is over 50°C (122°F).	· Cut off the power, turn to qualified electrician to reset the thermal cutout described in next paragraph. · If this does not solve the problem, refer to the box below
E6	Not heating and filtering properly. Buzzing warning.	Water pressure is not big enough to activate heating.	· Inlet or outlet on inner wall are blocked. · Filter cartridge is too dirty. · Pool water does not reach minimum water level. · Do not release air from pump Pump is wrong”	· Clean inlet and outlet · Clean or replace filter cartridge · Add water to reach water level · Do air release as outlined again · If this does not solve the problem, refer to the box below

### E3, E4, E5, E6 error code

- Cut off electricity for 5 minutes and reconnect.

If error code is still displayed on the control Box, please do the following instructions:

1 - Check that the water line is between the high and low limits.

2 - Clean or replace the filter cartridge.

3 - Unscrew and clean the 2 nozzles (Entry and exit of water) inside the spa and remove wastes if necessary (leaves, hairs, fur, skin...)

4 - Check that the propeller of the filter pump does not contain foreign objects.

Cut the spa again electrically for 5 minutes and re-connect it, if the error code is still displayed on the control box please contact the service centre.

## 7.2. Warranty

Wave products have been inspected with no evident defects prior to leaving the factory.

Wave warrants this product against defects in material and workmanship for a period of time, 1 year for the pump and 6 months for the liner, unless local law has special requirement. Warranty for this product begins on the date of purchase and Wave requires presentation of the original proof to purchase to confirm the date. During the warranty period, Wave will either repair or replace, at its discretion, any defective products. Replacement products or repaired parts will be warranted for the unexpired portion of the original warranty.

Shipping cost policy

The return of defect parts to the authorized service centre is at the cost of the owner.

On warranty period, the return is at the cost of service center.

Warranty policy

This limited warranty does not apply to any defect resulting from negligence, accident, misuse, or other reason beyond Wave's control, included but not limited to: normal wear and tear, negligence or failure to follow the product instructions, improper or inadequate maintenance; connection to improper power supply; chemical water damage, loss of pool water, unauthorized product modification or repair; use for commercial purpose; fire, lightening, flood or other external causes.

This warranty is valid only in the country of purchase in such countries where Wave sells and services the same model with identical technical specifications.

Warranty service outside the country of purchase is limited to the terms and conditions of the corresponding warranty in the country of service. Where the cost of repairs or replacement is not covered by this warranty, Wave will advise the owners and the cost shall be charged to the owner.

This warranty only applies to the original purchaser and terminates upon any transfer of ownership.

All repairs of which warranty claims are made must be pre-authorized by a Wave service centre.

All the authorized selling dealer is responsible for all in-field service work carried out on your Wave product. Wave will not be liable for results of cost of workmanship from unauthorized service person.

Warranty registration

To validate your warranty, please register your product on our website Wave: [www.wavespas.com](http://www.wavespas.com)

It is essential that all informations including customer name, date of purchase, serial number, spa model are provided. Without this information the warranty will be invalid.

**Waves Direct**

**9-10 Charlotte Square , Newcastle upon Tyne,  
Tyne and Wear, NE1 4FX, United Kingdom**

**[wavespas.com](http://wavespas.com)**