

»» ENGINEER REPORT

WATER HAMMER CONTROL

THE SCIENCE / THE SOLUTION / THE SELECTION

- »» RESIDENTIAL MiniRester™
- »» COMMERCIAL HydraRester™
- »» INDUSTRIAL MegaRester™



WATER HAMMER CONTROL

»» An Explanation and Solution to Water Hammer

Water hammer can occur in any type of piping system— small, medium or large. Whether you are designing a residential condo project, a commercial office tower or an industrial laundry facility in a high-rise hotel, proper methods for water hammer control need to be employed during the design stages of construction. This Engineer Report will explain the physics of water hammer and the best methods of water hammer control for residential, commercial and industrial piping systems.



TABLE OF CONTENTS

1 The Science

1.1 The Physics of Water Hammer
PG 03

1.2 The Damage
PG 05

2 The Solution

2.1 Controlling Water Hammer
PG 09

2.2 Arrester Sizing Guidelines
PG 10

2.3 National Model Codes
PG 11

2.4 Residential Arrester Sizing & Placement
PG 12

2.5 Commercial Arrester Sizing & Placement
PG 14

2.6 Industrial Arrester Sizing & Placement
PG 16

3 The Selection

3.1 Sioux Chief Arresters
PG 19

3.2 Residential Arresters
PG 20

3.3 Commercial Arresters
PG 22

3.4 Industrial Arresters
PG 26

3.5 Comparison
PG 28

4 The Appendix

4.1 Certifications
PG 31

4.2 Trade Journal Articles
PG 34

4.3 Arrester Installations
PG 38

4.4 Spec Sheets
PG 42

Flowing water lines, like trains, are hard to stop quickly. While they can be stopped by a valve or faucet, the sudden stop no doubt results in a serious pressure surge. The analogy may seem extreme, yet the truth is every time a flowing water column is stopped abruptly, a small train wreck occurs in your water line. The longer the line, and the faster the flow, the more momentum the "train" will carry. Even though these collisions in your lines are small, their long-term effects can and will result in large-scale damage throughout the piping system.



The Science

» Explaining the Physics of Water Hammer

This section covers the physics of uncontrolled water hammer and its damaging effects as they pertain to any piping system. We also review the history of water hammer in plumbing systems, previous attempts to control water hammer, and why these methods failed.

What Is Water Hammer

The term “water hammer” is used to describe the pressure surges, audible noise and destructive forces associated with the transfer of kinetic energy into the piping system due to an abrupt change in velocity of a non-compressible fluid. For the purpose of this discussion, the non-compressible fluid is usually water, and the change in velocity usually occurs when the flowing water comes to a sudden and complete stop due to valve or faucet closure. Thus, in the equations below, the initial flowing velocity is always equal to the change in velocity. (Example: Initial flowing velocity is 8 feet per second and, when the flow is completely stopped, zero feet per second. The change in velocity is 8 - 0 or 8 fps, which is equal to the initial flowing velocity of 8 fps.)

The two main factors necessary to create water hammer in a piping system are the initial speed (velocity) of the flowing water and an abrupt change to this flowing water velocity. When a water column is stopped abruptly, the momentum force in the flowing water (kinetic energy) quickly transforms into a pressure rise within the pipe. The amount of force (KE ft/lbs) within the flowing water can be calculated by the formula for kinetic energy:

$$KE = \frac{1}{2} mv^2$$

When considering KE within a piping system, the mass (m) can be substituted with the physics characteristics of water within a cylindrical pipe (i.e., specific weight, cross-sectional area, length, plus gravitational constant). Velocity (v) is calculated in feet per second (fps), which can easily be converted from the known gpm and pipe size. For a plumbing or piping system, the kinetic energy formula can be expressed as this:

$$KE = .97 \times A \times L \times v^2$$

A = Cross sectional area of pipe I.D. in square feet

L = Length of effective pipe in feet

v = Velocity of flowing water in feet per second

Since we can calculate the kinetic energy, we can also calculate the actual “pressure rise” within a piping system by using Joukowsky’s Formula:

$$pr = wav / 144g$$

pr = Pressure rise above flow pressure (psig)

w = Specific weight of liquid (water = 62.4 lbs/ft³)

a = Velocity of pressure wave in feet per second (fps)
(4000 – 4500 fps in metal pipe)

v = Change in flow velocity in feet per second (fps)

g = Gravitational constant (32.2 fps²)

1. Valve closed - static water

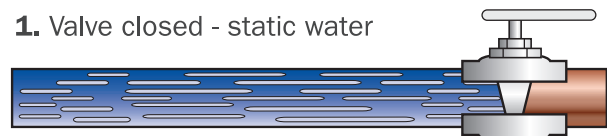

2. Valve open - moving water

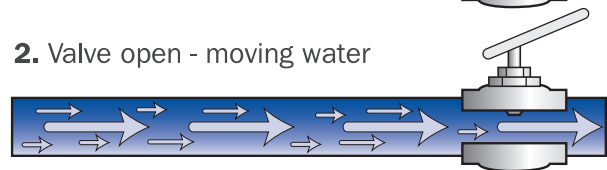

3. Valve closes - **WATER HAMMER**

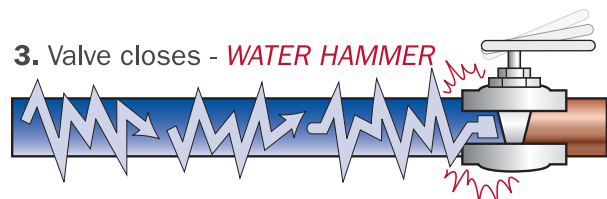

What is Water Hammer Continued

By plugging in the given factors on the previous page, the formula shows us that the pressure rise in metal pipe due to a sudden change in velocity is approximately 60 times the original flow velocity in feet per second. Thus, a common 1/2" supply line, flowing at 6 fps, can generate a pressure rise of 360 psig above and beyond the flow pressure itself (right). The resultant shock wave bounces back and forth within the supply line until it reaches a point of relief in a larger main where the initial velocity was much slower.

Within plastic pipe systems, such as PVC, CPVC, and PEX, the modulus of elasticity is much less than copper or steel pipe, and thus the velocity of the pressure wave is slower. This results in a lower pressure rise in plastic pipe versus metal pipe, given the same parameters. However, an equal amount of kinetic energy exists in both plastic and metal systems. So where does the energy go if it does not result in the same type of pressure rise? The answer is the excessive energy is absorbed into the plastic piping system by the instantaneous expansion of the pipe, fittings and appurtenances within the system. Historically, water hammer damage to the pipe itself is not the main concern, because the pipe can generally handle these expansions and contractions. Rather, it is the wide variety of fitting systems for plastic pipe (i.e., solvent weld, mechanical crimp, pinch clamps, expansion fittings, both made from brass and hard plastic) that are at risk.

WHY AIR CHAMBERS DON'T WORK

It used to be thought that an air chamber, or capped stand pipe, was an effective solution to controlling water hammer. However, within an air chamber, nothing separates the air from the water. It only takes a few short weeks before the air is absorbed into the water, leaving the air chamber waterlogged and completely ineffective. Laboratory tests confirm that the air is depleted by simple air permeation and by interaction between static pressure and flow pressure. In the diagram shown, (right) notice the difference in water level between "Static Line Pressure" and "Post-cycle Static Level."

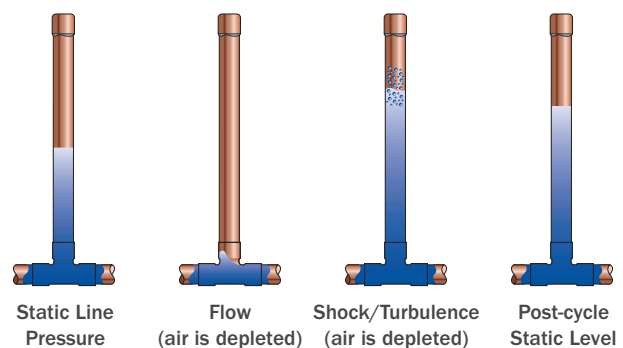
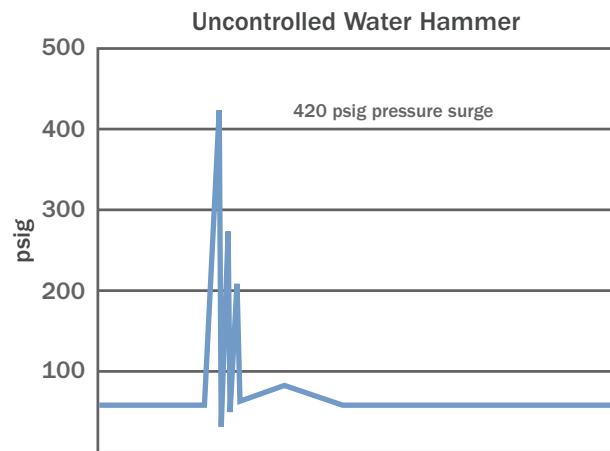

Product Damage Due to Water Hammer

All valves, fittings and appurtenances in the shock wave's path feel the full brunt of this pressure rise each and every time the flow is abruptly stopped. It would be a big mistake to consider only the excessive pressure effects on the pipe itself, because the pipe is not a primary concern for failure. Rather, all other plumbing products within the system are at risk. Certainly, in due time, uncontrolled water hammer will cause premature failure in the following products:

WATER HEATERS
SAFETY RELIEF VALVES (T&P VALVES)
PRESSURE REDUCING VALVES (PRVs)
BACKFLOW PREVENTERS
FAUCETS
SOLENOID VALVES
FITTINGS
HANGERS & BRACKETS

WATER HEATERS

Expansion and contraction caused by thermal changes has always been thought of as the main cause of tank failure. This may very well be true, but failure is exacerbated by water hammer. Although the evidence of water hammer damage is not as apparent, both residential and commercial water heaters fail prematurely from this excessive force. Repetitive shock waves traveling through the tank can eventually cause the tank lining to crack, leaving the steel tank exposed to rust and failure.



SAFETY RELIEF VALVES (T&P Valves)

Although the T&P is designed to relieve excess pressure, its simple spring design is not adequate to handle the rapid shock wave created by uncontrolled water hammer, which can come and go in a few milliseconds. The valve is left to absorb the damaging shock wave. On occasion, depending on the circumstances, the valve may "pop off" as a result of water hammer. However, this is not the intended purpose of this device, and could lead to failure when the safety feature is needed most.



Product Damage Due to Water Hammer Continued

PRESSURE REDUCING VALVES (PRVs)

Although PRVs are usually located at the opposite end of a quick-closing termination valve, the resultant shock wave will still affect a PRV. Repetitive shock waves can eventually damage the mechanics of the device, rendering it useless and allowing excessive main pressure to pass. Water hammer has also been known to crack the brass castings and seats of the device.



BACKFLOW PREVENTERS

Just like PRVs, backflow preventers are subject to the same water hammer problems. However, the damage and problems can be more complicated and costly with BFPs. Excess water hammer pressure downstream is inconveniently dumped by the BFPs relief valves each and every time a shock wave is created.



FAUCETS

Of course, faucets are susceptible to damage from the water hammer created by their own quick-closing design. Expensive faucet cartridges have been known to fail or even crack in half due to water hammer.



SOLENOID VALVES

Electronic solenoid valves in both residential and commercial clothes washers, dishwashers and ice makers are very susceptible to water hammer damage. The solenoid valve is usually the first (and by far the most common) part to be replaced on these appliances. Solenoid valves are now prominent on commercial flush valves and lav faucets. Do not be fooled by some manufacturers' claims of "slow-closing" solenoid valves. For both regular and slow-closing valves, the speed of closure and subsequent change in flow is still very abrupt and destructive.



FITTINGS

Solvent weld fittings for PVC and CPVC systems, as well as various mechanical joint systems for PEX pipe, are especially vulnerable to water hammer damage. Water hammer puts undue stress on directional fittings in two ways. First, the excess internal pressure can easily exceed the ASTM pressure rating for the system. Second, water hammer often causes pipe movement, which results in external stress on tees and elbows.



HANGERS & BRACKETS

Uncontrolled water hammer is by far the primary cause of loose pipe hangers and failed pipe support systems. This causes additional noise from loose rattling pipes and sometimes total pipe failure when hangers are completely dislodged.

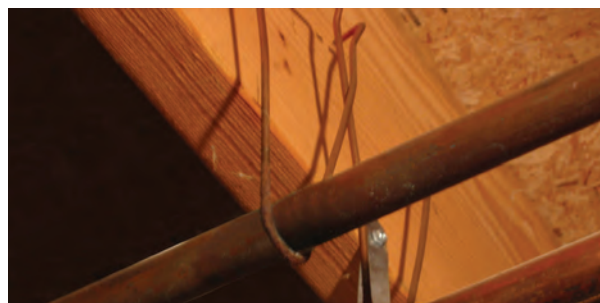



The most efficient and widely used type of arrester is the piston style. Its simplicity of design is cost efficient to produce, yet few moving parts assures high quality and longevity.

The Solution

» Exploring the Solution to Water Hammer

This section discusses the best method of water hammer control by means of an engineered water hammer arrester. It also covers the three common sizing and placement methods used in the plumbing industry for residential, commercial, and industrial applications, along with the applicable codes and standards.

Controlling Water Hammer

The most effective means of controlling water hammer is the installation of an engineered water hammer arrester. An engineered arrester employs a measured, compressible cushion of air or gas which is permanently separated from the water. When a valve closes abruptly, the moving water column is displaced up into the arrester, compressing the permanent air charge until all the momentum of the moving water is safely dissipated, allowing the column to slow down calmly, preventing the development of water hammer.

Historically, manufacturers have employed a rubber diaphragm, a metal bellows or a piston with o-rings to separate the air from the water. Although all of these types of devices have been around for many years, the most efficient and widely used type of arrester is the piston style. Its simplicity of design is cost efficient to produce, yet few moving parts promote high quality and longevity.

ASSE Testing and Certification

To ensure quality, the arrester product standard most widely specified by engineers worldwide is ASSE 1010. The American Society of Sanitary Engineering (ASSE) requires rigorous testing and annual factory quality audits in order for the manufacturer to display the ASSE Certification on their arresters. In addition, national model codes in the USA and Canada require ASSE 1010 Certification on any arrester installed.

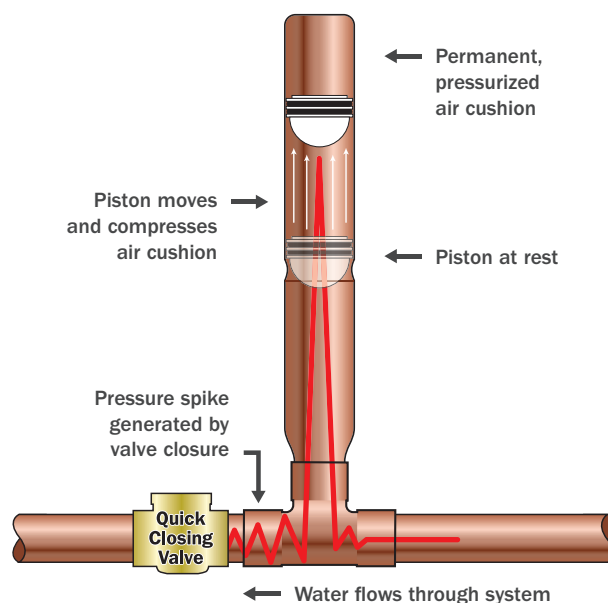

Methods of Sizing

Three different methods of sizing are outlined below for each industry segment. Choose the sizing method most appropriate for your project and refer to the following pages for more details on that method.

RESIDENTIAL



Single-Fixture & Private Plumbing Groups

Applications: Not just for homes. Plumbing fixtures in homes, duplexes, apartments, condominiums, motels, hotels and military housing.

Sizing / Placement

Guideline: One size fits all. Point-of-use AA size arrester on both hot and cold lines. Place on dishwashers, washing machines and tub/shower valves.



Dishwasher Laundry Tub/Shower

Arrester Group: Any ASSE 1010 Certified AA size arrester. Various connection size and type are for installer's convenience.



MIP Laundry Tub/Shower

COMMERCIAL



Multi-fixture Plumbing Groups

Applications: Plumbing fixtures in office buildings, retail, schools, hospitals, correctional facilities and public buildings.

Sizing / Placement

Guideline: The properly sized arrester corresponds to the total number of fixture units on each hot and cold branch line. Place each arrester at end of the branch line.

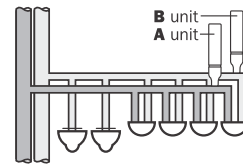

Arrester Group: Any ASSE 1010 Certified A, B, C, D, E, or F size arrester. Various connection size and type are for the installer's convenience.



A B C D E F

INDUSTRIAL

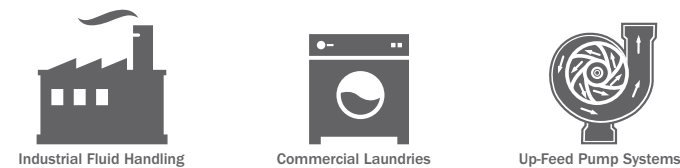

Large Industrial Piping Systems

Applications: Industrial equipment, food processing, commercial laundry, up-feed pump systems, irrigation and waste treatment systems.

Sizing / Placement

Guideline: To size an arrester for industrial applications, use the Industrial Equation, custom sizing the arrester given the system information of a particular project. A computer spreadsheet version of this equation is also available.



Arrester Group: Large industrial size arresters, 200-400 cubic inch size.



Residential & Commercial Model Code Requirements

Both UPC and IPC model codes, and now the National Plumbing Code of Canada, all require the installation of ASSE 1010 Certified Water Hammer Arresters on all quick-closing valves to control water hammer in both residential and commercial plumbing applications.



2012 UNIFORM PLUMBING CODE (UPC/IAPMO)

609.10 Water Hammer: All building water supply systems in which quick-acting valves are installed shall be provided with devices to absorb the hammer caused by high pressures resulting from the quick closing of these valves. These pressure-absorbing devices shall be approved mechanical devices. Water pressure-absorbing devices shall be installed as closely as possible to quick-acting valves. 609.10.1 Mechanical Devices: When listed mechanical devices are used, the manufacturer's specifications as to location and method of installation shall be followed.

IPC

2012 INTERNATIONAL PLUMBING CODE (IPC/ICC)

604.9 Water hammer: The flow velocity of the water distribution system shall be controlled to reduce the possibility of water hammer. A water-hammer arrestor shall be installed where quick-closing valves are utilized. Water-hammer arrestors shall be installed in accordance with the manufacturer's specifications. Water-hammer arrestors shall conform to ASSE 1010.



NATIONAL PLUMBING CODE OF CANADA 2010 (NPC/NRCC)

A-2.6.1.9.(1) Water Hammer Prevention. Water hammer is a buildup of pressure in a length of horizontal or vertical pipe that occurs when a valve or faucet is closed suddenly. The longer the pipe and the greater the water velocity, the greater the pressure exerted on the pipe, which can be many times the normal static water pressure and be sufficient to damage the piping system. Since air chambers made from a piece of vertical pipe do not provide acceptable protection, pre-manufactured water hammer arresters are required to address this potential problem. 2.2.10.15. (1) Water Hammer Arresters. Water hammer arresters shall conform to ASSE 1010.

NOTE: The three model codes above make no exception to their arrester requirements for various piping materials. Both plastic and metal piping systems are required to have water hammer arresters installed to protect not only the pipe itself, but all fittings, valves and appurtenances that would otherwise be adversely affected by uncontrolled water hammer.

Residential Installation Guide

To control water hammer in most residential applications, install ASSE 1010 Certified AA size water hammer arresters on both the hot and cold supply lines serving washing machines, dishwashers, ice makers and quick-closing tub/shower valves to satisfy the minimum requirements of all model codes. Arresters should be installed within six feet of each culprit valve, and can be installed at any angle. All AA size arresters that are ASSE Certified are equal in arrester capacity, regardless of connection size and type. The various AA arrester connection types are simply for the convenience of the installer.



Recommended



Dishwasher



Laundry



Tub/Shower



Ice Maker

Use as Needed



Lav/Sink



Toilet Ballcock

» Placement

Arresters should be installed within six feet of each culprit valve, and can be installed at any angle.

Access Boxes With Integral Arresters

In addition to the many connection types, ASSE Certified AA arresters are also available as integral parts of the supply valves installed in access boxes, such as laundry and ice maker boxes. These products make installation simple and easy for the plumber because the arresters are already the right size and factory installed in the right place for the application.

For the same reasons, they make code enforcement simple for the plumbing inspector. When access boxes with integral arresters are installed, the correct size and placement of the arresters is accomplished every time.



Residential Irrigation

Zone valves in residential lawn sprinkler systems are common culprits of severe water hammer. This uncontrolled pressure surge can be very damaging not only to the sprinkler system components but also to the backflow preventer and other components of the plumbing system.

To prevent water hammer, install the specified ASSE 1010 Certified arrester within six feet of the zone valve or group of valves:

On 3/4" service line:
One B size arrester

On 1" service line:
One C size arrester

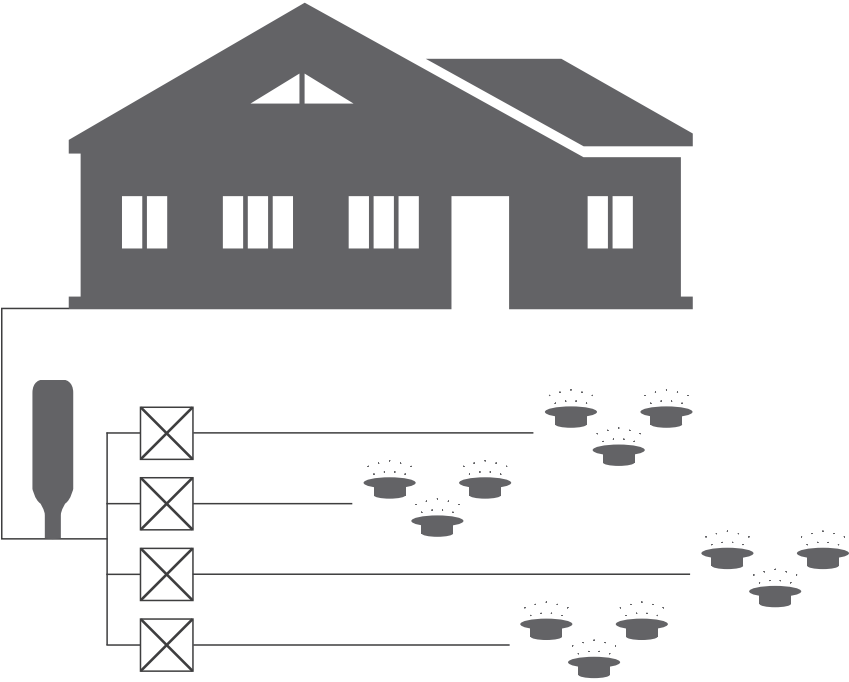

Commercial Installation Guide

For water hammer control in commercial plumbing applications, such as water closets, urinals and lavs in public restrooms, use the following sizing and placement guidelines based on fixture units.

DETERMINING ARRESTER SIZE BY FIXTURE UNITS

The National Plumbing Code offers this definition of fixture unit: “A fixture-unit is a quantity in terms of which the load producing effects on the plumbing system of different kinds of plumbing fixtures are expressed on some arbitrarily chosen scale.” The fixture unit values shown in Table 1 below represent the standard ratings used by engineers to size water distribution systems as well as water hammer arresters. “Public” fixtures, as referred to in Table 1 below, are fixtures found in public rest rooms, office buildings and other places where each fixture is open and accessible for use at all times.

MULTIPLE FIXTURE BRANCH LINES

On many types of applications, a single arrester must serve multiple fixtures. In these cases, the total fixture units should be determined for all fixtures served by the branch line where the arrester is to be placed. Once the fixture units for the branch line have been totaled, choose the appropriate arrester by matching fixture units in the table (below) to the arrester size with the corresponding fixture unit capacity. If the total number of fixture units has a fraction, it should be rounded to the next largest whole number. In addition, if the flow pressure at the fixture exceeds 65 psig, the next largest size water hammer arrester should be used.

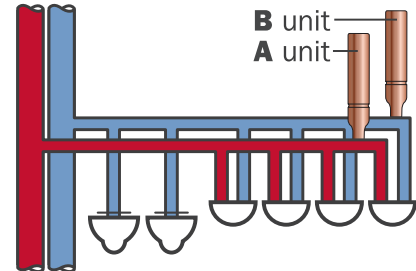

ARRESTER PLACEMENT ON MULTI-FIXTURE BRANCH LINES

Once the correct size arrester has been determined, the final concern is placement of the arrester within the system. Arrester placement depends on the length of the branch line on which the arrester is to be installed, which can be divided into two cases which are described below:

BRANCH LINES OF 20 FEET OR LESS (See Figure 1)

Place arrester at the end of the branch line within 6 feet of the last fixture served, as illustrated on page 15.

BRANCH LINES OVER 20 FEET (See Figure 2)

Calculate fixture units for each 20-foot section separately and place an arrester at the end of each 20-foot section (within 6 feet of the last fixture served in that section) as illustrated in Figure 2 on page 15.

TABLE 1

FIXTURE	TYPE OF SUPPLY CONTROL	FIXTURE UNITS					
		PUBLIC			PRIVATE		
		TOTAL	C.W.	H.W.	TOTAL	C.W.	H.W.
Water Closet 1.66 PF	Flush Valve	8	8	-	5	5	-
Water Closet 1.66 PF	Flush Tank	5	5	-	2.5	2.5	-
Pedestal Urinal 1.06 PF	Flush Valve	4	4	-	-	-	-
Stall or Wall Urinal	Flush Valve	4	4	-	-	-	-
Stall or Wall Urinal	Flush Tank	2	2	-	-	-	-
Lavatory	Faucet	2	1-1/2	1-1/2	1	1	1
Bathtub	Faucet	4	2	3	2	1-1/2	1-1/2
Shower Head	Mixing Valve	4	2	3	2	1	2
Bathroom Group	Flush Valve Closet	-	-	-	8	8	3
Bathroom Group	Flush Tank Closet	-	-	-	6	6	3
Separate Shower	Mixing Valve	-	-	-	2	1	2
Service Sink	Faucet	3	3	3	-	-	-
Laundry Tubs (1-3)	Faucet	-	-	-	3	3	3
Combination Fixture	Faucet	-	-	-	3	3	3
Clothes Washer	Solenoid Valves	-	-	-	4	3	3
Dishwasher	Solenoid Valve	-	-	-	1.5	-	1.5
Ice Maker	Solenoid Valve	-	-	-	1	1	-

TABLE 2

ARRESTER SIZE	AA	A	B	C	D	E	F
FIXTURE UNITS	1-4	5-11	12-32	33-60	61-113	114-154	155-330



FIGURE 1

If 20ft or less, place one arrester 6ft or less from the end of the run.



FIGURE 2

If more than 20ft, place arrester at the end of each 20-foot section, within 6ft of the end of that section.

Industrial Installation Guide

©1996 Sioux Chief Manufacturing

The formula below was developed by Sioux Chief as an alternative method of sizing the necessary arrester capacity for large commercial and industrial applications. In these situations, the formula shown below can be used to select the correct size arrester for any given system.

$$C = \frac{1.5 \times L \times V^2}{D^2 \times (P_f + 14.7) \times Y}$$

- L** = Effective pipe length (in feet)
- V** = Change in Velocity (in gallons per minute)
- D** = I.D. of pipe (in inches)
- P_f** = Flow pressure (PSIG)
- Y** = A function of P_{ma}/P_{fa} (see graph on following page)
- P_m** = Maximum allowable pressure (PSIG)
- C** = Required arrester capacity (in cubic inches)

EXAMPLE

Description of System

L Length of pipe = 200 feet. This is the effective pipe length of the branch line serving the hammering valve. This is where the energy is. As the same flow goes through larger pipes, such as the main trunk line, the energy calculates to be very low and inconsequential.

V Change in velocity = 120 gpm. We can usually assume that our initial flow rate (120 gpm) is equal to the change in velocity, because when we shut off a valve completely, the resultant velocity is always 0. Thus, 120 - 0 = 120. However, if the valve does not completely shut off, and the velocity changes from 120 gpm to 40 gpm, V would then equal 120 - 40 = 80 gpm. This is the most critical factor in the formula, and usually the most difficult to get on an existing installation.

D Pipe size = 3". Try to use the actual I.D. of the pipe if possible. The nominal size of the pipe will get you close to the right answer, but the actual I.D. size will be more accurate.

P_f Flow pressure = 60 psig. This variable is the gauge pressure at the valve when the valve is on. In the formula, we add 14.7 psi (atmospheric pressure) to the gauge pressure to convert it to absolute or **P_{fa}**.

P_m Maximum allowable pressure = 150 psi. This variable represents the pressure to which the sized arrester will limit the shock. It can vary depending on input from the plumber or yourself, but 150 psig is generally used because most plumbing equipment is rated at 150 psig. Also we have observed little or no water hammer noise at this level. In the formula, we add 14.7 psi (atmospheric pressure) to the gauge pressure to convert it to absolute or **P_{ma}**.

FORMULA CALCULATIONS

First we should calculate for the Y Factor. This variable answers the question "What is the maximum allowable pressure in relationship to the flow pressure? Is it twice as much?" To determine this you must divide the maximum allowable pressure (remember to add 14.7 to convert **P_m** to **P_{ma}**) by the flow pressure (remember to add 14.7 to convert **P_f** to **P_{fa}**).

$$P_{ma} / P_{fa} = (150 + 14.7) / (60 + 14.7) = 2.2$$

$$P_{ma} / P_{fa} = 2.2$$

Next, look at the graph (on following page) and find the intersection of **2.2** and the **Y** curve. Follow that point straight down to the X axis to read **35**. In this example, **Y = 35**.

Now that you have all the variables, do the original calculation:

$$C = \frac{1.5 \times 200 \times 120^2}{3^2 \times (60 + 14.7) \times 35}$$

$$C = 184 \text{ in}^3$$

ARRESTER SIZING

Choose an arrester that is equal to or larger than the necessary capacity in your calculation. In this example, a 200 cubic inch industrial arrester is the correct choice.

ARRESTER PLACEMENT

Place arrester on supply side of culprit valve within the last 5% of supply line to the valve. In this example, place arrester within 10 feet of the valve.

- L = Effective pipe length (in feet)
- V = Change in Velocity (in gallons per minute)
- D = I.D. of pipe (in inches)
- P_f = Flow pressure (PSIG)
- Y = A function of P_{ma}/P_{fa} (see graph below)
- P_m = Maximum allowable pressure (PSIG)
- C = Required arrester capacity (in cubic inches)

$$C = \frac{1.5 \times L \times V^2}{D^2 \times (P_f + 14.7) \times Y}$$

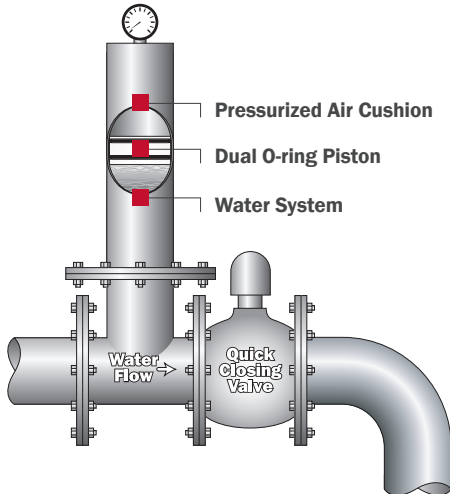

➤➤ **After Placement**
 The pressurized air cushion is permanently separated with a dual o-ring piston from the water system.

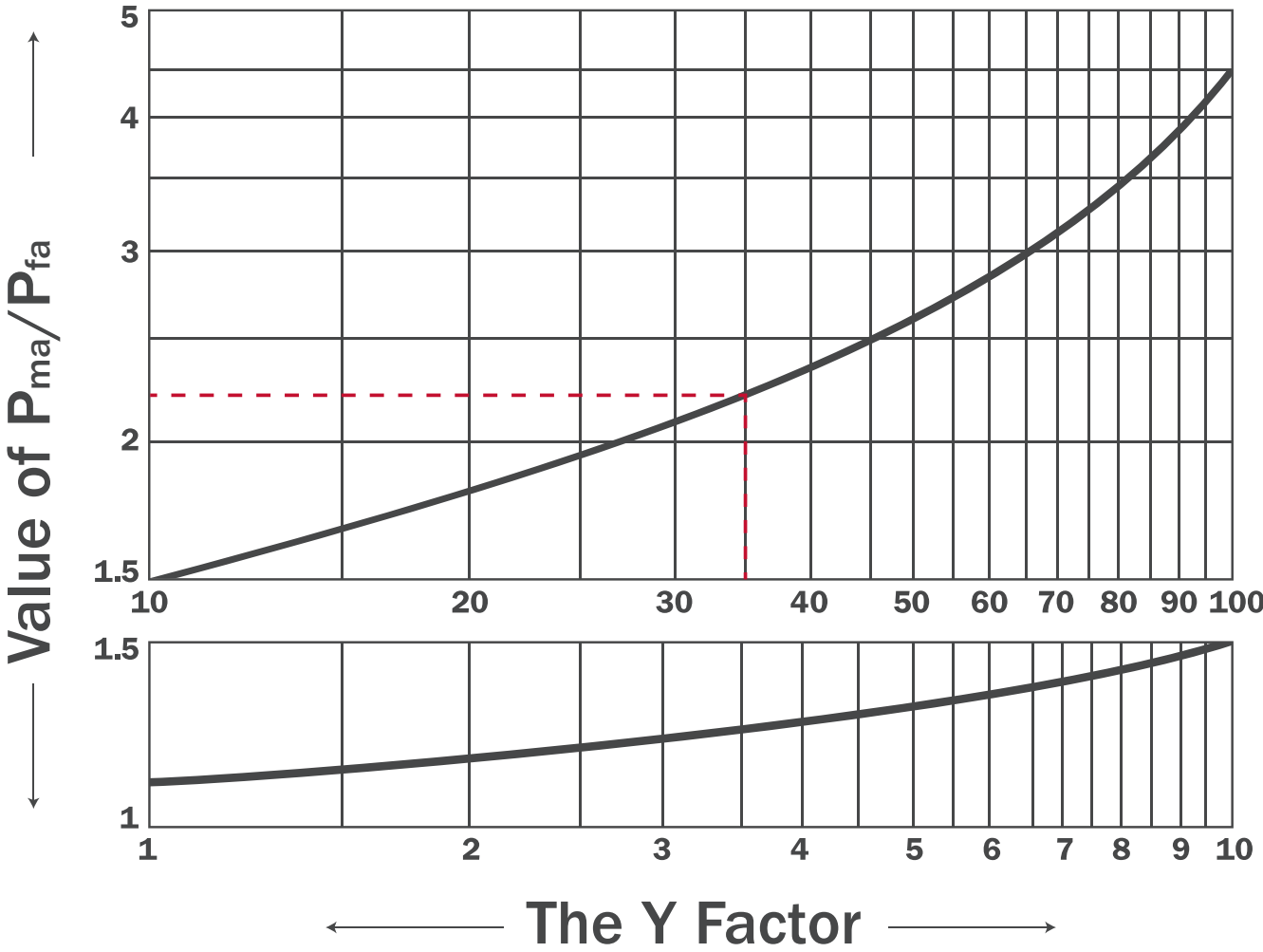



The Selection

» Exploring the Selection of Water Hammer Arresters

This chapter will explain why the Sioux Chief line of residential, commercial and industrial water hammer arresters is the number one arrester selected by engineers and specifiers throughout North America and around the world.

Sioux Chief Arresters

Sioux Chief Mfg. leads the plumbing industry in the development and manufacture of water hammer arresters for any and all applications.

Piston Design. Simplicity of design allows for the highest quality and longest life of any arrester type. Endurance tested to 500,000 cycles without failure.

Made in America. All arresters are manufactured in the USA, utilizing all-American copper and brass materials.

Green Footprint. 100% recyclable copper and brass, sourced from the Midwest, efficiently produced and distributed from the Heart of America, creates the smallest carbon footprint of any arrester brand on the market.

Connection Options. Sioux Chief's unique ability to provide a wide variety of connection options saves the installer time and money, while eliminating costly transition joints. Integral arrester connection types are designed specifically for the type of piping system used.

Certified. Arresters are certified by ASSE to the ASSE 1010 Standard, satisfying the requirements of all model codes. ASSE performs yearly factory audits to ensure their high-quality standards are maintained.

Expertise. Sioux Chief has experts on staff with computer software to help you with new project sizing, as well as troubleshooting existing installations.

Acceptance. Millions of Sioux Chief arresters have been specified and installed throughout the country and around the world over the past 25 years.

RESIDENTIAL MiniRester™



COMMERCIAL HydraRester™



INDUSTRIAL MegaRester™



MiniRester

All MiniResters are approved for sealed wall installations with no access panel required, and are certified by ASSE as AA size to the ANSI/ASSE 1010-2004 Standard. MiniResters may be installed at any angle.

STRAIGHTS

- Straight sweat arresters are compatible with press-fitting systems, such as Viega ProPress™ and all push-fitting systems
- Straight compression arresters install on any 1/2" nom. copper leg or riser. Especially popular in retrofitting 1/2" nom. air chambers
- MIP thread arresters install on any new rough-in or retrofit installation with 1/2" FIP fittings
- CPVC solvent weld arresters install on 1/2" CPVC tube or fittings in rough-in or retrofit applications
- PEX MiniResters are available with F1807, F1960 and Viega PexPress connections
- All 660-G Series MiniResters use brass components certified as no-lead. MiniResters made with copper and plastic components only are naturally no lead compliant

TEES

- Full-slip tee sweats install in-line on 1/2" CTS near the problem valve or fixture
- Hose tee arresters install on washing machine supply valves or directly to washing machine

TUB/SHOWER TEES

- Sweat branch arresters install easily on sweat tub/shower valves
- FIP swivel thread arresters install on MIP tub/shower valves. No more heat damaged cartridges from soldering the valve

PEX TEES

- ASTM F1807 PEX Tee†
- ASTM F1960 PEX Tee†

COMPRESSION TEES

- Install in-line on ice maker lines, lav or dishwasher supply tubes

FEMALE COMPRESSION TEE

- Installs either between stub out and supply stop, or between supply stop and supply tube for faucets, dishwashers, toilets or ice makers

† Note on ASTM PEX Fitting Standards:

ASTM F 1807: PEX Barb Insert Fittings Utilizing a Copper Crimp Ring.

ASTM F 1960: PEX Cold Expansion Fittings Utilizing a PEX Compression Ring.

ITEM NO.	DESCRIPTION	NO LEAD	PKG.	MIN. QTY.	CASE QTY.
STRAIGHT					
660-SB	1/2" Male Sweat	✓	B	50	50
660-S	1/2" Male Sweat, Clamshell	✓	C*	6	6
660-3SB	3/4" Male Sweat	✓	B	50	50
660-GCB	5/8" O.D. Compression Straight	✓	B	50	50
660-GC	5/8" O.D. Compression Straight, Clamshell	✓	C*	6	6
660-G2B	1/2" MIP Thread	✓	B	50	50
660-G2	1/2" MIP Thread, Clamshell	✓	C*	6	6
660-V2B	1/2" CPVC Socket	✓	B	50	50
660-V82B	1/2" Male CPVC	✓	B	50	50
660-V82	1/2" Male CPVC, Clamshell	✓	C*	6	6
660-X2B	1/2" F1807 PEX, Straight	✓	B	50	50
660-GVPX2B	1/2" Viega PEX Press	✓	B	50	50
660-WG2B	1/2" F1960 PEX	✓	B	50	50
ITEM NO.	DESCRIPTION	NO LEAD	PKG.	MIN. QTY.	CASE QTY.
SWEAT TEE					
660-T22	1/2" Full-slip Female Sweat Tee	✓	B	25	25
660-HB	3/4" Female Swivel Hose Thread × 3/4" Male Hose Thread Tee		B	25	25
660-H	3/4" Female Swivel Hose Thread × 3/4" Male Hose Thread Tee, Clamshell		C*	6	6
660-TKB	Female Swivel Ballcock Nut × Male Ballcock Thread Tee		B	25	25
660-TK	Female Swivel Ballcock Nut × Male Ballcock Thread Tee, Clamshell		C*	6	6
TUB/SHOWER TEE					
660-TS	1/2" Male Sweat Open End Branch × 1/2" Female Sweat Tee	✓	B	25	25
660-TS8	1/2" × 8" Stub Out × 1/2" Female Sweat Tee	✓	B	25	25
660-TS88	1/2" × 8" Double Stub Out × 1/2" Female Sweat Tee	✓	B	25	25
660-TSX	1/2" Male Sweat × 1/2" PEX F1807 Crimp Tee	✓	B	25	25
660-TSX88	1/2" × 8" Double Stub Out × 1/2" F1807 PEX Tee	✓	B	25	25
ITEM NO.	DESCRIPTION	NO LEAD	PKG.	MIN. QTY.	CASE QTY.
PEX TEE					
660-GTW2B	1/2" PEX Cold Expansion Tee F1960	✓	B	25	25
660-GTX2B	1/2" PEX Crimp Tee F1807	✓	B	25	25
660-GTX2	1/2" PEX Crimp Tee F1807, Clamshell	✓	C*	6	6
COMPRESSION TEE					
660-GTC0B	1/4" O.D. Compression Tee For Ice Maker Tube	✓	B	25	25
660-GTC0	1/4" O.D. Compression Tee For Ice Maker Tube, Clamshell	✓	C*	6	6
660-GTC1B	3/8" O.D. Compression Tee For Supply Tube	✓	B	25	25
660-GTC1	3/8" O.D. Compression Tee For Supply Tube, Clamshell	✓	C*	6	6
660-GT	5/8" O.D. Compression Tee, No Lead For 1/2" Nom Coppertube, Clamshell	✓	C*	6	6
660-GTB	5/8" O.D. Compression Tee, No Lead For 1/2" Nom Coppertube, Bulk	✓	B	25	25
FEMALE COMPRESSION TEE					
660-GTR0B	1/4" O.D. Comp. × 1/4" O.D. Female Comp.	✓	B	25	25
660-GTR0	1/4" O.D. Comp. × 1/4" O.D. Female Comp., Clamshell	✓	C*	1	6
660-GTR1B	3/8" O.D. Comp. × 3/8" O.D. Female Comp.	✓	B	25	25
660-GTR1	3/8" O.D. Comp. × 3/8" O.D. Female Comp. No Lead, Clamshell	✓	C*	6	6
660-GTRB	5/8" O.D. Comp × 5/8" O.D. Female Comp.	✓	B	25	25
660-GTR	5/8" O.D. Comp. × 5/8" O.D. Female Comp. No Lead, Clamshell	✓	C*	6	6

Packaging Codes || B: bulk C: cut-case box *:individually bar coded



HydraRester

Acceptance. The HydraRester has been specified and installed more than any other arrester model, making it the leading arrester in the country and around the world.

Certified. The American Society of Sanitary Engineering has certified the HydraRester to the ANSI/ASSE1010-2004 Standard.

Tested. HydraRester has been cycle tested at U.S. Testing Laboratories to withstand 10,000 shock cycles. Factory tested to withstand 500,000 cycles without failure (654-C tested).

Healthcare. Copper is well known for its antimicrobial properties. Plus, the HydraRester's piston design eliminates the possibility of stagnant water columns that can create ideal conditions for bacterial growth such as legionella.

Green. The HydraRester is made from 100% recyclable copper, sourced right here in the Midwest. Combined with Sioux Chief's automated production efficiencies, it gives the HydraRester the lowest carbon footprint of any arrester on the market.

Compatible. HydraRester is available in four connection options – MIP, Sweat, PEX or CPVC – saving the installer time and money. HydraRester male sweat fittings are compatible with press-fitting systems, such as Viega ProPress™, and all push-fitting systems.

Compact Size. Allows for installation in a 2 x 4 wall cavity.

Installation Angle. May be installed at any angle.

Sealed Wall Installation. Approved for installation with no access panel required.

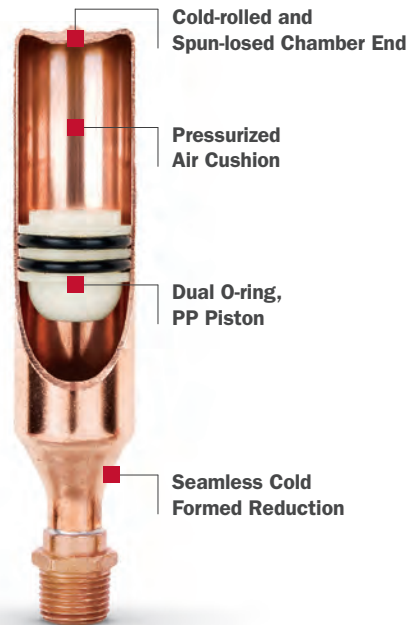

ITEM NO.	CONN. SIZE	UNIT SIZE	DIMENSIONS LENGTH/WIDTH		FIXTURE UNIT VALUE	CUBIC INCH VOLUME	$\frac{1}{160}$	PKG.	MIN. QTY.	CASE QTY.
MIP THREAD										
652-A	1/2"	A	6 1/2"	1 3/8"	1-11	5	✓	B	1	16
653-B	3/4"	B	8 3/4"	1 3/8"	12-32	7	✓	B	1	16
654-C	1"	C	11"	1 3/8"	33-60	11	✓	B	1	16
655-D	1"	D	10 1/8"	2 1/8"	61-113	20	✓	B	1	4
656-E	1"	E	12 5/8"	2 1/8"	114-154	29	✓	B	1	4
657-F	1"	F	15 1/8"	2 1/8"	155-330	36	✓	B	1	4
MALE SWEAT/PRESS FITTING										
652-AS	1/2"	A	8 1/2"	1 3/8"	1-11	5	✓	B	1	16
653-BS	3/4"	B	10"	1 3/8"	12-32	7	✓	B	1	16
654-CS	1"	C	12 1/2"	1 3/8"	33-60	11	✓	B	1	16
655-DS	1"	D	11"	2 1/8"	61-113	20	✓	B	1	4
656-ES	1"	E	13 1/2"	2 1/8"	114-154	29	✓	B	1	4
657-FS	1"	F	16"	2 1/8"	155-330	36	✓	B	1	4
CPVC SOCKET ASTM D 2846 †										
652-AC	1/2"	A	7 1/2"	1 3/8"	1-11	5	✓	B	1	16
653-BC	3/4"	B	9 1/2"	1 3/8"	12-32	7	✓	B	1	16
654-CC	1"	C	12"	1 3/8"	33-60	11	✓	B	1	16
PEX CRIMP ASTM F1807 †										
652-AX	1/2"	A	6 1/2"	1 3/8"	1-11	5	✓	B	1	16
653-BX	3/4"	B	8 3/4"	1 3/8"	12-32	7	✓	B	1	16
654-CX	1"	C	11"	1 3/8"	33-60	11	✓	B	1	16

† NOTE: PEX and CPVC connection specifications are limited to those called out in their respective ASTM Standards for Fittings.

Packaging Codes || B: bulk C: cut-case box *:individually bar coded



Connection Types



Sweat/Press Fitting



MIP

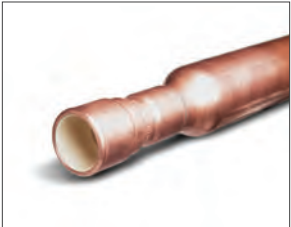

CPVC



PEX

3.3 Commercial Arresters

Cold Water - First Half
 3 Lavs= 4 1/2 FU
 1 Urinal= 4 FU
 TOTAL= 8 1/2 FU
 Requirement= A-Size

Cold Water - Second Half
 1 Urinal= 4 FU
 3 Water Closets= 24 FU
 TOTAL= 28 FU
 Requirement= B-Size

Hot Water
 3 Lavs= 4 1/2 FU
 Requirement= A-Size

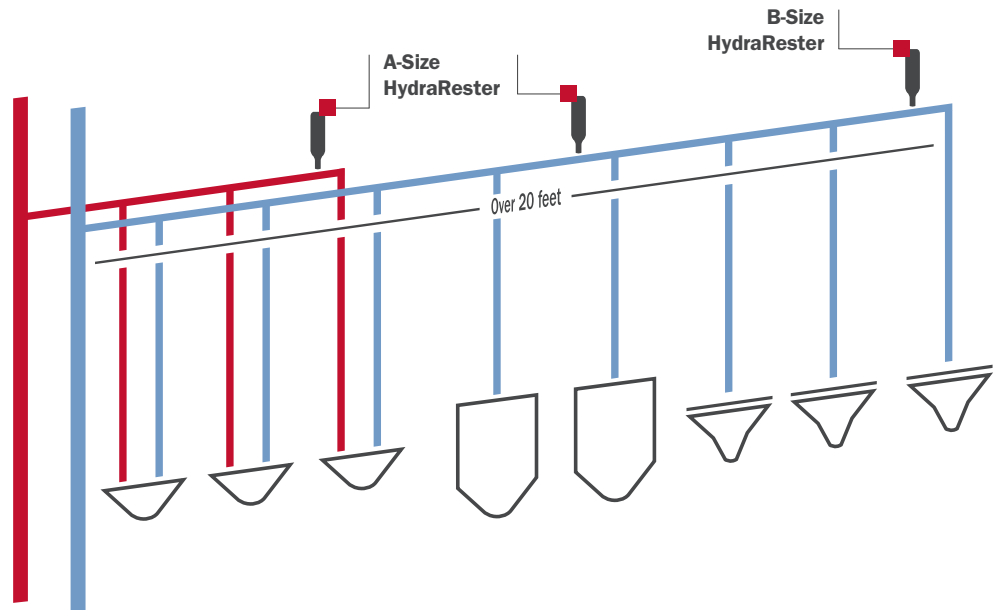

Cold Water Right
 2 Water Closets= 16 FU
 2 Urinal= 8 FU
 TOTAL= 24 FU
 Requirement= B-Size

Cold Water Left
 3 Lavs= 4 1/2 FU
 Requirement= A-Size

Hot Water
 3 Lavs= 4 1/2 FU
 Requirement= A-Size

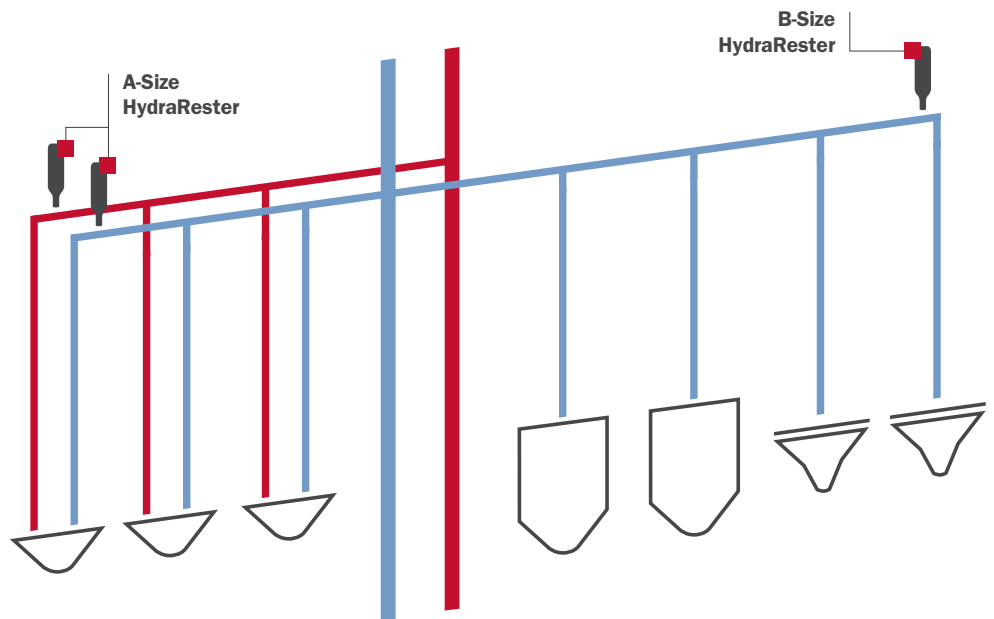

Cold Water

2 Water Closets= 16 FU
 2 Urinal= 8 FU
 2 Lavs= 3 FU
 TOTAL= 27 FU
 Requirement= B-Size

Hot Water

2 Lavs= 3 FU
 Requirement= A-Size

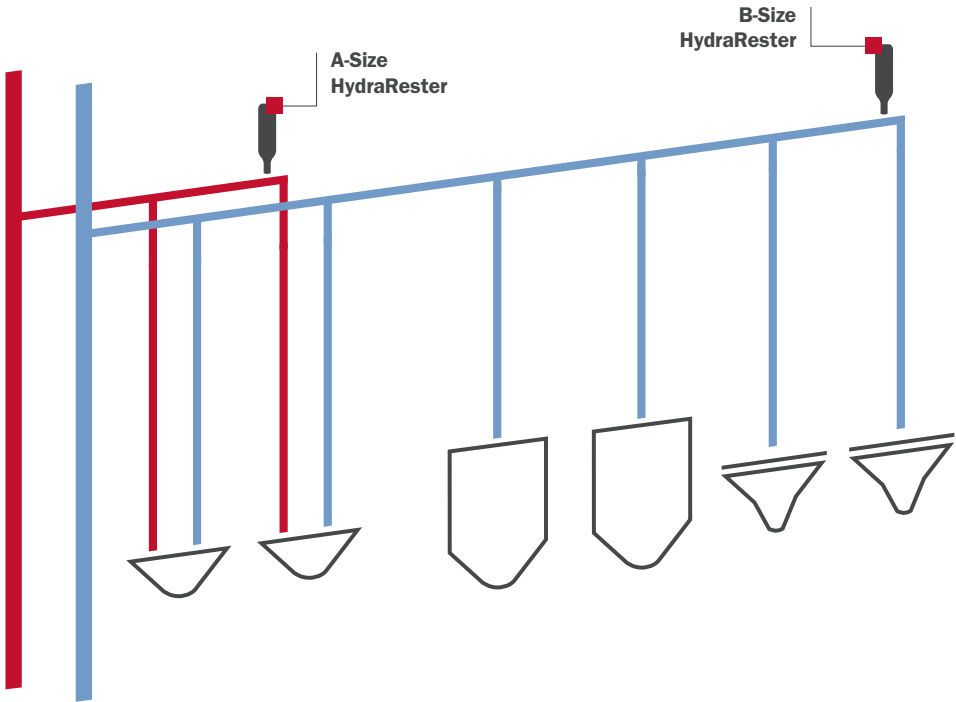

Cold Water Right

2 Water Closets= 16 FU
 2 Urinal= 8 FU
 TOTAL= 24 FU
 Requirement= B-Size

Cold Water

3 Lavs= 4 1/2 FU
 Requirement= A-Size

Hot Water

3 Lavs= 4 1/2 FU
 Requirement= A-Size

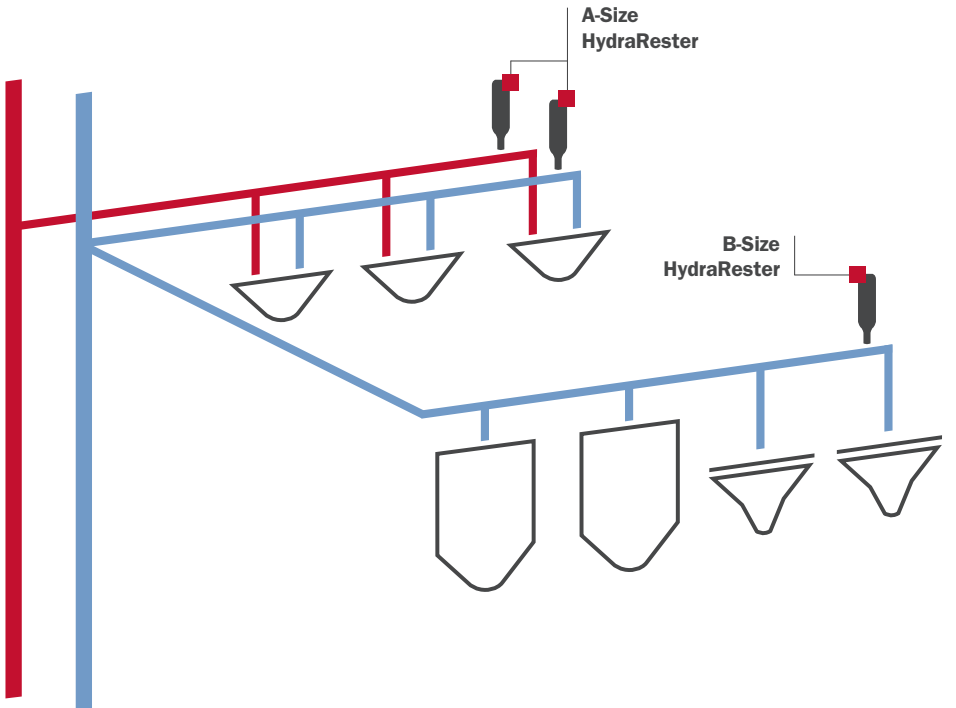

MegaRester

Industrial Applications. Perfect for industrial equipment, commercial laundry equipment, food-processing, irrigation and waste-treatment systems.

Choice of Tube Wall Material. Available in copper or 316 stainless steel for any application.

Adjustable Onsite. Liquid-filled gauge and air filler valve for jobsite charging.

Customized Per Application. Fit your specific job requirements. Call Sioux Chief for custom, expert sizing and placement recommendations.

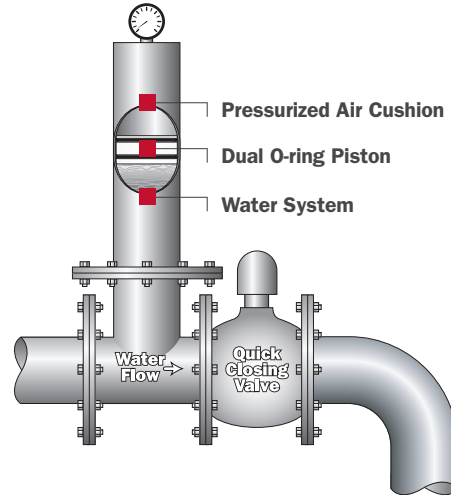

COPPER

- Dual o-ring piston lubricated with Dow 111 FDA-approved silicone compound
- Cast brass flange or wrought copper male thread fitting with lead-free solder joints
- 4" nominal Type L copper tube barrel
- 600-lb. (40-bar) liquid filled gauge
- Factory air charge

STAINLESS STEEL

- Dual O-ring piston lubricated with Dow 111 FDA-approved silicone compound
- Welded stainless steel flange or male thread fitting
- 4.25" O.D. 316 stainless steel barrel
- 600 lb. (40 bar) liquid filled gauge
- Factory air charge

ITEM NO.	CONNECTION SIZE AND TYPE	VOLUME (IN ³)	HEIGHT (IN)	PKG.	MIN. QTY.	CASE QTY.
COPPER						
658-1503	3" MIP (ANSI B1.20.1)	150	23.25	B	1	1
658-2002	2" MIP (ANSI B1.20.1)	200	29.25	B	1	1
658-2004	4" MIP (ANSI B1.20.1)	200	24.50	B	1	1
658-4004	4" MIP (ANSI B1.20.1)	400	40.50	B	1	1
658-4004F2	4" Class 150 Flange (ANSI B16.24)	400	39.75	B	1	1
STAINLESS STEEL						
658S2002	2" MIP (ANSI B1.20.1)	200	24.25	B	1	1
658S2004F2	4" Class 150 Flange (ANSI B16.24)	200	22.87	B	1	1
658S4004F2	4" Class 150 Flange (ANSI B16.24)	400	38.87	B	1	1

Packaging Codes || B: bulk C: cut-case box *:individually bar coded



Sioux Chief vs. the Competition

Sioux Chief's superior design and machining processes have allowed plumbers and contractors to bid jobs with confidence, knowing the product not only wins on paper, it performs in the field where it counts.



<i>Sioux Chief</i>	<i>Josam</i>	<i>J.R. Smith</i>	<i>PPP</i>	<i>Wade</i>	<i>Watts</i>	<i>Wilkins</i>	<i>Zurn</i>	YES	NO	
■	■	■	■	■	■	■	■	■	■	Permanent Gas Charge
■	■	■	■	■	■	■	■	■	■	Dual O-ring or Better
■	■	■	■	■	■	■	■	■	■	ASSE 1010 Certified AA-F
■	■	■	■	■	■	■	■	■	■	O Chamber Seams



Cross Reference Guide

MANUFACTURER (Trade Name)	AA	A	B	C	D	E	F
SIOUX CHIEF (HydraRester)	660 series	652-A	653-B	654-C	655-D	656-E	657-F
JOSAM (Absorbotron)	N/A	75001	75002	75003	75004	75005	75006
J.R. SMITH (Hydrotrol)	N/A	5005	5010	5020	5030	5040	5050
PPP (MM series, SC series)	MM-500 series	SC500	SC750	SC1000	SC1250	SC1500	SC2000
TYLER/WADE (Shokstop)	N/A	W-5	W-10	W-20	W-50	W-75	W-100
WATTS (AA = 05 series, A-F = 15 series)	05 series	15 - ½"	15 - ¾"	15 - 1"	15 - 1 ¼"	15 - 1 ½"	15 - 2"
ZURN (Shocktrol, Z-1700 series)	N/A	100	200	300	400	500	600



WARNING
This laser is a Class II laser. It emits a visible laser beam that may cause eye injury. Do not stare into the beam. Do not use reflective surfaces. Do not use flammable materials. Do not use in a confined space. Do not use in a hazardous environment. Do not use in a flammable atmosphere. Do not use in a explosive atmosphere. Do not use in a high pressure atmosphere. Do not use in a high temperature atmosphere. Do not use in a high humidity atmosphere. Do not use in a high vibration atmosphere. Do not use in a high magnetic field atmosphere. Do not use in a high electric field atmosphere. Do not use in a high radio frequency atmosphere. Do not use in a high electromagnetic interference atmosphere. Do not use in a high electromagnetic compatibility atmosphere. Do not use in a high electromagnetic compatibility atmosphere. Do not use in a high electromagnetic compatibility atmosphere.

Mini-Resistor
44



Appendix

» Certifications, Articles, Reports and Specifications

This section has technical information on ASSE Certification, case studies of water hammer situations, as well as engineer status reports. In addition, specification sheets for all Sioux Chief arresters are included.

What it Means to get Certified

In order for an arrester manufacturer to get their arrester products fully certified by ASSE, they must first go through rigorous performance and endurance testing by an accredited test lab. Each arrester model must pass this 10,000 cycle test. Once the testing is successfully completed, the test results are then reviewed by the ASSE Seal Board Committee before a full certification is issued. In addition to all of this testing and certification, ASSE performs annual factory audits to insure continuous quality with all arrester production. Annual Renewal Certificates are then issued for manufacturers that properly fulfill their ASSE requirements.



4.1 Certifications

ASSE International
18927 Hickory Creek Drive, Suite 220
Mokena, IL 60448
Phone: (708) 995-3019
<http://www.asse-plumbing.org>
Email: stan@asse-plumbing.org

SEAL LISTING CERTIFICATE OF RENEWAL

DATE: 03/17/2014

COMPANY: Sioux Chief Mfg. Co. Inc.
24110 S Peculiar Dr
PO Box 397
Peculiar MO 64078-9247

ASSE STANDARD NUMBER: 1010
SEAL NUMBER: 800

MODELS:
652 - 1/2 inch - With options of: A (MIP), AS (Sweat), AC (CPVC), AX (PEX)
653 - 3/4 inch - With options of: B (MIP), BS (Sweat), BC (CPVC), BX (PEX)
654 - 1 inch - With options of: C (MIP), CS (Sweat), CC (CPVC), CX (PEX)
655 - 1 inch - With options of: D (MIP), DS (Sweat)
656 - 1 inch - With options of: E (MIP), ES (Sweat)
657 - 1 inch - With options of: F (MIP), FS (Sweat)

These products have been authorized to display the ASSE Seal until 06/30/2015

Any changes or modifications to the above referenced products, without the prior written consent from the Seal Control Board, shall be cause for suspension.

ASSE Seal Control Board Chairman

Prevention Rather Than Cure

ASSEDatabase\seal_cert_renewal
SLCR - 03-4-2014

ASSE International
18927 Hickory Creek Drive, Suite 220
Mokena, IL 60448
Phone: (708) 995-3019
<http://www.asse-plumbing.org>
Email: stan@asse-plumbing.org

SEAL LISTING CERTIFICATE OF RENEWAL

DATE: 11/13/2013

These products have been authorized to display the ASSE Seal until 02/28/2015

COMPANY: Sioux Chief Mfg. Co. Inc.
ASSE STANDARD NUMBER: 1010
SEAL NUMBER: 988

MODELS:
660-2, 660-G2 - AA - straight adapter connection only
660-H - 3/4" MHT x 3/4" PHT - Type AA
660-LV, 660-T, 660-TC1, 660-TX1, 660-TC0, 660-TX2, 660-V2B, 660-TA2B, 660-TW2, 660-TK, 660-TR1, 660-TR, 660-X2B, 660-G2, 660-GLV,
660-GT, 660-GTA2B, 660-GTC0, 660-GTC1, 660-GTR, 660-CTR1, 660-GTW2, 660-GTX1, 660-GTX2 - 1/4" male thread - Type AA
660-LVS - 5/8" Female Thread - Type AA
660-SB - 1/2" Sweat - Type AA
660-T22 - 1/2" Sweat - Type T - Type T
660-V2B - 1/2" CPVC - Type AA

Any changes or modifications to the above referenced products, without the prior written consent from the Seal Control Board, shall be cause for suspension.

Prevention Rather Than Cure

ASSEDatabase\seal_cert_renewal
SLCR - 03-27-2009

American Society of Sanitary Engineering
FOR PLUMBING AND SANITARY RESEARCH

This certifies that **Sioux Chief Manufacturing Co.** is authorized to display the ASSE Seal on its

Product **Water Hammer Arrester**

Model **652A, 653B, 654C, 655D, 656E, 657F, 660SB, 660-T22**

Description _____

File #: **800**

in the manner and under the conditions stated herein and any supplemental description sheets, in accordance with

ASSE Standard Number **1010-1996(ANSI-1998)** Testing Laboratory **SGS US Testing**

This authorization is issued for one (1) year from date hereon and is renewable annually for a period of five (5) years.

The ASSE Seal (Conformity Assessment Mark) displayed on a product indicates that the product has been tested at an ASSE approved testing laboratory, and is found to be in compliance with an adopted ASSE standard that the manufacturers and this Society have found practical, workable and acceptable.

The American Society of Sanitary Engineering has created the Seal Control Program to encourage improvements in plumbing products and systems in the interests of greater protection of public health and safety.



Date June 1, 2000

Chairman *Richard Panger*
ASSE Seal Control Board

AMERICAN SOCIETY OF SANITARY ENGINEERING
For Plumbing and Sanitary Research



This certifies that **Sioux Chief** is authorized to display the A.S.S.E Seal on its

Product Water Hammer Arrester

Model 660-2

Description AA size

in the manner and under the conditions stated herein and any supplemental description sheets, in accordance with

A.S.S.E. Standard Number 1010-1996 Testing Laboratory SGS US Testing Company

This authorization is issued for one (1) year from date hereon and is renewable annually for a period of five (5) years.

The A.S.S.E. Seal displayed on a product indicates that the product has been tested at an A.S.S.E. approved testing lab and found to be in compliance with an adopted A.S.S.E. standard that the manufacturers and this Society have found practical, workable and acceptable.

The American Society of Sanitary Engineering has created the Seal Control Program to encourage improvements in plumbing products and systems in the interests of greater protection of public health and safety.

Date October 14, 1996

Chairman *Richard Panger*
A.S.S.E. Seal Control Board

Case Study

WATER HAMMER FROM A DIFFERENT ANGLE

By Michael Meagher
August 1, 2009

A recent case study involved a severe water hammer problem in a fountain refill piping system at the City Hall Building in Grandview, MO (a suburb of Kansas City). The system consisted of a long run of 1-1/2" copper tubing leading up to a solenoid valve in a utility room within the city hall building itself. On the non-pressure side of the valve, 1-1/2" PVC piping exited the building underground and ran 100 feet to the fountain pool outside. A float switch in the pool controlled the solenoid valve back in the utility room. No other valves, before or after, were being operated. Each time this valve cycled off, a large bang emanated from the valve and echoed throughout the building.

Previously, the city hall maintenance engineer had a water hammer arrester installed on the pressure side of the valve. Proper installation requirements for sizing and placement of the arrester were followed. However, the arrester seemed to have little effect on the loud hammer upon each valve closure. Eventually, the destructive water hammer created a large crack in the PVC threaded adapter on the non-pressure line, six feet downstream of the valve, causing a noticeable leak inside the utility room.

A local plumbing contractor, Morgan-Miller Plumbing, was then called in to analyze the situation and fix the problem. At first, this fitting failure was a bit puzzling. Under normal water hammer situations, one would

naturally expect the failure to occur on the pressure side of the valve. That's why arresters are usually required on the pressure side of valves. But in this case, the arrester was found to be working just fine, with no significant pressure surges upstream of the valve. This failure was definitely on the downstream side of the valve.

The joint leak in the fountain refill line seemed to be a small steady drip most of the time. However, at the precise moment immediately following valve closure, a very high-pressure water spray was observed coming from the cracked fitting, just for a split second, accompanied by a loud bang. This momentary high-pressure spray on the non-pressure line was the telltale clue confirming exactly what the problem was. A quick high-pressure surge on the downstream side of the valve after valve closure could only be caused by one thing: a vaporous cavitation.

Cavitation occurs when water pressure is lowered below its vapor pressure. Water will literally flash or vaporize, forming small entrained bubbles (water vapor in its gaseous

state) in the line directly after the quick-closing valve. In situations like the City Hall piping system, three factors play a role in this cavitation; high velocity, pipe length and quick valve closure. When the valve closes, the momentum of flow pulls a vacuum on the area immediately after the valve, constricting the pipe. If the velocity is high enough, the water column can cavitate.



If you have ever done any pressure surge calculations, you may recognize the same three factors that cause water hammer on the pressure side of the valve are the same factors that can cause cavitation on the non-pressure side. That's not a coincidence. The momentum energy in the flowing water is equal on both sides of the valve. When a valve is installed in the middle of the piping run rather than the end, the non-pressure run will contain a significant amount of kinetic energy as well.

It is important to note that water temperature is certainly an essential factor in the physics of cavitation and the vapor pressure of water. Hot water will flash to vapor easier than will cold water. However, in this City Hall case, and in most other plumbing-related cases studied, the cavitation problems developed in an ordinary cold-water piping system where temperature control or temperature change was not a factor.

The damaging effects of cavitation occur when momentum of the flowing water is dissipated and the entrained vapor bubbles collapse back to their liquid state. The rest of the non-pressure water column is then drawn back to fill this void at a super high velocity. An extremely high-pressure surge (water hammer) results after the high velocity water column slams into the valve (Figure 2). In lab tests of similar piping arrangements, pressure surges caused by cavitation have been measured up to 1,100 psig.

A water hammer arrester installed on the pressure side of the valve works great to control the energy in the water column upstream of the

valve, but does nothing to prevent the cavitation and severe pressure surge on the downstream side. Even installing a second water hammer arrester after the valve will not help, because conventional arresters are not designed to prevent this specific problem or to absorb the resultant shock.

A unique product called a vacuum arrester was introduced a few years ago to control this problem of cavitation. Similar in design to a piston-style water hammer arrester, the vacuum arrester temporarily breaks the vacuum that is pulled just beyond the closing valve. The operation of a vacuum arrester is functionally opposite of a conventional water hammer arrester.

The vacuum arrester has a much lower charge and the piston starts high in the barrel and travels down. When installed directly after the valve, the air in the vacuum arrester will expand to allow a more gradual stop of the water flow, and, thus, prevent cavitation.

In the Grandview City Hall piping system, the contractor correctly diagnosed the problem, installed a vacuum arrester and repaired the cracked fitting. Once a vacuum arrester was installed in addition to the water hammer arrester, the fountain system operated safely and quietly without any damaging pressure surges on either the pressure side or non-pressure side of the valve.

Unlike common atmospheric vacuum breakers, a vacuum arrester employs a contained pressure chamber that will never spit or leak water, nor will it

ever allow air to be introduced into the water line. However, a vacuum arrester is not a traditional backflow prevention device and should not be substituted for one in other applications where those devices are required by code.

Fig 1: Shut-off valve at END of long pipe run

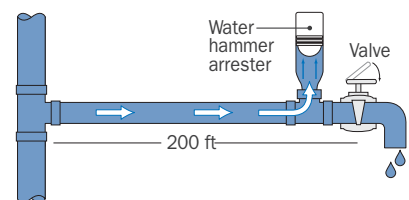

Fig 2: Shut-off valve in MIDDLE of long pipe run

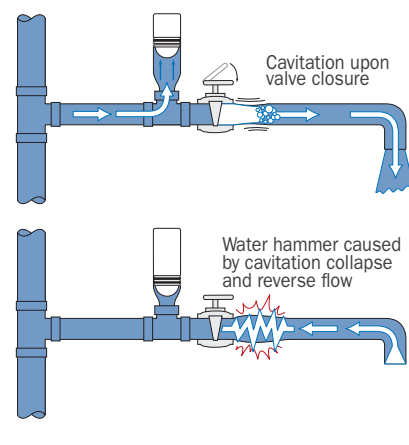
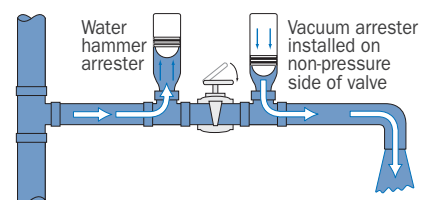

Fig 3: Shut-off valve in MIDDLE of long pipe run



RESIDENTIAL & LIGHT COMMERCIAL WATER HAMMER CONTROL

AA-size piston-type arresters provide the solution to preventing water hammer in both residential and commercial applications.

Excerpt from April 2002 PM Engineer Magazine.

AA-size water hammer arresters are now sweeping the country as the permanent and affordable solution to that age-old problem of banging pipes and system damage caused by water hammer pressure surges, but this progress has been a long time in the making. Like many things in our industry, change doesn't happen overnight. Process and product innovation, industry education, along with new product standards and codes, have led the way.

In the 1980s, several arrester manufacturers offered a better alternative to plain air chambers when they introduced their single-fixture size arresters to the marketplace. At first, the use of these new arresters was somewhat limited due to the lack of official recognition at the codes and standards level. That all changed in 1996 when ASSE officially added the single-fixture AA-size category to the other six A through F arrester sizes in their ASSE 1010 Standard. Within 12 months, no less than three manufacturers had received ASSE certification on their compact and more affordable AA sizes, or double-A arresters, as they are now called.

Since then, the installation of AA arresters to control water hammer has grown tremendously throughout the country. Code officials in many states see the AA arrester as a very simple, very feasible way to address this water hammer control issue they've been struggling with for years. And not surprisingly, a large number of plumbing contractors report they are installing AA arresters even on applications where they are not required by code. They say arresters add quality to their jobs and help reduce callbacks.

The AA size is considered a single-fixture arrester and it is designed for installation on a plumbing faucet or fixture at the point of use. In other words, one AA arrester should be placed on both the hot and cold lines as close as possible to each culprit valve or faucet that causes hammer. The most common applications for AA arresters are on the water lines serving washing machines,

dishwashers, and tub/shower valves. Historically, these areas have caused the most problems or have been the areas reported most often as having water hammer. At the very least, these three applications should always have AA arresters installed during new construction. Other possible applications on new construction or retrofit could be just about any other faucet or fixture in the plumbing system if water hammer is apparent, such as kitchen or lav faucets, water closets, and even ice maker valves.

A common myth is that one large arrester centrally located will control hammer throughout the piping system. In reality, this does little or nothing to control hammer. The arrester loses its effectiveness the farther away from the valve it is installed. Installation within six feet of the valve may work fine. However, when the arrester is installed 20 or 30 feet upstream, it has little effect. Arresters work like shock absorbers

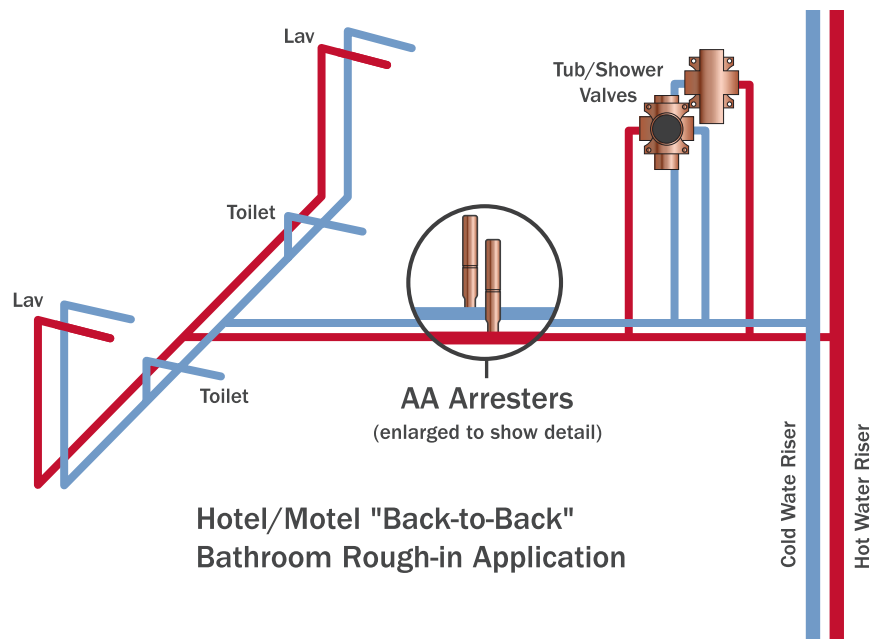

on a car. Your car has four wheels, so you need no less than four shocks, one placed at each wheel (point of use). Imagine the damage and abuse your car would take if it didn't have four properly placed shock absorbers. Your plumbing system is subject to the same type of abuse without proper arrester installation and placement.

Another question often asked is whether arresters are necessary on plastic tubing. Water hammer is a concern regardless of piping material, metal or plastic. It may be true that plastic tube does not seem to transmit as much noise as copper, but the energy from the flowing water is still there. It has to go somewhere. As a matter of fact, plastic tubing has a slightly smaller inner diameter compared to the same nominal size copper, so the flowing water has a higher velocity, which means even more energy to be absorbed when the flow is stopped. Upon valve closure, plastic tubing expands minutely which does absorb a small amount of this energy, but water hammer can still occur at flow rates of three or four gallons per minute. Many contractors install arresters on plastic tubing systems to alleviate the tubing and joints of any undue stress and strain, rather than the plastic system taking the full brunt of the pressure surge all by itself.

Even though the AA size is often thought of as residential, it can certainly be specified for commercial projects as well. Its ASSE listing and fixture-unit rating of 4 makes it ideal for sizing and specification on projects such as hotels, motels, or multi-family. For example, a common mistake in

hotel arrester sizing and placement is specifying one large multi-fixture arrester centrally located between several rooms. Worse yet, sometimes one arrester is specified to cover an entire floor. No matter how large the arrester is, the centrally located placement will not suffice. Large multi-fixture arresters work great on a commercial rest room with a bank of fixtures all on the same header; but when the branch lines go off in many directions, like in a hotel, smaller arresters placed at the point of use would be a better solution.

To insure proper water hammer control on this type of project, specify a pair of AA arresters at each tub/shower valve (a common water hammer culprit). For the typical hotel back-to-back bathroom configuration, one pair of AAs will suffice for both valves (see below) since the chance of simultaneous shut-off of both valves is almost nil.

The product innovation of AA arresters has created dramatic effects at the code level as well. In the past five years, there have been major code revisions concerning water hammer control. In 1996, IAPMO published its UPC Installation Standard IS 20-96 for CPVC piping systems, which required arresters on all solenoid valves supplied with CPVC tubing. When this was first published, the UPC had yet to require arresters on other piping materials.

Then in 1997, IAPMO added Section 609.10 Water Hammer Control to the main body of the Uniform Plumbing Code, and then updated it in the UPC-2000 revision. This section calls out the requirement of listed mechanical

devices on all quick closing valves in all potable water systems. It does not make exceptions for any piping material CPVC, copper, PEX or otherwise. Because of this new water hammer control requirement covering all piping systems, including CPVC, the secondary reference to water hammer control in the CPVC Installation Standard was deleted in 1998, evidently due to redundancy.

The International Plumbing Code (IPC-2000) also has a very similar requirement for water hammer control in its Section 604.9. AA arresters conforming to the ASSE 1010 Standard fulfill the product requirements of this code as well. IPC states that arresters should be installed per manufacturer's instructions. Therefore, if the arrester manufacturer states its arrester can be installed without access, then no access panels are required. Several states are already enforcing this section, and other states are planning to do so this year.

4.3 Arrester Installations

HydraRester

Arrester Installations

Partial Listing

Location	Name of Job	Units
Correctional Facilities		
Calipatria, CA	Northern Imperial County State Prison	54
Chowchilla, CA	Madera State Prison	1132
Coalinga, CA	Coalinga State Prison	480
Corcoran, CA	Corcoran Prison	188
Crescent City, CA	Del Norte California State Prison	813
Delano, CA	California State Prison	970
Oroville, CA	F.M. Booth Butte County Jail	44
San Mateo, CA	West County Detention Center	76
Santa Paula, CA	Ventura County Jail	415
Wasco, CA	State Prison	1012
Denver, CO	Women's Correction Facility	300
Niantic, CT	Womens Institution	500
Gainesville, FL	Alachua County Detention Center	160
Miami, FL	South Florida Reception/Correction Center	102
Orlando, FL	Central Florida Reception/Correction Center	98
Thomasville, GA	Thomas County Jail	138
Decatur, GA	DeKalb County Jail	465
Ina, IL	Rend Lake Correctional Center	750
Harrisburg, IL	Saline County Jail	160
Peoria, IL	Sheridan, Canton—Cell Houses	732
Kokomo, IN	Howard County Prison	322
Noblesville, IN	Hamilton County Juvenile Detention Center	15
El Dorado, KS	El Dorado Maximum Security Prison	160
Ellsworth, KS	Ellsworth Correctional Facility	161
Emporia, KS	Lyons County Law Enforcement Center	50
Lansing, KS	Kansas State Prison	118
Larned, KS	Larned State Correctional Facility Hospital	46
Wichita, KS	Sedgewick County Jail	526
Manchester, KY	Federal Correctional Institute	559
Warren, ME	Maine State Prison—Minimum Security	165
Baraga, MI	Baraga Correctional Facility	245
Greene County, MS	Southern Mississippi Correctional Facility	212
Monrovia, NY	New York State Maximum Security Facility	193
New York, NY	Metro Jefferson Correctional Facility	288
Portland, OR	Donald E. Long Juvenile Justice Center	128
Allenwood, PA	Allenwood Correction Center	340
Pittsburgh, PA	Allegheny County Jail	2000
Dauphin, PA	Dauphin County Prison	189
Waynesburg, PA	Green County Jail	665
Ridgeland, SC	Ridgeland Prison	126
Turbeville, SC	Turbeville Prison	208
Abilene, TX	French Robertson Unit-Texas Dept.	933
Amarillo, TX	Amarillo Prison	992
Childress, TX	Childress Prison	60
Diboll, TX	County Detention Center	83
Hondo, TX	Substance Abuse Treatment Facility	121
Lubbock, TX	TDCJ Brownfield Prison	149
Pampa, TX	Gray County Jail Addition	30
Texarkana, TX	Bowie County Jail	55
San Diego, TX	Substance Abuse Treatment Facility	103
Waco, TX	McLennan County Jail	76
Roanoke, VA	Roanoke City Jail	30
Portsmouth, VA	Deerfield Correction Center	34
Kenosha, WI	Racine Correctional Institute	35
Oshkosh, WI	Oshkosh Correctional Center	427
Medical Facilities		
Tuscaloosa, AL	Druid City Hospital	235
Atascadero, CA	Atascadero State Hospital	100
Bakersfield, CA	Bakersfield Memorial Hospital	230

HydraRester**Arrester Installations**

Partial Listing

Location	Name of Job	Units
Rancho Mirage, CA	Eisenhower Medical Center	55
Tustin, CA	Kaiser Hospital	124
Healdsburg, CA	Healdsburg General Hospital	20
Fresno, CA	Kaiser Hospital	477
Porterville, CA	Sierra View Hospital	90
New Britain, CT	New Britain Hospital	115
Orlando, FL	University Medical Center	50
Kissimmee, FL	Florida Hospital Addition	73
Hull, IA	Flyod Hospital	20
Coeur D'Alene, ID	Kootenai Medical Center	20
Coeur D'Alene, ID	New State Hospital	115
Bangor, ME	Eastern Maine Medical Center(MRI Bldg.)	19
Damariscotta, ME	Miles Hospital	43
Crow Agency, MT	Crow Agency Hospital	80
Greenville, NC	Pitt County Hospital	190
Winston-Salem, NC	Clinical Service Building	750
Rocky Mount, NC	Rocky Mount Hospital	48
Durham, NC	VA Medical Center	50
Raleigh, NC	UNC Women & Children's Hospital	582
Raleigh, NC	Wake Medical Center	150
Lincoln, NE	Bryan Memorial Hospital Outpatient Building	165
Albuquerque, NM	Loveless Multi-Practice Hospital	40
Tioga, NY	Tioga Hospital / Nursing Home	111
Utica, NY	Slocum Dickson Medical Clinic	200
Columbus, OH	Riverside Hospital	570
Columbus, OH	Correction Medical Center	88
Lawton, OK	VA Outpatient Center	92
Altoona, PA	Altoona Hospital	250
Pittsburgh, PA	West Penn Hospital	121
Greenwood, SC	Self Memorial Hospital	89
Bristol, TN	Bristol Regional Medical Center	240
Greenville, TN	Laughlin Hospital	200
Nashville, TN	Centennial Medical Center	285
Bonham, TX	VA Hospital	190
Lubbock, TX	Methodist Hospital	48
Houston, TX	Cypress Fair Womens Medical Center	76
Houston, TX	Kingwood Hospital	123
Tyler, TX	East Texas Medical Center	95
Suffolk, VA	Lakeview Medical Center	32
Norfolk, VA	Childrens Hospital	215
Fort Lewis, WA	Maddigan VA Hospital	398
Milwaukee, WI	Milwaukee City Medical Complex	32
Milwaukee, WI	Childrens Hospital of Wisconsin	350
Charleston, WV	CAMC Hospital	156
Schools		
Pomona, CA	Pomona College	51
New Britain, CT	Central Connecticut State University	145
Palm Beach Garden, FL	Eissey Theatre, Palm Beach Comm. College	20
Atlanta, GA	Georgia Industrial Institute	146
Atlanta, GA	University Apartments (96 Olympics)	410
Iowa City, IA	Hillcrest Dormitory	96
Pekin, IL	CB Smith School	50
Bloomington, IL	Indiana University- Sports and Rec Building	48
Bloomington, IN	Monroe County High School	50
Indianapolis, IN	Center Grove High School	52
Indianapolis, IN	North Central High School	36
Indianapolis, IN	Indianapolis Public School 14, #269	61
Jasper, IN	Ireland Elementary	46
Muncee, IN	Burriss School	50

4.3 Arrester Installations

HydraRester

Arrester Installations

Partial Listing

Location	Name of Job	Units
Las Vegas, NV	Cheyenne High School	34
Las Vegas, NV	Memorial High School	34
Greensboro, NC	NCAT University Dorm Renovation	105
Brooklyn, NY	Brooklyn Occupational Training Center	60
Brooklyn, NY	Public School IS# 171	25
Buffalo, NY	University of Buffalo Housing	360
Oxford, OH	University Commons	128
Guthrie, OK	Guthrie Elementary School	31
Norman, OK	Oklahoma University Energy Center	72
Altoona, PA	Blairsville, High School	30
Erie, PA	Erie County VOTEC	35
Landisville, PA	Hemsfield High School	94
Moscow, PA	Moscow Elementary School	40
Saint Matthews, SC	John Ford Middle School	68
Aiken, SC	Aiken High School Gym	43
Highland Park, TX	Highland Park Middle School	50
Houston, TX	Spring Branch Elementary School	100
College Station, TX	New Junior High School	43
Grapevine, TX	Grapevine/Colleyville ISD Elementary School	37
Lubbock, TX	Texas Tech. Univ. Health Sciences Building	96
Leesburg, VA	Lowden County Schools	78
Midlothian, VA	Bailey's Bridge High School	95
Sopkane, WA	Chase Middle School	48
Spokane, WA	Hamblen School	140
Antigo, WI	Antigo High School	25
Madison, WI	Beloit Memorial High School	32
	U.S. Military	
Fort Ord, CA	Military Housing	1142
Fresno, CA	Lemoore Naval Station	840
Twenty-Nine Palms, CA	U.S. Marine Corp Base	584
Denver, CO	Lowry AFB – Military Housing	368
Ft. Walton Beach, FL	Eglin AFB – Military Housing	505
Ft. Walton Beach, FL	Hurlburt Field – Military Housing	482
Mayport, FL	Rebault Bay Village Military Housing	1232
Panama City, FL	Coastal Dining Facility	40
Sorrento, FL	Patrick Air Force Base – Housing	250
Fort Benning, GA	Military Housing	456
St. Mary's, GA	King's Bay Submarine Base	164
Moanalua, HI	Military Base	1292
Pearl City, HI	Military Base	780
Schofield, HI	Military Housing	148
Glenview, IL	Glenview Naval Airbase	400
Fort Riley, KS	Military Housing	50
Bossier, LA	Barstow AFB – Military Housing	100
Camp Lejeune, NC	Bachelors Enlisted Quarters	426
Fort Bragg, NC	Military Housing	1156
Fort Bragg, NC	Military Housing (Barracks)	238
Fort Bragg, NC	Military Housing	528
Eatontown, NJ	Fort Monmouth Army Military Base	58
Clovis, NM	Cannon AFB Dorm	35
Holman, NM	Holman AFB – Enlisted Housing	740
Watertown, NY	Fort Drum – Military Housing	182
Altus, OK	Altus AFB – Military Housing	426
Fort Sill, OK	Military Housing	671
Fort Sill, OK	Barracks Renovation	264
Columbus, OH	DCSC Operation Center	272
Mechanicsburg, PA	Naval Control Parts Center	61
Newport, RI	Naval Education & Training Center	660
Box Elder, SD	Ellsworth AFB – Military Housing	1620

HydraRester**Arrester Installations**

Partial Listing

Location	Name of Job	Units
San Antonio, TX	Military Housing	284
Fort Hood, TX	Military Housing	176
Fort Hood, TX	Barracks Renovation	176
Shepherd, TX	Enlisted Dormitory	762
Fort Belvoir, VA	Army Military Housing	1328
Fort Belvoir, VA	Army Military Housing	79
Williamsburg, VA	Dormitory Training Facility, Camp Perry	61
Woodbridge, VA	Navy Apartments Village #1 and #3	706
McChord, WA	McChord AFB	300
Yakima, WA	Military Housing	400
Federal/State Government		
Fairbanks, AK	HUD 40	80
Novato, CA	Fire Station	30
Redwood Valley, CA	Northern Circle Indian Housing Authority	50
Augusta, GA	Delta Homes (HUD)	250
Cartersville, GA	Cartersville Housing Authority (HUD)	150
Marietta, GA	Marietta Housing Authority (HUD)	130
Honolulu, HI	Helemano Government Housing Project	340
Wichita, KS	Kansas State Office Building	70
Landover, MD	Sommerfield Housing Project	2021
Bath, ME	West Bath District Court House	17
St. Louis, MO	Convention Center Addition	57
Box Eldr, MT	Indian Housing Authority	80
Sparks, NV	Pyramid Lake Indian Housing Authority	70
Pittsburgh, PA	Crowley Manor Housing Project (HUD)	330
Charleston, SC	Charleston Ship Yard (Public Works Facility)	35
Coyce, SC	U. S. Postal Office	55
Effingham, SC	Florence Civic Center	460
Hotel/Motel		
Ocean Springs, AL	Sleep Inn Hotel	65
Boynton Beach, FL	Marriott Hotel	100
Ft. Lauderdale, FL	Comfort Suites Hotel	29
Kissimmee, FL	All-Star Resort	1296
Lake Buena Vista, FL	Magnolia Bend Disney Hotel	528
Orlando, FL	Clarion Hotel	338
Orlando, FL	Comfort Suites Hotel	120
Orlando, FL	Omni Rosen Hotel	236
Honolulu, HI	Hapuna Beach Hotel	45
Rockfork, IL	Econo-Lodge	100
Malden, MA	Gateway Hotel	336
Lansing, MI	Quality Inn Hotel	240
Traverse City, MI	Park Place Motel	80
Branson, MO	Holiday Inn	250
Branson, MO	Seven Gables Motel	40
Branson, MO	Green Mountain Inn	35
Branson, MO	Holiday Hill Resort	48
Branson, MO	Grand Victorian Inn	60
Osage Beach, MO	Marriott Tan Tara	40
Las Vegas, NV	MGM Grand Hotel	150
Durham, NC	Hilton Hotel	92
Corning, NY	Perri's Days Inn	64
Oklahoma City, OK	Marriott Hotel	191
Myrtle Beach, SC	Beach Cove Inn Motel/Hotel	520
Hilton Head, SC	Grande Ocean Resort	40
Chesapeake, VA	Marriott Hotel	33
Ayudhya, Thailand	Krung Sri Riverside Hotel	39
Bangkok, Thailand	Amarit Watergate Hotel	47
Bangkok, Thailand	Ayothaya Thani Hotel	633
Bangkok, Thailand	Bai Yok Tower II	22

4.4 Specifications

WATER HAMMER ARRESTERS

»» 660 SERIES

MiniRester™

ITEM # SUBMITTED	_____
JOB NAME	_____
LOCATION	_____
ENGINEER	_____
CONTRACTOR	_____
PO#	_____ TAG _____

SPECIFICATION

Sioux Chief 660 Series piston-type water hammer arresters shall be required in piping systems. Water hammer arresters shall have sufficient volume of air to dissipate the calculated kinetic energy generated in the piping system. Arresters shall be effective when installed at any angle. Arresters shall be approved for installation with no access panel required. Water hammer arresters shall be ANSI/ASSE 1010 2004 certified. Arresters shall be sized and placed per manufacturer's instructions.

MATERIALS

- Arrester body:** type L copper tube (660-G2B body is 304 stainless steel)
- Piston:** poly piston with two EPDM o-rings
- Fitting:** no-lead brass or copper
- Piston lubrication:** Dow-Corning, 111 FDA approved silicone compound

WORKING LIMITS*

- Max working temperature:** 250°F
- Max working pressure:** 350 PSIG
- Burst tested:** to 1,500 PSIG

*PEX and CPVC connection specifications are limited to those called out in their respective ASTM Standards for Fittings (CPVC D2846, PEX F1807 & F1960).

INSTALLATION

- Angle:** May be installed at any angle
- Access panels:** No access panels required
- Sweat connection:** Compatible with Press Fittings or Push Fittings

SIZING & PLACEMENT

Refer to instructions on product package, catalog or website.

CERTIFICATIONS/APPROVALS

Certified by ASSE to the ANSI/ASSE 1010-2004 standard, AA size
cUPC listed to UPC and Canadian codes and standards

DIMENSIONS

	Male Thread	Male Sweat	Male CPVC	CPVC Socket	F1807 PEX	F1960 PEX	Viega PEX	Comp.
Arrester size	AA	AA	AA	AA	AA	AA	AA	AA
Overall height	3 ³ / ₈ "	6 ¹ / ₂ "	4 ¹ / ₄ "	3 ³ / ₈ "	4 ¹ / ₄ "	5 ¹ / ₄ "	5 ¹ / ₄ "	5 ¹ / ₄ "
Chamber width	7/8"	7/8"	7/8"	7/8"	7/8"	7/8"	7/8"	7/8"
Connection size	1/2"	1/2"	1/2"	1/2"	1/2"	1/2"	1/2"	1/2"
Volume (cu. in.)	1.4	1.4	1.4	1.4	1.4	1.4	1.4	1.4
Fixture units	1-4	1-4	1-4	1-4	1-4	1-4	1-4	1-4



660-G2B

660-SB

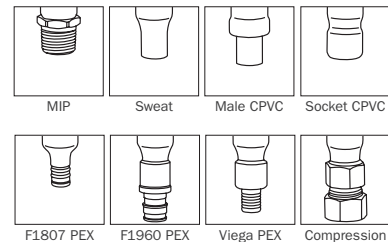
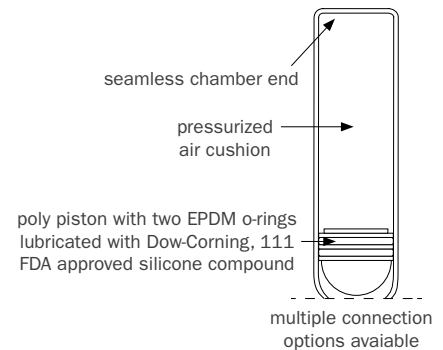

Choose Item Number

- 660-G2B = AA size, MIP
- 660-SB = AA size, sweat
- 660-V82B = AA size, male CPVC
- 660-V2B = AA size, CPVC socket
- 660-X2B = AA size, F1807 PEX
- 660-WG2B = AA size, F1960 PEX
- 660-GVPX2B = AA size, Viega PEX
- 660-GCB = AA size, compression

WATER HAMMER ARRESTERS

» 660-GTR SERIES

MiniRester™

SPECIFICATION

Sioux Chief 660-GTR piston-type water hammer arresters shall be installed where required on supply valves. Water hammer arresters shall be specifically sized and have sufficient volume of air to dissipate the calculated kinetic energy generated by closing residential or commercial faucets or valves. Arresters shall be installed on both hot and cold lines on the supply stops where applicable. Arresters shall be approved for installation with no access panel required.

MATERIALS

- Arrester body:** 304 stainless steel
- Piston:** polypropylene with two EPDM o-rings
- Tee body:** nickel-plated no-lead machined brass

WORKING LIMITS

- Max working temperature:** 250°F
- Max working pressure:** 350 PSIG
- Burst tested to:** 1,500 PSIG

INSTALLATION

Install MiniRester compression connections to supply stops and supply lines. Approved for installation with no access panels required.

CERTIFICATIONS/APPROVALS

Certified by ASSE to the ANSI/ASSE 1010-2004 standard, AA size cUPC listed to UPC and Canadian codes and standards

DIMENSIONS

	1/4" OD	3/8" OD	5/8" OD
A: overall height	4"	4"	4 1/4"
B: trunk width	2"	2"	2 1/2"

ITEM # SUBMITTED	_____
JOB NAME	_____
LOCATION	_____
ENGINEER	_____
CONTRACTOR	_____
PO#	_____ TAG _____

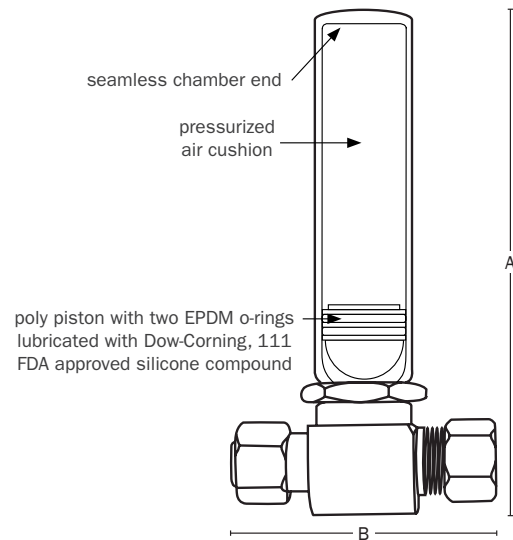

Choose Item Number

- 660-GTR0B** = 1/4" OD compression × female compression
- 660-GTR1B** = 3/8" OD compression × female compression
- 660-GTRB** = 5/8" OD compression × female compression

4.4 Specifications

WATER HAMMER ARRESTERS

» 650 SERIES

HydraRester™

SPECIFICATION

Sioux Chief 650 Series piston-type water hammer arresters shall be required in piping systems. Water hammer arresters shall have sufficient volume of air to dissipate the calculated kinetic energy generated in the piping system. Arresters shall be effective when installed at any angle. Arresters shall be approved for installation with no access panel required. Water hammer arresters shall be ANSI/ASSE 1010 2004 certified. Arresters shall be sized and placed per manufacturer's instructions.

MATERIALS

- Arrester body:** type L copper tube
- Piston:** poly piston with two EPDM o-rings
- Male thread fitting:** copper MIP thread
- Piston lubrication:** Dow-Corning, 111 FDA approved silicone compound

WORKING LIMITS*

- Max working temperature:** 250°F
- Max working pressure:** 350 PSIG
- Burst tested:** to 2,900 PSIG

* PEX and CPVC connection specifications are limited to those called out in their respective ASTM Standards for Fittings (CPVC D2846, PEX F1807).

INSTALLATION

- Angle:** May be installed at any angle
- Access panels:** No access panels required
- Sweat connection:** Compatible with Press Fittings or Push Fittings

SIZING & PLACEMENT

Refer to instructions on product package, catalog or website.

CERTIFICATIONS/APPROVALS

Certified by ASSE to the ANSI/ASSE 1010-2004 standard

DIMENSIONS

Arrester size	A	B	C	D	E	F
Overall height						
male thread	6½"	8¾"	11"	10½"	12⅝"	15½"
male sweat	8¼"	10"	12½"	11"	13½"	16"
CPVC	7½"	9½"	12"	—	—	—
PEX crimp	6½"	8¾"	11"	—	—	—
Chamber width	1⅜"	1⅜"	1⅜"	2⅜"	2⅜"	2⅜"
Connection size	½"	¾"	1"	1"	1"	1"
Volume (cu. in.)	5	7	11	20	29	36
Fixture units	1-11	12-32	33-60	61-113	114-154	155-330

ITEM # SUBMITTED _____
JOB NAME _____
LOCATION _____
ENGINEER _____
CONTRACTOR _____
PO# _____ TAG _____



652-A

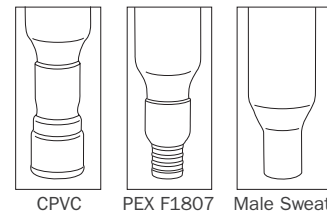
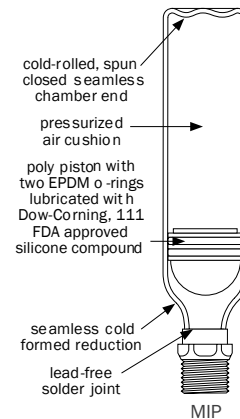

Choose Item Number

- 652-A** = A size, MIP
- 652-AS** = A size, sweat
- 652-AC** = A size, CPVC socket
- 652-AX** = A size, PEX crimp
- 653-B** = B size, MIP
- 653-BS** = B size, sweat
- 653-BC** = B size, CPVC socket
- 653-BX** = B size, PEX crimp
- 654-C** = C size, MIP
- 654-CS** = C size, sweat
- 654-CC** = C size, CPVC socket
- 654-CX** = C size, PEX crimp
- 655-D** = D size, MIP
- 655-DS** = D size, sweat
- 656-E** = E size, MIP
- 656-ES** = E size, sweat
- 657-F** = F size, MIP
- 657-FS** = F size, sweat

WATER HAMMER ARRESTERS

658 series

MegaRester™

SPECIFICATION

Sioux Chief 658 Series piston-type water hammer arresters shall be installed where required in piping systems. Water hammer arresters shall have sufficient volume of air to dissipate the calculated kinetic energy generated in the piping system. Arresters shall have a permanently sealed tube body with factory air charge, and shall be available with male thread or flanged connection. Arresters shall be sized and placed per manufacturer's instructions.

MATERIALS

arrester body

copper/brass: 4½" O.D. type L copper tube

stainless steel: 4¼" O.D. 316 stainless steel tube

male thread fitting

copper/brass: wrought copper fitting (ANSI B1.20.1),

lead-free solder joint

stainless steel: 316 stainless steel fitting (ANSI B1.20.1), welded

flange

copper/brass: cast brass flange (ANSI B16.24), lead free solder joint

stainless steel: 316 stainless steel flange (ANSI B16.24), welded

piston: Polypropylene piston, dual EPDM o-rings lubricated with Dow 111, FDA-approved silicone compound.

gauge: 600 lb. liquid-filled

WORKING LIMITS

max working temperature: 250°F

max working pressure: 350 PSIG

burst tested: to 2,900 PSIG

DIMENSIONS

	Height
658-1503	23.25"
658-2002	29.25"
658-2004	24.5"
658-4004	40.5"
658-4004F2	39.75"
658S2002	24.25"
658S2004F2	22.87"
658S4004F2	38.87"

Item # Submitted	_____
Job Name	_____
Location	_____
Engineer	_____
Contractor	_____
PO#	_____ TAG _____



658-2004



658S4004F2

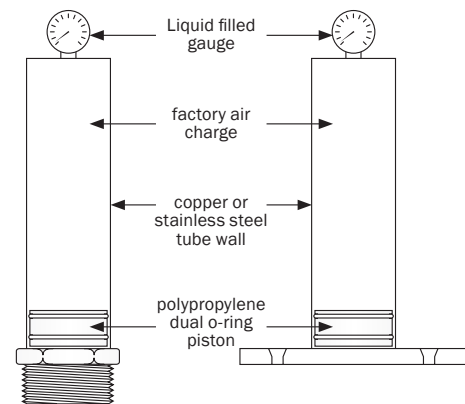

- 658-1503 copper, 3" MIP, 150 in³
- 658-2002 copper, 2" MIP, 200 in³
- 658-2004 copper, 4" MIP, 200 in³
- 658-4004 copper, 4" MIP, 400 in³
- 658-4004F2 copper, 4" flange, 400 in³

- 658S2002 stainless steel, 2" MIP, 200 in³
- 658S2004F2 stainless steel, 4" flange, 200 in³
- 658S4004F2 stainless steel, 4" flange, 400 in³

Sioux Chief

Sioux Chief Manufacturing Company • tel: 1-800-821-3944 • www.siouxchief.com • fax: 1-800-758-5950

11-08

TAKE THE FIELD.

24110 South Peculiar Drive
Peculiar, Missouri 64078
P 1.800.821.3944
F 1.800.758.5950

DISTRIBUTED BY

www.siouxchief.com

