



Instruction Sheet

102-151

RMB - Radiant Mixing Block®

SUPERSEDES: June 1, 2015

EFFECTIVE: July 30, 2015

Plant ID#: 001-3807



WARNING SYMBOL: THIS SYMBOL INDICATES THE PRESENCE OF HAZARDS WHICH CAN CAUSE SEVERE PERSONAL INJURY, SUBSTANTIAL PROPERTY DAMAGE OR EVEN DEATH IF IGNORED.

General

The Taco Radiant Mixing Block® (RMB) represents a breakthrough in the design, control and installation of radiant systems. The patented design combines a variable speed injection mixing control (RMC), injection circulator, system circulator, and air elimination into a single unit. Extremely versatile, the Radiant Mixing Block can be set up to operate as an outdoor reset control, a setpoint control or a delta T limiting control.

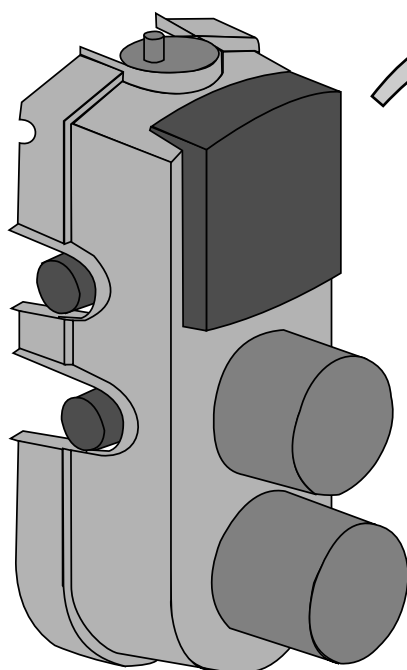

RADIANT MIXING BLOCK® (RMB)

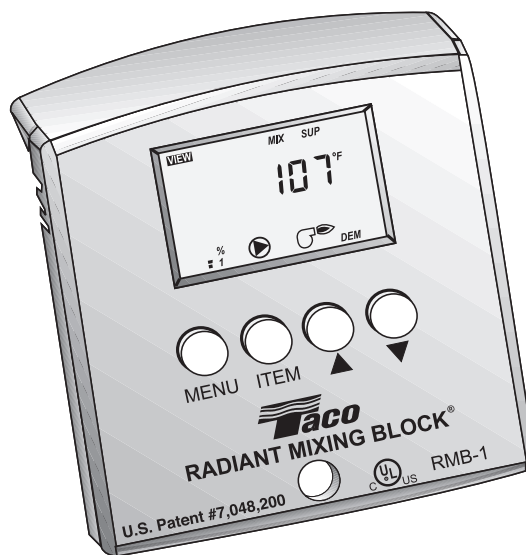
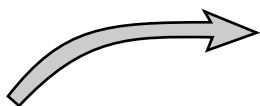

RADIANT MIXING CONTROL
U.S. Patent #7,048,200

Table of Contents

TYPICAL PIPING-----	2	SET UP OF RADIANT MIXING CONTROL -----	8
GETTING READY -----	3	DISPLAY OPERATION -----	10
APPLICATION -----	3	TROUBLE SHOOTING -----	12
DESIGN PROCEDURE -----	3	ERROR MESSAGES -----	13
INSTALLATION OF RADIANT MIXING BLOCK-----	4	TECHNICAL DATA -----	14
OUTDOOR RESET MODE -----	5	CLEANING -----	15
OUTDOOR RESET SETTINGS-----	5	REPLACING CARTRIDGE ASSEMBLY -----	15
SETPOINT AND DELTA T MODE-----	6	REPLACING THE CHECK VALVE -----	16
SETPOINT AND DELTA T SETTINGS-----	7	REPLACEMENT PARTS LIST -----	16
BOILER OPERATION MODE -----	7	LIMITED WARRANTY STATEMENT -----	16



A Taco resource – saving product

Typical Piping

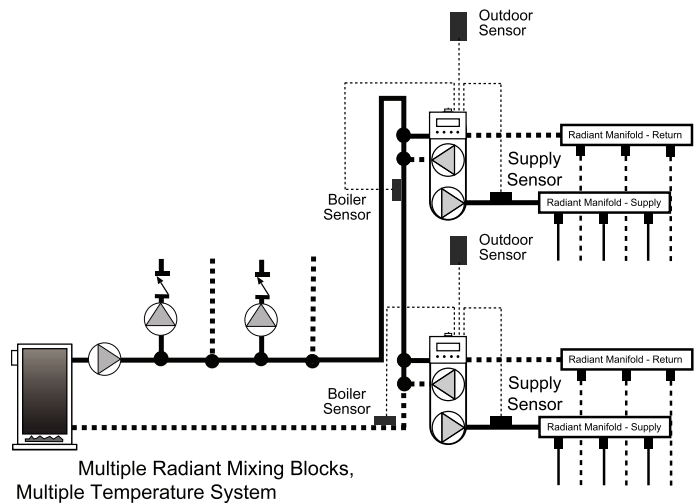
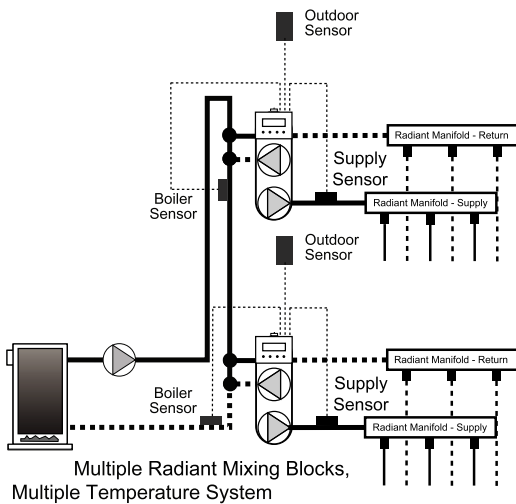
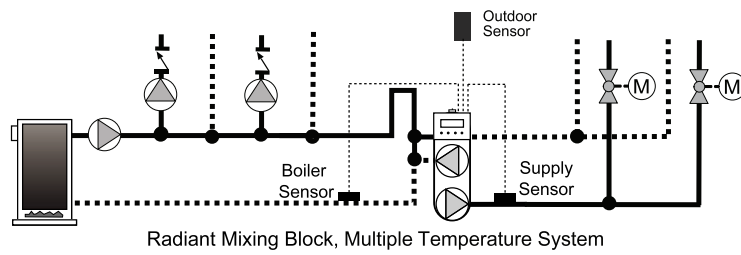
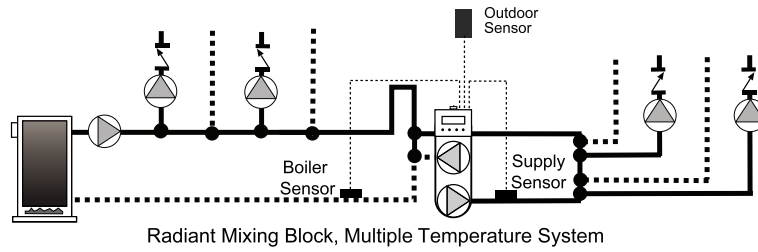
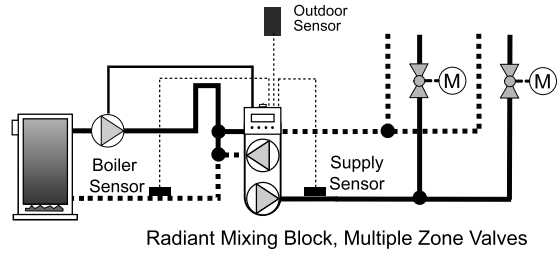
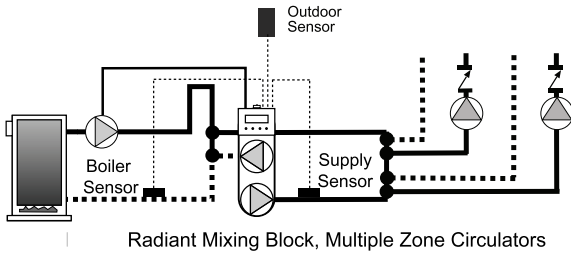
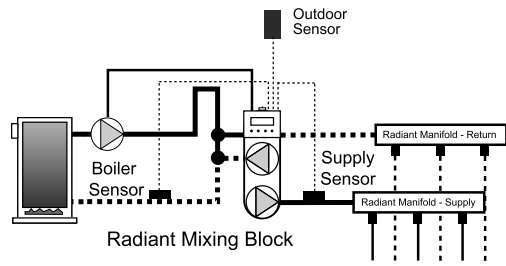
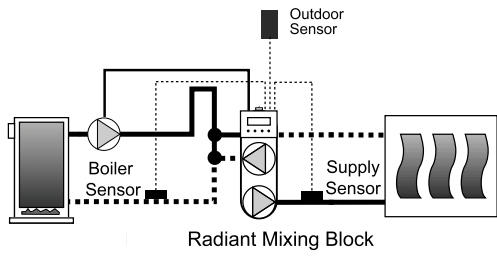

Getting Ready

Ensure that the contents of this package are complete. If any of the contents are missing or damaged, please contact your local Taco sales representative for assistance.

Contents should include the following:

- One Radiant Mixing Block, unit consists of the following parts:
 - One Radiant Mixing Control
 - One Green Enclosure
 - One Casing with two circulators attached
 - One Backplate
 - One Power Cord (6 feet, attached to backplate)
- One Taco Outdoor Sensor
- Two Taco Strap-on Sensors
- One Instruction Sheet

Application

The Taco Radiant Mixing Block® (RMB) is a complete injection mixing system. Integral to the unit is a variable speed injection circulator, constant speed system circulator, air elimination, and the electronics to drive it all. With only four piping connections needed, the RMB greatly reduces the time and space required for installation. The RMB can be set up to operate as an outdoor reset control, a setpoint control or a delta T limiting control, creating flexibility never seen before in a single unit.

Design Procedure

1. Using the pump curve located below, ensure that the System Pump of the Radiant Mixing Block will provide adequate flow for the system in which it is to be installed.
2. Using the table or equation below, determine the required flow rate for the Injection Pump.
3. Using the pump curve located below, ensure that the Injection Pump of the Radiant Mixing Block will provide adequate flow for the system in which it is to be installed.

SYSTEM PUMP CURVE

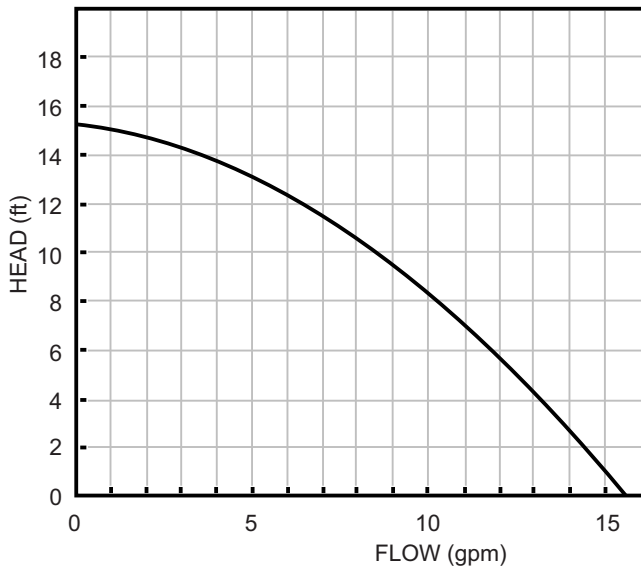

INJECTION PUMP CURVE

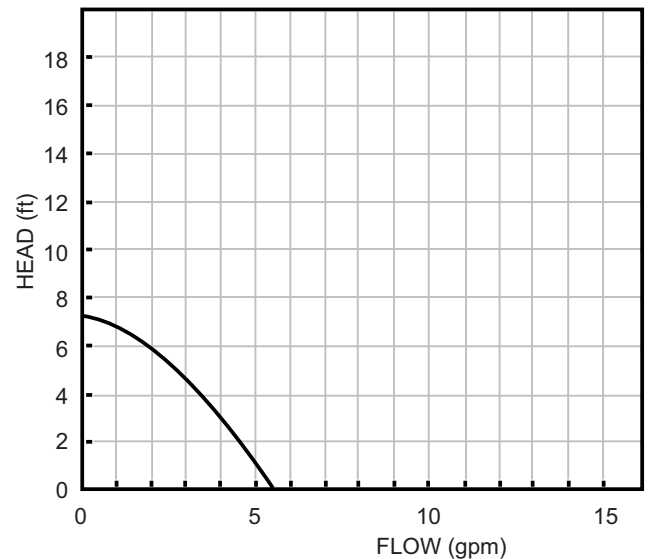

REQUIRED INJECTION PUMP FLOW RATE

T_b = Boiler Supply Temperature
T_s = Radiant Supply Temperature

$$\text{Injection Flow Rate (GPM)} = \frac{\text{BTU's}}{(\text{T}_b - \text{T}_s) \times 500}$$

Required Injection Flow Rate (GPM)

T_b - T_s	BTU's x 1,000					
	20	40	60	80	100	120
100	0.4	0.8	1.2	1.6	2.0	2.4
80	0.5	1.0	1.5	2.0	2.5	3.0
60	0.7	1.3	2.0	2.7	3.3	4.0
40	1.0	2.0	3.0	4.0	5.0	
20	2.0	4.0				

Installation of the Radiant Mixing Block

STEP ONE MOUNTING

1. Mounting position – The Radiant Mixing Block must be mounted in the vertical position with the automatic air vent located at the top of the Radiant Mixing Block.
2. To mount the Radiant Mixing Block begin by removing the Radiant Mixing Control from the front of the Radiant Mixing Block. Remove the screws and pull the Radiant Mixing Control straight forward. Ensure that the Radiant Mixing Control is stored in a safe place until it is ready to be remounted.
3. Remove the three screws holding the green plastic cover to the Radiant Mixing Block.
4. Select a suitable location to mount the Radiant Mixing Block that allows sufficient space for easy pipe connections.
5. Attach the sheet metal base to the wall with screws (not included) through the small mounting holes. See technical data for hole location and spacing.
6. Using four suitable screws (not included), fasten the Radiant Mixing Block to the selected location. Ensure that at least two of the mounting screws are attached to a wall stud or similar surface.

STEP TWO PIPING CONNECTIONS

1. Using proper piping practices, connect the supply to the radiant heating system to the Radiant Supply (bottom right hand connection) as indicated on the plastic cover of the Radiant Mixing Block. Ensure that a proper isolation valve is installed.
2. Using proper piping practices, connect the return from the radiant heating system to the Radiant Return (top right hand connection) as indicated on the plastic cover of the Radiant Mixing Block. Ensure that a proper isolation valve is installed.
3. Using proper piping practices, connect the supply from the boiler loop to the Boiler Supply (top left hand connection) as indicated on the plastic cover of the Radiant Mixing Block. Ensure that a proper isolation valve is installed.
4. Using proper piping practices, connect the return to the boiler loop to the Boiler Return (bottom left hand connection) as indicated on the plastic cover of the Radiant Mixing Block. Ensure that a proper isolation valve is installed.
5. Connect the Boiler Supply and Boiler Return lines to the boiler loop using standard Primary Secondary piping practices.

STEP THREE FILLING

1. Fill system with tap water – The system must be filled before operating the circulator. The bearings are water lubricated and should not be allowed to operate dry. Filling the system will result in immediate lubrication of the bearings. It is always good practice to flush a new system of foreign matter before starting the circulator.
2. Circulator operation – Operate the circulators for 5 minutes immediately after filling system to purge remaining air from the bearing chamber. This is especially important when installing the circulator during the off-season.

STEP FOUR REPLACING THE FRONT COVER

1. Place the green plastic cover over the Radiant Mixing Block.
2. Using the original three screws, fasten the green plastic cover to the Radiant Mixing Block.
3. Reinstall the Radiant Mixing Control and fasten it in place with the remaining original screw. RMC wiring starts on page 8.

STEP FIVE ELECTRICAL CONNECTIONS

1. Electrical connections – Observe all applicable codes when connecting to power supply. The motors are impedance protected, and do not require overload protection. The pumps cannot run backwards.

WARNING:

Do not use in swimming pool or spa areas; pump has not been investigated for this application.

WARNING:

In the event the retaining screws have been pulled out of the housing, DO NOT replace them. Use of any other screw may short out the stator windings, creating a risk of electrical shock.

CAUTION:

1. The addition of petroleum based fluids or certain chemical additives to systems utilizing TACO equipment voids the warranty.

2. Use supply wires suitable for 90°C – ATTENTION: Employer des fils d'alimentation adéquats pour 90°C.

WARNING:

To avoid electrical shock, disconnect the power supply to the circulator and the main electrical unit.

Outdoor Reset Mode of Operation

In order to properly control a hot water heating system, the amount of heat supplied to the building must equal the amount of heat lost by the building. The amount of heat delivered into a building depends on the temperature of the water in the heating unit and the surface area of the heating unit. Heating units with a small surface area, such as baseboard radiators, require a higher water temperature than heating units with a larger surface area such as radiant floors.

The amount of heat lost from a building depends on the outdoor temperature. As the outdoor temperature becomes colder, the amount of heat a building loses increases.

The operation of a hot water heating system can generally be improved by adjusting the supply water temperature to the system as the outdoor temperature changes. Using this approach, the heat input to the building can be matched to the heat lost from the building. This method of controlling the supply water temperature to a heating system greatly improves the comfort of the system and is known as Outdoor Reset.

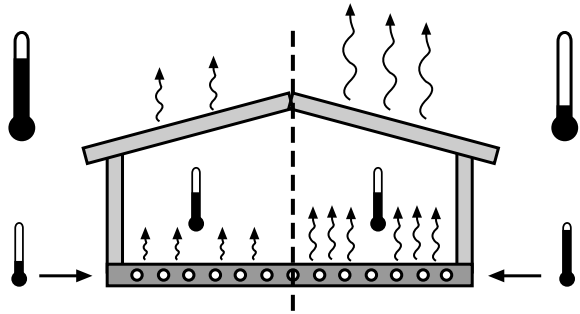

When a Taco Outdoor Sensor is connected to the Radiant Mixing Control (RMC), the RMC provides outdoor reset. When operating in the outdoor reset mode of operation, the installer must set the Outdoor Design Temperature and the Design Supply Temperature in order to establish the relationship between the outdoor temperature and the supply water temperature. This is known as setting the Heating Curve.

SEQUENCE OF OPERATION

When the RMC receives a Demand and it is not in a WWSD, the RMC turns on the system pump and calculates a Mixing Target temperature. The variable speed injection pump is then operated to maintain the Mixing Target temperature at the mixing supply sensor.

The boiler contact operates as described in the Boiler Operation section. The RMC also provides boiler protection as described in the Boiler Operation section.

DEMAND

The RMC requires a demand signal before it will begin operation. The RMC can use either a powered or an unpowered demand signal. Once a demand signal is received, the RMC displays the demand pointer in the display and operates as described above.

Powered Demand

The RMC recognizes a Powered Demand Signal when 24 V (ac) is applied across the Com and Heat Dem terminals.

Unpowered Demand

The RMC recognizes an Unpowered Demand signal when a switch is closed between the Com and Heat Dem terminals.

SYSTEM PUMP OPERATION

The RMC has an internal system pump contact. This contact turns on when the RMC has a mixing demand and is not in a WWSD. The integrated system pump as well as an external boiler pump may be controlled by this relay. By providing proper flow in the boiler loop, the boiler temperature can be accurately controlled based on the mixing load.

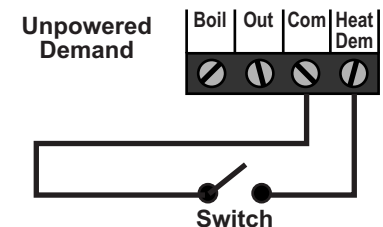
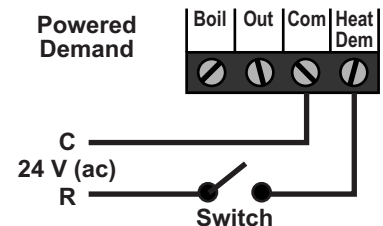

Outdoor Reset Settings

HEATING CURVE SETTINGS

In order to establish the heating curve, the RMC must be given two points to work with. The first point is the Outdoor Reset Starting Point and the second point is the Design Condition.

Outdoor Reset Starting Point

The Outdoor Reset Starting Point for the RMC is fixed at 72°F. This means that when the outdoor temperature is 72°F, the RMC calculates a required supply water temperature (Mix Target) of 72°F.

Design Conditions

The design conditions represent the supply water temperature required to satisfy the heating system on the typical coldest day of the year. These are the conditions that are used when calculating the size of the heating equipment needed to heat the building. The Design Conditions are made up of an outdoor temperature (Outdoor Design) and a supply water temperature (Design Supply).

Outdoor Design

The Outdoor Design temperature is the average coldest day of the year for the area in which the building is located.

Design Supply

The Design Supply temperature is the supply water temperature that is required to heat the building when the outdoor air temperature is as cold as the Outdoor Design temperature.

Maximum System Supply

Some systems, such as hydronic radiant floor heating, may require the maximum supply water temperature to be limited in order to protect certain system components from high temperatures. The RMC has a Maximum Supply setting that can be used to limit the maximum temperature that the control is allowed to use for a Mixing Target (MIX TRG) temperature.

Minimum System Supply

Some applications, such as floor warming, may require the minimum supply water temperature to be limited in order to provide a certain level of occupant comfort. The RMC has a Minimum Supply setting that can be used to limit the minimum temperature that the control is allowed to use for a Mixing Target (MIX TRG) temperature. This minimum applies as long as the RMC has a demand and is not in WWSD.

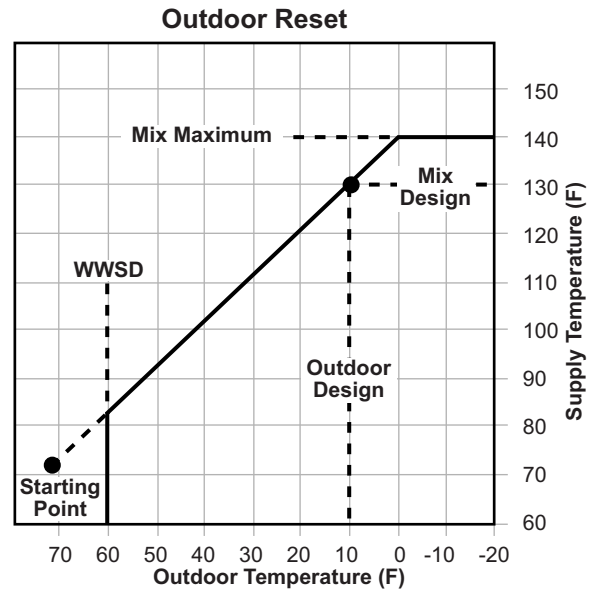

Warm Weather Shut Down (WWSD)

When the outdoor temperature is warmer than the WWSD setting, the RMC turns off the boiler and the variable speed injection pump. If a demand is received while the RMC is in a WWSD, the RMC indicates that the demand has been received by displaying the Demand pointer however, the MIX TRG remains as "- -". The RMC has a freeze protection feature that does not allow the supply water temperature to drop below 35°F (2°C) as long as there is a mixing demand signal.

Setpoint and Delta T Mode of Operation

In certain applications, it is desirable to maintain a fixed supply water temperature. This type of application is a setpoint application. Examples of setpoint applications include heat pump loops, reheat coils and floor warming.

In specialized applications, such as snow melting, it is desirable to limit the rate of temperature increase in the system from the system's starting temperature to its operating setpoint. This is desired in order to prevent thermal shock of the system. This type of application is a Delta T application.

If the RMC is to operate as a setpoint control, the Outdoor Design temperature must be set to OFF and the Mixing Target temperature must be set to the desired temperature.

If the RMC is to operate as a Delta T control, a mixing return sensor must be installed, the Outdoor Design temperature must be set to OFF and both the Delta T Max setting and the Mixing Target temperature must be set to the desired temperature.

In both of these applications, the outdoor sensor is not to be installed

SEQUENCE OF OPERATION

When the RMC receives a Demand, the system pump is turned on.

If the Delta T Max setting is set to OFF, the variable speed injection pump is operated to maintain the mixing supply sensor at the Mixing Target temperature set by the installer.

If the Delta T Max setting is not set to off, the variable speed injection pump is operated to maintain the mixing supply sensor at either the Mixing Return temperature plus the Delta T Max setting or the Mixing Target temperature set by the installer whichever is lower. The boiler contact operates as described in the Boiler Operation section. The RMC also provides boiler protection as described in the Boiler Operation section.

DEMAND

The RMC requires a demand signal before it will begin operation. The RMC can use either a powered or an unpowered demand signal. Once a demand signal is received, the RMC displays the demand pointer in the display and operates as described above.

Powered Demand

The RMC recognizes a Powered Demand Signal when 24 V (ac) is applied across the Com and Heat Dem terminals.

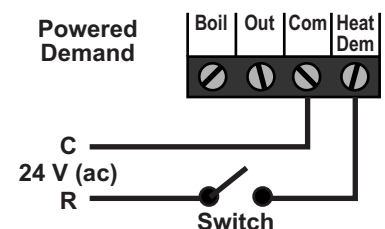

Unpowered Demand

The RMC recognizes an Unpowered Demand signal when a switch is closed between the Com and Heat Dem terminals.

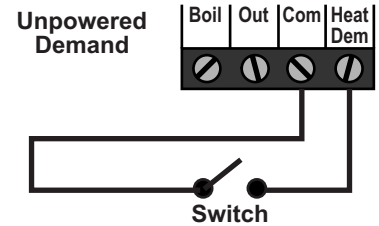

SYSTEM PUMP OPERATION

The RMC has an internal system pump contact. This contact turns on when the RMC has a mixing demand. The system pump as well as an external boiler pump may be controlled by this relay. By providing proper flow in the boiler loop, the boiler temperature can be accurately controlled based on the mixing load.

Setpoint and Delta T Settings

Outdoor Design

The Outdoor Design temperature must be set to OFF.

Mixing Target

The Mixing Target temperature is set to the desired operating temperature of the system.

Delta T Max

The Delta T Max temperature is set to the maximum temperature difference that is desired between the mixing return temperature and the mixing supply temperature. In order to adjust this setting, a mixing return sensor must be connected to the control.

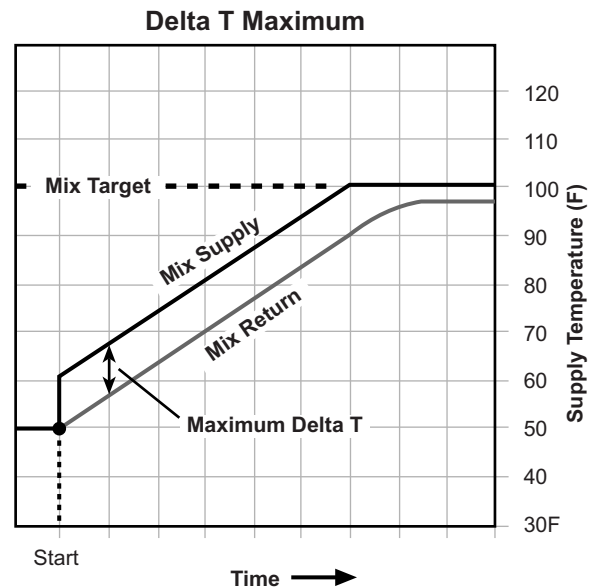
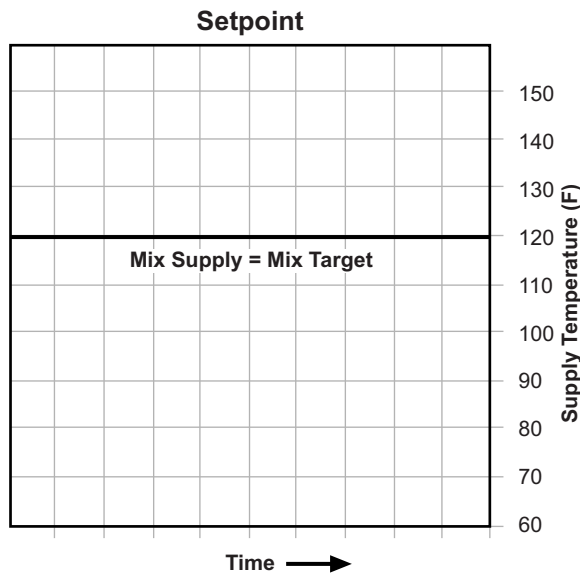

Boiler Operation

The RMC operates the boiler in two basic modes of operation. The RMC can either “Control” the boiler or “Enable” the boiler. The mode of operation is determined by the Boiler Sensor location. The boiler sensor location is determined using the DIP switch on the back of the circuit board. If the DIP switch is set to ON, the boiler sensor is to be located on the boiler supply. If the DIP switch is set to OFF, the boiler sensor is to be located on the boiler return.

- If the DIP switch is set to On, the RMC will “Control” the boiler.
- If the DIP switch is set to Off, the RMC will “Enable” the boiler.
- If the Boiler Sensor has not been installed, the RMC will “Enable” the boiler.



BOILER CONTROL

When the RMC controls the boiler, the RMC opens and closes the boiler contact in order to control the temperature of the boiler supply water temperature. When the RMC is controlling the boiler temperature, the RMC will determine the boiler supply water temperature that is required to satisfy the demands of the system. The RMC will also determine a differential that is sufficient to minimize short cycling of the boiler. The RMC will then cycle the boiler using these parameters.

Differential

An on / off boiler must be operated with a differential in order to prevent short cycling. When the supply water temperature drops 1/2 of the differential below the required boiler supply temperature, the boiler is turned on. The boiler is then kept on until the supply

water temperature rises 1/2 of the differential above the required boiler supply temperature. If the differential is too wide, there can be large supply water temperature swings; however, if the differential is too narrow, the boiler short cycles and operates inefficiently. This control automatically calculates the boiler differential in order to achieve an appropriate balance between temperature swings and boiler efficiency. This also permits the control to adapt to changing loads and conditions. The RMC only operates the boiler once the output of the injection circulator exceeds 10% of flow.

BOILER ENABLE

When the RMC “Enables” the boiler, the RMC opens and closes the boiler contact based on the output of the variable speed injection pump. The actual temperature and cycling of the boiler is then determined by other controls or the aquastats on the boiler itself. When operating in the boiler enable mode, the boiler contact turns on once the variable speed output exceeds 25%. The boiler contact shuts off if the output of the variable speed drops below 5% for more than three minutes or if the demand is removed from the RMC.

BOILER PROTECTION (BOILER MINIMUM)

Cool water is often returned to the boiler from low temperature radiant floor heating systems or when the heating system is recovering from night setback. This cool boiler return water may cause the boiler to operate at such a low temperature that the flue gases condense. Alternatively, when the boiler surfaces are hot due to previous loads such as domestic hot water generation, the large temperature difference (Delta T) between the boiler and its return water can cause the boiler to become thermally shocked. Proper protection of the boiler under these circumstances is required.

When a boiler sensor is connected to the control, the RMC is capable of providing boiler protection. When providing boiler protection, the RMC limits the output of the variable speed injection pump in order to reduce the amount of cool water being returned to the boiler. This allows the boiler temperature to increase to a point that avoids flue gas condensation.

Boiler Protection with Boiler Enable

When the Boiler Sensor is set to the “Return” setting the control begins to back off the variable speed injection pump when the boiler temperature drops below the Boiler Minimum Setting.

Boiler Protection with Boiler Control

When the Boiler Sensor is set to the “Supply” setting the control begins to back off the variable speed injection pump when the boiler temperature drops 1/2 of the Differential below the Boiler Minimum Setting.

Note: If a boiler sensor is not installed, the RMC cannot provide boiler protection.

Set Up of Radiant Mixing Control

CAUTION

Improper installation and operation of this product could result in damage to the equipment and possibly personal injury. It is your responsibility to ensure that this product is installed in a safe manner according to all of the applicable codes, standards and instructions. The electronic control contained in this product is not intended as a primary limit control. Removal of the PC Board from its enclosure can result in damage to the control and possibly even personal injury. Refer to qualified personnel for servicing.

STEP ONE - REMOVING THE RADIANT MIXING CONTROL FROM THE RADIANT MIXING BLOCK

- Remove the screw from the front of the control.
- Grasp the front of the control and remove it from the green plastic enclosure surrounding the injection mixing block.
- Wiring to the control is connected to the back of the circuit board using either the indicated spade connectors, molex connectors or the snap on terminal plugs. These may need to be disconnected to fully remove the control.

STEP TWO - INSTALLING THE SENSORS

Outdoor Sensor

Note: The temperature sensor is built into the plastic enclosure.

If the Radiant Mixing Block is to be used in the outdoor reset mode, the Outdoor Sensor must be installed. If the Radiant Mixing Block is to be used in either the setpoint or a delta T mode, the Outdoor sensor is not required and does not need to be installed. (See pages 5 to 7 for a complete description of the available modes.)

- Remove the screw from the center of the sensor and pull the front cover off of the sensor.
- The outdoor sensor can either be mounted directly to an outside wall or onto a standard electrical box. Wiring can enter the sensor either through the bottom or the back of the plastic enclosure.
- The sensor should be mounted on a wall which best represents the heat load on the building (i.e. a north facing wall for most buildings and a south facing wall for building with a large south facing glass area). The sensor should not be installed near heat sources such as exhaust vents or window openings.
- The sensor should be installed at an elevation above the ground that will prevent accidental damage or tampering.
- Ensure that the sensor is installed in a sheltered location out of direct sunlight and rain.
- Connect a two conductor wire to the terminal block in the Outdoor Sensor and run the wires from the Outdoor Sensor back to the Radiant Mixing Control's location.

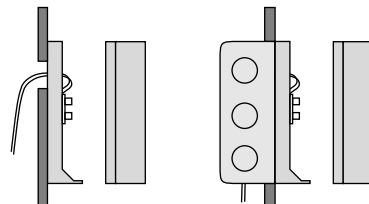

STEP TWO - (continued)

Installing the System and Boiler Sensors

Note: These sensors are designed to be mounted on a pipe or in a temperature well.

- These sensors can be strapped directly to the pipe using the cable tie provided with the sensors. Insulation should be installed around the sensors to reduce the effect of air currents on the temperature measurement. Care should be taken not to over-tighten the cable tie as this can cause damage to the sensor.
- The System Supply Sensor is to be installed on the System Supply pipe. This sensor is required at all times.
- If a Boiler Sensor is used, install the boiler sensor on either the boiler supply or the boiler return. Ensure that the DIP switch on the back of the circuit board of the RMC is set to ON if the sensor is installed on the boiler supply and set to OFF if the sensor is installed on the boiler return. If boiler control and boiler protection are not required in the application, the boiler sensor does not need to be installed.
- If a System Return Sensor is to be used, install the sensor on the system return pipe. This sensor is only required if the RMC is operating in the Delta T mode.

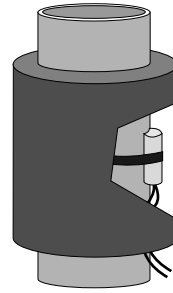

STEP THREE - WIRING THE RMC

- Before wiring the control, ensure that power to all circuits is off.
- Ensure that all wires are stripped to a minimum of 3/8" (9 mm) in order to ensure proper connection to the low voltage terminals.
- Provide a separate circuit with a minimum 15 A capacity in order to insure proper operation.

Wiring Power to the RMC

Using the supplied line cord, connect the white wire with the 1/4 inch female spade connector to the 1/4 inch male spade connector labelled "N" on the back of the RMC circuit board. Connect the black wire with the 1/4 inch female spade connector to the 1/4 inch male spade connector labelled "H" on the back of the RMC circuit board. Connect the green wire to the ground screw located on the casting of the Radiant Mixing Block.

Wiring to the Radiant Mixing Block

Wiring to the Injection Pump

Connect the variable speed injection pump's three pin molex connector from the Radiant Mixing Block to the matching three pin molex connector labelled "Var" on the back of the RMC circuit board.

Wiring the Radiant Mixing Block System Pump

Connect the system pump's four pin molex connector from the Radiant Mixing Block to the matching four pin molex connector labelled "Sys" on the back of the RMC circuit board.

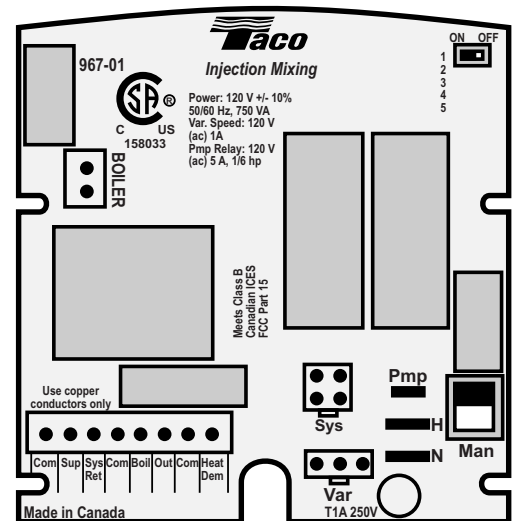

Wiring the Sensors

Do not apply power to the sensors or the sensor terminals as this will damage either the sensors or the control.

Begin by removing the eight (8) pin plug-in terminal block from the RMC's circuit board. To do this, pull the terminal block directly away from the circuit board.

System Supply Sensor (Required)

Connect the two wires from the System Supply Sensor directly to the "Com" and "Sup" terminals of the terminal block. The System Supply Sensor is used to measure the supply temperature being delivered to the system.

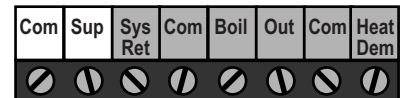

System Return Sensor (Delta T Limiting Mode)

Connect the two wires from the System Return Sensor directly to the "Com" and "Sys Ret" terminals of the terminal block. The System Return Sensor is used to measure the return temperature from the system.

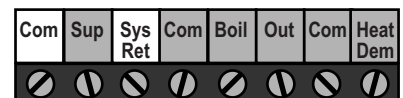

Boiler Sensor (Optional)

Connect the two wires from the Boiler Sensor directly to the "Com" and "Boil" terminals of the terminal block. The Boiler Sensor is used to measure the boiler temperature.

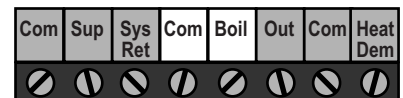

Outdoor Sensor (Reset Mode)

Connect the two wires from the Outdoor Sensor directly to the "Com" and "Out" terminals of the terminal block. The outdoor sensor is used to measure the outdoor air temperature.

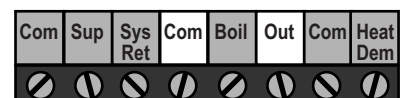

Wiring the External Boiler Pump (Optional)

Using a 3/16 inch female spade connector, connect the hot side of the boiler pump circuit to the male spade connector labelled "Pmp" located on the back of the RMC circuit board. Connect the neutral side of the boiler pump circuit to the neutral (N) side of the RMB's input power supply. When using this option the line cord should be removed and the RMB hard wired.

Wiring the Heat Demand (Required)

The Heat Demand circuit can be wired using either a powered signal or an unpowered switch closure.

Powered Demand

If a powered demand is being used, connect the switched side of the 24 V (ac) demand circuit to the "Heat Dem" terminal of the terminal block. Connect the second side of the 24 V (ac) demand circuit to the "Com" terminal of the terminal block.

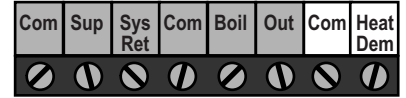

Unpowered Demand

If an unpowered demand is being used, connect one side of the demand switch to the "Heat Dem" terminal of the terminal block. Connect the second side of demand switch to the "Com" of the terminal block.

Wiring the Boiler

Begin by removing the two (2) pin plug-in terminal block from the RMC's circuit board. To do this, pull the terminal block directly away from the circuit board.

The Boiler Relay is a switch that is to be used in the boiler circuit. There is no power available on these terminals from the RMC. Connect the Boiler relay in series with the control circuit of the boiler.

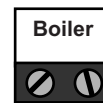

STEP FOUR - RECONNECTING THE TERMINAL BLOCKS

Insert the eight (8) pin plug-in terminal block into the eight (8) pin terminal header on the RMC circuit board. Press firmly until it snaps into place.

Insert the two (2) pin plug-in terminal block into the two (2) pin terminal header on the RMC circuit board. Press firmly until it snaps into place.

STEP FIVE - MOUNTING THE RMC

- Begin by pushing all excess wiring back into the Radiant Mixing Block.
- Place the RMC into the Radiant Mixing Block's plastic enclosure.
- Insert the screw into the hole located on the face of the RMC and tighten the screw to fasten the RMC to the Radiant Mixing Block Enclosure. Do not overtighten.

STEP SIX - POWERING THE RMC

Apply power to the RMC circuit by plugging in the line cord.

Display Operation

POWER UP

On power up, the control displays all segments for 2 seconds followed by the control version number.

The control then automatically goes to the operating mode and displays either the outdoor temperature or the mix supply temperature.



VIEW MENU

To advance to the next available View Item, press and release the ITEM button on the face of the control.

Outdoor Temperature

The outdoor temperature is displayed when the OUTDR element is turned on. This is the current temperature at the outdoor sensor. The outdoor temperature is only displayed if an outdoor sensor is installed and the Outdoor Design temperature is not turned off.



Mixing Supply Temperature

The mixing supply temperature is displayed when the MIX SUP elements are turned on. This is the current temperature at the mixing supply sensor.



Mixing Return Temperature

The mixing return temperature is displayed when the MIX RET elements are turned on. This is the current temperature at the mixing return sensor. The mixing return temperature is only displayed if the Outdoor Design temperature is turned OFF and a mixing return sensor is installed.

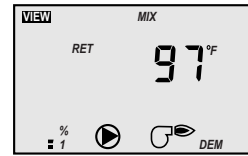

Mixing Target Temperature

The mixing target temperature is displayed when the MIX TARG elements are turned on. This is the temperature the RMC is currently trying to maintain at the supply sensor. If "--" is displayed, the RMC is either in WWSD or a demand for heat is not present.

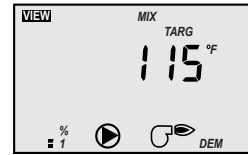

Boiler Temperature

The boiler temperature is displayed when the BOIL element is turned on. This is the current temperature at the boiler sensor. The boiler temperature is only displayed if a boiler sensor is installed.

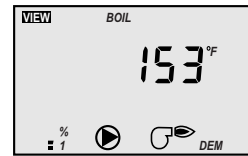

ADJUST MENU

To switch between the View menu and the Adjust menu, press and release the MENU button on the face of the control. To advance to the next available Adjust Item, press and release the ITEM button on the face of the control.

Mixing Target Temperature

The Mixing Target Temperature sets the desired supply temperature when operating in the setpoint mode. This item is only available if the Outdoor Design setting is set to OFF.



Delta T Maximum

The Delta T Maximum sets the maximum temperature difference between the mixing return sensor and the mixing supply sensor. This item is only available if Outdoor Design setting is set to OFF. If a mixing return sensor is not installed, set this item to OFF.



Outdoor Design Temperature

The Outdoor Design Temperature is the outdoor temperature used in the heat loss calculation. If the RMB is used in the outdoor reset mode, this item is set to the typical coldest outdoor temperature. If the RMB is used in the setpoint mode, this item is set to OFF.



Mixing Design Temperature

The mixing design temperature is the supply temperature used in the heat loss calculation. This is the supply temperature that is required to heat the building when the outdoor temperature is as cold as the outdoor design temperature. This item is only available if the Outdoor Design setting is not set to OFF.



Mixing Maximum Temperature

The mixing maximum temperature is the highest temperature that the control is allowed to use as a mixing target temperature. This item is only available if the outdoor design setting is not set to OFF.

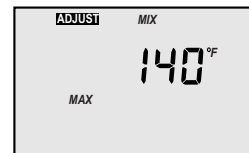

Mixing Minimum Temperature

The mixing minimum temperature is the lowest temperature that the control is allowed to use as a mixing target temperature. This item is only available if the outdoor design setting is not set to OFF.



Boiler Minimum Temperature

The boiler minimum temperature item should be set to the lowest water temperature at which the boiler can operate without causing the boiler flue gases to condense. Consult the boiler manufacturer for recommended minimum boiler supply temperatures. This item is only available if a boiler sensor is connected to the control.

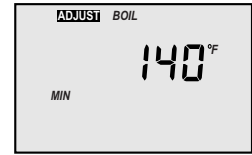

Warm Weather Shut Down (WWSD)

The warm weather shut down is the outdoor temperature at which the system is shut down. This item is only available if the outdoor design temperature is not set to OFF.



Units

The units of temperature in which all of the View and Adjust items are viewed in.



The control automatically goes back to the view menu when the buttons are left alone for 20 seconds
All settings will be saved even during power down of the control

Trouble Shooting

As in any troubleshooting procedure, it is important to isolate the problem as much as possible. By using the Error Messages located on pages 13 & 14, the trouble shooting process can be greatly simplified. When an error message is displayed on the RMC, refer to the error messages on pages 13 & 14 to identify the cause of the error and use standard testing procedures to confirm the fault. If you suspect an external wiring fault, return to step three and carefully check all external wiring connections. Once the fault has been corrected, press any button on the face of the control to clear the error message.

TEST ROUTINE

The main control functions of the RMC can be tested by pressing and holding the UP button for more than three (3) second. After the UP button has been pressed for more than three (3) second, the RMC follows the following sequence.

Step One

The variable speed output is increased from 0% to 100% over 10 seconds.

Step Two

The variable speed output is decreased from 100% to 0% over 10 seconds.

Step Three

The System Pump is turned on for 10 seconds.

Step Four

The Boiler Contact is turned on. After 10 seconds, the Boiler Contact and the System Pump contact are turned off. The RMC continues normal operation.

MANUAL OVERRIDE

In the event that the RMC fails to operate, a manual operation switch is located on the RMC's circuit board. When the manual operation switch is set to Man, the variable speed injection pump and the system pump outputs are turned on. This operation continues until the manual switch is returned to its original position.

FUSE REPLACEMENT

The Variable Speed output of the RMC is fused protected. This fuse is located on the circuit board on the back of the RMC. This is a field replaceable item.
Fuse rating: 1 A 1/12 hp, fuse T1 A 250 V

ADJUSTMENT OF SETTINGS

If the outdoor temperature is cold and the rooms are cold, increase the MIX DSGN setting by 5°F (3°C) per day.

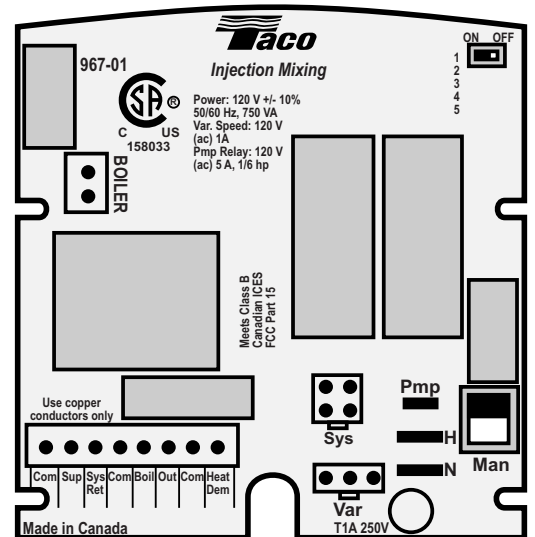

TESTING THE SENSORS

Do not apply voltage to the sensor or to the sensor input of the control as this will result in damage to either the sensor, the control, or both the sensor and the control.

A quality testing meter capable of measuring up to 2,000,000 ohms and a good quality digital thermometer are required to test the sensors. If a digital thermometer is not available, place a second sensor next to the original sensor and compare the readings.

Begin by measuring the temperature at the sensor location using the digital thermometer. Next, measure the resistance of the sensor using the testing meter. Ensure that the sensor is disconnected from the control at the time of testing. Using the reference chart below, determine the sensor's temperature. Compare the sensor's temperature to that measured by the digital thermometer. The two temperature readings should be close.

If the sensor's temperature is too high, this can indicate that there is a partial short in the sensor wiring. If the sensor's temperature is too low, this can indicate that there is a loose connection or break in the sensor wiring. Isolate and repair the problem. If the problem is isolated to the sensor, replace the sensor.

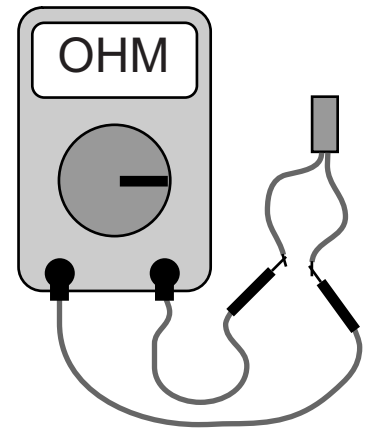

Temperature		Resistance	Temperature		Resistance	Temperature		Resistance	Temperature		Resistance
F	C	Ohms	F	C	Ohms	F	C	Ohms	F	C	Ohms
-30	-34	234,000	30	-1	34,500	90	32	7,300	150	66	2,000
-20	-29	165,000	40	4	26,000	100	38	5,800	160	71	1,700
-10	-23	118,000	50	10	20,000	110	43	4,700	170	77	1,400
0	-18	85,500	60	16	15,500	120	49	3,800	180	82	1,200
10	-12	62,500	70	21	12,000	130	54	3,100	190	88	1,000
20	-7	46,000	80	27	9,300	140	60	2,500	200	93	800

Error Messages

EEPROM Read Error

The control was unable to read the installer settings from its memory. The control was forced to load the factory defaults for all settings. The control will stop operation until all of the settings in the Adjust menu have been checked.

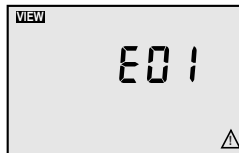

Mixing Return Sensor Short Circuit

A short circuit has been detected in the mixing return sensor. If the Maximum Delta T setting is set to OFF, the control continues operation. If the Maximum Delta T setting is not set to OFF, the control stops operation until the fault is corrected. To clear this error message, correct the short circuit and press any button on the control.

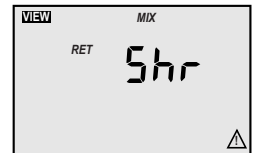

Outdoor Sensor Short Circuit

A short circuit has been detected in the outdoor sensor. The control assumes an outdoor temperature of 32°F (0°C) and continues operation. To clear this error message, correct the short circuit and press any button on the control.

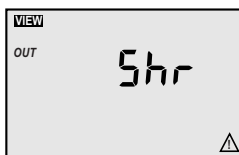

Mixing Return Sensor Open Circuit

An open circuit has been detected in the mixing return sensor. If the Maximum Delta T setting is set to OFF, the control continues operation. If the Maximum Delta T setting is not set to OFF, the control stops operation until the fault is corrected. To clear this error message, correct the open circuit and press any button on the control.



Outdoor Sensor Open Circuit

An open circuit has been detected in the outdoor sensor. The control assumes an outdoor temperature of 32°F (0°C) and continues operation. To clear this error message, correct the open circuit and press any button on the control.

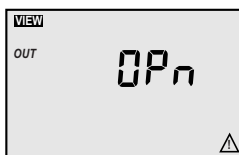

Boiler Sensor Short Circuit

A short circuit has been detected in the boiler sensor. The boiler contact is operated as if a boiler sensor is not installed. The control provides a boiler enable and does not provide boiler protection. To clear this error message, correct the short circuit and press any button on the control.

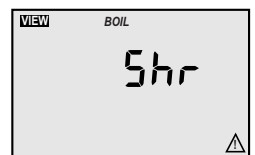

Mixing Supply Sensor Short Circuit

A short circuit has been detected in the mixing supply sensor. The control continues to operate the injection pump at a low speed (17 - 18%) as long as a demand is present. To clear this error message, correct the short circuit and press any button on the control.

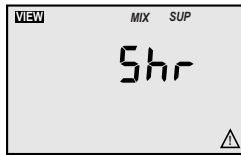

Boiler Sensor Open Circuit

An open circuit has been detected in the boiler sensor. The boiler contact is operated as if a boiler sensor is not installed. The control provides a boiler enable and does not provide boiler protection. To clear this error message, correct the open circuit and press any button on the control. If the sensor was deliberately removed, power down the control for five (5) seconds and re-power the control.

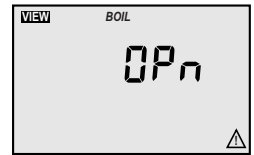

Mixing Supply Sensor Open Circuit

An open circuit has been detected in the mixing supply sensor. The control continues to operate the injection pump at a low speed (17 - 18%) as long as a demand is present. To clear this error message, correct the open circuit and press any button on the control.

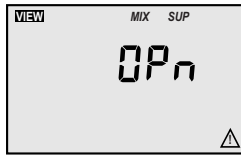

Technical Data

PERFORMANCE DATA

- Flow Range: 0 - 15.5 GPM
- Head Range: 0 - 15 Feet
- Minimum Fluid Temperature: 32°F (0°C)
- Maximum Fluid Temperature: 185°F (85°C)
- Maximum Working Pressure: 125 psi
- Connections: 3/4" NPT
- C US UL Mark
- FOR INDOOR USE ONLY

MATERIALS OF CONSTRUCTION

- Casing (body):..... Stainless Steel
- Stator Housing: Steel
- Cartridge: Stainless Steel
- Impeller: Non-Metallic
- Shaft: Ceramic
- O-Ring & Gaskets: EPDM
- Enclosure: Composite

ELECTRICAL DATA

- Volts 120
- Hz 60
- Ph 1
- Amps 2
- RPM 3250
- HP 1/40 & 1/25

RMC - Radiant Mixing Control (Variable Speed)

- Control - Microprocessor PID control: This is not a safety (limit) control
- Ambient conditions - Indoor use only, 32 to 185°F (0 to 85°C), <90% RH non-condensing
- Power Supply - 120 V (ac) +/- 10% 50/60 Hz 720 VA
- Var. Pump - 120 V (ac) 1 A 1/12 hp, fuse T1 A 250 V
- Sys / Pmp Relay - 120 V (ac) 5 A 1/4 hp, pilot duty 240 VA
- Boiler Relay - 120 V (ac) 5 A 1/4 hp, pilot duty 240 VA
- Demand - 24 V (ac) 0.1 VA or Dry contact
- Sensors - NTC thermistor, 10 kohm @ 77°F (25C +/- 0.2°C) B=3892
- Included - Taco Outdoor Sensor and 2 Taco Strap-on Sensors

- Motor Type Permanent Split Capacitor, Impedance Protected

CONTROL ADJUSTMENT MENU

- Mixing Setpoint Temperature 60° to 185° F
- Maximum Temperature Difference Between Mixing Supply and Return 10° to 70° F, Off
- Design Outdoor Air Temperature -60° to 32° F, Off
- Design Heating System Supply Water Temperature 70° to 185° F
- Maximum Mixing Target Supply 80° to 185° F
- Minimum Mixing Target Supply Fluid Temperature 35° to 150° F, Off
- Minimum Boiler Target Supply Water Temperature 80° to 180° F, Off
- Warm Weather Shut Down 35° to 100° F, Off
- Units °C or °F

CERTIFICATIONS AND LISTINGS

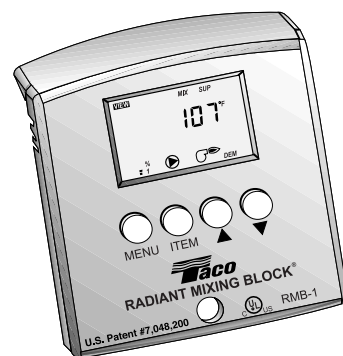

The installer must ensure that this control and its wiring are isolated and/or shielded from strong sources of electromagnetic noise. Conversely, this Class B digital apparatus complies with Part 15 of the FCC Rules and meets all requirements of the Canadian Interference-Causing Equipment Regulations. However, if this control does cause harmful interference to radio or television reception, which can be determined by turning the control off and on, the user is encouraged to try to correct the interference by reorienting or relocating the receiving antenna, relocating the receiver with respect to this control, and/or connecting the control to a different circuit from that to which the receiver is connected.

DIMENSIONS & WEIGHT

Model: RMB-1 Ship Weight: 18.5 lbs (8.4 kg)

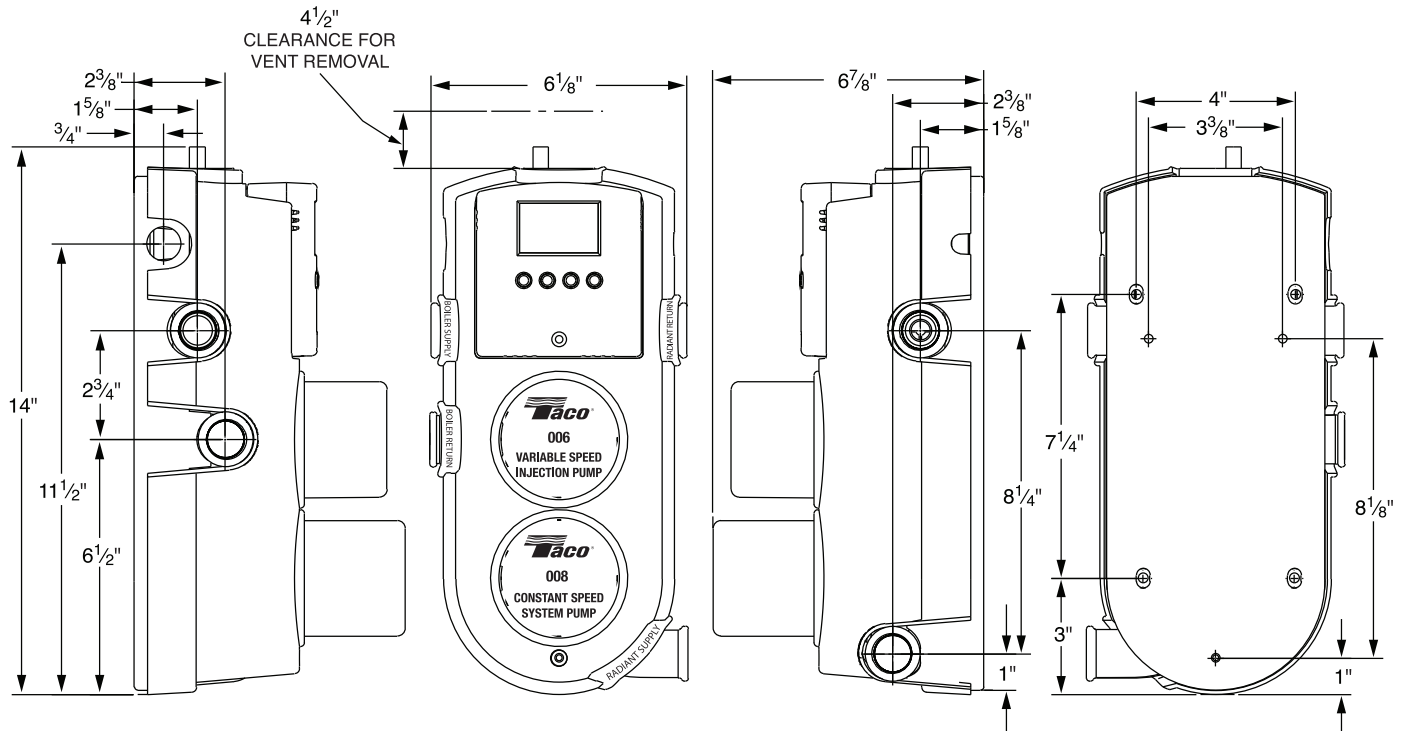

Cleaning

The exterior of the control can be cleaned using a damp cloth. Do not use any solvents. Moisten the cloth and wring out any excess water before cleaning the control.

Replacing Cartridge Assembly

1. Disconnect the electrical supply.
2. Reduce system pressure to 0 psi and allow system to return to room temperature. Isolate the RMB by closing the service valves or draining the system.
3. Remove the body bolts and swing motor assembly away from the body.
4. Pull cartridge out of the motor housing.
5. Install replacement cartridge, making sure that the cover plate is between the cartridge flange and motor.
6. Make sure the replacement cartridge corresponds to the full circulator product number. A complete parts list is available from your local plumbing supply wholesaler.
7. Reassemble the circulator using the new gasket and bolts supplied.
8. Follow the "Installation" procedure to start up the circulator.

Replacing the Check Valve

1. Disconnect the electrical supply.
2. Reduce system pressure to 0 psi and allow system to return to room temperature. Isolate the Radiant Mixing Block by closing the service valves or draining the system.
3. Remove the Boiler Supply connection to the Radiant Mixing Block.
4. Remove snap ring.
5. Remove the check valve, using needle nose pliers.
6. Install replacement check valve by pressing the valve into the casing until it is firmly seated.
7. Install the snap ring.
8. Reconnect the Boiler Supply connection to the Radiant Mixing Block.
9. Follow the "Installation" procedure to start up the Radiant Mixing Block.

Replacement Parts Breakdown

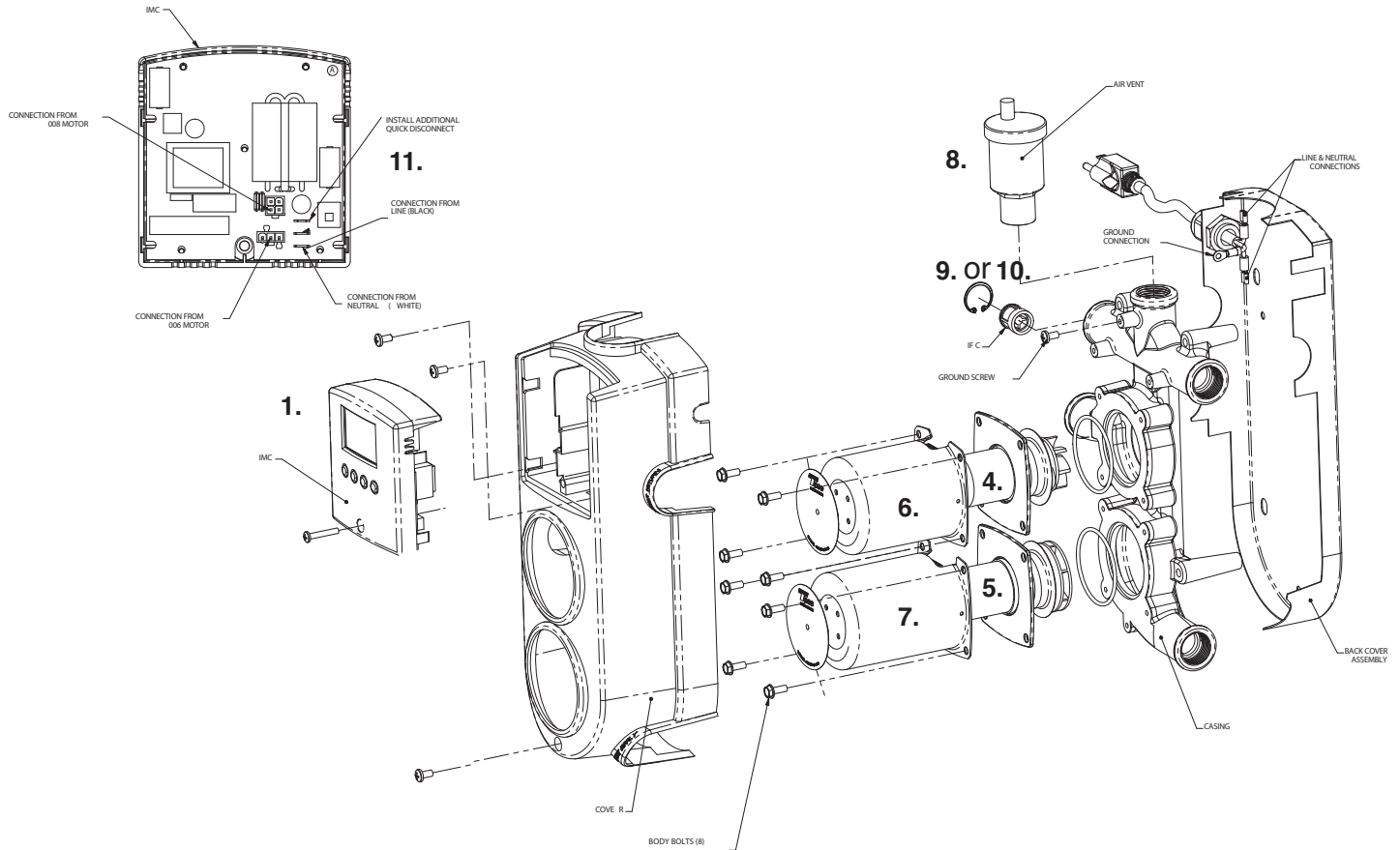

Replacement Parts

1. Control Board	193-004RP	7. Bottom System Pump Motor	193-016RP
2. Outdoor Sensor	9300-2052RP	8. Only Air Vent	419-1
3. Strap-On Sensor	9300-2044RP	9. Check Valve Dated 6/05 or Older	193-003RP
4. Top Injection Pump Cartridge	005-020RP	10. Check Valve Dated 7/05 or Newer	193-030RP
5. Bottom System Pump Cartridge	008-045RP	11. Brown Button Fuse	26-784RP
6. Top Injection Pump Motor Only	193-015RP		

LIMITED WARRANTY STATEMENT

Taco, Inc. will repair or replace without charge (at the company's option) any product or part which is proven defective under normal use within one (1) year from the date of startup or one (1) year and six (6) months from the date of shipment (whichever occurs first). Taco, Inc. will repair or replace without charge (at the company's option) any Taco 00 Series circulator cartridge that is proven defective under normal use within three (3) years from the date of manufacture.

In order to obtain service under this warranty, it is the responsibility of the purchaser to promptly notify the local Taco stocking distributor or Taco in writing and promptly deliver the subject product or part, delivery prepaid, to the stocking distributor. For assistance on warranty returns, the purchaser may either contact the local Taco stocking distributor or Taco. If the subject product or part contains no defect as covered in this warranty, the purchaser will be billed for parts and labor charges in effect at time of factory examination and repair.

Any Taco product or part not installed or operated in conformity with Taco instructions or which has been subject to misuse, misapplication, the addition of petroleum-based fluids or certain chemical additives to the systems, or other abuse, will not be covered by this warranty.

If in doubt as to whether a particular substance is suitable for use with a Taco product or part, or for any application restrictions, consult the applicable Taco instruction sheets or contact Taco at (401-942-8000).

Taco reserves the right to provide replacement products and parts which are substantially similar in design and functionally equivalent to the defective product or part. Taco reserves the right to make changes in details of design, construction, or arrangement of materials of its products without notification.

TACO OFFERS THIS WARRANTY IN LIEU OF ALL OTHER EXPRESS WARRANTIES. ANY WARRANTY IMPLIED BY LAW INCLUDING WARRANTIES OF

MERCHANTABILITY OR FITNESS IS IN EFFECT ONLY FOR THE DURATION OF THE EXPRESS WARRANTY SET FORTH IN THE FIRST PARAGRAPH ABOVE.

THE ABOVE WARRANTIES ARE IN LIEU OF ALL OTHER WARRANTIES, EXPRESS OR STATUTORY, OR ANY OTHER WARRANTY OBLIGATION ON THE PART OF TACO.

TACO WILL NOT BE LIABLE FOR ANY SPECIAL, INCIDENTAL, INDIRECT OR CONSEQUENTIAL DAMAGES RESULTING FROM THE USE OF ITS PRODUCTS OR ANY INCIDENTAL COSTS OF REMOVING OR REPLACING DEFECTIVE PRODUCTS.

This warranty gives the purchaser specific rights, and the purchaser may have other rights which vary from state to state. Some states do not allow limitations on how long an implied warranty lasts or on the exclusion of incidental or consequential damages, so these limitations or exclusions may not apply to you.

Taco Comfort Solutions™ A Taco Group Company

Taco, Inc., 1160 Cranston Street, Cranston, RI 02920 | Tel: (401) 942-8000 | FAX: (401) 942-2360

Taco (Canada), Ltd., 8450 Lawson Road, Suite #3, Milton, Ontario L9T 0J8 | Tel: (905) 564-9422 | FAX: (905) 564-9436

Visit our web site: www.TacoComfort.com | Printed in USA | ©2015 Taco, Inc.

