



MANUAL

Models

STP-30-1/2	STP-45-1/2	STP-45-3	STP-75-3	STP-90-3
STP-35-1/2	STP-50-1/2	STP-60-3	STP-75-3-C1/3	STP-90-C1/3
STP-40-1/2		STP-60-C1/3		STP-120-3
				STP-150-3

Congratulations on your purchase of a SAWO Steam Generator. Please read the manual carefully before using the steam generator.

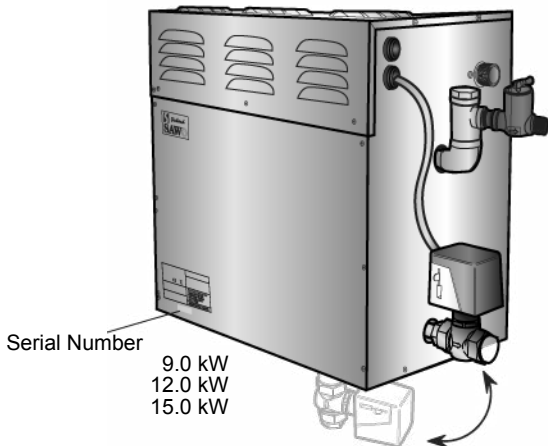
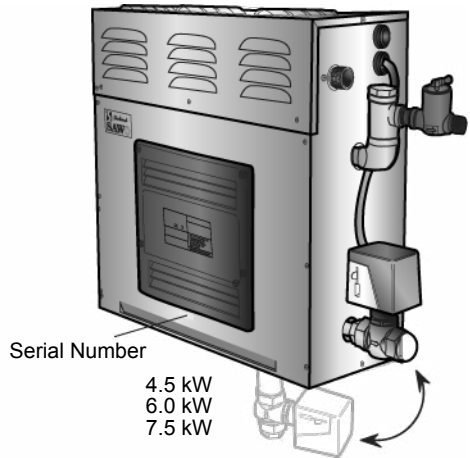
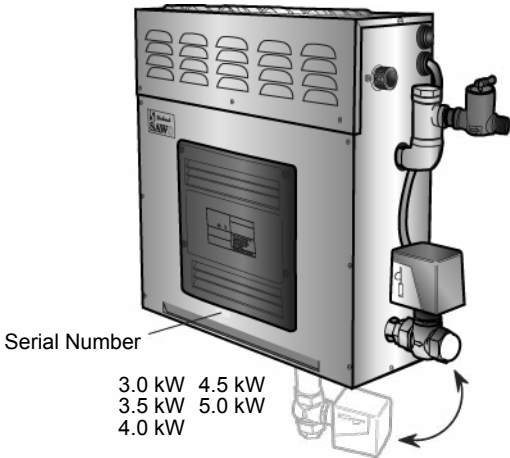

STEAM GENERATOR

SAWO Steam Generator

TABLE OF CONTENTS

Before Installation	2
Steam Room Guidelines	2
Steam Generator Parts	3
Instructions of Use	4
On/Off Mode	4
Standby Mode	5
Auto Drain Mode	5
Temperature / Timer	5
Key Lock	6
Changing the Values	6
Optional Features	6
Cabin Light / Dimmer	6
Fan	6
Scent Pump	7
Demand Button	7
Switching Between Different Modes	7
Maintenance	8
Decalcification	8
Level probe cleaning	9
Tank cleaning	9
Assembly and Installation	10
Plumbing	10
Steam Generator	11
Water Supply	11
Water Pressure	11
Connecting Water Filter and Softener	11
Steam Outlet	12
Steam Guard Overflow	12
Steam Head	12
Drain	13
Attaching Autodrain	13
Power Wiring	13
Technical Data	14
Electrical Diagram	14
Installing the Temperature Sensor	17
Installing Control Unit	18
Connection of SAWO Control to the PCB	19
Terminal Connection of Demand Button (optional)	20
DIP Switches in the Steam Generator	21
Steam Generator Series Connection	22
Troubleshooting	22

Before Installing

Use the following information together with the consultation of your contractor, architect or designer in determining all factors necessary in providing a suitable and safe steam room.

Check that the supply voltage is suitable to your steam generator.

Ensure that the steam generator kilowatt corresponds to the volume of your steam room. Refer to Technical Data (Page 14).

	<p>The voltage of the light output is 230VAC. Sawo recommends to use less than 50V for the steam room lightning. Use appropriate transformer for lower voltages. Sawo is not responsible of damages caused by using higher voltage inside the steam room.</p>
---	---

WARNING

Steam Room Guidelines

1. The Steam Room must be fully enclosed, complete with walls, door, flooring and ceiling.
2. Rubber linings (e.g. gaskets) are recommended for the door to effectively seal the heat and the steam inside the Steam Room.
3. If tiles are used for the flooring or some other smooth surface material, provide suitable anti-skid strips or rubberized mats to prevent slipping resulting to injury.
4. Materials used for the walls and ceiling should have water-resistant, non-corrosive surfaces such as tiles, marbles, molded acrylic, or other non-porous materials. The ceiling should be dome-shaped to prevent the dripping of condensate.
5. A drain must be provided in the flooring.
6. Heating, venting or air conditioning devices should not be installed inside the Steam Room.
7. Steam Room windows should be double paned.
8. Limit the Steam Room ceiling to a height of 2.5 meters. Exceeding 2.5m will require a higher-rated steam generator.
9. Floor drain for the steam generator must be available for maintenance.

Steam Generator Parts

For illustrative purposes only.

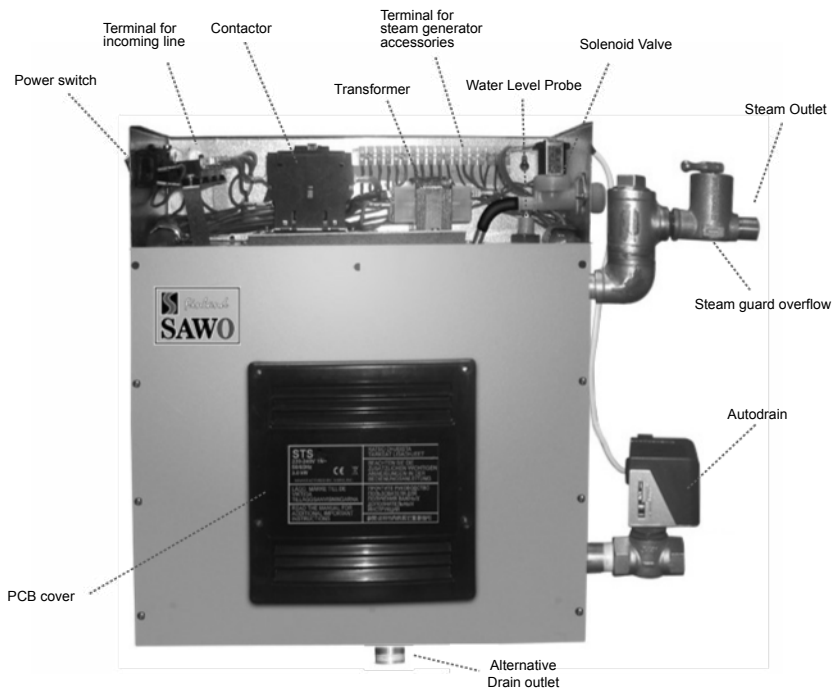

For illustrative purposes only.
Not for use for wiring. For
component identification only.

Instructions of Use

There are four different operation modes in the unit: Off, On, Standby and Drain. The user can easily switch between different modes, making the steam bathing more convenient with less energy consumption.

To use steam room the control unit needs to be in the On mode. In the On mode, the steamer is active, the temperature in the steam room will be kept in the preferred, set temperature, with occasional discharge of steam.

However, if the steam room is not used constantly, the generator can be set to Standby mode. The water in the tank is kept warm, with minimal energy usage. The generator is able to produce steam shortly after the unit is switch back to On mode for the convenience of the users.

More details about the different modes and how to move between them can be found in the text and graph following.



When the power switch is turned “On” the software versions of the control board and the user interface will be displayed for 1 second each. Then the control unit will go to “Off” mode. In the “Off” mode, the display is blank.

The auto drain can be disabled or enabled in the “Off” mode. Press and hold the Up button, then press the Power button. The display will show “Adr OFF” or “Adr on” as feedback.

On Mode

For “On” mode press “Power” button.

First, the set steam room temperature is displayed blinking for 5 seconds. Then the user can change the following settings; session time, temperature and fan (not all the models have the same features), by pressing the corresponding button in the control unit. The up and down arrow buttons can be used to increase and decrease the values.

If no buttons are pressed for 10 seconds, the set temperature for the steam room will be displayed.

When the session time expires, the control unit will go to the “Standby” mode.



Standby Mode

During the standby-mode the water in the steam generator tank is kept hot. This minimizes the time to produce steam when generator goes to on-mode next time.

Standby-mode can be activated by any of the following methods when the unit is in on-mode:

1. Short press "Standby" button
2. Short press "Power" button
3. When session time expires.

In standby-mode text "Standby" is displayed altering with the remaining standby time. To change remaining time press "up" or "down" arrow buttons. If the time is changed during the first 5 minutes after the activation of standby-mode, the time will be saved as a new default standby time.

To activate on-mode again short press the "standby" button

To go off-mode:

1. Press "Power" button for more than 3 seconds.
2. Press "Standby" button for more than 3 seconds to activate autodrain process, after which the unit goes automatically off-mode. (If autodrain feature is not available the unit will go off-mode)
3. Wait until remaining standby time expires and autodrain process (if available) completes

Auto drain Mode

The auto drain feature automatically drains the water system after every use. The tank is flushed and will remain empty until the steam generator is used again.

After the Standby time runs out, control unit automatically goes to Autodrain mode. When the drain cycle is activated, the generator's tank will be filled first. The water inside the tank will be cooled down, so the valve can be opened, as the water is not boiling hot anymore.

The draining process will take about 10 minutes.

User can cancel auto drain process whenever the water level in the tank is at normal or below normal level by pressing "power" button for more than 3 seconds.

To start Auto Drain in "On" mode press "Power" or "Standby" button followed by a long press (more than 3 seconds) of "Standby" button.



Temperature / Timer

The temperature/timer button can be used to switch between the temperature and session time.

When the steam generator is switched on, the set temperature at the steam room is displayed. It can be changed by pressing up and down buttons.

If the temperature/timer button is pressed, the remaining session time will be displayed. It can be changed by pressing up and down buttons. The session time will be saved as the default session time if it was changed within the first 5 mins from the beginning of "On" mode.

If the temperature/timer button is pressed again, the unit will return displaying the set temperature. In addition, if no buttons are pressed for 10 seconds, the set temperature of the steam room will be displayed.

Key Lock



Lock and unlock the key pad by pressing the up and down buttons at the same time for more than 5 seconds. A high beep will confirm the activation and the deactivation.

Only On/Off, Standby and Cabin light buttons are usable when the key pad is locked. If other buttons are pressed, “----” is shown in the display.

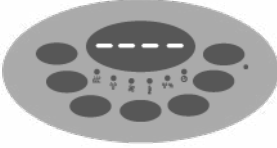

The key lock function is set automatically if it was left active during the previous operation.

Changing the values



Pressing the up or down button in the settings menu will in- or decrease the currently displayed value. A value cannot be in- or decreased above or below its maximum or minimum value, if it is tried low tone buzzer alarms the user.



The up and down buttons are repetitive. Holding the up or down button will cause the value to in- or decrease with an increased rate.

If no keys are pressed within 5 seconds, changes in the values are confirmed.

In the “On” mode, if no keys are pressed for 10 seconds, the display will automatically display the set temperature.

Optional Features

(Optional features are not available in every model)

Cabin Light / Dimmer



If the dimmer is not present and the cabin light button is pressed, it will switch the cabin light On/Off. When cabin light is ON red LED-indicator next to Cabin light button in the panel is lit.

If dimmer feature is available press “cabin light” button to turn cabin lights on and off. Light intensity value will be shown in the display and by pressing “up” or “down” arrows cabin light can be brighten or dimmed respectively.

If cabin lights are already turned on long press “cabin light” button to activate dimmer in order to change light intensity.

If no buttons are pressed within 5 seconds the last cabin light intensity value will be saved.

Fan



Fan can be operated in "On" and "Standby" modes. Long press (more than 3 seconds) "Fan/Scent" button in order to switch fan on/off.

Scent Pump



Before switching scent pump on make sure there is enough aroma in the aroma container. Never run the scent pump dry.

Scent pump can be operated in "On" mode only. In order to switch scent pump on/off short press "Fan/Scent" button. The Scent pump is allowed to be turned on only when the water in the tank is boiling.

Each time the scent pump is switched on the interval of the scent pump functioning is displayed. Interval can now be changed by pressing "up" or "down" arrow buttons between 1 (scent pump is activated every 20 mins) and 20 (pump on continuously). If no keys are pressed within 5 seconds, the previously displayed value will be shown again and the scent pump setting is saved.

If scent pump is on when the session time expires or the steam generator is turned off by pressing "power" button, scent pump will turn off too. Scent pump "on" and "interval" settings are saved and pump starts automatically on the next session.

To switch off the scent pump short press "Fan/Scent" button in "On" mode.

When the aroma oil is changed, check that the pipeline is not broken or it does not leak. It is also recommended to wash the fragrance container between changes, especially when using different fragrances.

The pump is easy to refill quickly: short press "Fan/Scent" button in "On" mode to activate interval value display. Press and hold "Up" arrow button to reach max. value 20 and scent pump will run continuously. It will take about 10 seconds for every 1 meter of pipeline for aroma liquid to reach the pump. As soon as the aroma liquid has reach the pump reset the pump functioning interval as preferred.

Use only fragrances meant for steam generator use. Follow the instructions in the fragrance packing.

Demand Button



A separate demand button can be installed on any desired location including inside the steam room. Press of the demand button will immediately release extra steam for 30 seconds.

Pressing the "Demand" button when the steam generator is in "Off" or Standby" mode will switch the control unit to "On" mode.

Switching Between Different Modes

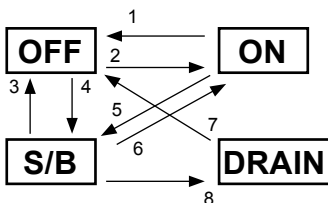

1. Press On/Off button for more than 3 seconds.
2. Press On/Off button or demand button.
3. Press On/Off button for more than 3 seconds.
4. Press Standby button.
5. Press On/Off button or Standby button or when the session time expires.
6. Press On/Off button or Standby button or demand button.
7. Press On/Off button for more than 3 seconds or when the drain time expires.
8. Press Standby button for more than 3 seconds or when the session time expires.

Maintenance

1. Decalcification

Tap water contains impurities, for example lime, that can cause calcium deposit and block the internal parts of the steam generator. To prevent this and prolong the lifetime of steam generator it is recommended to have a water filter and water softener. They are connected to the water source of the steam generator's water inlet.

SAWO Decalcifying Solution can be used for decalcification. Follow these guidelines to perform preventative maintenance of the steam generator.

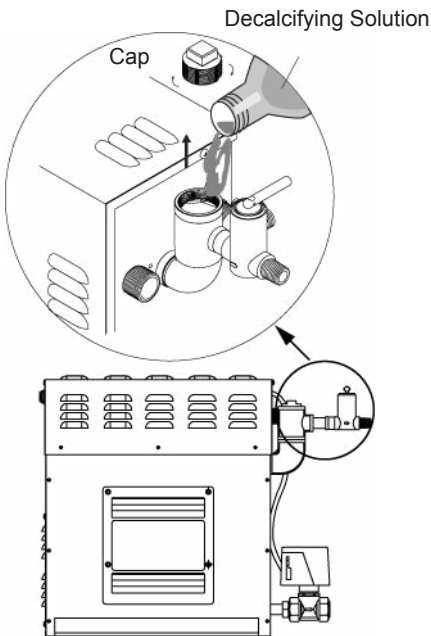
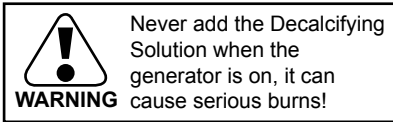

STP Classic:

1. Remove the cap of angled tube in the steam outlet piping. Before opening, make sure that the generator is off. Pour the solution into the water tank.
2. Turn ON the steam generator and wait until water inside the tank starts to boil. Let the solution boil 5 minutes.
- 3.1 If standby mode is available:
Press shortly Standby button. Steam generator goes to standby mode and after time expires, water will be drained automatically. After draining screen goes to OFF state.
- 3.2 If standby mode is not available:
Turn OFF the steam generator. Let the solution stay in the tank 30 minutes and then drain manually by pulling lever down.
4. Fill and drain the tank with water two times more.

STP Touch Control:

1. Turn ON the steam generator.
2. Go to Settings menu by pressing three seconds the settings icon. Scroll to the "Decalcifying" menu and press "Start". Confirm by pressing "OK".
3. Next process shows that water is filled in the tank. After water is filled, add decalcifying solution: open carefully the top cover of the angled tube and pour the solution slowly to the tank.
4. After pouring the solution, press "OK" on the screen. Steam generator will automatically go through decalcifying process including draining. After process is done, screen will go to off state.

Use Decalcifying Solution as follows:

Steam Generator (kW)	Decalcifying Solution (ml)
3-7.5	250
9-15	500

For steam generators in commercial use (over 5 hours continuously daily) additional service plan is recommended twice a year. Please contact your service center for details.

Frequency for decalcification:

Unit dH where 1 dH is 10 mg calcium in 1 liter of water

< 3 °dH = very soft water, decalcification every 500 operation hours

3-6 °dH = soft water, decalcification every 100 operation hours

6-9 °dH = hard water, decalcification every 50 operation hours

9-18 °dH = very hard water, decalcification every 30 operation hours

2. Level probe cleaning

- a. Disconnect steam generator from main supply before opening generator's covers. Only licensed electrician or professional maintenance person can open covers and do cleaning.
- b. Use adjustable wrench to deattach 3 wires from level probe. Make sure that when connecting wires back, wires are connected to right probes
- c. Use adjustable wrench to remove level probe. Clean tip of the pins from impurities using sandpaper. Don't damage plastic coating on pins. If coating is damaged, replace level probe. Tighten level probe by hands and use adjustable wrench only for final tightening.

3. Tank cleaning

Easy way of cleaning the tank.

- a. Disconnect steam generator from main supply before opening generator's covers. Only licenced electrician or professional maintenance person can open covers and do cleaning.
- b. Clean level probe as stated in 2.a to 2.b.
- c. Remove temperature fuse and tank temperature sensor from terminal block.
- d. Remove the cassette where the heating elements are attached and clean deposits from the element
- e. Remove deposits from bottom and sides of the tank. Open bottom plug to wash away deposits. Don't use autodrain valve since big particles can block autodrain valve.
- f. Attach bottom plug and use teflon pipe seal if needed
- g. Attach heating elements. Make sure that temperature fuse and tank tempesensor are on the top of heating element. Inserting heating element upside down will prevent the temperature fuse from working

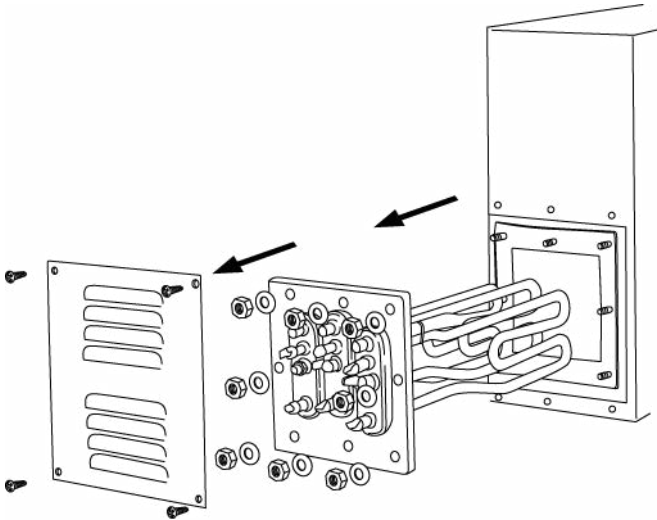

 WARNING	Do not overtighten the nuts that hold heating element cassette. Damaged nut can lead to leakage.
---	--

Assembly and Installation

1. Location of the steam generator has to be near the steam room. Place it within 7.5 meters to the steam room.
2. Steam generator has to be installed outside the steam room.
3. The steam generator must not be installed outdoors or areas that may damage the unit due to climate conditions.
4. Do not install the steam generator or plumbing lines in unheated attic or any locations where water could freeze.
5. The steam generator must not be installed in areas near flammable or corrosive materials or chemicals such as gasoline, paint thinners, chlorine or the like.
6. Provide a level surface to install steam generator. Side hole slots are provided for wall mounting. Make sure that the steam generator is secured and is level when mounted on the wall.
7. The steam generator has to be installed in an upright position only.
8. Install water filter and softener or alike when necessary.
9. Leave enough space for service and maintenance of the generator.

Minimum Space for Service and Maintenance

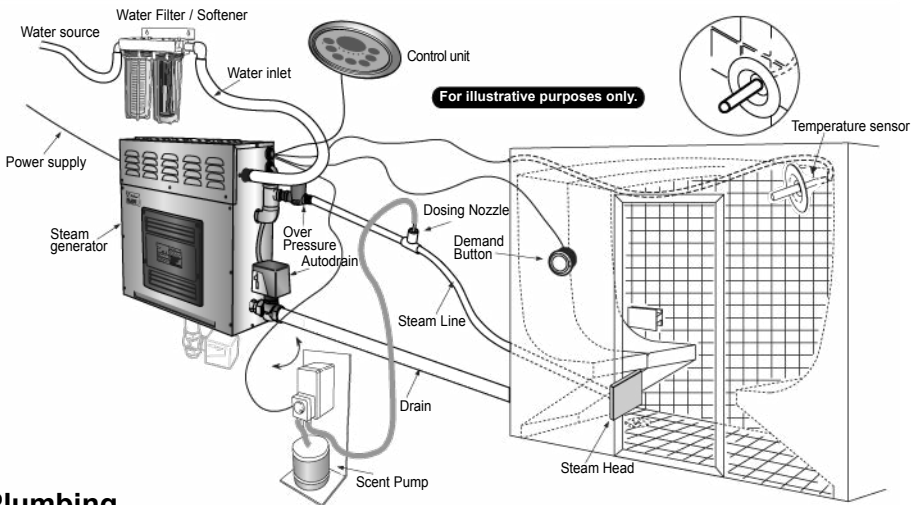
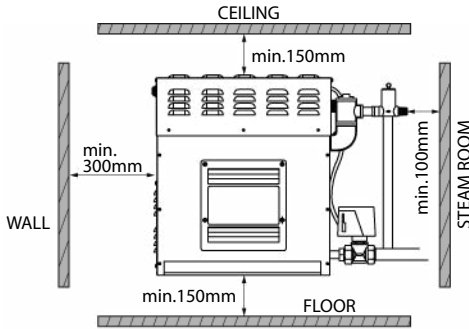

Plumbing

The plumbing has to be done by a qualified licensed plumber. Plumbing should be in accordance with national or local codes. Use unions for piping connections. Use only prescribed brass piping or copper tubing. Never use black or galvanized pipe for the plumbing as it can easily crack or damage.

Steam Generator

3.0 kW | 3.5 kW | 4.0 kW | 4.5 kW |
5.0 kW | 6.0 kW | 7.5 kW

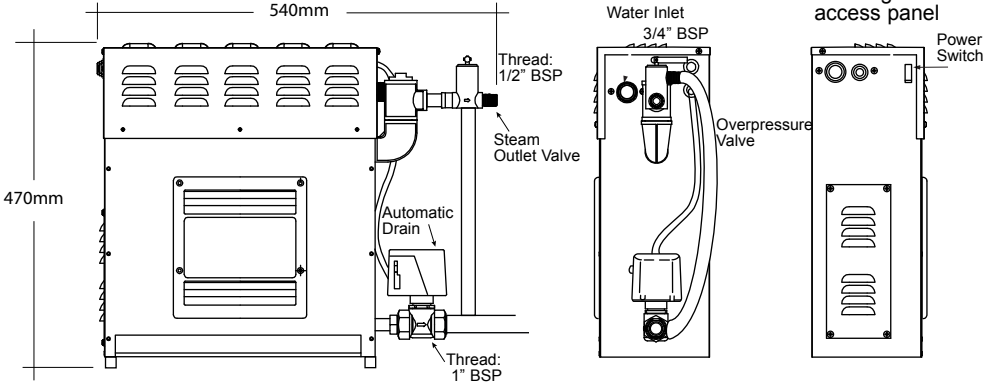

9.0 kW | 12.0 kW | 15.0 kW

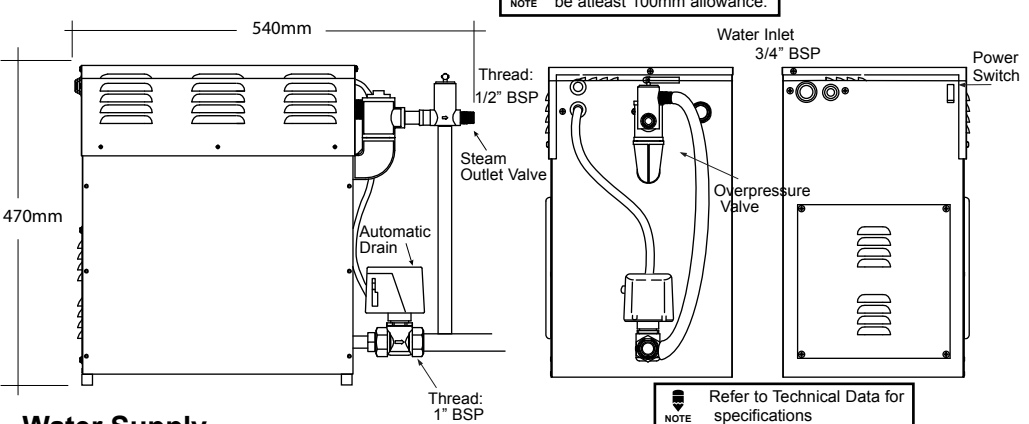

Water Supply

Provide a shut off valve on the water source for the steam generator. Turn off the inlet water line before installing the unit. Refer to the water filter's manual for the pressure requirement when installing. Maximum water pressure without water filter/softener is 8 bar. The water flow range must be at minimum of 4 liters per minute. Water softener is recommend to use.

Water Pressure

The water pressure required for the STP steam generators is 2-8 bar or 30-120psi. Below or above the pressure requirement may lead to damage or malfunction of the water inlet.

Connecting Water Filter and Softener

For illustrative purposes only.

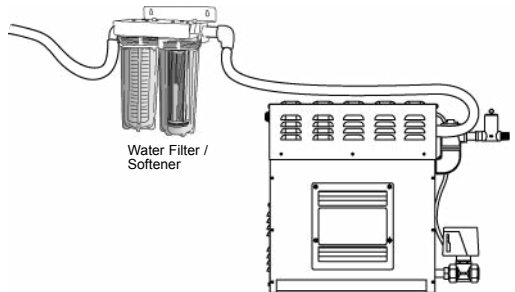

Steam Outlet

The steam must move in a continuous flow to the steam room. Do not install valves on the steam line. Use insulated, rated 120°C or higher, brass pipe or copper tubing for steam line to connect to the steam head as permitted by codes (see table below). Slope the steam line height by 20mm per meter towards the steam head to avoid trapping of the condensate and eliminate steam trap that blocks the flow of the steam.

Steam Guard Overflow

The overflow safety guard activates when there is an overpressure in the steam line. It automatically opens and releases the pressured steam. When this happens, please check your steam line for servicing.

Steam Head

Place the steam head on a safe area where bathers cannot get in contact with it as it can get very hot. The steam head must be facing downwards. A teflon tape or equivalent needs to be used on the thread for tightening it. Avoid using a wrench to tighten the steam head as it might get scratched.

Running the steam line down and then up will create a "steam trap" blocking the flow of the steam.

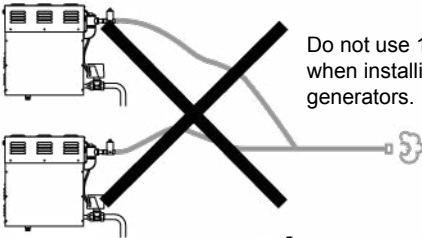
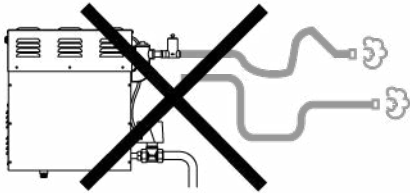

Do not use 1 steam line when installing 2 steam generators.

Use a Teflon or Sealant for the pipe threads (3/4" BSP)

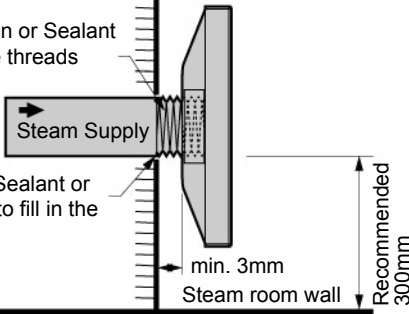

Place a Sealant or Silicone to fill in the gaps.

min. 3mm
Steam room wall

Recommended
300mm

Recommended Steam Head Location

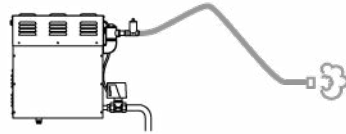
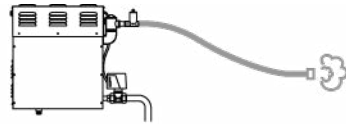
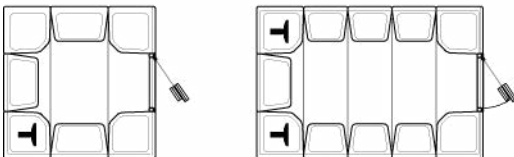

Steam Line sizes

kW	Steam Line
3 - 7,5	1/2"
9 and above	3/4"

Installation with multiple steam head

Add valve to each steam lines when installing multiple steam heads. This is to control the distribution of the steam inside the room.

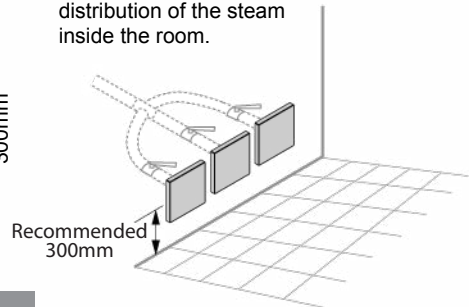

Recommended
300mm

Drain

Drain valve is provided for maintenance. Set drain connection for your steam generator according to national or local plumbing requirements. Use only 1" pipe for drain to avoid water clogged up.

Attaching the Autodrain

An extra outlet for the autodrain can be found under the steam generator.

1. Attach the Brass tee into the outlet that can be found on under and on the side of the steam generator.
2. An extra outlet for the autodrain can be found under the steam generator.
3. Attach the autodrain to the brass tee.
4. Open the cover of the steam generator.
5. Put the wire through the hole on the side of the steam generator.
6. Connect the wires in the terminal block to its label.
7. Cover back the steam generator.

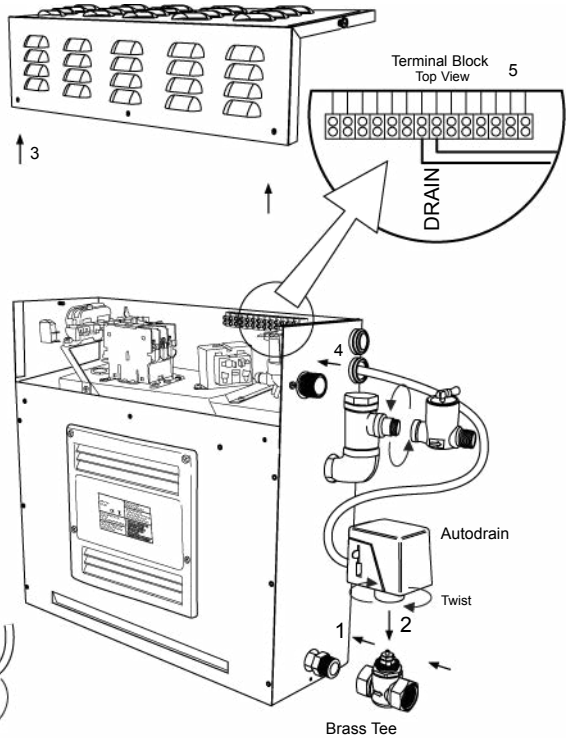

Power Wiring

Only a qualified electrician should do the Electrical wiring connections.

Check the power supply before installing your unit. Single Phase connection, a 220-240V supplied is required. Use two-wire supply source and equipment grounding wire of single phase connection.

A 90°C / 600V (HO7RN-F) rated insulated copper wire is required for SAWO steam generators. Check size of wires in Ampere Chart in accordance with the National Electrical Code and local electrical code.

The installation must include switch for all pole disconnection. Circuit breaker with 3mm control gap is recommended.

Technical Data

Model	kW	Steam Room Volume (m ³)	Heating Element		Voltage (V)	Current (A)	Phase	Wire Size mm ²	Size of Steam Generator (mm)			Weight (kg)
			(kW)	Type Number					Width	Depth	Height	
STP-30-1/2	3.0	3 max	2 x 1.5 kW	STG-150	220 - 240 / 380 - 415	14 / 8	1N / 2N	2.5 / 2.5	540	210	470	18
STP-35-1/2	3.5	3.5 max	1 x 1.5 kW 1 x 2.0 kW	STG-150 STG-200	220 - 240 / 380 - 415	16 / 9	1N / 2N	2.5 / 2.5	540	210	470	18
STP-40-1/2	4.0	4 max	2 x 2.0 kW	STG-200	220 - 240 / 380 - 415	18 / 10	1N / 2N	4.0 / 2.5	540	210	470	18
STP-45-1/2	4.5	2 - 5	1 x 2.0 kW 1 x 2.5 kW	STG-200 STG-250	220 - 240 / 380 - 415	20 / 12	1N / 2N	4.0 / 2.5	540	210	470	18
STP-45-3	4.5	2 - 5	3 x 1.5 kW	STG-150	380 - 415	7	3N	2.5	540	245	470	20
STP-50-1/2	5.0	2 - 6	2 x 2.5 kW	STG-250	220 - 240 / 380 - 415	22 / 8	1N / 2N	4.0 / 2.5	540	210	470	18
STP-60-3	6.0	3 - 10	3 x 2.0 kW	STG-200	380 - 415	9	3N	2.5	540	245	470	20
STP-60-C1/3	6.0	3 - 10	3 x 2.0 kW	STG-200	220 - 240 / 380 - 415	27 / 16 / 9	1N / 3 / 3N	6.0 / 2.5 / 2.5	540	245	470	20
STP-75-3	7.5	4 - 15	3 x 2.5 kW	STG-250	380 - 415	11	3N	2.5	540	245	470	20
STP-75-C1/3	7.5	4 - 15	3 x 2.5 kW	STG-250	220 - 240 / 380 - 415	34 / 20 / 11	1N / 3 / 3N	6.0 / 4.0 / 2.5	540	245	470	20
STP-90-3	9.0	8 - 20	6 x 1.5 kW	STG-150	380 - 415	13	3N	2.5	540	295	470	23
STP-90-C1/3	9.0	8 - 20	6 x 1.5 kW	STG-150	220 - 240 / 380 - 415	40 / 23 / 13	1N / 3 / 3N	10.0 / 4.0 / 2.5	540	295	470	23
STP-120-3	12.0	15 - 28	6 x 2.0 kW	STG-200	380 - 415	18	3N	4.0	540	295	470	23
STP-150-3	15.0	22 - 40	6 x 2.5 kW	STG-250	380 - 415	22	3N	4.0	540	295	470	23

PLS. NOTE: This table is for steam rooms built in with light walls (tempered glass or acrylic). Steam rooms with thick walls or ventilation, please use higher kilowatt steam generators.

Electrical Diagrams

CONVERTIBLE

3.0 kW | 3.5 kW | 4.0 kW | 4.5 kW | 5.0 kW

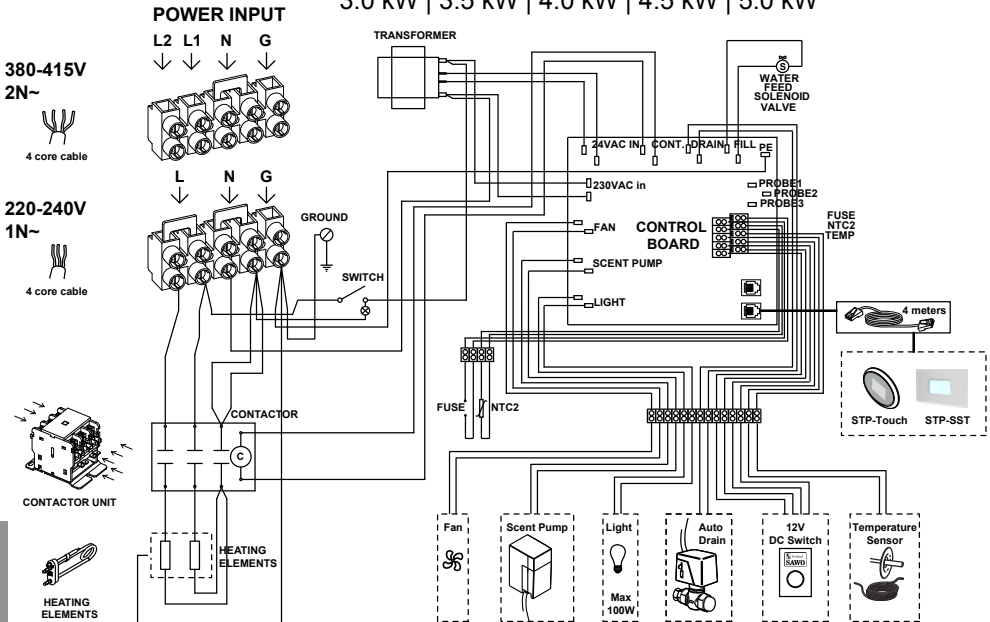

**380-415V
3N~**



**220-240V
3~**



**220-240V
1N~**

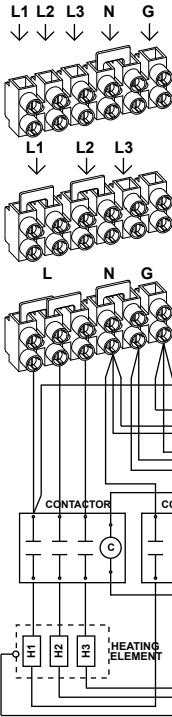
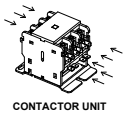

6.0 kW | 7.5 kW

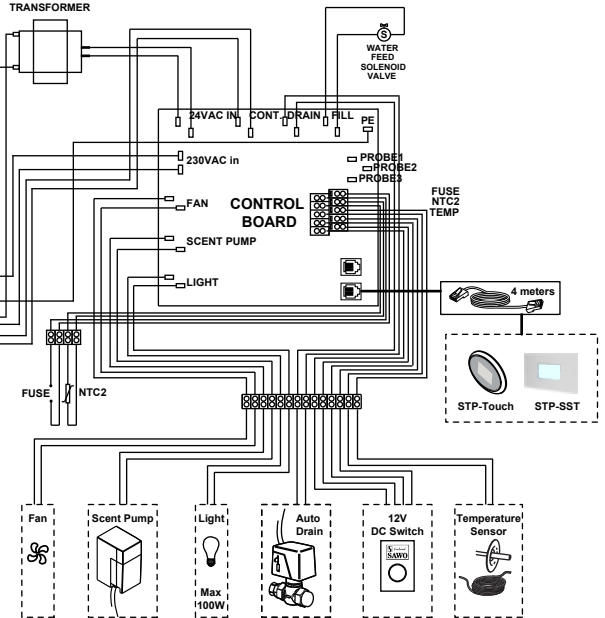

380-415V 3N~

4.5 kW | 6.0 kW | 7.5 kW

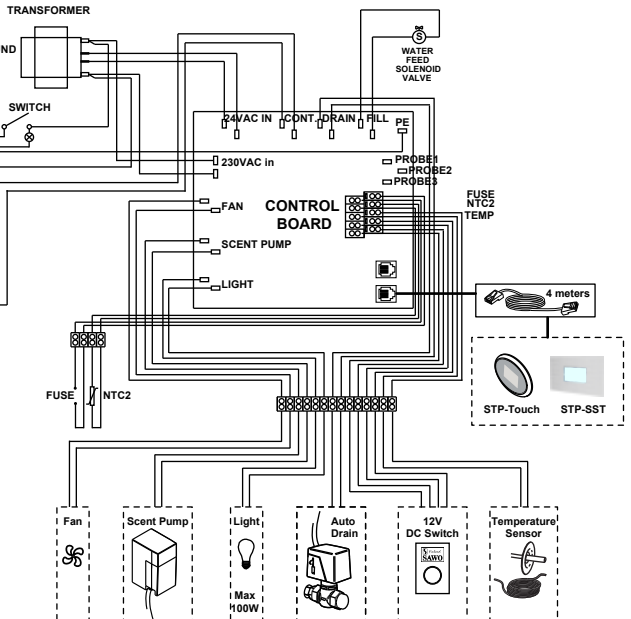
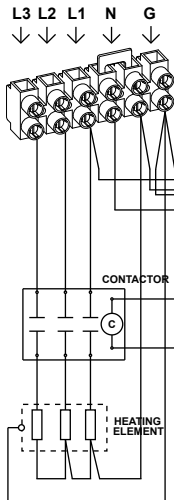

CONVERTIBLE

9.0 kW

380-415V
3N~

L1 L2 L3 N G



5 core cable

220-240V
3~



4 core cable

220-240V
1N~



3 core cable



CONTACTOR UNIT



HEATING ELEMENTS

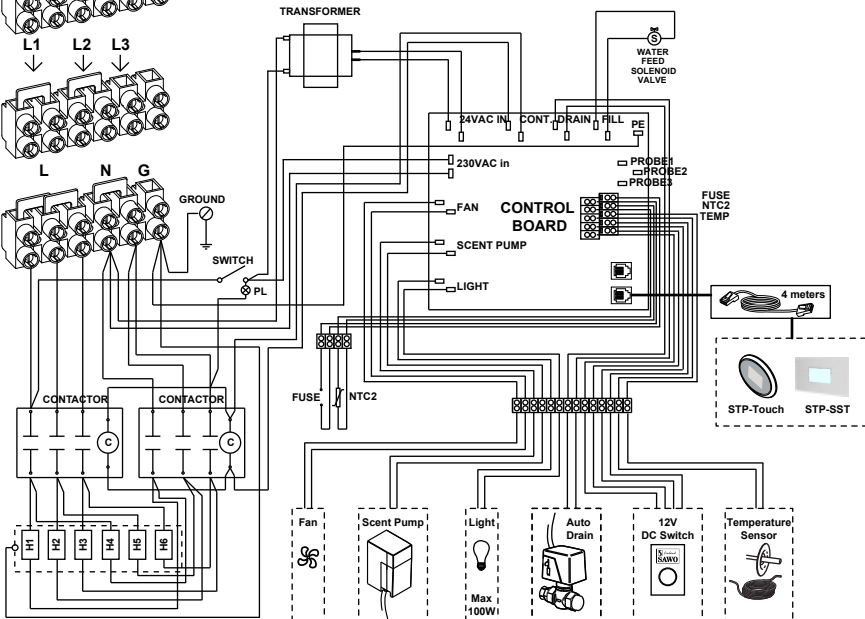
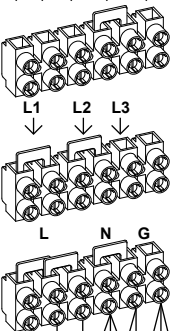

380-415V 3N~

9.0 kW | 12.0 kW | 15.0 kW

L3 L2 L1 N G



5 core cable

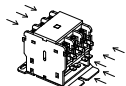

CONTACTOR UNIT



HEATING ELEMENTS

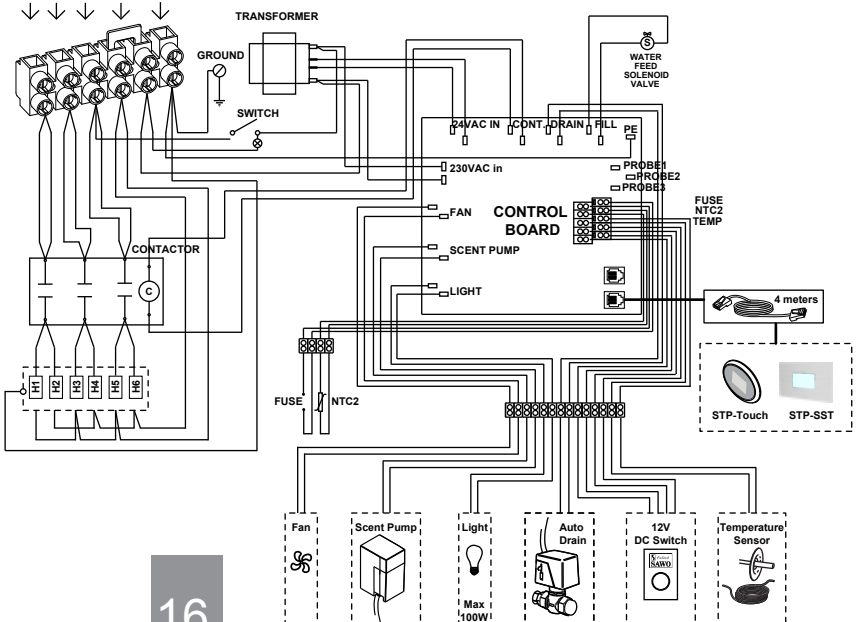

Installing the Temperature Sensor

Before installation main supply of the generator must be switch off from the circuit breaker.

The temperature sensor comes along with the SAWO steam generator. It is recommended to use only Sawo temperature sensor with Sawo generator as it may otherwise not function correctly. Temperature sensor wiring should not be routed near power cables or hot areas as it may cause electronic interference or damage to the wires.

The sensor has an integrated 9-meter cable. If longer cable is needed use 2 x 0.5 mm² to 2 x 1.0mm² cable for extension. (for illustrative purpose only)

1. The temperature sensor has to be installed:

Height 1.2-1.5 meters above the floor away from the steam head so that the steam will not hit the sensor directly.

2. An 25mm hole is required to insert the temperature sensor. Do not create bigger or smaller hole. Clean the hole before inserting the sensor.

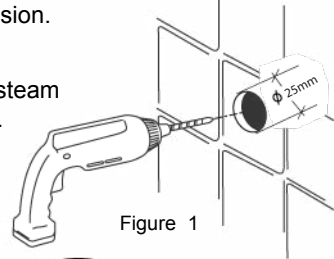

Figure 1

3. Make a hole in the cable lead-in on the side of the generator to pull the cable through. Connect the cable in the terminal block marked as "TEMP". See figure 2.

SAWO Steam Generator
(shown with cover removed)

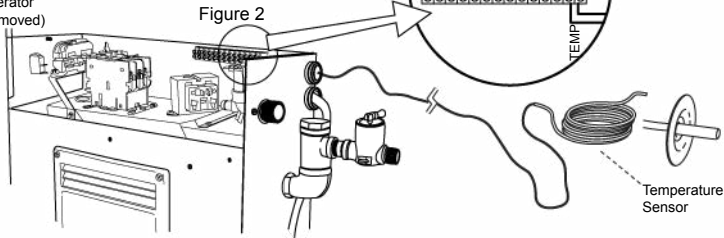
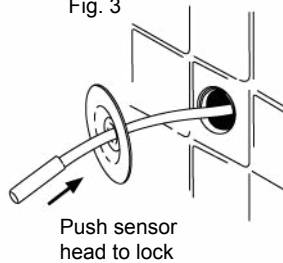

Figure 2

Temperature Sensor

4. Insert the temperature sensor through the steam room wall. Do not apply staples or other material that may damage the cable.

Fig. 3



5. Apply silicone sealant on the hole in the wall to create a moisture seal (Fig. 4). Make sure that there is no trace of silicone on the sensor as it may interfere its reading.

Fig. 4

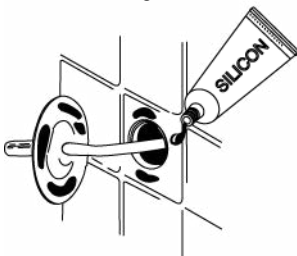
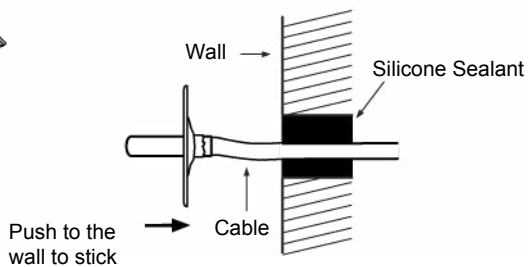

Fig. 5



Installing Control Unit

SAWO Steam Control sets the temperature of your steam room. Mount the steam control unit on an accessible area outside the steam room. It is recommended not to place the steam control near to showers or similar wet places.

Never attempt to modify or to fix the steam control. Ask your licensed technician or your nearest service centre for repair.

Before installation mains supply of the generator must be switch off from the circui breaker.

Installation Instructions

Check the most suitable area to place your steam generator control. The control and the steam generator should be accessible for the user and maintenance. Do not install the control unit inside the steam room! The cable of the control is 7.5 meters.

Mount the control in the wall, according to the specifications given below. Follow illustration.

 **NOTE** If the control is attached to a concrete wall, provide a control holder or equivalent to mount the control into it.

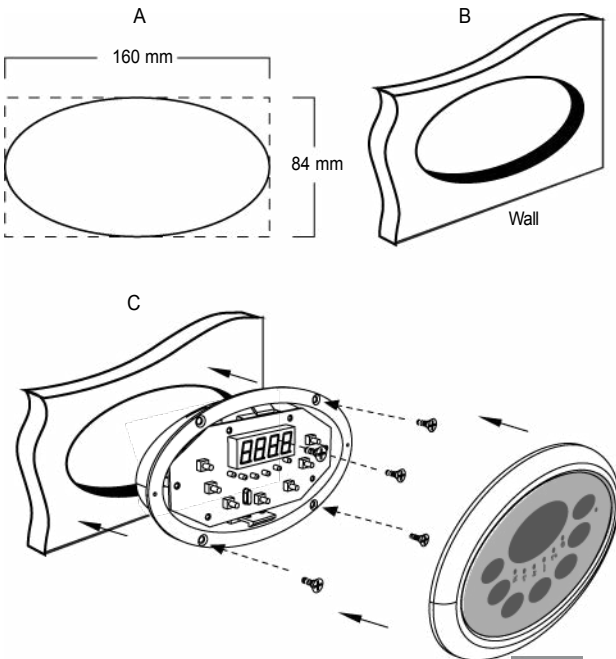

OPTIONAL
Interface Holders

Contact your SAWO distributor

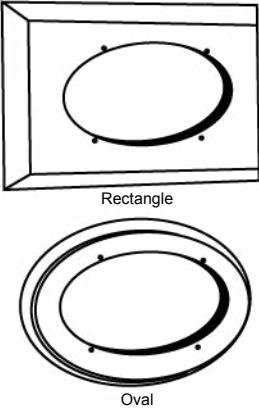

Rectangle

Oval

Connection of SAWO Control to the PCB.

Before installation make sure that the generator is disconnected from the mains by switching off the circuit breaker

1. Unscrew PCB cover on the side of the generator to get access on the PCB.
2. Guide the RJ12 control cable through the cable lead-in hole on the side of the generator and then behind the side panel as described in the drawing below to reach RJ jacks on the corner of PCB
3. Note that there are two black RJ jacks on the board. One is for the control cable and the other one for the optional slave unit. The control cable and slave cable can be connected to either of these jacks, the order is insignificant.

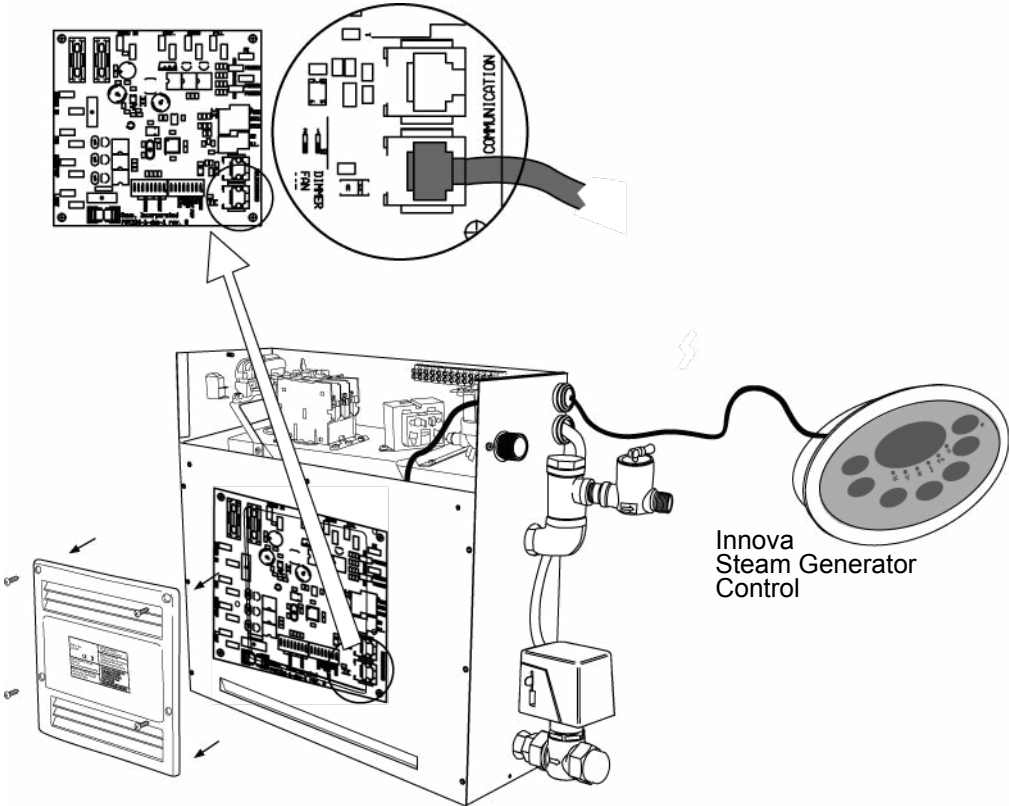

4. Fasten the PCB cover and the top cover of the generator
5. Turn the mains on and switch on the power switch in the back of the generator
6. The software version should be displayed in the control unit
7. Turn the control unit on "On" mode to check it works properly

Terminal Connection of Demand Button (optional)

Before installation make sure that the mains is disconnected from the generator by turning off the circuit breaker.

1. Open the top cover of the generator
2. Guide the cable through cable lead-in on the side of the generator.
3. Connect the wires to their designated places in the terminal block.
4. If the demand button has light connect the light wire on the "ILL" labeled terminal

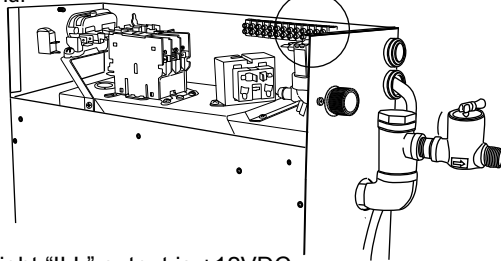
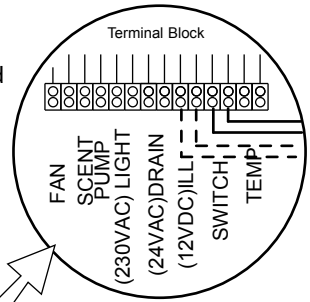

Make sure that polarity is right "ILL" output is +12VDC and 20mA.

<p style="text-align: center;">Light</p> <p style="text-align: center;">Max. 100W Power 230VAC</p> <p>If you have optional dimmer in steam generator, make sure that the ligths are dimmable before connecting. Steam generator uses phase control to regulate power for lighting.</p>	<p style="text-align: center;">Fan (optional)</p> <p style="text-align: center;">Max. P100W Power 230VAC</p>	<p style="text-align: center;">Scent Pump (optional)</p> <p style="text-align: center;">Max. P100W Power 230VAC</p>
---	---	--

DIP Switches in the Steam Generator

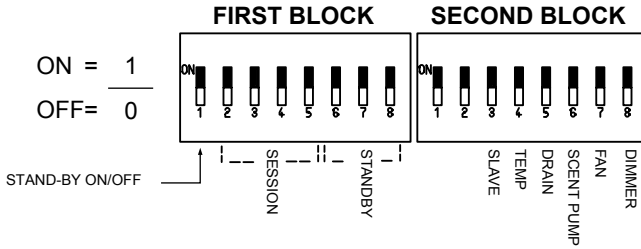

Standby time

Standby time can be set according to user preferences by setting dip switches on the power controller board

Standby Duration Mode	Switch 6	Switch 7	Switch 8
4h	0	0	0
6h	0	0	1
12h	0	1	0
18h	0	1	1
Unlimited	1	0	0
4h	1	0	1
4h	1	1	0
4h	1	1	1

Session Time

Session time can be set according to user preferences by session dip switches on the power controller board.

Session Time	Switch 2	Switch 3	Switch 4	Switch 5
10min	0	0	0	0
15min	0	0	0	1
20min	0	0	1	0
30min	0	0	1	1
45min	0	1	0	0
1h	0	1	0	1
2h	0	1	1	0
4h	0	1	1	1
6h	1	0	0	0
8h	1	0	0	1
12h	1	0	1	0
18h	1	0	1	1
Unlimited	1	1	0	0
10min	1	1	0	1
10min	1	1	1	0
10min	1	1	1	1

First Block of 8 Switches

DIP No.	Function
8	Standby mode duration
7	Standby mode duration
6	Standby mode duration
5	Maximum session time
4	Maximum session time
3	Maximum session time
2	Maximum session time
1	Disable standby mode / Enable standby mode

Dipswitches for other Functions

Dipswitch No.:	Function	On	Off
8	Cabin Light	Dimmer option enabled	Dimmer option disabled
7	Fan	Present	Not Present
6	Scent Pump	Present	Not Present
5	Auto Drain	Connected	Not Connected
4	Temperature range	30-55°C	30-50°C
3	Slave Unit	Yes	No
2	Slave Number		
1	Slave Number		

Dipswitches for Naming Slaves

Slave No.	Switch 1	Switch 2
1	0	0
2	0	1
3	1	0
4	1	1

Steam Generator Series Connection

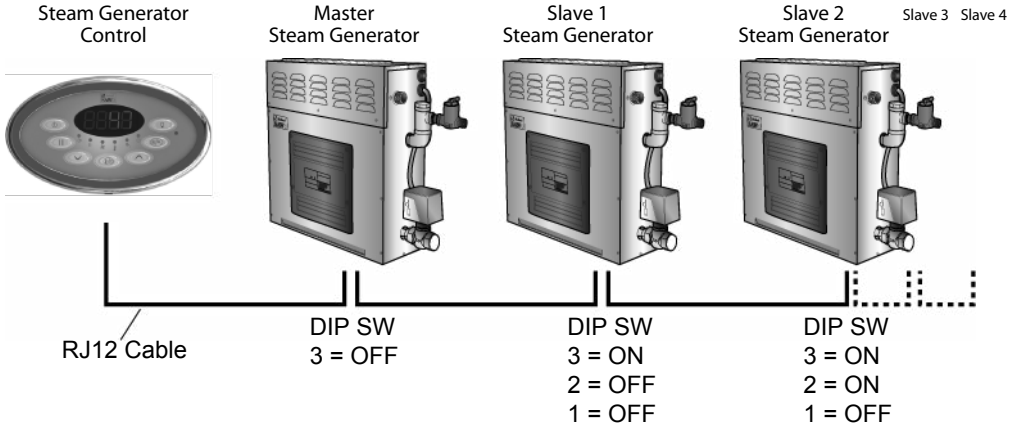

Troubleshooting

If an error occurs, the steam generator will be switched off. There will be a warning beep to alarm the user every 2 seconds. The code for the error will be displayed blinking in the control panel, see the table below.

Please note, only a qualified electrician or maintenance personnel are allowed to make the service operations and repairs!

If an error occurs in one of the slave units, error message is followed by slave number. For example: E1 -> S2 -> E1 ->S2... Pressing ON/OFF button disables the slave and rest of the generators can operate normally.

Possible errors are:

Code	Problem	Solution
E1	Temperature sensor 1 not connected.	Check the wire between the sensor and the control unit.
E2	Temperature sensor 1 short circuit.	If there is no problem with the wires and they are correctly installed, check the sensor.
E3	Temperature sensor 2 not connected.	
E4	Temperature sensor 2 short circuit.	If no problem can be found, contact the retailer.
E5	Temperature fuse defect.	Check the wire between the fuse and the control unit. Fuse has probably overheated. The reason for it needs to be discovered before using the steam generator again. A new fuse is needed.
		If no problem can be found, contact the retailer.

Code	Problem	Solution
E6	Water level too high and operation not permitted.	Check that the drain valve is not blocked. Clean the level probes. If no problem can be found, contact the retailer.
E7	Water level too low and operation not permitted.	Check that water supply is open and there is enough pressure. Check solenoid valve. Clean level probes. If no problem can be found, contact the retailer.
E8	Illogical combination of water level measurements.	Clean level probes. If no problem can be found, contact the retailer.
E9	Fill failure	Check that water supply is open and there is enough pressure. Check solenoid valve. Clean level probes. If no problem can be found, contact the retailer.
E10	Drain failure	Check that the drain valve is connected and not blocked. Clean the level probes. If no problem can be found, contact the retailer.
E11	Communication failure.	Check the RJ12 cable. If the area where cable is located has many other cables, it can cause EMC problems. If no problem can be found, contact the retailer.
E12	Temperature is greater than the maximum temperature.	Contact qualified electrician or maintenance personnel before using the steam generator again.
E13	No master steam generator connected	Dip switch setting is incorrect. Check dip switch settings. Check RJ12 for loose contact. Replace RJ12. If no problem can be found, contact the retailer.



www.sawo.com
info@sawo.com



Subject to change without notice.