

▲WARNING: This water heater is not suitable for use in manufactured (mobile) homes!

Use & Care Manual

With Installation Instructions for the Installer

Compliant with South Coast Air Quality Management District Rule 1146 14 ng/J NOx Emissions

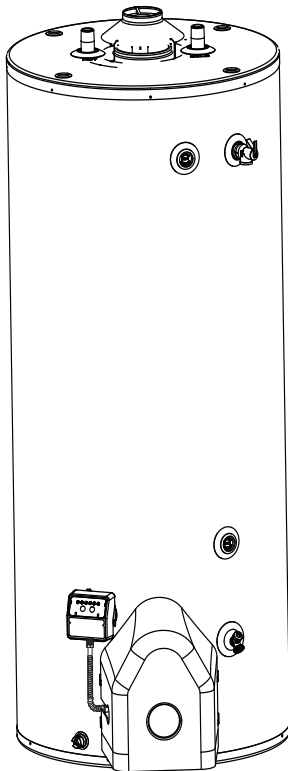

Low NOx Emissions

Gas Water Heaters

75 and 98 Gallon

FVIR Certified

The purpose of this manual is twofold: one, to provide the installer with the basic directions and recommendations for the proper installation and adjustment of the water heater; and two, for the owner-operator, to explain the features, operation, safety precautions, maintenance and troubleshooting of the water heater. This manual also includes a parts list.

It is imperative that all persons who are expected to install, operate or adjust this water heater read the instructions carefully so they may understand how to perform these operations. If you do not understand these instructions or any terms within it, seek professional advice.

Any questions regarding the operation, maintenance, service or warranty of this water heater should be directed to the seller from whom it was purchased. If additional information is required, refer to the section on "If you need service."

Do not destroy this manual. Please read carefully and keep in a safe place for future reference.



Recognize this symbol as an indication of Important Safety Information!



California Proposition 65 Warning: This product contains chemicals known to the State of California to cause cancer, birth defects or other reproductive harm.



WARNING: If the information in these instructions is not followed exactly, a fire or explosion may result causing property damage, personal injury or death.

▲ FOR YOUR SAFETY!

- Do not store or use gasoline or other flammable vapors or liquids or other combustible materials in the vicinity of this or any other appliance. To do so may result in an explosion or fire.

— WHAT TO DO IF YOU SMELL GAS

- Do not try to light any appliance.
- Do not touch any electrical switch; do not use any phone in your building.
- Immediately call your gas supplier from a neighbor's phone. Follow the gas supplier's instructions.

If you cannot reach your gas supplier, call the fire department.

Do not return to your home until authorized by the gas supplier or fire department.

- Improper installation, adjustment, alteration, service or maintenance can cause property damage, personal injury, or death. Refer to this manual. Installation and service must be performed by a qualified installer, service agency or the gas supplier.



Printed in USA

DO NOT RETURN this water heater to the store or place of purchase. If you need technical or installation assistance, please call the Technical Support Lines at 1-800-432-8373.

AP16412 (05/12)

Safety Information

Safety Precautions 3–6
LP Gas Models 5

Installation Instructions

Location 7
Water Supply Connections . . . 9
Gas Supply 11
Pipe Insulation 13
Heat Traps 13
Wiring Diagram 14
Installation Checklist 17
Potable/Space Heating 18

Operating Instructions

Lighting Instructions 19
Water Temperature 20, 21

Care and Cleaning

Draining 23
Maintenance 23
Burner Inspection 24
Extended Shut-Down 24

Troubleshooting Tips

Before You Call
For Service 25, 26

Customer Service

Parts List 31
If You Need Service 32



FOR YOUR RECORDS

Write the model and serial numbers here:

You can find them on a label on the appliance.

Staple sales slip or cancelled check here.

Proof of the original purchase date is needed to obtain service under the warranty.



READ THIS MANUAL

Inside you will find many helpful hints on how to use and maintain your water heater properly. A little preventive care on your part can save you time and money over the life of your water heater.

You'll find many answers to common problems in the **Troubleshooting Guide**. If you review the chart of **Troubleshooting Tips** first, you may not need to call for service.



READ THE SAFETY INFORMATION

Your safety and the safety of others are very important. There are many important safety messages in this manual and on your appliance. Always read and obey all safety messages.

 **This is the safety alert symbol. Recognize this symbol as an indication of Important Safety Information!**
This symbol alerts you to potential hazards that can kill or hurt you and others.

All safety messages will follow the safety alert symbol and either the word "DANGER", "WARNING", "CAUTION" or "NOTICE".

These words mean:

 **DANGER** An imminently hazardous situation that will result in death or serious injury.

 **WARNING** A potentially hazardous situation that could result in death or serious injury and/or damage to property.

 **CAUTION** A potentially hazardous situation that may result in minor or moderate injury.

NOTICE: Attention is called to observe a specified procedure or maintain a specific condition.

IMPORTANT SAFETY INFORMATION. READ ALL INSTRUCTIONS BEFORE USING.

Be sure to read and understand the entire Use and Care Manual before attempting to install or operate this water heater. It may save you time and money. Pay particular attention to the Safety Instructions. Failure to follow these warnings could result in serious bodily injury or death. Should you have problems understanding the instructions in this manual, or have any questions, STOP, and get help from a qualified service technician, or the local gas utility.

DANGER!

INSTALL THE DRAFT HOOD AND PROPERLY VENT THE WATER HEATER...

Failure to install the draft hood and properly vent the water heater to the outdoors as outlined in the Venting Section of the Installation Instructions in this manual can result in unsafe operation of the water heater. To avoid the risk of fire, explosion, or asphyxiation from carbon monoxide, never operate this water heater unless it is properly vented and has an adequate air supply for proper operation. Be sure to inspect the vent system for proper installation at initial start-up; and at least annually thereafter. Refer to the Care and Cleaning section of this manual for more information regarding vent system inspection.

WARNING!

Gasoline, as well as other flammable materials and liquids which include, but are not limited to (adhesives, solvents, paint thinners etc.), and the vapors they produce are extremely dangerous. DO NOT handle, use or store gasoline or other flammable or combustible materials anywhere near or in the vicinity of a water heater or any other appliance. Be sure to read and follow warning label pictured below and other labels on the water heater, as well as the warnings printed in this manual. Failure to do so can result in property damage, bodily injury or death.

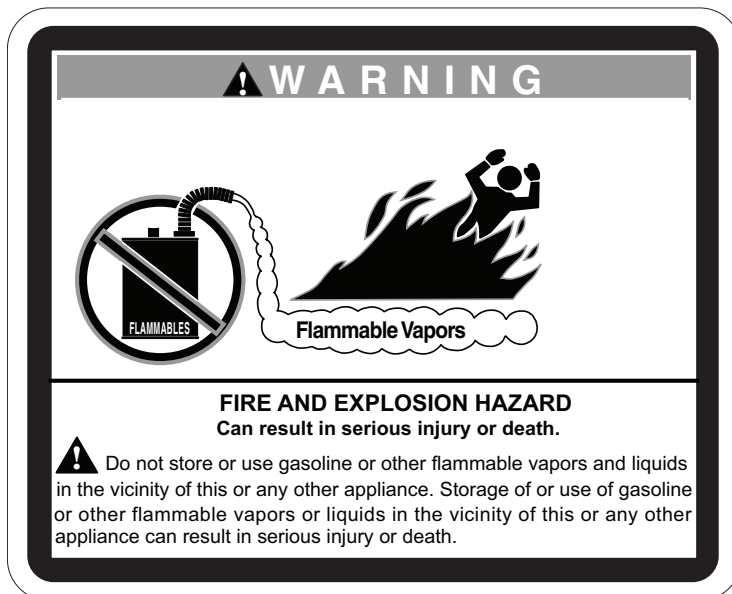

IMPORTANT SAFETY INFORMATION. READ ALL INSTRUCTIONS BEFORE USING.



! DANGER!

WATER TEMPERATURE SETTING

Safety and energy conservation are factors to be considered when selecting the water temperature setting of a water heater's gas control. Water temperatures above 125°F can cause severe burns or death from scalding. Be sure to read and follow the warnings outlined on the label pictured below. This label is also located on the water heater.

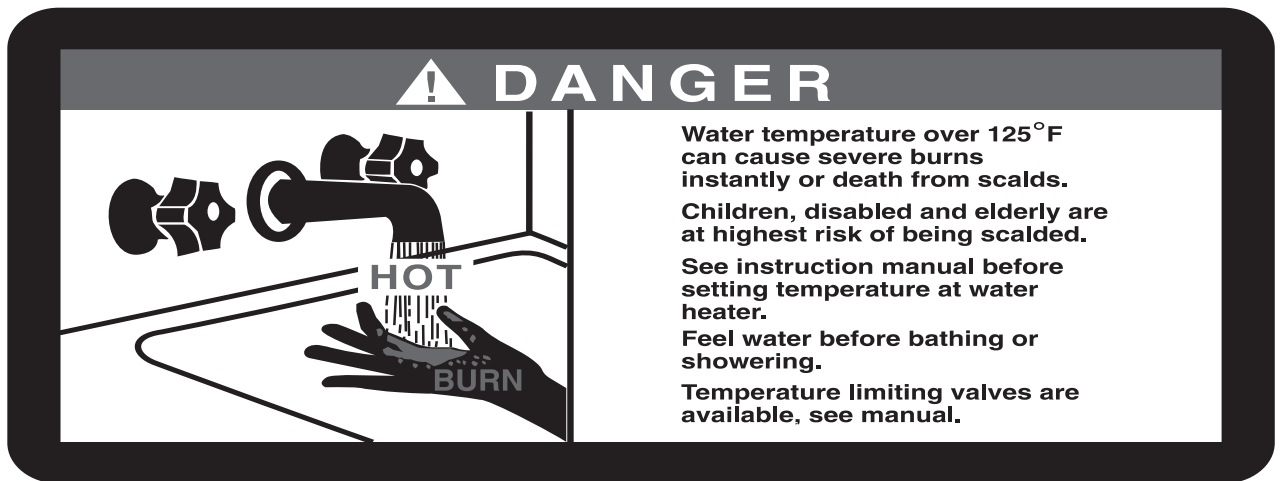

Time/Temperature Relationship in Scalds

Water Temperature	Time To Produce a Serious Burn
120°F	More than 5 minutes
125°F	1½ to 2 minutes
130°F	About 30 seconds
135°F	About 10 seconds
140°F	Less than 5 seconds
145°F	Less than 3 seconds
150°F	About 1½ seconds
155°F	About 1 second

Table courtesy of Shriners Burn Institute

NOTICE: Mixing valves are available for reducing point of use water temperature by mixing hot and cold water in branch water lines. Contact a licensed plumber or the local plumbing authority for further information.

! DANGER: Hotter water increases the potential for Hot Water SCALDS.

The chart shown above may be used as a guide in determining the proper water temperature for your home.

! DANGER: Households with small children, disabled, or elderly persons may require a 120°F or lower gas control (thermostat) setting to prevent contact with "HOT" water.

Maximum water temperatures occur just after the burner has shut off. To find water temperature being delivered, turn on a hot water faucet and place a thermometer in the water stream and read the thermometer. (See page 20 and 21 for more details.)

The temperature of the water in the heater can be regulated by setting the temperature dial on the front of the Combination Gas Control (thermostat). To comply with safety regulations the Combination Gas Control (thermostat) was set at its lowest setting before the water heater was shipped from the factory.

The illustration on the following page details the approximate water temperature for each LED indicator of the Combination Gas Control (thermostat).

Thermostat Water Temperature Details

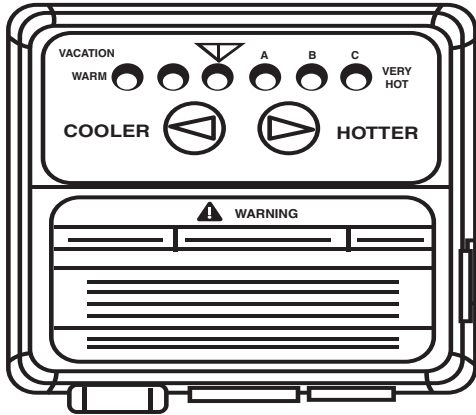

⚠ DANGER: Hotter water increases the potential for Hot Water SCALDS.

Temperature Setting for 160°F Thermostat	Display ▼ A B C	Burns on Adult Skin
WARM = approx. 70°F (21°C)	● ○ ○ ○ ○ ○	-----
▼ = approx. 120°F (49°C)	○ ○ ● ○ ○ ○	More than 5 minutes
A = approx. 130°F (54°C)	○ ○ ○ ● ○ ○	About 30 seconds
B = approx. 140°F (60°C)	○ ○ ○ ○ ● ○	Less than 5 seconds
C = approx. 150°F (66°C)	○ ○ ○ ○ ○ ●	About 1-1/2 seconds
C-Flashing = approx. 160°F (71°C)	○ ○ ○ ○ ○ ●	About 1/2 seconds

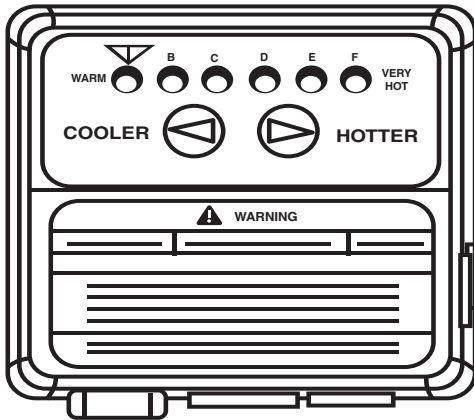

⚠ DANGER: Hotter water increases the potential for Hot Water SCALDS.

Temperature Setting for 180°F Thermostat	Display ▼ B C D E F	Burns on Adult Skin
▼ = approx. 120°F (49°C)	● ○ ○ ○ ○ ○	More than 5 minutes
B = approx. 130°F (54°C)	● ● ○ ○ ○ ○	About 30 seconds
C = approx. 140°F (60°C)	○ ● ○ ○ ○ ○	Less than 5 seconds
D = approx. 150°F (66°C)	○ ○ ● ○ ○ ○	About 1-1/2 seconds
E = approx. 160°F (71°C)	○ ○ ○ ● ○ ○	About 1/2 seconds
F = approx. 170°F (77°C)	○ ○ ○ ○ ● ○	-----
F = approx. 180°F (82°C)	○ ○ ○ ○ ○ ●	-----

IMPORTANT SAFETY INFORMATION. READ ALL INSTRUCTIONS BEFORE USING.



! DANGER!

LIQUEFIED PETROLEUM (LP) AND NATURAL GAS MODELS

LP and Natural gas have an odorant added to aid in detecting a gas leak. Some people may not physically be able to smell or recognize this odorant. If you are unsure or unfamiliar with the smell of LP or natural gas, ask the gas supplier. Other conditions, such as “odorant fade”, which causes the odorant to diminish in intensity, can also hide or camouflage a gas leak.

Water heaters utilizing LP gas are different from natural gas models. A natural gas water heater will not function safely on LP gas and vice versa.

No attempt should ever be made to convert the water heater from natural gas to LP gas. To avoid possible equipment damage, personal injury or fire, do not connect the water heater to a fuel type not in accordance with the unit data plate. LP for LP units. Natural gas for natural gas units. These units are not certified for any other fuel type.

LP appliances should not be installed below grade (for example, in a basement) if such installation is prohibited by federal, state and/or local laws, rules, regulations or customs.

LP gas must be used with great caution. It is heavier than air and will collect first in lower areas making it hard to detect at nose level.

Before attempting to light the water heater, make sure to look and smell for gas leaks. Use a soapy solution to check all gas fittings and connections. Bubbling at a connection indicates a leak that must be corrected. When smelling to detect a gas leak, be sure to sniff near the floor also.

Gas detectors are recommended in LP & natural gas applications and their installation should be in accordance with the detector manufacturer’s recommendations and/or local laws, rules, regulations or customs.

It is recommended that more than one method, such as soapy solution, gas detectors, etc., be used to detect leaks in gas applications.

! DANGER: If a gas leak is present or suspected:

DO NOT attempt to find the cause yourself.

DO NOT try to light any appliance.

DO NOT touch any electrical switch.

DO NOT use any phone in your building.

Leave the house immediately and make sure your family and pets leave also.

Leave the doors open for ventilation and contact the gas supplier, a qualified service agency or the fire department.

Stay away from the house (or building) until the service call has been made, the leak is corrected and a qualified agency has determined the area to be safe.

WARNING!

For your safety, the information in this manual must be followed to minimize the risk of fire or explosion, electric shock, or to prevent property damage, personal injury, or loss of life.



FOR INSTALLATIONS IN THE STATE OF CALIFORNIA

California Law requires that residential water heaters must be braced, anchored or strapped to resist falling or horizontal displacement due to earthquake motions. For residential water heaters up to 52-gallon capacity, a brochure with generic earthquake bracing instructions can be obtained from: Office of the State Architect, 1102 Q Street, Suite 5100, Sacramento, CA 95814 or you may call 916-445-8100 or ask a water heater dealer.

However, applicable local codes shall govern installation. For residential water heaters of a capacity greater than 52 gallons, consult the local building jurisdiction for acceptable bracing procedures.



SAFETY PRECAUTIONS

Have the installer show you the location of the gas shut-off valve and how to shut it off if necessary. Turn off the manual shut-off valve if the water heater has been subjected to overheating, fire, flood, physical damage or if the gas supply fails to shut off.

Read this manual entirely before installing or operating the water heater.

Use this appliance only for its intended purpose as described in this Use and Care Manual.

Be sure your appliance is properly installed in accordance with local codes and the provided installation instructions.

DO NOT attempt to repair or replace any part of your water heater unless it is specifically recommended in this manual. All other servicing should be referred to a qualified technician.



READ AND FOLLOW THIS SAFETY INFORMATION CAREFULLY.

SAVE THESE INSTRUCTIONS

Installing the water heater.

This water heater must be installed in accordance with these instructions, local codes, utility company requirements, and/or in the absence of local codes, use the latest edition of the American National Standard/National Fuel Gas Code. A copy can be purchased from either the American Gas Association, 400 N. Capitol Street NW, Washington, DC 20001 as ANSI standard Z223.1 or National Fire Protection Association, 1 Batterymarch Park, Quincy, MA 02269 as booklet NFPA 54.

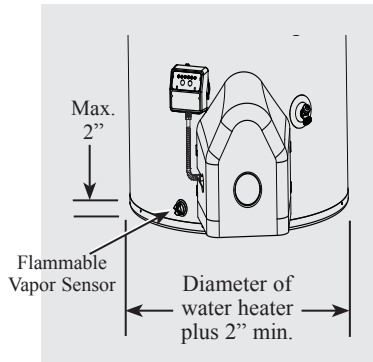

The auxiliary catch pan installation **MUST** conform to local codes.

NOTICE: DO NOT allow the flammable vapour sensor to become submerged in water. Make sure the catch pan is properly drained.

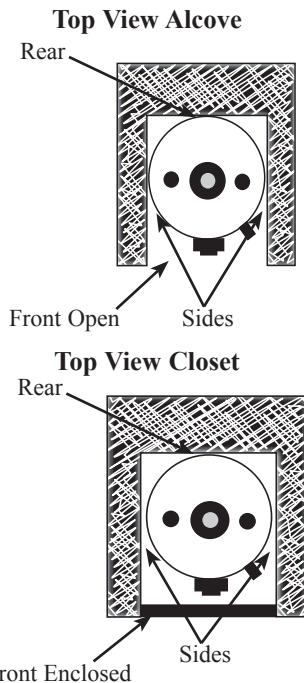

▲WARNING: Combustible construction refers to adjacent walls and ceilings and should not be confused with combustible or flammable products and materials. Combustible and/or flammable products and materials should never be stored in the vicinity of this or any gas appliance.

Location

The water heater should not be located in an area where leakage from the tank or connections will result in damage to the area adjacent to the heater or to lower floors of the structure.

When such areas cannot be avoided it is recommended that a suitable catch pan, adequately drained, must be installed under the water heater.

The pan must not restrict air flow to the combustion air inlet openings (perforation openings) located around the lower perimeter of the water heater.

Catch pan kits are available from the store where the water heater was purchased, or any water heater distributor.

Make certain the floor underneath the water heater is strong enough to sufficiently support the weight of the water heater once it is filled with water.

A gas fired water heater or any other appliance should not be installed in a space where liquids which give off flammable vapors are to be used or stored. Such liquids include gasoline, LP gas (butane or propane), paint or adhesives and their thinners, solvents or removers.

DO NOT block or obstruct the Flammable Vapor Sensor.

Because of natural air movement in a room or other enclosed space, flammable vapors can be carried some distance from where liquids which give off flammable vapors are to be used or stored. The open flame of the water heater's main burner can ignite these vapors and create a **shut down condition of the water heater which will not allow the water heater to ignite until examined by a Qualified Service Technician.**

FVIR certified gas water heaters can be installed on a residential garage floor without the use of an 18-inch stand in accordance with the National Fuel Gas Code, NFPA 54, ANSI Z223.1, unless otherwise directed by State and Local code requirements. The water heater must be located so it is not subject to physical

damage, for example, by moving vehicles, area flooding, etc

- The water heater should be installed as close as practical to the gas vent or chimney.
- Long hot water lines should be insulated to conserve water and energy.
- The water heater and water lines should be protected from exposure to freezing temperatures.
- **DO NOT** install the water heater in bathrooms, bedrooms, any occupied rooms normally kept closed, or in unprotected outdoor areas.
- Minimum clearance from combustible construction:

Location	Front*	Sides	Rear	Top**
Alcove	3" (7.6 cm)	0" (0 cm)	0" (0 cm)	12" (30.5 cm)
Closet	3" (7.6 cm)	0" (0 cm)	0" (0 cm)	12" (30.5 cm)

* "Front" Clearance dimension is measured from the water heater jacket to the closet door.

** "Top" clearance dimension is measured from the jacket top of the water heater to the ceiling.

If the clearances stated on the Instruction/Warning Label, located on the front of the heater differ, install the water heater according to the clearances stated on the label.

- If the water heater is installed in an alcove or closet, the entire floor must be covered by a wood or metal panel. A minimum of 24" clearance from the front and top should be available for adequate inspection and servicing.
- The water heater may be installed on combustible floors, but not directly on carpeting. If the water heater must be installed on carpeting, place a metal or wood panel beneath the water heater, extending beyond its full width and depth at least 3" in all directions.

Inspect Shipment

Carefully inspect the water heater for damage before proceeding with the installation. Of specific interest should be any dents or damage to the blower or plenum assembly. If you find damage,

DO NOT install or attempt any repair to the water heater. Contact the manufacturer as detailed under "IF YOU NEED SERVICE" on page 32.

Combustion and Ventilation Air

Proper operation of the water heater requires air for combustion and ventilation. Provisions for combustion and ventilation air must comply with referenced codes and standards.

When installed in a closet, DO NOT block or obstruct any of the combustion air inlet openings located around the perimeter of the outer door. A minimum of 1" is required between these combustion air inlet openings and any obstruction.

NOTICE: If the water heater is installed in an unconfined space within a building of conventional frame, masonry or metal construction, infiltration air is normally adequate for proper combustion and ventilation. If the water heater is installed in a confined space, provisions for combustion and ventilation air must be made.

A confined space is one having a volume of less than 50 cubic feet per 1000 Btuh of the aggregate input of all appliances within that space.

The air must be supplied through two permanent openings of equal area. One is to be located within 12" above the floor and the other is to be located within 12" from the ceiling.

The minimum net free area of each opening must not be less than one square inch per 1000 Btuh of the total input rating of all the appliances in the enclosure

(but not less than 100 square inches), if each opening communicates with other unconfined areas inside the building.

Buildings of unusually tight construction shall have the combustion and ventilation air supplied from outdoors, or a freely ventilated attic or crawl space.

If air is supplied from outdoors, directly or through vertical ducts, there must be two openings located as specified above and each must have a minimum net free area of not less than one square inch per 4000 Btuh of the total input rating of all the appliances in the enclosure.

If horizontal ducts are used to communicate with the outdoors, each opening must have a minimum net free area of not less than one square inch per 2000 Btuh of the total input rating of all the appliances in the enclosure. If ducts are used, the minimum dimensions of rectangular air ducts shall not be less than 3".

NOTICE: If the duct openings which supply combustion and ventilation air are to be covered with a protective screen or grill, the net free area (openings in the material) of the covering material must be used in determining the size of the openings. Protective screening for the openings MUST NOT be smaller than 1/4" mesh to prevent clogging by lint or other debris.

NOTICE: The water heater should not be installed near an air supply containing halogenated hydrocarbons.

Corrosive Atmospheres

The air in beauty shops, dry cleaning establishments, photo processing labs, and storage areas for liquid and powdered bleaches or swimming pool chemicals often contain such halogenated hydrocarbons.

An air supply containing halogenated hydrocarbons may be safe to breathe, but when it passes through a gas flame corrosive elements are released that

will shorten the life of any gas burning appliance.

Propellants from common spray cans or gas leaks from A/C and refrigeration equipment are highly corrosive after passing through a flame.

The water heater warranty is voided when failure of the heater is due to operation in a corrosive atmosphere.

Installing the water heater.

Thermal Expansion

Determine if a check valve exists in the inlet water line. Check with your local water utility company. It may have been installed in the cold water line as a separate back flow preventer, or it may be part of a pressure reducing valve, water meter or water softener. A check valve located in the cold water inlet line can cause what is referred to as a **“closed water system”**. A cold water inlet line with no check valve or back flow prevention device is referred to as an **“open”** water system.

As water is heated, it expands in volume and creates an increase in the pressure within the water system. This action is referred to as **“thermal expansion”**. In an **“open”** water system, expanding water which exceeds the capacity of the water heater flows back into the city main where the pressure is easily dissipated.

A **“closed water system”**, however, prevents the expanding water from flowing back into the main supply line, and the result of **“thermal expansion”** can create a rapid and dangerous pressure increase in the water heater and

system piping. This rapid pressure increase can quickly reach the safety setting of the relief valve, causing it to operate during each heating cycle. Thermal expansion, and the resulting rapid, and repeated expansion and contraction of components in the water heater and piping system can cause premature failure of the relief valve, and possibly the heater itself. Replacing the relief valve **will not** correct the problem!

The suggested method of controlling thermal expansion is to install an expansion tank in the cold water line between the water heater and the check valve (see illustration below). The expansion tank is designed with an air cushion built in that compresses as the system pressure increases, thereby relieving the over pressure condition and eliminating the repeated operation of the relief valve. Other methods of controlling thermal expansion are also available. Contact your installing contractor, water supplier or plumbing inspector for additional information regarding this subject.

IMPORTANT: Do not apply heat to the HOT or COLD water connections. If sweat connections are used, sweat tubing to adapter before fitting adapter to the cold water connections on heater. Any heat applied to the cold water supply fittings will permanently damage the dip tube and the heat traps in the hot/cold nipples.

NOTICE: The National Fuel Gas Code (NFGC) mandates a manual gas shut-off valve: See (NFGC) for complete instructions. Local codes or plumbing authority requirements may vary from the instructions or diagrams provided and take precedent over these instructions.

Water Supply Connections

Refer to the illustration below for suggested typical installation. The installation of unions or flexible copper connectors is recommended on the hot and cold water connections so that the water heater may be easily disconnected

for servicing if necessary. The HOT and COLD water connections are clearly marked and are 1” NPT on all models. Install a shut-off valve in the cold water line near the water heater.

Typical Installation

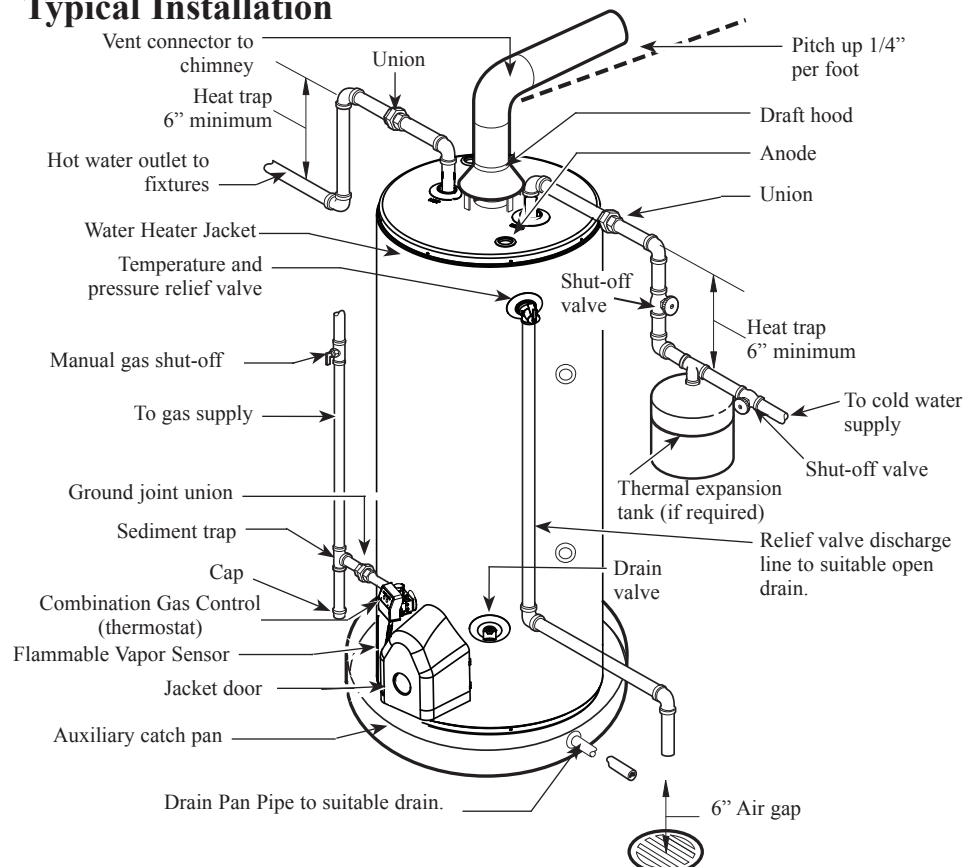

A new combination temperature and pressure relief valve, complying with the Standard for Relief Valves and Automatic Gas Shut-Off Devices for Hot Water Supply Systems, ANSI Z21.22, is supplied and must remain in the opening provided and marked for the purpose on the water heater. No valve of any type should be installed between the relief valve and the tank. Local codes shall govern the installation of relief valves.

Relief Valve

The pressure rating of the relief valve must not exceed 150 PSI, the maximum working pressure of the water heater as marked on the rating plate.

The Btuh rating of the relief valve must equal or exceed the Btuh input of the water heater as marked on its rating plate.

Position the outlet of the relief valve above a suitable open drain to eliminate potential water damage. Piping used should be of a type approved for hot water distribution.

The discharge line must be no smaller than the outlet of the valve and must pitch downward from the valve to allow complete drainage (by gravity) of the relief valve and discharge line.

The end of the discharge line should not be threaded or concealed and should be protected from freezing. No valve of any type, restriction, or reducer coupling should be installed in the discharge line.

▲WARNING: The tank must be full of water before heater is turned on. The water heater warranty does not cover damage or failure resulting from operation with an empty or partially empty tank.

To Fill the Water Heater

Make certain that the drain valve is closed, then open the shut-off valve in the cold water supply line.

Open each hot water faucet slowly to allow the air to vent from the water heater and piping.

A steady flow of water from the hot water faucet(s) indicates a full water heater.

Condensation

Condensation can form on the tank when it is first filled with water.

Condensation might also occur with a heavy water draw and very cold inlet water temperatures.

Drops of water falling on the burner can produce a sizzling or pinging sound.

This condition is not unusual, and will disappear after the water becomes heated. If, however, the condensation continues, examine the piping and fittings for possible leaks.

Installing the water heater.

⚠WARNING: Do not attempt to convert this water heater for use with a different type of gas other than the type shown on the rating plate. Such conversion could result in hazardous operating conditions.

Gas Supply

The branch gas supply line to the water heater should be clean properly sized black steel pipe or other approved gas piping material.

A union or ANSI design certified semi-rigid or flexible gas appliance connector should be installed in the gas line close to the water heater. The National Fuel Gas Code (NFGC) mandates a manual gas shut-off valve: See (NFGC) for complete instructions.

Compound used on the threaded joints of the gas piping must be of the type resistant to the action of LP gas. Use compound sparingly on male threads only.

Where a sediment trap is not incorporated as part of the appliance, a sediment trap shall be installed downstream of the equipment shutoff valve as close to the

inlet of the appliance as practical at the time of the appliance installation. The sediment trap shall be either a tee fitting with a capped nipple in the bottom outlet or other device recognized as an effective sediment trap. Do not use excessive force (over 31.5 ft lbs.) in tightening the pipe joint at the Combination Gas Control (thermostat) inlet, particularly if teflon pipe compound is used, as the valve body may be damaged.

The inlet gas pressure to the water heater must not exceed 14" w.c. for natural gas. For purposes of input adjustment, the minimum inlet gas pressure (with main burner on) is shown on the water heater rating plate. If high or low gas pressures are present, contact your gas supplier for correction.

⚠WARNING: Never use an open flame to test for gas leaks, as property damage, personal injury, or death could result.

Leak Testing

The water heater and its gas connections must be leak tested at normal operating pressures before it is placed in operation.

- 1 Turn on the manual gas shut-off valve near the water heater.
- 2 Use a soapy water solution to test for leaks at all connections and fittings. Bubbles indicate a gas leak that must be corrected.

The factory connections to the gas control (thermostat) should also be leak tested after the water heater is placed in operation.

Pressure Testing the Gas Supply System

The water heater and its manual gas shut-off valve must be disconnected from the gas supply piping system during any pressure testing of that system at pressures in excess of 3/8 psi (10.5" w.c.) for natural gas.

The water heater must be isolated from the gas piping system by closing the manual gas shut-off valve during any pressure testing of the gas supply piping at pressures equal to or less than 3/8 psi (10.5" w.c.) for natural gas.

⚠WARNING: Failure to install a water heater suitable for the altitude at the location it is intended to serve, can result in improper operation of the appliance resulting in property damage and/or, producing carbon monoxide gas, which could result in personal injury, or death.

High Altitude

This water heater is certified for installations up to 8,500 feet above sea level.

⚠WARNING: Installations above 8,500 feet are not authorized and may result in improper and inefficient operation of the appliance, producing carbon monoxide gas in excess of acceptable limits, which could result in serious injury or death.

The water heater must be installed with the factory supplied draft hood in place.

▲DANGER: Failure to install the draft hood and properly vent the water heater to the outdoors as outlined in the Venting section of this manual will result in unsafe operation of the water heater causing bodily injury, explosion, fire or death. To avoid the risk of fire, explosion, or asphyxiation from carbon monoxide, NEVER operate the water heater unless it is properly vented and has adequate air supply for proper operation as outlined in the Venting Section of this manual.

Venting

Vent connectors must be attached to the draft hood outlet to connect the water heater to the gas vent or chimney. The vent connectors must be the same size (diameter) as the draft hood or larger, never smaller.

For proper venting in certain installations a larger vent connector size may be needed. Consult the latest version of the National Fuel Gas Code (ANSI Z223.1/NFPA 54).

Horizontal vent connectors must be pitched upward to the chimney at least 1/4" per foot of length. Single wall vent connectors must be at least 6" from adjacent unprotected combustible surface. Vent joints must be securely fastened by sheet metal screws or other approved method.

Test for spillage at the draft hood relief opening after 5 minutes of main burner operation. Use a flame of a match or candle or smoke. The flame or smoke should be pulled into the draft hood's relief opening(s).

▲WARNING: If local codes require external application of insulation blanket kits the manufacturer's instructions included with the kit must be carefully followed.

Insulation Blankets

Insulation blankets, available to the general public, for external use on gas water heaters are not necessary. The purpose of an insulation blanket is to reduce the standby heat loss encountered with storage tank heaters. This water heater meets or exceeds the National Appliance Energy Conservation Act standards with respect to insulation and standby loss requirements making an insulation blanket unnecessary.

The manufacturer's warranty does not cover any damage or defect caused by installation, attachment or use of any type of energy saving or other unapproved devices (other than those authorized by the manufacturer) into, onto or in conjunction with the water heater. The use of unauthorized energy saving devices may shorten the life of the water heater and may endanger life and property.

The manufacturer disclaims any responsibility for such loss or injury resulting from the use of such unauthorized devices.

▲CAUTION: If local codes require the application of an external insulation blanket to this water heater, pay careful attention to the following so as not to restrict the proper function and operation of the water heater:

- **DO NOT** cover the operating or warning labels attached to the water heater or attempt to relocate them on the exterior of insulation blanket.
- **DO NOT** apply insulation to the top of the water heater. This will interfere with the safe operation of the draft hood.
- **DO NOT** cover the burner access door, jacket door, gas control (thermostat)/gas valve or pressure and temperature relief valve.
- **DO NOT** apply insulation to the bottom of the water heater or the area where the combustion air inlet openings are located. This area must be unobstructed so as not to restrict combustion air flow to the burner.
- **DO NOT** apply insulation to the area where the flammable vapor sensor is located. This area must be unobstructed so as not to restrict air flow to the sensor.
- Inspect the insulation blanket frequently making certain it has not sagged and is restricting the air flow to the combustion air inlet openings located around the perimeter of the water heater outer door. This could result in an unsafe operating condition.

Installing the water heater.

Wiring

This water heater may be connected to electric service with the power cord provided (**DO NOT** use an extension cord). A grounding receptacle is required.

If local codes do not permit the use of cord connections, a 120 V, 50/60 Hz power supply, with suitable disconnecting means, must be connected to the black and white leads in the blower assembly.

The maximum current draw is less than 5.0 amps.

The water heater must be electrically grounded in accordance with local codes, or, in the absence of local codes, in accordance with latest edition of the National Electric Code ANSI/NFPA No. 70 in US and for Canada the Canadian Electrical Code CSA C22.1. Refer to the figures below for water heater internal wiring.

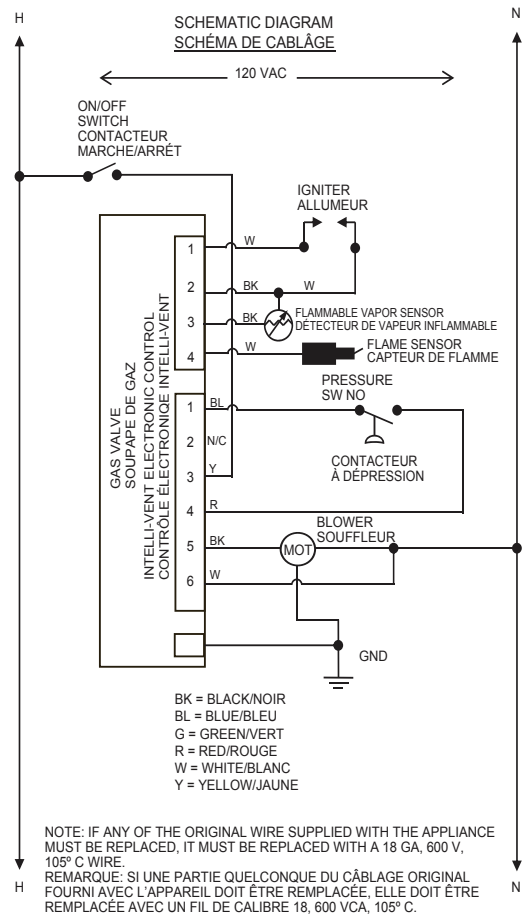
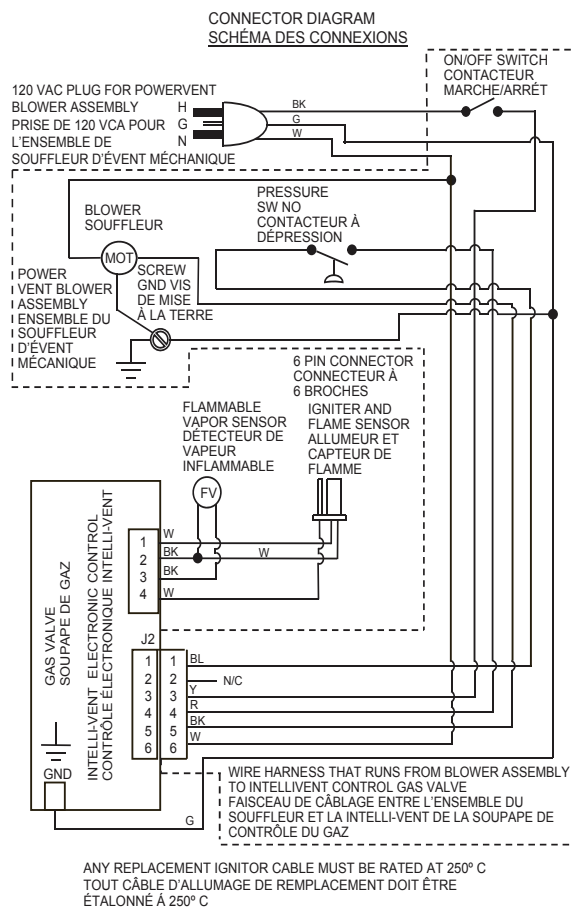

120V 50/60 Hz LESS THAN 5 AMPS

⚠ CAUTION! Wiring errors can cause improper and dangerous operation. VERIFY PROPER OPERATION AFTER SERVICING!

Hot and Cold Pipe Insulation Installation

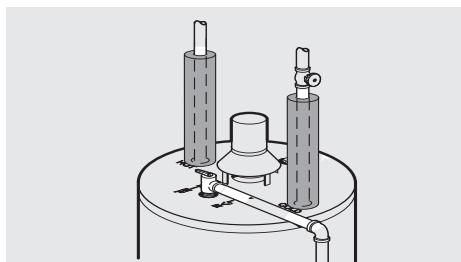

Typical vertical piping arrangement

For increased energy efficiency, some water heaters have been supplied with two 24" sections of pipe insulation. Please install the insulation, according

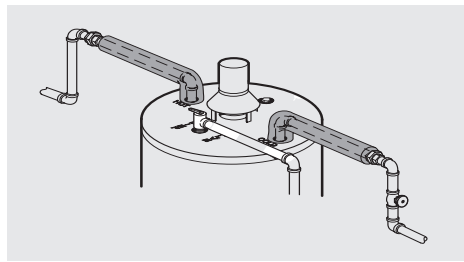

Typical horizontal piping arrangement

to the illustrations above, that best meets your requirements.

Temperature & Pressure Relief Valve (T&P) Insulation Installation

For increased energy efficiency, this water heater has been supplied with a 2 3/8" section of T&P insulation. Please install the insulation as shown below.

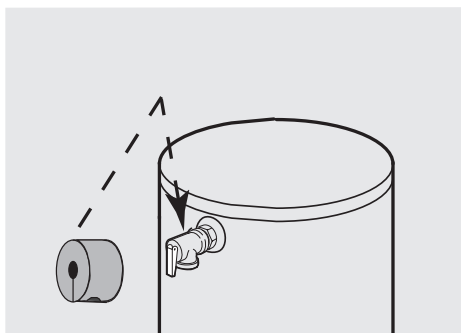

Typical Side Connect T & P Arrangement.

Slip the insulation cover over the T&P Valve through the center hole and align the hole in the side with the opening of the T&P Valve.

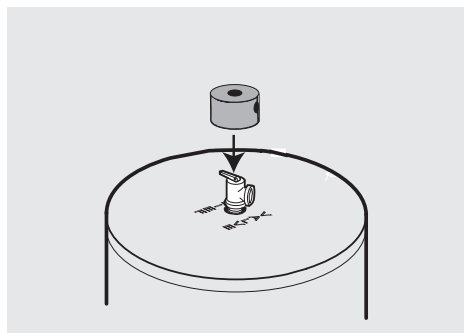

Typical Top Connect T & P Arrangement.

Ensure the T&P Valve opening is not obstructed by the insulation.

Heat Traps

For increased energy efficiency, some water heaters have been supplied with heat traps for installation in the hot outlet line and cold water inlet line.

These heat traps may require a minimum of one (1) 90° elbow and may require an additional 90° elbow or a 3/4" coupling depending on your installation needs. See Illustration of nipples and heat traps on page 31.

Installing the water heater.

During Installation of this water heater.....

DO

- **DO** check inlet gas pressure to ensure that it is within the range specified on the rating plate.
- **DO** provide adequate air for combustion and ventilation as discussed in the Use and Care Manual and the National Fuel Gas Code.
- **DO** maintain proper clearances to combustibles as specified on the rating plate.
- **DO** ensure that the venting system complies with the guidelines found in the Use and Care Manual and National Fuel Gas Code.
- **DO** contact a qualified service technician if the hot surface ignitor or main burner will not stay lit. The burner chamber is designed to be sealed utilizing a gasket.

DON'T

- **DON'T** block or restrict the flammable vapor sensor located around the lower portion of the water heater jacket.
- **DON'T** block or restrict Combustion Air Inlet Openings located around the outer door.
- **DON'T** remove the Burner Access Door unless absolutely necessary. This should only be done by a qualified service technician. A new burner access door gasket must be installed on any burner access door that has been removed.
- **DON'T** install this water heater where standing water may occur. The base of the water heater is meant to be mounted on a dry surface.
- **DON'T** allow cleaners, solvents, or other like materials to come in contact with the flammable vapor sensor.
- **DON'T** allow cleaner, solvents, or other materials to come in contact with the flammable vapor sensor.
- **DON'T** operate the water heater if the sight glass or burner access door grommet is damaged or broken.

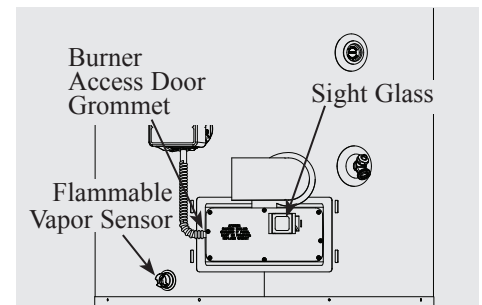

Installation Checklist

A. Water Heater Location

- Close to area of vent.
- Indoors and protected from freezing temperatures.
- Proper clearance from combustible surfaces observed and water heater not installed on carpeted floor.
- Sufficient fresh air supply for proper operation of water heater.
- Air supply free of corrosive elements and flammable vapors.
- Provisions made to protect area from water damage.
- Catch pan installed.
- Sufficient room to service the water heater.
- Combustible materials, such as clothing, cleaning materials, rags, etc. clear of the base of the heater.
- Clearances from combustion air inlet openings observed (see page 9).
- Flammable vapor sensor is not blocked..

B. Water Supply

- Water heater completely filled with water.
- Air purged from water heater and piping.
- Water connections tight and free of leaks.

C. Gas Supply

- Gas line equipped with shut-off valve, union and sediment trap.
- Approved pipe joint compound used.
- Soap and water solution used to check all connections and fittings for possible gas leak.
- Gas Company inspected installation (if required).

D. Relief Valve

- Temperature and Pressure Relief Valve properly installed and discharge line run to open drain.
- Discharge line protected from freezing.

E. Venting

- Flue baffle properly hung in top of heater's flue.
- Draft hood properly installed.
- Vent connector(s) pitched upward to chimney ($\frac{1}{4}$ " per foot of length minimum) .
- Vent connector(s) securely fastened together with screws.
- Single wall vent connector(s) at least 6" from combustible material.

F. Wiring

- Correct power supply (120 VAC).
- Electrical connections tight.
- Water heater properly grounded and proper polarity observed.

Supplemental instructions for gas water heaters installed in potable/space heating applications.

Local codes or plumbing authority requirements may vary from the instructions or diagrams provided in this manual and take precedent over these instructions.

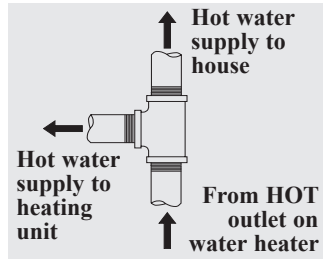

Tee fitting for vertical hot water supply lines.

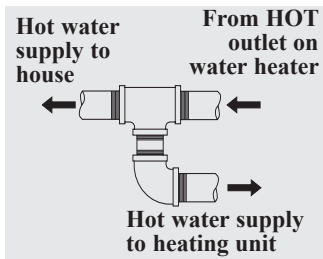

Tee fitting for horizontal hot water supply lines.

Combination Potable and Space Heating Application

Tee fitting must be installed as shown. This ensures that any air in the water lines will be purged through the domestic water faucets and showers.

⚠ DANGER: When this system requires water for space heating at elevated temperatures (above 125°F [52°C.]), a mixing or tempering valve must be installed in the hot water supply line to the house in order to reduce the scald hazard potential.

⚠ DANGER: Any piping or components used in the installation of this water heater in a combination potable and space heating application must be suitable for use with drinking water.

⚠ DANGER: If this water heater is installed in an application intended to supply domestic hot water needs and hot water for space heating purposes, do not connect the heater to an existing heating unit or components of a heating system that have previously been used with a non drinking water system. Toxic chemicals such as those used for boiler treatment may be present and will contaminate the drinking water supply causing possible health risks. Never introduce toxic chemicals, such as those used for boiler treatment, into this system.

NOTICE: 50 ft maximum distance from water heater to fan coil (developed length) is required for Massachusetts state.

Typical Piping Diagram for Combination Potable/Space Heating Installation

Nominal 3/4" size mixing or tempering valve (refer to warning above). Follow mixing or tempering valve manufacturer's instructions for installation of the valve.

Spring loaded check valve in heating unit hot water supply line and cold water return line (not supplied with water heater)

NOTICE: This check valve is incorporated in some heating units. Refer to the installation instructions supplied with specific heating unit to determine if it is required.

See diagrams above for proper pipe application for vertical or horizontal supply lines.

Isolation valve in hot water supply line to heating unit (not supplied with water heater)

Temperature and Pressure Relief Valve, tie to location approved by local code

Gas line to water heater

Temperature and pressure relief valve discharge line

Water heater jacket

Combination Gas Control (Thermostat)

Water Heater drain pan installed in accordance with the Local and State Code

Flammable Vapor Sensor

Water Heater to be in accordance with the Local and State Energy Code

All water piping shall be insulated in accordance with Local and State Energy Code.

Minimum of 2'-0" developed length of 3/4" pipe.

3/4" Tempered domestic hot water supply to house.

Pressure Gauge

3/4" Check Valve with 1/8" Hole

3/4" Shut-Off Valve (Typ.)

3/4" cold water supply

3/4" Shut-Off Valve (Typ.)

Heat Trap 6" Min.

2 Gallon Thermal Expansion Tank (if required-not supplied with water heater)

Air vent

140°F

120° to 130°F

3/4" HWS & HWR to Heating Coil.

Drain valve (not supplied with water heater)

Isolation valve in cold water return line from heating unit (not supplied with water heater)

Gas Direct Vent discharge must comply with Local and State Code

6" Air Gap

Vacuum Relief Valve (Not Supplied)



If required, install per local codes and valve manufacturer's instructions.

Electronically controlled pump timer. Activates every 6 hours for 60 seconds. Wire to bronze pump.

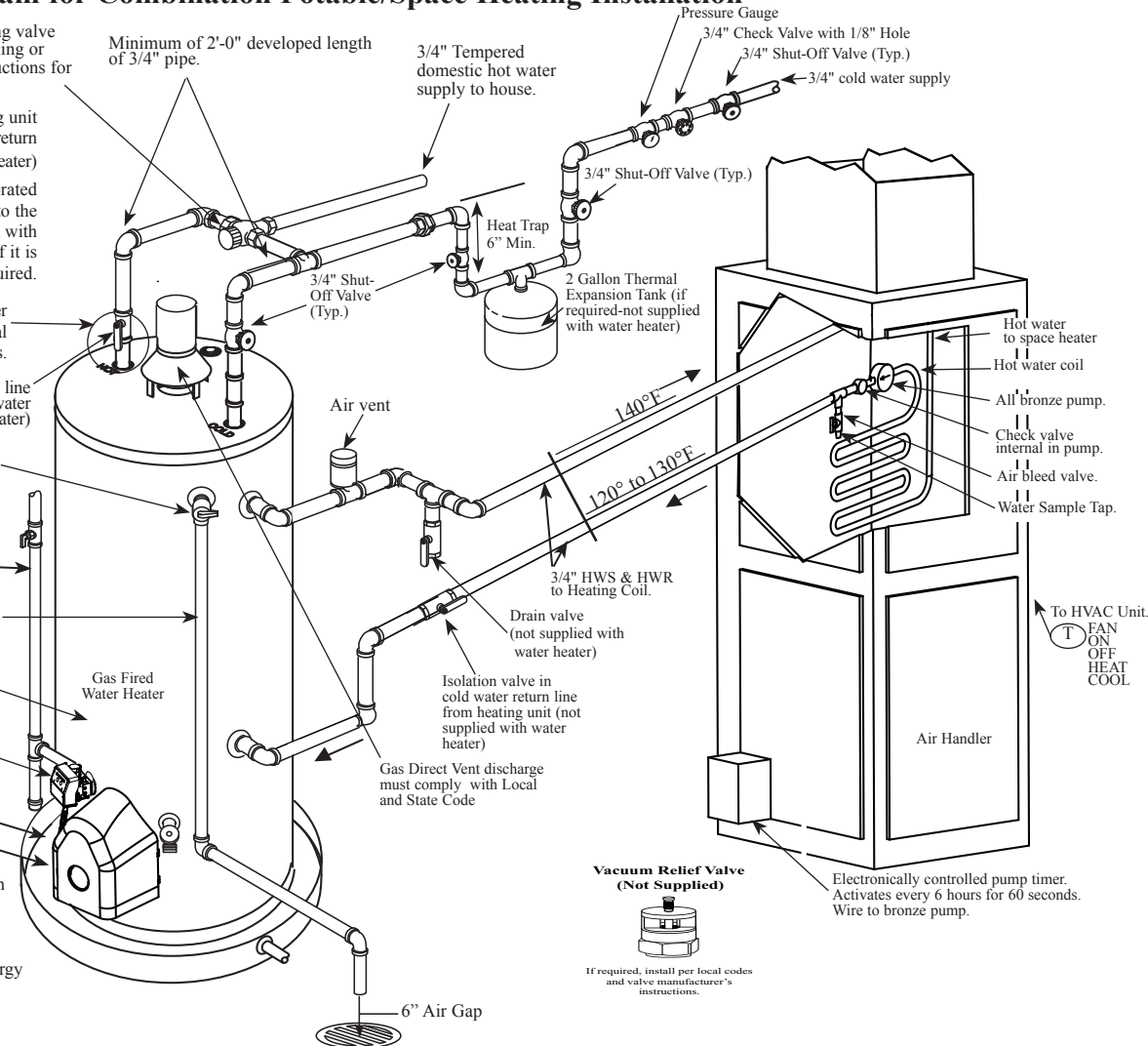

Lighting the water heater.

Before operating this water heater, be sure to read and follow the instructions on the label pictured below and all other labels on the water heater, as well as the warnings printed in this manual. Failure to do so can result in unsafe operation of the water heater resulting in property damage, personal injury, or death. Should you have any problems reading or following the instructions in this manual, STOP, and get help from a qualified person.

FOR YOUR SAFETY READ BEFORE OPERATING

⚠ WARNING: If you do not follow these instructions and the Use & Care Manual instructions exactly, a fire or explosion may result causing property damage, personal injury or loss of life.

- A. This appliance does not have a pilot. It is equipped with an ignition device which automatically lights the burner. Do NOT try to light the burner by hand.
- B. BEFORE PUTTING THIS APPLIANCE INTO SERVICE - Smell all around the appliance area for gas. Be sure to smell next to the floor because some gas is heavier than air and will settle on the floor.
WHAT TO DO IF YOU SMELL GAS
- Do not try to light any appliance.
 - Do not touch any electric switch; do not use any phone in your building.
 - Immediately call your gas supplier from a neighbor's phone. Follow the gas supplier's instructions.
- If you cannot reach your gas supplier, call the fire department.
- C. Use only your hand to push in the gas control buttons. Never use tools. If the control buttons will not push in, don't try to repair them, call a qualified service technician. Force or attempted repair may result in fire or explosion.
- D. Do not use this appliance if any part has been under water. Immediately call a qualified installer or service agency to replace a flooded water heater. Do not attempt to repair the unit! It must be replaced!

OPERATING INSTRUCTIONS

1. Stop! Read the safety information above on this label.
2. Toggle the "ON/OFF" switch located on the blower assembly to the "ON" position.
3. Set the thermostat to the lowest setting by pressing the COOLER ⏪ and HOTTER ⏩ buttons at the same time and holding them for (1) second. Depress the COOLER ⏪ button until only the WARM indicator light is lit.
4. Toggle the "ON/OFF" switch located on the blower assembly to the "OFF" position.
5. Turn off all electrical power to the appliance.
6. This appliance is equipped with a Hot Surface Ignition System which automatically lights the burner. Do NOT open the inner door of this appliance and try to light the burner by hand!
7. Wait five (5) minutes to clear out any gas. If you smell gas, STOP! Follow "B" in the safety information above on this label. If you do not smell gas, go ahead to the next step.
8. Turn on all electrical power to the appliance.
9. Toggle the "ON/OFF" switch located on the blower assembly to the "ON" position.
10. Set thermostat to the desired temperature setting by pressing the COOLER ⏪ and HOTTER ⏩ buttons at the same time and holding them for (1) second. Depress the HOTTER ⏩ button until the desired temperature display setting is lit. The preferred starting point for temperature setting is indicated by ▽ on the thermostat.
11. If the appliance will not operate, follow the instructions "TO TURN OFF GAS TO APPLIANCE" and call your service technician or gas supplier.

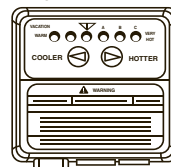

TO TURN GAS OFF TO THE APPLIANCE

1. Set the thermostat to the lowest setting by first depressing the COOLER ⏪ and HOTTER ⏩ buttons at the same time and holding for (1) second. Depress the COOLER ⏪ button until only the WARM indicator light is lit.
2. Toggle the "ON/OFF" switch located on the blower assembly to the "OFF" position.
3. Turn off all electrical power to the appliance.

Operating the Water Heater

▲ CAUTION: Hydrogen gas can be produced in a hot water system served by this water heater that has not been used for a long period of time (generally two weeks or more). **HYDROGEN GAS IS EXTREMELY FLAMMABLE!!** To dissipate such gas and to reduce risk of injury, it is recommended that the hot water faucet be opened for several minutes at the kitchen sink before using any electrical appliance connected to the hot water system. If hydrogen is present, there will be an unusual sound such as air escaping through the pipe as the water begins to flow. Do not smoke or use an open flame near the faucet at the time it is open.

Safety Precautions

- A** DO turn off manual gas shut-off valve if water heater has been subjected to over heating, fire, flood, physical damage or if the gas supply fails to shut off.
 - B** DO NOT turn on water heater unless it is completely filled with water.
 - C** DO NOT turn on water heater if cold water supply shut-off valve is closed.
 - D** DO NOT allow combustible materials such as newspaper, rags or mops to accumulate near water heater.
 - E** DO NOT store or use gasoline or other flammable vapours and liquids, such as adhesives or paint thinner, in vicinity of this or any other appliance. If such flammables must be used, open doors and windows for ventilation, and all gas burning appliances in the vicinity should be shut off including their pilot burners, to avoid vapours lighting.
- NOTICE: Flammable vapours can be drawn by air currents from surrounding areas to the water heater.**
- F** If there is any difficulty in understanding or following the Operating Instructions or the Care and Cleaning section, it is recommended that a qualified person or serviceman perform the work.
-

Operating Procedure

This water heater is equipped with a hot surface ignitor to light the main burner. There is no pilot light to be lit, but on initial start-up, it is recommended that the outer door be removed (leave inner door in place for safety) to view through the sight glass if the hot surface ignitor and main burner are operating properly.

Once filled with water, it is only necessary to plug the power cord in and make sure the “ON/OFF” switch located on the blower assembly is in the “ON” position to put the water heater into operation. Within seconds the hot surface

ignitor should heat up, then the gas valve should open and the main burner ignite. After the main burner ignites, replace the outer door. If no main burner flame is established, the gas control will go through three trials for ignition before going into a lock-out. A warning light will alert the user of this lock-out condition. If this happens, refer to “Troubleshooting Guide.”

TO SHUT OFF WATER HEATER – Turn switch located on the side of the blower assembly to the “OFF” position. See diagram on page 31 for location of blower assembly.

Water Temperature Setting

▲ DANGER: Hotter water increases the Potential for Hot Water SCALDS. Households with small children, disabled, or elderly persons may require a 120°F (49°C) or lower combination gas control (thermostat) setting to prevent contact with unsafe water temperatures.

The temperature of the water in the water heater can be regulated by pressing the buttons on the front of the combination gas control (thermostat).

Safety and energy conservation are factors to be considered when selecting the water temperature setting of the water heater’s combination gas control (thermostat). The lower the temperature setting, the greater the savings in energy and operating costs.

To comply with safety regulations, the combination gas control (thermostat) was set at its lowest setting before the water heater was shipped from the factory. The recommended starting point temperature is 120°F (49°C).

Water temperatures above 125°F (52°C) can cause severe burns or death from scalding. Be sure to read and follow the warnings outlined in this manual and on the label located on the water heater near the gas control (thermostat).

Mixing valves are available for reducing point of use water temperature by mixing hot and cold water in branch water lines. Contact a licensed plumber or the local plumbing authority for further information.

The chart on the next page may be used as a guide in determining the appropriate water temperature for your installation.

Water Temperature Setting...

Maximum water temperatures occur just after the burner has shut off. To determine the water temperature, turn on a hot water faucet and place a thermometer in the water stream.

To avoid any unintentional changes in water temperature settings, the combination gas control (thermostat) has a tamper resistant feature for changing the temperature setting. To change the temperature setting follow these instructions.

1. "Wake Up" the temperature indicators by holding down both "COOLER" and "HOTTER" temperature adjustment buttons at the same time for one second, see Figure below. One or two of the temperature indicators will light up. These indicators will only remain on for 30 seconds if no further buttons are pressed. After 30 seconds the control will go back to "sleep" mode.
2. Release both of the temperature buttons.
 - a. To decrease the temperature press and release the "COOLER" button until the desired setting is reached.
 - b. To increase the temperature press and release the "HOTTER" button until the desired setting is reached.

NOTICE: Holding down the button will not continue to lower or raise the temperature setting. The button must be pressed and released for each temperature change desired.

A condition known as "stacking" or "layering" can occur when a series of short and frequent hot water draws are taken.

The hottest temperature water will be at the top of the tank, closest to the outlet pipe delivering hot water to the home.

Stacking can cause this top layer of water to be hotter than the water toward the bottom of the tank near the combination gas control (thermostat). Therefore, always remember to test the water temperature with your hand before use and remember that hotter water increases the risk of scald injury.

Also, always supervise young children or others who are incapacitated.

The combination gas control (thermostat) is constructed with a built in safety shutoff device designed to shut off the gas supply to the burner if the main burner is extinguished for any reason.

The combination gas control (thermostat) is also equipped with a gas shutoff device that will shut off the gas supply to the burner if the water heater exceeds normal operating temperatures. Refer to the Before You Call For Service section of this manual, or contact your dealer.

▲ WARNING: Should overheating occur or the gas supply fail to shut off, turn off the manual gas (shutoff) valve to the appliance.

If the water heater has been subjected to fire, flood or physical damage, turn off the manual gas (shutoff) valve, and do not operate the water heater again until it has been checked by a qualified service technician.

Temperature Setting	Display ▼ A B C	Burns on Adult Skin
WARM = approx. 70°F (21°C)	● ○ ○ ○ ○ ○	-----
▼ = approx. 120°F (49°C)	○ ● ○ ○ ○ ○	More than 5 minutes
A = approx. 130°F (54°C)	○ ○ ● ○ ○ ○	About 30 seconds
B = approx. 140°F (60°C)	○ ○ ○ ● ○ ○	Less than 5 seconds
C = approx. 150°F (66°C)	○ ○ ○ ○ ● ○	About 1-1/2 seconds
C-Flashing = approx. 160°F (71°C)	○ ○ ○ ○ ○ ●	About 1/2 seconds

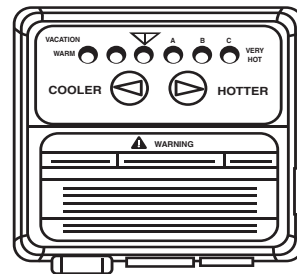

Time/Temperature Relationship in Scalds

Water Temperature	Time To Produce a Serious Burn
120°F (49°C)	More than 5 minutes
125°F (52°C)	1½ to 2 minutes
130°F (54°C)	About 30 seconds
135°F (57°C)	About 10 seconds
140°F (60°C)	Less than 5 seconds
145°F (63°C)	Less than 3 seconds
150°F (66°C)	About 1½ seconds
155°F (68°C)	About 1 second

Table courtesy of Shriners Burn Institute

Operating the Water Heater

Temperature Setting	Display	Burns on Adult Skin
	▼ B C D E F	
▼ = approx. 120°F (49°C)	● ○ ○ ○ ○ ○	More than 5 minutes
B = approx. 130°F (54°C)	● ● ○ ○ ○ ○	About 30 seconds
C = approx. 140°F (60°C)	○ ● ○ ○ ○ ○	Less than 5 seconds
D = approx. 150°F (66°C)	○ ○ ● ○ ○ ○	About 1-1/2 seconds
E = approx. 160°F (71°C)	○ ○ ○ ● ○ ○	About 1/2 seconds
F = approx. 170°F (77°C)	○ ○ ○ ○ ● ○	-----
F = approx. 180°F (82°C)	○ ○ ○ ○ ○ ●	-----

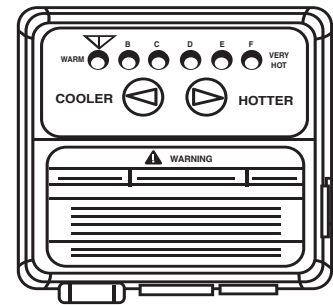

Sequence of Operation

During initial start-up or a call for heat, the control will verify the vent vacuum switch is open.

Once the control verifies the vent vacuum switch is open, the control will energize the blower motor for the pre-purge sequence (approximately 5 seconds).

The control will verify the vent vacuum switch has closed, ensuring that the blower is functioning properly and that the venting system is not blocked.

The control will then proceed through a sequence of self-diagnostics before initiating a trial for ignition.

During the trial for ignition, the hot surface ignitor will warm up.

Once the hot surface ignitor warms up, the main gas valve will open allowing gas to flow to the main burner.

Once the main burner ignites, the control will verify that the burner flame is present through the flame sense circuit. The hot surface ignitor will then turn off.

The main burner will remain lit throughout the heat cycle until the water temperature setting is reached.

Once the water temperature setting is reached, the control will close the main gas valve which will extinguish the main burner flames.

The blower motor will stay energized for an additional 5 seconds after the control verifies that the burner flame is extinguished in order to clear combustion gases from the water heater.

After the post-purge sequence, the control will de-energize the blower motor and go into a stand-by mode awaiting the next call for heat.

This water heater is equipped with a flammable vapour sensor that is monitored continuously by the electronic control in all modes of operation.

In the event that flammable vapours are detected, the control will automatically shut down the water heater and prevent the water heater from being started again.

The following is a list of materials that will cause the Flammable Vapour Sensor to shut down the water heater.

- Vapours of Gasoline.
- Vapours of certain flammable paints, stains, and thinners.
- Vapours of vent pipe Cement & Solvents.
- Bleach (direct contact with flammable vapour sensor).
- Some other flammable materials and their vapours.

If the flammable vapour sensor shuts down the water heater, then the electronic control will display the appropriate error code and you should then promptly contact a qualified service technician.

Refer to the “NOTICE” on page 3 for additional information.

Care and cleaning of the water heater.

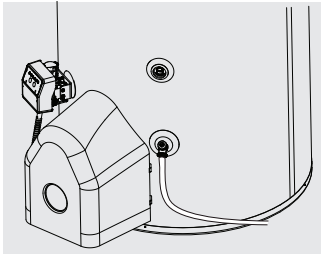

Draining the Water Heater

▲CAUTION: Shut off gas to the water heater at the gas control (thermostat) manual shut-off valve before draining water.

▲DANGER: Before manually operating the temperature and pressure relief valve, make certain no one will be exposed to the hot water released by the valve. The water drained from the tank may be hot enough to present a scald hazard and should be directed to a

suitable drain to prevent injury or damage.

In order to drain the water heater, turn off the cold water supply. Open a hot water faucet or lift the handle on the relief valve to admit air to the tank.

Attach a garden hose to the drain valve on the water heater and direct the stream of water to a drain. Open the valve.

▲DANGER: Before manually operating the relief valve, make certain no one will be exposed to the danger of the hot water released by the valve. The water may be hot enough to create a scald hazard. The water should be released into a suitable drain to prevent injury or property damage.

▲DANGER: Hotter water increases the potential for Hot Water Scalds.

▲DANGER: Failure to perform the recommended Routine Preventative Maintenance can harm the proper operation of this water heater, which can cause carbon monoxide dangers, excessive hot water temperatures and other potentially hazardous conditions.

Routine Preventative Maintenance

Properly maintained, your water heater will provide years of dependable trouble-free service.

It is recommended that a periodic inspection of the gas control (thermostat), burner, relief valve, internal flue-way and venting system should be made by service personnel qualified in gas appliance repair.

It is suggested that a routine preventative maintenance program be established and followed by the user.

PRESSURE SWITCH - Inspect the inlet to the pressure switch and the tubing for debris or blockage. Clean out the tubing periodically to prevent buildup of debris.

At least once a year, lift and release the lever handle on the temperature pressure relief valve, located near the top of the water heater, to make certain the valve operates freely. Allow several gallons to flush through the discharge line to an open drain.

NOTICE: If the temperature and pressure relief valve on the hot water heater discharges periodically, this may be due to thermal expansion in a closed water system. Contact the water supplier or your plumbing contractor on how to correct this. **DO NOT** plug the relief valve outlet.

A water heater's tank can act as a settling basin for solids suspended in the water. It is therefore not uncommon for hard water deposits to accumulate in the bottom of

the tank. If allowed to accumulate, these solids can cover the combination gas control (thermostat) sensors, causing the sensors to operate erratically. Because accumulated solids can prevent the combination gas control (thermostat) sensors from accurately reading the water temperature, the water at the fixture can be hotter than the combination gas control (thermostat) setting. It is suggested that a few quarts of water be drained from the water heater's tank every month to clean the tank of these deposits.

Rapid closing of faucets or solenoid valves in automatic water using appliances can cause a banging noise heard in a water pipe. Strategically located risers in the water pipe system or water hammer arresting devices can be used to minimize the problem.

The anode rod should be removed from the water heater's tank annually for inspection and replaced when more than 6" of core wire is exposed at either end of the rod.

Make sure the cold water supply is turned off before removing anode rod.

This water heater incorporates a combustion shut off device that shuts the operation of the water heater down if undesirable combustion conditions occur. Such as the presence of flammable vapors or blockage of the combustion air inlet openings. Please contact a Qualified Service Technician if this occurs.

DO NOT expose the flammable vapor sensor to water, solvents, or cleaning agents.

▲DANGER: Combustible materials, such as clothing, cleaning materials, or flammable liquids, etc., must not be placed against or next to the water heater.

Housekeeping

Visually inspect the hot surface ignitor.

Make sure that the flammable vapor sensor is not blocked or obstructed.

To ensure sufficient ventilation and combustion air supply, proper clearances must be maintained.

Care and cleaning of the water heater.

Venting System Inspection

Inspect the gas venting system and the chimney.

Make certain the vent connector from the draft hood to the chimney is properly positioned and securely attached.

If after inspection of the vent system you found soot or deterioration; call the local gas utility to correct the

problem and clean the flue, or replace the flue, flue baffle, and venting system before resuming operation of the water heater.

Test for spillage at the draft hood relief opening after 5 minutes of burner operation. Use a flame of a match or candle or smoke.

Burner Inspection

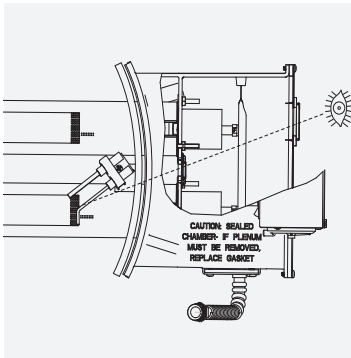

Through the sight glass, visually inspect the hot surface ignitor and main burner periodically.

Inspect the hot surface ignitor with the main burner off and inspect the main burner while firing.

If any unusual burner operation is noted, the water heater should be shut off until qualified service assistance can be obtained.

▲CAUTION: For your safety, cleaning of the burner must be performed only by qualified service personnel as it involves the disconnection of gas piping and leak testing. The burner chamber is a sealed area. If the burner access door is removed, the inner door gasket must be replaced.

For cleaning, remove the inner doors burner assembly from the water heater. A vacuum cleaner can be used on the burner and inside the water heater. The burner can also be cleaned by blowing air over the burner surface. Do not allow any large debris to remain inside the burner.

NOTICE: Refer to the Hydrogen Gas Caution in the Operating Instructions.

Vacation and Extended Shut-Down

If the water heater is to remain idle for an extended period of time, the power and water to the appliance should be turned off to conserve energy and prevent a build-up of dangerous hydrogen gas.

The water heater and piping should be drained if they might be subjected to freezing temperatures.

After a long shut-down period, the water heater's operation and controls should be checked by qualified service personnel. Make certain the water heater is completely filled again before placing it in operation.

NOTICE: Do not remove the anode rod from the water heater's tank, except for inspection and/or replacement, as operation with the anode rod removed will greatly shorten the life of the glass lined tank and will exclude warranty coverage.

Anode Rod

This water heater is equipped with an anode rod designed to prolong the life of the glass lined tank. The anode rod is slowly consumed, thereby eliminating or minimizing corrosion of the glass lined tank.

Water sometimes contains a high sulfate and/or mineral content and together with cathodic protection process can produce a hydrogen sulfide, or rotten egg odor in the heated water. Chlorination of the water supply should minimize the problem.

Blower

▲DANGER: Disconnect power to blower before cleaning.

Clean the blower periodically to remove any buildup of lint or dirt. Remove the

inlet plate and blow out any lint or dirt on the wheel and on the screen of the inlet plate. Before operation, re-install the inlet plate to the blower.

Before You Call For Service...



Troubleshooting Tips

Save time and money! Review the charts on the following pages first and you may not need to call for service.

This water heater incorporates a combustion shut off device that shuts the operation of the water heater down if undesirable combustion conditions occur. Such as the presence of flammable vapors or blockage of the combustion air inlet openings. Please contact a Qualified Service Technician if this occurs.

Problem	Possible Causes	What To Do
Condensation	This usually happens when a new water heater is filled for the first time.	<ul style="list-style-type: none"> This is normal. After the water in the tank warms up, the condensation will disappear. If, however, the condition persists, examine the piping and fittings for possible leaks. Refer to page 11 for more information.
	Moisture from the products of combustion condensing on the tank surface.	<ul style="list-style-type: none"> This is normal and will disappear in time. Refer to page 11 for more information.
	An undersized water heater will cause condensation.	<ul style="list-style-type: none"> Use a water heater size that meets the requirements of your needs.
Yellow flame or soot	Scale on top of the burner.	<ul style="list-style-type: none"> Contact a qualified service technician to remove scale.
	Flue or Combustion air inlet openings are restricted.	<ul style="list-style-type: none"> Remove obstruction or debris from flue or combustion air inlet openings on blower assembly.
	Not enough combustion or ventilation air supplied to the water heater location.	<ul style="list-style-type: none"> Proper operation of the water heater requires air for combustion and ventilation. See the Combustion and Ventilation Air information in the “Installing The Water Heater” section of this manual.
Unable to light the main burner	Air in gas line.	<ul style="list-style-type: none"> Contact a qualified service technician to purge the air from the gas line.
	Blocked Exhaust	<ul style="list-style-type: none"> Contact a qualified service technician to evaluate vent pipe for blockage.
	Pressure Switch	<ul style="list-style-type: none"> Make sure the pressure switch hose is not "kinked".
	Wire Connection(s) not fully secured.	<ul style="list-style-type: none"> Contact a qualified service technician to confirm wire connections.
	Combustion Shut-off Device tripped.	<ul style="list-style-type: none"> Combustion shut-off device should be inspected by a qualified service technician.
	Gas Control Problem	<ul style="list-style-type: none"> Contact a qualified service technician.
Main burner does not lit	Gas Controls (Thermostat's) Energy shutoff device open.	<ul style="list-style-type: none"> The combination gas control (thermostat) should be stay replaced by a qualified service technician.
	Combustion Shutoff Device Tripped.	<ul style="list-style-type: none"> The combustion shutoff device should be inspected by a qualified service technician.

⚠ CAUTION: For your safety **DO NOT** attempt repair of gas piping, combination gas control (thermostat), burners, vent connectors or other safety devices. Refer repairs to qualified service personnel.

⚠ CAUTION: Label all wires prior to disconnection when servicing controls. Wiring errors can cause improper and dangerous operation. **VERIFY PROPER OPERATION AFTER SERVICING.**

Before You Call For Service...



Troubleshooting Tips

Save time and money! Review the charts on the following pages first and you may not need to call for service.

This water heater incorporates a combustion shut off device that shuts the operation of the water heater down if undesirable combustion conditions occur. Such as the presence of flammable vapors or blockage of the combustion air inlet openings. Please contact a Qualified Service Technician if this occurs.















Problem	Possible Causes	What To Do
Rumbling noise in tank.	Scale and sediment	<ul style="list-style-type: none"> ● Drain the water heater to remove scale and sediment from the tank. Refer to page 23.
Relief valve producing popping noise or draining	Pressure build up caused by thermal expansion to a closed system.	<ul style="list-style-type: none"> ● This is an unacceptable condition and must be corrected. Contact the water supplier or plumbing contractor on how to correct this. Do not plug the relief valve outlet.
Not enough or no hot water	Water usage may have exceeded the capacity of the water heater.	<ul style="list-style-type: none"> ● Wait for the water heater to recover after an abnormal demand.
	Low gas pressure.	<ul style="list-style-type: none"> ● Check gas supply pressure and manifold pressure.
	The Combination Gas Control (thermostat) may be set too low.	<ul style="list-style-type: none"> ● See the “Water Temperature Setting” of The Water heater section of this manual.
	Leaking or open hot water faucets.	<ul style="list-style-type: none"> ● Make sure all faucets are closed.
	Check valve error codes.	<ul style="list-style-type: none"> ● Refer to gas valve error code table in the next section.
	“ON/OFF” switch turned off.	<ul style="list-style-type: none"> ● Turn “ON”.
	Blower unplugged.	<ul style="list-style-type: none"> ● Plug in. Verify power supply (120VAC).
	Combustion Shutoff System tripped.	<ul style="list-style-type: none"> ● Contact a qualified service technician.
Water is too hot	The Combination Gas Control (thermostat) is set too high.	<ul style="list-style-type: none"> ● See the “Water Temperature Setting” of The Water Heater section of this manual.
	The Combination Gas Control (thermostat) Defective.	<ul style="list-style-type: none"> ● Contact a qualified service technician to replace the combination Gas Control (thermostat).

⚠ CAUTION: Make certain power to water heater is “OFF” before removing protective cover FOR ANY REASON.

⚠ CAUTION: For your safety DO NOT attempt repair of gas piping, Combination Gas Control (thermostat), burners, vent connectors or other safety devices. Refer repairs to qualified service personnel.

⚠ CAUTION: Label all wires prior to disconnection when servicing controls. Wiring errors can cause improper and dangerous operation. VERIFY PROPER OPERATION AFTER SERVICING.

Gas Valve LED Error Codes

LED Status	Problem	Solution
	An open earth ground circuit to the ignition system.	<ol style="list-style-type: none"> 1. Check that the earth ground connection is properly connected. 2. Check that the ground conductor on the water heater is properly connected.
	Wiring error or a high resistance to earth ground.	<ol style="list-style-type: none"> 1. Check proper connection of line neutral and hot wires. 2. Check that the water heater is securely connected to earth ground.
	Pressure switch remained closed longer than 5 seconds after the call for heat began.	<ol style="list-style-type: none"> 1. Verify that the wiring to the pressure switch(es) is correct. 2. Replace the pressure switch(es).
	Pressure switch remained open longer than 5 seconds after the combustion blower was energized.	<ol style="list-style-type: none"> 1. Verify that the wiring to the pressure switch(es) is correct. 2. Verify that the wiring to the pressure switch(es) is connected correctly. 3. Check the vent and / or combustion air-inlet systems for obstructions.
	Error in the hot surface ignitor circuit.	<ol style="list-style-type: none"> 1. Check that all wiring is correct and secure. 2. Replace hot surface ignitor.
	System in lockout.	<ol style="list-style-type: none"> 1. Gas supply is off or too low to operate. Turn on the gas supply and / or increase the inlet gas supply pressure. 2. Hot surface ignitor not positioned correctly. 3. Low voltage to the water heater. Increase supply voltage to rated voltage. 4. Electric polarity to unit is incorrect - test and correct. 5. Check the vent and/or the combustion air-inlet systems for obstructions.
	Problem in the gas valve driver circuit.	<ol style="list-style-type: none"> 1. Turn power to the water heater off for 10 seconds and then back on. 2. Replace Combination Gas Control (thermostat).
	Problem with the internal circuit.	<ol style="list-style-type: none"> 1. Turn power to the water heater off for 10 seconds and then back on. 2. Replace Combination Gas Control (thermostat).
	Problem with the internal circuit.	<ol style="list-style-type: none"> 1. Turn power to the water heater off for 10 seconds and then back on. 2. Replace Combination Gas Control (thermostat).
	Flame signal sensed out of proper sequence.	<ol style="list-style-type: none"> 1. Replace Combination Gas Control (thermostat).
	ECO activated.	<ol style="list-style-type: none"> 1. Replace Combination Gas Control (thermostat).
	One of the temperature adjust buttons stuck closed.	<ol style="list-style-type: none"> 1. Press and release each of the buttons once. 2. Replace Combination Gas Control (thermostat).
	Water temperature sensor is either open or short circuited.	<ol style="list-style-type: none"> 1. Check that all wiring is correct and secure. 2. Replace Combination Gas Control (thermostat).
	Unit shuts down.	<ol style="list-style-type: none"> 1. Check for correct wiring to FV sensor. 2. Check for open circuits to FV sensor. 3. Replace FV sensor.
	Unit shuts down and in lockout.	<ol style="list-style-type: none"> 1. FV sensor detected presence of flammable vapors. 2. Contact a service agency.

⚠ CAUTION: Make certain power to water heater is “OFF” before removing protective cover FOR ANY REASON.

⚠ CAUTION: Label all wires prior to disconnection when servicing controls. Wiring errors can cause improper and dangerous operation. VERIFY PROPER OPERATION AFTER SERVICING.

⚠ CAUTION: For your safety DO NOT attempt repair of gas piping, Combination Gas Control (thermostat), burners, vent connectors or other safety devices. Refer repairs to qualified service personnel.

Gas Valve LED Error Codes

LED Status	Problem	Solution
▼ B C D E F ● ○ ○ ● ○ ○	An open earth ground circuit to the ignition system.	<ol style="list-style-type: none"> 1. Check that the earth ground connection is properly connected. 2. Check that the ground conductor on the water heater is properly connected.
▼ B C D E F ● ○ ● ○ ● ○	Wiring error or a high resistance to earth ground.	<ol style="list-style-type: none"> 1. Check proper connection of line neutral and hot wires. 2. Check that the water heater is securely connected to earth ground.
▼ B C D E F ● ○ ● ○ ○ ○	Pressure switch remained closed longer than 5 seconds after the call for heat began.	<ol style="list-style-type: none"> 1. Verify that the wiring to the pressure switch(es) is correct. 2. Replace the pressure switch(es).
▼ B C D E F ● ○ ● ○ ○ ●	Pressure switch remained opened longer than 5 seconds after the combustion blower was energized.	<ol style="list-style-type: none"> 1. Verify that the wiring to the pressure switch(es) is correct. 2. Verify that the wiring to the pressure switch(es) is connected correctly. 3. Check the vent and / or combustion air-inlet systems for obstructions.
▼ B C D E F ● ○ ● ○ ● ●	Error in the hot surface ignitor circuit.	<ol style="list-style-type: none"> 1. Check that all wiring is correct and secure. 2. Replace hot surface ignitor.
▼ B C D E F ● ○ ○ ● ● ○	System in lockout.	<ol style="list-style-type: none"> 1. Gas supply is off or too low to operate. Turn on the gas supply and / or increase the inlet gas supply pressure. 2. Hot surface ignitor not positioned correctly. 3. Low voltage to the water heater. Increase supply voltage to rated voltage. 4. Electric polarity to unit is incorrect - test and correct. 5. Check the vent and/or the combustion air-inlet systems for obstructions.
▼ B C D E F ● ○ ○ ○ ● ●	Problem in the combination gas valve driver circuit.	<ol style="list-style-type: none"> 1. Turn power to the water heater off for 10 seconds and then back on. 2. Replace the combination gas control (thermostat).
▼ B C D E F ● ○ ● ● ● ○	Problem with the internal circuit.	<ol style="list-style-type: none"> 1. Turn power to the water heater off for 10 seconds and then back on. 2. Replace the combination gas control (thermostat).
▼ B C D E F ● ● ● ● ● ●	Problem with the internal circuit.	<ol style="list-style-type: none"> 1. Turn power to the water heater off for 10 seconds and then back on. 2. Replace the combination gas control (thermostat).
▼ B C D E F ● ○ ○ ○ ● ○	Flame signal sensed out of proper sequence.	<ol style="list-style-type: none"> 1. Replace the combination gas control (thermostat).
▼ B C D E F ● ○ ○ ● ● ●	ECO activated.	<ol style="list-style-type: none"> 1. Allow water temperature in the tank to cool off, then turn power to the water heater off for 10 seconds and then back on. 2. If error code re-occurs, reduce the thermostat setting. 3. Replace the combination gas control (thermostat).
▼ B C D E F ● ○ ● ● ○ ○	One of the temperature adjust buttons stuck closed.	<ol style="list-style-type: none"> 1. Press and release each of the buttons once. 2. Replace the combination gas control (thermostat).
▼ B C D E F ● ○ ● ● ○ ●	Water temperature sensor is either open or short circuited.	<ol style="list-style-type: none"> 1. Check that all wiring is correct and secure. 2. Replace the combination gas control (thermostat).
▼ B C D E F ● ○ ○ ● ○ ●	Unit shuts down.	<ol style="list-style-type: none"> 1. Check for correct wiring to FV sensor. 2. Check for open circuits to FV sensor. 3. Replace FV sensor.
▼ B C D E F ● ○ ○ ○ ○ ●	Unit shuts down and in lockout.	<ol style="list-style-type: none"> 1. FV sensor detected presence of flammable vapours. 2. Contact a service agency.

▲ CAUTION: Make certain power to water heater is “OFF” before removing protective cover FOR ANY REASON.

▲ CAUTION: Label all wires prior to disconnection when servicing controls. Wiring errors can cause improper and dangerous operation. VERIFY PROPER OPERATION AFTER SERVICING.

▲ CAUTION: For your safety DO NOT attempt repair of gas piping, Combination Gas Control (thermostat), burners, vent connectors or other safety devices. Refer repairs to qualified service personnel.

Notes:

Notes:

Replacement Parts.

For 75 and 98 gallon models using natural gas.

Instructions For Placing a Parts Order

All parts orders should include:

- 1 The model and serial number of the water heater from the rating plate.
- 2 Specify type of gas (natural or LP) as marked on the rating plate.

- 3 Part description (as noted below) and number of parts desired.

CAUTION: For your safety, DO NOT attempt repair of gas piping, Combination Gas Control (thermostat), burners, vent connectors or other safety devices. Refer repairs to qualified service personnel.

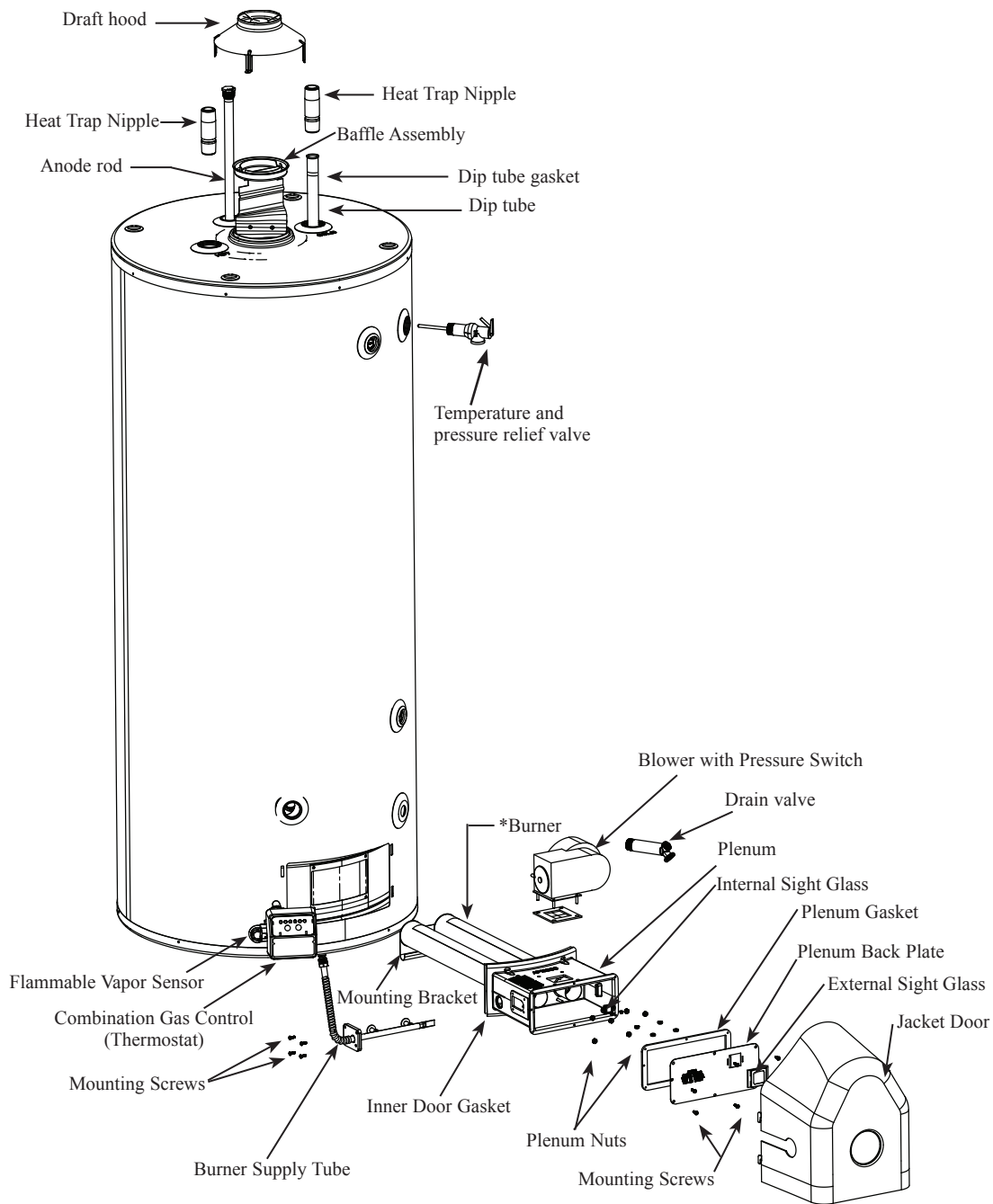

IF YOU NEED SERVICE



1. Should you have any questions about your new water heater, or if it requires adjustment, repair, or routine maintenance, it is suggested that you first contact your installer, plumbing contractor or previously agreed upon service agency. In the event the firm has moved, or is unavailable, refer to the telephone directory, commercial listings or local utility for qualified service assistance.

2. Should your problem not be solved to your complete satisfaction, you should then contact the Manufacturer's National Service Department at the following address:

Rheem Manufacturing Co.
Water Heater Division
1241 Carwood Court
Montgomery, Alabama 36117
Phone: 1-800-432-8373.

When contacting the manufacturer, the following information will be requested:

- a. Model and serial number of the water heater as shown on the rating plate attached to the jacket of the heater.
- b. Address where the water heater is located and physical location.
- c. Name and address of installer and any service agency who performed service on the water heater.
- d. Date of original installation and dates any service work was performed.
- e. Details of the problems as you can best describe them.
- f. List of people, with dates, who have been contacted regarding your problem.