



QUICK TOUCH TIMER CONTROL

(PACKAGED INSIDE ELECTRICAL BOX)



JR-3 OR JR-4 STEAM GENERATOR



CONTROL CORD SET



WATER INLET



TWO 1/2" STEAM NOZZLE TD* AND ESCUTCHEON

* Tear Drop Essential Oil Reservoir

USE ONLY RELAX-A-MIST® FACTORY SUPPLIED PARTS

1. GENERAL INFORMATION (See Steam Generator Selection)
STEAM GENERATOR LOCATION

The steam generator should be located in a ventilated area outside of, but within 20 feet of the shower or steam room, where the steam pipes can be installed without the possibility of a steam trap. The steam generator may be placed under the floor, in a closet, or any convenient location where it WILL BE LEVEL, DRY, AND WILL NOT FREEZE in the winter. The steam generator MUST be easily accessible should service be required in the future. INSTALL THE STEAM GENERATOR WITH THE COPPER STEAM PIPES COMING OUT OF THE TOP OF THE APPLIANCE AND THE ELECTRICAL BOX FACING THE ACCESS! See Fig. 1.

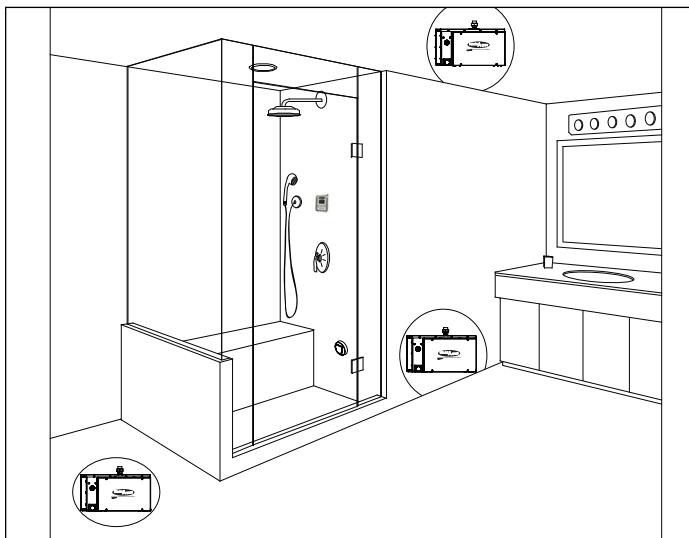

Fig. 1

STEAM PIPING AND STEAM NOZZLE (To and in the steam room)

The steam pipes must be a minimum of 1/2 inch I.D. rigid copper. Installing the steam pipes using the most direct or shortest route (WITHOUT FORMING A STEAM TRAP) and with the fewest number of elbows will, in most cases, maintain a lower pressure (less than 1 lb) in the boiling tank than a longer route with many elbows.

The Relax-A-Mist® steam nozzle installation uses standard construction materials, tools and methods. Depending on wall thickness, custom sized nipples may need to be fabricated by the plumber or purchased from a local hardware store. It is important to install the steam nozzles in an area where a person cannot be burned from the hot steam exiting the nozzles. The steam nozzles were designed to be installed on a flat surface. During the final installation, the steam nozzles supplied MUST be used. See **Steam Piping to Bath or Shower, CAUTION 1-3**, and **Fig. 2**.

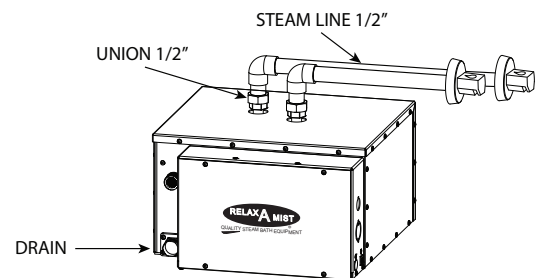

Fig. 2

CAUTION: There is to be **NO RESTRICTION** in the **STEAM PIPES** BETWEEN the **STEAM GENERATOR** and the **STEAM NOZZLES** that would in any way cause **PRESSURE** to build in the **STEAM GENERATOR**. **INSTALL** the **STEAM NOZZLES** **12 INCHES** above the finished floor, in a **LOCATION** where the **STEAM** WILL NOT BURN anyone.

TIMER SWITCH (Steam Generator Control)

The Quick Touch Timer can be located inside or outside the steam room. If using the optional Time and Temperature Control, refer to that control's installation instructions now. Relax-A-Mist® timer switches are not precision timing devices. See **CAUTION 11**.

DRAIN VALVE OPTION (Ask Dealer For Details)

A 3/4 inch copper, female adapter (located below the water supply connection), can be plumbed to a drain with either a manual shut-off or an automatic drain valve installed at the steam generator (purchased separately). See **Fig. 2**.

2. ROUGH-IN

WATER SUPPLY (According to Local Plumbing Code)

The water supply pipe should be equipped with a shut-off that is accessible and close to the steam generator. Installation of a water hammer arrester (water bumper) is recommended. To maintain a proper water level in the generator, the water supply should have a minimum of 20 lbs pressure. If the water supply contains impurities that could cause scale build-up or corrode the steam generator, install appropriate water treatment. See **CAUTION 4** and **WARRANTY POLICY**. See diagrams on **Page 6**.

DRAIN VALVE OPTION (According to Local Plumbing Code)

Installing a drain line is optional; the steam generator is supplied with a 3/4 inch brass plug installed in the drain pipe. If installing a drain line, a 3/4 inch drain valve and rigid copper pipe must be installed from the steam generator location to a drain. Water must be able to drain from all sections of the drain line at all times. Ask dealer for details.

ELECTRICAL - WATTS, WIRE, AND FUSE SIZES

(According to Local Electrical Code - Use Copper Wire Only - Must be Installed by a Qualified Electrician)

Check to ensure that the supply voltage (either 208V or 240V) is compatible with the voltage listed on the steam generator identification label (below water supply). The fuses or circuit breaker must be of adequate size to carry the necessary amperage to operate the steam generator.

STEAM GENERATOR:	JR-3	JR-4
WATTS	6,000	9,000
Hz	60	60
Phase	1	1
208 VOLTS		
Fuse/Breaker Size	40 Amp	60 Amp
Copper Wire - Supply	#8 AWG	#6 AWG
Copper Wire - Switch	#22 AWG	#22 AWG
240 VOLTS		
Fuse/Breaker Size	40 Amp	50 Amp
Copper Wire - Supply	#8 AWG	#8 AWG
Copper Wire - Switch	#22 AWG	#22 AWG
* Must use supply wires suitable for 90°C		
* Wire size may differ depending on temperature rating; consult with certified Electrician.		

Select a convenient location in the steam room, within 20 feet of the steam generator (5 feet up from the finished floor, **away from the area above the steam nozzles**), to install the Quick Touch Timer (found in the appliance electrical box), and cord set packaged with steam unit. Cut a 7/8 inch hole in the wall material and pass the female end of the cord set through the wall for final installation **OR**, the Time and Temperature Control with remote may be installed (**purchased separately**). **ASK DEALER FOR DETAILS.**

There is one class 1, 2 conductor copper wire and ground power cable, and one, factory supplied, class 2 25 foot control wire to be run to the steam generator:

- a) Run a copper power supply cable, 2 wire

and ground, of adequate gauge to carry the necessary amperage from the fuse or circuit breaker to the steam generator location.

- b) Run the factory supplied 25 foot cord set from the steam generator location to the Timer Control location. Leave sufficient length at each end of cord set for the final installation connections. See **CAUTION 8-10**.

THE ELECTRICAL “SUPPLY” FOR THE STEAM GENERATOR **CANNOT** BE SWITCHED DIRECTLY BY THE TIMER CONTROL SUPPLIED WITH THE STEAM GENERATOR. **Use Copper Supply Wire Only.** The copper power supply cable must run directly from the fuse or circuit breaker to the steam generator. The factory supplied cord set must be run directly from the steam generator to the Timer Control. The Timer Control activates a contactor in the steam generator, through the class 2 voltage circuitry.

STEAM PIPING TO BATH OR SHOWER

The steam pipes must be a minimum of 1/2 inch I.D. type “L” rigid copper. Install rigid copper pipes (maximum length of 25 feet), from the steam generator to where it will enter the steam bath area, in a location where the steam will not burn anyone. Insulate the steam pipes for maximum efficiency. **WARNING: STEAM NOZZLES ARE HOT.**

The 1/2 inch end of the steam pipes at the steam room should have female pipe thread fittings that are attached to something solid, (example: “wing-back 90 elbows”). **IMPORTANT - Ensure the elbows are perpendicular to the finished wall on two axis. Check their orientation by threading in a nipple that extends past the studs and out beyond the finished wall.** This way during the final installation of the steam nozzles, they will be square to the finished wall. Be sure the wing-back 90 elbow backing can withstand the force of tightening the nipple and steam nozzle to the correct torque required to prevent leaks. For steam nozzle location purposes during rough-in, install 1/2 inch iron pipe nipples into the female fittings, hand tight, between 2 and 2-1/2 turns (the final tightening will be 4 turns), so they will protrude through the wall into the steam room. After the finished walls are in place, the iron nipples will be replaced by brass nipples of the appropriate length. See **Final Installation Steam Piping** and **Fig. 3**.

- 1- Steam nozzle
- 2 - Escutcheon
- 3 - Sealer (silicone)
- 4 - Finished wall
- 5 - 1/2" brass nipple
- 6 - 1/2" C x FIP adapter
- 7 - 1/2" C x C wing-back elbow
- 8 - 1/2" copper pipe type “L”
- 9 - 12" from steam pipe to steam room floor.

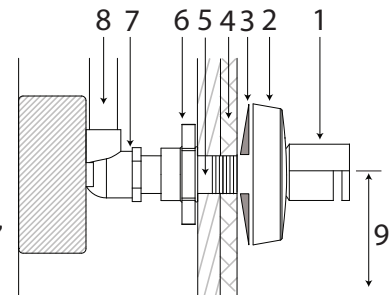

Fig. 3

WARNING: STEAM NOZZLES ARE HOT.

In a shower or steam room, the centre of the brass nipples and steam nozzles must be 12 inches above the finished

floor and in a location away from the user's pathways, where the steam will not burn anyone, preferably on the same wall as the shower controls. See **Fig. 1**.

If the steam nozzles are installed too low or too close to a corner, the steam will strike the floor or wall (may cause damage to tile grout) and condense into water before it can heat and steam the room. Installing the steam nozzles correctly, in the lower part of the room, ensures a more even distribution of the heat and steam. It is not recommended to place the steam nozzles under a bench, as there is a distinct possibility that someone sitting on the bench could inadvertently put their feet underneath it and be burned. When the steam nozzles are installed under a bench, it is sometimes impossible for the heat and the steam to circulate throughout the room.

Care **MUST** be taken to **AVOID A STEAM TRAP!** Water must be able to drain from all sections of the steam pipes at all times. See **CAUTION 1-2** and **Fig. 4**.

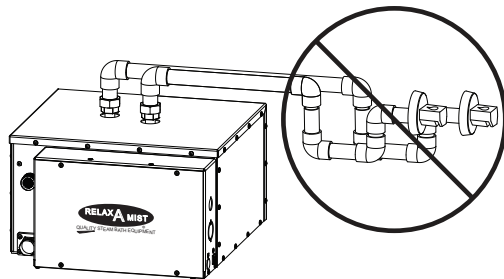

Fig. 4

3. FINAL INSTALLATION

WATER SUPPLY (According to Local Plumbing Code)

The water inlet connection on the steam generator is a male garden thread. A swivel garden hose to 3/8 inch tubing adapter is supplied for the installer's connection. The swivel adapter will be a union. Install a shut-off on the water supply and reduce it to use 3/8 inch O.D. soft copper tubing. Use 3/8 inch O.D. soft copper tubing between the shut-off and the swivel adapter at the steam generator. Form a "loop" in the 3/8 inch soft copper

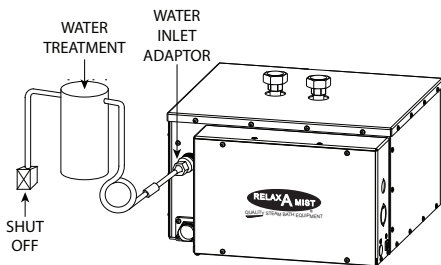

Fig. 5

tubing to ensure the boiler is being installed level. See **Fig. 5**.

DRAIN VALVE OPTION (According to Local Plumbing Code)

Install the shut-off (purchased separately), within 1 foot of the steam unit, between the 3/4 inch copper female adapter and a 3/4 inch union attached to the drain line. The drain valve must be in the closed position while the steam generator is in operation. Ask dealer for details.

ELECTRICAL (According to Local Electrical Code)

Check to ensure that the supply voltage (either 208V or 240V) is compatible with the voltage listed on the steam generator identification label (below the water supply). Pull the roughed-in copper supply cable (2 wires and ground) into the steam generator electrical connection box using the knock-outs; **DO NOT** drill holes in the electrical box. Proceed with "a & b". Move the control cord set to the outside right of the electrical connection box and proceed with "c & d".

- a) Connect the copper power supply ground wire to the Relax-A-Mist® grounding lug inside the appliance's electrical connection box; use provided knockouts.
- b) Connect the two copper wires from the power supply, one to each of the red and black Relax-A-Mist® wires inside the electrical box. See **Fig. 6**.
- c) On the side panel of the steam generator electrical box, remove the protective label marked "Remove To Insert Modular Connector", from the rear modular female plug. Front plug is for optional Automatic Drain.

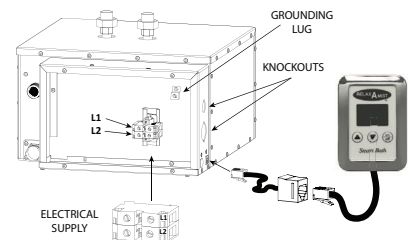

Fig. 6

Note: At this point, **the control, cord set and steam generator functions must be tested.** Before continuing with the final electrical installation, proceed to **Timer Pretest**. After the Timer Pretest has successfully been completed, continue to step **d**).

- **DO NOT CUT FACTORY WIRING TO INSTALL TIMER SWITCH**
- **DO NOT FORCE CONNECTIONS**
- **SEE CAUTION 6-12**
- **DO NOT ADHERE QUICK TOUCH TIMER TO WALL UNTIL TIMER PRETEST HAS SUCCESSFULLY BEEN COMPLETED.**

TIMER PRETEST

The following instructions are for the Quick Touch Timer. If you have purchased the Time and Temperature Control with remote or an alternate control, refer to their instructions now.

- i) With the water and power supply turned on, insert the male plug from the Quick Touch Timer wire directly into the steam generator female connector so the retaining tab locks in place with an audible "click". See electrical diagram on **Page 7**. The timer display will illuminate two horizontal bars, indicating the timer is connected and has power. If the timer display does not illuminate horizontal bars, check all electrical connections and correct. If problem persists, call 1-800-Y-U-STEAM (1-800-987-8326) Monday to Friday, 8:00am to 4:30pm PST or e-mail technicalsupport@relax-a-mist.com for assistance.

- ii) When the display illuminates the horizontal bars, press the “on/off” button; the display will show 30 minutes. Listen to hear the generator filling with water and the audible “click” of the contactor closing. When the water valve finishes filling the unit, arrow the timer control down to zero. When zero is reached, the horizontal bars will reappear and the steam unit will turn off.
- iii) Remove the plastic cover from the timer cord set and insert the male plug, retaining tab to bottom, into the female plug on the steam generator. At the timer control location, remove the protective label from the female connector on the cord set. Insert the male plug from the Quick Touch Timer wire into the female connector. When the display illuminates the horizontal bars, press the “on/off” button; the display will show 30 minutes. When steam enters the room, arrow the timer control down to zero. When zero is reached, the horizontal bars will reappear and the steam unit will turn off.
- iv) This successfully completes the **Timer Pretest**; turn off the water and power supply and proceed to step d).
- d) If the **Timer Pretest** has been successfully completed, the Timer Control may now be applied to a clean, flat, dry, finished surface. Peel off the protective film from the back of the timer. Push the excess cord into the wall cavity. Firmly press the Quick Touch Timer onto the wall. If the wall surface is uneven, apply a silicone sealant to seal around the timer switch. Continue to **Steam Piping**.

STEAM PIPING

THE STEAM GENERATOR MUST BE POSITIONED WITH THE STEAM PIPES COMING OUT OF THE **TOP** OF THE UNIT. Using the 1/2 inch union provided and 2 wrenches, connect the roughed-in steam pipes to the generator steam pipes. Where the 1/2 inch iron pipe nipples stick out from the finished wall in the shower, measure one inch along the nipples from the wall and make a mark. Remove the 1/2 inch iron nipples used during the rough-in. Measure the iron nipples from the threads to the mark and use brass nipples of that length to install the steam nozzles and escutcheons tight to the wall. The steam nozzles must be installed with the “tear drop” reservoir facing up and the “steam slot” pointing down. Once the appropriate size nipples have been selected, apply Teflon tape or thread sealant on both ends of the nipples. Apply silicone around the back of the brass pipe adapter to seal between the adapter and the tile. Wipe away any excess silicone from around the steam nozzles. See **Fig. 3, Fig. 7, and Fig. 8.**

Note: Masking the nozzles and wall with tape may help to avoid getting excess silicone on the nozzles and tile.

In a shower or steam room where the steam lines have been roughed in according to the instructions above, the installed steam nozzles should be against the wall and there should be 12 inches from the steam nozzle opening to the finished floor.

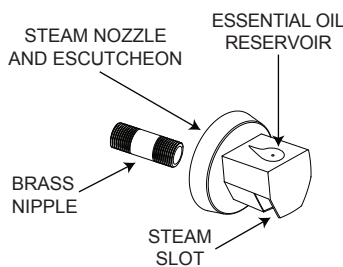

Fig. 7

- 1- Steam nozzle and escutcheon
- 2 - 1/2" C x FIP adapter
- 3 - 1/2" brass nipple
- 4 - 1/2" C x C wing-back elbow
- 5 - 1/2" copper pipe type "L"
- 6 - Finished wall
- 7 - 12" from steam pipe to steam room floor

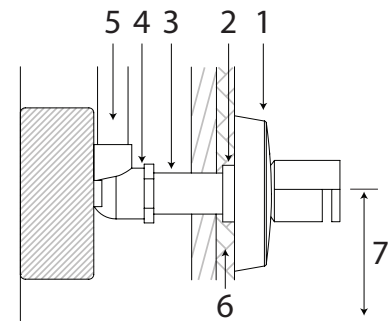

Fig. 8

CAUTION CAUTION CAUTION

- 1. a. Under NO circumstances are the steam lines from the steam generator to be restricted or reduced to less than 1/2 inch inside diameter, or contain a steam trap. Recommended steam line distance: maximum 25 feet.
- b. Under NO circumstance is there to be a valve or other obstruction in the steam lines.
- 2. Water MUST be able to drain from ALL sections of the steam lines at all times.
- 3. Use only the steam nozzles that are supplied with the steam generator. For safety reasons, they MUST be used.
- 4. Adequately treat impure water or the Warranty may become null and void.
- 5. The steam generator MUST be positioned so that THE STEAM LINES COME OUT OF THE TOP OF THE APPLIANCE.
- 6. Use only the factory modular cord set supplied with appliance. Any substitute connector or cord set may damage or will not operate the appliance and will void the Warranty.
- 7. Cutting or tampering with the internal wiring or cord sets will void the Warranty.
- 8. **DO NOT** install the Timer Control above the steam nozzles. Place away from area above the steam nozzles.
- 9. **DO NOT** pull on the cord set plugs during installation.
- 10. Check orientation of female and male low voltage connectors to ensure parts are inserted in the correct position.
- 11. **DO NOT** adhere the Timer Control to the wall until the **Timer Pretest** procedure has been **successfully completed**.
- 12. Installations are to be performed by a qualified Plumber and Electrician, in accordance with **local plumbing and electrical codes**.

Relax-A-Mist® Steam Equipment Specifications

STEAM GENERATOR START UP

The following instructions are for the Quick Touch Timer. If you have installed the Time & Temperature Control with remote or an alternate control, refer to their start up instructions now.

- To start, make sure the electrical supply and the water supply are both in the **OFF** position. Make sure that all plumbing and electrical connections are correct. Ensure the Flow Stabilizer (supplied with models JR1-4), has **NOT** been installed until after startup has been completed and only if required (see Flow Stabilizer instructions for more information).
- If the drain option is used with a manual shut-off, ensure it is in the closed position.
- Turn on the water supply to the steam generator. No water will enter the unit, as the electricity is still off at this point.
- Turn on the electrical supply to the steam generator.
- The display on the Quick Touch Timer has two horizontal bars illuminated. Press the "on/off" button on the Quick Touch Timer. The display will read "30" minutes. This will energize the contactor coil, which will sound an audible "click" as the contacts close and will in turn energize the water level sensing device. The water entering the appliance will be audible in the form of several short "spurts" of water and will stop when the operating water level has been achieved. If the unit shuts off before water fill is complete, press the "off" ("on/off") button on the Quick Touch Timer and then press the "on" ("on/off") button again to restart the cycle to complete the filling.
Caution: The steam nozzles are HOT. Warning: HOT Steam will burn you.
- Within approximately 2 minutes from energizing the Relax-A-Mist®, steam will be entering the steam room.
Scalding Caution: When the generator is first turned on, there may be an initial burst of hot water from the steam nozzles until the steam lines have come up to temperature. After the steam room has heated to a satisfactory temperature, adjust the timer display by pressing the "up" or "down" arrows to increase or decrease the length of time desired for a steam bath.
- Leave these installation instructions at the steam generator or with the home owner. Sit back, relax, and enjoy!

STEAM GENERATOR SELECTION

To select the correct size of steam generator, add the cubic footage of the shower with the appropriate adjustment to determine the calculated cubic footage:

- Length x Width x Height = CUBIC FOOTAGE. Do not deduct for seating.
- Add appropriate adjustment to account for heat loss through materials:

Acrylic or Fiberglass	No adjustment
Ceramic Tile, ¼" thick, or Cultured Marble	+ 30%
Ceramic Tile, ⅜" thick or thicker	+ 100%
Glass or Glass Block wall	+ 15%
Natural Stone or ½" thick material	+ 100%
Steam lines over 25 feet (insulate heavily)	+ 25%
Cast Iron Tub	+ 25%
Exterior walls subject to freezing	+ 30%
- Select the generator that corresponds to your calculated cubic footage:

Model Number	JR-1	JR-2	JR-3	JR-4
Maximum Calculated Cubic Feet	90	175	260	375

- Line voltage must be specified when ordering. **Units available in 240 or 208 Volts, 1 Phase. Single family dwellings usually have 240 Volts AC while condominiums usually have 208 Volts AC.**

Note: Use Copper Wire Only. Do not drill holes in electrical box, use provided knockouts.

DISCLAIMER:

The above information represents suggestions only. Each steam room is unique. Relax-A-Mist® manufactures steam generators only and therefore cannot warrant information given regarding steam room materials or construction techniques. Final selection of the steam room temperature setting and the duration of stay is at the discretion of the operators or owners.

Example
 A steam room is 3' wide x 5' long x 7' high with 3/8" ceramic tile.

3' x 5' x 7' = 105 cubic feet
 + 100% (for 3/8" thick ceramic tiles)
 = **210 calculated cubic feet**

For a room this size, we would recommend our model **JR-3** for rooms up to 260 calculated cubic feet.



DIAGRAM SHEET JR-3 & JR-4 - PLUMBING



WATER SUPPLY

HOSE CONNECTION FOR WATER SUPPLY
(FACTORY SUPPLIED)

DO NOT INSTALL FLOW STABILIZER UNTIL AFTER PRETEST IS COMPLETE AND ONLY IF REQUIRED

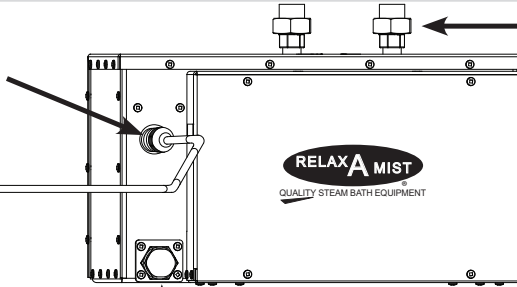
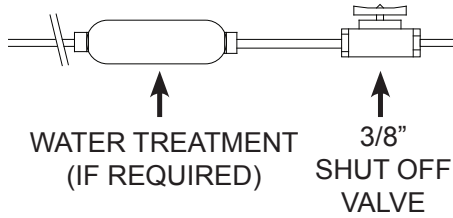

TWO 1/2" STEAM PIPES

CAUTION: DO NOT REMOVE DRAIN PLUG WITHOUT INSTALLING SHUTOFF VALVE

OPTIONAL DRAIN FEATURES

MANUAL DRAIN VALVE (SEE YOUR DEALER)

REQUIRED PARTS TO INSTALL MANUAL DRAIN VALVE:

- 3/4" MALE ADAPTOR
- 3/4" COPPER PIPE
- 3/4" BALL VALVE

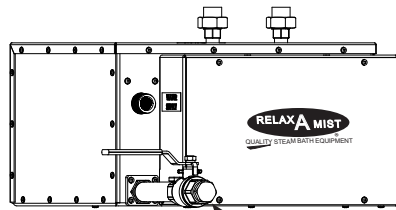

PLUMB TO DRAIN

CAUTION: DRAIN VALVE MUST BE CLOSED WHEN UNIT IS IN OPERATION

ELECTRONIC DRAIN VALVE (SEE YOUR DEALER)

REQUIRED PARTS TO INSTALL ELECTRONIC DRAIN VALVE:

- 3/4" ELECTRONIC DRAIN VALVE (FACTORY SUPPLIED OR ORDERED)

DO NOT INSTALL FLOW STABILIZER

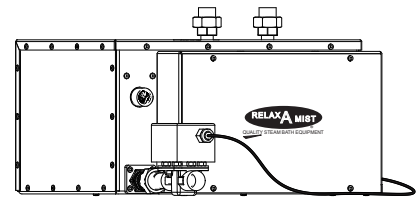

PLUMB TO DRAIN

STEAM LINE PIPING & STEAM NOZZLE

- 1/2" COPPER PIPE, TYPE "L"
- SLOPE PIPE TOWARD STEAM GENERATOR

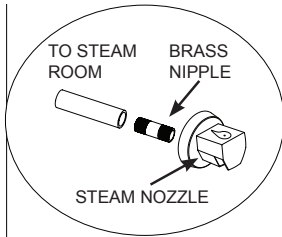
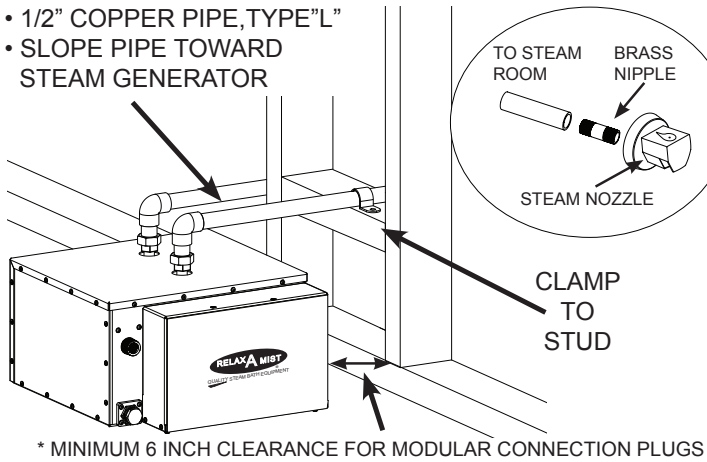

CLAMP TO STUD

* MINIMUM 6 INCH CLEARANCE FOR MODULAR CONNECTION PLUGS

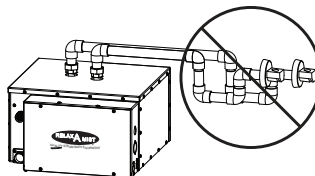

CAUTION: DO NOT CREATE A STEAM TRAP!

TYPICAL STEAM NOZZLE INSTALLATION

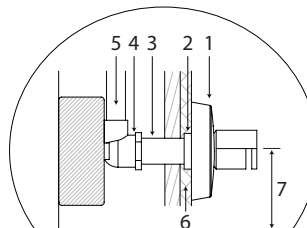

- 1- STEAM NOZZLE AND ESCUTCHEON
- 2 - 1/2" C X FIP ADAPTER
- 3 - 1/2" BRASS NIPPLE
- 4 - 1/2" C X C WING-BACK ELBOW
- 5 - 1/2" COPPER PIPE TYPE "L"
- 6 - FINISHED WALL
- 7 - 12" FROM STEAM PIPE TO STEAM ROOM FLOOR

- 12" FROM FINISHED FLOOR
- 12" FROM FINISHED SIDE WALL
- STEAM ROOM LAYOUT WILL DETERMINE THE STEAM NOZZLE LOCATION

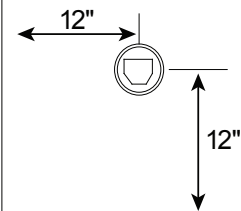

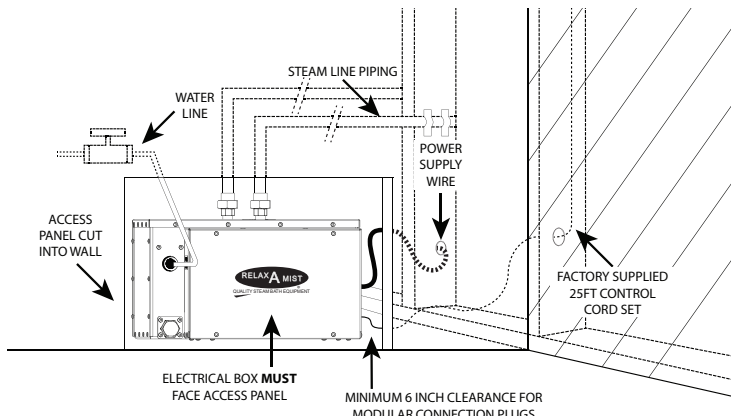

DIAGRAM SHEET JR-3 & JR-4 - ELECTRICAL



POWER SUPPLY 240/208V 1Ph

ELECTRICAL BOX MUST BE ACCESSIBLE



- CONNECT GROUND WIRE TO GROUNDING LUG
- CONNECT ELECTRICAL POWER SUPPLY WIRES TO "L1" AND "L2" TERMINALS IN ELECTRICAL BOX STEAM GENERATOR

NOTE: POLARITY MUST BE MAINTAINED WHEN CONNECTING MULTIPLE UNITS

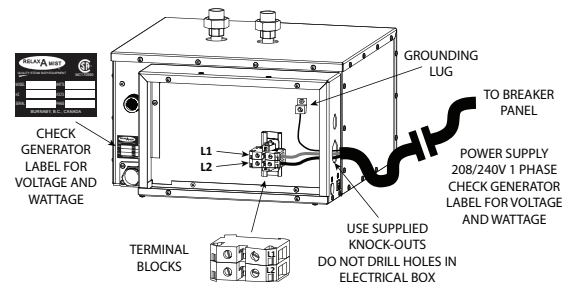

MODULAR CONNECTORS

QUICK TOUCH TIMER CONTROL

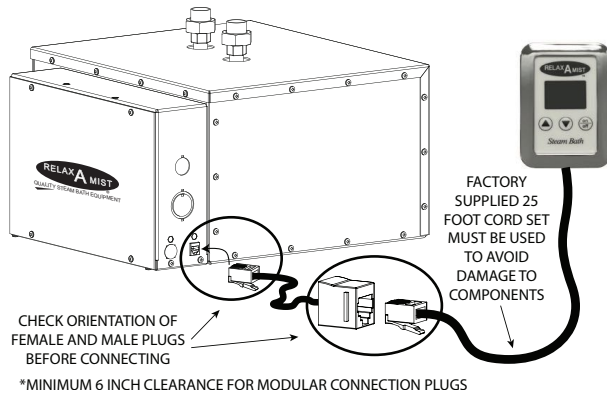

MODULAR CONNECTOR

CAUTION: INSERT FACTORY SUPPLIED CORD SET INTO RECEPTACLE MARKED "TIMER SWITCH 24VAC". GENERATOR CANNOT BE STARTED WITHOUT MODULAR CONNECTOR.

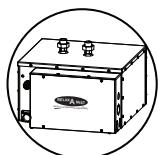
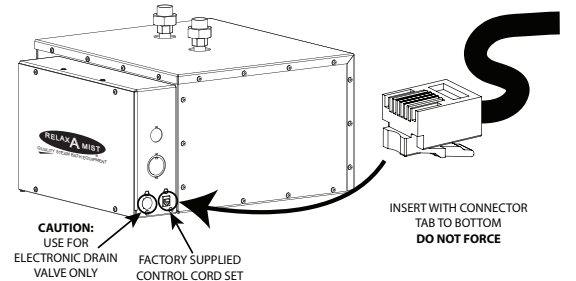

CORRECT

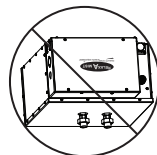

WRONG

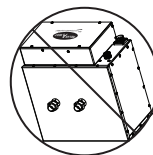

WRONG

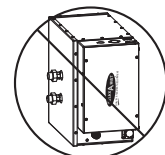

WRONG

THIS CARTON CONTAINS:

- 1 - STEAM GENERATOR
- 1 - HOSE CONNECTION (FOR WATER SUPPLY)
- 2 - 1/2" STEAM NOZZLES AND ESCUTCHEONS
- 1 - CONTROL SWITCH
- 1 - CONTROL CORD SET (25FT)
- 1 - INSTALLATION INSTRUCTIONS
- 1 - DIAGRAM SHEET

CAUTION INSTALLER!

WARRANTY MAY BE VOID IF:

- WIRES CUT
- FUSES ON PCB ARE BURNT
- GENERATOR IS INSTALLED IN INCORRECT POSITION
- ELECTRICITY TO UNIT TURNED ON WITHOUT WATER SUPPLIED
- STEAM GENERATOR IS PRESSURIZED OR USED TO PRESSURE TEST STEAM LINE PIPING
- HOLES DRILLED INTO ELECTRICAL BOX
- FACTORY SUPPLIED MODULAR CORD SET NOT USED
- INSTALLER FAILS TO FOLLOW ANY OF THE RELAX-A-MIST® INSTALLATION INSTRUCTIONS



WARRANTY POLICY

For a period of one year from the date of installation, or 18 months from the date of manufacture, whichever comes first, all parts and assemblies are warranted as to workmanship and materials used in their manufacture. There is no cosmetic warranty on installed parts or controls. Any Relax-A-Mist® products containing defective parts, if returned prepaid to an authorized Service Depot within the one year or 18 month time limit, will be repaired free of charge, F.O.B. the authorized Service Depot making such repairs.

The Company will not be responsible for any breakdown, damage, or losses, direct or indirect, arising in contract or in tort from any cause whatsoever, including failure to follow the Relax-A-Mist® installation instructions specifically, careless handling, improper voltage supply, corrosion and/or electrolysis or a buildup of minerals on the parts or assemblies for any reason or from any source; nor for transportation and/or other charges incurred in the removal, replacement or repair of defective products or parts; and there are no warranties or conditions expressed or implied or otherwise applicable, to the company's products except as expressly stated herein.

**WARRANTY IS VOID IF RESIDENTIAL STEAM GENERATORS
ARE USED IN A COMMERCIAL INSTALLATION.**

AUTHORIZED SERVICE DEPOTS

BRITISH COLUMBIA

LEISURE BATHS LTD.
6909 Antrim Avenue
Burnaby, BC V5J 4M5

TEL 604-437-4717
or 1-800-Y-U-STEAM
(1-800-987-8326)
FAX 604-437-5776

MANITOBA

BALCAEN & SONS LTD.
1392 Pembina Highway
Winnipeg, MB R3T 2C1

TEL 204-475-1506
FAX 204-287-2222

ALBERTA

FRASER-BOND LTD.
9452 Almond Crescent S.E.
Calgary, AB T2J 1B6

TEL 403-253-7533
FAX 403-253-7583

ONTARIO

ACCORD APPLIANCE INC.
#17 - 750 Oakdale Rd.
North York, ON M3N 2Z4

TEL 416-743-4181
FAX 416-743-4183

ALBERTA

LEHMANN PLUMBING
3649 73 Avenue
Edmonton, AB T6B 2T8

TEL 780-465-4434
FAX 780-465-4595

QUEBEC

THOMAS & SCHMIDT (T&S)
2825 rue Sabourin
Saint-Laurent, QC H4S 1M9

TEL 514-745-1556
or 1-800-363-0708
FAX 514-745-4777

For assistance, phone Relax-A-Mist® at 1-800-Y-U-STEAM (1-800-987-8326) or e-mail: technicalsupport@relax-a-mist.com