



# MASTER

*Water Conditioning Corp.*

[www.masterwater.com](http://www.masterwater.com)

---

## Installation and Operation Manual



---

## **10/20 COMBINATION UNIT with the 255/742 Logix Control Valve With Vortech**

October 2006

## Table of Contents

Page No.	Topic	Description
1	Model # and Packaging	Packaging Information
	Component Packaging Description	Packaging Description
	MBA Logix Control Valve	Valve Description
2	Softening System	System Positioning
	Combination Unit Tank Loading	Filling with Media
3	Logix 255/742 Control Valve	Attaching Valve to Tank Figure 1 & Figure 2
4	Service & Drain Piping, General Installation Layout	Drain Piping Figure 3
5	System Schematic	Piping Layout
6	Electrical Supply	Electrical Requirements
	Brine Tank / Brine Tubing	Brine tank w/shut off
7	Logix 255/742 Control Valve Electrical Connection	Instructions on Logix 742 Electrical Connection
	Filling Combination Unit with Water	Details for Filling Tank with Water
8	Filling Combination Unit with Water Continued	Details for Filling Tank with Water Continued
	Logix 742 Control Valve Timer Settings	Setting the Timer
9	Logix 742 Control Valve Timer Settings Continued	Setting the Timer Continued
10	Final Check	Final Installation Check
11	Troubleshooting	Symptom / Cause / Solution
12	Troubleshooting	Symptom / Cause / Solution
13	Troubleshooting	Symptom / Cause / Solution
14	ERR Troubleshooting	Error Troubleshooting
15	255/742 Valve Body Schematic	Parts View
16	Valve Body Parts List	Part Numbers List
17	Valve Parts List	Part Numbers List
18	Warranty	Warranty

**Installation and Operating Instructions for**  
**255/742 Logix**  
**Top Mount Combination Unit**

**Model #:**

\_\_\_\_\_ FES-10T      \_\_\_\_\_ FES-20T Iron Filter and Softener  
 \_\_\_\_\_ NS-10T      \_\_\_\_\_ NS-20T pH Control and Softener  
 \_\_\_\_\_ TS-10T      \_\_\_\_\_ TS-20T Dechlorination and Softener

**Shipping Carton Description / unit:**

# of cartons	Contents	Description
1	Mineral tank	Distributor pipe installed
1	255/742 Logix control valve	255/742 timer and bypass with 3/4" copper or pvc connection NOTE: The control valve is shipped in the brine tank.
	Birm for FES	½ CF Boxes
	NS-Mix for NS	½ CF Boxes
	Carbon for TS	½ CF Boxes

**\*Note: The units have Vortech and do not require gravel.**

**System Description:**

The combination unit has a Logix top mounted automatic control valve with an electronic timer to initiate regeneration. The Logix Valve is constructed of non-corrosive Noryl® material and is rated at a maximum working water pressure of 100 psi. It uses a 742 microprocessor based timer to actuate regeneration in the following ways:

- a. Manual regeneration button to start an emergency regeneration
- b. Regeneration day setting

**NOTE: THIS COMBO UNIT IS NOT INTENDED TO BE USED FOR TREATING WATER THAT IS MICROBIOLOGICALLY UNSAFE OR OF UNKNOWN QUALITY WITHOUT ADEQUATE DISINFECTION WHETHER BEFORE OR AFTER THE SYSTEM.**

**Combination Unit Positioning:**

1. Place combination unit in desired position, far enough from walls and other obstructions to allow for servicing the unit.
2. Place the combination unit within reasonable access to a grounded 115V/60 HZ circuit and a legal drain line connection.

**Combination Unit Tank Loading:**

1. Remove yellow caplug from top of tank. DO NOT CUT white riser tube. Tube was prefitted at the factory.
2. Center the distributor and make sure it is resting on the bottom of the tank. The top of the distributor pipe will extend above the top of the tank (this was prefitted at the factory).
3. Cover the top opening of the distributor pipe before filling the tank with media.

<b>Model</b>	<b>Carbon</b>	<b>Birm</b>	<b>NS-Mix</b>
<b>TS-10 &amp; 20T</b>	1/2-cubic foot		
<b>FES-10 &amp; 20T</b>		1/2-cubic foot	
<b>NS-10 &amp; 20T</b>			½-cubicfoot

4. Pour all filter media provided with the unit into the top of the tank. See page one for your specific model number of unit to determine the amount of media to load into the mineral tank.
5. Remove the material used to cover the top opening of the distributor pipe.

**Logix Control Valve:**

1. When facing the front of the Logix timer, the inlet connection (**Figure 1**) is located on the left and the outlet connection is on the right. The control valve's inlet and outlet connections are either 3/4" copper or pvc equipped with gasket and nut.

Figure 1

Left Side                      Right Side

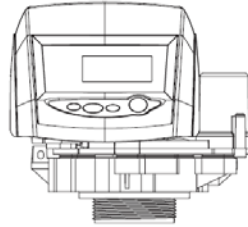

Install the 256 bypass valve (**See Figure 2**) with inlet and outlet handles facing upward. Place gasket into nut and secure 1" copper or pvc tail piece with a nut. Repeat the procedure for the outlet connection.

**DO NOT OVERTIGHTEN THE NUT.**

Figure 2

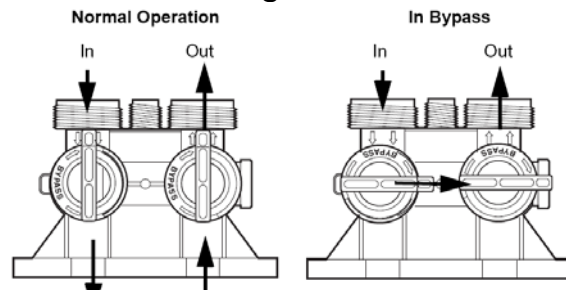

2. The control valve's drain connection is 1/2" npt and is located on the back of the control valve.
3. Turn the control valve upside down and ensure that the control valve distributor o'rings are in place. Use silicone lubricant on the o'rings.
4. Place the control valve onto the distributor pipe.
5. Thread the control valve hand tight to 20 foot pounds!

**DO NOT OVERTIGHTEN!**

**\*\*DO NOT USE PETROLEUM!\*\***

**\*\*USE ONLY SILICONE \*\***

### ***Service and Drain Piping:***

1. Pipe combination unit into the service lines .The inlet and outlet connections of the control valve are 3/4" copper or pvc and are located on the back of the valve body. As you face the timer the inlet is on the left and and the outlet is on the right. Always follow local plumbing codes when installing our water treatment equipment.
2. If sweat fittings are used, be sure soldering is done in such a manner as not to allow heat to reach the control valve or bypass. (If Schedule 80 PVC is used make sure to follow the proper primer and solvent instructions.)
3. The drain line connection is located on the back of the valve as you face the timer. It is recommended you install a ½ " union on the drain line for servicing. The drain line must be of adequate size to allow for full regeneration flow.

Figure 3

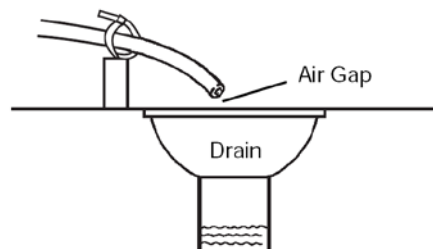

- The control valve drain connection is ½ " npt.
- Never decrease the drain piping size to below drain connection size.
- Maximum drain line length is 20 feet.
- Maximum drain line height is 6 feet above the control valve.
- The drain line must be piped to an open airgap (See Figure 3)
- Always follow local plumbing codes.



**WARNING:** Never insert drain line directly into a drain, sewer line or trap (Figure 8). Always allow an air gap between the drain line and the wastewater to prevent the possibility of sewage being back-siphoned into the conditioner.

**Typical Piping Layout**

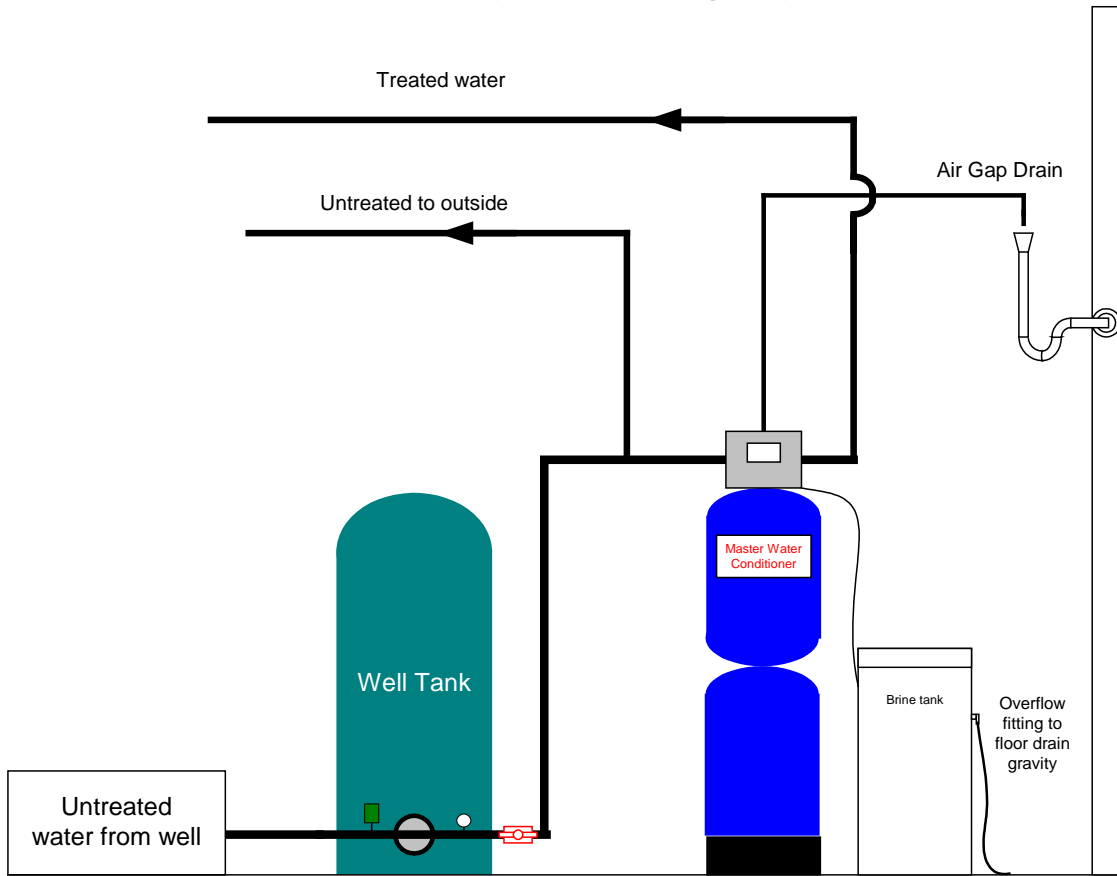

**NOTE:** All Master Water Conditioners must be installed after the well tank or water meter if its public water supply.

## **Electrical Requirements:**

Always follow all local electrical codes when installing our water treatment equipment.

1. Provide an 115v/60Hz properly grounded dedicated electrical outlet. (It's very important that the polarity be correct)  
**Avoid using outlets that are switch controlled.**
2. Maximum amperage required is 5 amps.
3. Make sure the electrical service provides power 24 hours per day.  
We recommend installing a **surge protector** to protect unit from power surges, which are not covered by warranty.

## **Brine Tank:**

1. The brine tank should be located directly beside the Combination Unit mineral tank.
2. Connect the 3/8" poly tubing to the 3/8" white elbow compression fitting located on the right side of the Logix control valve.

**See Figure Below.**

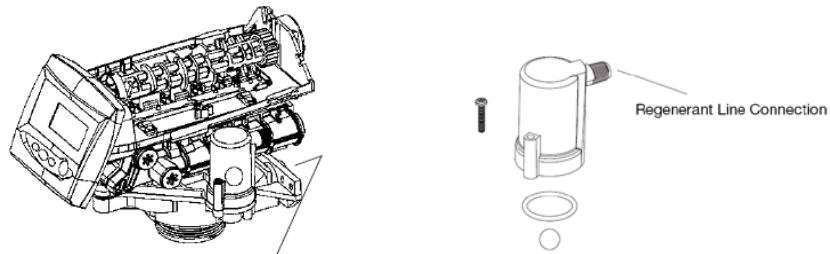

## **Logix Control Valve Electrical Connection:**

**Note: Do not touch the wiring harness between the Logix timer and the motor, it's positioning is critical and therefore already installed at the factory.**

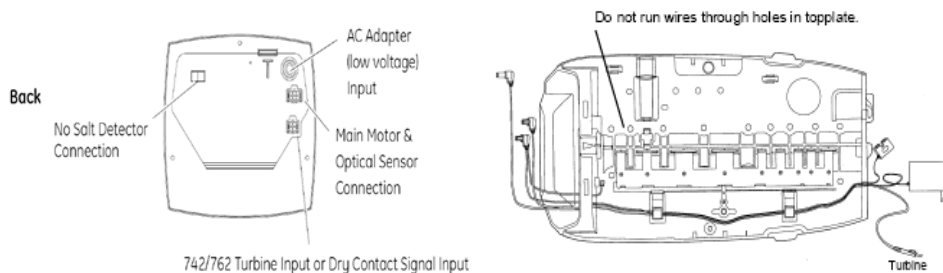



1. Remove plastic control valve cover by spreading sides while lifting.
2. Plug transformer into back of timer following the existing wires.
3. Plug transformer into a properly grounded 120V/60 HZ electrical outlet.
4. The screen will now display "255" then the "Time of Day".

**Filling Combination Unit with Water:**

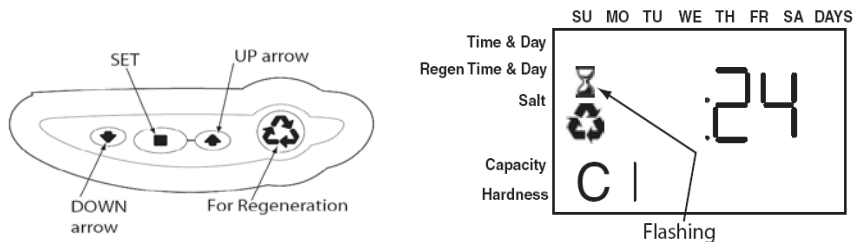

**Figure 4**

1. Push the FOR REGENERATION button (**Figure 4**) on the controller down for 5 seconds. This will initiate a manual regeneration. You will notice a flashing hour glass during regeneration.

The controller will indicate that the motor is turning the camshaft to cycle C1 (BACKWASH). The controller will indicate the total regeneration time remaining. Filling tank in this position allows air to escape from drain.

Open the bypass inlet valve ¼ turn and allow water to flow into the mineral tank at a slow rate.

**Warning: IF WATER ENTERS THE TANK TOO FAST, ALL THE RESIN WILL BE FLUSHED TO DRAIN DURING START UP.**

2. When water is running steadily at the drain, open the bypass valve's inlet and outlet to their maximum position.
3. Simultaneously press the SET and UP buttons on the controller for 1 second then release, the motor will advance the cam to C2. Once C2 is displayed simultaneously press the SET and UP buttons on the controller for 1 second then release, the motor will advance the cam to C3. Repeat this procedure until the timer enters the C7 (FAST RINSE) position. The softener will go through the rinsing cycle and then automatically advance to

(BRINE REFILL) C8 and fill the brine tank with the proper amount of water.

4. The control valve will advance to C0 (REGENERATION COMPLETE) and Time of Day will be displayed. This is treated water.

**Regeneration Cycles:**

- C1 – Backwash
- C2 – Regeneration Draw/Slow Rinse (not used in filter mode)
- C3 – Slow Rinse (not used in filter mode)
- C4 – System Pause (to repressurize tank)
- C5 – Fast Rinse cycle 1
- C6 – Backwash cycle 2 (not used in filter mode)
- C7 – Fast Rinse cycle 2 (not used in filter mode)
- C8 – Regenerant Refill (not used in filter mode)

**Logix Control Valve Timer Settings:**

**Note:** The control valve is set at the factory. You only need to set the time of day and regeneration time if required, which is preset at 2 am.

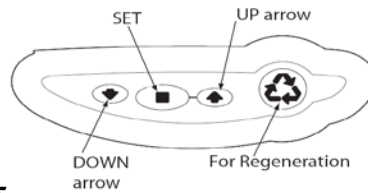

Figure 5

**Time of Day Setting**

- 1) Press the SET button. The screen will show the Time of Day in blinking numbers.
- 2) To change the Time of Day, use the UP or DOWN arrows.
- 3) Press the SET button.

**Day of Week Setting**

- 1) Press the SET button. The screen will show the Day of Week in blinking triangle.
- 2) To change the Day of Week, use the UP or DOWN arrows.
- 3) Press the SET button.

**Time of Regeneration Setting (the factory default is 2 AM)**

- 1) Press the SET button. The screen will show the Time of Regeneration in blinking numbers.
- 2) To change the Time of Regeneration, use the UP or DOWN arrows.
- 3) Press the SET button.

***Regeneration Frequency Setting (the factory default is 3)***

- 1) Press the SET button. The screen will show the Regeneration frequency in blinking numbers.
- 2) To change the number, use the UP or DOWN arrows.
- 3) Press the SET button.

If you wish to regenerate on certain days of the week, do the following:

- a. First, do steps above, but set at zero.
- b. Press SET button until you reach the day you wish to regenerate.
- c. Press the UP or Down arrows to set the day.
- d. Press the SET button to lock the day in.
- e. Repeat process to select the next day of regeneration.

NOTE: The days of Regeneration will be highlighted on the screen.

***Salt Amount Setting***

- 1) Press the SET button. The screen will show the Salt Amount as pounds in blinking numbers.
- 2) **DO NOT CHANGE THE NUMBER.**
- 3) Press the SET button.

***Softening Capacity Setting***

- 1) Press the SET button. The screen will show the Capacity as grains in blinking numbers.
- 2) **DO NOT CHANGE THE NUMBER.**
- 3) Press the SET button.

**Note: The time of day will remain on the screen when settings are complete.**

***Final Check:***

1. Fill the brine tank with Solar Salt and the Res-Up Feeders with Res-Up (one quart is provided).
2. Make sure the drain line connection meets all plumbing codes and that the drain line size can handle the backwash flow rate of the combination unit.
3. Make sure the Inlet and Outlet on bypass valve are open.
4. Make sure the control valve timer is plugged into an electrical outlet with power 24 hours per day.
5. Check all piping for leaks.

## Troubleshooting

**Symptom:** Water conditioner fails to regenerate. No soft water.

<b>Possible Cause</b>	<b>Solution</b>
Power supply to 742 control has been interrupted.	Determine reason for power interruption and correct. Reset time of day.
Water pressure lost.	Restore water pressure.
Corrupted programming of 742 Logix timer.	Reprogram timer assembly.
Defective 742 Logix timer.	Replace timer assembly.
No salt in brine tank.	Add salt and regenerate.
Manual bypass valve is open.	Close manual bypass valve.
Leak at riser pipe seal.	Insure that riser pipe is properly sealed at o'ring seal. InMPect pipe for cracks.
Insufficient brine.	Check brine float height and clean assembly if necessary. Check flow rate capabilities of safety float and air check assembly.
Plugged injector or injector screen.	Inspect and clean injector and/or injector screen.

**Symptom:** No Brine Draw

<b>Possible Cause</b>	<b>Solution</b>
Plugged injector or injector screen.	Inspect and clean injector and/or injector screen.
Insufficient water pressure.	Increase water pressure above 25 psig (172kPa) minimum.
Corrupted programming of 742 Logix timer.	Reprogram timer assembly.
Defective 742Logix timer.	Replace timer assembly.
Obstructed drain line.	Remove obstruction.

**Symptom:** Insufficient brine draw

<b>Possible Cause</b>	<b>Solution</b>
Partially clogged injector or injector screen.	Inspect and clean injector and/or injector screen assembly.
Restricted flow rate in brine line.	Check flow rate capabilities of the safety float/aircheck assembly.
Insufficient water pressure.	Increase water pressure above 25 psig (172kPa) minimum.
Excessive back pressure on injector due to elevated drain line.	Reduce drain line elevation to height of valve.
Damaged valve disk.	Replace all valve disks.
Partially restricted drain line.	Remove restriction.

**Symptom:** Insufficient Refill to Brine Tank

<b>Possible Cause</b>	<b>Solution</b>
Brine refill control	Remove and clean
Restricted flow rate in brine line.	Check flow rate capabilities of the safety float/aircheck assembly.

**Symptom:** Excessive Water in Brine Tank

<b>Possible Cause</b>	<b>Solution</b>
Plugged drain line flow control.	Clean flow control.
Plugged injector and/or injector screen	Inspect and clean injector and/or screen.

**Symptom:** Loss of Media to Drain

<b>Possible Cause</b>	<b>Solution</b>
No flow control installed in drain line.	Install drain line flow control.

**Symptom: Leak to Drain**

<b>Possible Cause</b>	<b>Solution</b>
No flow control installed in drain line.	Install drain line flow control.
Insufficient water pressure.	Increase water pressure above 25 psig (172kPa) minimum.
Damaged valve disk or obstruction in valve disk.	Inspect and if damaged, replace all valve disks or remove obstruction.

**Symptom: Loss of Water Pressure**

<b>Possible Cause</b>	<b>Solution</b>
Fouled resin bed due to iron accumulation.	Clean control valve and mineral bed with cleaner.
Slots in riser pipe or laterals are filled with resin fines.	Inspect and clean distributor pipe slots as needed.

**Symptom: Salt in Water to Service After Regeneration**

<b>Possible Cause</b>	<b>Solution</b>
Injector is too small for system size.	Install correct injector
Brine draw time excessively long due to low water pressure.	Increase water pressure above 25 psig (172 kPa) minimum.
Restricted drain line.	Remove drain line restriction.
Insufficient rinse volume.	Increase slow rinse time, fast rinse time, or both.
Damaged valve disk.	Replace all valve disks.
Plugged injector and/or injector screen.	Inspect and clean injector and/or injector screen.

**Symptom: Soft Water but No Filtration or pH Control**

<b>Possible Cause</b>	<b>Solution</b>
FES unit Birm, TS unit Carbon are exhausted and need replacement	Check P.2 for Media Loading., Use dome hole to replace media.
NS unit NS Mix is depleted	Add NS Mix through dome hole.

# TROUBLESHOOTING

## 700 Series Controller Troubleshooting

Problem	Possible Cause	Solution
ERR 1 is displayed	Controller power has been connected and the control is not sure of the state of the operation.	Press the UP arrow and the control should reset.
ERR 2 is displayed	Controller power does not match 50 or 60 Hz.	Disconnect and reconnect the power. If problem persists, obtain the appropriate controller or AC adapter for either 50 or 60 Hz power.
ERR 3 is displayed	Controller does not know the position of the camshaft. Camshaft should be rotating to find Home position.	Wait for two minutes for the controller to return to Home position. The hourglass should be flashing on the display indicating the motor is running.
	Camshaft is not turning during ERR 3 display.	Check that motor is connected. Verify that motor wire harness is connected to motor and controller module. Verify that optical sensor is connected and in place. Verify that motor gear has engaged cam gear. If everything is connected, try replacing in this order: <ul style="list-style-type: none"> <li>–Wire harness</li> <li>–Motor</li> <li>–Optical sensor</li> <li>–Controller</li> </ul>
	If camshaft is turning for more than five minutes to find Home position:	Verify that optical sensor is in place and connected to wire. Verify that camshaft is connected appropriately. Verify that no dirt or rubbish is clogging any of the cam slots. If motor continues to rotate indefinitely, replace the following components in this order: <ul style="list-style-type: none"> <li>–Wire harness</li> <li>–Motor</li> <li>–Optical sensor</li> <li>–Controller</li> </ul>
Four dashes displayed: -- : --	Power failure occurred	Press SET to reset the time display.



## 255 VALVE EXPLODED VIEW

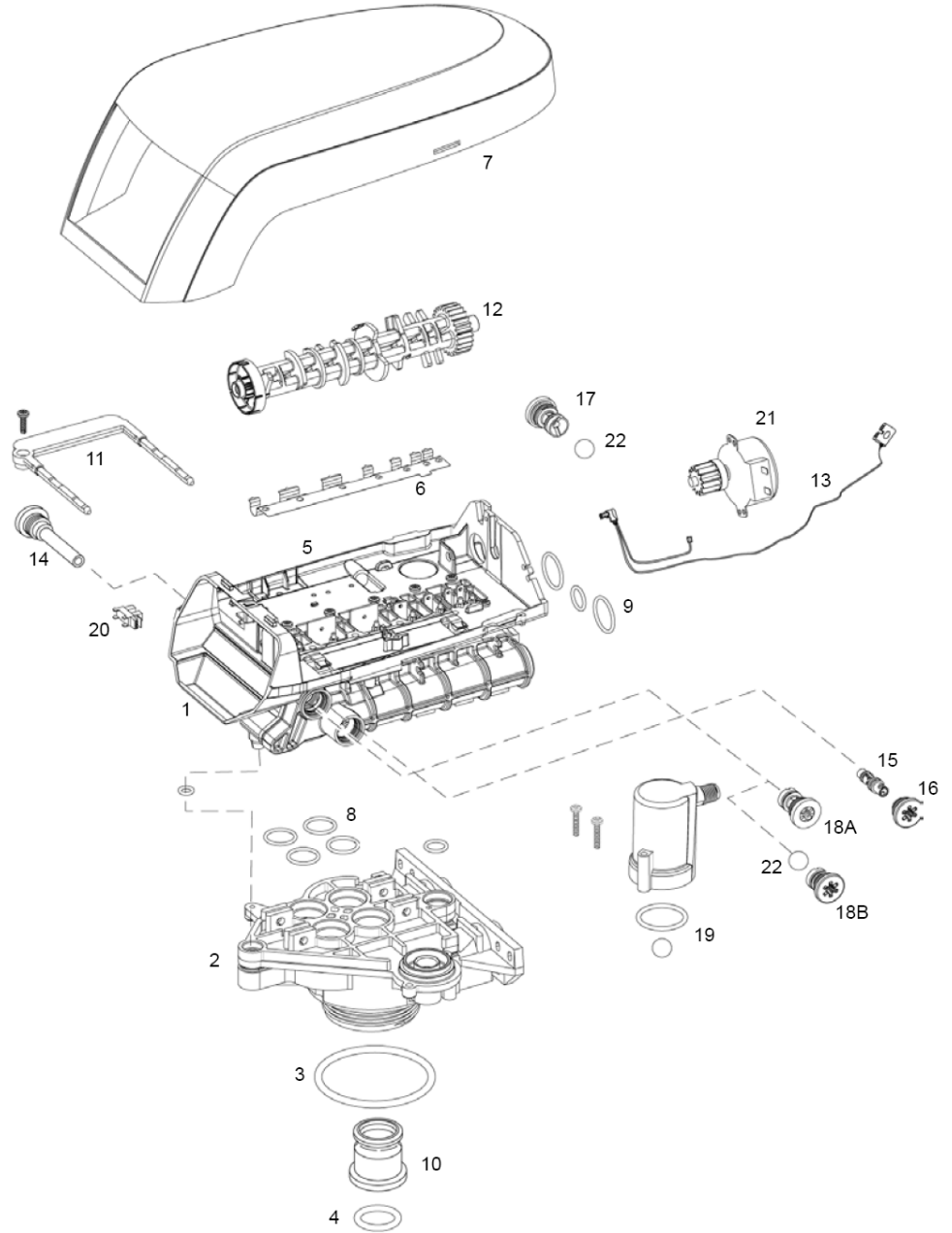

\*Warning: Do not use flow control ball with #18A.

## 255 VALVE PARTS LIST

Part				Part			
Code	No.	Description	Qty.	Code	No.	Description	Qty.
1	1000232	255 Valve Assembly, w/o Flow Controls	1	14	1000226	Screen/Cap Assembly w/ O-Ring	1
2	1033784	255 Tank Adapter New Style	1	15		Injector (High Efficiency) Options	1
3	1010429	O-Ring BN	1	1030408		"E" Injector (High Efficiency) - Yellow	
4	1010428	O-Ring EP		1030409		"F" Injector (High Efficiency) - Peach	
5	1235340	Top Plate, 255 Valve, 700/860 Series Controller	1	1030410		"G" Injector (High Efficiency) - Tan	
6	1235341	Spring, One Piece, 255 Valve	1	1030411		"H" Injector (High Efficiency) - Lt Purple	
7	1236246*	Cover, Valve, 255/Performa, 700/860 Series Controller	1	1030412		"J" Injector (High Efficiency) - Lt Blue	
8	1001404	O-Ring Group: Tank Adapter	1	1030413		"K" Injector (High Efficiency) - Pink	
9	1040459	O-Ring Group: Piping Boss	1	1035736		"L" Injector (High Efficiency) - Orange	
10	1001986	13/16 inch Rubber Insert (Optional)	1	1035737		"M" Injector (High Efficiency) - Brown	
*	1000250	Valve Disk Kit - Standard	1	1035738		"N" Injector (High Efficiency) - Green	
*	1041196	Blending Valve Kit 900/700 Series Top Plate	1	1035739		"Q" Injector (High Efficiency) - Purple	
11		Locking Bar	1	1035884		"R" Injector (High Efficiency) - Dark Gray	
	1031402	English Language Locking Bar		16	1000269	Injector Cap with O-Ring	1
	1031403	French Language Locking Bar		17		Drain Control Assembly with O-Ring	1
	1031404	German Language Locking Bar		1000209		No. 7 (1.2 gpm; 4.5 Lpm)	
	1031405	Italian Language Locking/Bar		1000210		No. 8 (1.6 gpm; 6.1 Lpm)	
	1031406	Japanese Language Locking Bar		1000211		No. 9 (2.0 gpm; 7.6 Lpm)	
	1031407	Spanish Language Locking Bar		1000212		No. 10 (2.5 gpm; 9.5 Lpm)	
	1006093	Locking Bar Screw - No. 8-9/16 inch		1002130		No. 12 (3.5 gpm; 13.2 Lpm)	
12		Camshaft Options	1	1000214		No. 13 (4.1 gpm; 15.5 Lpm)	
	1235353	Cam 255/700-860 Series Valve, STD, Black		1000215		No. 14 (4.8 gpm; 18.2 Lpm)	
	1236251	Cam 255/700-860 Series Valve, TWIN, Tan (insert)		18A	1000222	Regenerant Refill Controller, No Ball	1
13	1235269	Motor/Optical Cable Assembly, 700 Series Controller	1	18B	1243510	Regenerant Refill Controller	
				19		Air Check Kit	1
				1032416		Air Check Kit 3/8-inch male	
				1032417		Air Check Kit 1/4-inch male	
				20	1235373	Module, Sensor, Photo Interrupter	1
				21	1235361	Motor w/Spacer & Pinion, 700 Series Controller, 12 V, 50/60 Hz	1
				22	1030502	Ball, Flow Control	1
				*	1033066	New to Old Style Aircheck Adapter	1

\*Not Shown

## Logix 700 Series Controllers Parts List

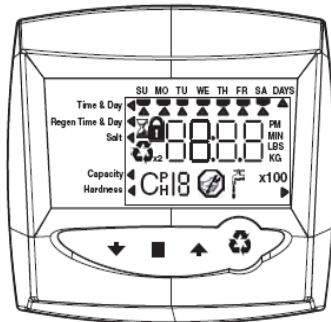

742/762 Control

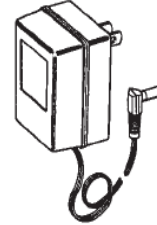

AC Adapter

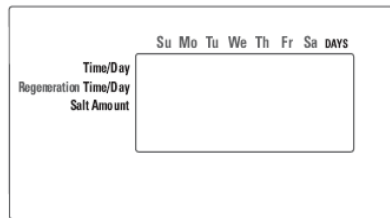

700 Control Overlays

Part				Part			
Code	No.	Description	Qty.	Code	No.	Description	Qty.
		Electronics Modules/Controllers	1			AC Adapter	
1242150		Logix 742 Controller		1000810		Japanese	
1242162		Logix 742 F Controller		1000811		North American	
1242168		Logix 762 Controller		1000812		Australian	
1242170		Logix 762F Controller		1000813		British	
		Electrical Components		1000814		European	
1235269		Motor/Optical Cable Assembly, 700 Series Control		1030234		Transformer Extension Cord 15 foot (4.5m)	
1235373		Module, Sensor, Photo Interrupter		1235448		North American Outdoor AC Adapter Overlays	
1235361		Motor w/Spacer & Pinion, 700 Series Controller 12V, 50/60 Hz		1238472		Overlay, 716 Controller, English	
1244336		Refill Sensor Probe for Salt Detector Applications		1238476		Overlay, 740C/742C Controller, English	
1256257		Remote Mount Kit					

# 12 YEAR LIMITED WARRANTY

As of Oct. 1, 1995

This Residential Water Conditioner is warranted for a period of **one year** from date of purchase by first user against defects in materials and workmanship. In addition, the complete control valve is warranted for **five years**. The control valve body (excluding internals and electrical parts) is warranted for **six years**. The mineral tank, plastic brine tank or cabinet tank (excluding mineral) is warranted against rust, corrosion or bursting for a period of **twelve years** from date of manufacture. Except, as specifically set forth in this paragraph, Master Water Conditioning Corporation makes no other warranties, express or implied.

This warranty shall be void if the conditioner is moved from the place of original installation, or if damage is caused by misuse, misapplication, accident, freezing, flood, fire or if not installed in accordance with instructions furnished by Master Water Conditioning Corporation.

This warranty shall be void in the event of damages from external sources or where the conditioner has been operated at pressure in excess of 100 pounds per square inch or at a temperature greater than 100 degrees F. or less than 32 degrees F. Incidental costs or consequential damages are not covered by this warranty.

All defective parts shall be returned prepaid to Master Water Conditioning Corporation for inspection. **Master shall not be liable for labor charges other than Master factory repairs.**

This warranty gives you specific legal rights, and you may have other rights which vary from state to state. Some states do not allow limitations on duration of implied warranties or exclusion of incidental or consequential damages, so the above limitations may not apply to you.

All claims must be submitted in writing to Master Water Conditioning Corporation at 224 Shoemaker Road, Pottstown, Pennsylvania 19464 within thirty (30) days from the discovery of the defect. Master Water Conditioning Corporation thereafter will correct defective parts and workmanship or rusting, corrosion or bursting within sixty (60) days.

Failure to notify Master by completing, signing and returning the registration card within twenty (20) days of the purchase shall void the warranty.



224 Shoemaker Rd. Pottstown, Pa. 19464