

CLICK ANYWHERE on THIS PAGE to RETURN to LOCHINVAR WATER HEATER INFORMATION at InspectApedia.com

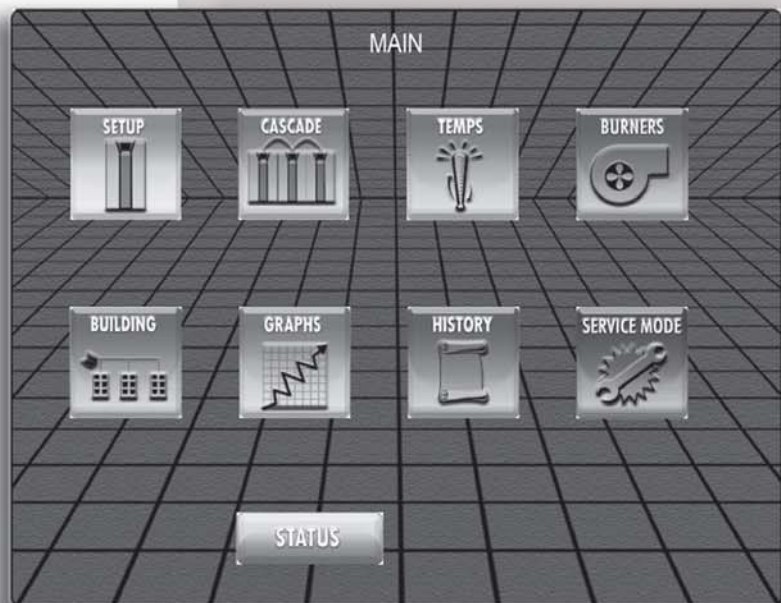

Service Manual

Models: 1.0, 1.3, and 1.5



WARNING

This manual must only be used by a qualified heating installer / service technician. Read all instructions, including this manual and the Armor X2 Installation and Operation Manual, before installing. Perform steps in the order given. Failure to comply could result in severe personal injury, death, or substantial property damage.

Save this manual for future reference.

Contents

CONTENTS.....	2	Parameter Table.....	10-11
Hazard Definitions.....	2	Viewable and Changeable Control Parameters.....	12-31
PLEASE READ BEFORE PROCEEDING	2	2. MAINTENANCE	
Handling Ceramic Fiber Materials.....	3	Maintenance and Annual Startup.....	32-36
When servicing water heater.....	3	3. TROUBLESHOOTING	
Water heater operation.....	3	Alarm Screen.....	37
Heater water	3	Before Troubleshooting.....	38
Freeze protection fluids	3	Check Control Module Fuses	38
WHAT IS IN THIS MANUAL	4	Table 3A - Troubleshooting Chart - No Display	39
1. SERVICE		Checking Temperature Sensors	40
The Armor X2 Water Heater Display	5	Table 3D - Troubleshooting Chart - Noisy System.....	41
Control Inputs	6	Table 3E - Troubleshooting Chart - Fault Messages.....	42-48
Control Outputs.....	7	Combustion Analysis Procedure	49
General Operation	8	Table 3F -Troubleshooting Chart -Combustion Levels.....	49
Sequence of Operation	9	Table 3G - Flue Products	49
		Gas Valve Adjustment Procedure.....	50
		Revision Notes	Back Cover

Hazard definitions

The following defined terms are used throughout this manual to bring attention to the presence of hazards of various risk levels or to important information concerning the life of the product.

DANGER

DANGER indicates an imminently hazardous situation which, if not avoided, will result in death or serious injury.

WARNING

WARNING indicates a potentially hazardous situation which, if not avoided, could result in death or serious injury.

CAUTION

CAUTION indicates a potentially hazardous situation which, if not avoided, may result in minor or moderate injury.

CAUTION

CAUTION used without the safety alert symbol indicates a potentially hazardous situation which, if not avoided, may result in property damage.

NOTICE

NOTICE indicates special instructions on installation, operation, or maintenance that are important but not related to personal injury or property damage.

Please read before proceeding

WARNING

Installer – Read all instructions, including this manual and the Armor X2 Installation and Operation Manual, before installing. Perform steps in the order given.

User – This manual is for use only by a qualified heating installer/service technician.

Have this water heater serviced/inspected by a qualified service technician at least annually.

Failure to comply with the above could result in severe personal injury, death or substantial property damage.

NOTICE

When calling or writing about the water heater – Please have the water heater model and serial number from the water heater rating plate.

Consider piping and installation when determining water heater location (see the Armor X2 Installation and Operation Manual).

Any claims for damage or shortage in shipment must be filed immediately against the transportation company by the consignee.

Please read before proceeding

⚠ WARNING **Installer** – Read all instructions, including this manual and the Armor X2 Water Heater Installation and Operation Manual, before installing. Perform steps in the order given.

Have this water heater serviced/inspected by a qualified service technician at least annually.

Failure to comply with the above could result in severe personal injury, death or substantial property damage.

NOTICE When calling or writing about the water heater – Please have the water heater model and serial number from the water heater rating plate.

Consider piping and installation when determining water heater location (see the Armor X2 Water Heater Installation and Operation Manual).

Any claims for damage or shortage in shipment must be filed immediately against the transportation company by the consignee.

Handling ceramic fiber materials

REMOVAL OF COMBUSTION CHAMBER LINING

⚠ WARNING The combustion chamber insulation in this appliance contains ceramic fiber material. Ceramic fibers can be converted to cristobalite in very high temperature applications. The International Agency for Research on Cancer (IARC) has concluded, “Crystalline silica in the form of quartz or cristobalite from occupational sources is carcinogenic to humans (Group 1)”. Normal operating temperatures in this appliance are below the level to convert ceramic fibers to cristobalite. Abnormal operating conditions would have to be created to convert the ceramic fibers in this appliance to cristobalite.

The ceramic fiber material used in this appliance is an irritant; when handling or replacing the ceramic materials it is advisable that the installer follow these safety guidelines.

- Avoid breathing dust and contact with skin and eyes.
 - Use NIOSH certified dust respirator (N95). This type of respirator is based on the OSHA requirements for cristobalite at the time this document was written. Other types of respirators may be needed depending on the job site conditions. Current NIOSH recommendations can be found on the NIOSH website at <http://www.cdc.gov/niosh/homepage.html>. NIOSH approved respirators, manufacturers, and phone numbers are also listed on this website.
 - Wear long-sleeved, loose fitting clothing, gloves, and eye protection.
- Apply enough water to the combustion chamber lining to prevent airborne dust.
- Remove the combustion chamber lining from the water heater and place it in a plastic bag for disposal.
- Wash potentially contaminated clothes separately from other clothing. Rinse clothes washer thoroughly.

NIOSH stated First Aid.

- Eye: Irrigate immediately.
- Breathing: Fresh air.

When servicing water heater –

- To avoid electric shock, disconnect electrical supply before performing maintenance.
- To avoid severe burns, allow the water heater to cool before performing maintenance.

Water heater operation –

- Do not block flow of combustion or ventilation air to the water heater.
- Should overheating occur or gas supply fail to shut off, do not turn off or disconnect electrical supply to circulator. Instead, shut off the gas supply at a location external to the appliance.
- Do not use this water heater if any part has been under water. The possible damage to a flooded appliance can be extensive and present numerous safety hazards. Any appliance that has been under water must be replaced.

What is in this manual?

Service

The Armor X2 water heater display

- Display panel readout, buttons and their functions

Control module inputs

- Control module inputs and options

Control module outputs

- Control module outputs and options

General

- How the water heater operates
- How the control module operates
- Access modes -- user and installer
- Sequence of operation -- Water Heating

Control panel menu access

- Accessing programming mode and locating menus
(See separate guide covering the PC interface.)

Control panel parameter access

- Accessing and changing parameters from the display panel

Quick start information -- parameter table

- An index of available adjustments and readouts, where to access them and where to find detailed information.

Armor X2 water heater operation

- Setup
- Service / Setup
- Setpoint
- Night Setback
- Cascade
- Pumps
- BMS

Maintenance

- Service and maintenance schedules
- Address reported problems
- Inspect water heater area and water heater interior
- Clean condensate trap
- Check all piping for leaks
- Check air openings
- Flue vent system and air piping
- Check water system
- Check water heater relief valve
- Inspect ignition electrode
- Check ignition ground wiring
- Check all water heater wiring
- Check control settings
- Perform start-up and checks
- Check burner flame
- Check flame signal
- Check flue gas temperature
- General maintenance
- Review with owner
- Cleaning the water heater heat exchanger
- Oiled bearing circulators

Troubleshooting

- Troubleshooting table - No display
- Checking temperature sensors
- Sensor tables
- Troubleshooting table - Fault messages displayed on the water heater interface
- Combustion analysis procedure
- Gas valve adjustment procedure

1 Service

The Armor X2 display

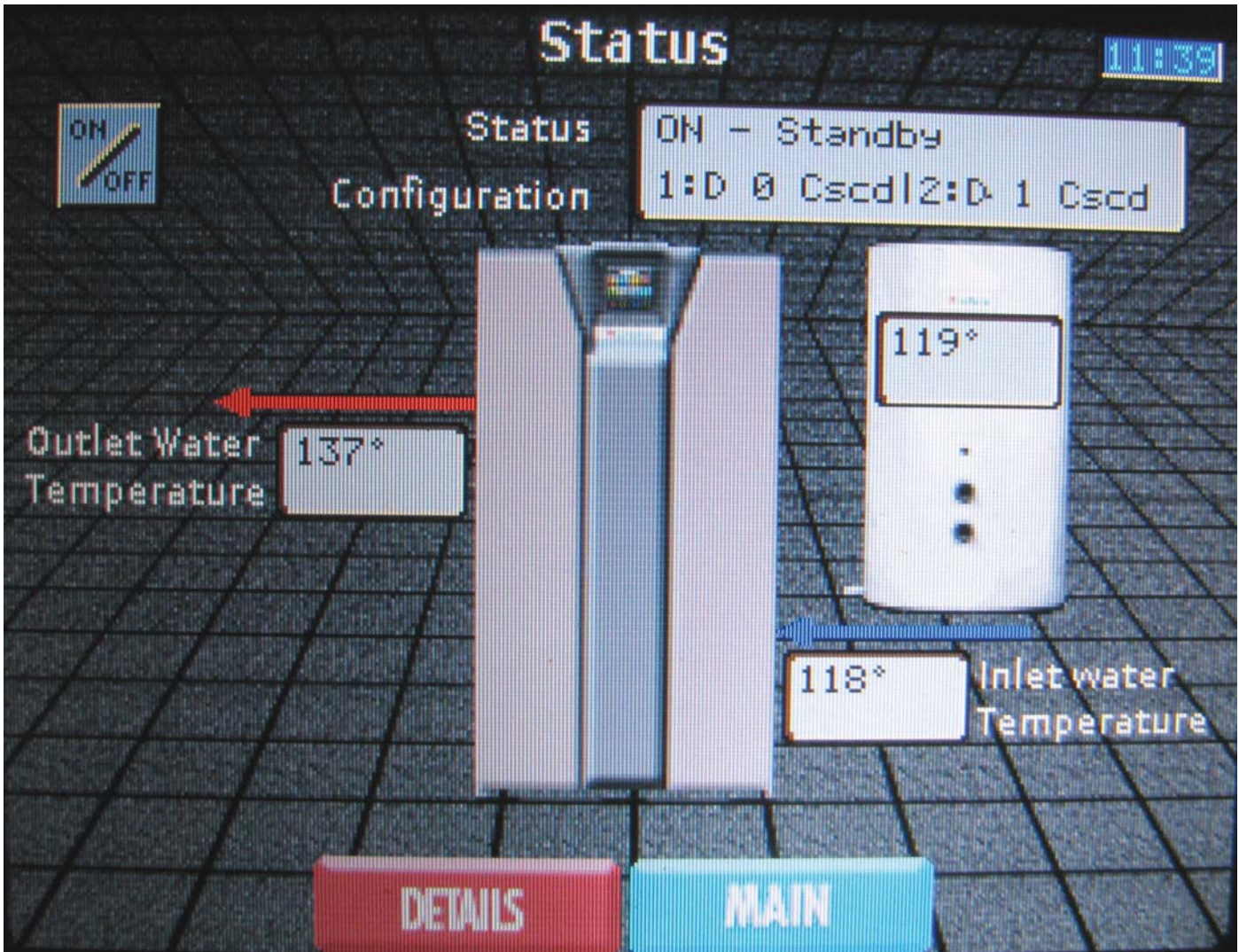

1 Service

Control inputs

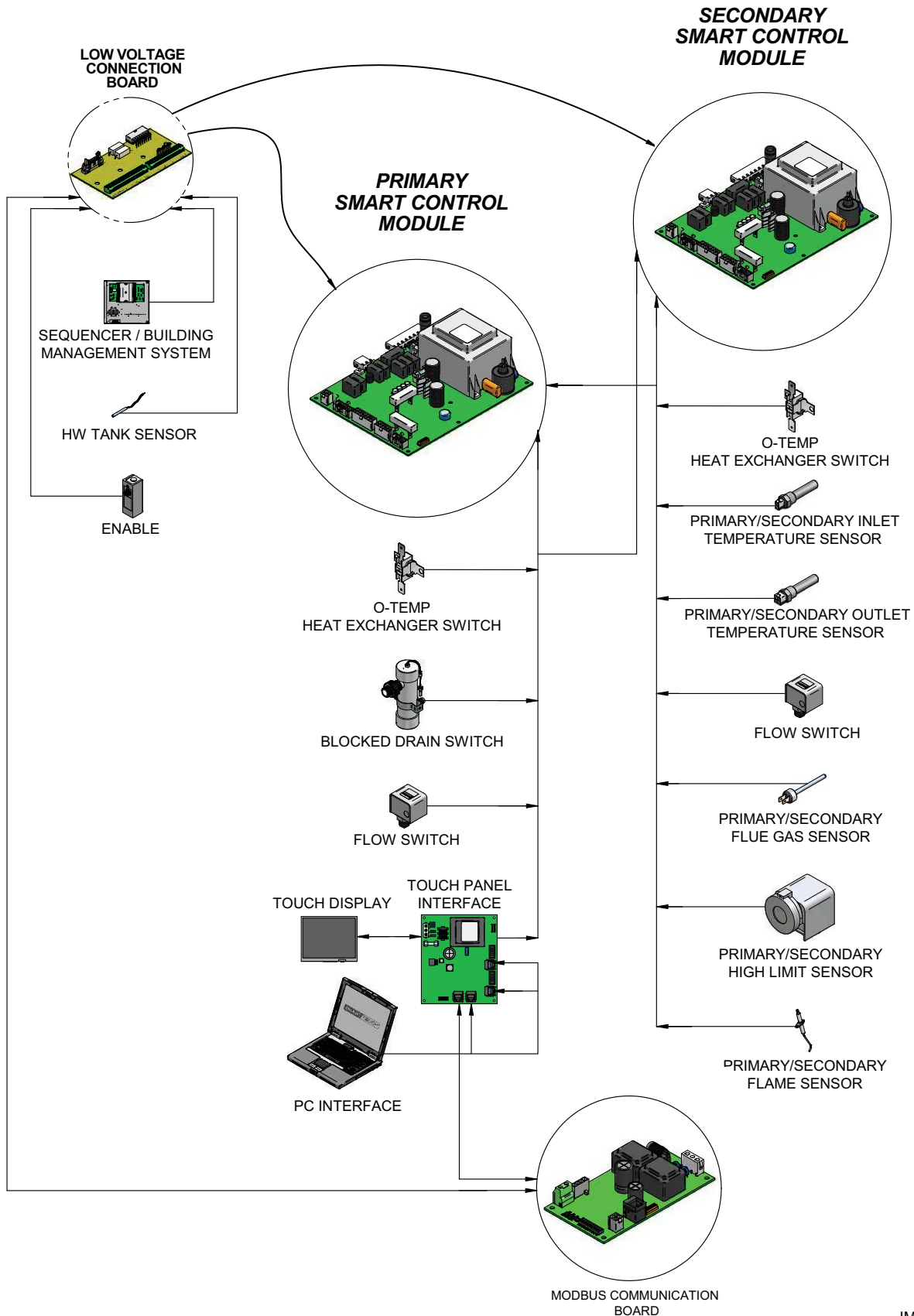

1 Service *(continued)*

Control outputs

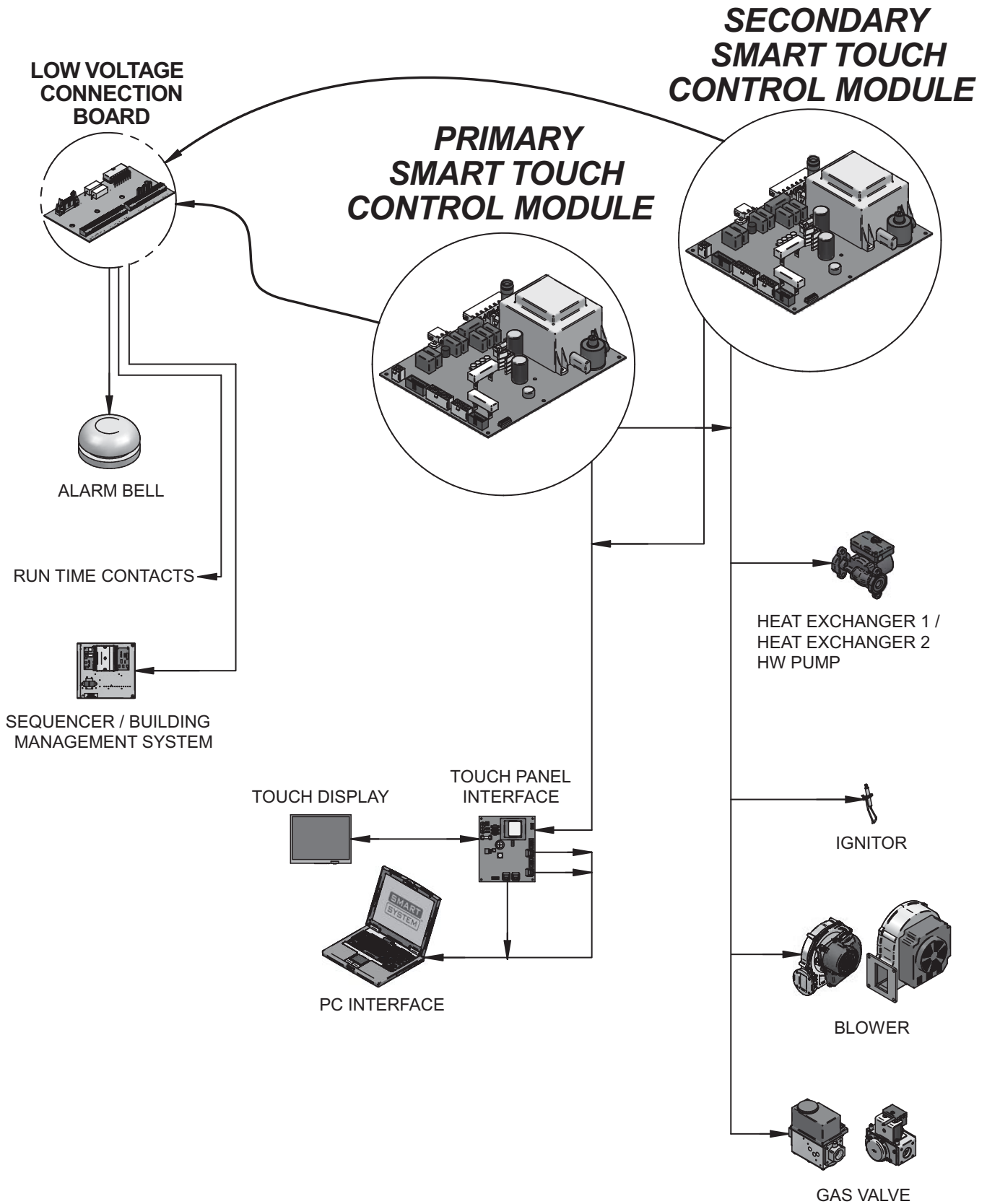

1 Service

General Operation

How the water heater operates

The Armor X2 uses two (2) advanced stainless steel heat exchangers and two (2) electronic control modules that allow fully condensing operation. The blowers pull in gas and air and push flue products out of the water heater through the heat exchangers and flue piping. The control modules regulate blower speeds to control total water heater firing rate. The gas valves sense the amount of air flowing into the water heater and allow only the right amount of gas to flow.

Sequence of operation

Table 1A shows control module normal sequences of operation for each individual control module. Additionally, the control modules are programmed to synchronize their combined modulation rates in order to maximize total water heater efficiency.

Access modes

User

The user can view all of the settings on the LCD screen. By entering the user password (0704), the user can adjust the User Set Point, Outdoor Shutdown, Night Setback, Boost, HW Water Heater Output Set Point, Backlight Time, and Backlight Brightness settings.

Installer

Most parameters are available only to the installer, accessible only by entering the installer access code (5309).

1 Service *(continued)*

Sequence of operation

Table 1A Sequence of operation

Note: This unit is equipped with two (2) independent, but synchronized combustion systems. One of the heat exchanger combustion systems will fire first. If the demand cannot be met by one (1) combustion system the same sequence of operation will be followed to bring the second heat exchanger combustion system online.

1.	Upon a call for heat, the control turns on the appropriate pumps.
2.	The control confirms that the flow switch contacts are closed.
3.	The control starts the blower and closes the louver contacts to begin the Pre-Purge cycle.
4.	The control confirms that the blower comes up to the desired speed, the flap valve opens, and the air pressure switch, gas pressure switch (optional), louver proving switch (optional), and blocked drain switch contacts close.
5.	Once the Pre-Purge cycle is complete, the control lowers the blower speed, initiates sparking of the ignition electrode, and opens the gas valve.
6.	After a short wait, the control stops sparking and checks for the presence of flame current through the spark and flame sense electrodes.
7.	If the control does not detect flame current, the control will try again. If no flame current is detected on the second try, the control will lockout indefinitely until the RESET button on the touch screen LCD is pressed.
8.	If the control detects flame current, the control will hold the blower speed constant for a few seconds to allow the flame to stabilize, then begin modulating the firing rate in order to maintain the controlling sensor to the desired set point temperature.
9.	If the first heat exchanger in the water heater is unable to maintain the desired set point temperature, the second heat exchanger in the water heater will be started, using much of the same sequences as described above. Once both heat exchangers are firing, the controls will work in synchronization to maintain the desired set point temperature. If the heat load should decrease sufficiently, the second heat exchanger will be shut down, much like the sequences described below.
10.	Once a call for heat is satisfied, the control will turn off the gas valve and begin the Post-Purge cycle. The pumps that are running will begin their respective Pump Delay cycles.
11.	At the end of the Post-Purge cycle, the louver contacts will open.
12.	The control verifies that the blower stops running and the flap valve closes.
13.	At the end of the Pump Delay cycle(s), the pump(s) will be turned off.

1 Service

Parameter table

Table 1B This table lists the parameters and where to access them

	MENU	DESCRIPTION	SEE PAGE	USER ACCESS		INSTALLER ACCESS	
				DISPLAY	MODIFY	DISPLAY	MODIFY
SETUP		Service/Setup	17	Yes	Yes	Yes	Yes
		Night Setback	17	Yes	Yes	Yes	Yes
		Set points	17	Yes	Yes	Yes	Yes
		Cascade	17	Yes	Yes	Yes	Yes
		BMS	17	Yes	Yes	Yes	Yes
SERVICE / SETUP PARAMETERS		Demand Conf	18	Yes	No	Yes	No
		Serv Not Time	18	No	No	Yes	Yes
		Serv Not Run H	18	No	No	Yes	Yes
		Serv Not Cycl	18	No	No	Yes	Yes
		Max Serv T	19	Yes	No	Yes	No
		Temp Unit	19	No	No	Yes	Yes
		User Passwd	19	No	No	Yes	Yes
		LCD Backlight	19	No	No	Yes	Yes
		LCD Bright	19	No	No	Yes	Yes
		HW Pump D	19	No	No	Yes	Yes
SET POINT PARAMETERS		Tank setp	20	No	No	Yes	Yes
		Tank on df	20	No	No	Yes	Yes
		Tank off df	20	Yes	Yes	Yes	Yes
		NSB setp	20	No	No	Yes	Yes
		Drop in Inlet	20	No	No	Yes	Yes
		Anti-C t	20	No	No	Yes	Yes
		Tank Off Diff	20	Yes	Yes	Yes	Yes

1 Service *(continued)*

Table 1B *(continued from previous page)* This table lists the parameters and where to access them

NIGHT SETBACK		Date and time	21	Yes	Yes	Yes	Yes
		On Timer and Off Timer	21	No	No	Yes	Yes
CASCADE		Casc Address	22	Yes	Yes	Yes	Yes
		Casc off df	22	No	No	Yes	Yes
		Casc off/on df	22	No	No	Yes	Yes
		Max Outl temp	22	No	No	Yes	Yes
BMS		BMS Type	23	No	No	Yes	Yes
		ModBus Timeout	23	No	No	Yes	Yes
		BMS Setp min V	23	No	No	Yes	Yes
		BMS Setp max V	23	No	No	Yes	Yes
		BMS V min Setp	23	No	No	Yes	Yes
		BMS V max Setp	23	No	No	Yes	Yes
		BMS V Heat	23	No	No	Yes	Yes
		Dropin BMS End	23	No	No	Yes	Yes
		BMS mod@minV	24	No	No	Yes	Yes
		BMS mod@maxV	24	No	No	Yes	Yes
		BMS V @min mod	24	No	No	Yes	Yes
		BMS V @max mod	24	No	No	Yes	Yes

1 Service

Viewable and changeable control parameters

Status Screen:

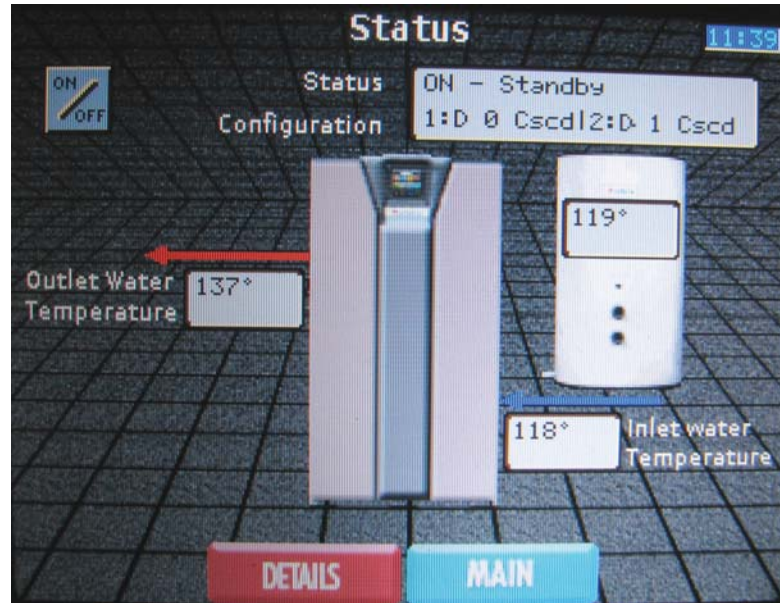

When the ON/OFF switch is turned to the ON position, the first screen visible on the LCD display will be the Status Screen. This screen displays the current status of the Armor X2 water heater. The following items can be viewed or interacted with on the Status Screen:

On/Off button - Pressing this button allows the water heater to be placed in either Manual Shutdown Mode or Standby Mode.

Status - This line shows the current operating status of the Armor X2 water heater. Displayed items are as follows:

- Manual Shutdown - The water heater will not respond to a hot water call.
- Standby - The water heater has not received a hot water call.
- HW Storage - The water heater has received a hot water call.
- HW Pump Delay - The water heater has satisfied a hot water call and the hot water pumps are running for a fixed time to remove any residual heat.

- BMS - The water heater has received a call for heat from a 0-10 VDC BMS control.
- Service Set Point Met - While in Service Mode, the water temperature at either the outlet sensor or the system sensor has exceeded 185°F.
- Anti-Cycle Delay - The water heater has satisfied a call for heat, but has received another call for heat before the anti-cycling time parameter has elapsed.
- Cascade ComError - A communication error has occurred between the Control Module 1 and Control Module 2 or between the Leader and Member water heaters.

1 Service *(continued)*

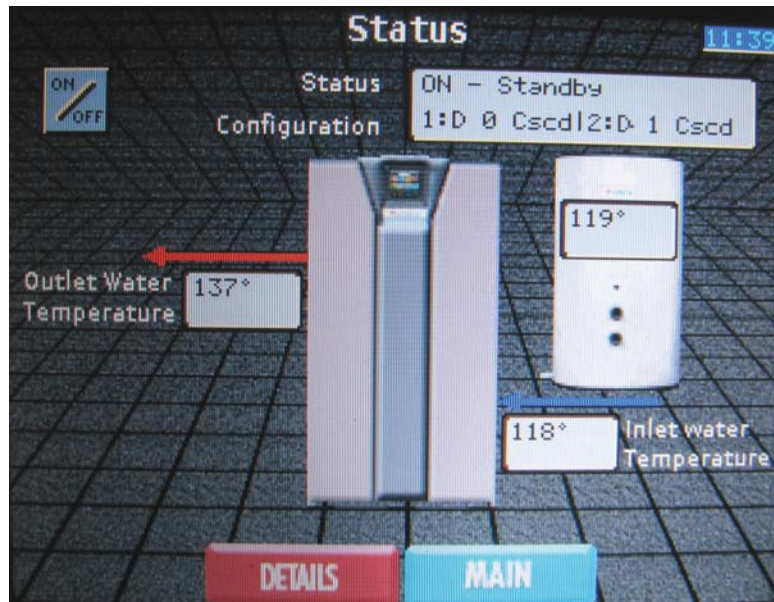

Configuration - This line shows the current configuration of the two control modules inside the unit.

Outlet Water Temperature - This is a calculated temperature based on the readings of the outlet temperatures of the two (2) heat exchangers.

Inlet Water Temperature - This is a calculated temperature based on the inlet temperature readings from the two (2) heat exchangers.

Hot Water Tank Temperature - This is the temperature as measured by the tank sensor in the hot water storage tank.

Time - The time is displayed in the upper right-hand corner of the display. It is displayed in a 24 hour format. Reference the Night Setback parameters on page 21 for information regarding adjusting the date and time.

Details button - Pressing this button brings up the Details Screen. This screen shows the status of the various safeties, inputs, and outputs to each control module. Reference the Details Screen section on page 14 for more information regarding this screen.

Main button - Pressing this button brings up the Main Screen. From this screen navigation to eight (8) other screens is possible. Reference the Main Screen section on page 16 of this manual for more information regarding this screen.

1 Service

Details Screen:

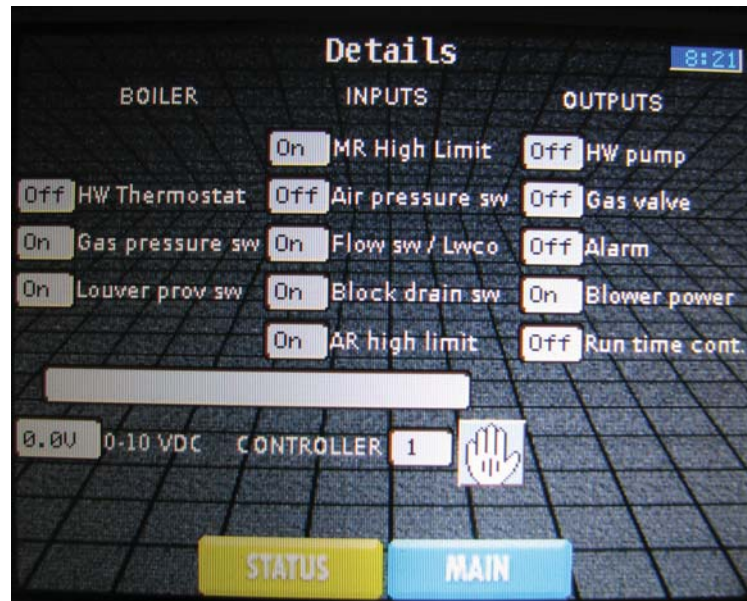

The Details Screen is accessed by pressing the DETAIL button on the Status Screen. This screen shows the status of the various safeties, inputs and outputs to each control module. Selection of the control module to be viewed is accomplished by pressing the SELECT button. The control module being displayed is shown in the module box.

Displayed items are as follows:

- HW Thermostat - Is ON when a Hot Water call has been received from a tank thermostat. Is OFF when a Hot Water call has not been received from a tank thermostat.
- Gas Pressure Switches - Is ON when the high and low gas pressure switches are closed. If OFF when either the high or low gas pressure switches are open.
- Louver Proving Switch - Is ON when a remote proving safety switch is closed. Is OFF when a remote proving safety switch is open.
- Manual Reset High Limit - Is ON when the manual reset high limit is closed. Is OFF when the manual reset high limit is open.
- Air Pressure Switch - Is ON when the combustion air blower is energized and the flap valve switch is closed. Is OFF when the flap valve switch is open.
- Flow Switch / Low Water Cutoff - Is ON when the low water cutoff contacts are closed or if an optional flow switch is used and it is closed as well. Is OFF when the low water cutoff contacts are open or if an optional flow switch is open.
- Blocked Drain Switch - Is ON when the blocked drain switch on the condensate trap is closed. Is OFF when the blocked drain switch on the condensate trap is open.
- Auto Reset High Limit - An auto reset high limit is not used in the standard configuration of the Armor X2 water heater. If OFF is shown then a wiring problem exists.
- HW Pump - Is ON when a Hot Water Generation call has been received from a tank thermostat or a tank sensor and the hot water generation pump is energized. Is OFF when the hot water generation pump is de-energized.
- Gas Valve - Is ON when the gas valve is energized. Is OFF when the gas valve is de-energized.
- Alarm - Is ON when a fault has been detected and the alarm contacts are closed. Is OFF when the alarm contacts are open.
- Blower Power - Is ON when the combustion air blower is energized. Is OFF when the combustion air blower is de-energized.
- Run Time Contacts - Is ON when the burner is energized. Is OFF when the burner is de-energized.
- 0-10Vdc - Shows the voltage signal being delivered from a remote Building Management System (BMS).

1 Service *(continued)*

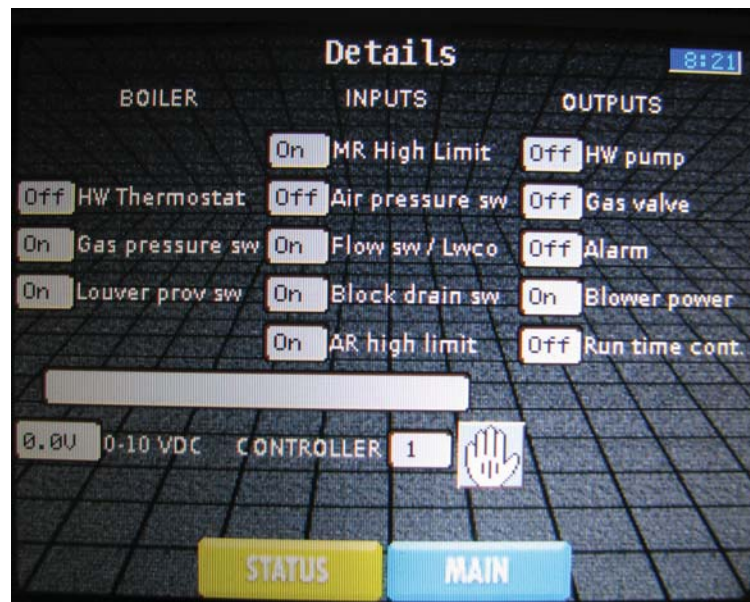

A blank message box is located on the Details Screen. This box will display various messages detailing the status of the control module. If a message is present in this box, the DETAILS button on the Status Screen will contain a yellow triangle with an exclamation mark (!) inside.

Displayed items are as follows:

- Delta T Shutdown - The temperature rise between the inlet and outlet temperatures has exceeded 35°F. Reference page 48 for more information regarding this shutdown.
- Outlet Temp Shutdown - The outlet temperature has exceeded 195°F. Reference page 48 for more information regarding this shutdown.
- Flue Temp Shutdown - The flue temperature has exceeded 240°F. Reference page 48 for more information regarding this shutdown.
- Voltage too Low - The 120 VAC input to the control has dropped below 80 VAC. Reference page 47 for more information regarding this fault message.
- Connect Tank Sensor - Tank sensor is not detected by Control Module 1. For proper operation of the Armor X2 water heater the tank sensor must be connected.
- Manual Shutdown - The water heater has been shutdown with the ON/OFF button on the Status Screen.

Time - The time is displayed in the upper right-hand corner of the display. It is displayed in a 24 hour format. Reference the night setback parameters on page 22 for information regarding adjusting the date and time.

Status button - Pressing this button displays the Status Screen. This screen shows the current status of the Armor X2 water heater. Reference pages 12 - 13 for more information regarding this screen.

Main button - Pressing this button displays the Main Screen. From this screen, navigation to eight (8) additional screens is possible. Refer to Main Screen on page 16 for more information regarding this screen.

1 Service

Main Screen:

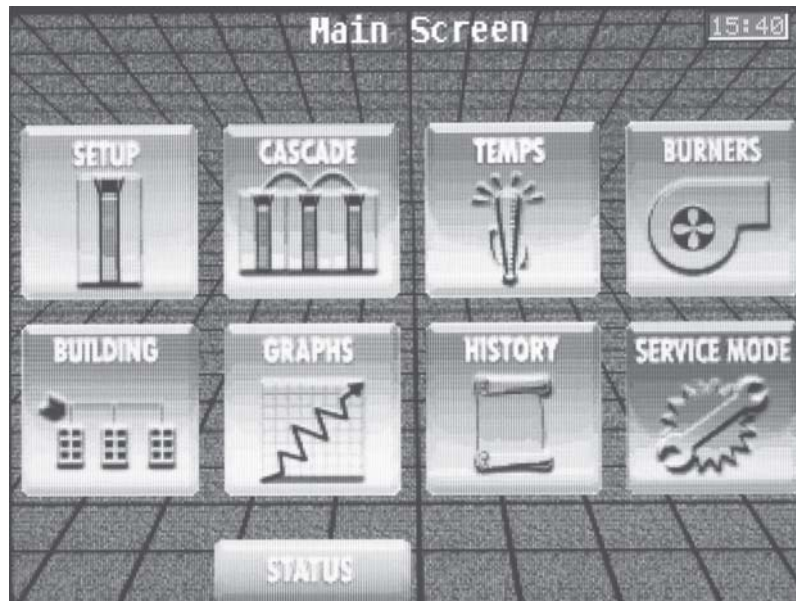

The Main Screen allows navigation to eight (8) additional screens which are used to set temperatures, operating conditions, and monitor water heater operation. These screens are as follows:

- Setup - Allows access to five (5) other screens for the adjustment of the control parameters.
- Cascade - Shows the status of multiple heaters connected together in a cascade arrangement.
- Temps - Shows the temperatures measured by the individual sensors connected to the heater.
- Burners - Shows the status of the two (2) independent burner systems used in the heater.
- Building - Shows the information from a Building Integration System using Modbus Protocols.
- Graphs - Allows the selection of items to be graphed on a chart.
- History - Shows the operating and fault history of the two (2) control modules.
- Service Mode - Allows the installer to control the fan speed of the individual control modules for the purposes of combustion analysis. Service Mode will override all other heat demands, however, all safeties will continue to function.

Navigation to the Main Screen can be accomplished by pressing the MAIN button at the bottom of the page.

Reference pages 17 - 31 of this manual for more information regarding the eight (8) accessible screens.

Time - The time is displayed in the upper right-hand corner of the display. It is displayed in a 24 hour format. Reference the night setback parameters on page 21 for information regarding adjusting the date and time.

Status button - Pressing this button displays the Status Screen. This screen shows the current status of the Armor X2 water heater. Reference pages 12 - 13 for more information regarding this screen.

1 Service *(continued)*

CAUTION

Before changing parameters, note the settings so that the unit can be returned to its original operating parameters.

Setup Screen:

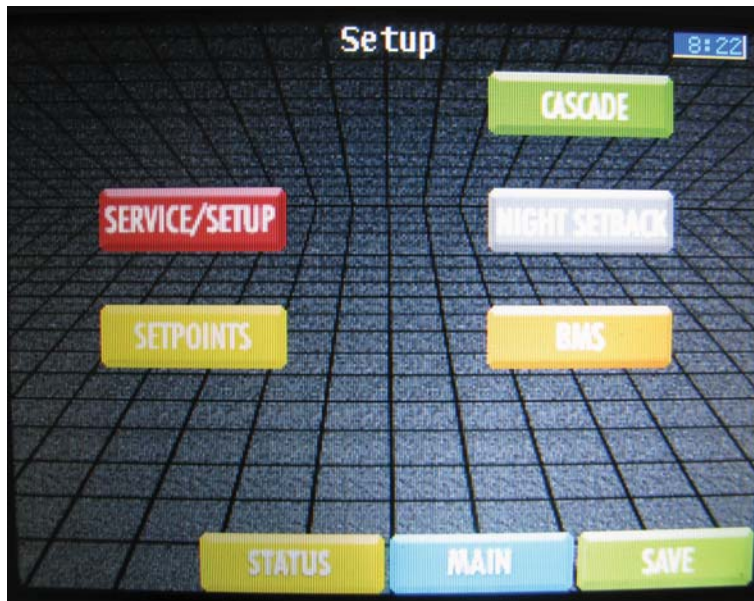

The Setup Screen allows access to five (5) other screens for adjusting control parameters.

These screens are as follows:

- Service / Setup - Allows access to change service notification parameters, LCD backlight parameters, and temperature units.
- Setpoints - Allows access to change the HW set point and ON/OFF differentials.
- Cascade - Allows access to change the cascade parameters.
- Night Setback - Allows access to change the date and time and ON/OFF times for night setback.
- BMS - Allows access to change the 0 - 10Vdc BMS parameters.

To change a parameter, press one of the five screen buttons. A list of parameters and their corresponding location are located on pages 10 and 11, Table 1B. Once a Screen button is pressed a list of adjustable parameters will appear.

Select the parameter to be adjusted by pressing the SELECT button next to the parameter. The first time the parameters are accessed, you will be required to enter the service password. The service password is 5309. Using the keypad, enter the password and then press the OK button. If the password is not entered correctly, the screen will revert to the Parameter List Screen and you will not be able to adjust the parameters. If a digit has been entered incorrectly, press the left arrow key on the keypad to back up one digit.

If the password has been entered correctly, the Parameter Change Screen will appear. The Parameter Change Screen will display the parameter being changed, the previous setting of the parameter, and adjustment buttons.

To adjust the parameter, press the + or - buttons to change the value being displayed. Once the parameter has been adjusted to the desired setting, press the APPLY button to change the parameter and return to the Parameter List Screen. If no change is necessary, press the BACK button to return to the Parameter List Screen. Once all the necessary adjustments have been made, press the BACK button to return to the Setup Screen. Repeat this procedure to adjust the parameters in other screens.

Press the SAVE button to program all changes made to the control parameters and return to the Status Screen. Leaving the Setup Screen without pressing the SAVE button will erase the changes made to the control parameters and revert them back to their previous settings.

Time - The time is displayed in the upper right-hand corner of the display. It is displayed in a 24 hour format. Reference the night setback parameters on page 21 for information regarding adjusting the date and time.

Main button - Pressing this button brings up the Main Screen. From this screen navigation to eight (8) other screens is possible. Reference the Main Screen section on page 16 of this manual for more information regarding this screen.

Save button - Pressing this button will save all changes made to the control parameters.

Status button - Pressing this button displays the Status Screen. This screen shows the current status of the Armor X2 water heater. Reference pages 12 - 13 for more information regarding this screen.

1 Service

Service/Setup Parameters Screen:

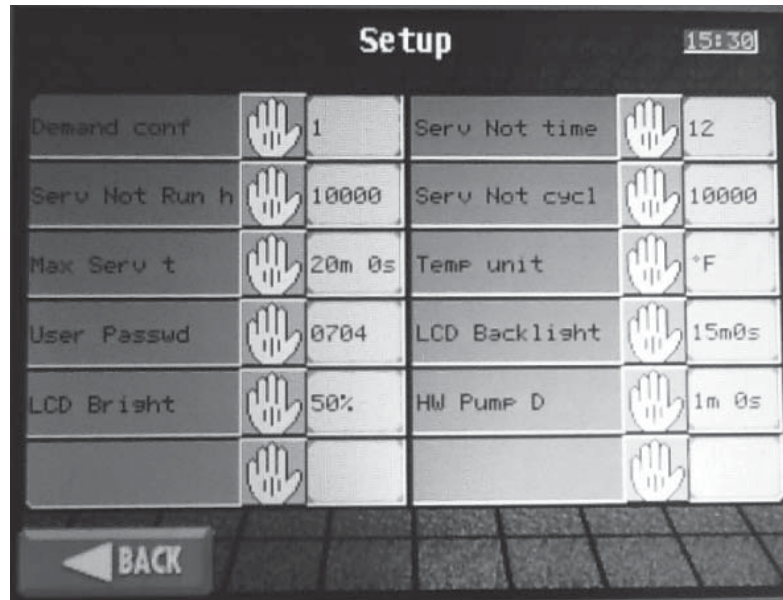

The Service / Setup Screen allows access to 10 parameters. Those parameters are as follows:

- Demand Configuration - Sets the configuration of the control modules inside the water heater. The configuration selections are:

Demand Configuration 1: Cascade Set Point Thermostat based - the control modulates the water heater based on the user set point and the temperature of the tank sensor.

Demand Configuration 2: Cascade BMS Thermostat based - a 0 - 10Vdc signal is provided to the water heater to control either the set point or the modulation of the water heater.

Demand Configuration 3: Cascade BMS Voltage based - a 0 - 10Vdc signal is provided to the water heater to control either set point or modulation. A minimum voltage signal is required to initiate a call for heat.

Demand Configuration 4: Cascade Set Point Modbus Thermostat based - the control modulates the water heater based on the tank set point and the temperature of the tank sensor. An enable signal is provided by writing to the holding registers on the Modbus communication board.

Demand Configuration 5: Cascade Modbus BMS Thermostat based - a 0 - 10V dc signal is provided to the water heater to control either the set point or the modulation of the water heater. An enable signal and an equivalent 0 - 10V signal is provided by writing to the holding registers on the Modbus communication board.

Demand Configuration 6: Cascade Modbus BMS Voltage based on a 0 - 10V dc signal is provided to the water heater to control either set point or modulation. An equivalent 0 - 10V dc signal is provided by writing to the holding registers on the Modbus communication board.

When any of these BMS configurations are selected, additional parameters for BMS operation will have to be adjusted. Reference the BMS parameters on pages 23 and 24 for information regarding adjusting these parameters. There are three (3) other configuration selections that are possible, however, they must NOT be used on the Armor X2 water heater.

This parameter can only be changed by the installer. The default configuration is Cascade Set Point Thermostat based.

- Service Notification Time - When the water heater determines that a scheduled service is due based on days of installation, the Service Needed screen will appear. This parameter can only be changed by the installer. The adjustment range for this parameter is 0 months to 36 months. The default time is 12 months.
- Service Notification Running Hours - When the water heater determines that a scheduled service is due based on the hours of actual operation. This parameter can only be changed by the installer. The adjustment range for this parameter is 0 hours to 100,000 hours. The default time is 10,000 hours.
- Service Notification Cycles - When the water heater determines that a scheduled service is due based on the number of water heater cycles, the Service Needed screen will appear. This parameter can only be changed by the installer. The range for this parameter is 0 cycles to 100,000 cycles. The default is 10,000 cycles.

1 Service *(continued)*

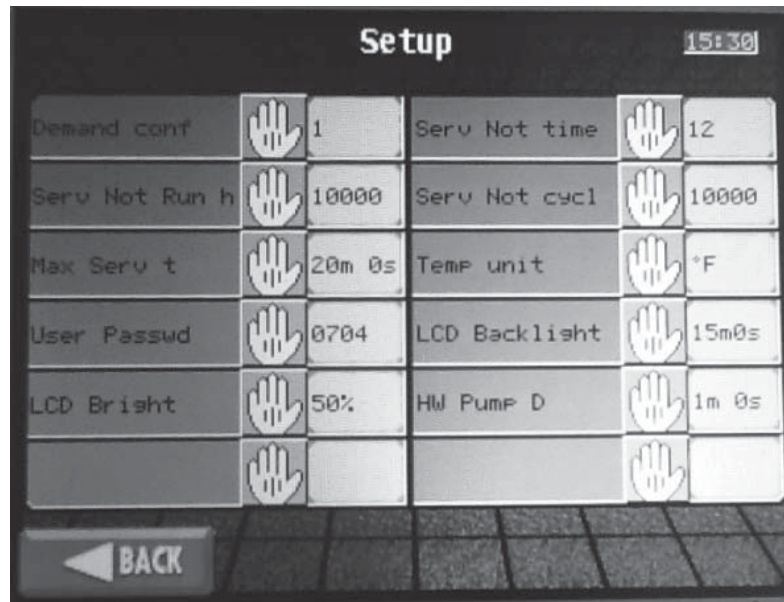

- **Maximum Service Time** - Service Mode allows the installer to control the fan speed of the individual control modules for the purposes of combustion analysis.

Service Mode will override all other heat demands, however, all safeties will remain intact. Maximum service time sets the length of time the water heater will stay in Service Mode if no buttons are pressed before reverting back to its original state. This parameter can only be changed by the installer. The time range of this parameter is 0 to 40 minutes. The default value is 20 minutes.

- **Temperature Units** - The control can be configured to display temperatures in either °C or °F. The default is °F.
- **User Password** - Allows the user to access and change a limited number of control parameters. The access code can be changed by the user or the installer to a code of their choosing. The default code is 0704.
- **LCD Backlight** - Sets the length of time the LCD Screen will stay on after a button has been pressed. This parameter can be changed by the user or the installer. The time range for this parameter is 30 seconds to ON. With a setting of ON, the LCD Screen will be on continuously. The default time is 15 minutes.
- **LCD Brightness** - Controls the brightness of the screen. This parameter can be changed by the user or the installer. The range for this parameter is 10% to 100%. The default percentage is 50%.
- **HW Pump D** - Controls the length of time the HW pump continues to run after the burner turns off.

Reference page 17 for information regarding changing parameters.

Time - The time is displayed in the upper right-hand corner of the display. It is displayed in a 24 hour format. Reference the night setback parameters on page 21 for information regarding adjusting the date and time.

Back button - Pressing this button will back the screen up to the previous screen.

1 Service

Set Point Parameters Screen:

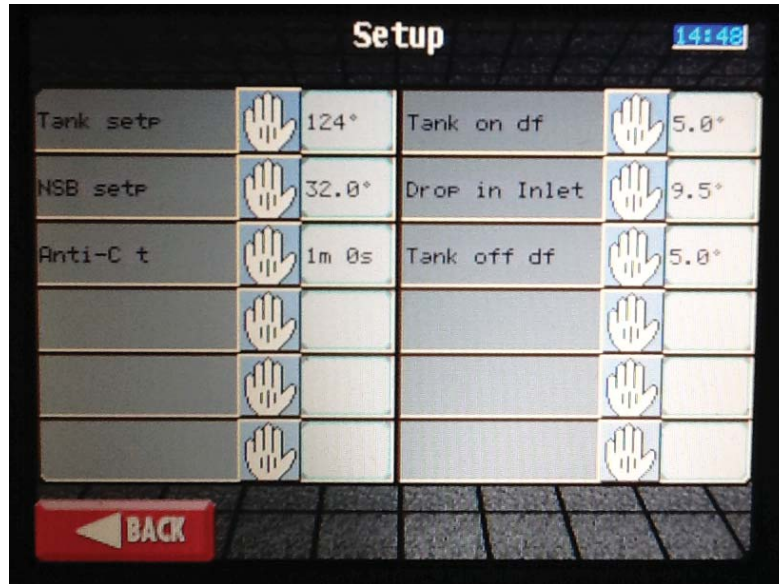

The Set Point Screen allows access to 6 parameters. Those parameters are as follows:

- Hot Water Tank Set Point - The hot water tank set point sets the target temperature of the water in the tank. This parameter can be changed by the user or the installer. The temperature range of this parameter is 60° to 185°F. The default value is 125°F.
- Hot Water Tank On Differential - Sets how many degrees below the Hot Water Tank Set Point the hot water tank temperature must drop before the water heater will turn on. This parameter can only be changed by the installer. The temperature range for this parameter is 0° to 100°F. The default value is 5°F.
- Night Setback Set Point - Once the internal clock has been set correctly, the night setback feature can be used to program a lower water temperature set point. This parameter can be changed by the user or the installer. The temperature range for this parameter is 32° to 140°F. This feature is turned off with a setting of 32°F. The default value is 32°F.
- Drop in Inlet Temperature for Ending Anti-cycling - The control will bypass the anti-cycling time if the inlet water temperature drops too quickly. The control will use the inlet water temperature at Heat Exchanger 1 when it shuts off as the starting point. If the temperature drops below the temperature parameter the control will abort anti-cycling and allow the water heater to fire. This parameter can only be changed by the installer. The temperature range of this parameter is 0° to 86°F. The default value is 10°F.
- Anti-cycling Time - Once a call for heat has been satisfied, a set amount of time must elapse before the control will respond to a new call for heat. The control will block the new call for heat and Anti-cycling will be shown in the water heater status display until the time has elapsed or the inlet water temperature drops below the parameter drop in inlet temperature for ending anti-cycling. This parameter can only be changed by the installer. The time range for this parameter is 0 minutes to 40 minutes. The default value is 1 minute.
- Hot Water Tank Off Differential - Sets how many degrees above the Hot Water Tank Set Point the hot water tank temperature must rise before the water heater will turn off. This parameter can only be changed by the installer. The temperature range for this parameter is 0° to 100°F. The default value is 5°F.

Reference page 17 for information regarding changing parameters.

Time - The time is displayed in the upper right-hand corner of the display. It is displayed in a 24 hour format. Reference the night setback parameters on page 21 for information regarding adjusting the date and time.

Back button - Pressing this button will back the screen up to the previous screen.

1 Service *(continued)*

Night Setback Parameters Screen:



The Night Setback Screen allows access to 15 parameters. Those parameters are as follows:

- Date and Time - The control uses an internal clock for the night setback feature and for logging of events. For these features to work correctly, the clock must be set when the heater is first installed or any time the heater has been powered off for more than 30 days.

To set the clock, press the SELECT button in the upper right-hand corner of the display. The date and time are displayed as “Day dd/mm/yy hh:mm”. Day = day of the week (1 = Monday, 2 = Tuesday, etc.), dd = date, mm = month, yy = year, hh = hour, mm = minutes (24 hours time; 2:30 PM = 14:30). Using the keypad, adjust the date and time by working from left to right. If a digit has been entered incorrectly, press the left arrow key on the keypad to back the digit up. If a change is not necessary, press the BACK button to return to the Parameter List Screen. Once the correct date and time have been entered press the OK button on the display to program the date and time into memory and return to the Parameter List Screen.

The internal clock does not adjust for Daylight Savings Time and therefore, will require a manual adjustment.

- On Timer and Off Timer - If the parameter night setback set point is set to anything other than 32°F, the night setback feature becomes active. This will require on and off times to be programmed for the days that reduced temperatures are required. Each day of the week (Monday through Sunday) will have an on and off time.

Example: Monday ON: 22:30, Tuesday OFF: 6:45. If you wish to skip a day and no night setback is necessary, program the on and off times the same and set them prior to 12:00 (noon). If you wish to keep night setback active throughout an entire day, program the on and off times the same and set them after 12:00 (noon). The default times for each day will be on at 18:00 and off at 8:00.

To adjust the on and off times, select the parameter to be adjusted by pressing the SELECT button next to the parameter. Using the keypad, adjust the time by working from left to right. If a digit has been entered incorrectly, press the left arrow key on the keypad to back the digit up. If no change is necessary, press the BACK button to return to the Parameter List Screen. Once the correct time has been entered press the OK button on the display to program the time into memory and return to the Parameter List Screen.

Reference page 21 for information regarding NSB Set Point Temp programming.

Apply button - If changes have been made to the date and time or to one of the on or off timers, the APPLY button must be pressed to program the changes into the control module and return to the Setup Screen.

Back button - Pressing this button will back the screen up to the previous screen.

1 Service

Cascade Parameters Screen:

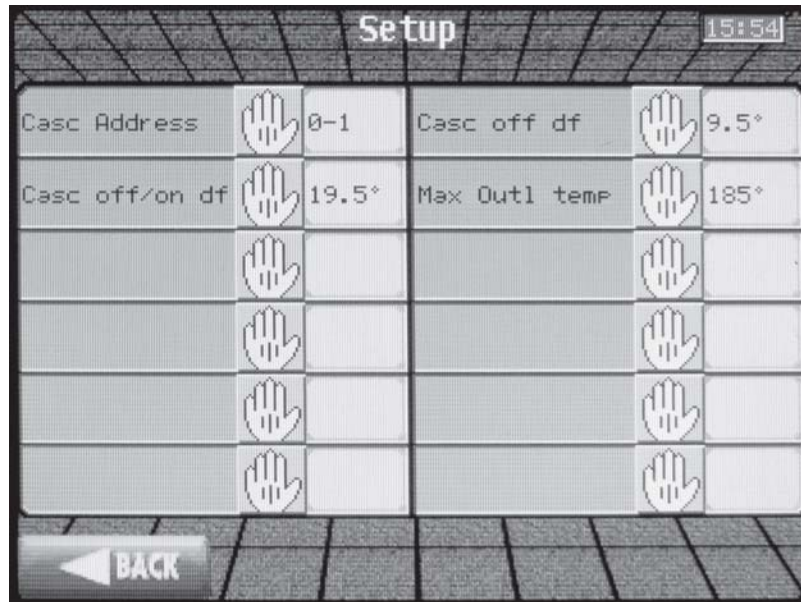

Cascade Operation

When multiple water heaters are installed, they can be wired together in a cascade sequence. A maximum of eight (8) heaters can be controlled from a single control. In this application one heater would be designated as the Leader and all others would be designated as Members. The designated Leader water heater determines the total output needed from the group based on the set point and the tank sensor reading. Reference the Wiring of the Cascade section in the Armor X2 Installation and Operation Manual for more information regarding the cascade feature.

The Cascade Screen allows access to four (4) parameters. Those parameters are as follows:

- Cascade Address - The heater designated as the Leader should be programmed with address 0-1. All Member heaters require addresses from 2-3 through 14-15. The address must be different for each member. The addresses can be in any order, regardless of the order in which the water heaters are wired together. This parameter can only be changed by the installer. The default address is 0-1.
- Cascade Off Differential - Sets how many degrees above set point the temperature has to go before the lead water heater will shut off. This parameter can only be changed by the installer. The temperature range of this parameter is 0° to 72°F. The default value is 10°F.

- Cascade Off/On Differential - Sets how many degrees below the turn off temperature (set point + Cascade Off Differential) the temperature has to go before the lead water heater will turn on. This parameter can only be changed by the installer. The temperature range of this parameter is 0° to 72°F. The default value is 20°F.
- Maximum Outlet Temperature - Sets the set point that individual heater will attempt to achieve in a cascade. When a heater is commanded to fire by the Leader, it will attempt to achieve this temperature at its outlet. The Leader will control the modulation of the last heater to fire in order to hold the temperature at the tank sensor to the user set point. If any of the water heater outlet temperatures reach the Maximum Outlet Temperature setting, the water heater will then modulate down on its own in order to keep its outlet temperature within the Maximum Outlet Temperature setting. Therefore, this parameter can be used to limit the outlet temperatures of all the heaters in a cascade.

Reference page 17 for information regarding changing parameters.

Time - The time is displayed in the upper right-hand corner of the display. It is displayed in a 24 hour format. Reference the night setback parameters on page 21 for information regarding adjusting the date and time.

Back button - Pressing this button will back the screen up to the previous screen.

1 Service *(continued)*

0 - 10Vdc BMS Parameters Screen:

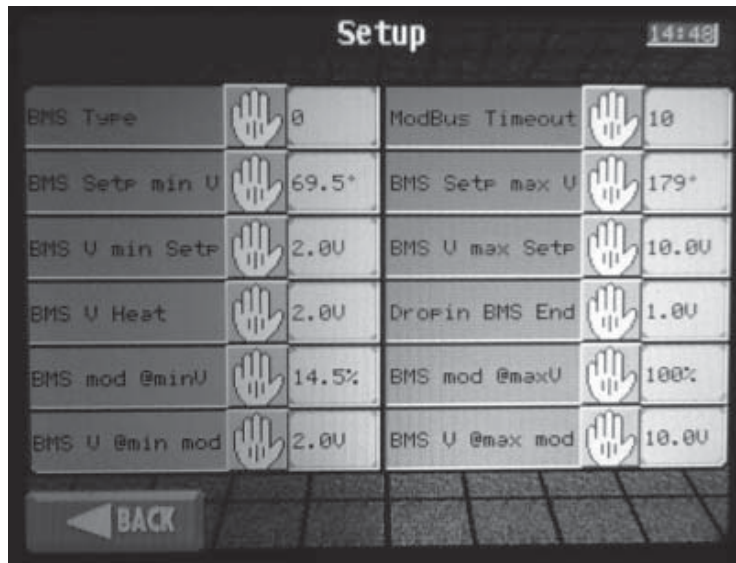

0-10Vdc Operation

When the Demand Configuration parameter (see page 18) is set to either Cascade BMS Thermostat Based, Cascade BMS Voltage Based, Cascade Modbus BMS Thermostat Based, or Cascade Modbus BMS Voltage Based; a 0 - 10Vdc signal can be supplied to the terminal strip connection or through Modbus communications to control a single unit or a multiple unit cascade.

The BMS Screen allows access to 12 parameters. Those parameters are:

- BMS Type - When the unit or cascade is controlled by the 0-10Vdc BMS input, the voltage signal can control either the modulation rate or set point. This parameter can only be changed by the installer. The default method of control is modulation rate.
- ModBus Time - When the tank temperature reading is provided through the ModBus control, it should be refreshed on a regular basis. This setting defines the maximum time it must be refreshed. If the time expires, the control will revert to its local reading.
- BMS Set Point at Minimum Voltage - Determines the set point used by the unit or cascade when the BMS voltage is at or below the setting of the BMS Voltage Minimum Set Point parameter. This parameter is only active when the BMS Type is set to Set Point. This parameter can only be changed by the installer. The temperature range of this parameter is 32° to 179°F. The default value is 70°F.
- BMS Set Point at Maximum Voltage - Determines the set point used by the unit or cascade when the BMS voltage is at or above the setting of the BMS Voltage Maximum Set Point parameter. This parameter is only active when the BMS Type is set to Set Point. This parameter can only be changed by the installer. The temperature range of this parameter is 70° to 190°F. The default value is 179°F.
- BMS Voltage at Minimum Set Point - Determines the voltage at which the external signal begins to increase the set point. Below this voltage, the set point will be at the setting of the BMS Set Point Minimum Voltage parameter. This parameter is only active when the BMS Type is set to Set Point. This parameter can only be changed by the installer. The range of this parameter is 0 to 10V. The default value is 2V.
- BMS Voltage at Maximum Set Point - Determines the voltage at which the external signal forces the set point to the setting of the BMS Set Point Maximum Voltage parameter. This parameter is only active when the BMS Type is set to Set Point. This parameter can only be changed by the installer. The range of this parameter is 2V to 10V. The default value is 10V.
- BMS Voltage at Start Call for Heat - When the Demand Configuration parameter (see page 18) is set to Cascade BMS Voltage Based, this parameter determines the BMS input voltage at which the unit or cascade is enabled. The unit or cascade will become enabled when the BMS input voltage rises up to or above this value. This parameter can only be changed by the installer. The range of this parameter is 0 to 10V. The default value is 2V.
- Drop in BMS Voltage to End Call for Heat - When the Demand Configuration parameter (see page 18) is set to Cascade BMS Voltage Based, this parameter determines the BMS input voltage at which the unit or cascade is disabled. The unit or cascade will become disabled when the BMS input voltage drops down to or below the BMS voltage at start call for heat minus this value. This parameter can only be changed by the installer. The range of this parameter is 0 to 10V. The default value is 1V.

1 Service

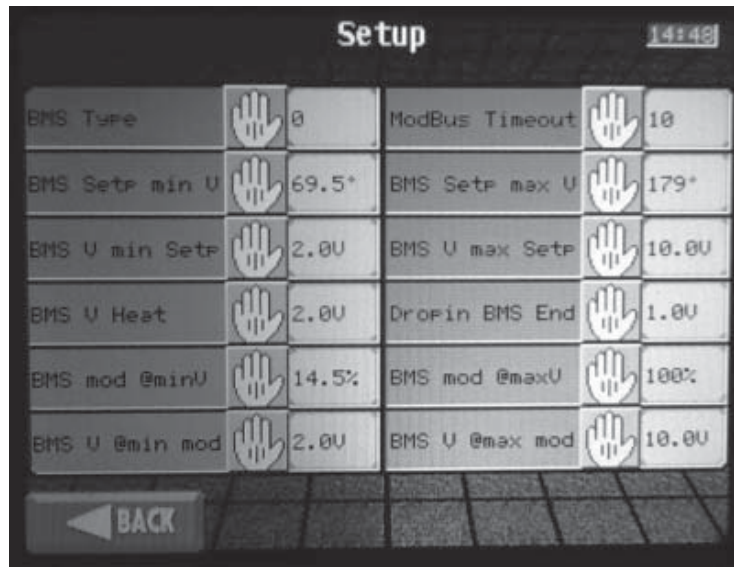

- **BMS Modulation at Minimum Voltage** - Determines the modulation rate of the unit or cascade when the BMS input voltage is at or below the setting of the BMS Voltage at Minimum Modulation parameter. This parameter is only active when the BMS Type is set to modulation rate. This parameter can only be changed by the installer. The range of this parameter is 0% to 100%. The default value is 14.5%.
- **BMS Modulation at Maximum Voltage** - Determines the modulation rate of the unit or cascade when the BMS input voltage is at or above the setting of the BMS Voltage at Maximum Modulation parameter. This parameter is only active when the BMS Type is set to modulation rate. This parameter can only be changed by the installer. The range of this parameter is 14.5% to 100%. The default value is 100%.
- **BMS Voltage at Minimum Modulation** - Determines the voltage at which the external signal begins to increase the modulation rate (power). Below this voltage, the modulation rate (power) will be at the setting of the BMS Modulation at Minimum Voltage parameter. This parameter is only active when the BMS Type is set to modulation rate (power). This parameter can only be changed by the installer. The range of this parameter is 0V to 10V. The default value is 2V.
- **BMS Voltage at Maximum Modulation** - Determines the voltage at which the external signal forces the modulation rate (power) to the setting of the BMS Modulation at Maximum Voltage parameter. This parameter is only active when the BMS Type is set to modulation rate (power). This parameter can only be changed by the installer. The range of this parameter is 2V to 10V. The default value is 10V.

Reference page 17 for information regarding changing parameters.

Time - The time is displayed in the upper right-hand corner of the display. It is displayed in a 24 hour format. Reference the night setback parameters on page 21 for information regarding adjusting the date and time.

Back button - Pressing this button will back the screen up to the previous screen.

1 Service *(continued)*

Cascade Screen:

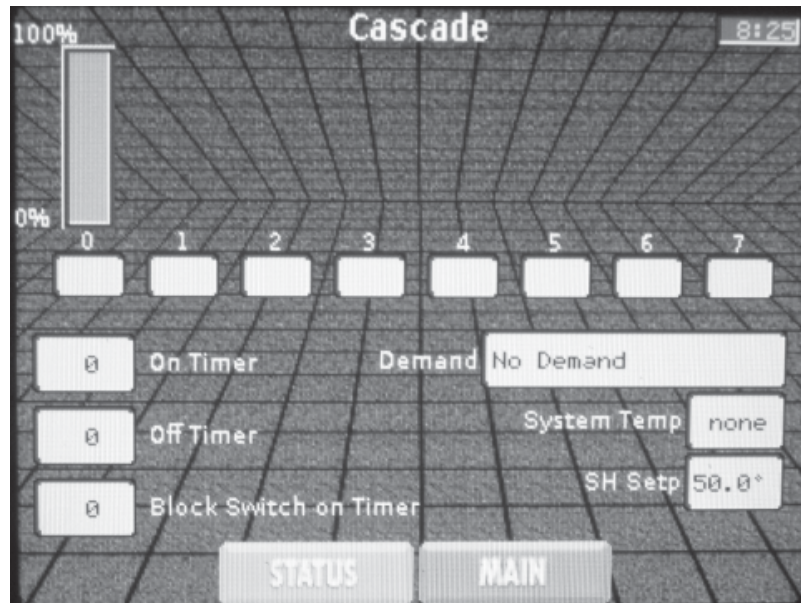

The Cascade Screen provides the status of the cascade system. Items that can be viewed on the Cascade Screen are as follows:

Water Heater Power Level Indicators - For each water heater present in the cascade a power level indicator will be present above its corresponding number. The level will rise and fall indicating the approximate power level of the water heater. The display box underneath each number will display "HW" when that water heater is providing heat for a Hot Water Generation call.

On Timer and Off Timer - The ON and OFF timers are used to force each water heater in the cascade to have a minimum on and off time to prevent short cycling.

Block Switch On Timer - Whenever a water heater is commanded to start, the block switch on timer is started. This provides a delay between the first ignition system and the second ignition system inside the water heater. Once the second ignition system is started, the timer is reset and the next water heater is prevented from starting until the timer times out. This process is repeated for each water heater in the cascade.

Demand - Shows the status of the cascade. Displayed items are:

- No Demand - the Cascade leader has not received a call for heat.
- Hot Water Demand - the Cascade leader has received a call for heat.
- Set Point Met - the tank temperature has met the User Set Point + the Off Differential.
- Pump Delay - the cascade has satisfied a hot water call and the hot water pump is running for a fixed time.

Set Point - This is the set point of the cascade system. The heater designated as the Leader will use this set point to determine the power level required to bring the tank temperature to this point. A default value of 50°F (10°C) is displayed when the Call for Heat is inactive.

Time - The time is displayed in the upper right-hand corner of the display. It is displayed in a 24 hour format. Reference the night setback parameters on page 21 for information regarding adjusting the date and time.

Status button - Pressing this button displays the Status Screen. This screen shows the current status of the Armor X2 water heater. Reference the Status Screen on page 12 for more information regarding this screen.

Main button - Pressing this button displays the Main Screen. From this screen, navigation to eight (8) other screens is possible. Reference the Main Screen on page 16 for more information regarding this screen.

1 Service

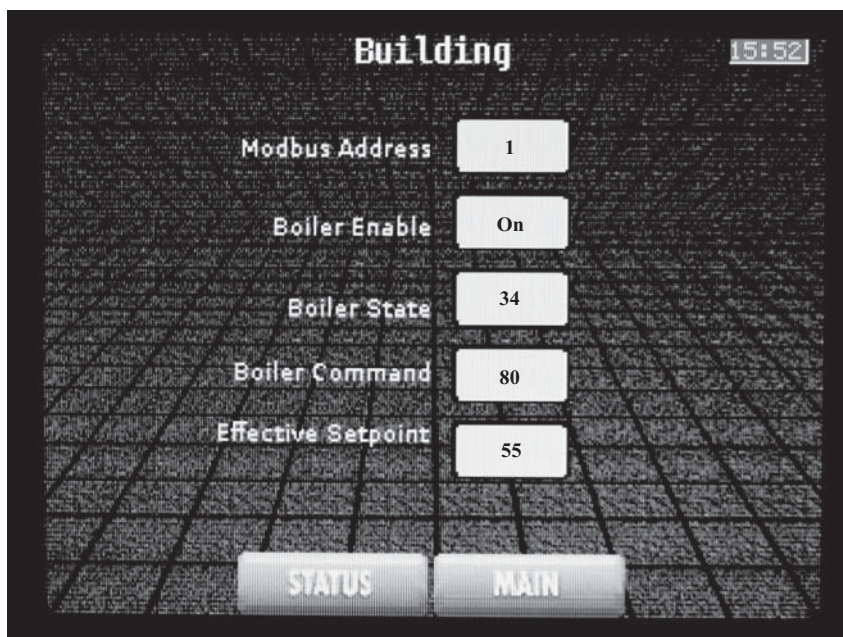

The Building Screen displays information that is specific to the Building Automation System and is being transmitted through the Modbus communication link:

Modbus Address - This is the address of a specific Armor X2 water heater. This address is set by dip switches on the Modbus communication board. The value displayed here should be the same as the value of the dip switches. The Building Automation System should use this address to communicate with the water heater.

Boiler Enable - This displays the enable status that has been transmitted to the water heater by the Building Automation System.

Boiler State - This displays the state code of the water heater. Please reference the Armor X2 Modbus Instruction Manual for a full definition of each code.

Boiler Command - This displays the value written to register 40003 of the Modbus communication board by the Building Automation System. The value is displayed as the percent of firing rate, 80 = 80% firing rate.

Effective Setpoint - This displays the value written to register 40003 of the Modbus communication board by the Building Automation System. The value is displayed as the effective setpoint in degrees (°F or °C).

Note: The water heater can be configured to operate off the water heater command or the effective setpoint. The water heater configuration determines which value is meaningful.

Time - The time is displayed in the upper right-hand corner of the display. It is displayed in a 24 hour format. Reference the night setback parameters on page 21 for information regarding adjusting the date and time.

Status button - Pressing this button displays the Status Screen. this screen shows the current status of the Armor X2 water heater. Reference page 12 for more information regarding this screen.

Main button - Pressing this button displays the Main Screen. From this screen, navigation to eight (8) other screens is possible. Reference the Main Screen on page 16 for more information regarding this screen.

1 Service *(continued)*

Temps Screen:

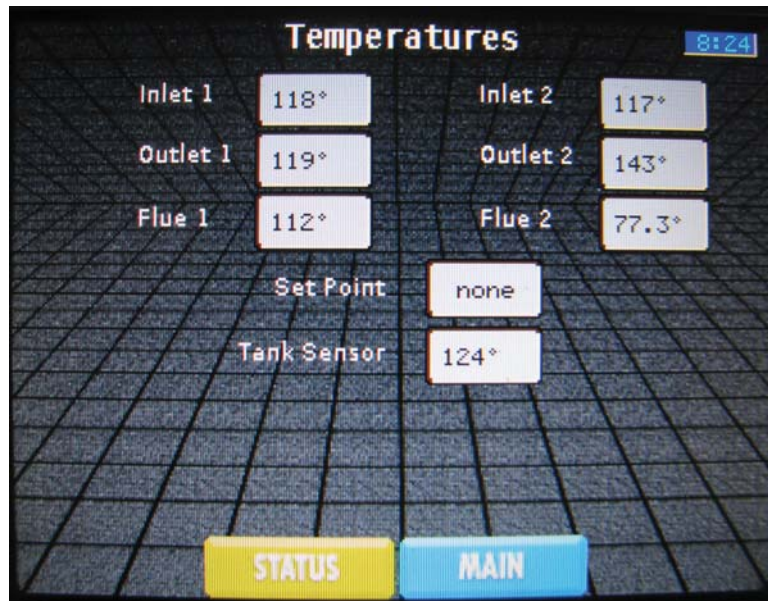

The Temps Screen displays the various temperatures as measured by sensors connected to each control module. Items that can be viewed on the Temps Screen are as follows:

- Inlet 1-2 - This is the water temperature as measured by the sensor located in the inlet of each heat exchanger.
- Outlet 1-2 - This is the water temperature as measured by the sensor located in the outlet of each heat exchanger.
- Flue 1-2 - This is the temperature as measured by the sensor located in the flue connection on each heat exchanger.
- Set Point - The temperature is the tank set point for a Hot Water call.
- Tank Sensor - Temperature sensed in the tank by the tank sensor.

Time - The time is displayed in the upper right-hand corner of the display. It is displayed in a 24 hour format. Reference the night setback parameters on page 21 for information regarding adjusting the date and time.

Status button - Pressing this button displays the Status Screen. this screen shows the current status of the Armor X2 water heater. Reference page 12 for more information regarding this screen.

Main button - Pressing this button displays the Main Screen. From this screen, navigation to eight (8) other screens is possible. Reference the Main Screen on page 16 for more information regarding this screen.

1 Service

Burners Screen:

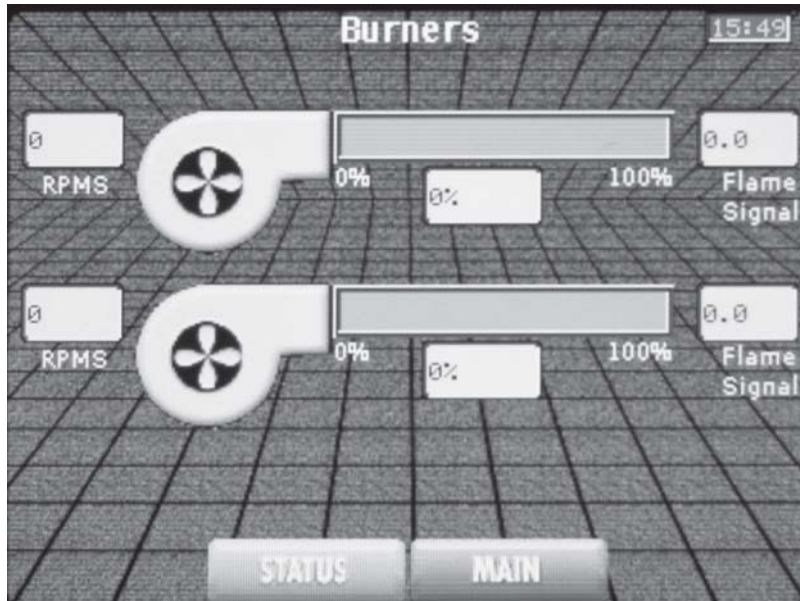

This screen provides the status of the combustion air blowers and flame signals. Items that can be viewed on the Burners Screen are as follows:

- Blower Power Level Indicator - Two (2) blowers are depicted on the display. The top blower corresponds with Heat Exchanger 1 or Top heat exchanger. The lower blower corresponds with Heat Exchanger 2 or Bottom heat exchanger. Beside each blower is a power level indicator. The level will increase and decrease indicating the approximate power level of the blower. The display box underneath each indicator level will display the firing rate of each control module.
- RPM's - Each blower will display the rpm that the control module is requiring of the blower.
- Flame Signal - The flame signal for each control module will be displayed in dc microamps.

Time - The time is displayed in the upper right-hand corner of the display. It is displayed in a 24 hour format. Reference the night setback parameters on page 21 for information regarding adjusting the date and time.

Status button - Pressing this button displays the Status Screen. this screen shows the current status of the Armor X2 water heater. Reference page 12 for more information regarding this screen.

Main button - Pressing this button displays the Main Screen. From this screen, navigation to eight (8) other screens is possible. Reference the Main Screen on page 16 for more information regarding this screen.

1 Service *(continued)*

Graph Select Screen:

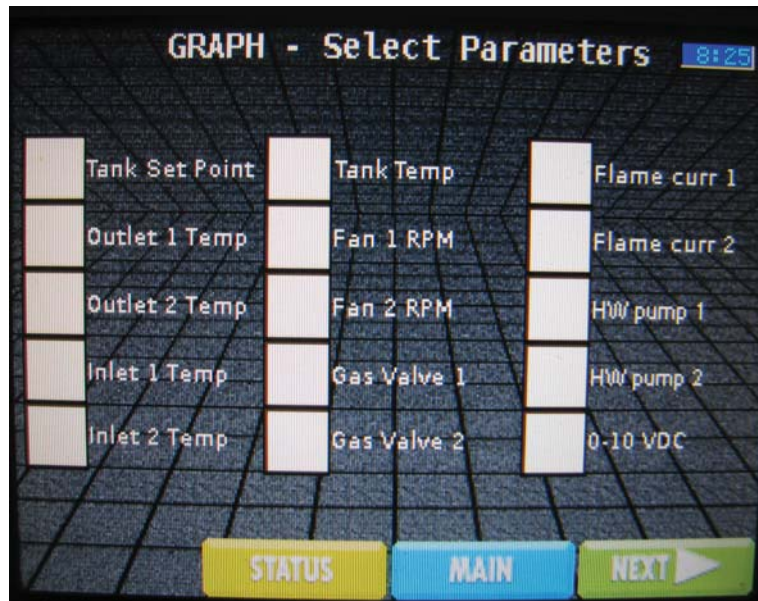

The Graphs Screen consists of two (2) different screens. The first screen is the Parameter Selection Screen. By pressing the box beside the desired item, a check will appear in the selected box and the control will graph the status of that item. A maximum of five (5) items can be graphed at one time.

The second screen is accessed by pressing the NEXT button. Once the items to be graphed are selected, press the NEXT button to view the graph. Each item graphed will have a different color line to represent it. The items selected will be shown in a display bar with their Min and Max ranges listed below them. Press the BACK button to return to the Parameter Selection Screen.

Time - The time is displayed in the upper right-hand corner of the display. It is displayed in a 24 hour format. Reference the night setback parameters on page 21 for information regarding adjusting the date and time.

Status button - Pressing this button displays the Status Screen. this screen shows the current status of the Armor X2 water heater. Reference page 12 for more information regarding this screen.

Main button - Pressing this button displays the Main Screen. From this screen, navigation to eight (8) other screens is possible. Reference the Main Screen on page 16 for more information regarding this screen.

1 Service

History Screen:

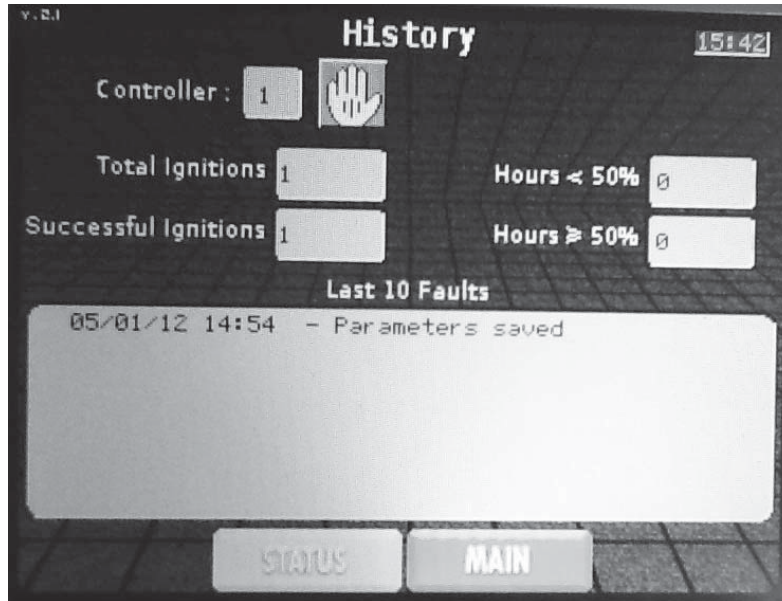

The History Screen shows the status of various counters and faults for each control module. Selection of the control module to be viewed is accomplished by pressing the SELECT button. The control module being displayed is shown in the module box. Items that can be viewed on the History Screen are as follows:

- Successful Ignitions - Shows the number of times the control has successfully ignited.
- Hours > 50% - Shows the number of hours the control has operated at greater than 50%.
- Hours < 50% - Shows the number of hours the control has operated at less than 50%.
- Total Ignitions - Shows the total number of times the control has attempted to ignite.
- Last 10 Faults - Shows the last 10 faults of the control module by date and time.

Time - The time is displayed in the upper right-hand corner of the display. It is displayed in a 24 hour format. Reference the night setback parameters on page 21 for information regarding adjusting the date and time.

Status button - Pressing this button displays the Status Screen. this screen shows the current status of the Armor X2 water heater. Reference page 12 for more information regarding this screen.

Main button - Pressing this button displays the Main Screen. From this screen, navigation to eight (8) other screens is possible. Reference the Main Screen on page 16 for more information regarding this screen.

1 Service *(continued)*

Service Mode Screen:

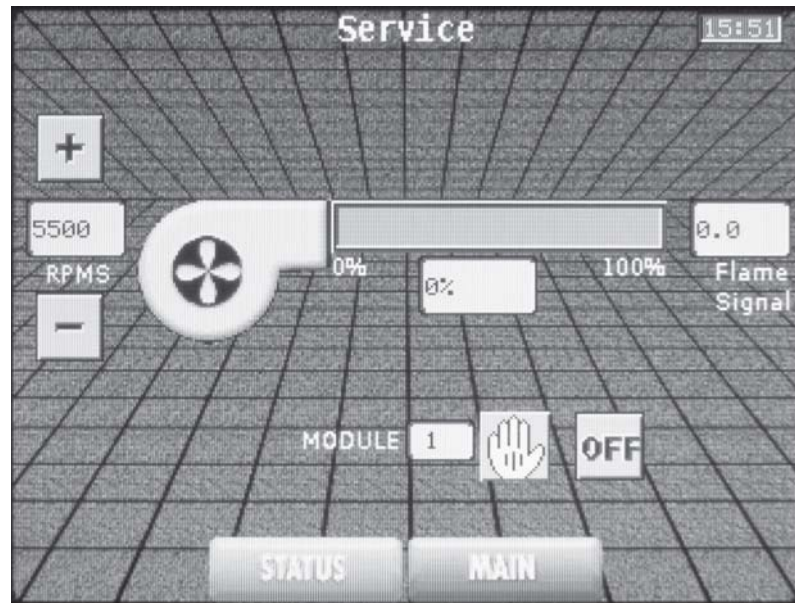

The Service Mode Screen allows the individual control modules to override all other heat demands and operate at a full fire condition for the purpose of combustion analysis. Selection of the control module to be placed into Service Mode is accomplished by pressing the SELECT button. The control module being placed into Service Mode is shown in the module box.

To place the unit into Service Mode, press the ON/OFF button until ON is displayed. The control module will override all other heat demands, however, all safeties will be active. If no buttons are pressed, the control module will automatically revert back to its original state after the Max Service Time delay has expired. The default setting for the Max Service Time is 20 minutes. To take the control module out of Service Mode, press the ON/OFF button until OFF is displayed.

Items that can be viewed and interacted with on the Service Mode Screen are as follows:

- Blower Power Level Indicator - A blower is depicted on the display with a power level indicator beside it. The level will increase and decrease indicating the approximate power level of the blower. The display box underneath the indicator level will display the firing rate of the control module.
- RPM's - The blower motor rpm that the control module is requiring of the blower.
- Plus and Minus Buttons - By pressing the plus or minus button the rpm of the blower motor can be increased or decreased.
- Flame Signal - The flame signal for the control module will be displayed in dc microamps.

Time - The time is displayed in the upper right-hand corner of the display. It is displayed in a 24 hour format. Reference the night setback parameters on page 21 for information regarding adjusting the date and time.

Status button - Pressing this button displays the Status Screen, this screen shows the current status of the Armor X2 water heater. Reference page 12 for more information regarding this screen.

Main button - Pressing this button displays the Main Screen. From this screen, navigation to eight (8) other screens is possible. Reference the Main Screen on page 16 for more information regarding this screen.

2 Maintenance

Maintenance and annual startup

Table 2A Service and Maintenance Schedules

Service technician (see the following pages for instructions)		Owner maintenance	
ANNUAL START-UP	General:		
	<ul style="list-style-type: none"> • Address reported problems • Inspect interior; clean and vacuum if necessary; • Clean condensate trap and fill with fresh water • Check for leaks (water, gas, flue, condensate) • Verify flue and air lines in good condition and sealed tight • Check system water pressure/system piping/expansion tank • Check control settings • Check ignition and flame sense electrodes (sand off any deposits; clean and reposition) • Check wiring and connections • Perform start-up checkout and performance verification per Section 9 in the Armor X2 Installation and Operation Manual. • Flame inspection (stable, uniform) • Flame signal (at least 10 microamps at high fire) • Clean the heat exchanger if flue temperature is more than 54°F (30°C) above return water temperature. • Test low water flow conditions. 	Daily	<ul style="list-style-type: none"> • Check water heater area • Check pressure/temperature gauge
	<p>If combustion or performance indicate need:</p> <ul style="list-style-type: none"> • Clean heat exchanger • Remove and clean burner using compressed air only • Clean the blower wheel 	Monthly	<ul style="list-style-type: none"> • Check vent piping • Check air piping • Check air and vent termination screens • Check relief valve • Check condensate drain system • Check automatic air vents
		Every 6 months	<ul style="list-style-type: none"> • Check water heater piping (gas and water) for leaks • Operate relief valve

2 Maintenance *(continued)*

⚠ WARNING Follow the service and maintenance procedures given throughout this manual and in component literature shipped with the water heater. Failure to perform the service and maintenance could result in damage to the water heater or system. Failure to follow the directions in this manual and component literature could result in severe personal injury, death, or substantial property damage.

⚠ WARNING The water heater should be inspected annually only by a qualified service technician. In addition, the maintenance and care of the water heater designated in Table 2A and explained on the following pages must be performed to assure maximum water heater efficiency and reliability. Failure to service and maintain the water heater and system could result in equipment failure.

⚠ WARNING Electrical shock hazard – Turn off power to the water heater before any service operation on the water heater except as noted otherwise in this instruction manual. Failure to turn off electrical power could result in electrical shock, causing severe personal injury or death.

Address reported problems

1. Inspect any problems reported by the owner and correct before proceeding.

Inspect water heater area

1. Verify that water heater area is free of any combustible materials, gasoline and other flammable vapors and liquids.
2. Verify that air intake area is free of any of the contaminants listed in Section 1 of the Armor X2 Installation and Operation Manual. If any of these are present in the water heater intake air vicinity, they must be removed. If they cannot be removed, reinstall the air and vent lines per this manual and the Armor X2 Installation and Operation Manual.

Inspect water heater interior

1. Remove the front access cover and inspect the interior of the water heater.
2. Vacuum any sediment from inside the water heater and components. Remove any obstructions.

Clean condensate trap

1. Inspect the condensate drain line, condensate PVC fittings, and condensate trap.
2. Remove the PVC cap retaining screw from the PVC cap (FIG. 2-1).
3. Remove the 2 inch PVC cap with the switch located at the top of the trap (FIG. 2-1).
4. Remove any sediment in the trap.
5. Fill with fresh water until the water begins to pour out of the drain.
6. Replace the cap. Press the cap onto the trap until the cap makes contact with the drain.
7. Replace the retaining screw.

Figure 2-1 Condensate Trap

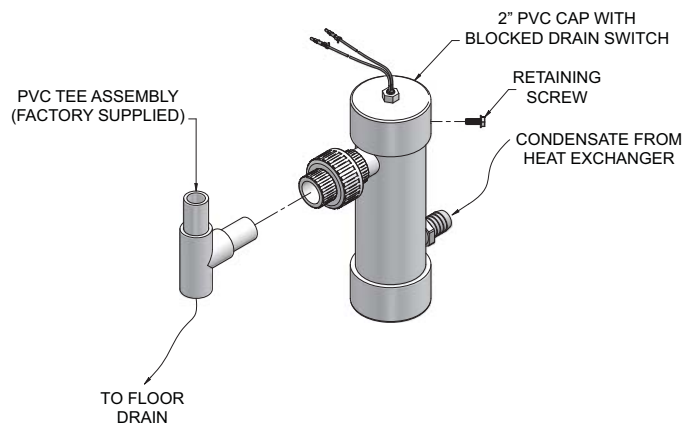

⚠ WARNING The condensate trap must be filled with water during all times of water heater operation to avoid flue gas emission from the condensate drain line. Failure to fill the trap could result in severe personal injury or death.

Check all piping for leaks

⚠ WARNING Eliminate all system or water heater leaks. Leaking water may cause severe property damage.

1. Inspect all water and gas piping and verify to be leak free.
2. Look for signs of leaking lines and correct any problems found.
3. Check gas line using the procedure found in Section 7 - Gas Connections of the Armor X2 Installation and Operation Manual.

2 Maintenance

Flue vent system and air piping

1. Visually inspect the entire flue gas venting system and air piping for blockage, deterioration or leakage. Repair any joints that show signs of leakage. Verify that air inlet pipe is connected and properly sealed.
2. Verify that water heater vent discharge and air intake are clean and free of obstructions.

⚠ WARNING Failure to inspect for the above conditions and have them repaired can result in severe personal injury or death.

Check water system

1. Verify all system components are correctly installed and operational.
2. Watch the system pressure as the water heater heats up (during testing) to ensure pressure does not rise too high. Excessive pressure rise indicates expansion tank sizing or performance problem.

Check expansion tank

1. Expansion tanks provide space for water to move in and out as the water expands due to temperature increase or contracts as the water cools. Tanks may be diaphragm or bladder type. See Section 6 - System Piping of the Armor X2 Water Heater Installation and Operation Manual for suggested best location of expansion tanks.

Check water heater relief valve

1. Inspect the relief valve and lift the lever to verify flow. Before operating any relief valve, ensure that it is piped with its discharge in a safe area to avoid severe scald potential. Read Section 6 - System Piping of the Armor X2 Installation and Operation Manual before proceeding further.

⚠ WARNING Safety relief valves should be re-inspected AT LEAST ONCE EVERY THREE YEARS, by a licensed plumbing contractor or authorized inspection agency, to ensure that the product has not been affected by corrosive water conditions and to ensure that the valve and discharge line have not been altered or tampered with illegally. Certain naturally occurring conditions may corrode the valve or its components over time, rendering the valve inoperative. Such conditions are not detectable unless the valve and its components are physically removed and inspected. This inspection must only be conducted by a plumbing contractor or authorized inspection agency – not by the owner. Failure to re-inspect the water heater relief valve as directed could result in unsafe pressure buildup, which can result in severe personal injury, death, or substantial property damage.

⚠ WARNING Following installation, the valve lever must be operated AT LEAST ONCE A YEAR to ensure that waterways are clear. Certain naturally occurring mineral deposits may adhere to the valve, rendering it inoperative. When manually operating the lever, water will discharge and precautions must be taken to avoid contact with hot water and to avoid water damage. Before operating lever, check to see that a discharge line is connected to this valve directing the flow of hot water from the valve to a proper place of disposal. Otherwise severe personal injury may result. If no water flows, valve is inoperative. Shut down the water heater until a new relief valve has been installed.

2. After following the above warning directions, if the relief valve weeps or will not seat properly, replace the relief valve. Ensure that the reason for relief valve weeping is the valve and not over-pressurization of the system due to expansion tank waterlogging or undersizing.

2 Maintenance *(continued)*

Inspect ignition and flame sense electrodes

1. Remove the ignition and flame sense electrodes from the water heater heat exchanger access cover.
2. Remove any deposits accumulated on the ignition/flame sense electrode using sandpaper. If the electrodes cannot be cleaned satisfactorily, replace with new ones.
3. Replace ignition/flame sense electrode, making sure gasket is in good condition and correctly positioned.

Check ignition ground wiring

1. Inspect water heater ground wire from the heat exchanger access cover to ground terminal strip.
2. Verify all wiring is in good condition and securely attached.
3. Check ground continuity of wiring using continuity meter.
4. Replace ground wires if ground continuity is not satisfactory.

Check all water heater wiring

1. Inspect all water heater wiring, making sure wires are in good condition and securely attached.

Check control settings

1. Go to the Setup Screen and check all settings. See Section 1 of this manual. Adjust settings if necessary. See Section 1 of this manual for adjustment procedures.
2. Check settings of external limit controls (if any) and adjust if necessary.

Perform start-up and checks

1. Start water heater and perform checks and tests specified in Section 9 - Start-up of the Armor X2 Installation and Operation Manual.

Check burner flame

1. Inspect flame through observation window.
2. If the flame is unsatisfactory at either high fire or low fire, turn off water heater and allow water heater to cool down. Remove the burner and clean it thoroughly using a vacuum cleaner or compressed air. Do not use compressed air to clean burner if performed inside a building.
3. Remove the burner, reference FIG. 2-2.
4. When replacing the burner, ensure gasket is in good condition and positioned correctly (FIG. 2-2).

Figure 2-2 Burner Assembly

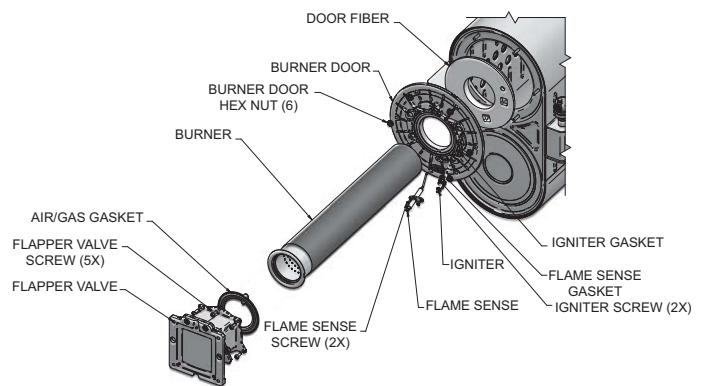

Check flame signal

1. At high fire the flame signal shown on the display should be at least 10 microamps.
2. A lower flame signal may indicate a fouled or damaged flame sense electrode. If cleaning the flame sense electrode does not improve, ground wiring is in good condition, and ground continuity is satisfactory, replace the flame sense electrode.
3. See Section 3 - Troubleshooting in this manual for other procedures to deal with low flame signal.

Review with owner

1. Review the Armor X2 Installation and Operation Manual with the owner.
2. Emphasize the need to perform the maintenance schedule specified in the Armor X2 Installation and Operation Manual (and in this manual as well).
3. Remind the owner of the need to call a licensed contractor should the heater or system exhibit any unusual behavior.

2 Maintenance

Cleaning water heater heat exchanger

For recommended materials; including brush, appropriate extension(s), refractory cover, and detailed instructions see Table 2B - Heat Exchanger Cleaning Kits.

- Shut down water heater:
 - Follow the "To Turn Off Gas to Appliance" instructions for the heater in the Armor X2 Installation and Operation Manual.
 - Do not drain the heater unless it will be exposed to freezing temperatures.
- Allow time for the heater to cool to room temperature if it has been firing.
- Remove the nuts securing the heat exchanger access cover to the heat exchanger and set aside.
- Remove the heat exchanger access cover, burner, and gas/air arm assembly.

⚠ WARNING

The water heater contains ceramic fiber materials. Use care when handling these materials per instructions on page 3 of this manual. Failure to comply could result in severe personal injury.

- Remove the condensate hose from the heat exchanger end. Connect a field supplied 3/4" diameter hose to a drain pan. Using field supplied means, cover the refractory in the back of the combustion chamber of the heat exchanger.
- Use a vacuum cleaner to remove any accumulation on the heating surfaces. Do not use any solvent.
- Brush the heat exchanger while dry using a nylon bristle brush. **Caution:** DO NOT use a metal brush. Re-vacuum the heat exchanger.
- Finish cleaning using a clean cloth dampened with warm water. Rinse out debris with a low pressure water supply.
- Allow the heat exchanger to thoroughly dry.
- Remove the field supplied rear refractory cover from the back of the combustion chamber of the heat exchanger and reassemble.
- Close isolation valves on piping to isolate water heater from system. Attach a hose to the water heater drain and flush water heater thoroughly with clean water by using purging valves to allow water to flow through the water make-up line to the water heater.
- Perform start-up and check-out procedures in the Check Flame and Combustion Section of the Armor X2 Installation and Operation Manual.
- Replace the access cover and restore water heater to operation.

Table 2B Heat Exchanger Cleaning Kits

Model Number	Kit Number	Part Number	Component Description
AW 1.0 - 1.5	KIT30064	MSC20083*	Nylon 4" Wheel Brush*
		MSC20085	1/4" x 12" Drill Extension
		MSC20086	1/4" x 24" Drill Extension

⚠ CAUTION

* Do NOT use a metal brush. Only use the kit provided brush or an equivalent replacement nylon brush.

Check Delta T

- Check the Delta T using Table 2C as a reference.

Table 2C Water Heater Pump Applications / Recommended Temperature Rise

Water Heater Pump Applications							
Model	*Pipe Size		Pump Make	Pump Model	**Flow Rate (GPM)	Loss (FT/HD)	Temp. Rise
	Inlet	Outlet					
1.0	2"	3"	Armstrong	E22	100	26	22°F
1.3	2"	3"	Grundfos	TP 40-160	125	32	22°F
1.5	2"	3"	Grundfos	TP 40-160	130	31	24°F

***Note:** Pump sizing and flow requirements are based on 45 feet of piping, 4 - 90° elbows, and 2 - fully ported ball valves.

****Note:** This appliance is shipped with two pumps to meet the flow requirements listed above.

Oiled bearing circulators

- The circulator shipped with the Armor water heater is water-lubricated. No oiling is required.
- Check other circulators in the system. Oil any circulators requiring oil, following circulator manufacturer's instructions. Over-oiling will damage the circulator.

3 Troubleshooting

Alarm Screen:



If a fault occurs which requires a Manual Reset, the unit will go into a lockout condition and the Alarm Screen will be activated. The screen will switch between a black or red background every 5 seconds with the text “Alarm Unit Needs Servicing” shown on the display.

A message box shows the alarm status of the two (2) control modules. Mod1 is for Control Module 1 and Mod2 is for Control Module 2. A description of the alarm will be beside the control module with the fault. If a control module does not have a fault, “No Alarm Present” will be in the text.

It is possible for one control module to be in alarm while the other continues to function. However, it will not be possible to view any other screens until the control module is reset.

Reset button - The RESET button must be pressed to reset an alarm. Once the button is pressed, the Reset Confirmation Screen appears. You are asked if you wish to reset the control module. If so, press the YES button. If you do not wish to reset the control module press the NO button. If neither button is pressed within 20 seconds, the screen will return to the Alarm Screen.

Once the condition has been corrected and the alarm is reset, the Status Screen will be displayed.

3 Troubleshooting

⚠ WARNING Label all wires prior to disconnection when servicing controls. Wiring errors can cause improper and dangerous operation. Always disconnect power to the water heater before servicing. Failure to comply could result in severe personal injury, death, or substantial property damage.

⚠ WARNING Never jumper (bypass) any device except for momentary testing as outlined in the Troubleshooting chart. Severe personal injury, death, or substantial property damage can result.

Before troubleshooting:

1. Have the following items:
 - a. Voltmeter that can check 120 VAC, 24 VAC, and 12 VDC.
 - b. Continuity checker.
 - c. Contact thermometer.
2. Check for 120 VAC (minimum 102 VAC to maximum 132 VAC) to water heater.
3. Make sure all external limit controls are installed and operating.

Check the following:

1. Wire connectors to control module are securely plugged in at the control module and originating control.
2. Gas pressures:
 - Maximum: 14 inches w.c. (3.5 kPa) natural, 14 inches w.c. (3.2 kPa) LP with no flow (lockup) or with water heater on
 - Minimum: 4 inches (5 inches on 1.0 models only) w.c. (1.0 kPa) natural, 8 inches w.c. (2.0 kPa) LP with gas flowing (verify during water heater startup)

Check control module fuses

NOTICE ALWAYS check control module fuses before replacing control module or any major components (blower, etc.). If one of these fuses is blown, it can prevent the control module or other components from operating.

1. Turn OFF the power to the water heater at the external line switch.
2. Remove the front access cover.
3. Remove the two (2) screws securing the control panel to the unit to gain access to the control module.

Figure 3-1 Control Module Fuses

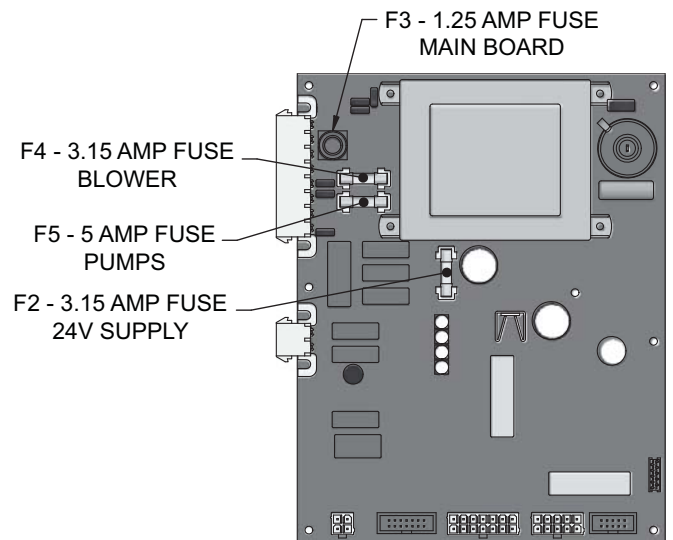

4. Remove the two (2) nuts on the control module cover.
5. Inspect fuses F2, F3, F4, and F5, see FIG 3-1 below.
6. The water heater is shipped with six (6) spare fuses in a plastic bag located under the low water cutoff on the control module.
7. If necessary, replace open fuse (F3 is 1.25 amps, F2 and F4 are 3.15 amps, and F5 is 5 amps).

Note: Fuses F2 - F5 are all slow blow fuses.

⚠ WARNING Do not jumper fuse or replace with any fuse except as specified. Failure to comply could result in severe personal injury, death, or substantial property damage.

8. Re-install the control module cover using the nuts removed in Step 4.

Note: If the spark wire was unplugged, reattach it to the control.

9. Re-install the control panel using the two (2) screws removed in Step 3. Re-install the front access cover after fuse inspection.
10. Restore power to the water heater at the external line switch and verify water heater operation (Section 9 - Start-up in the Armor X2 Installation and Operation Manual) after completing water heater service.

3 Troubleshooting *(continued)*

Table 3A Troubleshooting Chart - No Display

FAULT	CAUSE	CORRECTIVE ACTION
No Display	- No 120 VAC supplied to unit.	<ul style="list-style-type: none"> • Check external line switch, fuse, or breaker. • Check position of ON/OFF switch. Turn switch to the ON position. • Check 120 VAC through the ON/OFF switch. • Check wiring harness connection between display board and main control board. Connect harness at both points.
	- No voltage through the switch.	<ul style="list-style-type: none"> • Replace switch.
	- Bad display board.	<ul style="list-style-type: none"> • Replace board.
	- Bad main control board.	<ul style="list-style-type: none"> • Replace the main control board.
	- Blown fuse.	<ul style="list-style-type: none"> • Replace fuse F3 on the main control board, see page 38 of this manual.
No Burner Operation	- Main control board temperature set point satisfied.	<ul style="list-style-type: none"> • Review temperature setting.
	- Remote thermostat satisfied.	<ul style="list-style-type: none"> • Review remote thermostat setting.
	- Unit locked out on fault.	<ul style="list-style-type: none"> • Consult display for specific fault. Refer to fault descriptions on page 42 of this manual for corrective actions.
Unit Does Not Modulate Above 50%	- Water heater controlled by BMS.	<ul style="list-style-type: none"> • Check BMS parameter settings.
	- Flue sensor open.	<ul style="list-style-type: none"> • Verify that the flue sensor is located in the flue outlet.
		<ul style="list-style-type: none"> • Check wiring connections at the flue sensor.
		<ul style="list-style-type: none"> • Check the resistance of the flue sensor and compare to Table 3C on page 40 of this manual.

3 Troubleshooting

Checking temperature sensors

The water heater temperature sensors (inlet water, outlet water, system water, and flue) are all resistance type devices. The following tables show the correct values for the sensors at various temperatures. Use an ohmmeter to read the resistance of the sensor at a known temperature. If the resistance of the sensor does not closely match its corresponding table, replace the sensor.

Table 3B - Inlet/Outlet and Tank Sensor Resistance vs. Temperature

Temperature	Resistance	Temperature	Resistance
50	18,780	158	1,990
68	12,263	176	1,458
86	8,194	194	1,084
104	5,592	212	817
122	3,893	--	--
140	2,760	--	--

Table 3C - Flue Temperature Sensor Resistance vs. Temperature

Temperature	Resistance	Temperature	Resistance
68	14,773	176	1,707
86	9,804	194	1,266
104	6,652	212	952
122	4,607	230	726
140	3,252	248	560
158	2,337	--	--

3 Troubleshooting *(continued)*

Table 3D Troubleshooting Chart - Noisy System

FAULT	CAUSE	CORRECTIVE ACTION
Noisy Operation	- Supply gas problem. Natural gas pressures should be between 4 inches w.c. (1.0 kPa) and 14 inches w.c. (3.5 kPa). LP gas pressures should be between 8 inches w.c. (2.0 kPa) and 14 inches w.c. (3.2 kPa).	<ul style="list-style-type: none"> Refer to Section 7 - Gas Connections of the Armor X2 Installation and Operation Manual for detailed information concerning the gas supply.
	- Gas/air mixture problem.	<ul style="list-style-type: none"> Refer to the Gas Valve Adjustment Procedure on page 50 of this manual for the proper gas valve setting. Verify that the vent/air intake lengths do not exceed the maximum listed in the General Venting section of the Armor X2 Installation and Operation Manual.
	- Dirty/damaged burner.	<ul style="list-style-type: none"> Refer to page 35 in this manual for the burner removal and inspection procedure. Clean or replace the burner as necessary.
	- Low water flow through the heat exchanger.	<ul style="list-style-type: none"> Refer to Section 6 - System Piping of the Armor X2 Installation and Operation Manual for minimum flow rates. Verify that the water heater is piped in a primary/secondary fashion and that the water heater and system pump are running on a call for heat.
	- Air in the piping system.	<ul style="list-style-type: none"> Properly purge all air from the piping system.
	- Low system water pressure.	<ul style="list-style-type: none"> Verify system pressure is a minimum of 12 psi (82.7 kPa).
No Pump Operation - HW Pump	- Blown fuse.	<ul style="list-style-type: none"> Replace fuse F5 on the control board, see page 38 of this manual.
	- Faulty pump.	<ul style="list-style-type: none"> Replace pump.
	- Internal fault on control board.	<ul style="list-style-type: none"> Replace main control board.
	- Faulty pump relay.	<ul style="list-style-type: none"> Replace relay.
Relief Valve Opening	- System pressure exceeds relief valve setting.	<ul style="list-style-type: none"> Lower the system pressure below the 150 psi (1034.2 kPa) rating of the supplied relief valve. Improperly sized expansion tank.
	- Outlet temperature exceeds relief valve settings.	<ul style="list-style-type: none"> Check temperature settings of the main control board.

3 Troubleshooting

Table 3E Troubleshooting Chart - Fault Messages Displayed on Water Heater Interface

FAULT	DESCRIPTION	CORRECTIVE ACTION
<p>Flow Switch/ LWCO (will require a manual reset once condition has been corrected. Press the RESET button on the display to reset.)</p>	<p>Either the flow switch or the optional AUX switch is not making.</p>	<ul style="list-style-type: none"> • Check water heater pump operation on a call for heat. • Check for closed valves or obstructions in the water heater piping. • Verify system is full of water and all air has been purged from the system. • Check for loose or misplaced jumpers if flow switch is not installed.
	<p>Blown fuse.</p>	<ul style="list-style-type: none"> • Replace fuse F2 on the control board, see page 38 of this manual.
<p>Condensate Drain Blocked (will require a manual reset once condition has been corrected. Press the RESET button on the display to reset.)</p>	<p>The blocked drain switch has detected excessive condensate build up inside the unit.</p>	<ul style="list-style-type: none"> • Check condensate tube from unit to floor drain for proper installation and obstructions. • Inspect condensate trap for blockage. Clean if necessary. • Check for loose wiring connection at wire harness plug. • Bad blocked drain switch. Replace switch.
<p>Flame out of Sequence (will require a manual reset once the condition has been corrected. Press the RESET button on the display to reset.)</p>	<p>The flame detector circuit is seeing a flame signal while no flame is present.</p>	<ul style="list-style-type: none"> • Check supply voltage for proper polarity. • Check external wiring for voltage feedback. • Check the flame rod and make sure it is clean. • Check the internal wiring for bad connections. • Replace main control board.
<p>Gas Valve / Connection (will require a manual reset once the condition has been corrected. Press the RESET button on the display to reset.)</p>	<p>The main control board did not detect the gas valve.</p>	<ul style="list-style-type: none"> • Check wiring harness connection at the gas valve and at the main control board. • Replace the gas valve wire harness. • Replace the gas valve. • Replace the main control board.
<p>Burner Did Not Light (will require a manual reset once the condition has been corrected. Press the RESET button on the display to reset.)</p>	<p>The unit has failed to prove main burner ignition. It will require a manual reset before attempting to fire again.</p>	<ul style="list-style-type: none"> • Inspect spark electrode and associated wiring for damage and connection. Reference page 35 of this manual for removal and cleaning procedures. Replace if necessary. • Check for proper electrical grounding of the unit. • Check incoming supply gas pressure. Natural gas pressures should be between 4 - 14 inches w.c. (1.0 - 3.5 kPa) and LP gas pressures should be between 8 - 14 inches w.c. (2.0 - 3.2 kPa). Refer to Section 7 - Gas Connections of the Armor X2 Installation and Operation Manual for detailed information concerning the gas supply. • Verify that the tube from the gas valve to the air inlet is connected and is not damaged. • Verify that the vent/air intake pipes are correctly installed and that there are no obstructions. • Check for 24 VAC to the gas valve at the 2-pin connection on the side of the main control board during the ignition attempt. If no voltage is present, replace the main control board.

3 Troubleshooting *(continued)*

Table 3E *(continued from previous page) Troubleshooting Chart - Fault Messages Displayed on Water Heater Interface*

FAULT	DESCRIPTION	CORRECTIVE ACTION
<p> Burner Did Not Light (cont'd) (will require a manual reset once the condition has been corrected. Press the RESET button on the display to reset.) </p>	<p>The unit has failed to prove main burner ignition. It will require a manual reset before attempting to fire again.</p>	<ul style="list-style-type: none"> • If 24 VAC is present at the main control board, check the wiring between the main control board and the gas valve. Replace the wiring if necessary. Do not disconnect the wiring from the gas valve and attempt to measure voltage at that point. The main control board can detect if the gas valve is not connected and will display the Gas Valve / Connection fault. • If 24 VAC is present, check the outlet of the valve to ensure the valve is flowing gas. With a manometer connected to the outlet tap of the gas valve, when the unit is in the prepurge period, there should be a negative pressure present. When the valve is energized a change in pressure should occur. If the pressure change does not occur, the gas valve is not opening. Replace the gas valve. • Inspect flame sensor and associated wiring. Reference page 35 of this manual for removal and cleaning procedures. Replace if necessary. • Inspect the burner. Reference page 35 of this manual for removal and cleaning procedures. Replace if necessary. • Replace the main control board.
<p> Flame Lost While Running (will require a manual reset once the condition has been corrected. Press the RESET button on the display to reset.) </p>	<p>The unit was running and lost the flame signal. This condition occurred twice .</p>	<ul style="list-style-type: none"> • Inspect spark electrode and associated wiring for damage and connection. Reference page 35 of this manual for removal and cleaning procedures. Replace if necessary. • Check for proper electrical grounding of unit. • Check incoming supply gas pressure. Natural gas pressures should be between 4 - 14 inches w.c. (1.0 - 3.5 kPa) and LP gas pressures should be between 8 - 14 inches w.c. (2.0 - 3.2 kPa). Refer to Section 7 - Gas Connections of the Armor X2 Installation and Operation Manual for detailed information concerning the gas supply. • Verify that the tube from the gas valve to the air inlet is connected and is not damaged. • Verify that the vent/air intake pipes are installed correctly and there are no obstructions. • Check for 24 VAC to the gas valve at the 2-pin connection on the side of the main control board during the ignition attempt. If no voltage is present, replace the main control board.

3 Troubleshooting

Table 3E (continued from previous page) Troubleshooting Chart - Fault Messages Displayed on Water Heater Interface

FAULT	DESCRIPTION	CORRECTIVE ACTION
<p>Flame Lost While Running (cont'd) (will require a manual reset once the condition has been corrected. Press the RESET button on the display to reset.)</p>	<p>The unit was running and lost the flame signal. This condition occurred twice .</p>	<ul style="list-style-type: none"> • If 24 VAC is present at the main control board, check the wiring between the main control board and the gas valve. Replace the wiring if necessary. Do not disconnect the wiring from the gas valve and attempt to measure voltage at that point. The main control board can detect if the gas valve is not connected and will display the Gas Valve / Connection fault. • If 24 VAC is present, check the outlet of the valve to ensure the valve is flowing gas. With a manometer connected to the outlet tap of the gas valve, when the unit is in the prepurge period, there should be a negative pressure present. When the valve is energized a change in pressure should occur. If the pressure change does not occur, the gas valve is not opening. Replace the gas valve. • Inspect flame sensor and associated wiring. Reference page 35 of this manual for removal and cleaning procedures. Replace if necessary. • Inspect the burner. Reference page 35 of this manual for removal and cleaning procedures. Replace if necessary. • Replace the main control board.
<p>Manual Reset High Limit (will require a manual reset once the condition has been corrected. Press the RESET button on the display to reset.)</p>	<p>The outlet water temperature has exceeded the setting of the high limit.</p>	<ul style="list-style-type: none"> • Verify that the system is full of water and that all air has been properly purged from the system. • Verify that the water heater is piped properly into the heating system. Refer to Section 6 - System Piping of the Armor X2 Installation and Operation Manual for the proper piping methods for the Armor X2. • Check voltage to water heater pump motor on a call for heat. If voltage is not present, check wiring back to the pump relay. • Replace the pump relay if necessary. • If 120 VAC is present on a call for heat and the water heater pump is not operating, replace the pump. • If the high limit has tripped, check setting of the device. • Check resistance of water sensors and compare to Table 3B on page 40 of this manual. Replace sensor if necessary. • Replace high limit.

3 Troubleshooting *(continued)*

Table 3E (continued from previous page) Troubleshooting Chart - Fault Messages Displayed on Water Heater Interface

FAULT	DESCRIPTION	CORRECTIVE ACTION
<p>Automatic Reset High Limit / HEX-Temp SW (will require a manual reset once the condition has been corrected. Press the RESET button on the display to reset.)</p>	<p>Either the auto-reset high limit, or the O-temp heat exchanger switch has opened.</p>	<p>Automatic Reset High Limit:</p> <ul style="list-style-type: none"> • Verify that the system is full of water and that all air has been properly purged from the system. • Verify that the water heater is piped properly into the heating system. Refer to Section 6 - System Piping of the Armor X2 Installation and Operation Manual for the proper piping methods for the Armor X2. • Check voltage to water heater pump motor on a call for heat. If voltage is not present, check wiring back to the pump relay. • Replace the pump relay if necessary. • If 120 VAC is present on a call for heat and the water heater pump is not operating, replace the pump. • Check resistance of water sensors and compare to Table 3B on page 40 of this manual. Replace sensor if necessary. • Replace outlet sensor.
		<p>HEX Temp SW:</p> <ul style="list-style-type: none"> • Check continuity across two contacts. Wires should be connected at both poles of normally closed switch. • Inspect the rear of the inner combustion chamber at the burner level, for refractory breakdown/missing. Replace the refractory if no damage to the heat exchanger as a result of the burner, otherwise, replace the heat exchanger. • Faulty O-temp heat exchanger switch. Replace switch.
<p>Blower RPM's Too Low (will require a manual reset once the condition has been corrected. Press the RESET button on the display to reset.)</p>	<p>The actual fan rpm is 30% lower than what is being called for. Reference the Burners Screen information on page 28 of this manual.</p>	<ul style="list-style-type: none"> • Vent/air intake lengths exceed the maximum allowed lengths. Refer to Section 3 - General Venting of the Armor X2 Installation and Operation Manual for proper lengths. • Check for obstruction or blockage in the vent/air intake pipes or at terminations. • Check the wiring connections at the fan and at the main control board. • Replace the fan. • Replace the main control board.
	<p>Blown fuse.</p>	<ul style="list-style-type: none"> • Replace fuse F4 on the control board, see page 38 of this manual.

3 Troubleshooting

Table 3E (continued from previous page) Troubleshooting Chart - Fault Messages Displayed on Water Heater Interface

FAULT	DESCRIPTION	CORRECTIVE ACTION
<p>Blower RPM's Too High (will require a manual reset once the condition has been corrected. Press the RESET button on the display to reset.)</p>	<p>The actual fan rpm is 30% higher than what is being called for.</p>	<ul style="list-style-type: none"> • Vent/air intake lengths exceed the maximum allowed lengths. Refer to Section 3 - General Venting of the Armor X2 Installation and Operation Manual for proper lengths. • Check for obstruction or blockage in the vent/air intake pipes or at terminations. • Check the wiring connections at the fan and at the main control board. • Replace the fan. • Replace the main control board.
<p>Sensor Open (will require a manual reset once the condition has been corrected. Press the RESET button on the display to reset.)</p>	<p>Either the inlet water or outlet water temperature sensor has been disconnected.</p>	<ul style="list-style-type: none"> • Check the sensors and their associated wiring. Repair or replace the sensor or wiring if damaged. • Measure the resistance of the sensors and compare the resistance to the tables on page 40 of this manual. • Replace the sensor if necessary.
<p>Sensor Shorted (will require a manual reset once the condition has been corrected. Press the RESET button on the display to reset.)</p>	<p>Either the inlet water or outlet water temperature sensor has been shorted.</p>	<ul style="list-style-type: none"> • Check the sensors and their associated wiring. Repair or replace the sensor or wiring if damaged. • Measure the resistance of the sensors and compare the resistance to the tables on page 40 of this manual. • Replace the sensor if necessary.
<p>Flue Sensor Open / Removed (will require a manual reset once the condition has been corrected. Press the RESET button on the display to reset.)</p>	<p>The flue sensor has been disconnected or removed from the flue.</p>	<ul style="list-style-type: none"> • Check the sensor and its associated wiring. Repair or replace the sensor or wiring if damaged. • Measure the resistance of the sensors and compare the resistance to the tables on page 40 of this manual. • Replace the sensor in flue. • Replace the sensor if necessary.
<p>Flue Sensor Shorted (will require a manual reset once the condition has been corrected. Press the RESET button on the display to reset.)</p>	<p>The flue sensor has been shorted.</p>	<ul style="list-style-type: none"> • Check the sensor and its associated wiring. Repair or replace the sensor or wiring if damaged. • Measure the resistance of the sensors and compare the resistance to the tables on page 40 of this manual. • Replace the sensor if necessary.
<p>Louver Proving Switch (will require a manual reset once the condition has been corrected. Press the RESET button on the display to reset.)</p>	<p>An optional remote proving switch is not making.</p>	<ul style="list-style-type: none"> • Check function of remote devices. • Check for loose or misplaced jumper if proving switch is not installed.

3 Troubleshooting *(continued)*

Table 3E *(continued from previous page) Troubleshooting Chart - Fault Messages Displayed on Water Heater Interface*

FAULT	DESCRIPTION	CORRECTIVE ACTION
<p style="text-align: center;">Air Flow Too Low</p> <p>(will require a manual reset once the condition has been corrected. Press the RESET button on the display to reset.)</p>	Air pressure switch contacts are open.	<ul style="list-style-type: none"> • Check the wiring connections to switch. Wires should be connected to the common and normally closed terminals. • Vent/air intake lengths exceed the maximum allowed lengths. Refer to Section 3 - General Venting of the Armor X2 Installation and Operation Manual for proper lengths. • Check for obstruction or blockage in the vent/air intake pipes or at terminations. • Check reference hoses connected to the air pressure switch for blockage or obstruction. • Inspect the burner. Reference page 35 of this manual for removal and cleaning procedures. Replace if necessary. • Inspect the heat exchanger. Reference page 36 of this manual for removal and cleaning procedures. Replace if necessary. • Faulty air pressure switch. Replace switch.
	Flap valve contacts are in an open position.	<ul style="list-style-type: none"> • Check the wiring connections to the flap valve switch. Replace or repair wiring if necessary. • Check for obstruction in the vent / air intake pipes or at terminations. • Verify combustion air blower is operating. Replace if necessary. • Replace flap valve switch.
<p style="text-align: center;">Flap Valve Stuck Open</p>	Flap valve contacts are in a closed position.	<ul style="list-style-type: none"> • Check wiring connections to the flap valve switch. Replace or repair wiring if necessary. • Check flap valve for obstruction or blockage. • Replace flap valve switch.
<p style="text-align: center;">Too Many Resets - Try Later</p>	Too many manual resets have occurred during a 15 minute period.	<ul style="list-style-type: none"> • Wait 15 minutes and try again. • Turn power off to unit, wait 30 seconds and then turn power back on.
<p style="text-align: center;">Voltage Too Low</p>	120 VAC input to the main control board has dropped below 80 VAC.	<ul style="list-style-type: none"> • Check 120 VAC supply to the transformer. • Check wiring connections at the low voltage terminal strip. • Check the wire size/length to remote devices. • Replace the main control board.

3 Troubleshooting

Table 3E (continued from previous page) Troubleshooting Chart - Fault Messages Displayed on Water Heater Interface

FAULT	DESCRIPTION	CORRECTIVE ACTION
Internal Fault	The main control board has detected an internal fault.	<ul style="list-style-type: none"> • Replace the main control board.
Writing to Memos	The main control board has detected an internal fault.	<ul style="list-style-type: none"> • Replace the main control board.
CRC Parameters	The main control board has detected an internal fault.	<ul style="list-style-type: none"> • Replace the main control board.
No Error Stored	The main control board has detected an internal fault.	<ul style="list-style-type: none"> • Press the RESET button on the SMART TOUCH display panel.
Flue Temp Shutdown	The stack temperature has exceeded the set parameters for the water heater.	<ul style="list-style-type: none"> • Inspect the heat exchanger. Reference page 36 of this manual for the procedure on how to clean the flue side of the heat exchanger. • Inspect the flue sensor and associated wiring. Measure the resistance of the flue sensor and compare to Table 3C on page 40 of this manual. Replace the sensor if necessary. • Verify that the vent/air intake pipes are properly installed and that there are no obstructions. • Replace the main control board.
Delta T Shutdown	The temperature rise across the heat exchanger has exceeded the set parameters for the water heater.	<ul style="list-style-type: none"> • Verify that the system is full of water and that all air has been properly purged from the system. • Verify that the heater is piped properly into the heating system. Refer to Section 6 - System Piping of the Armor X2 Installation and Operation Manual for the proper piping methods for the Armor X2 water heater. • Check for voltage to the water heater pump motor on a call for heat. If voltage is not present, check the wiring back to the pump relay. Replace the pump relay if necessary. • If 120 VAC is present on a call for heat and the water heater pump is not operating, replace the pump. • Verify that the water heater pump is set to the proper speed or that the pump is the proper size. Reference Section 6 - System Piping of the Armor X2 Water Heater Installation and Operation Manual for water heater pump specifications.
Outlet Temp Shutdown	Outlet water temperature has exceeded the maximum outlet water temperature.	<ul style="list-style-type: none"> • Verify that the system is full of water and that all air has been properly purged from the system. • Verify that the water heater is piped properly into the heating system. Refer to Section 6 - System Piping of the Armor X2 Installation and Operation Manual for the proper piping methods for the Armor X2 water heater. • Check for voltage to the water heater pump motor on a call for heat. If voltage is not present, check wiring back to the pump relay. Replace the pump relay if necessary. • If 120 VAC is present on a call for heat and the heater pump is not operating, replace the pump.

3 Troubleshooting *(continued)*

Combustion Analysis Procedure

1. Turn the main power off to the water heater by placing the "On/Off" switch in the OFF position.
2. Remove the flue temperature sensors from the flue pipe connections. **Note:** Combustion measurements will be made at this point.
3. Turn the main power on to the water heater by placing the "On/Off" switch in the ON position.
4. Navigate to the Service Mode Screen from the Status Screen by pressing the MAIN button and then the SERVICE MODE button.
5. On the Service Screen place Heat Exchanger 1 into operation by selecting Heat Exchanger 1 with the SELECT button and turning the heat exchanger on by pressing the ON/OFF button (OFF indicates that the heat exchanger is off and ON indicates that the heat exchanger should be firing).
6. Insert the probe from a combustion analyzer into the hole left by the removal of the flue temperature sensor.

Note: Heat Exchanger 1 is the top heat exchanger; please ensure the probe is in the top flue sensor location.

7. Once the heat exchanger has modulated up to full fire measure the combustion. The values should be in the range listed in Table 3H above. CO levels should be less than 200 ppm for a properly installed unit. If the combustion is not within range reference the chart below for possible causes and corrective actions.

Table 3H Flue Products

Natural Gas		Propane	
CO ₂	O ₂	CO ₂	O ₂
8.0% - 10%	3.0% - 6.5%	9.0% - 11%	4.1% - 6.9%

8. Once the Heat Exchanger 1 analysis is complete, test the safety shutoff device by turning the manual shutoff valve to the OFF position and ensuring that Heat Exchanger 1 shuts down and registers an alarm. Open the manual shutoff valve, reset the control, and return to Service Mode.
9. Repeat the same procedure for Heat Exchanger 2 by selecting Heat Exchanger 2 while on the Service Mode Screen. Be certain to insert the probe from the combustion analyzer into the Heat Exchanger 2 flue temperature sensor location.
10. Turn the main power off to the water heater and replace the flue temperature sensor into the flue pipe connection.
11. Place the water heater back into normal operation.

⚠ WARNING

You must replace the flue gas temperature sensor to prevent flue gas spillage into the room. Failure to comply could result in severe personal injury, death, or substantial property damage.

Table 3G Troubleshooting Chart - Combustion Levels

POSSIBLE CAUSE	CORRECTIVE ACTION
Vent/Air Intake Length or Obstruction	<ul style="list-style-type: none"> • Refer to Section 3 - General Venting of the Armor X2 Installation and Operation Manual for the proper venting and air intake methods for the Armor X2 water heater. • Check for obstructions at the vent/air intake terminals.
Gas Supply Pressure	<ul style="list-style-type: none"> • Refer to Section 7 - Gas Connections of the Armor X2 Installation and Operation Manual for the proper gas supply for the Armor X2 water heater.
Dirty/Damaged Burner	<ul style="list-style-type: none"> • Refer to page 35 of this manual for burner removal and cleaning procedures. • Replace burner if necessary.
Gas Valve Adjustment	<ul style="list-style-type: none"> • Refer to page 50 of this manual for the gas valve adjustment procedure.

3 Troubleshooting

Gas valve adjustment procedure

If adjustment of the gas valve is deemed necessary, use the following procedures: (**Note:** The procedures below are model specific.)

CAUTION Under normal operating conditions this valve should not need adjusting.

Model 1.0

Locate the throttle adjustment screw on top of the gas valve, see FIG. 3-2. Using a screwdriver, turn the screw a 1/4 turn **counterclockwise** to increase CO₂ levels or a 1/4 turn **clockwise** to decrease CO₂ levels. After one adjustment on the valve, follow the Combustion Analysis Procedure on page 49 of this manual to measure the combustion.

If combustion is still not within the specified range, repeat the procedure. This procedure **SHOULD NOT** be performed more than four (4) times. If after four (4) adjustments and the combustion is still not within the specified range, revisit the possible causes in Table 3F on page 49 or replace the gas valve.

Figure 3-2 Gas Valve Adjustment: Model 1.0

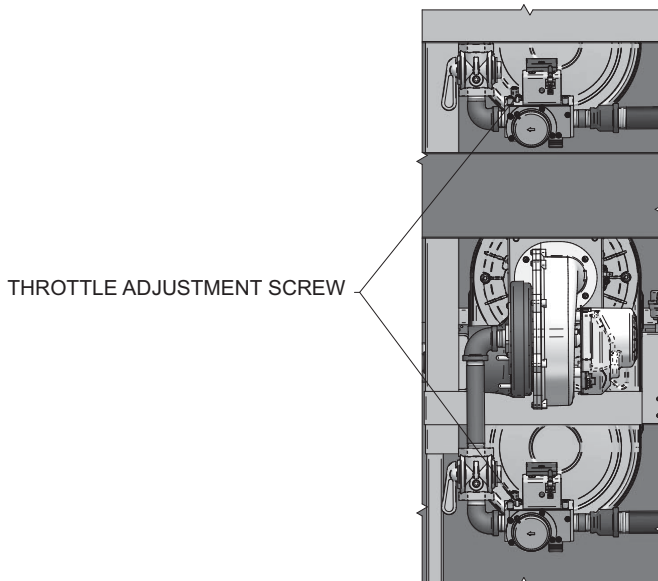

Models 1.3 - 1.5

Locate the throttle adjustment screw on top of the gas valve, see FIG. 3-3. Using an Allen wrench, turn the screw a 1/4 turn **counterclockwise** to increase CO₂ levels or a 1/4 turn **clockwise** to decrease CO₂ levels. After one adjustment on the valve, follow the Combustion Analysis Procedure on page 49 of this manual to measure the combustion.

If combustion is still not within the specified range, repeat the procedure. This procedure **SHOULD NOT** be performed more than four (4) times. If after four (4) adjustments and the combustion is still not within the specified range, revisit the possible causes in Table 3F on page 49 or replace the gas valve.

Figure 3-3 Gas Valve Adjustment: Models 1.3 - 1.5

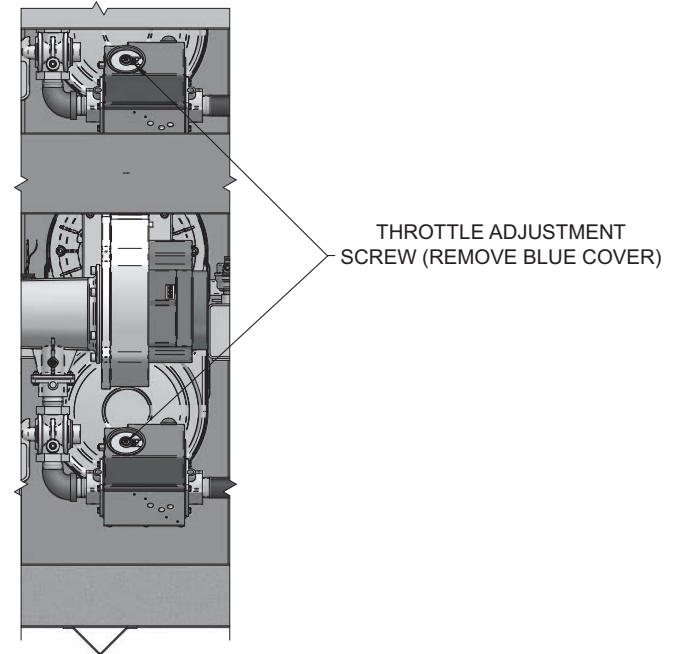

Notes



Revision Notes: *Revision A (ECO #C09645) initial release.*