

CLICK ANYWHERE on THIS PAGE to GAS PIPING, FLEXIBLE CSST INFORMATION at InspectApedia.com

HOME-FLEX[®]

CSST Flexible Gas Pipe

System Design and Installation Manual



Suggested Tools for Installation of HOME-FLEX®



Tubing Cutter

Use to cut HOME-FLEX® tubing to desired length.



Utility Knife

Use to remove yellow protective jacket at tubing end where the fitting is to be installed.



Slip-joint (or similar) Pliers

Use to compress the retainer ring in place on first corrugation (or valley) of the HOME-FLEX® tubing.



Adjustable Wrenches (x2)

Use in fitting assembly to connect the CSST and NPT ends of the fitting.

(¾" fittings require 1½" or larger wrench opening)



Gloves



Eye Protection

For technical support call: **661-257-3923** or email: **info@homeflex.com**



Escanear el código QR de la derecha, o vaya a [es.homeflex.com](https://www.homeflex.com), para descargar la versión española del *Manual de Instalación y Diseño del Sistema*.

HOME-FLEX® CSST System Design and Installation Manual

Chapter 1: Introduction

1.1 User Warnings	1
1.2 Limitations of Manual	2
1.3 Applicable Codes and Standards	3

Chapter 2: Description of System Components

2.1 Tubing	5
2.2 Fittings	6
2.3 Striker Plates	7
2.4 Pressure Regulators	7
2.5 Manifolds	7
2.6 Shut-off valves and Quick-Connect Devices	7
2.7 Bonding Clamps	8
2.8 Protection Devices	8
2.9 HOME-FLEX® Tubing Cutter	9
2.10 Replacement Parts	9
2.11 HOME-FLEX® Appliance Connectors	10

Chapter 3: Sizing and Configurations

3.1 Configuration	11
Low Pressure Systems	12
Dual Pressure Systems	13
Hybrid Systems (Rigid pipe and CSST)	13
3.2 Sizing Methods and Examples	13
Sizing Tables	13
Low Pressure systems (Longest Length/Branch Method)	14
Elevated Pressure Systems	16
Hybrid CSST & Black Iron Rigid Pipe Systems	18

Chapter 4: Installation Practices

4.1 General Practices	20
4.2 Fitting Assembly	21
Male, Female, Union and Tee Fitting Assembly Overview	21
Male, Female, Union and Tee Fitting Assembly	22
Termination Fitting Assembly Overview (Parts 11-464-XXX)	23
Termination Fitting Assembly (Parts 11-464-XXX)	24
Troubleshooting Fitting Connections	25
4.3 Routing	25
General Routing Practices	25
Clearance Holes and Notching	26

Concealed Locations for Fittings	27
Outdoor Installation	28
4.4 Protection	29
Striker Plates	29
Through-Wall Penetration	30
4.5 Meter connections	30
Connection by Special Termination Fitting	30
Direct Connection	30
4.6 Appliance connections	31
Termination Fittings with Appliance Connectors	31
Direct Connection	31
Pad-Mounted Equipment	32
Roof Top Equipment	32
Outdoor Appliances: Barbecue Grills, Gaslights, and Heaters	32
4.7 Manifold Stations	34
4.8 Pressure Regulators	34
Installation Requirements	34
Vent Limiters and Vent Lines	35
Performance Testing	36
Regulator Adjustments	36
4.9 Underground Installations	36
4.10 Electrical Bonding	37

Chapter 5: Inspection, Repair, and Replacement of CSST

5.1 Minimum Inspection Requirements Checklist	39
5.2 Repair of Damaged Tubing	40
When Pipe Needs to be Replaced	40
Method Of Repair: Splice or Replace?	40

Chapter 6: Pressure Test Procedures

6.1 Procedure For Low Pressure Systems	41
6.2 Procedure For Elevated Pressure Systems	41
6.3 Appliance Connection Check Procedure	42

Chapter 7: Sizing/Capacity Tables

7.1 Natural Gas Sizing Tables	43
6-7 in / 0.5 in w.c. drop	44
6-7 in / 1 in w.c. drop	44
8-10 in / 3 in w.c. drop	45
12-14 in / 6 in w.c. drop	45
2 PSI / 1 PSI drop	46
5 PSI / 3.5 PSI drop	46
7.2 Liquid Petroleum (LP) Sizing Tables	47
11 in / 0.5 in w.c. drop	47
13-14 in / 2.5 in w.c. drop	47
2 PSI / 1 PSI drop	48
5 PSI / 3.5 PSI drop	48
7.3 Steel Pipe Capacity Chart	49
½ PSI / 0.5 in w.c. drop	49

Chapter 8: Technical Information Sheet

8.1 HOME-FLEX® Corrugated Stainless Steel Tubing (CSST)50
8.2 HOME-FLEX® Fittings50
8.3 HOME-FLEX® Manifolds50
8.4 HOME-FLEX® Protection Devices.....50

Chapter 9: Definitions.....51

Chapter 1: Introduction

This side of the HOME-FLEX® manual applies to HOME-FLEX® Corrugated Stainless Steel Tubing (CSST) and its associated metal fittings. **HOME-FLEX® CSST and HOME-FLEX Underground® are two different systems with different uses and installation requirements. The tubing and fittings are not interchangeable.**

The corrugations of the CSST give this flexible metal gas pipe a ribbed appearance. The CSST has a yellow plastic covering over it that is referred to as a jacket. Even though the yellow plastic jacket covers the outside of the ribbed tubing, you can still see and feel the ribs. HOME-FLEX® CSST is for use with natural gas and LP (propane) gas. CSST is for use inside houses and buildings and may also be installed under houses and buildings. It may be run underground only if it is protected within a non-metallic water tight conduit.

1.1 User Warnings

HOME-FLEX® Corrugated Stainless Steel Tubing (CSST) flexible gas piping material must be installed by a Qualified Installer who has been certified in the use of the HOME-FLEX® gas piping system. Certification can be completed by reading this *System Design and Installation Manual* and registering with Valencia Pipe Company to obtain a Qualified Installer Card by filling out the online form at register.homeflex.com, or by calling 661-257-3923 in the absence of internet access. In submitting the registration, you are asserting that you understand all aspects of the installation requirements, including all materials used, as well as local plumbing, mechanical, electrical and/or building codes applicable at the locale where HOME-FLEX® is to be installed. If you do not understand all aspects of the installation requirements and local codes, locate a Qualified Installer in your area who does. You must presently possess, or attain prior to installing, a HOME-FLEX® Qualified Installer Card to install HOME-FLEX® CSST.

Additional resources beyond this guide can be accessed on the HOME-FLEX® website: www.homeflex.com. Installers must meet applicable qualifications set forth by the state and/or local administrative authorities which enforce the plumbing, mechanical and/or electrical codes where the gas piping is being installed.

This HOME-FLEX® *System Design and Installation Manual* provides general instructions for the design and installation of flexible gas piping systems using HOME-FLEX® branded CSST. It is not to be used as a guide for the installation of other manufacturers' CSST products.

The HOME-FLEX® *System Design and Installation Manual* is to be used in conjunction with state and local building codes. In the event of a conflict between this guide and local codes, the local code takes precedence. In the absence of local codes, installation shall comply with the current edition of the *National Fuel Gas Code* (ANSI Z223.1/NFPA 54), the *National Standard of Canada*, the *Natural Gas and Propane Installation Code* (CSA B149.1), the *Uniform Plumbing Code*, the *Federal Manufactured Home Construction and Safety Standards* (ICC/ANSI 2.0), the *Standard on Manufactured Housing* (NFPA 501), the *National Electric Code* (NFPA 70), and/or the *Standard for the Installation of Lightning Protection System* (NFPA 78), as applicable.

The instructions and procedures outlined in the HOME-FLEX® *System Design and Installation Manual* must be strictly adhered to for a safe and effective installation. Prior to beginning installation, competent engineering practices and principles must be employed in designing the system, taking into account local codes, requirements of the natural gas utility or propane supplier, and the requirements of the gas system being installed. All installations must be



Valencia Pipe Company

28839 Industry Drive

Valencia CA 91355

Phone: 661-257-3923

Fax: 661-257-3928

Email: info@homeflex.com

www.homeflex.com

Copyright © 2019, HOME-FLEX, LLC. HOME-FLEX® and the VPC logo are registered trademarks of Valencia Pipe Company, Inc. All rights reserved. 1604/E

Introduction

inspected by the local authority that oversees gas plumbing prior to the supplying of gas to the system.

HOME-FLEX® tubing and fittings are engineered and tested to work in combination. Using HOME-FLEX® CSST tubing or fittings with the tubing or fittings of other CSST flexible gas piping manufacturers is strictly prohibited and could lead to serious bodily injury or property damage.

Exposure to high voltage electricity may cause damage to CSST systems. Strict adherence to Section 4.10, "Electrical Bonding" (p. 37), will mitigate potential damage.

Wear gloves, eye protection, and suitable protective clothing when working with HOME-FLEX® CSST and fittings.

WARNING! If installed improperly, fire, explosion or asphyxiation may result. Installation instructions and applicable local codes must be strictly followed.

CALIFORNIA PROPOSITION 65 WARNING: This product contains one or more chemicals known to the State of California to cause cancer, birth defects, or other reproductive harm. **Wash hands after handling.**

1.2 Limitations of Manual

This *System Design and Installation Manual* is intended to assist the qualified gas pipe installer in the design, installation, and testing of the HOME-FLEX® flexible gas piping system for residential, commercial, and industrial buildings. It is not possible for this guide to anticipate every variation in construction style, building configuration, appliance requirement, or local restriction. This document will not cover every application. The user should either exercise his own engineering judgment on system design and installation, or seek technical input from qualified sources. Additional information on gas piping systems is available from your local gas utility or propane supplier. General usage guidelines of HOME-FLEX® flexible gas piping are outlined as follows:

The piping system is for use with fuel gases only and is intended for operating pressures not exceeding 25 PSI (172.5 kPa). The maximum actual operating pressure, including transients, shall not in any case exceed 30 PSI (207 kPa) for 5 PSI (34.5 kPa) rating.

Precautions shall be taken by the installer to ensure any exposed tubing is not damaged or abused during building construction or reconstruction.

Only the components provided or specified by Valencia Pipe Company, Inc. are to be used in the installation.

The size and depth of installation clearance holes or notches for routing the tubing through wall studs and joists shall comply with the requirements of the local building code.

Concealed tubing shall be protected from puncture threats, using the shielding devices specified by Valencia Pipe Company, at all points of penetration through studs, joists, plates or similar structures. The extent of protection shall be defined as follows:

- At points of penetration less than 2" (50.8 mm) from any edge of a stud, joist, plate, etc., a listed striker plate is required to provide protection at the area of support and within 5 in (127 mm) of each side (if appropriate) of the support.
- At points of penetration 2" - 3" (50.8 to 76.2 mm) from any edge of a stud, joist, plate, etc., a listed striker plate is required to provide protection throughout the area of support.
- At points of penetration greater than 3" (76.2 mm) from any edge of a stud, joist, plate, etc., no protection is required.
- Tubing routed horizontally through studs shall be protected from puncture threats between the studs using the shielding devices specified.

- Tubing greater than 1" (25.4 mm) inside diameter installed within hollow cavity walls of 2 x 4 construction shall be protected along the entire concealed length in the manner and using the shielding devices specified by Valencia Pipe Company.
- The width of the installed striker plate, at the points of penetration through wall studs, floor joists, plates, sills, etc., shall be at least 1.5 times the outside diameter of the tubing.

The inspection, testing and purging of the installation shall be performed using the procedures specified in Part 4, General, of the *National Fuel Gas Code* (ANSI Z223.1/NFPA 54), and/or the *Natural Gas and Propane Installation Code* (CSA B149.1), the *International Fuel Gas Code*, the *Uniform Plumbing Code*, or in accordance with the requirements of the applicable local codes. The installed gas piping system shall not exhibit any loss of pressure during the field pressure test.

When routing HOME-FLEX® tubing, sharp bends, stretching, and kinking or twisting of the tubing are to be avoided as these can damage the CSST tubing. The minimum permissible bend radius of HOME-FLEX® tubing is 1¼" (32 mm) for ½" tubing, 1⅝" (42 mm) for ¾" tubing, and 2" (51 mm) for 1" tubing. Under no circumstances is this minimum bend radius to be exceeded.

The piping system shall not be used as a grounding electrode for an electrical system.

1.3 Applicable Codes and Standards

Model codes which list CSST as an acceptable gas piping material:

ANSI/IAS LC-1 / CSA 6.26 Standard

CANADA-CSA B149.1 *Natural Gas and Propane Installation Code*

CANADA-CSA B149.2 *Propane Storage and Handling Code*

BOCA: *National Mechanical Code*

CABO: *One and Two Family Dwelling Code*

California Mechanical and Plumbing Codes

IAPMO: *Uniform Plumbing Code*

ICBO: *Uniform Mechanical Code*

ICC: *International Fuel Gas Code*

ICC: *International Mechanical Code*

ICC: *International Residential Code*

NFPA 54/ANSI Z 223.1 *National Fuel Gas Code*

NFPA 58: *Storage and Handling of LP Gases*

SBCCI: *Southern Building Code Congress International*

Tested to Code Requirements per ASTM E84 / UL 723

This *System Design and Installation Manual* has been written in accordance with the most current edition of ANSI LC1 CSA 6.26, *Fuel Gas Piping Systems using Corrugated Stainless Steel Tubing (CSST)*.



Items marked with the UPC logo are IAPMO certified for the United States and Canada.

Introduction



Items marked with the CSA logo are CSA certified for the United States and Canada.

NOTE: CSST approval from the above codes does not mean that CSST is approved for use in all localities. It is the installer's responsibility to confirm that CSST is accepted by the local authority with jurisdiction over the installation site. Valencia Pipe Company assumes no responsibility for materials or labor expenses incurred as a result of the installer not verifying local approval.

Chapter 2: Description of System Components

2.1 Tubing

The HOME-FLEX® fuel gas piping system employs corrugated, flexible, semi-rigid stainless steel tubing with brass attachment fittings terminating in NPT pipe fittings for integration into traditional rigid black pipe systems or direct connection to gas systems. Tubing is available in sizes of ½", ¾", and 1".

HOME-FLEX® tubing is jacketed with a yellow polyethylene cover clearly marked with gas pressure rating, and EHD* (Equivalent Hydraulic Diameter). Tubing is available in lengths of 25 (½" and ¾" only), 75, 150 (1" only), and 250-feet (½" and ¾" only).

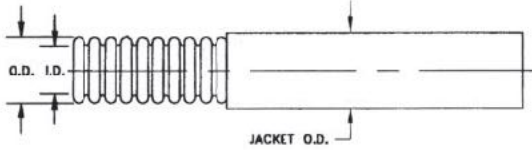

Part No.	Size (in)	EHD* (AGA Size)	Jacket OD (max)	Inside diameter (nom)	Wall Thickness
11-005	½"	18	0.76"	0.551"	0.01"
11-007	¾"	25	1.06"	0.827"	0.01"
11-010	1"	31	1.29"	1.06"	0.01"

* EHD (Equivalent Hydraulic Diameter): a relative measure of flow capacity. A higher EHD value indicates greater flow capacity of pipe.

Part No.	Size (in)	Length	
11-00525	½"	25'	
11-00575	½"	75'	
11-005250	½"	250'	
11-005500	½"	500'	
11-00725	¾"	25'	
11-00775	¾"	75'	
11-007250	¾"	250'	
11-007500	¾"	500'	
11-01075	1"	75'	
11-010150	1"	150'	

Description of System Components

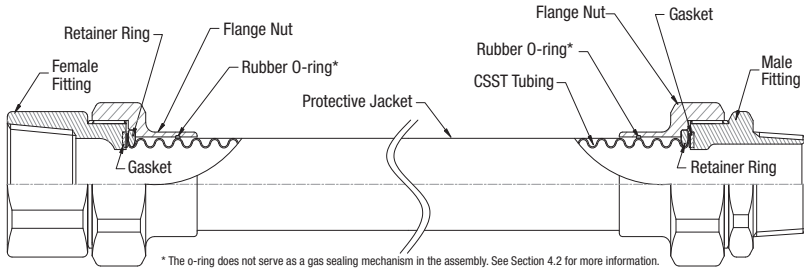

Figure 2.1 HOME-FLEX® Tubing and Fitting Assembly

2.2 Fittings



HOME-FLEX® fittings are available for ½", ¾", and 1" HOME-FLEX® tubing and allow for easy connection to gas systems and accessories using standard NPT threads. (See Figure 2.1)

In addition to standard NPT adapter fittings, the following are also available: reducer tees to integrate with different sized tubing runs, and special termination flanges for convenient gas appliance connections.

	Part No.	Description	
	11-436-005	½" Male NPT x CSST	
	11-436-007	¾" Male NPT x CSST	
	11-436-010	1" Male NPT x CSST	
	11-435-005	½" Female NPT x CSST	
	11-435-007	¾" Female NPT x CSST	
	11-435-010	1" Female NPT x CSST	
	11-429-101	¾" CSST x ½" Male NPT Reducer	
	11-429-005	½" Union (CSST x CSST)	
	11-429-007	¾" Union (CSST x CSST)	
	11-429-010	1" Union (CSST x CSST)	
	11-464-005	½" Termination Flange	
	11-464-008	¾" Termination Flange	

2.3 Striker Plates

Striker plates are used to protect CSST from puncture hazards when passed through studs, joists, and other building materials.

	Part No.	Description	
	11-3070SP	4" x 9" Striker Plate	

2.4 Pressure Regulators





Pressure regulators are used in elevated pressure system installations (over 14 inches water column, or 1/2 PSI) to reduce pressure to standard low pressure required for appliances.

	Part No.	Description
	Maxitrol 325-3L	1/2" NPT 7-11" w.c. Gas Line Pressure Regulator (250,000 Btu/hr max)
	Maxitrol 325-5AL	3/4" NPT 7-11" w.c. Gas Line Pressure Regulator (425,000 Btu/hr max)

Note: The regulators listed are for reference only. They are not distributed or supported by Valencia Pipe Company.

2.5 Manifolds

Manifolds allow for parallel installations of HOME-FLEX® tubing with runs to each appliance. Manifolds are available with 1/2" or 3/4" inlets and have four 1/2" or 3/4" NPT outlets.

	Part No.	Description	
	11-050504	1/2" x 1/2" x 1/2" Female NPT	
	11-070504	3/4" x 3/4" x 1/2" Female NPT	
	11-100704	1" x 1" x 3/4" Female NPT	

2.6 Shut-off valves and Quick-Connect Devices

At pressures less than 1/2 PSI (3.45 kPa), manual shut-off valves (ball valves) must comply with ANSI Z21.15 / CGA 9.1 *Manually Operated Gas Valves for Appliances, Appliance Connector Valves and Hose End Valves*, or with ANSI/ASME B16.44 *Manually Operated Metallic Gas Valves for Use in Above Ground Piping Systems up to 5 PSI*.





When operating at pressures at or exceeding 1/2 PSI, manual gas valves are to have a pressure rating of at least 5 PSI (34.5 kPa) and must comply with ANSI/ASME B16.33 *Manually Operated Metallic Gas Valves for Use in Gas piping Systems Up to 125 Psig*, or with IAS U.S. Requirement No. 3-88 *Manually Operated Gas Valve for Use in House Piping Systems*, or with CGA 3.16 *Lever Operated Non-Lubricated Gas Shut-Off Valves*, or with CGA 3.11 *Lever Operated Pressure Lubricated Plug Type Gas Shut-Off Valves*, or with CGA CR91-002 *Manually Operated Gas Valves for*

Description of System Components

Use on Gas Piping. Valves listed as complying with IAS U.S. Requirement 3-88 or CGA CR91-002 but not ASME B16.33 or CGA 3.11 are not to be installed outdoors.

Valves must be used in the following conditions:

- a) Gas appliances must have an accessible ½ PSIG manual shut-off valve upstream of connectors with a union to allow removal of appliance
- b) An accessible manual gas shut-off valve is required upstream of each pressure regulator on elevated pressure systems.

	Part No.	Description
	HFSB-1515	⅜" Female NPT Ball Valve 
	HFSB-2424	½" Female NPT Ball Valve 
	HFSB-3434	¾" Female NPT Ball Valve 
	HFSB-4444	1" Female NPT Ball Valve 

Quick-connect devices provide a safe and easy way to make connections to moveable outdoor gas appliances like barbecues and space heaters. Quick-connect devices used with HOME-FLEX® gas piping systems must conform to ANSI Z21.15, CGA 9.1, 9.2, 6.9 and AGA/CGA 7-90/CR94-001. A shut-off valve should be installed upstream of the quick-connect device and remain in the off position when the quick-connect device is not in use. All installations and devices must conform with local codes. Quick-connect devices that can be used with HOME-FLEX® gas piping systems include, but are not limited to, models in the M. B. Sturgis 3/375 family of products.

2.7 Bonding Clamps

Bonding clamps are used to connect the CSST gas piping system to the structure's existing grounding system. Connection is to be made to a HOME-FLEX® fitting or black-iron component nearest the gas service entrance of the building (see Section 4.10 on page 37). Connection is never to be made directly to the HOME-FLEX® tubing.

	Part No.	Description
	11-05BC	Bronze UL 467 listed bonding clamp for use with ½" and ¾" systems

2.8 Protection Devices

Like striker plates, HOME-FLEX® Flexible Protective Conduit is used to protect HOME-FLEX® tubing from puncture hazards.

	Part No.	Description
	11-12512	1¼" x 12" Flexible Protective Conduit (For use with ½" & ¾" CSST)



2.9 HOME-FLEX® Tubing Cutter

The HOME-FLEX® Tubing Cutter is specially designed to cut HOME-FLEX® and other brands of CSST, as well as aluminum, brass, copper, and stainless steel tubing. It can accommodate tubing with an outer diameter (O.D.) from 0.2" to 1.25".

	Part No.	Description
	11-TC-02125	Tubing Cutter designed for ½", ¾" and 1" HOME-FLEX® CSST
	11-TCB-02	Pack of 2 replacement blades

2.10 Replacement Parts

HOME-FLEX® fittings require a retainer ring, a non-metallic gasket, and an o-ring for proper assembly (see Figure 2.1 on page 6). Should any of these components be damaged or misplaced, packs of replacement rings are available.

	Part No.	Description
	11-057C	One each of replacement ring, gasket, and optional o-ring for ½" and ¾" fittings 
	11-10C	Two each of replacement rings, gaskets, and o-rings for 1" fittings 

2.11 HOME-FLEX® Appliance Connectors

HOME-FLEX® CSST cannot be used to make direct connections to moveable appliances like gas ranges or clothes dryers (see Section 4.6 on page 31). Connection to these appliances should be made from a HOME-FLEX® Termination Flange fitting to a HOME-FLEX® Appliance Connector, or comparable device. Appliance connectors are available coated and uncoated in lengths of 12, 18, 24, 30, 36, 48, 60 and 72 inches with a variety of end fittings. Browse the full product line at homeflex.com. Determine the correct appliance connector for your application by identifying the required length to connect the gas outlet to the appliance inlet and select the series that offers a maximum flow rate greater than the maximum demand of the appliance.

	Maximum Flow Rate in BTU/h (British Thermal Units per Hour) by Connector Series and Length					
	Length	HFHC 3/8" OD 1/4" ID	HFDC 1/2" OD 3/8" ID	HFRC 5/8" OD 1/2" ID	HFSA 1" OD 3/4" ID	
	12"	52k	117k	192k	481k	CSST
	18"	49k	110k	181k	458k	CSST
	24"	47k	104k	170k	436k	CSST
	30"	44k	97k	160k	414k	CSST
	36"	42k	90k	149k	391k	CSST
	48"	37k	77k	128k	347k	CSST
	60"	34k	70k	116k	323k	CSST
	72"	31k	64k	104k	300k	CSST

k = 1,000 BTU/h

EXAMPLE: 10k = 10,000 BTU/h = 10 CFH (Cubic Feet per Hour) of Natural Gas

Chapter 3: Sizing and Configurations

3.1 Configuration

Before routing HOME-FLEX® tubing, it is advisable to prepare a sketch from the building plans showing the locations of appliances to be serviced by the gas line, the load demands of each appliance, the point of delivery (location of gas meter or second stage liquid petroleum (LP) regulator), system pressure, and possible piping routes and lengths. Appliance load requirements can be obtained from the manufacturer's nameplate located on the appliance, or provided to you by the builder or contractor. Performing this sketch will ensure that you select the proper HOME-FLEX® tubing and accessories and avoid potentially costly corrections to the installation.

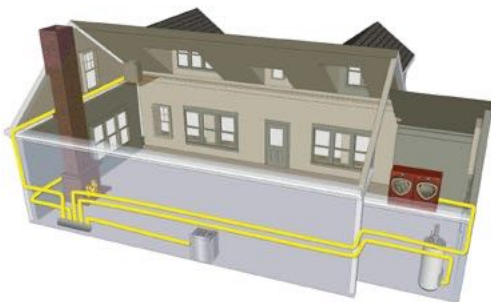

- a) Determine local piping restrictions prior to purchasing and installing HOME-FLEX® flexible gas tubing. In particular, confirm that the local administrative authority governing the installation location has accepted the use of yellow Corrugated Stainless Steel Tubing (CSST) flexible gas piping. While CSST is accepted by the major national and international code bodies, adoption of local codes can lag behind these bodies, and/or have special requirements in addition to the national codes.
- b) Determine the metered (supply) pressure of the gas source at the installation location.
 - i) Natural Gas
 - Standard low-pressure supply in North America is usually 6-7 inches water column (w.c.), alternatively designated as ¼ PSI.
 - Medium pressure supply, such as 14 inches w.c. (½ PSI) provides significant CSST size reduction. Check with the local gas utility for the availability of medium pressure. Most appliances distributed in the US and Canada are designed to operate up to 14 inches w.c.
 - Elevated pressure supply of 2 PSI is typically the highest pressure supplied within residential buildings in the US and Canada. Installations for systems of this pressure always require installation of a pounds-to-inches pressure regulator between the utility meter and the appliances.
 - ii) Propane (Liquefied Petroleum or LP) Gas
 - The pressure of LP systems are traditionally set to 11 inches w.c. at the second stage regulator of the system.
 - Like natural gas, elevated pressure settings from 14 inches w.c. to 2 and 5 PSI provide CSST size reductions. Check with the gas supplier for availability. For 2 PSI and greater, use a gas line pressure regulator set to 11 inches w.c. outlet pressure at the appliance side of the LP system.
- c) Determine the load demand of each appliance to be used at the installation location and the total load for all appliances to determine the total capacity needed for the installation. CFH/BTUH equivalents for natural gas or propane flow can be obtained from the local gas utility or propane supplier. The capacity tables within

Sizing and Configurations

this guide should be used to determine the tubing size required to meet BTUH input load requirements.

- For natural gas with a specific gravity of 0.60, one cubic foot per hour (1 CFH) is approximately 1,000 BTUH.
- For LP gas with a specific gravity of 1.52, one cubic foot per hour (1 CFH) is approximately 2,500 BTUH.

For any given system and its load requirements, there are several piping system designs available to the installer using HOME-FLEX® tubing. The sections below will outline several demand scenarios and the different system options open to the installer. It would be impossible to outline all the possible installation methods. It is the installer's responsibility to use the information supplied here to determine the best routing solution, using these examples as a guide.

Low Pressure Systems

In low pressure systems, there are two installation options: series layouts where a main run from the gas source splits to each appliance, and parallel layouts where the main run from the gas source leads to a central distribution manifold from which individual runs service the appliances.

Low Pressure Series Systems

Series systems are the most commonly used layout for black steel pipe installations with low pressure supplies. In series layouts, a main run from the gas source is branched with tees to each appliance. The service pressure downstream of the meter is typically less than ½ PSI.

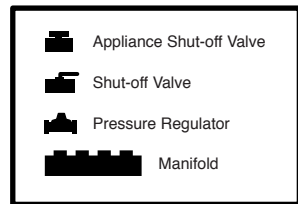

Figure 3.1 Routing Diagram Key

It is important to consider the minimum pressure supplied to any given appliance in a series layout. Most natural gas appliances require a minimum of 4" w.c. pressure, while LP appliances require a minimum of 10" w.c. pressure. Local code restrictions may dictate allowable pressure drop along any particular run.

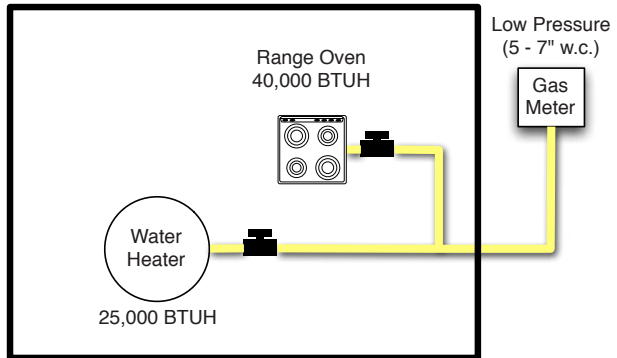

Figure 3.2 A low pressure series layout

Low Pressure Parallel Systems

Parallel systems have a central distribution manifold with branch runs to the appliances. Typically, a main supply line is run from the gas supply to a manifold and "home runs" are routed to each appliance location. Manifold stations are located as close as possible to the

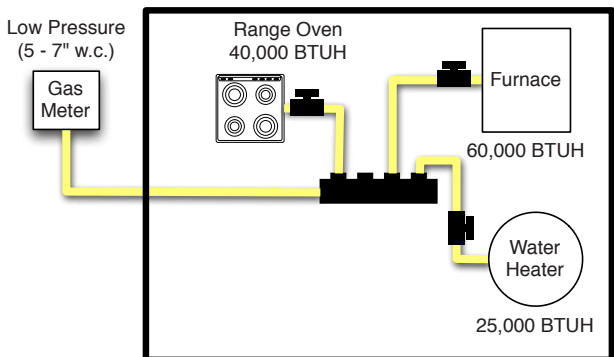

Figure 3.3 A low pressure parallel layout

appliance(s) with the greatest load. Parallel layouts are most commonly used in $\frac{1}{4}$ to $\frac{1}{2}$ PSI systems.

Dual Pressure Systems

Elevated pressure systems generally have a main line from the gas supply to one or more gas pressure regulators and then a manifold with "home runs" to appliances. These runs may branch off through use of a tee, if gas loads permit.

Elevated Pressure System

It is also possible to have a complete elevated pressure system where the pressure regulators are positioned at each appliance. This method is typically employed in systems with high loads or long runs.

Multiple Manifold System

Another variant used with elevated pressure is to have multiple manifolds, each with a regulator before the manifold. This approach allows for large BTU load demands while using smaller diameter tubing.

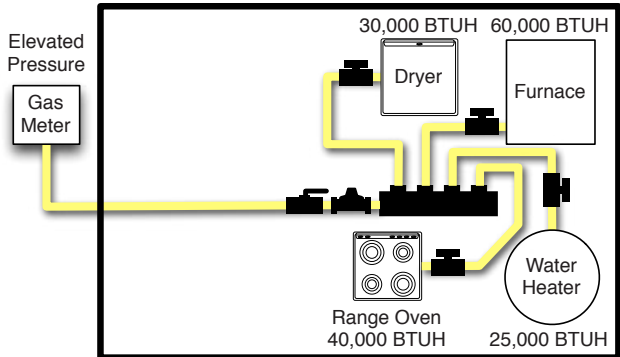

Figure 3.4 A dual pressure system layout

Hybrid Systems (Rigid pipe and CSST)

The use of both CSST and rigid black pipe can be advantageous to minimize the pressure drops typically encountered on systems with high loads or long runs. For example, a parallel system could require a larger diameter main branch to provide the total appliance load. HOME-FLEX® is certified for use with black steel pipe and copper tubing gas piping systems.

3.2 Sizing Methods and Examples

This section will outline sizing procedures under several different circumstances to demonstrate how to select the proper size and configuration of HOME-FLEX® flexible gas tubing. These examples are presented to demonstrate the process of using sizing tables to determine necessary pipe size and configuration. Every installation is different and this requires that the installer go through the processes outlined below for the proper sizing and configuration of the gas piping system given the circumstances and requirements at the installation location.

Sizing Tables

All piping systems introduce pressure loss, the amount of which depends on the piping size and the gas flow (in cubic feet per hour). When "sizing" a system, the installer determines the smallest size piping that will deliver the flow required given the allowable amount of pressure drop. Sizing tables provide the maximum load for a run given the gas pressure, allowable pressure drop, size of pipe and the length of the run. Different sizing tables are used for each combination of system pressure and pressure drop.

Allowable pressure drop is the maximum pressure loss that can occur and maintain supply pressure for proper equipment or appliance operation. Natural gas appliances are generally designed to function with a minimum pressure of 4 inches w.c. LP appliances are generally designed for a minimum pressure of 10 inches w.c. The sizing tables in this guide should be used to provide no less than 5 inches w.c. to natural gas appliances and 10.5 inches w.c. to LP appliances.

Sizing and Configurations

Allowable pressure drop can be calculated by subtracting the desired appliance inlet pressure (recommended 5 inches w.c. for natural gas and 10.5 inches w.c. for propane) from the gas source pressure (gas meter for natural gas or the secondary regulator for LP).

Low pressure series systems are sized using the "longest length method" (also known as the "branch length method") in the same manner as low pressure black steel pipe systems. Tables from the *National Fuel Gas Code* (NFPA 54) are used to calculate the sizing. Pressure drop in a low pressure system is usually limited to ½ inch w.c.

For elevated pressure systems, there are two operating pressures downstream of the gas source: the pressure set by the service regulator at the meter (usually 2 PSI) which leads to the pounds-to-inches regulator. The proper drop between the meter and the regulator is usually 1 PSI, allowing a ¾ PSI regulator drop downstream while providing the ¼ PSI (6-7 inches w.c.) required for appliances. Between the regulator and the appliances, sizing is calculated like low pressure systems with the exception that the allowable pressure drop is 3 inches w.c., typically sized for one appliance installed as a "home run" from the manifold.

Low Pressure systems (Longest Length/Branch Method)

Sizing of the following systems is done by section. Each section is sized by determining the total gas load for all appliances and the maximum distance (longest length) over which a section delivers gas.

Example 1: Low Pressure System in a Series Arrangement (Figure 3.5)

In this installation, a small number of appliances are located near the natural gas source in one general area. The short runs and low appliance load make it ideal for a series arrangement.

Length of Runs: A = 12' B = 8' C = 15'
Supply Pressure: 6" w.c.
Pressure Drop: 0.5" w.c.

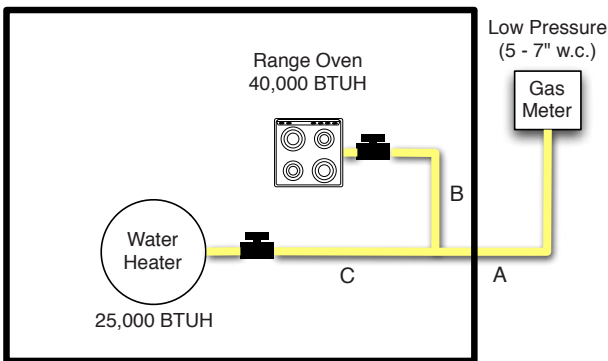

Figure 3.5 Low Pressure System—Series Arrangement

Step 1 Size Section A: Determine the longest run from the source that includes section A and the total gas load it must deliver.

- Meter to range oven is 20 feet (A + B).
- Meter to water heater is 27 feet (A + C).
- Maximum load carried by section A is 65,000 BTUH (range + water heater). Convert to CFH by dividing by 1000 (for natural gas with a specific gravity of 0.60, 1 CFH = 1,000 BTUH). Maximum load is 65 CFH.
- Find the maximum capacity table that matches the system characteristics, in this case, natural gas with a minimum gas pressure of 6-7 inches w.c. and a pressure drop of 0.5 inches w.c. Table 7.1 is the correct table.
- Find the column in the length row that is greater than or equal to the longest run in the system. The longest run in this system is 27 feet and the table has columns for 25 and 30 feet. **Never round down when sizing.** The correct column is 30 feet.
- We then scan down the 30 feet column searching for a CFH value that is greater than or equal to the total load of the system. At 30 feet, ½" tubing has a maximum

load of 42 CFH so it is not suitable for this system. The next size is $\frac{3}{4}$ " with a maximum load of 116 CFH. $\frac{3}{4}$ " tubing is the correct size for section A.

Step 2 Size Section B: Determine the length of the run from the meter to the range oven and the load delivered.

- The length from the meter to the range oven is 20 feet (A + B), and the load is 40 CFH (40,000 BTUH divided by 1000 CF per BTUH).
- Consulting Table 7.1, we see that for a 20-foot run, $\frac{1}{2}$ " tubing will supply up to 51 CFH. The correct size tubing for section B is $\frac{1}{2}$ ".

Step 3 Size Section C: Determine the length of the run from the meter to the water heater and the load delivered.

- The length is 27 feet (A + C) and the load is 25 CFH (25,000 BTU).
- Consulting Table 7.1, we see that for a 30-foot run, $\frac{1}{2}$ " tubing will supply up to 42 CFH. The correct size for section C is $\frac{1}{2}$ ".

Example 2: Medium Pressure in a Parallel Arrangement

This system is typical of a single family residential installation with several appliances. As it is a medium-pressure system, the allowable pressure drop of 6 inches w.c. is greater than what would have been permissible in a low pressure system.

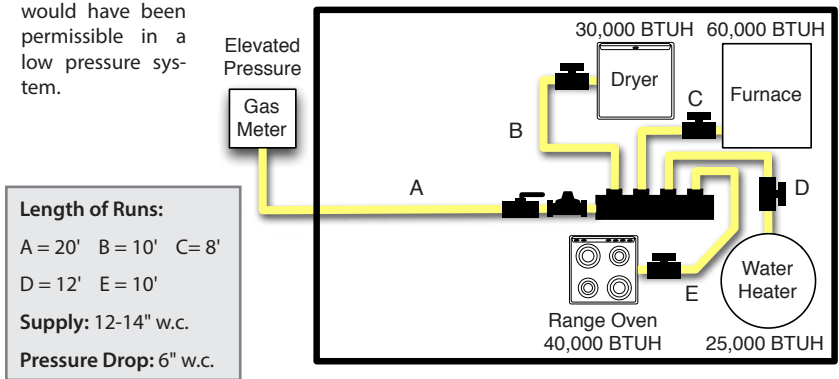

Figure 3.6 Medium Pressure System—Parallel Arrangement

Step 1 Size Section A: Determine the longest run from the meter to any appliance:

- Meter (A) to water heater (D) is the longest run at 32 feet.
- The maximum load transported by section A is the total load of all appliances: dryer + furnace + water heater + range oven = 155,000 BTU = 155 CFH.
- Consulting Table 7.4, the columns nearest 32' are 30' and a 40'. Because we must use the length value that is greater than or equal to the measured run, the 40' column is correct. Our total load is 155 CFH, and $\frac{1}{2}$ " tubing has a total maximum capacity of 116 CFH at 40 feet, which is not enough for this system. $\frac{3}{4}$ " Tubing has a maximum capacity of 398 CFH. $\frac{3}{4}$ " Tubing is the correct size.

Step 2 Size Section B: Determine the length from the meter to the dryer:

- A + B = 30 feet and the total load is the load of the dryer is 30,000 BTUH = 30 CFH.
- Table 7.4 shows that $\frac{1}{2}$ " tubing has a total load capacity of 133 CFH at 30 feet, exceeding the load of the dryer, so $\frac{1}{2}$ " tubing is the correct size.

Step 3 Size Section C: Determine the length from the meter to the Furnace.

- A + C = 28 feet, and the total load is 60,000 BTUH = 60 CFH.

Sizing and Configurations

- Table 7.4 shows that ½" tubing has a total load of 133 CFH at 30 feet, so ½" tubing is the correct size.

Step 4 Size Section D: Determine the length from the meter to the water heater.

- $A + D = 32$ feet, and the load of the water heater is 25,000 BTUH = 25 CFH.
- Table 7.4 shows that ½" tubing has a total load capacity of 116 CFH at 40 feet, so ½" tubing is the correct size.

Step 5 Size Section E: Determine the length from the Range oven to the Furnace.

- $A + E = 30$ feet and the load of the furnace is 40,000 BTUH = 40 CFH.
- Table 7.4 shows that ½" tubing, with a maximum capacity of 133 CFH, is correct.

Elevated Pressure Systems

Example 3: Elevated Pressure System in a Parallel Arrangement

In this example, an extended tubing run is required from the gas meter to the desired appliance locations. This scenario is common in single and multifamily locations. 2 PSI elevated systems are ideal for the long runs required in multifamily buildings that have a central gas meter bank.

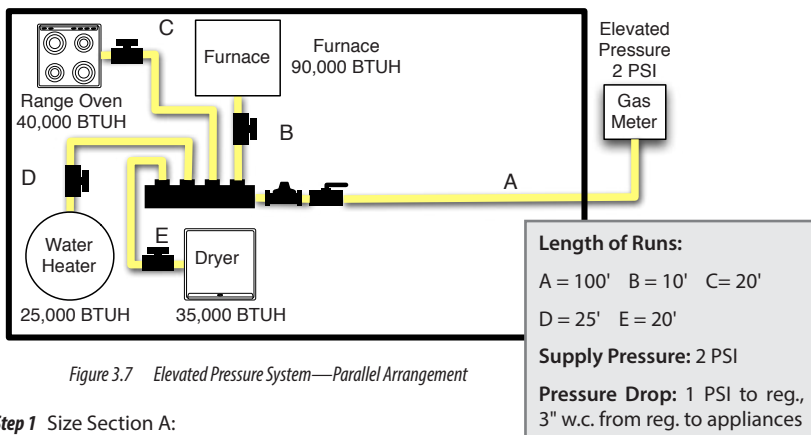

Figure 3.7 Elevated Pressure System—Parallel Arrangement

Step 1 Size Section A:

- Maximum load = furnace + range oven + water heater + dryer = 190,000 BTU = 190 CFH and the distance to the regulator is 100 feet.
- Supply pressure is 2 PSI and allowable drop is 1 PSI. Table 7.5 is the correct table.
- Scanning the 100' column, ½" tubing has a maximum capacity of 129 CFH which is not adequate. ¾" Tubing has a maximum capacity of 471 CFH. As this meets or exceeds our required capacity of 190 CFH, ¾" tubing is the correct size.

Step 2 Size Sections B-E: From the regulator outlet, the system is supplying 8 inches w.c. with an allowable drop of 3 inches w.c. Table 7.3 is the correct table for this section of the system.

- Section B is 10 feet with an appliance load of 90 CFH for the furnace. ½" Tubing has a maximum capacity of 160 CFH at 10 feet, so ½" is the correct size.
- Section C is 20 feet with an appliance load of 40 CFH for the range oven. ½" Tubing has a maximum capacity of 116 CFH at 20 feet, so ½" is the correct size.
- Section D has a length of 25 feet with an appliance load of 25 CFH. ½" Tubing has a maximum capacity of 104 CFH at 25 feet, so ½" is the correct size.
- Section E has a length of 20 feet with an appliance load of 35 CFH. ½" Tubing has a maximum capacity of 116 CFH at 20 feet, so ½" is the correct size.

Example 4: Medium Pressure Parallel Arrangement with a Series Branch

This installation has a barbecue installed near the water heater. Given the number of appliances, a parallel arrangement was selected for the system, with a single run supplying the barbecue and the water heater in series.

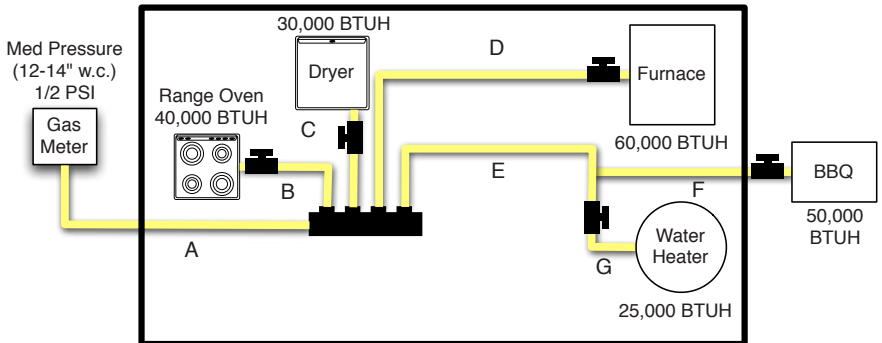

Figure 3.8 Medium Pressure System—Parallel Arrangement with Series Branch

Step 1 Size Section A: Determine the length of the longest run (from gas meter to appliance) and total load required by the system.

- Total system load = range + dryer + furnace + water heater + BBQ = 205,000 BTUH = 205 CFH.
- Longest run is from meter to the BBQ: $A + E + F = 60$ feet.
- Supply pressure is 12-14 inches w.c. ($\frac{1}{2}$ PSI), and allowable pressure drop is 6 inches w.c., so Table 7.4 is the correct table.
- At a length of 60 feet, $\frac{1}{2}$ " tubing can supply a maximum of 96 CFH. The system requires at least 205 CFH, so $\frac{1}{2}$ " is too small. $\frac{3}{4}$ " Tubing can supply a maximum of 329 CFH. $\frac{3}{4}$ " Tubing is the correct size.

Length of Runs:

A = 25' B = 10' C = 10' D = 20'

E = 20' F = 15' G = 5'

Supply Pressure: 12-14" w.c.

Pressure Drop: 6" w.c.

Step 2 Size Section B: Measure the length from the meter to the range to determine appropriate size.

- Total length is 35 feet (A + B), and appliance load is 40 CFH.
- 35 feet is not an option on the table, so we round up to 40 feet. $\frac{1}{2}$ " Tubing has a maximum capacity of 116 CFH at 40 feet, so $\frac{1}{2}$ " is the correct size for this run.

Step 3 Size Section C: Determine the length from meter to the dryer:

- Total length is 35 feet (A + C) and appliance load is 30 CFH for the dryer.
- $\frac{1}{2}$ " Tubing has a maximum capacity of 116 CFH at 40 feet so $\frac{1}{2}$ " is the correct size.

Step 4 Size Section D: Determine the length from the meter to the furnace.

- Total Length is 45 feet (A + D) and appliance load is 60 CFH.
- $\frac{1}{2}$ " Tubing has a maximum capacity of 104 CFH at 50 feet so $\frac{1}{2}$ " is the correct size.

Step 5 Size Section E: Determine the longest length and total load for the section. As there are two appliances serviced by this run, it is calculated as a series layout like Example 1.

- Section E serves both the water heater and BBQ, so total load is 75 CFH.
- The longest length is from the meter to the BBQ (A + E + F) = 60 feet.
- $\frac{1}{2}$ " Tubing has a maximum capacity of 96 CFH at 60 feet so $\frac{1}{2}$ " is the correct size.

Sizing and Configurations

Step 6 Size Section F: Determine the total length and load.

- The BBQ load is 50 CFH and the length is 60 feet (A + E + F).
- ½" Tubing has a maximum capacity of 96 CFH at 60 feet so ½" is the correct size.

Step 7 Size Section G: Determine the total length and load.

- The water heater load is 25 CFH and the length is 50 feet (A + E + G).
- ½" Tubing has a maximum capacity of 104 CFH at 50 feet, so ½" is the correct size.

Hybrid CSST & Black Iron Rigid Pipe Systems

In low and medium pressure systems with high loads and/or long runs, it can be advantageous to use both black steel pipe and HOME-FLEX® tubing to minimize pressure drops.

Sizing Hybrid HOME-FLEX® and Black Iron Systems

Proper sizing of hybrid HOME-FLEX® and rigid black steel pipe requires the use of the standard gas piping capacity tables used for black steel pipe (these can be found in many plumbing and mechanical codes as well as the *National Fuel Gas Code*) as well as the HOME-FLEX® capacity tables in this manual. For your convenience, a black steel capacity table for sizing is printed in Table 7.11 (p. 49) of this book.

Example 5: Low Pressure Hybrid System in a Series Arrangement

The system in Figure 3.9 is a commercial building with three unit heaters and a water heater. The source is standard low pressure with a 6 inch w.c. supply and 0.5 inch w.c. maximum allowable pressure drop. Sizing this system requires sizing the rigid black pipe section as well as the HOME-FLEX® CSST runs to the appliances.

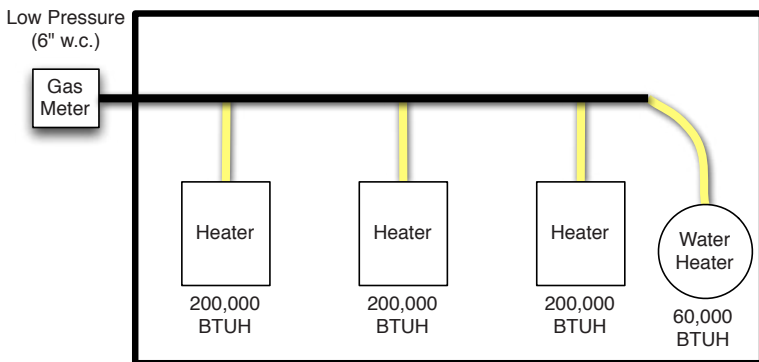

Figure 3.9 Low Pressure Hybrid System—Series Arrangement

Step 1 Size the rigid black steel pipe: Determine length of longest run and total load.

- The longest run from the meter is A1 + A2 + A3 + A4 + E = 70 feet.
- Total load is 600,000 BTUH = 600 CFH. Consulting Table 7.11, at a 70 foot length, the diameter of black steel pipe that can supply 600 CFH or greater is 1½" with a maximum capacity of 750 CFH. The correct size for section A1 is 1½".
- To size section A2, we can reduce the load already carried by A1, in this case 200 CFH from the first heater. The length, however, remains 70 feet. Total load then is

Length of Runs:

A1 = 10' A2 = 20' A3 = 20' A4 = 5'

B = 10' C = 10' D = 10' E = 15'

Supply Pressure: 6" w.c.

Pressure Drop: 0.5" w.c.

400 CFH, which at 70 feet can be supplied by 1¼" pipe with a maximum capacity of 490 CFH. 1¼" pipe is the correct size for section A2.

- To size section A3, we can reduce the load by another 190 CFH to 210 CFH for the remaining heater and the water heater. At 70-feet, 1" pipe can supply a maximum of 240 CFH, which is sufficient for the run. 1" pipe is the correct size.
- To size section A4, the load is reduced to just the 60 CFH of the water heater. At 70-feet, ½" pipe can provide a maximum capacity of 61 CFH. ½" pipe is the correct size for section A4.

Step 2 Size Section E: The length is the length of the black pipe plus the length of the HOME-FLEX® run = 70 feet, and total load is 60 CFH. Referencing Table 7.1, ¾" tubing provides a maximum capacity of 76 CFH at 70 feet. ¾" Tubing is the correct size for section E.

Step 3 Size Section D: The length is the length of the black pipe up to the branch and the length of the HOME-FLEX® run = A1 + A2 + A3 + D = 60 feet. Load is the load of the heater, 150 CFH. At 60 feet, 1" inch CSST can provide a maximum capacity of 156 CFH. 1" is the correct size.

Step 4 Size Section C: The length is 40 feet and total load is 190 CFH. At 40 feet, 1" tubing provides a maximum of 195 CFH. 1" Tubing is the correct size.

Step 5 Size Section B: The length is 20 feet and total load is 200 CFH. At 20 feet, 1" tubing is required to provide at least 200 CFH, with a maximum capacity of 288 CFH.

Chapter 4: Installation Practices

4.1 General Practices

HOME-FLEX® CSST flexible gas piping material must be installed by a Qualified Installer who has been certified in the use of the HOME-FLEX® gas piping system. Installers must meet applicable qualifications set forth by the state and/or local administrative authorities which enforce the plumbing, mechanical, electrical and/or building codes at the locale where the gas piping is to be installed. A HOME-FLEX® Qualified Installer Card is required to install HOME-FLEX® CSST. For more information on certification please see Section 1.1 on page 1.

All HOME-FLEX® tubing and components should be stored such that they are not damaged or exposed to water, debris, or chemicals. During the installation and construction process, care must be taken to ensure that exposed tubing is not damaged.

Only components provided or specified by Valencia Pipe Company are to be used as part of the HOME-FLEX® gas piping system. Do not use HOME-FLEX® tubing or HOME-FLEX® fittings with the tubing or fittings of another CSST brand or manufacturer. Connections between different brands of CSST may be made through the use of standard malleable iron fittings.

During installation, any open ends of HOME-FLEX® tubing are to be temporarily plugged, taped, or otherwise sealed to prevent the entrance of dirt, dust, or other debris into the gas system.

Contact with sharp objects or substances harmful to the CSST or yellow protective jacket must be avoided. The protective jacket should be kept in place as much as possible to protect the tubing from corrosive threats. Contact with chemicals containing chlorides or ammonia (such as fluxes or acid based cleaners) must be followed by a thorough rinse and dry. Only non-corrosive leak detection fluids should be used when testing for leaks.

Take care to avoid unnecessary stress or strain on HOME-FLEX® tubing and fittings. While the ability to bend HOME-FLEX® tubing is a main feature in its installation convenience, there is a minimum bend radius that should never be exceeded as it could damage the tubing. Multiple tight bends can restrict gas flow, leading to the increased pressure drop. HOME-FLEX® tubing should never be stretched, kinked, or twisted. Bends should be of as large a radius as possible to maximize gas flow and reduce risk of damage to CSST. Figure 4.1 demonstrates how the radius of a bend is calculated. Table 4.1 lists the absolute and recommended minimum bend radii for HOME-FLEX® tubing.

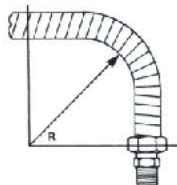

Figure 4.1 Bend Radius (R)

Tubing Size	Absolute Minimum Bend Radius (R)	Recommended Min. Bend Radius (R)
½" (13 mm)	1¼" (32 mm)	3" (75 mm)
¾" (19 mm)	1⅝" (42 mm)	
1" (25 mm)	2" (51 mm)	5" (125 mm)

HOME-FLEX® tubing must be supported with approved pipe straps, bands or hangers suitable for the size and weight of the tubing, at intervals not to exceed those shown in Table 4.2. Tubing should not be supported by, or run near, conductive metallic systems such as metallic appliance vents, ducting, or piping. Electrical cables must be avoided and cannot be used as supports. Tubing is considered supported if it passes through or over a structural component of the building.

Tubing Size	Horizontal Support Spacing	Vertical Support Spacing
½" (13 mm)	6 ft.	10 ft.
¾" (19 mm)	8 ft. (USA) 6 ft. (CAN)	
1" (25 mm)		

4.2 Fitting Assembly

HOME-FLEX® fittings achieve seal by compressing the tubing into the gasket (Figure 4.2). It is critical that the cut end of the tubing is clean of any burrs or jagged edges, and that there is no debris on the tubing or gasket. A seal is achieved with a good deal of force (Table 4.3). In the absence of a torque wrench, the general guideline is to tighten with two wrenches (one holding the fitting in place, the other turning the flange nut counter-clockwise) until the nut will no longer turn and only 2-3 threads are showing.

Table 4.3 Recommended Force for HOME-FLEX® Fitting Assembly

Tubing Size	Torque Value
½" (13 mm)	62 lb-ft
¾" (19 mm)	62 lb-ft
1" (25 mm)	74 lb-ft

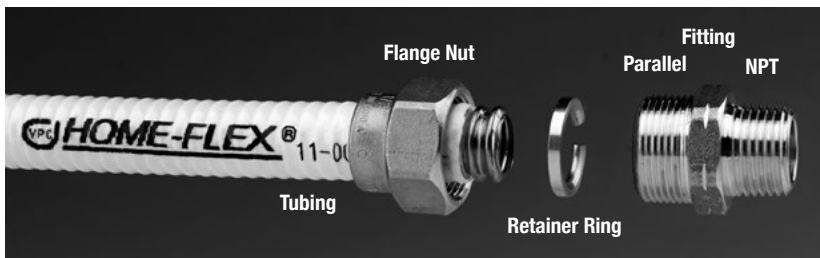

Figure 4.2 (1) Gasket in Fitting Before Assembly, (2) After Assembly (note groove in gasket), (3) Fitting with and without o-ring; and (4) Compressed Tubing

Note: The gasket can only be used once. Once it has been compressed (Figure 4.2) during the assembly process, it cannot be reused. A new gasket must be installed in the fitting

Note: Not all fittings include an o-ring (Figure 4.2-3). The o-ring does not function as a gas sealing mechanism in the fitting assembly. The o-ring keeps moisture and corrosives out of the area between the tubing and fitting flange. If the o-ring is misplaced or not present and there is risk of outside moisture or contaminants entering the assembly, wrap with the assembly with self-bonding silicone tape from the tubing jacket to the end of the nut flange.

Male, Female, Union and Tee Fitting Assembly Overview



Male, Female, Union and Tee Fitting Assembly

Step 1 Cut HOME-FLEX® tubing to length

Using a stainless steel rated tube cutter, cut the HOME-FLEX® tubing to the desired length, leaving at least 1 extra inch for placement of the fitting. Cut in the valley of the tubing and clean any burrs or jagged edges. Cut in full circular strokes in one direction, tightening gradually after each rotation. Be careful to not overtighten the roller as it could flatten the HOME-FLEX® tubing.



Step 2 Remove tubing jacket to prepare for fitting assembly

Using a utility knife, strip the yellow pipe jacket back 2 valleys from the end of the tubing.

DO NOT USE A TUBE CUTTER FOR THIS TASK AS IT COULD DAMAGE THE TUBING.

Step 3 Place flange nut over HOME-FLEX® tubing

Slide the HOME-FLEX® flange nut over the tubing with the threaded end pointing toward the end of the tubing. The flange should cover the yellow tubing jacket.



Step 4 Place retainer ring on HOME-FLEX® tubing

Place the retainer ring in the first valley of the tubing. Being careful to not dent the tubing, clamp the ring in place by applying gentle pressure 360° around the ring. It should fit tightly and not easily spin around the tubing.

Male, Female, Union and Tee Fitting Assembly

Step 5 Install HOME-FLEX® fitting in destination (manifold, pipe system, fixed appliance, etc.)

Make sure that the gasket inside the HOME-FLEX® fitting is secure on the socket. Apply a pipe sealant to the tapered (NPT) thread of the fitting and install it in the gas system.

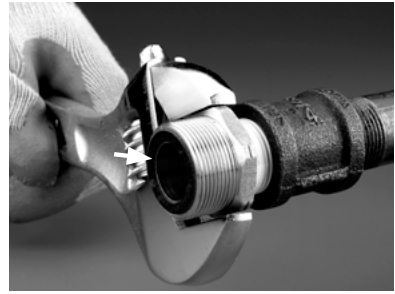

Step 6 Attach flange nut to the installed HOME-FLEX® fitting

Place the HOME-FLEX® flange nut onto the installed fitting. Hand tighten the fitting assembly from the nut-end being sure that only the nut turns (the fitting and tubing should not turn). Then tighten to the recommended torque value in Table 4.3 (p. 21) using a second wrench to hold the fitting in place (generally, tighten with force until the nut will no longer turn).

DO NOT use sealant on the parallel thread (gasket side) of the socket.



Termination Fitting Assembly Overview (Parts 11-464-XXX)

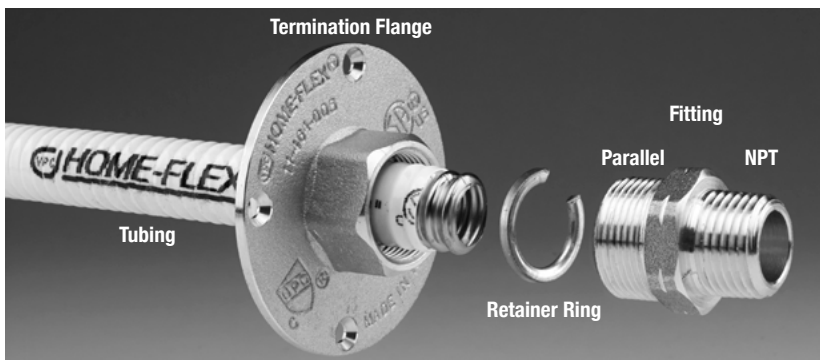

Termination Fitting Assembly (Parts 11-464-XXX)

Step 1 Cut HOME-FLEX® tubing to length

Route CSST through structure to the desired location of the termination flange. Bend tubing as required so it exits the structure in desired direction of the termination plate. Cut the excess CSST so about 2" of tubing extends beyond the wall.



Step 2 Remove tubing jacket to prepare for fitting assembly

Using a utility knife, strip the yellow tubing jacket back 2 valleys from the end of the tubing. Also remove the yellow warning label from the fitting assembly.

DO NOT use a tube cutter.

Step 3 Place flange nut over HOME-FLEX® tubing

Slide the termination flange over the tubing with the threaded end pointing toward the end of the tubing.

DO NOT SECURE THE FLANGE.



Step 4 Place retainer ring on HOME-FLEX® tubing

Place the retainer ring in the first valley of the tubing. Being careful not to dent the tubing, clamp the retainer ring in place by applying gentle pressure 360° around the ring. It should fit tightly and not easily spin around the tubing.

Termination Fitting Assembly (Parts 11-464-XXX)

Step 5 Place fitting and assemble flange

Pull termination flange toward end of tubing so it catches on the retainer ring, ensuring that the retainer ring and flange are flush. The base of the flange should be parallel with tubing corrugation. DO NOT use sealant tape or pipe dope on parallel threads between flange and fitting.

Hold the fitting on the NPT thread and attach to termination flange by turning the flange counter-clockwise onto the fitting, being sure the tubing and flange do not move. Hand tighten.



Step 6 Tighten the flange assembly

Complete tightening with two wrenches to suggested torque values in Table 4.3 (p. 26), holding the fitting fixed with one wrench while turning the flange counter-clockwise with the other, being sure that the tubing does not rotate. Push the assembly back flush to the wall and secure with screws.

Troubleshooting Fitting Connections

Step 1 Gradually tighten fitting until leak stops.

Step 2 If leak does not stop after reaching maximum torque, stop, open the assembly and check for:

- a) Proper fitting assembly. Make sure the gasket is installed in the base of the parallel thread of the fitting. If it was not, install the gasket, repeat assembly steps, and test for leaks again. **Gaskets cannot be reused: if it was installed, replace it with a new gasket and continue to step 2b.**
- b) Check for any obstructing material (dirt, shavings, jacket, etc.) in assembly. Remove material and reassemble, checking for leaks again.
- c) Integrity of assembly pieces. If the retainer ring or the gasket are cracked, misshapen or otherwise damaged, replace them and repeat assembly.

Note: DO NOT use sealing solution on parallel thread (gasket end) of fitting assembly. Gaskets cannot be reused, and must be replaced if fitting assembly is disassembled.

4.3 Routing

General Routing Practices

Routing requirements for CSST flexible gas pipe can vary by locality. Be sure to confirm the requirements of the administrative authority for the location where HOME-FLEX® is to be installed before installing HOME-FLEX®. In general, HOME-FLEX® can be routed:

- Beneath, through, and along side floor and ceiling joists. This is typical for residential and commercial installations with basements or multi-floor routing.

Installation Practices

- Inside hollow interior wall cavities. Routing inside wall cavities is preferred for vertical sections of tubing. Horizontal runs through wall cavities should be avoided to minimize the need for striker protection from puncture hazards.
- Through approved conduit underground or under building slabs. Under no circumstances is HOME-FLEX® to be routed underground or under slab unless it is routed within a nonmetallic water-tight conduit that is at least 1/2" larger than the outer diameter (OD) of the CSST tubing. Fittings and joints are not permissible in such runs—the run must be one unbroken line of tubing. Runs underneath slabs must be sleeved and vented per local codes.
- Outdoors. When installed outdoors, the yellow jacketing of HOME-FLEX® must be intact along the entire run and protected from long term exposure to UV rays from the sun. Any areas of exposed tubing are to be wrapped with self-bonding silicone tape or sleeved to prevent threats from acids or chlorides.
- Along the perimeter of a building. Care must be taken to protect HOME-FLEX® from the possibility of mechanical damage when installed along the exterior of a building. If installed within 6 feet of the ground, HOME-FLEX® tubing must be routed within a conduit or chase. If installed in a location where the tubing will not be subject to possible mechanical damage, a conduit is not required, but is recommended.

Tubing should not be supported by, or run near, conductive metallic systems such as metallic appliance vents, ducting, or piping.

Careful consideration should be given to route HOME-FLEX® tubing in areas where mechanical damage is least likely.

Clearance Holes and Notching

Clearance holes for routing tubing through studs, joists, plates, etc. must have a diameter at least 1/2" larger than the outside diameter of the tubing (Table 4.3). Local codes pertaining to structural members must be followed when drilling clearance holes—no structural members should be compromised, weakened or impaired by cutting, notching, drilling, or otherwise alternating the member.

Tubing Size	Drill Hole Size
1/2" (13 mm)	1 3/8" (35 mm)
3/4" (19 mm)	1 1/2" (38 mm)
1" (25 mm)	1 3/4" (45 mm)

Routing through holes in joists, rafters or similar wood structures

When HOME-FLEX® tubing is installed through bored holes in joists, rafters, or other wood structures, the holes should be bored such that the edge of the hole is at least 2 inches from the nearest edge of the wood structure (Figure 4.3). If this criterion can't be met, the tubing must be protected by a striker plate of suitable size installed in accordance with Section 4.4 (p. 29). The diameter of the hole should be no more than 1/3 the depth of the wood structure.

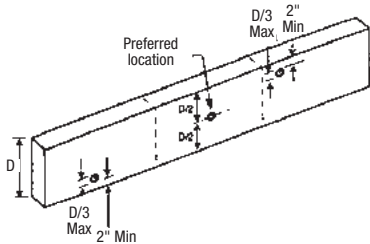

Figure 4.3 Holes in Wood Structures

Holes and Cuts in Top and Sole Plates

Holes bored through top plates, top frame members and sole plates should not exceed 50% of the width of the structure, and should be in the center of the structure. If a sole or plate is to be cut for the routing of HOME-FLEX® tubing, the width of the cut should be 1/2" greater than the outside diameter of the tubing and no greater than 2 inches (Figure 4.4). Tubing must be protected with striker plates in accordance with Section 4.4.

Routing through vertical wall framing

Requirements for boring through vertical members of wall framing differ depending on whether the member is bearing or not. For non-bearing members (Figure 4.5), the size of the hole should be no larger than 60% of the width of the member. For bearing members, the size of such hole should be no more than 40% of the member. (Figure 4.6)

Routing through metallic surfaces

When installing HOME-FLEX® through galvanized steel studs, plastic grommets (often supplied by the stud manufacturer) should be used to reduce potential damage to the yellow jacket of the HOME-FLEX® tubing. When installing through

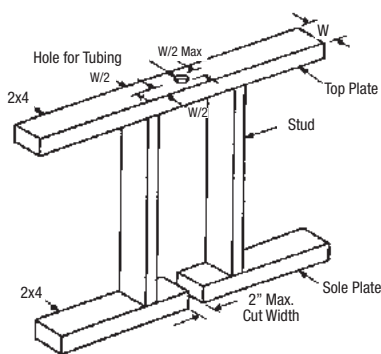

Figure 4.4 Holes and Cuts in Top and Sole Plates

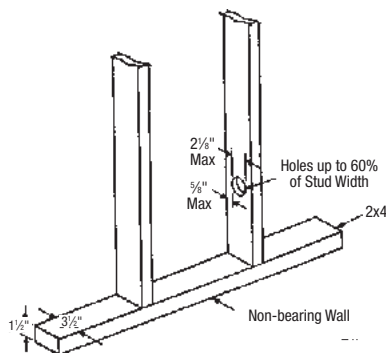

Figure 4.5 Holes in Non-Bearing Walls

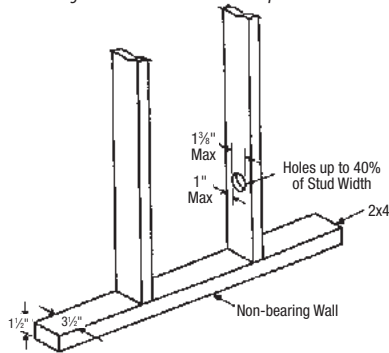

Figure 4.6 Holes in Bearing Walls

holes in other metallic members, the tubing must be similarly protected from contact with the member to prevent mechanical wear on the yellow jacket and tubing. Acceptable means of protection include: rubber grommets, bushings, HOME-FLEX® Flexible Protective Conduit, PVC tape, thermal contraction sleeve material, or a minimum of four wraps of 10 mil duct tape.

Concealed Locations for Fittings

The HOME-FLEX® mechanical attachment fittings have been tested and are listed per the requirements of ANSI LC1 and CSA 6.26 Standard (USA and Canada). This specification provides test requirements which certify fittings for concealed installations and connections to appliances where concealing the fittings is the only practical alternative

These guidelines address some of the known situations which may require the use of a concealed fitting. While accessibility of fittings is always preferred, there are some situations where concealing the fittings is the only practical option. This guide cannot address all applications of concealed fittings, but instead provides general instructions to demonstrate the principles which apply to fittings listed for installation in concealed locations (*National Fuel Gas Code*, NFPA 54 Chapter 7).

NOTE: Manifold stations which are composed of multiport manifold(s), shut off valve, and pressure regulator **shall not be** installed in concealed locations regardless of the qualifications of tubing fittings.

New Installations

HOME-FLEX® can be connected to steel piping systems through threaded pipe connections. This can be a sub-out run to an appliance connection, be outdoors to a meter, etc.

Installation Practices

HOME-FLEX® connections to fireplace key valves can be located in a concealed location, provided that accessibility is not readily provided.

When multiple outlets are supplied from a single tubing run (like in a series arrangement), each downstream outlet branch can be connected to the main run using a tee fitting which can be located in a concealed location. (Figure 4.7)

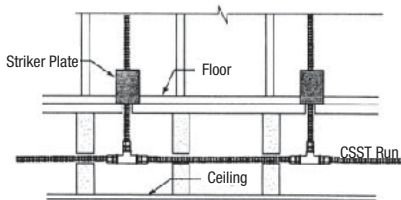

Figure 4.7 Multiple Outlets Along Main CSST Run

Modifications to Existing Systems

New Ceilings: HOME-FLEX® fittings originally installed in an unfinished ceiling location can be concealed in the event that a ceiling is installed at a later date.

Extensions to existing tubing runs: A concealed run of tubing can be extended with a new pipe run to feed another appliance location, so long as there is sufficient capacity to supply both appliances simultaneously. If an accessible location for the modification is not available, the existing run can be modified with a tee fitting, resulting in a concealed fitting (Figure 4.8)

Repairs to existing tubing runs: Damaged tubing runs should be repaired in accordance with Section 5.2 of this guide. The repair can result in a line splice that may be located in a concealed location.

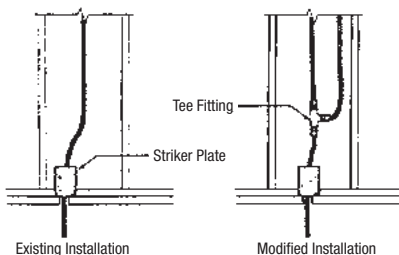

Figure 4.8 Extension of Existing Tubing Run

Outdoor Installation

ANSI LC1-CSA 6-26 contains test requirements determining suitability for exposure of CSST to outdoor environments. HOME-FLEX® is certified to this standard and is suitable for outdoor installations. The HOME-FLEX® jacket is UV resistant and able to withstand exposure to sunlight for a limited time. Avoid prolonged exposure to direct sunlight to attain longevity of the jacket. When this is not possible, tubing should be routed in a non-metallic sleeve or wrapped in self-bonding silicone tape.

When installed outdoors, the yellow jacketing of HOME-FLEX® must be intact along the entire run. Any areas of tubing not covered by the jacket are to be wrapped with self-bonding silicone tape or sleeved to prevent damage from acids and chlorides.

If HOME-FLEX® is installed in the equipment room of a swimming pool or hot tub, or otherwise exposed to a corrosive environment which could be harmful to the tubing, the tubing shall be installed in a protective device, and any exposed portions of the stainless steel tubing should be wrapped with self-bonding silicone tape, beginning on the jacket and ending on the nut of the HOME-FLEX® fitting.

Care must be taken to protect HOME-FLEX® from mechanical damage when installed along the exterior of a building. If installed within 6 feet of the ground, HOME-FLEX® tubing must be routed within a conduit or chase. If installed in a location where the tubing will not be subject to possible mechanical damage, a conduit is not required, but is recommended.

HOME-FLEX® should never be buried directly underground. To route HOME-FLEX® tubing underground, it must be protected within a nonmetallic water-tight conduit that is at least ½" larger than the outer diameter (OD) of the CSST tubing. Fittings and joints are not permissible in such runs—the run must be one unbroken line of tubing. Runs underneath slabs must be sleeved and vented per local codes. (See Section 4.9, "Underground Installations" on page 36)

Note: If installed underneath mobile homes or in crawl spaces, HOME-FLEX® should be installed in accordance with the above *Outdoor Installation Issues* section.

4.4 Protection

Protection is required when HOME-FLEX® tubing is concealed, constrained, and within 3 inches of a potential threat.

HOME-FLEX® flexible gas tubing must be adequately protected wherever it is at risk of damage from puncture, shearing, crushing, or other physical threats. Tubing is to be protected at support points, and when passing through structural members of the building such as studs, joists, and plates as outlined in this section. If the tubing requires protection, the measures in this section should be followed.

Striker Plates

Shielding devices (striker plates) are used to protect the HOME-FLEX® tubing from puncture threats such as drill bits, nails, screws, etc. Such devices are required when the tubing is concealed and is constrained such that the tubing would not be able to move if struck by a puncture threat.

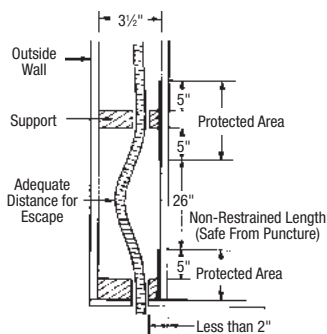

Figure 4.9 Elevated View of Unsupported Horizontal Tubing Run

1. At support points and areas of possible penetration less than 2 inches away from any edge of a stud, joist, plate, etc., shielding is required both at the area of support and within 5 inches of each side. (Figure 4.9)

2. At support points and points of possible penetration 2-3 inches from any edge of stud, joist plate, or other member, shielding is required throughout the area of support. (Figure 4.10)

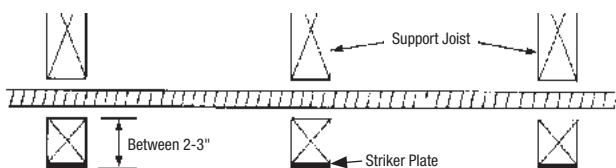

Figure 4.10 Shielding at Support Area When Penetration is 2-3 inches from Edge

3. At termination points using the HOME-FLEX® termination flange, HOME-FLEX® Flexible Protective Conduit should be installed to protect the CSST in the area between the striker plates and the outlet. (Figure 4.11)
4. For tubing routed horizontally between studs, striker plates should be installed at each stud, and Flexible Protective Conduit, or other approved conduit, should be installed across the entire length of the run.
5. If striker plates can't reasonably be installed (like between floors with enclosed joist areas or installations when walls are already in place), schedule 40 steel pipe has been found acceptable by CSA International for puncture protection. Steel pipe must have an inner diameter at least 1/2" larger than the outer diameter of the HOME-FLEX® tubing (Table 4.4). Protection must extend 5 inches beyond the penetration of the structural members. A 12 inch pipe length is acceptable for penetration of a single stud. Despite this approval, the use of striker plates is recommended whenever possible.

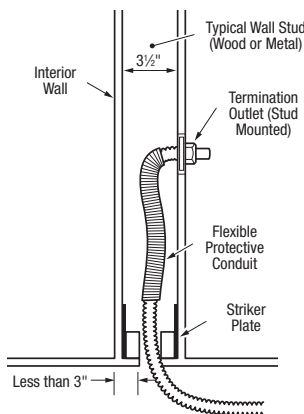

Figure 4.11 Use of Flexible Protective Conduit

HOME-FLEX® Size	Sch 40 Steel Pipe Size
1/2"	1 1/4"
3/4"	1 1/2"
1"	1 3/4"

Installation Practices

Avoiding Puncture Threats

The best way to protect from puncture threats (and potentially speed your installation) is to route tubing in areas of the structures where no added protection is necessary. The guidelines below will help the installer route HOME-FLEX® tubing in areas where secondary puncture protection isn't required:

1. Support tubing such that it is more than 3 inches away from any outside edge of a stud, joist, plate, etc., or wall surface. (See Figure 4.12 compared to Figure 4.10)
2. In non-restrained installations, make sure that the tubing can move at least 3 inches from the direction of potential penetration.
3. Tubing supported under joists in basements or crawl spaces does not require added protection so long as it is not concealed by wallboard or ceilings and is at least 3" away from puncture threats through floors or ceilings.
4. Added protection is not necessary in unfinished garage walls where the tubing is clearly exposed so long as puncture threats do not exist from the outside wall.

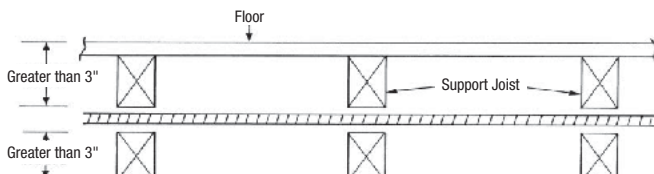

Figure 4.12 Penetration Point Greater than 3" from Edge of Stud, Joist, Plate, etc.

Through-Wall Penetration

HOME-FLEX® tubing and its polyethylene jacket have been tested to the flame spread and smoke density requirements of ASTM E84 and meets AGA and ANSI LC-1 limits imposed for this criteria. HOME-FLEX® is classified as NFPA Class A/IBC Class A with a flame spread value of 0 and a smoke density value of 80. Other requirements for fire rated resistive constructions may be imposed by local codes. The Qualified Installer must meet local building codes pertaining to flame and smoke density regulations for nonmetallic materials at all times.

4.5 Meter connections

Natural gas meters are generally structurally supported independent of the building structure and piping system. When the gas meter is independently supported, HOME-FLEX® can, in some localities, be used to connect the meter to the building gas system. If the gas meter is not supported independent of the building structure or gas piping system, HOME-FLEX® tubing cannot be used to connect directly to the meter.

Connection by Special Termination Fitting

Do not use HOME-FLEX® CSST as a direct connection if the meter must be supported by the piping system. If the meter is supported by the building structure, common practice is to route the CSST system to a termination flange mounted to the exterior of the building, and to connect the meter to the termination flange with rigid pipe. Alternatively, rigid pipe can be used to penetrate the building, with an attachment to HOME-FLEX® inside the structure. (Figure 4.13)

Direct Connection

If a direct connection from HOME-FLEX® to an independently supported gas meter is permitted by the local utility, the connection should include an extra 3-6" of length to allow for building settling and meter movement. Exposed sections of CSST are to be wrapped with self-bonding silicone tape, especially if the building is of masonry construction. For direct connections through masonry construction, a PVC sleeve is required, and also recommended for wood frame construction. (Figure 4.14)

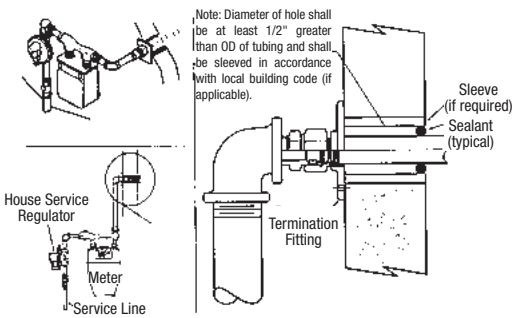

Figure 4.13 Connection to Building supported Meter

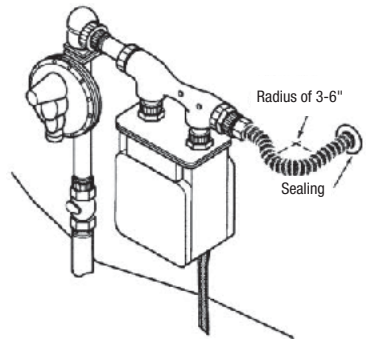

Figure 4.14 Independently Supported Meter

Note: Check with the local servicing utility prior to directly connecting HOME-FLEX® to the gas meter as utilities regulate connections to meter attachments.

4.6 Appliance connections

Termination Fittings with Appliance Connectors

The HOME-FLEX® termination flange fitting is designed to service moveable appliances and quick-connect devices at floor and hallow wall piping outlets (Figure 4.15) in combination with a HOME-FLEX® Flexible Appliance Connector or similar approved device. The termination outlet minimizes the need for concealed fittings and makes the installation of gas connections for moveable appliances easy. The flange plate should be securely fastened in place during rough-in of the structure. It may be attached to a brace spanning between wall studs or directly to the floor.

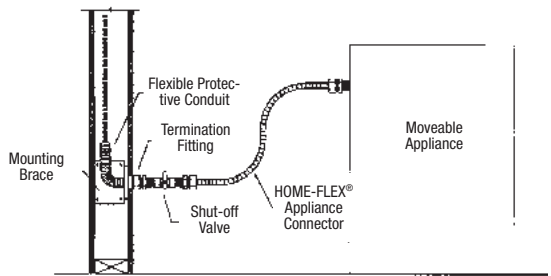

Figure 4.15 HOME-FLEX® Connection to Movable Gas Appliance

As an alternative to the special termination flange, a termination can be made with rigid pipe connected to the main HOME-FLEX® system. The rigid stub-out must be fastened to the wall or floor using a pipe flange or other rigid mounting object.

Connections made between HOME-FLEX® and movable appliances must be made with a HOME-FLEX® Flexible Appliance Connector, or similar approved device.

Direct connections between HOME-FLEX® CSST and movable appliances are not allowed.

Direct Connection

In most localities, fixed appliances may be directly connected to HOME-FLEX® flexible gas piping sys-

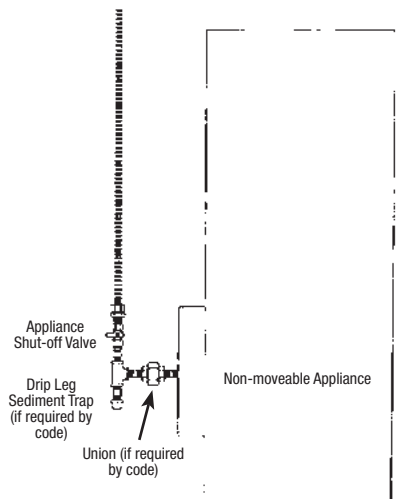

Figure 4.16 Direct Connection to Fixed Appliance

Installation Practices

tems. When located in a secure dedicated place, like an attic or garage, the gas piping can be connected directly to the appliance shut-off valve without installing a special termination flange or flexible appliance connector. (Figure 4.16)

Pad-Mounted Equipment

Gas equipment like pool heaters, generators, heat pumps, and gas air conditioners that are mounted on concrete pads should connect to the HOME-FLEX® system at a termination fitting with either black steel pipe or an approved outdoor appliance connector. Direct connection of HOME-FLEX® to pad-mounted equipment is allowed when the CSST is securely supported and protected from physical damage, so long as such practice is permissible by local and state codes. Any exposed tubing should be wrapped with self-bonding silicone tape, sealing the fitting connection.

Roof Top Equipment

Special mechanical protection of HOME-FLEX® tubing is not required for roof-mounted equipment unless the tubing may be subject to physical or environmental damage in the location. It is recommended that the tubing be covered to protect it from the elements. HOME-FLEX® tubing should penetrate the roof within 6 feet of the equipment location, whenever possible. Long runs of tubing on the roof should be supported with nonmetallic blocks at the intervals specific in Table 4.2, and raised above the roof at the height dictated by local code. (Figure 4.17)

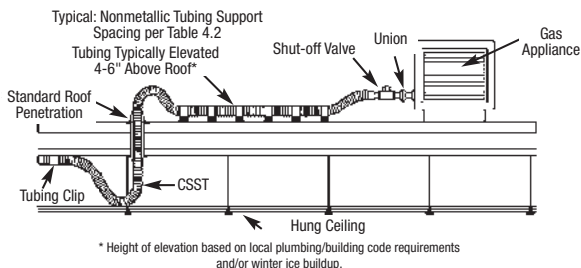

Figure 4.17 Roof Top Equipment Installation

In addition to nonmetallic blocks, HOME-FLEX® can be supported with a strut or channel running from block to block. This provides a secure, damage resistant track for the CSST and allows for the block spacing to be set at every 8 feet. The channel run should be a 1/16" galvanized shallow channel with splice plates at joints and bends. HOME-FLEX® tubing should be firmly attached to each block with metallic clamps designed for the strut, or other appropriate fastener. Black UV resistant cable ties can be used at intermediate points to ease the rolling out of HOME-FLEX®. Blocks should be attached to the roof surface in compliance with the roofing manufacturer's instructions. (Figure 4.18)

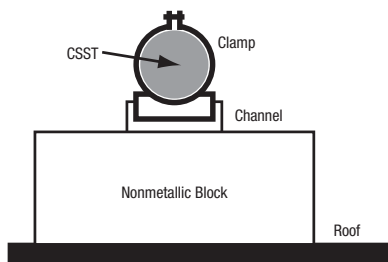

Figure 4.18 Rooftop Support with Strut

Any HOME-FLEX® tubing run vertically up the side of a building or on a rooftop must be protected in accordance with "Outdoor Installation Issues" in Section 4.3.

Outdoor Appliances: Barbecue Grills, Gaslights, and Heaters

As with movable indoor appliances, movable barbecue grills, heaters, and other appliances should not be directly attached to HOME-FLEX® CSST. An approved outdoor appliance connector should be used to make the connection from the appliance to the piping system at a special termination flange, a steel nipple, or a quick-connect device as described in Section 2.6 (p. 7). Always follow manufacturer's installation instructions. (Figure 4.19)

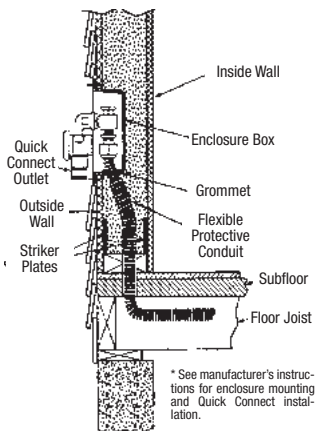

Figure 4.19 Quick Connect Outlet

Diameter of hole shall be at least 1/2 in. greater than OD of tubing and shall be sleeved and sealed in accordance with local building code (if applicable)

Connection of CSST to grill controls/shut-off valve shall be in accordance with the manufacturer's instructions

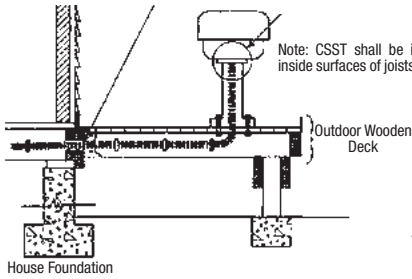

Figure 4.20 Fixed Outdoor Appliance (Deck Mounted)

Non-movable outdoor appliances, such as fixed barbecues, gas lights, or heaters can be directly connected with HOME-FLEX® so long as such connections are permissible by local code. On a deck, the outdoor portion of the tubing run must be supported against the sides of joists. If the deck elevation is below the building foundation, exposed tubing must be routed through a protective water-tight nonmetallic conduit. Underground tubing runs must follow the guidelines in Section 4.9 (p. 36). The exposed end of conduit must be sealed to prevent foreign objects (dirt, water, pests, etc.) from entering. (Figure 4.20 and Figure 4.21)

Fireplace Installations

Most gas fireplaces and gas logs are considered fixed appliances which can be directly connected with HOME-FLEX® without a special termination flange (ANSI Z24.50). Direct delivery of gas is approved to the key valve for decorative and heat generating fireplaces and for gas logs used in masonry and pre-fabricated fireplaces. (Figure 4.22)

DO NOT use HOME-FLEX® CSST to connect gas log lighter or gas wands for use in all-fuel (wood burning) fireplaces. For gas log lighter installations in all-fuel fireplaces, HOME-FLEX® must be terminated at the key valve or another location outside the fireplace. The final attachment to the lighter should be made using black steel pipe.

Should HOME-FLEX® need to be installed through masonry materials in the fireplace construction, the yellow jacket should remain intact and the HOME-FLEX® tubing should be routed through a nonmetallic sleeve appropriate for the application. Sleeves are not required for routing through ceramic liner in heat generating fireplaces. Spaces between the jacket and penetration at interior and/or exterior locations can be caulked. The jacket can be removed inside the firebox.

Attachment to the HOME-FLEX® system is usually made at the fireplace shut-off valve, often located in the control area beneath the burner unit or at the side of the log set. HOME-FLEX® can be run into the lower control area without removal of the polyethylene jacket. If the fire-

Note: CSST shall be installed only on inside surfaces of joists at the centerline

Note: Connection of CSST to equipment gas controls shall be in accordance with the manufacturer's instructions

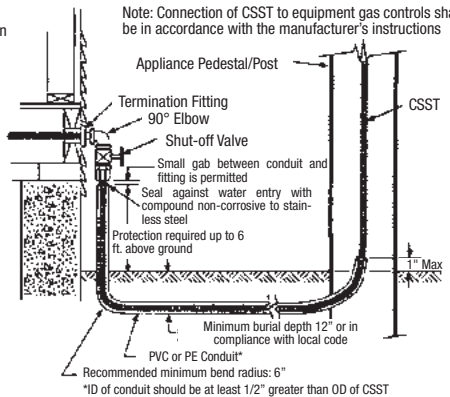

Figure 4.21 Fixed Outdoor Appliance (Underground Routing)

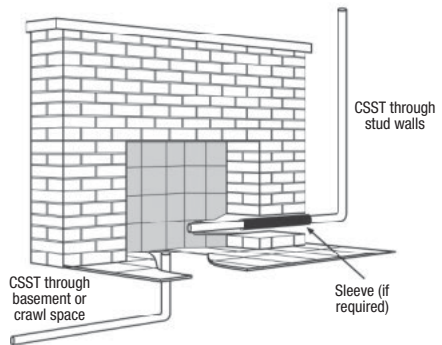

Figure 4.22 Routing to Masonry Fireplace

Installation Practices

place is vented, it is suggested to remove the yellow jacketing inside the fire box to prevent direct flame contact with the jacket.

If installing HOME-FLEX® through sheet metal enclosures (as commonly used for decorative fireplaces), it is recommended to leave the protective yellow jacketing in place through the penetration. HOME-FLEX® should be secured to the building structure outside the fireplace to limit motion after installation. Installations that may lead to abrasion of HOME-FLEX®, such as vibration from a fan in the fireplace assembly, require a short piece of Flexible Protective Conduit or PVC pipe to insulate the HOME-FLEX® from the enclosure.

4.7 Manifold Stations

In elevated pressure systems (typically installed in a parallel arrangement), it is recommended to use a central manifold and regulator station to take best advantage of regulator capacity (Figure 4.24). Stainless steel manifolds are available from Valencia Pipe Company or can be assembled through the use of rigid black steel pipe and fabricated tee manifolds. It is recommended that the station be located near the appliance(s) with the highest load in the system to allow for shorter runs to those appliances.

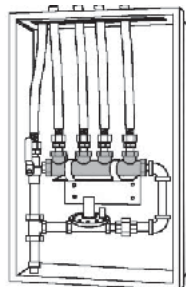

Figure 4.23 Gas Load Center

The manifold and regulator station MUST be located in an accessible location to maintain access to the shut-off valves and regulator. The station may be housed in a gas load center enclosure (Figure 4.23). Optional shut-off valves can be mounted on the manifold to control each appliance run in addition to the main line shut-off valve.

Subject to local code approval, manifolds may be concealed when used in low pressure systems, or when the manifold is installed in a location removed from the regulator. However, accessible locations are strongly recommended.

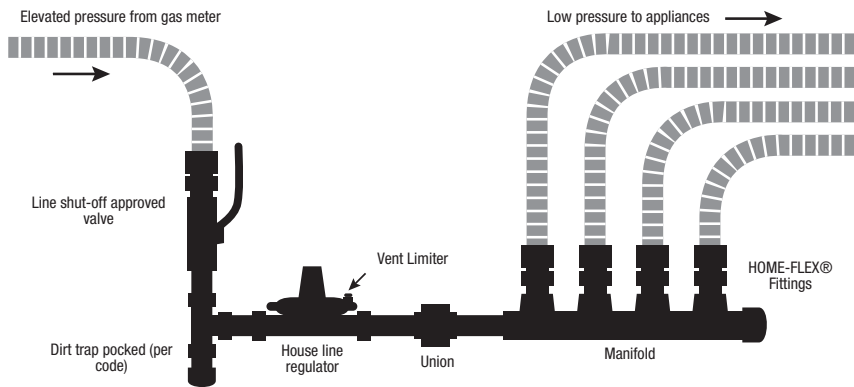

Figure 4.24 Example of Manifold Station Layout

4.8 Pressure Regulators

Installation Requirements

A HOME-FLEX® gas piping system used with inlet gas pressures in excess of ½ PSI, but servicing appliances rated for a maximum of ½ PSI, must contain a pounds-to-inches regulator to limit the downstream pressure to no more than ½ PSI. Gas pressure regulators must comply with a nationally recognized standard for pressure regulators such as ANSI Z21.80/CSA 6.22. Regulators must also conform to the following:

- Regulators must be sized in accordance with the total appliance load (maximum flow rate), largest single appliance flow rate, inlet pressure range at the regulator inlet, and the desired outlet pressure. (Table 4.5 and Table 4.6)
- Regulators must be installed in accordance with the manufacturer's instructions. Ensure the flow of gas is correct, as indicated by the flow markings on the regulator casing.
- The regulator must be installed in a fully accessible area with an approved shut-off valve upstream. A union can be used to allow for removal of the regulator if the location doesn't allow proper room for regulator servicing.
- Where a gas line pressure regulator is used in a system with a source pressure in excess of 2 PSI to serve appliances rated for 1/2 PSI or less, a regulator with an integrated over-pressure protection device (OPD) must be used. The regulator with OPD must be assembled and listed by the regulator manufacturer in accordance with ANSI Z21.80, *Standard for Line Pressure Regulators*.

Model	7" w.c. (17 mbar)	½ PSI (34 mbar)	¾ PSI (52 mbar)	1 PSI (69 mbar)
325-3	145 (4.0)	204 (5.8)	250 (7.0)	289 (8.2)
325-5A	339 (9.6)	476 (13.5)	583 (16.5)	673 (19.1)

Part No.	Gas Type	Max. Single Appliance Load	Max. Total Load	Outlet Pressure Set Point	Operating Inlet Pressure			
					½ PSI	¾ PSI	1 PSI	1½ PSI
325-3	Natural (0.64 sp. gr.)	140 CFH	250 CFH	8" w.c.	145 (4.1)	200 (5.7)	250 (7.1)	250 (7.1)
				11" w.c.	93 (2.6)	172 (4.9)	225 (6.4)	250 (7.1)
	LP (1.53 sp. gr.)	91 CFH (229 MBTU/hr)	163 CFH (410 MBTU/hr)	11" w.c.	60 (1.7) (152 MBTU/hr)	112 (3.2) (281 MBTU/hr)	146 (4.1) (368 MBTU/hr)	162 (4.6) (409 MBTU/hr)
325-5A	Natural (0.64 sp. gr.)	300 CFH	550 CFH	8" w.c.	335 (9.5)	475 (13.5)	550 (15.6)	550 (15.6)
				11" w.c.	211 (6.0)	391 (11.1)	511 (14.5)	550 (15.6)
	LP (1.53 sp. gr.)	195 CFH (483 MBTU/hr)	358 CFH (901 MBTU/hr)	11" w.c.	286 (8.1) (345 MBTU/hr)	254 (7.2) (639 MBTU/hr)	332 (9.4) (836 MBTU/hr)	357 (10.1) (899 MBTU/hr)

Note: The regulator models specified above are provided for reference only. They are not distributed, warranted, or supported by Valencia Pipe Company.

Vent Limiters and Vent Lines

Regulators must be equipped with a manufacturer-supplied vent limiting device, or be capable of being vented outdoors. When installed indoors, the vent-limiting device is to be used. When a vent-limiter is used, the regulator must be mounted in an upright position for proper function. For outdoor venting, the vent line must be at least the same size as the regulator vent connection and not exceed a length of 30 feet. The vent must be designed to prevent entry of water or other foreign materials that could clog the line. DO NOT vent to an appliance flue, building exhaust system, or pilot light.

If installing the regulator outdoors, remove the vent limiter and mount the regulator with the vent outlet pointing toward the ground to prevent water from entering. If the manufacturer provides a cap for outdoor installations, this can be used and the regulator can be mounted right side up.

Gas line regulators do not vent gas under normal operating conditions. A regulator that is venting gas should be replaced immediately.

Performance Testing

A performance test of the regulator should be conducted to confirm that adequate pressure reaches all appliances. During the test, all appliances should be running at full load to make sure that adequate pressure is maintained under full-load conditions for the gas piping system. The inlet pressure for gas appliances should be equal to, but not greater than, the appliance's recommended inlet pressure range. If the pressure is not within this range, adjustments to the service regulator or the pounds-to-inches gas line regulator may be required to adjust line pressure.

Regulator Adjustments

Regulators can be adjusted to deliver different outlet pressures downstream of the regulator. To adjust a regulator, remove the seal cap to expose the adjusting screw. Turn the screw clockwise to increase outlet pressure, or counter-clockwise to decrease pressure. (Figure 4.25)

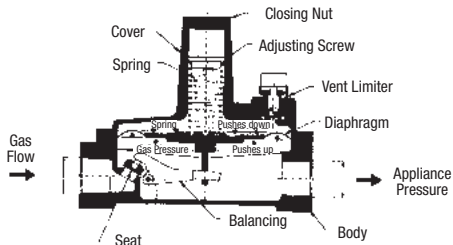

Figure 4.25 Pressure Regulator Diagram

If the spring adjustment doesn't result in the desired pressure, make sure the supply pressure is at least equal to the desired outlet pressure plus the pressure drop of the regulator. If this pressure is adequate, contact to the manufacturer. DO NOT continue to turn the screw clockwise if the outlet pressure reading doesn't increase as this may result in over-firing should there be an increase in inlet pressure.

4.9 Underground Installations

Building codes require that gas piping runs that come in contact with earth or other material that could corrode the piping be protected from corrosion. Piping installed beneath (underground) or within the slab of a building must be encased in a nonmetallic water-tight conduit that is vented. Fittings and couplings are not permitted when HOME-FLEX® is installed underground.

HOME-FLEX® should never be buried directly underground without a conduit. To route HOME-FLEX® tubing underground, it must be protected within a nonmetallic water-tight conduit that is at least 1/2" larger than the outer diameter of the CSST tubing. Fittings and joints are not permissible in such runs; the run must be one unbroken line of tubing.

For outdoor underground installations, the annular space between the CSST and the nonmetallic conduit must be sealed to prevent entrance of moisture, dirt, debris, and insets.

For indoor buried installations, the annular space between the CSST and the nonmetallic conduit does not have to be sealed. In the event that local code requires the conduit to be vented, the use of a tee designed for use with nonmetallic conduit may be placed at the termination end of the conduit. One end of the tee should be sealed while the other outlet can be used to connect a vent line that is routed outside (See Figure 4.26, Figure 4.27, and Figure 4.28). Vent lines routed to the outside of a structure must be installed in such a manner to prevent entrance of moisture, dirt, debris, and insects.

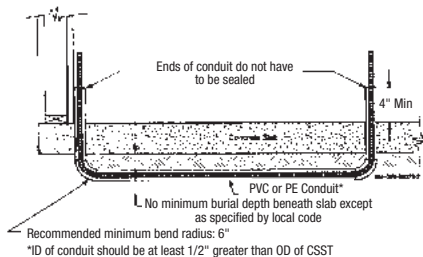

Figure 4.26 Installation in Nonmetallic Conduit Under Slab

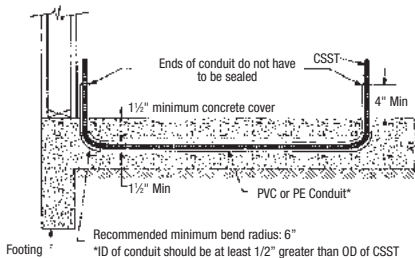

Figure 4.27 Installation in Nonmetallic Conduit In Slab

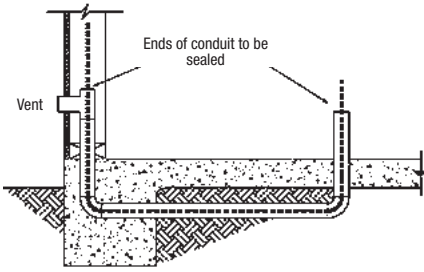

Figure 4.28 Installation in Nonmetallic Conduit with Venting

Table 4.7 Burial Depths for Underground Routing	
Outdoors	Minimum of 12"
In slab	1-½" minimum concrete coverage
Under slab	No minimum burial depth below slab, or in compliance with local codes

Table 4.8 Conduit Termination Height for Underground Routing	
Indoors	Conduit to extend a minimum of 1" above finished floor height
Outdoors	Conduit to extend a minimum of 4" above finished grade

Note: If installed underneath mobile homes or in crawl spaces, HOME-FLEX® should be installed in accordance with Section 4.3, *Outdoor Installation Issues*.

4.10 Electrical Bonding

Proper bonding and grounding may reduce the risk of damage and fire from electrical arcing to CSST as a result of a lightning strike. Lightning does not have to strike a structure directly to cause damage. Conductive systems, like piping or wiring, can become energized indirectly by a lightning strike. When systems are not properly bonded, the current from the energized line can cause electricity to arc (or jump) from one system to another and damage the CSST. Proper adherence to the bonding instructions should lower the risk of electrical arcing and related damages.

Bonding Guidelines

Direct bonding is required for gas piping systems incorporating standard (yellow) CSST whether or not the connected gas equipment is electrically powered. This requirement is for single-family and multi-family buildings and required by the 2009 and later editions of the National Fuel Gas Code, the International Fuel Gas Code and the Uniform Plumbing Code. A person knowledgeable in electrical system design, the local electrical code and these requirements should specify the bonding for commercial applications.

CSST installed inside or attached to a building or structure shall be electrically continuous and direct-bonded to the electrical ground system of the premises in which it is installed. The gas piping system shall be considered to be direct-bonded when installed in accordance with the following:

The bonding conductor is permanently and directly connected to the electrical service equipment enclosure, the grounded conductor at the electrical service, the grounding electrode conductor, or to one or more of the grounding electrodes used. When an additional grounding electrode(s) is used for the gas service, it shall be bonded to the electrical service grounding electrode system or, where provided, the lightning protection grounding system. For single and multi-family structures a single bond connection shall be made on an accessible rigid piping component or CSST fitting located downstream of the utility gas meter or second-stage LP regulator. The bonding clamp attachment point may be at any location within the gas piping system. However, the shortest practical bonding wire length will improve the effectiveness of the direct-bond. The corrugated stainless steel tubing portion of the gas piping system shall not be used as the point of attachment of the bonding clamp under any circumstances. (Figure 4.29 and Figure 4.30)

Installation Practices

The bonding conductor shall be no smaller than a 6 AWG copper wire or equivalent. The bonding conductor shall be installed and protected in accordance with the National Electrical Code, NFPA 70, (NEC) and Canadian Electrical Code CSA- C22.1 (CEC). Bonding/grounding clamps shall be installed in accordance with its listing per UL 467 and shall make metal-to-metal contact with a rigid pipe component or CSST fitting. This direct-bond is in addition to any other bonding requirements as specified by local codes for ground fault protection.

The 2018 edition of the National Fuel Gas Code, International Fuel Gas Code, and Uniform Plumbing Code limits the length of the bonding conductor to 75-ft. When there are no local code requirements for the length of this conductor refer to the NEC / CEC for guidance regarding the permissible length of the bonding conductor.

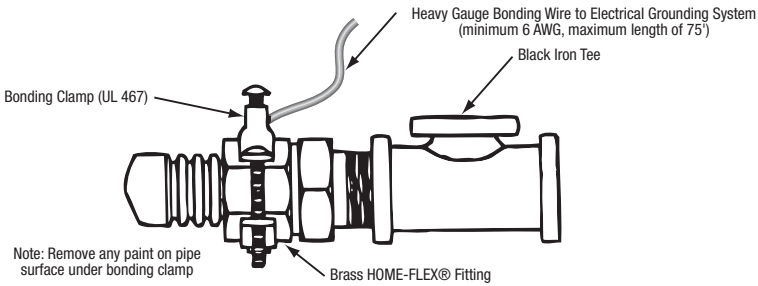

Figure 4.29 Bonding Connection to Brass Fitting

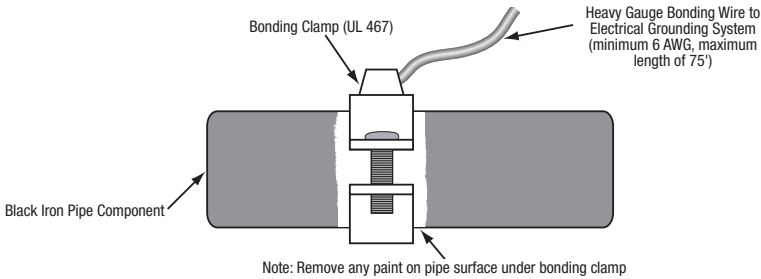

Figure 4.30 Bonding Connection to Rigid Black Iron Pipe

Chapter 5: Inspection, Repair, and Replacement of CSST

5.1 Minimum Inspection Requirements Checklist

All installations shall be inspected by the authority having jurisdiction in accordance with state and local mechanical, electric, and/or plumbing codes, or in the absence of such codes, the *National Fuel Gas Code* (NFPA 54/ANSI Z 223.1), the *International Fuel Gas Code* (IFGC), the *National Electric Code* (NFPA 70), and/or the *Uniform Plumbing Code* (UPC), as applicable.

- Installer has HOME-FLEX® Qualified Installer Card
- Inspection and pressure test completed at rough-in (Chapter 6)
- Only fixed appliances are directly connected to the HOME-FLEX® system (Section 4.6)
- Connections to moveable appliances are made with HOME-FLEX® Flexible Appliance Connectors, or similar approved devices (Section 4.6)
- System properly sized to deliver pressure required for all appliances (Section 3.2 and Chapter 7)
- Regulator, if required, is installed in an accessible location with a shut-off valve mounted ahead of it (Section 4.8)
- If routed underground or through masonry, HOME-FLEX® tubing is properly sleeved (Section 4.3)
- Striker plate protection in place where required (Section 4.4)
- HOME-FLEX® tubing is supported at proper interval (Section 4.1 and Table 4.2)
- No damaged tubing dents or defects (Section 5.2)
- Direct bond to the electrical service grounding electrode system (Section 4.10)

5.2 Repair of Damaged Tubing

If tubing is damaged before, during, or after installation, refer to these guidelines to determine the proper course of repair.

When Pipe Needs to be Replaced

If the tubing is only slightly dented due to impact, it may not need to be replaced. A slight dent is defined as a dent less than $\frac{1}{3}$ the diameter of the pipe and does not require replacement. (Figure 5.1)



Figure 5.3 Repair Unnecessary

The HOME-FLEX® tubing must be replaced under the following circumstances:

- The tubing has been significantly crushed or dented (a dent greater than $\frac{1}{3}$ the diameter of the pipe). (Figure 5.2)
- The tubing has been damaged by puncture of ANY kind (nails, screws, drill bits, etc.).
- The tubing has been bent beyond its minimum bend radius such that a crease or kink remains. (Figure 5.3)

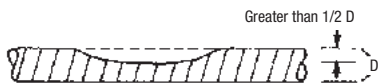

Figure 5.4 Repair Necessary

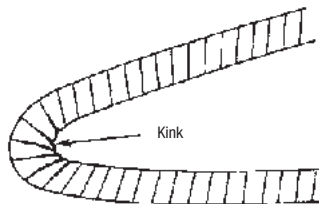

Figure 5.1 Repair Necessary Due to Exceeding Minimum Bend Radius

Method Of Repair: Splice or Replace?

HOME-FLEX® can be repaired by splicing through the use of HOME-FLEX® fittings (Figure 5.4), but if the tubing run is short and easily accessible, the preferred repair method is to replace the entire length of tubing. This is often a speedier repair than a splice, and does not add additional fitting joints to the system, avoiding increased pressure loss and simplifying the piping system. The existing HOME-FLEX® fittings can be reused on the new run, so long as they are undamaged. When reusing fittings, the nonmetallic gasket must be replaced to ensure a proper seal.

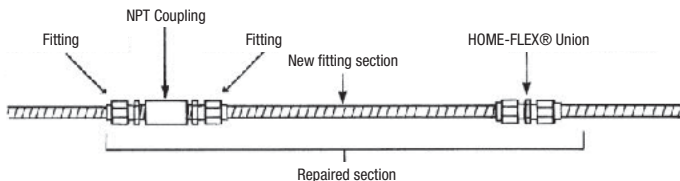

Figure 5.2 Repair of Damaged Tubing with a Spliced New Section

Chapter 6: Pressure Test Procedures

The final installation must be inspected and tested for leaks in accordance with local and/or state codes. In the absence of local guidelines, test the system at 1½ times the maximum working pressure, but not less than 3 PSI, using the procedures specified in Chapter 8 "Inspection, Testing and Purging" of the *National Fuel Gas Code* (NFPA 54/ANSI Z223). When local codes are more stringent, local codes must be followed. If no local codes apply, test according to the National Fuel Gas Code, IFGC, or UPC. The installer should never pressure test with the pounds-to-inches regulator installed as this may damage the regulator.

6.1 Procedure For Low Pressure Systems

- Pressure testing should be performed during rough construction of the facility, before interior walls are finished. This will permit a more complete inspection of the piping system during the pressure testing, and save costly rework in the event of leaks or other problems. **Valencia Pipe Company is not responsible for repairs necessary to correct defects discovered after interior walls are finished.**
- Do not connect appliances or pressurize the system with fuel gas until after the pressure test is completed.
- All gas outlets for appliance connections should be capped during pressure testing.
- **Use only non-corrosive leak check solutions.** Rinse with water and dry the tubing thoroughly after leak detection. Valencia Pipe Company recommends commercially available fluid leak detection solutions.
- Most utilities perform a leak test after setting the gas meter and prior to turning on the gas. This test is performed after the final construction is complete and finished interior walls are in place. This test is performed to assure no damage was done to the tubing during the closing-in construction process.

6.2 Procedure For Elevated Pressure Systems

Systems above ½ PSI require a two-part pressure test. The first part is performed on the elevated pressure section, between the meter connection and the pounds-to-inches line gas pressure regulator (Figure 6.1). The second part is performed on the low pressure section, between the pounds-to-inches line gas pressure regulator and the gas appliance outlet. If a steel pipe "jumper" is inserted in place of the line gas pressure regulator the entire system can be pressure tested in one step.

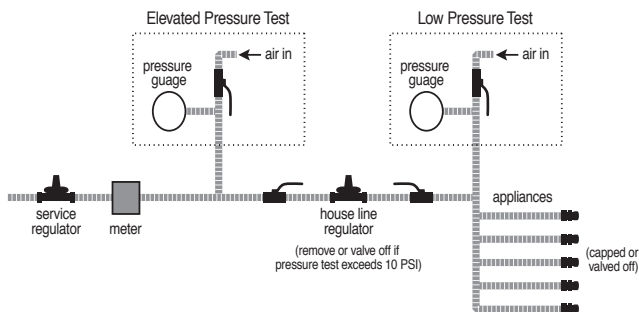

Figure 6.1 Pressure Test Requirements for a 2 PSI System

6.3 Appliance Connection Check Procedure

After the final pressure test, inspection, and final construction are complete, appliances may be connected to the HOME-FLEX® gas piping system.

This final connection can be accomplished by a HOME-FLEX® Appliance Connector (or similar device), direct connection with CSST tubing, or with rigid black pipe, depending on the appliance (see Section 4.6 for installation details and guidelines).

Turn the gas on at the meter and inspect for leakage before operating the appliances.

Connections made at the appliances should be leak checked with a commercially available fluid leak detection solution. The tubing system should be purged before placing the appliances in operation to displace the air in the system with fuel gas. Be sure to bleed tubing system into a well ventilated area.

NOTE: Leak test solutions may cause corrosion to some types of material in the gas tubing system. Be sure to water rinse after the test and thoroughly dry all contacted material. Also, the vent limiter should not be leak tested with a liquid test solution. This could contaminate the internal ball check mechanism, or plug the breathing hole, resulting in erratic regulator operation.

Chapter 7: Sizing/Capacity Tables

Natural Gas Sizing Tables

Table 7.1 Low Pressure (6 - 7 in w.c. with 0.5 in drop)	44
Table 7.2 Low Pressure (6 - 7 in w.c. with 1 in drop)	44
Table 7.3 Regulator Outlet (8 - 10 in w.c. with 3 in drop)	45
Table 7.4 Medium Pressure (12 - 14 in w.c. with 6 in drop)	45
Table 7.5 Elevated Pressure (2 PSI with 1 PSI drop)	46
Table 7.6 Elevated Pressure (5 PSI with 3.5 PSI drop)	46

Liquid Petroleum (LP) Sizing Tables

Table 7.7 Low Pressure LP (11 in w.c. with 0.5 in w.c. drop)	47
Table 7.8 Medium Pressure LP (13-14 in w.c. with 2.5 in w.c. drop)	47
Table 7.9 Elevated Pressure LP (2 PSI with 1 PSI drop)	48
Table 7.10 Elevated Pressure LP (5 PSI with 3.5 PSI drop)	48

Steel Pipe Capacity Charts

Table 7.11 Natural Gas (½ PSI or less with 0.5 in w.c. drop)	49
--	----

Sizing/Capacity Tables

Table 7.1 Low Pressure (6 - 7 in w.c. with 0.5 in drop)

Maximum Capacity of HOME-FLEX® CSST in BTU/h (British Thermal Units per Hour) of Natural Gas by Length of Tubing Run

(Approximate 1,000 BTU/h Natural Gas per 1 CFH; based on a 0.6 specific gravity of gas)

**Inlet Pressure: 6-7 in w.c. (¼ PSI)
Pressure Drop: 0.5 in w.c.**

Run (ft.)	Tubing Size (EHD)		
	½" (EHD 18)	¾" (EHD 25)	1" (EHD 31)
5	100k	283k	626k
10	71k	200k	425k
15	59k	163k	338k
20	51k	141k	288k
25	46k	127k	254k
30	42k	116k	230k
40	37k	100k	195k
50	33k	89k	172k
60	30k	82k	156k
70	28k	76k	143k
75	27k	73k	137k
80	26k	71k	133k
90	25k	67k	124k
100	24k	63k	117k
125	21k	57k	103k
150	19k	52k	93k
200	17k	45k	79k
300	14k	37k	63k
400	12k	32k	54k
500	11k	28k	47k

Table 7.2 Low Pressure (6 - 7 in w.c. with 1 in drop)

Maximum Capacity of HOME-FLEX® CSST in BTU/h (British Thermal Units per Hour) of Natural Gas by Length of Tubing Run

(Approximate 1,000 BTU/h Natural Gas per 1 CFH; based on a 0.6 specific gravity of gas)

**Inlet Pressure: 6-7 in w.c. (¼ PSI)
Pressure Drop: 1 in w.c.**

Run (ft.)	Tubing Size (EHD)		
	½" (EHD 18)	¾" (EHD 25)	1" (EHD 31)
5	132k	406k	925k
10	95k	287k	627k
15	79k	234k	500k
20	69k	203k	426k
25	62k	182k	376k
30	57k	166k	339k
40	50k	143k	289k
50	45k	128k	255k
60	41k	117k	230k
70	38k	108k	211k
75	37k	105k	203k
80	36k	101k	196k
90	34k	96k	183k
100	32k	91k	173k
125	29k	81k	153k
150	27k	74k	138k
200	23k	64k	117k
300	19k	52k	93k
400	17k	45k	80k
500	15k	41k	70k

k = 1,000 BTU/h EXAMPLE: 10k = 10,000 BTU/h = 10 CFH (Cubic Feet per Hour) of Natural Gas

Equivalent Hydraulic Diameter (EHD): A theoretical sizing which is used to compare the hydraulic performance between manufacturers. A higher EHD number indicates greater flow capacity of piping.

Tables include losses for four 90 degree bends and two (2) end fittings. Tubing runs with larger numbers of bends and/or fitting shall be increased by an equivalent length of tubing according to the following formula: $L = 1.3 \times (n)$ where L is the additional length of tubing necessary and n is the number of additional fittings and/or bends.

Table 7.3 Regulator Outlet (8 - 10 in w.c. with 3 in drop)

Maximum Capacity of HOME-FLEX® CSST in BTU/h (British Thermal Units per Hour) of Natural Gas by Length of Tubing Run

(Approximate 1,000 BTU/h Natural Gas per 1 CFH; based on a 0.6 specific gravity of gas)

Inlet Pressure: **8-10 in w.c.**
Pressure Drop: **3 in w.c.**

Run (ft.)	Tubing Size (EHD)		
	½" (EHD 18)	¾" (EHD 25)	1" (EHD 31)
5	222k	692k	1,717k
10	160k	493k	1,165k
15	132k	404k	928k
20	116k	351k	790k
25	104k	314k	697k
30	96k	288k	630k
40	84k	250k	536k
50	75k	224k	473k
60	69k	205k	427k
70	64k	190k	392k
75	62k	184k	377k
80	60k	178k	363k
90	57k	168k	340k
100	54k	159k	321k
125	49k	143k	283k
150	45k	131k	256k
200	39k	114k	218k
300	32k	93k	173k
400	28k	81k	148k
500	25k	72k	130k

Table 7.4 Medium Pressure (12 - 14 in w.c. with 6 in drop)

Maximum Capacity of HOME-FLEX® CSST in BTU/h (British Thermal Units per Hour) of Natural Gas by Length of Tubing Run

(Approximate 1,000 BTU/h Natural Gas per 1 CFH; based on a 0.6 specific gravity of gas)

Inlet Pressure: **12-14 in w.c. (½ PSI)**
Pressure Drop: **6 in w.c.**

Run (ft.)	Tubing Size (EHD)		
	½" (EHD 18)	¾" (EHD 25)	1" (EHD 31)
5	308k	1,058k	2,536k
10	222k	764k	1,720k
15	184k	631k	1,371k
20	161k	552k	1,167k
25	145k	497k	1,030k
30	133k	456k	930k
40	116k	398k	791k
50	104k	359k	698k
60	96k	329k	631k
70	89k	306k	579k
75	86k	296k	557k
80	84k	287k	537k
90	79k	272k	503k
100	75k	259k	474k
125	68k	233k	418k
150	62k	214k	378k
200	54k	187k	321k
300	45k	154k	256k
400	39k	135k	218k
500	35k	121k	192k

k = 1,000 BTU/h EXAMPLE: 10k = 10,000 BTU/h = 10 CFH (Cubic Feet per Hour) of Natural Gas

Equivalent Hydraulic Diameter (EHD): A theoretical sizing which is used to compare the hydraulic performance between manufacturers. A higher EHD number indicates greater flow capacity of piping.

Tables include losses for four 90 degree bends and two (2) end fittings. Tubing runs with larger numbers of bends and/or fitting shall be increased by an equivalent length of tubing according to the following formula: $L = 1.3 \times (n)$ where L is the additional length of tubing necessary and n is the number of additional fittings and/or bends.

Sizing/Capacity Tables

Table 7.5 Elevated Pressure (2 PSI with 1 PSI drop)

Maximum Capacity of HOME-FLEX® CSST in BTU/h (British Thermal Units per Hour) of Natural Gas by Length of Tubing Run

(Approximate 1,000 BTU/h Natural Gas per 1 CFH; based on a 0.6 specific gravity of gas)

Inlet Pressure: **2 PSI** Pressure Drop: **1 PSI**

Run (ft.)	Tubing Size (EHD)		
	½" (EHD 18)	¾" (EHD 25)	1" (EHD 31)
5	577k	1,982k	5,870k
10	408k	1,421k	4,065k
15	333k	1,170k	3,279k
20	289k	1,019k	2,815k
25	258k	915k	2,501k
30	236k	839k	2,271k
40	204k	730k	1,950k
50	183k	656k	1,732k
60	167k	601k	1,573k
70	154k	558k	1,449k
75	149k	540k	1,397k
80	144k	524k	1,350k
90	136k	495k	1,269k
100	129k	471k	1,200k
125	115k	423k	1,066k
150	105k	387k	968k
200	91k	337k	831k
300	75k	278k	670k
400	65k	242k	575k
500	58k	217k	511k

Table 7.6 Elevated Pressure (5 PSI with 3.5 PSI drop)

Maximum Capacity of HOME-FLEX® CSST in BTU/h (British Thermal Units per Hour) of Natural Gas by Length of Tubing Run

(Approximate 1,000 BTU/h Natural Gas per 1 CFH; based on a 0.6 specific gravity of gas)

Inlet Pressure: **5 PSI** Pressure Drop: **2.5 PSI**

Run (ft.)	Tubing Size (EHD)		
	½" (EHD 18)	¾" (EHD 25)	1" (EHD 31)
5	1,131k	3,855k	11,881k
10	828k	2,783k	8,228k
15	690k	2,300k	6,637k
20	606k	2,009k	5,698k
25	548k	1,809k	5,063k
30	505k	1,661k	4,596k
40	444k	1,451k	3,946k
50	401k	1,306k	3,506k
60	370k	1,199k	3,183k
70	345k	1,115k	2,934k
75	334k	1,080k	2,828k
80	325k	1,047k	2,733k
90	308k	991k	2,568k
100	294k	943k	2,428k
125	266k	849k	2,157k
150	245k	779k	1,959k
200	215k	681k	1,682k
300	179k	563k	1,357k
400	157k	492k	1,165k
500	142k	443k	1,035k

k = 1,000 BTU/h EXAMPLE: 10k = 10,000 BTU/h = 10 CFH (Cubic Feet per Hour) of Natural Gas

Equivalent Hydraulic Diameter (EHD): A theoretical sizing which is used to compare the hydraulic performance between manufacturers. A higher EHD number indicates greater flow capacity of piping.

Tables include losses for four 90 degree bends and two (2) end fittings. Tubing runs with larger numbers of bends and/or fitting shall be increased by an equivalent length of tubing according to the following formula: $L = 1.3 \times (n)$ where L is the additional length of tubing necessary and n is the number of additional fittings and/or bends.

Table 7.7 Low Pressure LP (11 in w.c. with 0.5 in w.c. drop)

Maximum Capacity of HOME-FLEX® CSST in BTU/h (British Thermal Units per Hour) of Liquid Propane (LP) Gas by Length of Piping Run
(Approximate 2,520 BTU/h LP Gas per 1 CFH; based on a 1.52 specific gravity of gas)

Inlet Pressure: **11 in w.c.** Pressure Drop: **0.5 in w.c.**

Run (ft.)	Tubing Size (EHD)		
	½" (EHD 18)	¾" (EHD 25)	1" (EHD 31)
5	150k	447k	990k
10	108k	316k	672k
15	90k	258k	535k
20	78k	223k	455k
25	70k	200k	402k
30	65k	182k	363k
40	56k	158k	309k
50	51k	141k	273k
60	47k	129k	246k
70	43k	119k	226k
75	42k	115k	217k
80	41k	112k	210k
90	39k	105k	196k
100	37k	100k	185k
125	33k	89k	163k
150	30k	82k	147k
200	26k	71k	125k
300	22k	58k	100k
400	19k	50k	85k
500	17k	45k	75k

Table 7.8 Medium Pressure LP (13-14 in w.c. with 2.5 in w.c. drop)

Maximum Capacity of HOME-FLEX® CSST in BTU/h (British Thermal Units per Hour) of Liquid Propane (LP) Gas by Length of Piping Run
(Approximate 2,520 BTU/h LP Gas per 1 CFH; based on a 1.52 specific gravity of gas)

Inlet Pressure: **13-14 in w.c.** Pressure Drop: **2.5 in w.c.**

Run (ft.)	Tubing Size (EHD)		
	½" (EHD 18)	¾" (EHD 25)	1" (EHD 31)
5	322k	1,000k	2,449k
10	232k	712k	1,661k
15	192k	584k	1,324k
20	168k	507k	1,127k
25	151k	454k	994k
30	139k	416k	898k
40	121k	361k	764k
50	109k	324k	675k
60	100k	296k	609k
70	93k	274k	559k
75	90k	265k	537k
80	87k	257k	518k
90	83k	243k	485k
100	79k	230k	458k
125	71k	207k	404k
150	65k	189k	365k
200	57k	164k	310k
300	47k	134k	247k
400	41k	117k	211k
500	37k	105k	186k

k = 1,000 BTU/h EXAMPLE: 252k = 252,000 BTU/h = 100 CFH (Cubic Feet per Hour) of LP Gas

Equivalent Hydraulic Diameter (EHD): A theoretical sizing which is used to compare the hydraulic performance between manufacturers. A higher EHD number indicates greater flow capacity of piping.

Tables include losses for four 90 degree bends and two (2) end fittings. Tubing runs with larger numbers of bends and/or fitting shall be increased by an equivalent length of tubing according to the following formula: $L = 1.3 \times (n)$ where L is the additional length of tubing necessary and n is the number of additional fittings and/or bends.

Sizing/Capacity Tables

Table 7.9 Elevated Pressure LP (2 PSI with 1 PSI drop)

Maximum Capacity of HOME-FLEX® CSST in BTU/h (British Thermal Units per Hour) of Liquid Propane (LP) Gas by Length of Piping Run
 (Approximate 2,520 BTU/h LP Gas per 1 CFH; based on a 1.52 specific gravity of gas)

Inlet Pressure: **2 PSI** Pressure Drop: **1 PSI**

Run (ft.)	Tubing Size (EHD)		
	½" (EHD 18)	¾" (EHD 25)	1" (EHD 31)
5	908k	3,259k	9,279k
10	637k	2,353k	6,426k
15	518k	1,945k	5,183k
20	448k	1,699k	4,450k
25	399k	1,530k	3,954k
30	364k	1,404k	3,590k
40	314k	1,226k	3,082k
50	280k	1,104k	2,738k
60	256k	1,014k	2,486k
70	236k	943k	2,291k
75	228k	913k	2,209k
80	221k	885k	2,135k
90	208k	838k	2,005k
100	197k	797k	1,896k
125	176k	718k	1,685k
150	160k	659k	1,530k
200	138k	576k	1,313k
300	112k	476k	1,059k
400	97k	416k	910k
500	87k	374k	808k

Table 7.10 Elevated Pressure LP (5 PSI with 3.5 PSI drop)

Maximum Capacity of HOME-FLEX® CSST in BTU/h (British Thermal Units per Hour) of Liquid Propane (LP) Gas by Length of Piping Run
 (Approximate 2,520 BTU/h LP Gas per 1 CFH; based on a 1.52 specific gravity of gas)

Inlet Pressure: **5 PSI** Pressure Drop: **3.5 PSI**

Run (ft.)	Tubing Size (EHD)		
	½" (EHD 18)	¾" (EHD 25)	1" (EHD 31)
5	2,108k	7,734k	20,369k
10	1,491k	5,469k	13,912k
15	1,217k	4,465k	11,131k
20	1,054k	3,867k	9,502k
25	943k	3,459k	8,405k
30	861k	3,157k	7,603k
40	745k	2,734k	6,490k
50	667k	2,446k	5,741k
60	609k	2,233k	5,193k
70	563k	2,067k	4,771k
75	544k	1,997k	4,593k
80	527k	1,934k	4,433k
90	497k	1,823k	4,155k
100	471k	1,729k	3,921k
125	422k	1,547k	3,468k
150	385k	1,412k	3,137k
200	333k	1,223k	2,678k
300	272k	998k	2,143k
400	236k	865k	1,829k
500	211k	773k	1,618k

k = 1,000 BTU/h EXAMPLE: 252k = 252,000 BTU/h = 100 CFH (Cubic Feet per Hour) of LP Gas

Equivalent Hydraulic Diameter (EHD): A theoretical sizing which is used to compare the hydraulic performance between manufacturers. A higher EHD number indicates greater flow capacity of piping.

Tables include losses for four 90 degree bends and two (2) end fittings. Tubing runs with larger numbers of bends and/or fitting shall be increased by an equivalent length of tubing according to the following formula: $L = 1.3 \times (n)$ where L is the additional length of tubing necessary and n is the number of additional fittings and/or bends.

Table 7.11 Natural Gas (½ PSI or less with 0.5 in w.c. drop)**Maximum Capacity of Schedule 40 Metallic Pipe in BTU/h (British Thermal Units per Hour) of Natural Gas by Length of Piping Run**

(Approximate 1,000 BTU/h Natural Gas per 1 CFH; based on a 0.6 specific gravity of gas)

Maximum Gas Pressure: ½ PSI Pressure Drop: 0.5 in w.c.

Run (ft.)	Metallic Schedule 40 IPS Pipe Size										
	¼"	⅜"	½"	¾"	1"	1¼"	1½"	2"	2½"	3"	4"
10	43k	95k	175k	360k	680k	1,400k	2,100k	3,950k	6,300k	11,000k	23,000k
20	29k	65k	120k	250k	465k	950k	1,460k	2,750k	4,350k	7,700k	15,800k
30	24k	52k	97k	200k	375k	770k	1,180k	2,200k	3,520k	6,250k	12,800k
40	20k	45k	82k	170k	320k	660k	990k	1,900k	3,000k	5,300k	10,900k
50	18k	40k	73k	151k	285k	580k	900k	1,680k	2,650k	4,750k	9,700k
60	16k	36k	66k	138k	260k	530k	810k	1,520k	2,400k	4,300k	8,800k
70	15k	33k	61k	125k	240k	490k	750k	1,400k	2,250k	3,900k	8,100k
80	14k	31k	57k	118k	220k	460k	690k	1,300k	2,050k	3,700k	7,500k
90	13k	29k	53k	110k	205k	430k	650k	1,220k	1,950k	3,450k	7,200k
100	12k	27k	50k	103k	195k	400k	620k	1,150k	1,850k	3,250k	6,700k
125	11k	24k	44k	93k	175k	360k	550k	1,020k	1,650k	2,950k	6,000k
150	10k	22k	40k	84k	160k	325k	500k	950k	1,500k	2,650k	5,500k
175	9k	20k	37k	77k	145k	300k	460k	850k	1,370k	2,450k	5,000k
200	8k	19k	35k	72k	135k	280k	430k	800k	1,280k	2,280k	4,600k

k = 1,000 BTU/h EXAMPLE: 10k = 10,000 BTU/h = 10 CFH (Cubic Feet per Hour) of Natural Gas

Chapter 8: Technical Information Sheet

8.1 HOME-FLEX® Corrugated Stainless Steel Tubing (CSST)

Tubing Materials: Type 304 Stainless Steel

Jacket Materials: UV/Ozone resistant polyethylene with flame retardant

Specification Operating Pressure: 25 PSIG

Listings: CSA 256532, IAPMO 7660

Operating Temperature Range: -40°F - 200°F

8.2 HOME-FLEX® Fittings

Fitting Materials: C360 Brass

Retainer Ring Materials: C360 Brass

O-ring Materials: Silicone

High Temperature Gasket Materials: Non-asbestos material

Specification Operating Pressure: 25 PSIG

Listings: CSA 256532, IAPMO 7660

Operating Temperature Range: -40°F - 200°F

8.3 HOME-FLEX® Manifolds

Materials: Type 304 Stainless Steel

Specification Operating Pressure: 25 PSIG

Listings: CSA 256532, IAPMO 7660

Operating Temperature Range: -40°F - 200°F

8.4 HOME-FLEX® Protection Devices

HOME-FLEX® Striker Plate Materials: 16-gauge hardened steel

HOME-FLEX® Bonding Clamp Materials: Bronze UL 467 Listed

Listings: CSA 256532, IAPMO 7660

Operating Temperature Range: -40°F - 200°F

Chapter 9: Definitions

A.G.A. American Gas Association

ANSI Z223.1 1988 The 1988 edition of the National Fuel Gas Code published by American National Standard Institute. Also known as NFPA 54 (National Fire Protection Association).

Appliance (Equipment) Any device which utilizes natural gas or propane as a fuel or raw material to produce light, heat, power, refrigeration or air conditioning.

Approved Acceptable to the authorities having jurisdiction.

ASME American Society of Mechanical Engineers

ASTM American Society for Testing and Materials

Authority Having Jurisdiction The organization, office or individual responsible for "approving" equipment, an installation or a procedure.

BTU Abbreviation for British Thermal Unit, which is the quantity of heat required to raise the temperature of one pound of water one degree Fahrenheit .

CAN-CGA-B149.1 Natural gas installation book used in Canada.

CAN-CGA-B149.2 Propane gas installation book used in Canada.

CFH Gas flow rate stated in cubic feet per hour.

CSST Corrugated stainless steel tubing

Concealed Gas Piping Gas piping, which, when in place in a finished building, would require removal of permanent construction to gain access to the piping.

Connector, Gas Appliance A factory-fabricated assembly of gas conduit and relating fittings designed to convey gaseous fuel, and used for making connections between a gas supply piping outlet and the gas to an appliance. It is equipped at each end for attachment to standard taper pipe threads.

Delivery Pressure Gas pressure available after the gas meter.

Design Pressure The maximum operating pressure permitted by this document, as determined by the design procedures applicable to the materials involved.

Drip Leg The container (dirt trap pocket) placed at a low point in a system of piping to collect and remove foreign material or condensation.

EHD (Effective Hydraulic Diameter) A relative measure of flow capacity used to compare individual sizes between different manufacturers. The higher the EHD number the greater flow capacity of the piping.

Elevated Pressure System Refers to any system with a pressure above 1/2 PSIG, but less than 5 PSIG.

Exposed Gas Piping Gas piping which will be in view in the finished structure.

Fuel Gas A commonly distributed gas used for fuel such as natural gas, manufactured gas, undiluted liquefied petroleum gas (vapor phase only), and liquefied petroleum gas-air mixtures of these gases (including propane and butane).

Full Lockup The capability of totally stopping the flow of gas if the load goes to zero, thus preventing the downstream pressure from increasing more than a certain upper limit pressure above the set point.

Gas Utilization Equipment Any device which utilizes gas as a fuel or raw material or both.

ID Inside diameter of pipe or tubing.

Definitions

Inches (") Water Column (w.c.) Method of stating pressure measured in inches of water column by a manometer or pressure gauge. Commonly used in the gas industry when the pressure is less than one (1) PSI.

$$\begin{aligned} \frac{1}{4} \text{ PSI} &= 7 \text{ in. w.c.} & \frac{1}{2} \text{ PSI} &= 14 \text{ in. w.c.} & 1 \text{ PSI} &= 28 \text{ in. w.c.} \\ 2 \text{ PSI} &= 56 \text{ in. w.c.} & 5 \text{ PSI} &= 139 \text{ in. w.c.} \end{aligned}$$

Joint A connection between two lengths of tubing or a length of tubing and fitting.

Listed Equipment or materials including a list published by an organization acceptable to the authority having jurisdiction and concerned with product evaluation that maintains periodic inspection of production of listed equipment or materials and whose listing states either that the equipment or material meets appropriate standards or has been tested and found suitable for use in a specified manner.

Load The amount of gas in CFH required by an appliance, or group of appliances, per their rating plate.

Lockup Pressure, Regulator The system pressure, immediately downstream of the regulator, at which the regulator valve will completely close (leak tight) under no-flow conditions to prevent the downstream pressure from exceeding a predetermined level.

LP Gas Liquefied petroleum. Fuel gas that is stored and transported in a liquid state, i.e., propane, butane, and mixtures of these and other heavier hydrocarbons.

MBTU 1,000 BTUs. See BTU above.

Manifold (Header) A pipe or fitting to which a number of branch lines are connected.

Meter An instrument installed to measure the volume of gas delivered through a piping system.

NFPA National Fire Protection Agency

OD Outside Diameter of pipe or tubing.

Piping As used in this document, either pipe or tubing, or both. Pipe is a rigid conduit of iron, steel, copper, brass or aluminum, while tubing is a semi-rigid conduit of corrugated stainless steel.

Piping System As used in this manual, an assembly of corrugated stainless steel tubing and tubing fittings, intended for field assembly, and installed in residential or commercial building to distribute fuel gas to gas utilization equipment within the building. The piping system may also include a gas pressure regulators, shutoff valves, tube shielding devices, distribution manifolds and other approved devices or components.

Pressure Unless otherwise stated, is expressed in pounds per square inch (PSI) above atmospheric pressure (i.e. gauge pressure).

Pressure Drop The loss in static pressure of gas due to friction or obstruction in tubing, valves, fittings, regulators and burners.

PSIG Pounds per square inch gauge. The pressure, as read from a measurement gage or device. Gauge pressure is pressure above atmospheric pressure and is sometimes referred to as PSI.

Purge To displace the original air, or gas, or a mixture of gas and air in a gas conduit with a new air/gas mixture.

Qualified Installer A qualified installer must meet applicable qualifications set forth by the state and/or local administrative authorities which enforce the plumbing, mechanical, electrical and/or building codes at the locale where the gas piping is to be installed. The installer must also be certified in the use of the HOME-FLEX® gas piping system.

Regulator A device that reduces and controls pressure. It automatically opens and closes in response to changing pressure conditions in the downstream piping.

Regulator, Gas Appliance Pressure A device for controlling and maintaining a uniform pressure to the manifold of gas burning equipment. This valve is typically part of the appliance. It reduces the pressure from 5.5" w.c. to the manifold pressure in the appliance.

Regulator, Line Gas Pressure (PSI to inches w.c.) A device placed in a gas line between the service regulator and the appliance regulator for controlling, maintaining or reducing the pressure in that portion of the piping system downstream of the device. This valve reduces the house line pressure (typically 2 PSI) to the regulator manifold pressure (typically 8-10" w.c.).

Regulator, Service Pressure (PSI or inches w.c.) A device installed by the serving gas supplier to reduce and limit the service line gas pressure. This valve reduces the service pressure to the metering pressure. It is located upstream of the gas meter.

Regulator Vent The opening in the atmospheric side of the regulator housing permitting the in and out movement of air to compensate for the movement of the regulator diaphragm.

Specific Gravity As applied to gas, the ratio of the weight of a given volume to that of the same volume of air, both measured under the same conditions.

Striker Plates A special type of shielding device used when concealed tubing is run through wall studs, floor and ceiling joists or other structural members where tubing movement is restricted.

Valve, Manual Shut-off A valve (located in the piping system and readily accessible and operable by the consumer) used to shut off individual equipment.

Vent Limiter Device Restriction/orifice type device in the vent outlet of a pressure regulator that controls or limits leakage, in the event of a diaphragm leak. It also allows the diaphragm to move freely to control pressure.

HOME-FLEX[®]

LIMITED WARRANTY

Valencia Pipe Company, Inc. ("VPC") hereby provides a limited warranty that its HOME-FLEX[®] Products will be free from any defect of workmanship and material for a period of one year from the date of proof of purchase. If any of the HOME-FLEX[®] Products are determined to be defective by VPC, the measure of the damage is the price of the defective goods only. No charge for labor or expense required to repair defective goods, or occasioned by them, will be allowed. VPC shall have no liability whatsoever for any amount in excess of the price paid for the HOME-FLEX[®] Product.

Should any defect of the HOME-FLEX[®] Product be claimed, the proposed defective HOME-FLEX[®] Product must be returned to VPC within the limited warranty period of one year from the date of purchase. The obligation of VPC under this limited warranty is, VPC at its discretion, may replace the defective HOME-FLEX[®] Product, repair the defective HOME-FLEX[®] Product or refund the purchase price paid for the HOME-FLEX[®] Product following receipt by VPC of proof of purchase of its HOME-FLEX[®] Product.

This limited warranty shall not apply to any part or parts of the HOME-FLEX[®] Products if it has been installed, altered, repaired or misused, through negligence or otherwise, in a way that in the opinion of VPC affects the reliability of, or detracts from, the performance of the product. Nor does this limited warranty cover replacements or repairs necessitated by loss or damage resulting from any cause beyond the control of VPC, including but not limited to acts of God, acts of government, floods or fires.

In order for the VPC limited warrant to apply; the HOME-FLEX[®] Product installation must have been performed strictly in accordance with local plumbing and/or building codes, and in accordance with the HOME-FLEX[®] CSST Flexible Gas Pipe System Design and Installation Manual. The VPC limited warranty will only apply if the HOME-FLEX[®] product was installed by a Qualified Installer who has been certified in a manner recognized by VPC and has been issued an HOME-FLEX[®] Qualified Installer Card from VPC.

The foregoing is in lieu of any other warranties, expressed, implied or statutory and VPC neither assumes nor authorizes any person to assume for VPC any other obligation or liability in connection with the sales of its products. The VPC limited warranty implies no warranty of merchantability or fitness for a particular purpose and is hereby disclaimed and excluded from the VPC limited warranty. VPC also reserves the right to repair or replace that part of the HOME-FLEX[®] Product that is determined by VPC to have been determined to have a defect during the limited warranty period.

