

CLICK ANYWHERE on THIS PAGE to RETURN TO GRUNDFOS SCALA 2 PUMP GUIDE at InspectApedia.com

THIS IS the 2015 MANUAL

SCALA

Installation and operating instructions



Original installation and operating instructions.

These installation and operating instructions describe Grundfos SCALA domestic water supply pumps.

Sections 1-4 give the information necessary to be able to unpack, install and start up the product in a safe way.

Sections 5-14 give important information about the product, as well as information on service, fault finding and disposal of the product.

CONTENTS

	Page
1. General information	2
1.1 Target group	2
1.2 Symbols used in this document	2
2. Receiving the product	2
2.1 Inspecting the product	2
2.2 Scope of delivery	2
3. Installing the product	3
3.1 Location	3
3.2 System sizing	3
3.3 Mechanical installation	3
3.4 Foundation	3
3.5 Installation examples	4
3.6 Suction pipe length	5
3.7 Electrical connection	5
4. Starting up the product	5
4.1 Priming the pump	5
4.2 Starting the pump	5
4.3 Shaft seal run-in	6
5. Storing and handling the product	6
5.1 Handling	6
5.2 Storing	6
5.3 Winterizing	6
6. Product introduction	6
6.1 Product description	6
6.2 Application	6
6.3 Pumped liquids	6
6.4 Identification	7
7. Control functions	8
7.1 Menu overview, SCALA2	8
8. Operating the controller	9
8.1 Setting the outlet pressure	9
8.2 Locking and unlocking the operating panel	9
8.3 Expert settings, SCALA2	9
8.4 Resetting to factory settings	9
9. Starting up the product after shutdown or standstill	9
9.1 Deblocking the pump	9
9.2 Controller settings	9
9.3 Priming	9
10. Servicing the product	10
10.1 Maintaining the product	10
10.2 Customer service information	10
10.3 Service kits	10
11. Taking out of operation	10
12. Fault finding the product	11
12.1 Grundfos Eye operating indications	11
12.2 Fault resetting	11
12.3 Fault finding chart	12
13. Technical data	14
13.1 Operating conditions	14
13.2 Mechanical data	14
13.3 Electrical data	14
14. Disposal	14

**Warning**

Prior to installation, read this document and the quick guide. Installation and operation must comply with local regulations and accepted codes of good practice.

Warning

This product can be used by children of eight years and up and persons with reduced physical, sensory or mental capabilities or lack of experience and knowledge if they are under supervision or have been instructed in the safe use of the product and understand the hazards involved.

Children must not play with the product.

Cleaning and maintenance of the product must not be made by children without supervision.

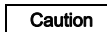

This pump has been evaluated for use with water only.

Warning

Risk of electric shock.

This pump has a grounding conductor and grounding-type attachment plug. To reduce the risk of electric shock, be certain that the pump is connected only to a properly grounded, grounding-type receptacle.

**1. General information****1.1 Target group**

These installation and operating instructions are intended for professional installers.

1.2 Symbols used in this document**Warning**

If these safety instructions are not observed, it may result in personal injury.

**Warning**

If these instructions are not observed, it may lead to electric shock with consequent risk of serious personal injury or death.



If these safety instructions are not observed, it may result in malfunction or damage to the equipment.



Notes or instructions that make the job easier and ensure safe operation.

2. Receiving the product**2.1 Inspecting the product**

Check that the product received is in accordance with the order.

Check that the voltage and frequency of the product match voltage and frequency of the installation site. See section 6.4.1 *Nameplate*.

2.2 Scope of delivery

The box contains the following items:

- 1 Grundfos SCALA pump
- 1 quick guide
- 1 safety instructions booklet.

3. Installing the product

3.1 Location

The pump can be installed indoors or outdoors, but it must not be exposed to frost.

We recommend that you install the pump near a drain or in a drip tray connected to a drain in order to lead away possible condensation from cold surfaces.

3.1.1 Minimum space

The pump can be installed in small spaces such as a cupboard. It requires a minimum space of 430 x 215 x 325 mm (17 x 8.5 x 12.8 inches).

Even though the pump does not require much space, we recommend that you leave enough space for service and maintenance access.

3.1.2 Installing the product in frosty environment

If the pump is to be installed outdoors where frost may occur, enclose it completely in insulating material to keep it from freezing.

3.2 System sizing



Warning

The system in which the pump is incorporated must be designed for the maximum pump pressure.

The pump is factory-set to three bar outlet pressure which can be adjusted according to the system in which it is incorporated.

The tank precharge pressure is 1.25 bar (18 psi).

3.3 Mechanical installation



Warning

Before starting any work on the product, make sure that the power supply has been switched off and that it cannot be accidentally switched on.

3.4 Foundation

Fasten the pump to a solid horizontal foundation by means of screws through the holes in the base plate. See fig. 1.

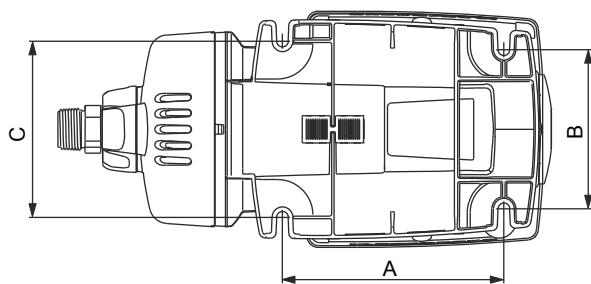

Fig. 1 Base plate

A	130 mm	5.12 inches
B	181 mm	7.13 inches
C	144 mm	5.67 inches

3.4.1 Pipework

Make sure that the pump is not stressed by the pipework.

The pumps are equipped with flexible connections, $\pm 5^\circ$, to facilitate the connection of inlet and outlet pipes. The inlet and outlet ports can be loosened by turning the union nuts by hand.

Caution

Always loosen and tighten inlet and outlet union nuts by hand.

1. Carefully screw the inlet and outlet connections on to the inlet and outlet ports using a pipe wrench or similar tool.
2. Then fit the connections to the inlet and outlet holding the connections with one hand, and tightening the union nuts with the other hand. See fig. 2.

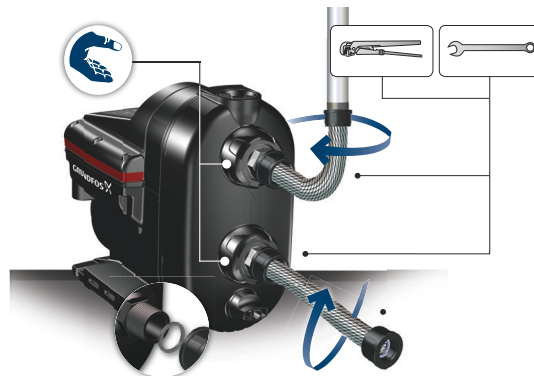

Fig. 2 How to fit the connections

3.4.2 How to reduce noise in the installation

Vibrations from the pump may be transferred to the surrounding structure and create noise in the 20-1000 Hz spectrum, also called the bass spectrum.

Correct installation using a vibration-damping rubber pad, flexible hoses and correctly placed pipe hangers for rigid pipes can reduce the noise experienced by up to 50 %. See fig. 3.

Place pipe hangers for the rigid pipes close to the connection of the flexible hose.

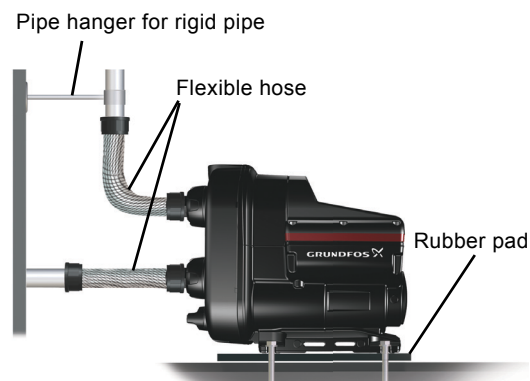

Fig. 3 How to reduce noise in the installation

TM06 4318 1915

TM06 3809 1015

TM06 4321 1915

3.5 Installation examples

Fittings, hoses and valves are not supplied with the pump.

3.5.1 Mains water pressure boosting

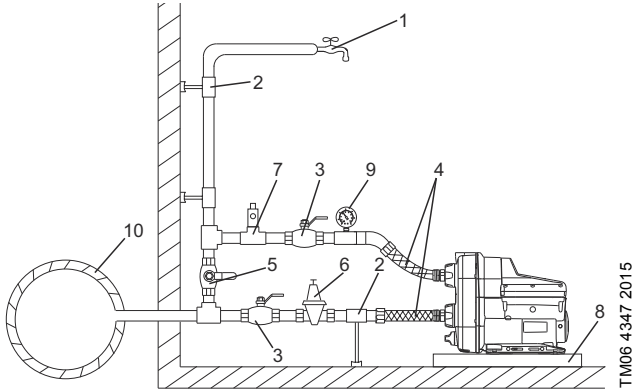

Fig. 4 Mains water pressure boosting

Pos.	Description
1	Highest tapping point
2	Pipe hangers and supports
3	Isolating valves
4	Flexible hoses
5	Bypass valve
6	Optional pressure-reducing valve on the inlet side if the inlet pressure can exceed 10 bar (145 psi)
7	Optional pressure-relief valve on the outlet side if the installation cannot stand up to a pressure of 6 bar (85 psi)
8	Drip tray. Install the pump on a small stand to avoid the ventilation holes from being flooded.
9	Pressure gauge
10	Mains water pipe

3.5.2 Suction from a well

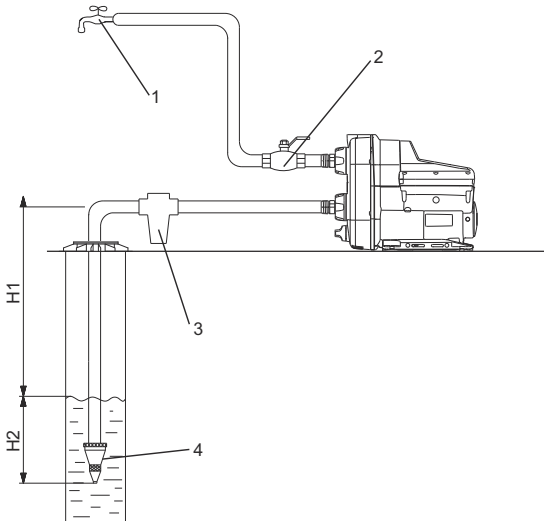

Fig. 5 Suction from a well

Pos.	Description
1	Highest tapping point
2	Isolating valve
3	Inlet filter. If the water can contain sand, gravel or other debris, please install a filter on the inlet side to protect the pump and installation.
4	Foot valve with strainer
H1	Maximum suction lift is 8 m (29 ft)

Pos. Description

H2 Inlet pipe must be submersed at least 0.5 m (1.64 ft)

3.5.3 Suction from freshwater tank

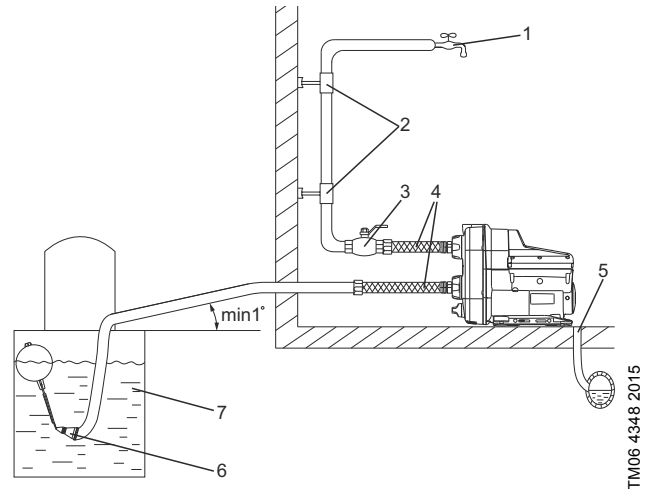

Fig. 6 Suction from freshwater tank

Pos.	Description
1	Highest tapping point
2	Pipe hangers
3	Isolating valve
4	Flexible hoses
5	Drain to sewer
6	Foot valve with strainer
7	Freshwater tank

3.6 Suction pipe length

The overview below shows the different possible pipe lengths, depending on the vertical pipe length.

The overview is only intended as a guide.

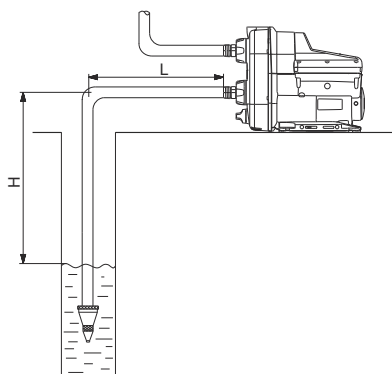

Fig. 7 Suction pipe length

TM06 4372 2115

DN 32		DN 40	
H [m (ft)]	L [m (ft)]	H [m (ft)]	L [m (ft)]
0 (0)	68 (223)	0 (0)	207 (679)
3 (10)	43 (141)	3 (10)	129 (423)
6 (20)	17 (56)	6 (20)	52 (171)
7 (23)	9 (30)	7 (23)	26 (85)
8 (26)	0 (0)	8 (26)	0 (0)

Preconditions:

Maximum flow velocity: 1 l/s (16 gpm)

Inside roughness of pipes: 0.01 mm (0.0004 inch).

Size	Inside pipe diameter	Pressure loss
DN 32	28 mm (1.1 inches)	0.117 m/m (5 psi/100 ft)
DN 40	35.2 mm (1.4 inches)	0.0387 m/m (1.6 psi/100 ft)

3.7 Electrical connection

3.7.1 Plug connection



Warning

Check that the voltage and frequency of the product match voltage and frequency of the installation site.



Warning

If the power supply cable is damaged, it must be replaced by the manufacturer, his service agent or similarly qualified persons in order to avoid hazard.



Warning

As a precaution, the product must be connected to a socket with earth connection.

Note

We recommend that you fit the permanent installation with an earth leakage circuit breaker (ELCB) with a tripping current < 30 mA.

The pump incorporates current and temperature dependent motor protection.

3.7.2 Connections without plug



Warning

The electrical connection must be carried out by an authorised electrician in accordance with local regulations.



Warning

Before making any connections in the product, make sure that the power supply has been switched off and that it cannot be accidentally switched on.

The product must be connected to an external mains switch with a contact gap of at least 3 mm [0.12 inch] in all poles.

4. Starting up the product

Caution

Do not start the pump until it has been filled with liquid.

4.1 Priming the pump

1. Unscrew the priming plug and pour minimum 1.7 litres (0.45 gallons) of water into the pump housing. See fig. 8.
2. Screw the priming plug on again.

Note

If the suction depth exceeds 6 m (20 ft), it may be necessary to prime the pump more than once.

Caution

Always tighten priming and drain plugs by hand.

4.2 Starting the pump

1. Open a tap to prepare the pump for venting.
2. Insert the power plug into the socket or turn on the power supply and the pump will start.
3. When water flows without air, close the tap.
4. Open the highest tapping point in the installation, preferably a shower.
5. Adjust the pressure to the required pressure by means of the  buttons.
6. Close the tapping point.

Startup has been completed.



Fig. 8 Priming the pump

TM06 4204 1615

4.3 Shaft seal run-in

The shaft-seal faces are lubricated by the pumped liquid, meaning that there may be a certain amount of leakage from the shaft seal.

When the pump is started up for the first time, or when the shaft seal has been replaced, a certain run-in period is required before the leakage is reduced to an acceptable level. The time required for this depends on the operating conditions, that is, every time the operating conditions change, a new run-in period will be started.

Under normal conditions, the leaking liquid will evaporate. As a result, no leakage will be detected.

5. Storing and handling the product

5.1 Handling

Caution Take care not to drop the pump as it may break.

5.2 Storing

In case the pump is to be stored for a period of time, drain it and store it in a dry location.

Temperature range during storing must be -40 to 70 °C (104 to 158 °F).

5.3 Winterizing

If the pump is going to be out of operation during the winter and can be exposed to frost, it must be disconnected from the power supply and winterized.

Proceed as follows:

1. Stop the pump by means of the on/off button .
2. Disconnect the power supply.
3. Open a tap to release the pressure in the pipe system.
4. Close the isolating valves and/or drain the pipes.
5. Gradually loosen the priming plug to release the pressure in the pump.
6. Remove the drain plug to drain the pump. See fig. 9.



Fig. 9 Draining the pump

5.3.1 Startup after the winter

Check that the pump is not blocked by following the steps in section 9.1 *Deblocking the pump*.

See section 4. *Starting up the product*.

6. Product introduction

6.1 Product description

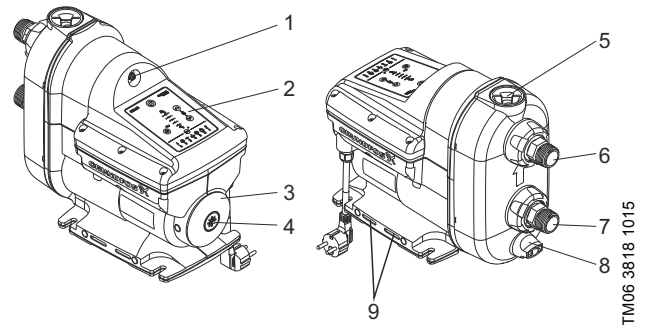

Fig. 10 Grundfos SCALA pump

Pos.	Description
1	Air valve for built-in pressure tank
2	Operating panel. See section 7. <i>Control functions</i> .
3	Nameplate. See section 6.4.1 <i>Nameplate</i> .
4	Plug for access to pump shaft. See section 9.1 <i>Deblocking the pump</i> .
5	Priming plug. See section 4.1 <i>Priming the pump</i> .
6	Outlet opening. With $\pm 5^\circ$ flexible connection. See section 3.4.1 <i>Pipework</i> .
7	Inlet opening. With $\pm 5^\circ$ flexible connection. See section 3.4.1 <i>Pipework</i> .
8	Drain plug. See section 5.3 <i>Winterizing</i>
9	Ventilation holes. Must not be flooded.

6.2 Application

The pump is suitable for pressure boosting of fresh water in domestic water supply systems.

6.3 Pumped liquids

The pump is designed for clean fresh water and chlorinated water < 300 ppm.

TM06 4203 1615

TM06 3818 1015

6.4 Identification

6.4.1 Nameplate

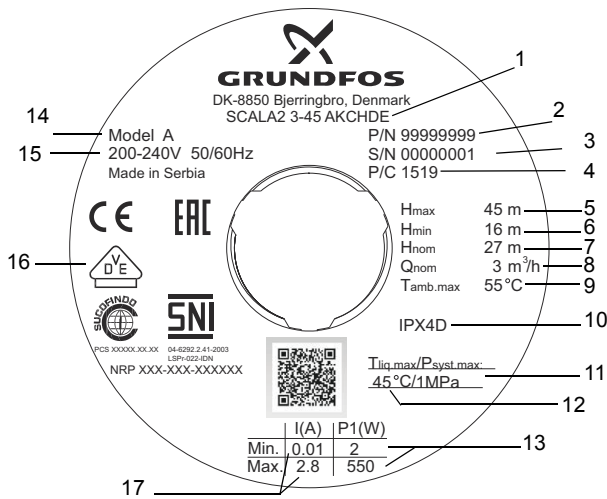

Fig. 11 Example of nameplate

Pos.	Description
1	Type designation
2	Product number
3	Serial number
4	Production code (year and week)
5	Maximum head
6	Minimum head
7	Rated head
8	Rated flow rate
9	Maximum ambient temperature
10	IP class
11	Maximum operation pressure
12	Maximum liquid temperature
13	Minimum and maximum rated power
14	Model
15	Voltage and frequency
16	Approvals
17	Minimum and maximum rated current

6.4.2 Type key

	SCALA2	3	-45	A	K	C	H	D	E
Type range:	SCALA1	Economy							
	SCALA2	Comfort							
Rated flow rate [m³/h]									
Maximum head [m]									
Material code:									
A:	Standard								
Supply voltage:									
K:	1 x 200-240 V, 50/60 Hz								
M:	1 x 208-230 V, 60 Hz								
V:	1 x 115 V, 60 Hz								
W:	1 x 100-115 V, 50/60 Hz								
Motor:									
C:	High-efficiency motor with frequency converter								
Mains cable and plug:									
A:	Cable with plug, IEC type I, AS/NZS3112, 2 m								
B:	Cable with plug, IEC type B, NEMA 5-15P, 6 ft								
C:	Cable with plug, IEC, type E&F, CEE7/7, 2 m								
D:	Cable without plug, 2 m								
G:	Cable with plug, IEC type G, BS1363, 2 m								
H:	Cable with plug, IEC type I, IRAM 2073, 2 m								
J:	Cable with plug, NEMA 6-15P, 6 ft								
Controller:									
D:	Integrated frequency converter								
Thread:									
A:	R 1" EN 1.4308								
C:	NPT 1" EN 1.4308								
E:	R 1" composite material								
F:	NPT 1" composite material								

7. Control functions

7.1 Menu overview, SCALA2



Fig. 12 SCALA2 operating panel

TM06 3301 5114

SCALA2	Function
	On/off
	Increases the outlet pressure
	Decreases the outlet pressure
	Resets alarms
	Indicates the required outlet pressure
	Indicates that the pump has been stopped manually
	Indicates that the operating panel is locked

7.1.1 Pressure indicator, SCALA2

The pressure indicator shows the required outlet pressure from 1.5 to 5.5 bars (22 to 80 psi) in 0.5 bar (7.5 psi) intervals. The illustration below shows a pump set to 3 bar (44 psi) indicated by two green lights and a pump set to 3.5 bar (51 psi) indicated by one green light.



Fig. 13 SCALA2 outlet pressure indication

TM06 4345 2015

	BAR	PSI	Water column [m]	kPa	MPa
	5.5	80	55	550	0.55
	5.0	73	50	500	0.50
	4.5	65	45	450	0.45
	4.0	58	40	400	0.40
	3.5	51	35	350	0.35
	3.0	44	30	300	0.30
	2.5	36	25	250	0.25
	2.0	30	20	200	0.20
	1.5	22	15	150	0.15

TM06 4187 1615

Fig. 14 Pressure indication table

The pressure settings 4.5, 5.0 and 5.5 bar (65, 73 and 80 psi) require a minimum positive inlet pressure which is maximum 4 bar (58 psi) lower than the required outlet pressure.

Note

Example: If the required outlet pressure is 5 bar, the minimum inlet pressure must be 1 bar (14.5 psi).

7.1.2 Indicator lights, SCALA2

Indications	Description
	Operating indications
	The operating panel is locked
	Power supply failure
	The pump is blocked, e.g. the shaft seal has seized up
	Leakage in the system
	Dry-running or water shortage*
	The maximum pressure has been exceeded
	The maximum runtime has been exceeded
	The temperature is outside the range

* For fault number 4, dry-running, the pump will try to reset automatically in a sequence of three attempts within the first minute. After this, eight attempts within an hour and repeatedly once every 24 hours. For the remaining faults, 1, 2, 3, 5, 6 and 7, the pump will reset whenever the cause has disappeared or been remedied.

For further information about system status, see section 12.1 Grundfos Eye operating indications.

8. Operating the controller

8.1 Setting the outlet pressure

Adjust the outlet pressure by pressing .

8.2 Locking and unlocking the operating panel

The operating panel can be locked, which means that the buttons do not function and no settings can be changed accidentally.

How to lock the operating panel

1. Hold down the buttons simultaneously for three seconds.
2. The operating panel is locked when symbol lights up.

How to unlock the operating panel

1. Hold down the buttons simultaneously for three seconds.
2. The operating panel is unlocked when symbol turns off.

8.3 Expert settings, SCALA2

Note *Expert settings are for installers only.*

The expert setting menu allows the installer to toggle between the functions auto reset, anti cycling and maximum continuous operating time.

Auto reset

This function allows the pump to automatically reset the alarms when operating conditions are back to normal.

Anti cycling

This function monitors the stops and starts of the pump and will give an alarm if the pump starts too frequently. If the pump starts and stops too frequently, there is a leakage in the system and the pump will show alarm 3.



Leakage in the system.

Maximum continuous operating time

This function is a timer that will turn off the pump if it runs continuously for 30 minutes. If the pump exceeds the running time of 30 minutes, it will show alarm 6.



Maximum runtime exceeded.

8.3.1 Accessing the expert settings

Proceed as follows:

1. Hold down the button for five seconds.
2. The symbol will start flashing to indicate that the expert settings are active.

The pressure indicator now acts as the expert "menu". A flashing green diode is the cursor. Move the cursor using the buttons, and toggle the selection on or off using the button. The diode for each setting will light up when the setting is active.

Move cursor up

Move cursor down

Toggle settings

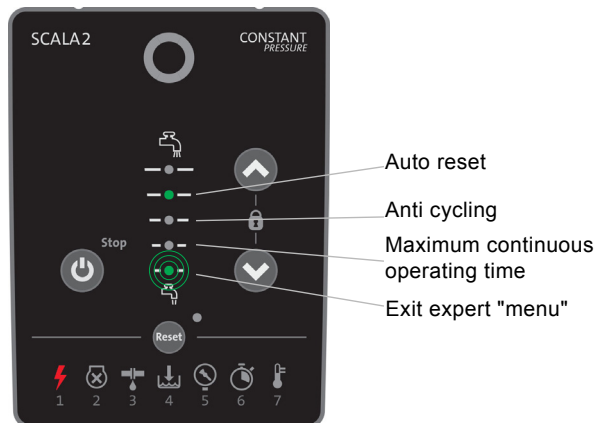

Fig. 15 Expert "menu" overview

8.4 Resetting to factory settings

The pump can be reset to factory setting by pressing the buttons simultaneously for five seconds.

9. Starting up the product after shutdown or standstill

9.1 Deblocking the pump



Warning

Before starting any work on the product, make sure that the power supply has been switched off and that it cannot be accidentally switched on.

The end cover incorporates a plug which can be removed by means of a suitable tool. This makes it possible to deblock the pump shaft if it has seized up as a result of inactivity.

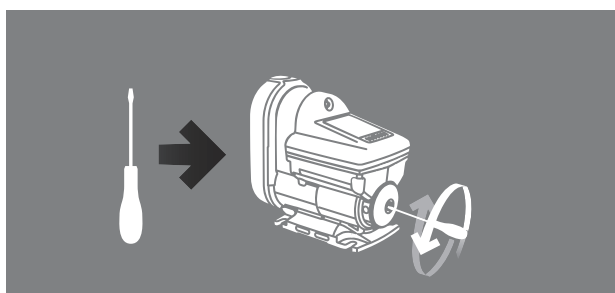

Fig. 16 Deblocking the pump

9.2 Controller settings

The pump will remember the controller settings even if it is turned off.

9.3 Priming

If the pump has been drained, it must be filled with liquid before startup. See section 4. *Starting up the product.*

TM06 4346 2015

TM06 4202 1615

10. Servicing the product



Warning

Before starting any work on the product, make sure that the power supply has been switched off and that it cannot be accidentally switched on.

10.1 Maintaining the product

10.1.1 Insect filter

The pump has an insect filter to prevent insects from nesting in the pump.

The filter is placed on the bottom and can easily be removed and cleaned with a stiff brush. See fig. 17.

Clean the insect filter once a year or as needed.

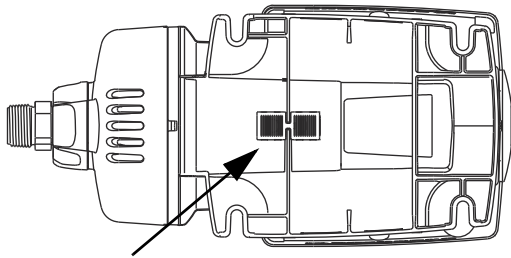

Fig. 17 Insect filter

10.1.2 Inlet and outlet valves

The pump is maintenance-free, but we recommend that you check and clean the inlet and outlet non-return valves once a year or as needed.

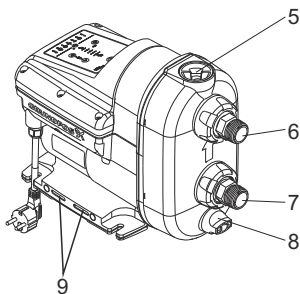

Fig. 18 SCALA pump

To remove the inlet non-return valve, follow the steps below:

1. Turn off the power supply and disconnect the power plug.
2. Shut off the water source.
3. Open a tap to release the pressure in the pipe system.
4. Close the isolating valves and/or drain the pipes.
5. Gradually open and remove the priming plug. See fig. 18 (pos. 5).
6. Remove the drain plug and drain the pump. See fig. 18 (pos. 8).
7. Unscrew the union nut holding the inlet connection. See fig. 18 (pos. 7). Depending on the installation type, it may be necessary to remove the pipes from both the inlet and outlet connections.
8. Pull out the inlet connection.
9. Pull out the inlet non-return valve.
10. Clean the non-return valve with warm water and a soft brush.
11. Assemble the components in reverse order.

To remove the outlet non-return valve, follow the steps below:

1. Turn off the power supply and disconnect the power plug.
2. Shut off the water source.
3. Open a tap to release the pressure in the pipe system.
4. Close the isolating valves and/or drain the pipes.
5. Gradually open and remove the priming plug. See fig. 18 (pos. 5). The plug and non-return valve are one unit.
6. Clean the non-return valve with warm water and a soft brush.
7. Assemble the components in reverse order.

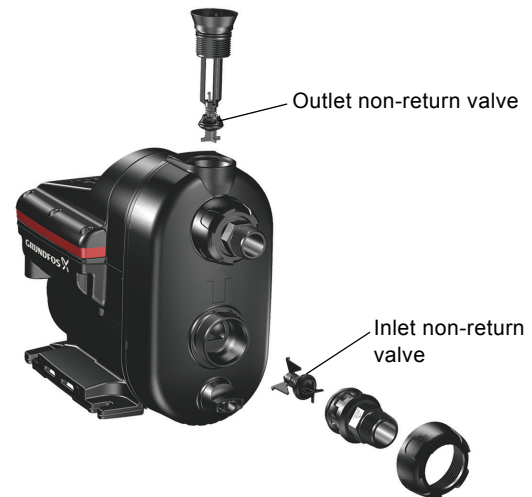

Fig. 19 Outlet and inlet non-return valves

10.2 Customer service information

For further information on service parts, see Grundfos Product Center on www.product-selection.grundfos.com.

10.3 Service kits

For further information on service kits, see Grundfos Product Center on www.grundfos.com.

11. Taking out of operation

For further information on how to take the product out of operation, see end-of-life documentation on www.grundfos.com.







TM06 4537 2515

TM06 3818 1015

TM06 4331 1915

12. Fault finding the product

12.1 Grundfos Eye operating indications

Grundfos Eye	Indication	Description
	No lights on.	Power off. The pump is not running.
	Two opposite green indicator lights running in the direction of rotation of the pump.	Power on. The pump is running.
	Two opposite green indicator lights at a 45 ° angle is the icon used throughout this document for pump running.	Power on. The pump is running.
	Two opposite green indicator lights permanently on.	Power on. The pump is not running.
	Two opposite red indicator lights flashing simultaneously.	Alarm. The pump has stopped.
	Two opposite red indicator lights is the icon used throughout this document for pump stopped.	Alarm. The pump has stopped.

12.2 Fault resetting

A fault indication can be reset in one of the following ways:

- When you have eliminated the fault cause, reset the pump manually by pressing the  button. The pump will then revert to normal duty.
- If the fault disappears by itself, the pump will attempt to reset automatically and the fault indication will disappear if automatic reset is successful.

















12.3 Fault finding chart

**Warning**

Before starting fault finding, switch off the power supply.

Make sure that the power supply cannot be accidentally switched on.

Fault	Grundfos Eye	Indicator light	Automatic reset	Cause	Remedy
1. The pump is not running.		-	-	a) Power supply failure	Switch on the power supply. Check the cables and cable connections for defects and loose connections and check for blown fuses in the electrical installation.
			Yes	b) The power supply is out of prescribed voltage range	Check the power supply and the pump nameplate. Reestablish the power supply within the prescribed voltage range.
			No	c) The shaft seal has seized up	See section 9. <i>Starting up the product after shutdown or standstill.</i>
			No	d) The pump is blocked by impurities	See section 9. <i>Starting up the product after shutdown or standstill.</i> Contact Grundfos Service if the problem persists.
			Yes	e) Dry running	Check the water source, and prime the pump.
			No	f) The maximum runtime has been exceeded	Check the installation for leakage and reset the alarm.
			No	g) The internal non-return valve is defective or blocked in completely or partly open position	Clean, repair or replace the non-return valve. See section 10. <i>Servicing the product.</i>
2. The pump is running.			-	a) Leakage from the pipework, or the non-return valve not properly closed due to impurities	Check and repair the pipework, or clean, repair or replace the non-return valve.
			-	b) Small continuous consumption	Check the taps and reconsider the usage pattern (ice machines, water evaporators for air-conditioning, etc.).
			-	c) The temperature is below freezing point	Consider protecting the pump and the installation against frost.
3. Pump performance is insufficient.		-	-	a) The pump inlet pressure is too low	Check the inlet conditions of the pump.
		-	-	b) The pump is undersized.	Replace the pump with a bigger pump.
		-	-	c) The inlet pipe, the inlet strainer or the pump is partly blocked by impurities	Clean the inlet pipe or the pump.
		-	-	d) Leakage in the inlet pipe	Repair the inlet pipe.
		-	-	e) Air in inlet pipe or the pump	Prime the inlet pipe and the pump. Check the inlet conditions of the pump.
		-	-	f) The required outlet pressure is too low for the installation	Increase the pressure setting (arrow up).
			Yes	g) The maximum temperature has been exceeded - the pump is running at reduced performance	Check the cooling conditions. Protect the pump against direct sunlight or any nearby heat sources.

Fault	Grundfos Eye	Indicator light	Automatic reset	Cause	Remedy
4. System overpressure.			Yes	a) The maximum pressure has been exceeded - the inlet pressure is higher than 6 bar, 0.6 MPa (85 psi)	Check the inlet conditions.
			Yes	b) The maximum pressure has been exceeded - equipment elsewhere in the system causes a high pressure at the pump (e.g. water heater or defective safety equipment)	Check the installation.
5. The pump can be reset, but runs only for a few seconds.			Yes	a) Dry running or water shortage	Check the water source, and prime the pump.
			Yes	b) The inlet pipe is blocked by impurities	Clean the inlet pipe.
			Yes	c) The foot or non-return valve is blocked in closed position	Clean, repair or replace the foot or non-return valve.
			Yes	d) Leakage in the inlet pipe	Repair the inlet pipe.
			Yes	e) Air in the inlet pipe or the pump	Prime the inlet pipe and the pump. Check the inlet conditions of the pump.
6. The pump can be reset, but starts repeatedly, immediately after stopping.			No	a) The internal non-return valve is defective or blocked in completely or partly open position.	Clean, repair or replace the non-return valve.
			No	b) The tank precharge pressure is not correct.	Adjust the tank precharge pressure to 70 % of the required outlet pressure.

13. Technical data

13.1 Operating conditions

Maximum ambient temperature:

1 x 208-230 V, 60 Hz:	45 °C (113 °F)
1 x 115 V, 60 Hz:	45 °C (113 °F)
1 x 200-240 V, 50/60 Hz:	55 °C (131 °F)

Maximum liquid temperature: 45 °C (113 °F)

Maximum system pressure: 10 bar, 1 MPa (145 psi)

Maximum inlet pressure: 6 bar, 0.6 MPa (85 psi)

Maximum head: 45 m (147 ft)

IP rating: X4D (outdoor installation)

Pumped liquid: Clean water

Noise level: < 45 dB(A)

13.2 Mechanical data

Pipe connections are R 1" or NPT 1".

13.3 Electrical data

Type	Supply voltage [V]	Frequency [Hz]	I _{max.} [A]	P1 [W]	Stand-by power [W]
					2
SCALA2	1 x 200-240	50/60	2.3 - 2.8	550	2
					2
SCALA2	1 x 208-230	60	2.3 - 2.8	550	2
SCALA2	1 x 115	60	5 - 5.7	560	2

Type	Supply voltage [V]	Frequency [Hz]	Plug
			IEC, type E&F
			IEC, type I
			IEC, type G
			None
SCALA2	1 x 200-240	50/60	
SCALA2	1 x 208-230	60	NEMA 6-15P
SCALA2	1 x 115	60	IEC, type B, NEMA 5-15P

13.3.1 Dimensions and weights

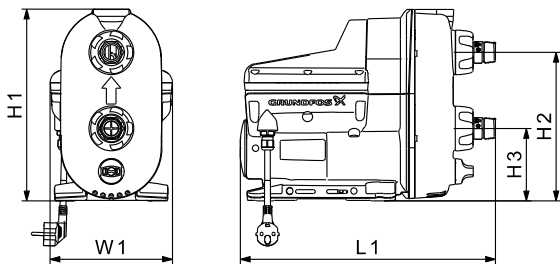

TM06 3305 5114

Type	H1 [mm] [inch]	H2 [mm] [inch]	H3 [mm] [inch]	W1 [mm] [inch]	L1 [mm] [inch]	Weight [kg] [lbs]
SCALA2	302 11.9	234 9.2	114 4.5	193 7.6	403 15.9	10 22

14. Disposal

This product has been designed with focus on the disposal and recycling of materials. The following disposal values apply to all variants of Grundfos SCALA pumps:

- minimum 85 % for recycling
- maximum 10 % for incineration
- maximum 5 % for depositing.

Values are percent of total weight.

This product or parts of it must be disposed of in an environmentally sound way according to local regulations.

Subject to alterations.

98880508 0615
ECM: XXXXXXXX