

INSTALLATION INSTRUCTIONS FOR WALL HUNG VALVE BOWLS



Thank you for selecting the Crane Plumbing low consumption toilet. To insure this product is installed properly, please read these instructions carefully before you begin. Be sure your installation conforms to local codes.

Before Beginning: Unpack the toilet and check to make sure there is no damage.

Closet Carrier Support: The appropriate wall carrier must be obtained for this unit. Refer to the instructions supplied with the carrier. For proper installation of a 4-bolt support system

wall cavity requirement, and rough-in information for waste outlet piping.

A Word of Caution: The new toilet is made of fine china like the best quality tableware. It is ruggedly constructed, however extra care should be exercised during installation when rough handling and the danger of dropped tools threaten to chip or crack it.

Water Supply: Refer to applicable Rough-in drawing for proper location of water supply.

Obtain the proper Flush Valve for use with this fixture. Refer to products from: Sloan, Delany, and Zurn for reference.

Installing the Toilet

1

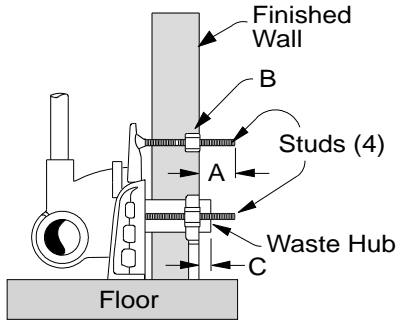

SIDE VIEW

The use of a Closet Carrier Support is required.

The fixture stud should extend 2-1/8" from the finished wall (A). Bearing washers and nuts must be flush with the wall (B).

The waste inlet hub should extend 5/16" from the finished wall (C). Use a felt or neoprene gasket (not a wax ring) on closet outlet.

Refer to instructions provided with the Closet Carrier System for specific installation requirements.

2 Follow support manufacturer's recommended setting of closet outlet connection.

NOTE: Bearing nuts and washers must be set to take full loading from the fixture allowing 1/16" clearance between fixture and wall.

Place the felt or neoprene gasket on the bowl outlet. (wax ring is not recommended) When the bowl is installed, The gasket must be compressed sufficiently against the hub to effect a gas and watertight seal.



Lift the bowl and move it toward the wall. Slip mounting studs through the corresponding holes in the bowl. Make sure the gasket is in place.

Install bowl on support using cap nuts and fiber washers with the back-up nuts and washers.

DO NOT APPLY TOP RIGHT FIBER WASHER AND CAP UNTIL OTHER CAP NUTS HAVE BEEN FIRMLY TIGHTENED USING A WRENCH.

DO NOT OVERTIGHTEN NUTS, AS VITREOUS CHINA EASILY CHIPS AND CRACKS.

Install top right cap nut with fiber washer and run up hand tight. Wrench tighten 1/4 turn.

Apply sealant to gap between bowl and finished wall. Wipe away excess sealant.

Pour water into the bowl to prevent the escape of sewer gas.

CLICK ANYWHERE on THIS PAGE to RETURN to BACK FLUSH & WALL MOUNT TOILETS at InspectApedia.com



FIXTURES COMPLY WITH AMERICANS WITH DISABILITIES ACT WHEN MOUNTED AT RIM HEIGHT OF 17" ABOVE FINISHED FLOOR.

3446 Placidus

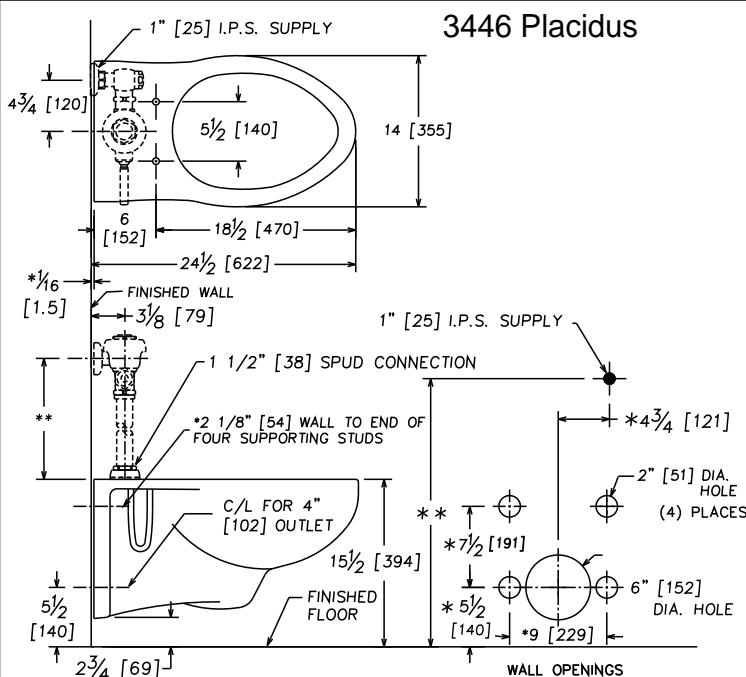

* THESE DIMENSIONS MUST BE MAINTAINED FOR PROPER INSTALLATION

** VARIABLE-CHECK WITH MANUFACTURER OF FLUSH VALVE FOR PROPER ROUGH-IN

3449 Placidus

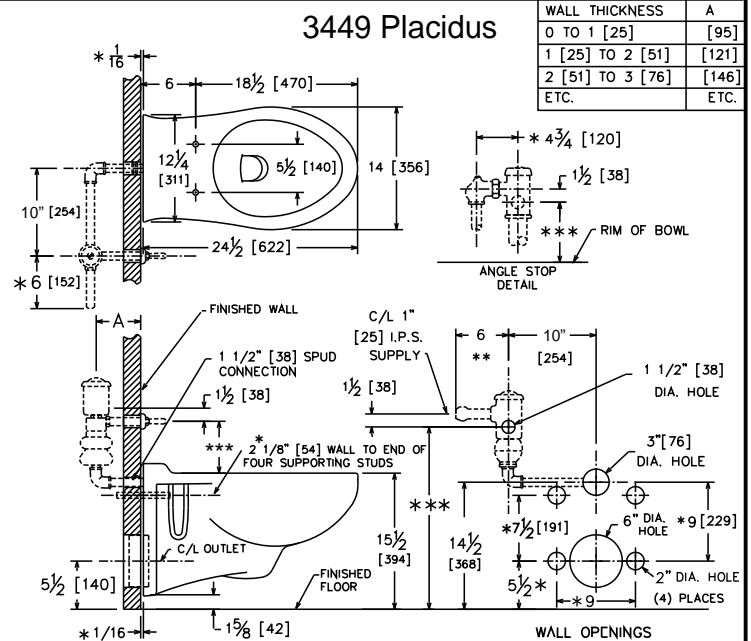

WALL THICKNESS	A
0 TO 1 [25]	[95]
1 [25] TO 2 [51]	[121]
2 [51] TO 3 [76]	[146]
ETC.	ETC.

* THESE DIMENSIONS MUST BE MAINTAINED FOR PROPER INSTALLATION

** ROUGH IN FOR ANGLE STOP WHEN REQUIRED

*** VARIABLE-CHECK WITH MANUFACTURER OF FLUSH VALVE FOR PROPER ROUGH-IN

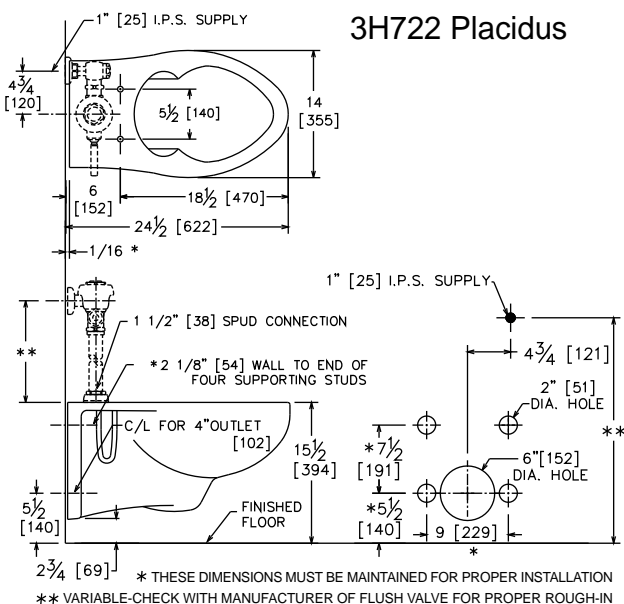
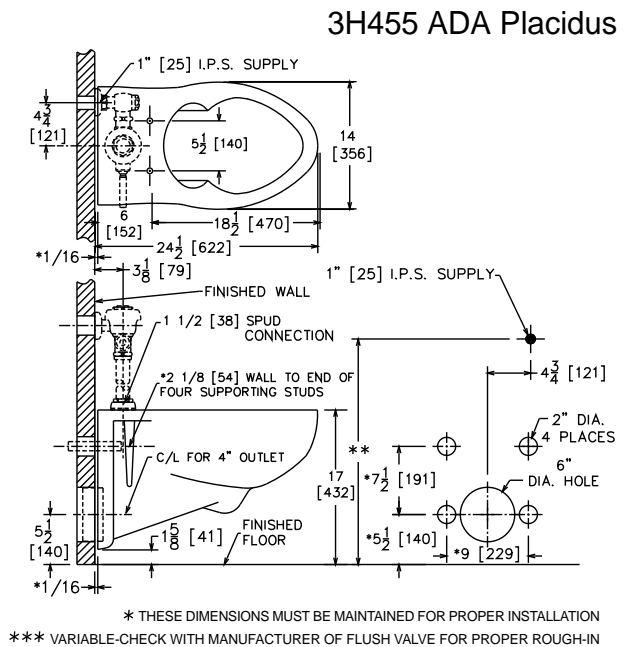
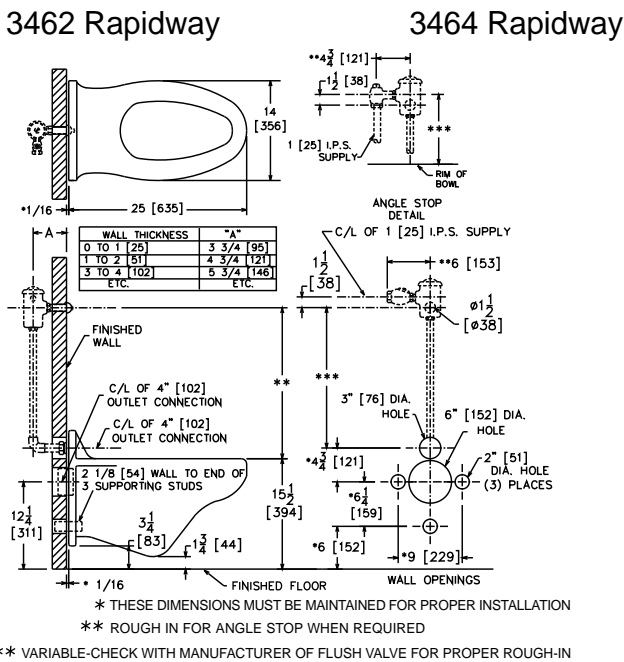
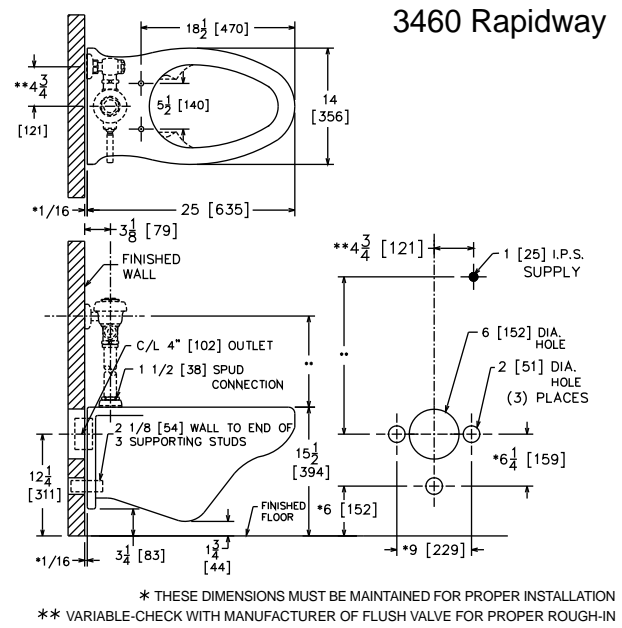
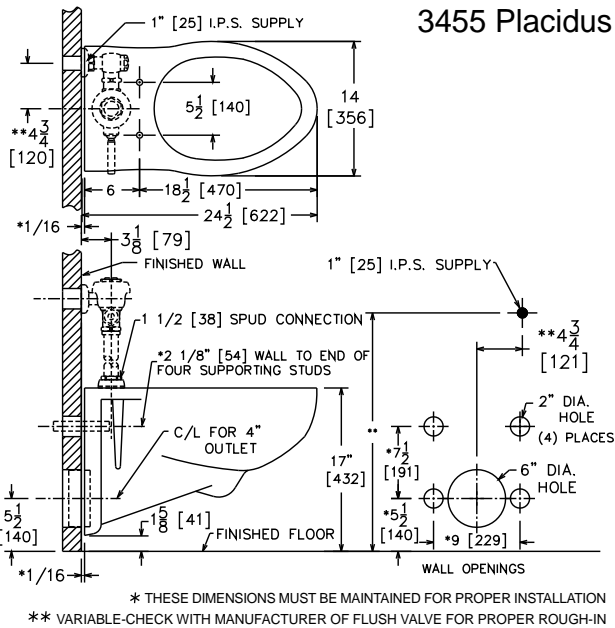

DAY TO DAY CLEANING - Wash with warm water, a soft cloth and mild liquid detergent.

WARRANTY - A limited warranty of five (5) years applies to this product. Retain invoice in case warranty service becomes necessary. If seeking warranty service, telephone: (419) 522-4211 for complete warranty information and exclusions.

