

CLICK ANYWHERE on THIS PAGE to return to CLACK WATER SOFTENERS
INFO & MANUALS at InspectApedia.com

Pro  H₂O™ Series
WS1 & WS1 CD Matrix
1" & 1.25" Control Valve
with Fully Adjustable Cycles

Operation and Instruction Manual



Table of Contents

Installation	4
Specification Table.....	5
Start-up Instructions	6
Filter Instructions	7
Softener Set-up	11
Softener Setting Options	13
Filter System Set-up	14
Installer/User Display Settings	17
Installation	23
Service Instructions	25
Parts & Drawings.....	30
Troubleshooting Procedures	43
Notes	45
WS1 CD Matrix Control Programming Manual	46-67

Introduction

This manual is about a control valve to be used on water softeners or water filters. The manual is designed to aid water treatment equipment manufacturers in the selection of the various control valve options. Information in this manual is different than what is needed for installation and servicing of a particular water treatment system. This manual is not intended to be used as a manual for a complete water softener or filter. Certain parts of the manual will serve as aids to manufacturers in the writing and layout of the manuals for installers and service personnel.

The following general warnings and the specifications in Table 1 must appear in the OEM's System Manual.

The control valve, fittings and/or bypass are designed to accommodate minor plumbing misalignments but are not designed to support the weight of a system or the plumbing.

Do not use Vaseline, oils, other hydrocarbon lubricants or spray silicone anywhere. A silicone lubricant may be used on black o-rings but is not necessary. **Avoid any type of lubricants, including silicone, on the clear lip seals.**

The nuts and caps are designed to be unscrewed or tightened by hand or with the special plastic wrench. If necessary a pliers can be used to unscrew the nut or cap. Do not use a pipe wrench to tighten or loosen nuts or caps. Do not place a screwdriver in the slots on caps and/or tap with a hammer.

Do not use pipe dope or other sealants on threads. Use Teflon tape on the threaded inlet, outlet and drain fittings. Teflon tape is not necessary on the nut connection or caps because of o-ring seals.

After completing any valve maintenance involving the drive assembly or the drive cap assembly and pistons, press and hold NEXT and REGEN buttons for 3 seconds or unplug power source jack from the printed circuit board (black wire) and plug back in. This resets the electronics and establishes the service piston position. The display should flash all wording, then flash the software version and then reset the valve to the service position.

All plumbing should be done in accordance with local plumbing codes. The pipe size for the drain line should be a minimum of ½". Backwash flow rates in excess of 7 gpm or length in excess of 20' require ¾" drain line.

Solder joints near the drain must be done prior to connecting the drain line flow control fitting. Leave at least 6" between the drain line control fitting and solder joints when soldering pipes that are connected on the drain line control fitting. Failure to do this could cause interior damage to the drain line flow control fitting.

When assembling the installation fitting package (inlet and outlet), connect the fitting to the plumbing system first and then attach the nut, split ring and o-ring. Heat from soldering or solvent cements may damage the nut, split ring or o-ring. Solder joints should be cool and solvent cements should be set before installing the nut, split ring and o-ring. Avoid getting primer and solvent cement on any part of the o-rings, split rings, bypass valve or control valve.

Plug into an electrical outlet. Note: All electrical connections must be connected according to local codes. (Be certain the outlet is uninterrupted.)

Install grounding strap on metal pipes.

Table 1
Specifications which must be included in OEM's Manual

Minimum/Maximum Operating Pressures	20 psi (138 kPa) -125 psi (862 kPa)	
Minimum/Maximum Operating Temperatures	40°F (4°C) - 110°F (43°C)	
AC Adapter:	<u>U.S.</u>	<u>International</u>
Supply Voltage	120 V AC	230 V AC
Supply Frequency	60 Hz	50 Hz
Output Voltage	12 V AC	12 V AC
Output Current	500 mA	500 mA
No user serviceable parts are on the PC board, the motor, or the AC adapter. The means of disconnection from the main power supply is by unplugging the AC adapter from the wall.		

Table 2 contains a summary of specifications for the control valve and bypass valve.

Table 2
Quick Reference Specifications

Service flow rate 1" (includes bypass and meter)	27 gpm (102.2 lpm) @15 psig (103 kPa) drop	
Backwash flow rate 1" (includes bypass)	27 gpm (102.2 lpm) @25 psig (172 kPa) drop	
Service flow rate 1.25" (includes meter)	34 gpm (128.7 lpm) @15 psig (103 kPa) drop	
Service flow rate 1.25" (includes bypass and meter)	32 gpm (121.1 lpm) @15 psig (103 kPa) drop	
Backwash flow rate 1.25"	32 gpm (121.1 lpm) @25 psig (172 kPa) drop	
Backwash flow rate 1.25" (includes bypass)	30 gpm (113.5 lpm) @25 psig (172 kPa) drop	
Minimum/Maximum Operating Pressures	20 psi (138 kPa) -125 psi (862 kPa)	
Minimum/Maximum Operating Temperatures	40°F (4°C) - 110°F (43°C)	
AC Adapter:	<u>U.S.</u>	<u>International</u>
Supply Voltage	120 V AC	230V AC
Supply Frequency	60 Hz	50 Hz
Output Voltage	12 V AC	12 V AC
Output Current	500 mA	500 mA
Regenerant Refill Rate	0.5 gpm (1.9 lpm)	
Injectors	See Injector Graphs	
Drain Line Flow Controls	See Table 7	
Inlet / Outlet Fitting Options	<ul style="list-style-type: none"> - 1" NPT elbow which has a unique drill out feature to allow a ¼" NPT connection to the inlet and/or outlet - ¾" & 1" PVC solvent weld fitting - ¾" or 1" straight brass sweat fittings - 1" or 1 ¼" plastic male NPT fittings - 1" or 1 ¼" plastic male BSPT fittings - 1 ¼" & 1 ½" brass sweat fitting - 1 ¼" & 1 ½" PVC solvent fitting - ¾" or 1" PEX fittings 	
Distributor Tube Opening WS1ER Valve	1.05" outside diameter (¾" NPS)	
Distributor Tube Opening WS1.25ER Valve	1.32" outside diameter (1" NPS)	
	32 mm outside diameter	
Tank Thread	2½" - 8 NPSM	
Control Valve Weight	4.5 lbs.	2.0 kg
PC Board Memory	Nonvolatile EEPROM (electrically erasable programmable read only memory)	
Compatible with regenerants/chemicals	Sodium chloride, potassium chloride, potassium permanganate, sodium bisulfite, chlorine and chloramines	

Control Valve Function and Cycles of Operation

This glass filled Noryl¹ (or equivalent) fully automatic control valve is designed as the primary control center to direct and regulate all cycles of a water softener or filter. When the WS1CH control valve is manufactured as a softener, the control valve can be ordered to perform downflow or upflow regeneration. The WS1.25CH control valve is only available in downflow regeneration. When the WS1CH or WS1.25CH control valve is set up as a filter, the control valve can be set to perform downflow regeneration or simply backwash. The control valve can be set to regenerate on demand (consumption of a predetermined amount of water) and/or as a time clock (passage of a particular number of days). The control valve can be set so that a softener can meet the Water Quality Association (WQA) Standard S100 or NSF/ANSI Standard 44 efficiency rating.

It is not recommended to change control valves from downflow to upflow brining or vice versa in the field. The valve bodies for downflow and upflow are unique to the regeneration type and should not be interchanged. A mismatch of valve body and regeneration piston will result in hard water bypass during service.

The control valve is compatible with a variety of regenerants and resin cleaners. The control valve is capable of routing the flow of water in the necessary paths to regenerate or backwash water treatment systems. The injector regulates the flow of brine or other regenerants. The control valve regulates the flow rates for backwashing, rinsing, and the replenishing of treated water into a regenerant tank, when applicable.

The control valve uses no traditional fasteners (e.g. screws); instead clips, threaded caps and nuts and snap type latches are used. Caps and nuts only need to be firmly hand tightened because radial seals are used. Tools required to service the valve include one small blade screw driver, one large blade screw driver, pliers and a pair of hands. A plastic wrench is available which eliminates the need for screwdrivers and pliers. Disassembly for servicing takes much less time than comparable products currently on the market. Control valve installation is made easy because the distributor tube can be cut ½” above to ½” below the top of tank thread. The distributor tube is held in place by an o-ring seal and the control valve also has a bayonet lock feature for upper distributor baskets.

The AC adapter power pack comes with a 15 foot power cord and is designed for use with the control valve. The AC adapter power pack is for dry location use only. The control valve remembers all settings until the battery power is depleted if the power goes out. After the battery power is depleted, the only item that needs to be reset is the time of day; other values are permanently stored in the nonvolatile memory. The control valve battery is not rechargeable but is replaceable.

The control valve’s unique design and electronics allow the OEM the flexibility shown in Tables 3 and 4.

**Table 3
Regeneration Cycles Softening**

WS1CH & WS1.25CH Downflow Regenerant Refill After Rinse	WS1CH & WS1.25CH Downflow Regenerant Prefill	WS1CH only Upflow Regenerant Refill After Rinse	WS1CH only Upflow Regenerant Prefill
1 st Cycle: Backwash	1 st Cycle: Fill	1 st Cycle: UP Brine	1 st Cycle: Fill
2 nd Cycle: dn Brine	2 nd Cycle: Softening	2 nd Cycle: Backwash	2 nd Cycle: Softening
3 rd Cycle: Backwash	3 rd Cycle: Backwash	3 rd Cycle: Rinse	3 rd Cycle: UP Brine
4 th Cycle: Rinse	4 th Cycle: dn Brine	4 th Cycle: Fill	4 th Cycle: Backwash
5 th Cycle: Fill	5 th Cycle: Backwash	5 th Cycle: Service	5 th Cycle: Rinse
6 th Cycle: Service	6 th Cycle: Rinse		6 th Cycle: Service
	7 th Cycle: Service		

¹ Noryl is a trademark of General Electric.

Table 4
Regeneration Cycles Filtering

WS1CH & WS1.25CH Downflow Regenerant Refill After Rinse	WS1CH & WS1.25CH No Regeneration
1 st Cycle: Backwash 2 nd Cycle: Regenerate 3 rd Cycle: Backwash 4 th Cycle: Rinse 5 th Cycle: Fill 6 th Cycle: Service	1 st Cycle: Backwash 2 nd Cycle: Rinse 3 rd Cycle: Service

The control valve with a water meter can be set for Demand Initiated Regeneration (DIR) only, Time Clock operation only or DIR and Time Clock which ever comes first, depending upon what settings are selected for Day Override and Gallon Capacity.² See Table 5.

If a control valve does not contain a meter, the valve can only act as a time clock, and day override should be set to any number and gallon capacity should be set to off.

Table 5
DIR/Time Clock Options

DIR	Time Clock	Reserve Capacity	Softener	Filter		Settings ³	
				Regenerant	Backwash Only	Day Override	Gallon Capacity
Yes		Automatically calculated	Yes			Off	Auto
Yes		If desired enter a value less than estimated capacity	Yes	Yes	Yes	Off	Any Number
Yes	Yes	Automatically calculated	Yes			Any Number	Auto
Yes	Yes	If desired enter a value less than estimated capacity	Yes	Yes	Yes	Any Number	Any number
	Yes	None	Yes	Yes	Yes	Any Number	Off

For DIR Softeners, there are two options for setting the Gallons Capacity. The Gallons Capacity is automatically calculated if set to AUTO. Reserve Capacity is automatically estimated based on water usage if AUTO is used. The other option is to set the Gallons Capacity to a specific number. If a specific number is set, reserve capacity is zero, unless the value is manually set (i.e. the manufacturer intentionally sets the gallon capacity number below the calculated capacity of the system).

If the system is set up as a prefill upflow softener the control valve can also be set to normal or proportional brining. If proportional brining is selected, the actual salt level fill will be calculated by dividing the actual volume treated by the calculated volumetric capacity, then multiplying the salt level fill selected by this percentage.

The control valve can also be set to regenerate immediately or at the next regeneration time by changing the Regeneration Time Option. There are three choices for settings:

1. "NORMAL" means regeneration will occur at the preset regeneration time.
2. "on 0" means regeneration will occur when the gallons capacity reaches zero.
3. "NORMAL" and "on 0" means the regeneration will occur at the preset regeneration time unless the gallons capacity reaches zero. If the gallons capacity reaches zero the regeneration will begin 10 minutes after no water usage.

The user can initiate manual regeneration. The user has the option to request the manual regeneration at the delayed regeneration time or to have the regeneration occur immediately:

1. Pressing and releasing the REGEN button. "Regen Today" will flash on the display and the regeneration will occur at the delayed regeneration time. The user can cancel the request by pressing and releasing the REGEN button. This method of manually initiating regeneration is not allowed when the system is set to "on 0", i.e. to immediately regenerate when the gallon capacity reaches zero.
2. Pressing and holding the REGEN button for approximately 3 seconds will immediately start the regeneration. The user cannot cancel this request, except by resetting the control by pressing NEXT and REGEN buttons simultaneously for 3 seconds.

The WS1CH & WS1.25CH control valves consist of the following components:

- | | |
|--|---|
| 1. Drive Assembly | 6. Drain Line Flow Control and Fitting Assembly |
| 2. Drive Cap Assembly, Main Piston and Regenerant Piston | 7. Water Meter or Meter Plug |
| 3. Spacer Stack Assembly | 8. Mixing Valve (optional) |
| 4. Injector Cap, Screen, Injector Plug and Injector | 9. Installation Fitting Assemblies |
| 5. Refill Flow Control Assembly or Refill Port Plug | 10. Bypass Valve (optional) |

Note: The WS1CH & WS1.25CH share many of the same components. Refer to Figure 6 for control valve identification.

² See Installer Display Settings, OEM Softener System Setup and OEM Filter System Setup for explanations of Day Override and Gallon Capacity.

³ Day Override and Gallon Capacity can not both be set to "oFF" at the same time.

OEM General Instructions

The control valve offers multiple procedures that allow the valve to be modified to suit the needs of the installation. These procedures are:

- OEM Setup
- OEM Softener System Setup
- OEM Filter System Setup
- Installer Display Settings
- User Display Settings
- Diagnostics
- Valve History

Once the OEM Setup has been set, the other procedures can be accessed in any order. Details on each of the procedures are provided on the following pages.

At the discretion of the manufacturer, the field technician can access all settings. To “lock out” access to diagnostic and valve history displays and modifications to settings except hardness, day override, time of regeneration and time of day by anyone but the manufacturer, press ▼, NEXT, ▲, and SET CLOCK in sequence after settings are made. To “unlock”, so other displays can be viewed and changes can be made, press ▼, NEXT, ▲, and SET CLOCK in sequence.

When in operation normal user displays such as time of day, gallons remaining before regeneration, days remaining before regeneration or current flow rate are shown. When stepping through a procedure, if no buttons are pressed within five minutes, the display returns to a normal user display. Any changes made prior to the five minute time out are incorporated.

To quickly exit OEM Softener Setup, OEM Filter Setup, Installer Display Settings, Diagnostics or Valve History press SET CLOCK. Any changes made prior to the exit are incorporated.

When desired, all information in Diagnostics may be reset to zero when the valve is installed in a new location. To reset to zero, press NEXT and ▼ buttons simultaneously to go to the Service/OEM 1 screen, and release. Press ▲ and ▼ simultaneously to reset diagnostic values to zero. Screen will return to User Display.

Sometimes it is desirable to have the valve initiate and complete two regenerations within 24 hours and then return to the preset regeneration procedure. It is possible to do a double regeneration if the control valve is set to “NORMAL” or “NORMAL + on 0” in OEM Softener System Setup or OEM Filter System Setup. To do a double regeneration:

1. Press the “REGEN” button once. REGEN TODAY will flash on the display.
2. Press and hold the “REGEN” button for three seconds until the valve regeneration initiates.

Once the valve has completed the immediate regeneration, the valve will regenerate one more time at the preset regeneration time.

Proportional Brining

If the system is set up as a prefill upflow softener, the control valve can also be set to normal or proportional brining.

This step will appear after Step 8S and before Step 9S if the system is set up as a prefill upflow softener. The following options can be selected:

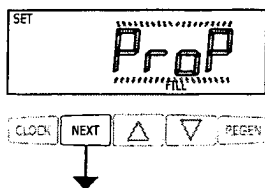

- NORMAL FILL - System always prefills with the salt level selected.
 - ProP FILL - If proportional brining is selected the actual salt level fill will be calculated by dividing the actual volume treated by the calculated volumetric capacity, then multiply the salt level fill selected by this percentage.
- Press NEXT to go to the next step. Press REGEN to return to the previous step.

OEM Cycle Sequence

OEM Cycle Sequence instructions allows the OEM to set meter size, dPswitch or alternating valve, pre or post fill and dn or up brine where applicable. Fill and brine values are ignored when the system is set up as a filter. The OEM Softener System Setup or the OEM Filter System Setup allow the OEM to set how long cycles will last.

Verify the correct valve body, main piston, regenerant piston, and stack are being used, and that the injector or injector plug(s) are in the correct locations. See Compliance Table in Service Instructions under Injector Cap, Screen, Injector Plug and Injector section and Figure 6.

The following is an example of how to set a valve so that when regeneration is initiated BACKWASH occurs first, dn BRINE occurs second, RINSE occurs third, and FILL occurs fourth.

STEP 1C

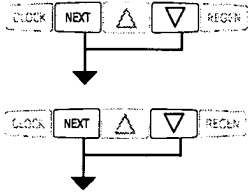

Step 1C – Press NEXT and ▼ simultaneously for 3 seconds and release. Then press NEXT and ▼ simultaneously for 3 seconds and release. If screen in Step 2C does not appear in 5 seconds the lock on the valve is activated. To unlock press ▼, NEXT, ▲, and SET CLOCK in sequence, then press NEXT and ▼ simultaneously for 3 seconds and release. Then press NEXT and ▼ simultaneously for 3 seconds and release.

STEP 2C

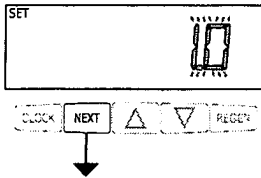

Step 2C – Use the ▲ or ▼ to select 1.0 for WS1CH or 1.25 for WS1.25CH valve. Press NEXT to go to Step 3C. Press REGEN to exit OEM Cycle Sequence.

STEP 3C

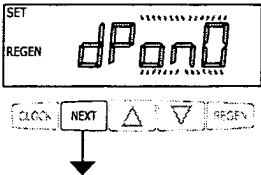

Step 3C – Allows selection of one of the following:

- an outside signal to initiate a regeneration;
- the Control Valve to act as an alternator; or
- the Control Valve to have no hard water bypass.

Selecting the use of an outside signal to initiate a regeneration:

Selection only matters if a connection is made to the two pin connector labeled DP SWITCH located on the printed circuit board. Following is an explanation of the options:

dPon0 - If the dP switch is closed for an accumulative time of 2 minutes a regeneration will occur immediately.

dPdel - If the dP switch is closed for an accumulative time of 2 minutes a regeneration will occur at the scheduled regeneration time.

HoLd - If the dP switch is closed a regeneration will be prevented from occurring.

Selecting the Control Valve to act as an alternator:

Note: Also must do one of the following:

- If set up for a softener in Step 9S set Volume Capacity in GALLONS, in Step 10S select Regeneration Time Option “on 0” and in Step 3I select Day Override “oFF”.
- If set up for a filter, in Step 8F set Volume Capacity in GALLONS, in Step 9F select Regeneration Time Option “on 0” and in Step 3I select Day Override “oFF”.

Select ALTA for the control valve that has the two pin connector labeled DRIVE connected to the alternator valve motor.

Select ALTb for the control valve that will not be connected to the alternator valve motor.

Configuring the Control Valve for No Hard Water Bypass Operation:

Selection requires a connection to a Clack Two Way Motorized Valve or a Clack Motorized Alternator Valve (MAV) is made to the two pin connector labeled ALTERNATOR DRIVE located on the printed circuit board. The Clack Two Way Motorized Valve can be connected to the valve outlet in either direction. The B port of a MAV must be plugged and the valve outlet connected to the A port. The Clack Two Way Motorized Valve or a Clack Motorized Alternator Valve will be driven closed before the first regeneration cycle that is not FILL or SOFTENING or FILTERING, and be driven open after the last regeneration cycle that is not FILL.

Press NEXT to go to Step 4C. Press REGEN to return to previous step.

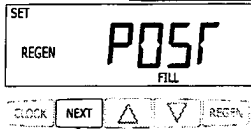
STEP 4C

STEP 4C – Set Refill option using ▼ or ▲ buttons:

- “PoST” to refill the brine tank after the final rinse; or
- “PrE” to refill the brine tank two hours before the regeneration time set.

If selecting “Filter” in Step 2F, “POST” should always be selected.

Press NEXT to go to Step 5C. Press REGEN to return to previous step.

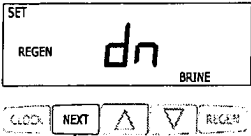
STEP 5C

STEP 5C – Set regenerant downflow or upflow using ▼ or ▲ buttons:

- “dn” if the regenerant is to flow downward through the media; or
- “UP” if the regenerant is to flow upward through the media. Step 2C must be set to 1 for a 1” valve.

Prior to selecting a regenerant flow direction, verify the correct valve body, main piston, regenerant piston, and stack are being used, and that the injector or injector plug(s) are in the correct locations. See Compliance Table in Service Instructions under Injector Cap, Screen, Injector Plug and Injector section and Figure 6. This screen will not display if the unit is set up as a 1.25”, 1.5”, 2” or filter valve.

If selecting “Filter” in Step 2F, “dn” should always be selected.

Press NEXT to exit OEM Cycle Sequence. Press REGEN to return to previous step.

RETURN TO NORMAL MODE

OEM Softener System Setup

In OEM Softener System Setup the OEM chooses the value for the specified cycles (the order of which is specified by the selections for Step 4C and Step 5C in OEM Cycle Sequence) and specifies other operating parameters for the system. If a cycle is present the value can be set to off. Fill is in pounds of salt and all other cycles are in minutes.

Step 4C	Step 5C	Cycle Order
Post	dn	Backwash, Brine, Backwash, Rinse, Fill
Pre	dn	Fill, Service, Backwash, Brine, Backwash, Rinse
Post	UP	Brine, Backwash, Rinse, Fill
Pre	UP	Fill, Service, Brine, Backwash, Rinse

Note: If “Pre” is selected in Step 4C and “UP” is selected in Step 5C, the proportional brining display will appear after the Grains Capacity display (Step 8S).

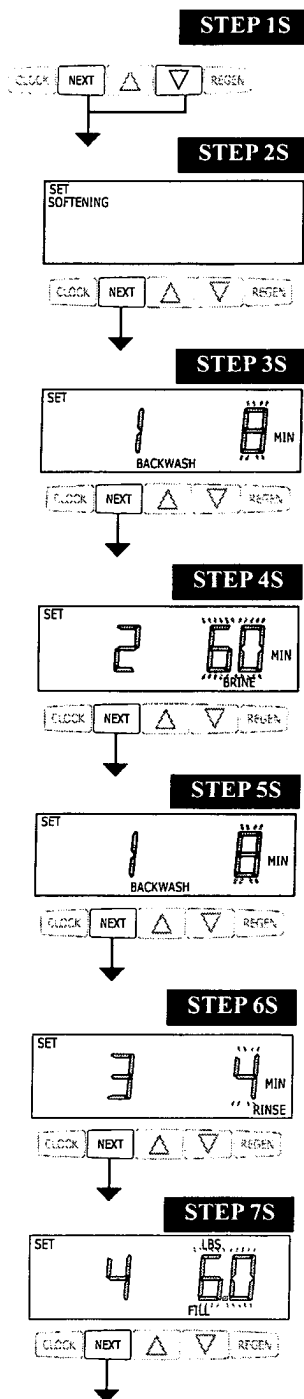

Step 1S – Press NEXT and ▼ simultaneously for 3 seconds and release. If screen in Step 2S does not appear in 5 seconds the lock on the valve is activated. To unlock press ▼, NEXT, ▲, and SET CLOCK in sequence, then press NEXT and ▼ simultaneously for 3 seconds and release.

Step 2S – Choose SOFTENING using the ▼ or ▲ button. Press NEXT to go to Step 3S. Press REGEN to exit OEM Softener System Setup.

Step 3S – Select the time for the first cycle (which in this example is BACKWASH) using the ▼ or ▲ button. Press NEXT to go to Step 4S. Press REGEN to return to previous step.

Step 4S – Select the time for the second cycle (which in this example is dn BRINE) using the ▼ or ▲ button. Verify the correct valve body, main piston, regenerant piston, and stack are being used, and that the injector or injector plug(s) are in the correct locations. See Compliance Table in Service Instructions under Injector Cap, Screen, Injector Plug and Injector section and Figure 6. Press NEXT to go to Step 5S. Press REGEN to return to previous step.
NOTE: The display will flash between cycle number and time, and brine direction (dn or UP).

Step 5S – Select the time for the third cycle (which in this example is BACKWASH) using the ▼ or ▲ button. Press NEXT to go to Step 6S. Press REGEN to return to previous step.

Step 6S – Select the time for the fourth cycle (which in this example is RINSE) using the ▼ or ▲ button. Press NEXT to go to Step 7S. Press REGEN to return to previous step.

Step 7S – Select the LBS for the fifth cycle (which in this example is FILL) using the ▼ or ▲ button. Press NEXT to go to Step 8S. Press REGEN to return to previous step.

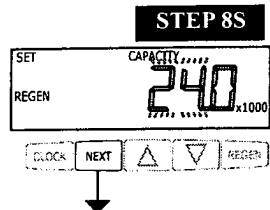

Step 8S –Set Grains Capacity using the ▼ or ▲ button. The ion exchange capacity is in grains of hardness as calcium carbonate for the system based on the pounds of salt that will be used. Calculate the pounds of salt using the fill time previously selected. The allowable grains capacity range varies from 5000 to 500,000 grains. Grains capacity is affected by the fill time. The grains capacity for the selected fill time should be confirmed by OEM testing. The capacity and hardness levels entered are used to automatically calculate reserve capacity when gallon capacity is set to AUTO. Press NEXT to go to Step 9S. Press REGEN to return to previous step.

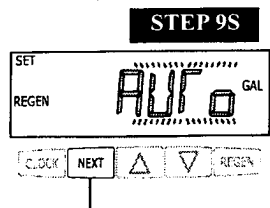

Step 9S – Set Volume Capacity using the ▼ or ▲ button. If value is set to:

- “AUTO” capacity will be automatically calculated and reserve capacity will be automatically estimated;
- “oFF” regeneration will be based solely on the day override set (see Installer Display Settings Step 3I); or
- as a number (allowable range 20 to 250,000) regeneration initiation will be based off the value specified.

If “oFF” or a number is used, hardness display will not be allowed to be set in Installer Display Settings Step 2I. See Table 8 for more detail. Press NEXT to go to Step 10S. Press REGEN to return to previous step.

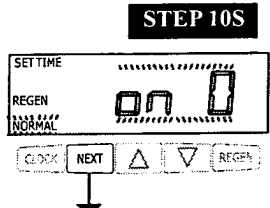

Step 10S – Set Regeneration Time Options using the ▼ or ▲ button. If value is set to:

- “NORMAL” means regeneration will occur at the preset time;
- “on 0” means regeneration will occur immediately when the gallons capacity reaches 0 (zero); or
- “NORMAL + on 0” means regeneration will occur at one of the following:
 - the preset time when the gallons capacity falls below the reserve or the specified number of days between regenerations is reached, whichever comes first; or
 - after 10 minutes of no water usage when the gallons capacity reaches 0 (zero). See Table 8 for more detail.

Press NEXT to go to Step 11S. Press REGEN to return to previous step.

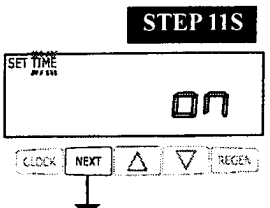

Step 11S – Set Relay operation using the ▼ or ▲ button. The choices are:

- Relay Actuation Time: After the start of a regeneration the amount of time that should pass prior to activating the relay. The start of regeneration is defined as the first backwash cycle, Dn brine cycle or UP brine cycle which ever comes first.
- Set Gal Softening on: Relay activates after a set number of gallons have been used while in service and then deactivates after a set period of time or after the meter stops registering flow, whichever comes first.
- Set Gal Softening Regen on: Relay activates after a set number of gallons have been used while in service or during regeneration and then deactivates after a set period of time or after the meter stops registering flow, whichever comes first.
- Set Gal HoLd: Relay closes every set number of gallons and releases when the ▲ button is pressed.
- Set Off: If set to Off, Steps 12S and 13S will not be shown.

Press NEXT to go to Step 12S. Press REGEN to return to previous step.

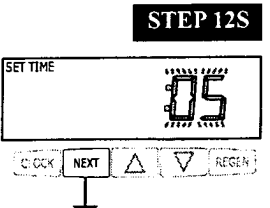

Step 12S: Set Relay Actuation Time or Gallons using the ▲ or ▼ buttons. The choices are:

- Relay Actuation Time: After the start of a regeneration the amount of time that should pass prior to activating the relay. The start of regeneration is defined as the first backwash cycle or Dn brine cycle, which ever comes first. Ranges from 1 minute to 500 minutes.
- Relay Actuation Gallons: Relay activates after a set number of gallons have passed. Ranges from 1 to 100 gallons.
- Relay HoLd: Relay closes every set number of gallons. Ranges from 1,000 to 99,000,000 gallons.

Press NEXT to go to Step 13S. Press REGEN to return to previous step.

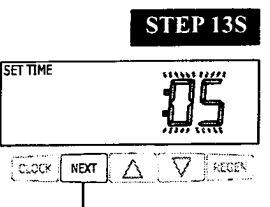

Step 13S: Set Relay Deactivate Time using the ▲ or ▼ buttons.

- If Set Time on is selected in Step 11S the relay will deactivate after the time set has expired. Ranges from 1 second to 500 minutes.
- If Set Gal Softening on or Set Gal Softening Regen on is selected in Step 11S the relay will deactivate after the time set has expired or after the meter stops registering flow, whichever comes first. Ranges from 1 second to 500 minutes.
- Does not display for Gal HoLd selection.

Press NEXT to go to Step 14S. Press REGEN to return to previous step.



Step 14S: Set the Service Call Indicator by using the ▲ or ▼ buttons. Range is in ¼ of a year increments from 0.25 to 9.75 years. Selecting OFF will disable this feature.

Press NEXT to exit OEM Softener System Setup. Press REGEN to return to previous step.

RETURN TO NORMAL MODE

Table 8

Softener Setting Options

Gallons Capacity	Regeneration Time Option	Day Override	Result ⁸
AUTO	NORMAL	oFF	Reserve capacity automatically estimated. Regeneration occurs when gallons capacity falls below the reserve capacity at the next Regen Set Time.
AUTO	NORMAL	Any number	Reserve capacity automatically estimated. Regeneration occurs at the next Regen Set Time when gallons capacity falls below the reserve capacity or the specified number of days between regenerations is reached.
Any number	NORMAL	oFF	Reserve capacity <u>not</u> automatically estimated. Regeneration occurs at the next Regen Set Time when gallons capacity reaches 0.
oFF	NORMAL	Any number	Reserve capacity <u>not</u> automatically estimated. Regeneration occurs at the next Regen Set Time when the specified number of days between regenerations is reached.
Any number	NORMAL	Any number	Reserve capacity <u>not</u> automatically estimated. Regeneration occurs at the next Regen Set Time when gallons capacity reaches 0 or the specified number of days between regenerations is reached.
AUTO	On 0	oFF	Reserve capacity <u>not</u> automatically estimated. Regeneration occurs immediately when gallons capacity reaches 0. Time of regeneration will not be allowed to be set because regeneration will always occur when gallons capacity reaches 0.
Any number	On 0	oFF	Reserve capacity <u>not</u> automatically estimated. Regeneration occurs immediately when gallons capacity reaches 0. Time of regeneration will not be allowed to be set because regeneration will always occur on 0.
AUTO	NORMAL on 0	oFF	Reserve capacity automatically estimated. Regeneration occurs when gallons capacity falls below the reserve capacity at the next Regen Set Time or regeneration occurs immediately after 10 minutes of no water usage when gallon capacity reaches 0.
AUTO	NORMAL on 0	Any number	Reserve capacity automatically estimated. Regeneration occurs at the next Regen Set Time when gallons capacity falls below the reserve capacity or the specified number of days between regenerations is reached or regeneration occurs immediately after 10 minutes of no water usage when gallon capacity reaches 0.
Any number	NORMAL on 0	Any number	Reserve capacity <u>not</u> automatically estimated. Regeneration occurs at the next Regen Set Time when the specified number of days between regenerations is reached or regeneration occurs immediately after 10 minutes of no water usage when gallon capacity reaches 0.

⁸Reserve capacity estimate is based on history of water usage.

OEM Filter System Setup

In OEM Filter System Setup the order of the cycles is preset to Backwash, dn Brine, Backwash, Rinse and Fill. Fill is set in gallons and all other cycles are set in minutes. Each cycle can be set to off. Fill is always Post Fill even if Pre is selected in Step 4C.

STEP 1F

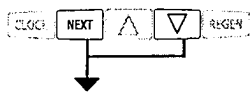

Step 1F – Press NEXT and ▼ simultaneously for 3 seconds and release. If screen in Step 2F does not appear in 5 seconds the lock on the valve is activated. To unlock press ▼, NEXT, ▲, and SET CLOCK in sequence, then press NEXT and ▼ simultaneously for 3 seconds and release.

STEP 2F

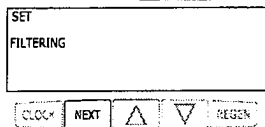

Step 2F – Choose FILTERING using the ▼ or ▲ buttons. Press NEXT to go to Step 3F. Press REGEN to exit OEM Filter System Setup.

STEP 3F

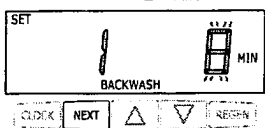

Step 3F – Select the time for the first cycle using the ▼ or ▲ button. Press NEXT to go to Step 4F. Press REGEN to return to previous step.

STEP 4F

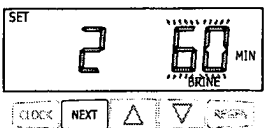

Step 4F – Select the time for the second cycle using the ▼ or ▲ button. Press NEXT to go to Step 5F. Press REGEN to return to previous step.
NOTE: The display will flash between cycle number and time, and brine direction (dn or UP).

STEP 5F

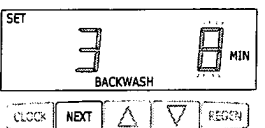

Step 5F – Select the time for the third cycle using the ▼ or ▲ button. Press NEXT to go to Step 6F. Press REGEN to return to previous step.

STEP 6F

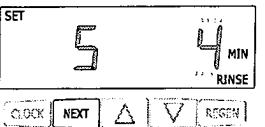

Step 6F – Select the time for the fifth cycle (which in this example is RINSE) using the ▼ or ▲ button. Press NEXT to go to Step 7F. Press REGEN to return to previous step.

STEP 7F

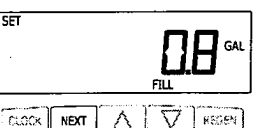

STEP 7F – Enter “off” if regenerant is not used (i.e. backwash only) or enter the refill volume (in gallons) using ▼ or ▲ buttons. Prior to selecting off or regenerant volume, verify the correct valve body, main piston, regenerant piston, and stack are being used, and that the injector or injector plug(s) are in the correct locations. See Compliance Table in Service Instructions under Injector Cap, Screen, Injector Plug and Injector section and Figure 6.
Press NEXT to go to Step 8F. Press REGEN to return to previous step.

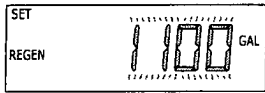
STEP 8F

Step 8F – Set Volume Capacity using the ▼ or ▲ button. If value is set to:

- “oFF” regeneration will be based solely on the day override set (see Installer Display/Settings Step 3I); or
- as a number (allowable range 20 to 250,000) regeneration initiation will be based off the value specified.

See Table 9 for more detail. Press NEXT to go to Step 9F. Press REGEN to return to previous step.

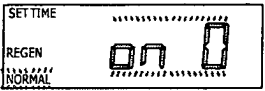
STEP 9F

Step 9F – Set Regeneration Time Options using the ▼ or ▲ button. If value is set to:

- “NORMAL” means regeneration will occur at the preset time;
- “on 0” means regeneration will occur immediately when the gallons capacity reaches 0 (zero); or
- “NORMAL + on 0” means regeneration will occur at one of the following:
 - the preset time when the gallons capacity falls below the reserve or the specified number of days between regenerations is reached whichever comes first;
 - or
 - after 10 minutes of no water usage when the gallon capacity reaches 0 (zero).

See Table 9 for more detail. Press NEXT to go to Step 10F. Press REGEN to return to previous step.

STEP 10F

Step 10F: Set Relay operation using the ▲ or ▼ button. The choices are:

- Set Time on: Relay activates after a set time at the beginning of a regeneration and then deactivates after a set period of time. The start of regeneration is defined as the first backwash cycle or Dn brine cycle, which ever comes first.
- Set Gal Filtering on: Relay activates after a set number of gallons have been used while in service and then deactivates after a set period of time or after the meter stops registering flow, whichever comes first.
- Set Gal Filtering Regen on: Relay activates after a set number of gallons have been used while in service or during regeneration and then deactivates after a set period of time or after the meter stops registering flow, whichever comes first.
- Set Gallons HoLd: Relay closes every set number of gallons and releases when the ▲ button is pressed.
- Set Off: If set to Off, Steps 11F and 12F will not be shown.

Press NEXT to go to Step 11F. Press REGEN to return to previous step.

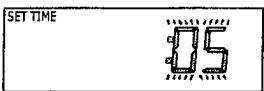
STEP 11F

Step 11F: Set Relay Actuation Time or Gallons using the ▲ or ▼ buttons. The choices are:

- Relay Actuation Time: After the start of a regeneration the amount of time that should pass prior to activating the relay. The start of regeneration is defined as the first backwash cycle or Dn brine cycle, which ever comes first. Ranges from 1 minute to 500 minutes.
- Relay Actuation Gallons: Relay activates after a set number of gallons have passed. Ranges from 1 to 100 gallons.
- Relay HoLd: Relay closes every set number of gallons. Ranges from 1,000 to 99,000,000 gallons.

Press NEXT to go to Step 12F. Press REGEN to return to previous step.

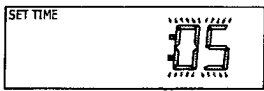
STEP 12F

Step 12F: Set Relay Deactivate Time using the ▲ or ▼ buttons.

- If Set Time on is selected in Step 10F the relay will deactivate after the time set has expired. Ranges from 1 second to 500 minutes.
- If Set Gal Filtering on or Set Gal Filtering Regen on is selected in Step 10F the relay will deactivate after the time set has expired or after the meter stops registering flow, whichever comes first. Ranges from 1 second to 500 minutes.
- Does not display for Gallons HoLd selection.

Press NEXT to go to Step 13F. Press REGEN to return to previous step.

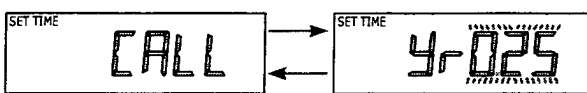
STEP 13F

Step 13F: Set the Service Call Indicator by using the ▲ or ▼ buttons. Range is in ¼ of a year increments from 0.25 to 9.75 years. Selecting OFF will disable this feature.

Press NEXT to exit OEM Filter System Setup. Press REGEN to return to previous step.

RETURN TO NORMAL MODE

Table 9

Filter Setting Options

Gallons Capacity	Regeneration Time Option	Day Override	Result
oFF	NORMAL	Any number	Reserve capacity <u>not</u> automatically estimated. Regeneration occurs at the next Regen Set Time when the specified number of days between regenerations is reached.
Any number	NORMAL	oFF	Reserve capacity <u>not</u> automatically estimated. Regeneration occurs at the next Regen Set Time when gallons capacity reaches 0.
Any number	NORMAL	Any number	Reserve capacity <u>not</u> automatically estimated. Regeneration occurs at the next Regen Set Time when gallons capacity reaches 0 or the specified number of days between regenerations is reached.
Any number	On 0	oFF	Reserve capacity <u>not</u> automatically estimated. Regeneration occurs immediately when gallons capacity reaches 0. Time of regeneration will not be allowed to be set because regeneration will always occur on 0.
Any number	NORMAL on 0	Any number	Reserve capacity <u>not</u> automatically estimated. Regeneration occurs at the next Regen Set Time when the specified number of days between regenerations is reached or regeneration occurs immediately after 10 minutes of no water usage when gallon capacity reaches 0.

Installer Display Settings

STEP 11

STEP 11 - Press NEXT and ▲ simultaneously for 3 seconds.

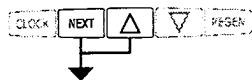

STEP 21

STEP 21 – Hardness: Set the amount of hardness in grains of hardness as calcium carbonate per gallon using the ▼ or ▲ buttons. The default is 20 with value ranges from 1 to 150 in 1 grain increments. Note: The grains per gallon can be increased if soluble iron needs to be reduced. This display will show “-nA-” if “FILTER” is selected in Step 2F or if ‘AUTO’ is not selected in Set Volume Capacity in OEM Softener System Setup. Press NEXT to go to step 3I. Press REGEN to exit Installer Display Settings.

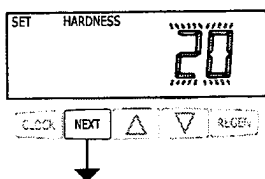

STEP 31

STEP 31 – Day Override: When volume capacity is set to “oFF”, sets the number of days between regenerations. When volume capacity is set to AUTO or to a number, sets the maximum number of days between regenerations. If value set to “oFF”, regeneration initiation is based solely on volume used. If value is set as a number (allowable range from 1 to 28) a regeneration initiation will be called for on that day even if sufficient volume of water were not used to call for a regeneration. Set Day Override using ▼ or ▲ buttons:

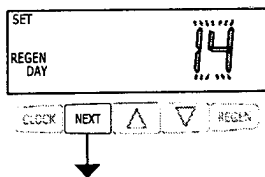

- number of days between regeneration (1 to 28); or
- “oFF”.

See Table 8 for more detail on softener setup and Table 9 for more detail on filter setup. Press NEXT to go to step 4I. Press REGEN to return to previous step.

STEP 41

STEP 41 – Next Regeneration Time (hour): Set the hour of day for regeneration using ▼ or ▲ buttons. AM/PM toggles after 12. The default time is 2:00 AM. This display will show “on 0” if “on 0” is selected in Set Regeneration Time Option in OEM Softener System Setup or OEM Filter System Setup. Press NEXT to go to step 5I. Press REGEN to return to previous step.

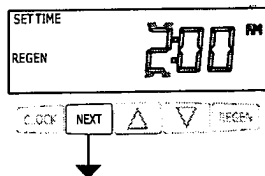

STEP 51

STEP 51 – Next Regeneration Time (minutes): Set the minutes of day for regeneration using ▼ or ▲ buttons. This display will not be shown if “on 0” is selected in Set Regeneration Time Option in OEM Softener System Setup or OEM Filter System Setup. Press NEXT to exit Installer Display Settings. Press REGEN to return to previous step.

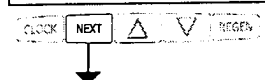

RETURN TO
NORMAL MODE

To initiate a manual regeneration immediately, press and hold the “REGEN” button for three seconds. The system will begin to regenerate immediately. The control valve may be stepped through the various regeneration cycles by pressing the “REGEN” button.

User Display Settings

General Operation

When the system is operating, one of five displays may be shown. Pressing NEXT will alternate between the displays. One of the displays is always the current time of day.

The second display is one of the following: days remaining or volume remaining. Days remaining is the number of days left before the system goes through a regeneration cycle. Capacity remaining is the gallons that will be treated before the system goes through a regeneration cycle. Pressing the ▼ button while in the Capacity Remaining display will decrease the capacity remaining in 10 gallon increments and will also increase the volume used impacting the recorded values in Diagnostics Steps 3D, 4D and 5D and Valve History, Step 4VH.

The third display shows the current treated water flow rate through the system. The fourth display will show either dP or hold if the dP switch is closed.

The fifth display indicates the user should call for service. The fifth display will not appear if OFF is selected in Step 14S of OEM Softener System Setup or Step 13F of OEM Filter System Setup. To clear the Service Call reminder, press the ▲ and ▼ buttons simultaneously while CALL is displayed.

If the system has called for a regeneration that will occur at the preset time of regeneration, the words REGEN TODAY will appear on the display.

If a water meter is installed, the word “Softening” or “Filtering” flashes on the display when water is being treated (i.e. water is flowing through the system).

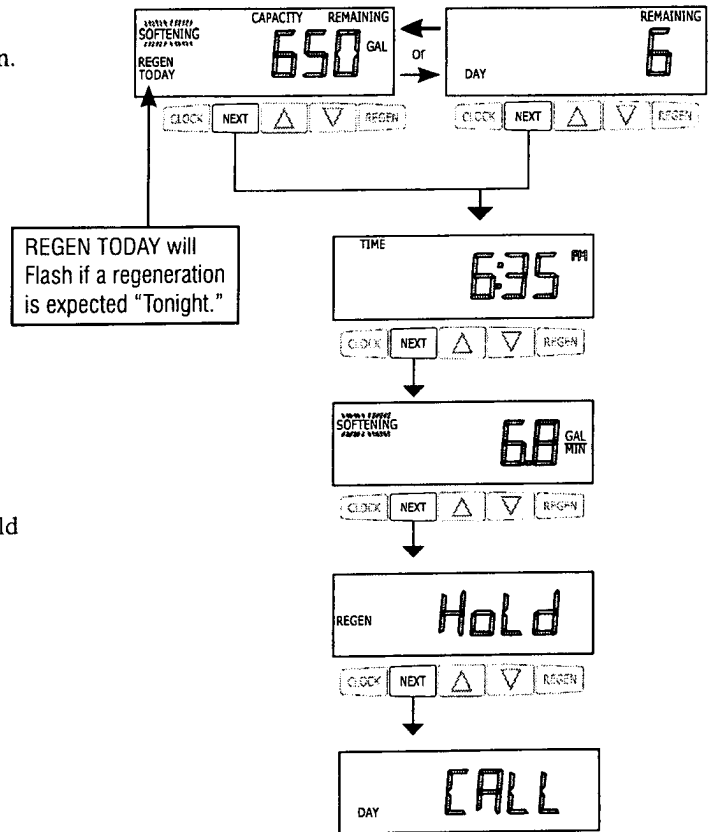

Regeneration Mode

Typically a system is set to regenerate at a time of low water usage. An example of a time with low water usage is when a household is asleep. If there is a demand for water when the system is regenerating, untreated water will be used.

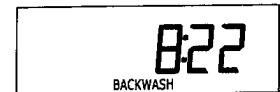

When the system begins to regenerate, the display will change to include information about the step of the regeneration process and the time remaining for that step to be completed. The system runs through the steps automatically and will reset itself to provide treated water when the regeneration has been completed.

Manual Regeneration

Sometimes there is a need to regenerate the system sooner than when the system calls for it, usually referred to as manual regeneration. There may be a period of heavy water usage because of guests or a heavy laundry day.

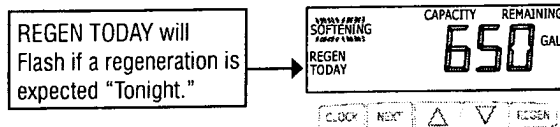

To initiate a manual regeneration at the preset delayed regeneration time, when the regeneration time option is set to "NORMAL" or "NORMAL + on 0", press and release "REGEN". The words "REGEN TODAY" will flash on the display to indicate that the system will regenerate at the preset delayed regeneration time. If you pressed the "REGEN" button in error, pressing the button again will cancel the request. Note: If the regeneration time option is set to "on 0" there is no set delayed regeneration time so "REGEN TODAY" will not activate if "REGEN" button is pressed.

To initiate a manual regeneration immediately, press and hold the "REGEN" button for three seconds. The system will begin to regenerate immediately. The request cannot be cancelled.

Note: For softeners, if the brine tank does not contain salt, fill with salt and wait at least two hours before regenerating.

Set Time of Day

The user can also set the time of day. Time of day should only need to be set if the battery has been depleted because of extended power outages or when daylight saving time begins or ends. If an extended power outage occurs, the time of day will flash on and off which indicates the time of day should be reset. The non rechargeable battery should also be replaced.

STEP 1U

STEP 1U – Press SET CLOCK.

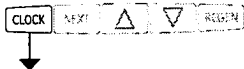

STEP 2U

STEP 2U - Current Time (hour): Set the hour of the day using ▼ or ▲ buttons. AM/PM toggles after 12. Press NEXT to go to Step 3U.

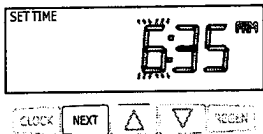

STEP 3U

STEP 3U - Current Time (minutes): Set the minutes of the day using ▼ or ▲ buttons. Press NEXT to exit Set Time of Day. Press REGEN to return to previous step.

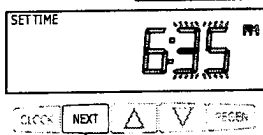

RETURN TO NORMAL MODE

RETURN TO NORMAL MODE

Power Loss

If the power goes out the system will keep time until the battery is depleted. If an extended power outage occurs, the time of day will flash on and off which indicates the time of day should be reset and the battery replaced. The system will remember the rest.

Error Message

If the word "ERROR," a number and the word "CALL" are alternately flashing on the display contact the OEM for help. A number indicates that the valve was not able to function properly.

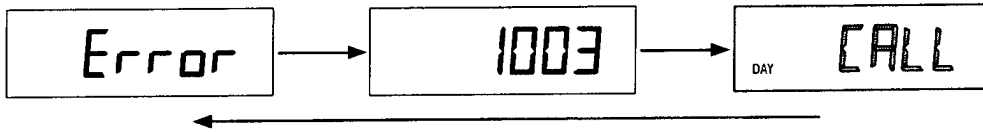

Diagnostics

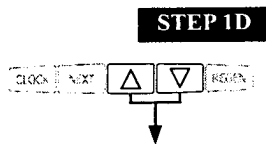

STEP 1D – Press ▲ and ▼ simultaneously for three seconds. If screen in step 2D does not appear in 5 seconds the lock on the valve is activated. To unlock press ▲, NEXT, ▼, and SET CLOCK in sequence, then press ▲ and ▼ simultaneously for 3 seconds.

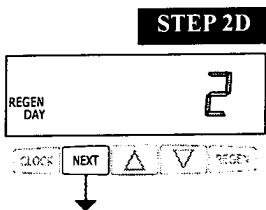

STEP 2D – Days, since last regeneration: This display shows the days since the last regeneration occurred. Press the NEXT button to go to Step 3D. Press REGEN to exit Diagnostics.

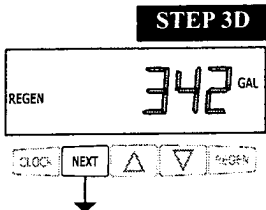

STEP 3D – Volume, since last regeneration: This display shows the volume of water that has been treated since the last regeneration. This display will equal zero if a water meter is not installed. Press the NEXT button to go to Step 4D. Press REGEN to return to previous step.

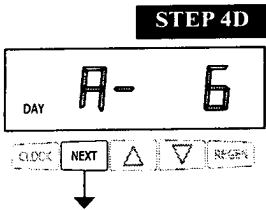

STEP 4D – Volume, reserve capacity used for last 7 days: If the valve is set up as a softener, a meter is installed and Set Volume Capacity is set to "Auto," this display shows 0 day (for today) and flashes the reserve capacity. Pressing the ▲ button will show day 1 (which would be yesterday) and flashes the reserve capacity used. Pressing the ▲ button again will show day 2 (the day before yesterday) and the reserve capacity. Keep pressing the ▲ button to show the capacity for days 3, 4, 5 and 6. The ▼ button can be pressed to move backwards in the day series. Press the NEXT button at any time to go to Step 5D. Press REGEN to return to previous step.

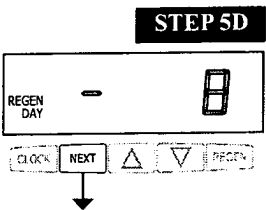

STEP 5D - Volume, 63-day usage history: This display shows day 1 (for yesterday) and flashes the volume of water treated yesterday. Pressing the ▲ button will show day 2 (which would be the day before yesterday) and flashes the volume of water treated on that day. Continue to press the ▲ button to show the maximum volume of water treated for the last 63 days. If a regeneration occurred on the day the word "REGEN" will also be displayed. This display will show dashes if a water meter is not installed. Press the NEXT button at any time to go to Step 6D. Press REGEN to return to previous step.

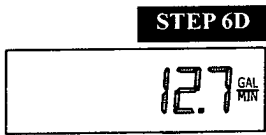

STEP 6D – Flow rate, maximum last seven days: The maximum flow rate in gallons per minute that occurred in the last seven days will be displayed. This display will equal zero if a water meter is not installed. Press the NEXT button to exit Diagnostics. Press REGEN to return to previous step.

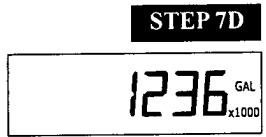

STEP 7D – Gallons, total used since start-up: This display shows the total gallons treated since startup. This display will equal zero if a water meter is not installed. Press the NEXT button to go to Step 8D. Press REGEN to return to previous step.

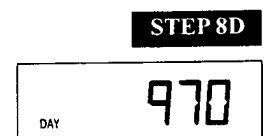

STEP 8D – Days, total since start-up: This display shows the total days since startup. Press the NEXT button to go to Step 9D. Press REGEN to return to previous step.

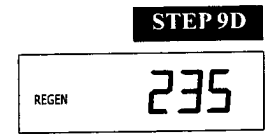

STEP 9D – Regenerations, total number since start-up: This display shows the total number of regenerations that have occurred since startup. Press the NEXT button to exit Diagnostics. Press REGEN to return to previous step.

RETURN TO NORMAL MODE

When desired, all information in Diagnostics may be reset to zero when the valve is installed in a new location. To reset to zero, press NEXT and ▼ buttons simultaneously to go to the Service/OEM 1 screen, and release. Press ▲ and ▼ simultaneously to reset diagnostic values to zero. Screen will return to User Display.

Valve History

STEP 1VH

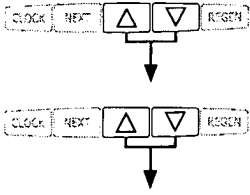

STEP 1VH – Press ▲ and ▼ simultaneously for three seconds and release. Then press ▲ and ▼ simultaneously and release. If screen in step 2VH does not appear in 5 seconds the lock on the valve is activated. To unlock press ▼, NEXT, ▲, and SET CLOCK in sequence, then press ▲ and ▼ simultaneously for 3 seconds and release. Then press ▲ and ▼ simultaneously and release.

STEP 2VH

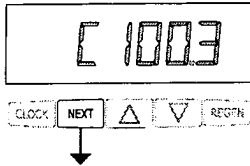

STEP 2VH – Software Version: This display shows the software version of the valve. Press the NEXT button to go to Step 3VH. Press REGEN to exit Valve History.

STEP 3VH

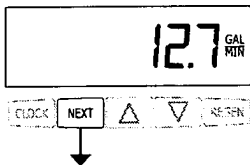

STEP 3VH⁹ – Flow rate, maximum since startup: This display shows the maximum flow rate in gallons per minute that has occurred since startup. This display will equal zero if a water meter is not installed. Press the NEXT button to go to Step 4VH. Press REGEN to return to previous step.

STEP 4VH

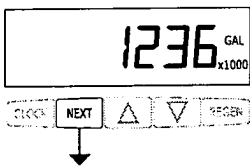

STEP 4VH – Gallons, total used since start-up: This display shows the total gallons treated since startup. This display will equal zero if a water meter is not installed. Press the NEXT button to go to Step 5VH. Press REGEN to return to previous step.

STEP 5VH

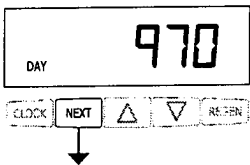

STEP 5VH – Days, total since start-up: This display shows the total days since startup. Press the NEXT button to go to Step 6VH. Press REGEN to return to previous step.

STEP 6VH

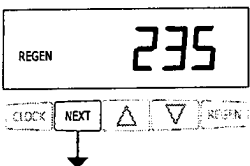

STEP 6VH – Regenerations, total number since start-up: This display shows the total number of regenerations that have occurred since startup. Press the NEXT button to go to Step 7VH. Press REGEN to return to previous step.

STEP 7VH

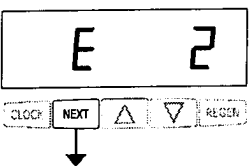

STEP 7VH – Error, number of occurrences since start-up: This display shows E and the total number of errors that have occurred since startup. Press the NEXT button to exit Valve History. Press REGEN to return to previous step.

RETURN TO NORMAL MODE

⁹ Values in steps 2VH through 7VH cannot be reset.

Installation

Refill Flow Control Assembly or Refill Port Plug

Control valves that are setup for backwash only come equipped with a refill port plug. The refill port plug has no regenerant line connection.

Control valves that use a regenerant come equipped with a 3/8" refill flow control assembly. To switch to the 1/2" refill flow control assembly, remove the refill flow control and retainer (from the 3/8" refill elbow) by twisting and pulling out. Insert the refill flow control and retainer into the 1/2" refill elbow.

To complete the regenerant line connection, orientate the outlet in the desired direction and push the plastic insert into the polytube. Push the polytube into the nut. Do not use pipe dope or other sealants on threads. The threads for the compression nut do not need Teflon tape. Tighten the nut securely to create a pressure tight connection. A pliers or crescent wrench may be used to tighten or unscrew the nut. The nut, gripper and retainer sleeve is a 3 piece assembly that can come apart if removed from the elbow body. Parts must be reassembled exactly as shown in refill flow control assembly drawing to function properly. If the nut is completely removed from the body, slip the nut, plastic gripper and retainer sleeve on to the tube then tighten on to the fitting.

Drain Line Flow Control and Fitting Assembly

To determine which drain line flow control to use, obtain media bed expansion tables from the media manufacturer, choose a water temperature and look up the desired backwash rate per square foot of bed area. Then calculate the backwash rate using the desired tank diameter. Using Table 7, choose the drain line flow control that has the backwash flow rate closest to the calculated backwash rate. If a manufacturer chooses to use an external drain line flow control, use an elbow fitting that does not contain a hole.

If the drain line is a 5/8" flexible polytube, slide the nut onto the polytube, then place the polytube insert into the end of the polytube and tighten the nut on to the 3/4" drain line fitting. The nut is only designed for use with flexible polytube. Use other nuts if attaching different materials.

To access the drain line flow control remove the locking clip by pulling it straight out. Pull fitting out and replace the locking clip so that it is not misplaced. The drain line fitting is pressed in and has an o-ring seal.

In the 3/4" elbow, the white flow control retainer is pressed in and has an o-ring seal. The retainer can be removed by rotating and pulling. The flow control can be removed by prying upward with a small blade flat screwdriver in one of the slots on the side. The drain line flow control and retainer can be chemically cleaned in dilute sodium bisulfite or vinegar, or replaced. Do not use a wire brush to clean the flow control or the washer. The washers are identified with three numbers, which correspond to the flow rate. When reinstalling make sure the identifying number and the rounded inside diameter on the washer is visible when seated in the retainer. The white flow control washer retainer can also be removed and cleaned. Push the retainer in firmly when reinstalling.

In the 1" straight fitting, the retainer is the fitting. Unscrew the nut to access the flow control. The drain line flow control and the fitting can be chemically cleaned or replaced. Do not use a wire brush to clean the flow control or the fitting.

Do not use Vaseline, oils, or other unacceptable lubricants on o-rings. A silicone lubricant may be used on the black o-ring. Use a pliers or crescent wrench to tighten or unscrew the nut. Do not use a pipe wrench to tighten or loosen nut. Do not use pipe dope or other sealants on threads. Use Teflon tape on the threads of the drain line control fitting when installing 3/4" NPT or 1" straight fitting.

Installation Fitting Assemblies

The installation fittings connect to the control valve or the bypass valve using nuts that only require hand tightening. Hand tighten nut connections between control valve and installation fittings, control valve and bypass valve, and bypass valve and installation fittings allow for easy serviceability. Do not use a pipe wrench to tighten nuts on installation fittings. Hand tighten only.

The split ring retainer design holds the nut on and allows load to be spread over the entire nut surface area, reducing the chance for leakage. The split ring design, incorporated into the installation fittings allows approximately 2 degrees off axis alignment to the plumbing system. The installation fittings are designed to accommodate minor plumbing misalignments but are not designed to support the weight of a system or the plumbing.

When assembling the installation fitting package, connect the fitting to the plumbing system first and then attach the nut, split ring and o-ring. Heat from soldering or solvent cements may damage the nut, split ring or o-ring. Solder joints should be cool and solvent cements should be set before installing the nut, split ring and o-ring. Avoid getting primer and solvent cement on any part of the o-rings, split rings, bypass valve or control valve. Solvent cements and primers should be used in accordance with the manufacturer's instructions.

Slip the nut onto the fitting first, then the split ring second and the o-ring last. Hand tighten the nut. If the fitting is leaking tightening the nut will not stop the leak. Remove the nut, remove the fitting, and check for damage or misalignment of the o-ring.

Do not use pipe dope or other sealant on threads. Use teflon tape on threaded inlet, outlet and drain fittings. Teflon tape is not necessary on the nut connection or caps because of o-ring seals.

Do not use Vaseline, oils, or other unacceptable lubricants on o-rings. A silicone lubricant may be used on black o-rings.

Bypass Valve

The bypass valve easily connects to the control valve body using nuts that only require hand tightening. Hand tighten nut connections between control valve and fittings, control valve and bypass valve, and bypass valve and installation fittings allow for easy serviceability. The split ring retainer design holds the nut on and allows load to be spread over the entire nut surface area, reducing the chance for leakage. The split ring design incorporated into the bypass allows approximately 2 degrees off axis alignment to the plumbing system. The bypass is designed to accommodate minor plumbing misalignments but is not designed to support the weight of a system or the plumbing.

Avoid getting primer and solvent cements on any part of the o-rings or split rings, bypass valve or control valve. Do not use pipe dope or other sealant on threads. Teflon tape is not necessary on the caps because of o-ring seals.

Do not use Vaseline, oils, or other unacceptable lubricants on o-rings. A silicone lubricant may be used on black o-rings.

Mixing Valve

The mixing valve is an option on the control valve. If the control valve is ordered with a mixing valve it will be installed in the control valve assembly process.

To adjust the blended water, close the mixing valve. Open a water faucet to the desired flow rate. Open the mixing valve until the desired hardness is reached. Close the faucet.

Note: The use of the mixing valve requires modification to the valve body. These modifications should not be done in the field.

Service Instructions

Drive Assembly

Remove the valve cover to access the drive assembly.

Disconnect the power source plug (black wire) from the PC board prior to disconnecting the motor or water meter plugs from the PC board. The power source plug connects to the four-pin jack. The motor plug connects to the two-pin jack on the left-hand side of the PC board. The water meter plug (gray wire) connects to the three-pin jack on the far right-hand side of the PC board.

The PC board can be removed separately from the drive bracket but it is not recommended. Do not attempt to remove the display panel from the PC board. Handle the board by the edges. To remove the PC board from the drive bracket, unplug the power, water meter and motor plugs from the PC board. Lift the middle latch along the top of the drive bracket while pulling outward on the top of the PC board. The drive bracket has two plastic pins that fit into the holes on the lower edge of the PC board. Once the PC board is tilted about 45° from the drive bracket it can be lifted off of these pins. To reinstall the PC board, position the lower edge of the PC board so that the holes in the PC board line up with the plastic pins. Push the top of the PC board towards the valve until it snaps under the middle latch, weave the power and water meter wires into the holders and reconnect the motor, water meter and power plugs.

The drive bracket must be removed to access the drive cap assembly and pistons or the drive gear cover. It is not necessary to remove the PC board from the drive bracket to remove the drive bracket. To remove the drive bracket start by removing the plugs for the power source and the water meter. Unweave the wires from the side holders. Two tabs on the top of the drive back plate hold the drive bracket in place. Simultaneously lift the two tabs and gently ease the top of the drive bracket forward. The lower edge of the drive bracket has two notches that rest on the drive back plate. Lift up and outward on the drive bracket to disengage the notches.

To reassemble, seat the bottom of the drive bracket so the notches are engaged at the bottom of the drive back plate. Push the top of the drive bracket toward the two latches. The drive bracket may have to be lifted slightly to let the threaded piston rod pass through the hole in the drive bracket. Maintain a slight engaging force on top of the drive bracket while deflecting the bracket slightly to the left by pressing on the side of the upper right corner. This helps the drive gears mesh with the drive cap assembly. The drive bracket is properly seated when it snaps under the latches on the drive back plate. If resistance is felt before latching, then notches are not fully engaged, the piston rod is not in hole, the wires are jammed between the drive bracket and drive back plate, or the gear is not engaging the drive cap assembly.

To inspect the drive gears, the drive gear cover needs to be removed. Before trying to remove the gear cover, the drive bracket must be removed from the drive back plate. (Refer to the instructions above regarding removing the drive bracket from the drive back plate. The drive gear cover can be removed from the drive bracket without removing the motor or the PC board.) The drive gear cover is held in place on the drive bracket by three clips. The largest of the three clips is always orientated to the bottom of the drive bracket. With the PC board facing up, push in and down on the large clip on the drive gear cover. Handle the cover and the gears carefully so that the gears do not fall off the pegs in the cover.

Replace broken or damaged drive gears. Do not lubricate any of the gears. Avoid getting any foreign matter on the reflective coating because dirt or oils may interfere with pulse counting.

The drive gear cover only fits on one way, with the large clip orientated towards the bottom. If all three clips are outside of the gear shroud on the drive bracket the drive gear cover slips easily into place.

The drive bracket does not need to be removed from the drive plate if the motor needs to be removed. To remove the motor, disconnect the power and motor plugs from the jacks on the PC board. Move the spring clip loop to the right and hold. Rotate the motor at least a ¼ turn in either direction so the wires are vertical (up & down) before gently pulling on the wire connectors to remove the motor. Pulling directly on the wires without rotating the motor may break the wires off the motor.

Replace the motor if necessary. Do not lubricate the motor or the gears. To reinstall the motor, move the spring clip loop to the right and hold. Gently turn the motor while inserting so that the gear on the motor meshes with the gears under the drive gear cover. Release the spring clip loop and continue to rotate the motor until the wires are horizontal and the motor housing engages the small plastic bulge inside the drive bracket motor retainer. Reconnect the motor plug to the two-pronged jack on the lower left side of the PC board. If the motor will not easily engage with the drive gears when reinstalling, lift and slightly rotate the motor before reinserting. Reconnect the power plug.

Replace the valve cover. After completing any valve maintenance, press and hold NEXT and REGEN buttons for 3 seconds or unplug power source jack (black wire) and plug back in. This resets the electronics and establishes the service piston position. The display should flash all wording, then flash the software version and then reset the valve to the service position.

Drive Cap Assembly, Main Piston and Regenerant Piston

The drive assembly must be removed to access the drive cap assembly. The drive cap assembly must be removed to access the piston(s). The drive cap assembly is threaded into the control valve body and seals with an o-ring. To remove the drive cap assembly use the special plastic wrench or insert a ¼" to ½" flat blade screwdriver into one of the slots around the top 2" of the drive cap assembly so it engages the notches molded into the drive back plate around the top 2" of the piston cavity. See Figure 5. The notches are visible through the holes. Lever the screwdriver so the drive cap assembly turns counter clockwise. Once loosened unscrew the drive cap assembly by hand and pull straight out.

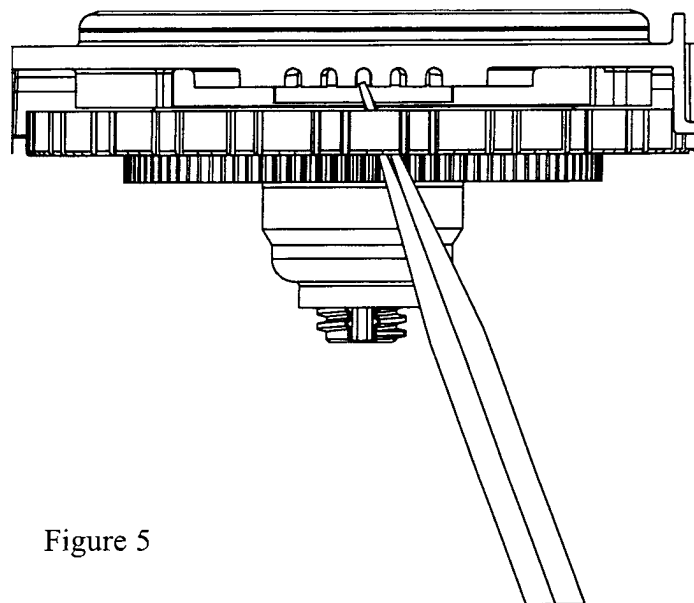

Figure 5

The drive cap assembly contains the drive cap, the main drive gear, drive cap spline, piston rod and various other parts that should not be disassembled in the field. The only replaceable part on the drive cap assembly is the o-ring. Attached to the drive cap assembly is the main piston (downflow or upflow) and if a regenerant is used, a regenerant piston.

The regenerant piston (the small diameter one behind the main piston) is removed from the main piston by pressing sideways and unsnapping it from its latch. Chemically clean in dilute sodium bisulfite or vinegar, or replace the regenerant piston if needed. To remove the main downflow or upflow piston fully extend the piston rod and then unsnap the main piston from its latch by pressing on the side with the number. Chemically clean in dilute sodium bisulfite or vinegar, or replace the main piston.

Reattach the main piston to the drive cap assembly. Reattach the regenerant piston (if needed) to the main piston. Do not lubricate the piston rod, main piston or regenerant piston. Lubricant will adversely affect the clear lip seals. Reinsert the drive cap assembly and piston into the spacer stack assembly and hand tighten the drive cap assembly. Continue to tighten the drive cap assembly using a screwdriver as a ratchet until the black o-ring on the spacer stack assembly is no longer visible through the drain port. Excessive force can break the notches molded into the drive back plate. Make certain that the main drive gear still turns freely. The exact position of the piston is not important as long as the main drive gear turns freely.

Reattach the drive assembly to the control valve and connect all plugs. After completing any valve maintenance, press and hold NEXT and REGEN buttons for 3 seconds or unplug power source jack (black wire) and plug back in. This resets the electronics and establishes the service piston position. The display should flash all wording, then flash the software version and then reset the valve to the service position.

Note: Refer to Figure 6 to identify main piston.

Spacer Stack Assembly

(Refer to Figure 6 for WS1CH & WS1.25CH spacer stack identification.)

To access the spacer stack assembly remove the drive assembly, drive cap assembly and piston. The spacer stack assembly can be removed easily without tools by using thumb and forefinger. Inspect the black o-rings and clear lip seals for wear or damage. Replace the entire stack if necessary. Do not disassemble the WS1CH or WS1.25CH stack.

The spacer stack assembly may be chemically cleaned (dilute sodium bisulfite or vinegar) or wiped with a soft cloth.

The spacer stack assembly can be pushed in to the control valve body bore by hand. Since the spacer stack assembly can be compressed it is easier to use a blunt object (5/8" to 1-1/8" in diameter) to push the center of the assembly into the control valve body. The assembly is properly seated when at least four threads are exposed (approximately 5/8"). Do not force the spacer stack assembly in. The control valve body bore interior can be lubricated with silicone to allow for easy insertion of the entire stack. Do not use silicone or any other type of lubricant on the clear lip seals or the piston.

Reattach the drive cap assembly and piston(s) and the drive assembly.

After completing any valve maintenance, press and hold NEXT and REGEN buttons for 3 seconds or unplug power source jack (black wire) and plug back in. This resets the electronics and establishes the service piston position. The display should flash all wording, then flash the software version and then reset the valve to the service position.

Injector Cap, Screen, Injector Plug and Injector

Unscrew the injector cap and lift off. Loosen cap with special plastic wrench or pliers if necessary. Attached to the injector cap is a screen. Remove the screen and clean if fouled.

The plug and/or injector can be pried out with a small screwdriver. The plug can be wiped clean. If the plug leaks replace the entire plug. The injector consists of a throat and a nozzle. Chemically clean the injector with vinegar or sodium bisulfite. The holes can be blown out with air. Both pieces have small diameter holes that control the flow rates of water to insure that the proper concentration of regenerant is used. Sharp objects, which can score the plastic, should not be used to clean the injector. Scoring the injector or increasing the diameter of the hole could change the operating parameters of the injector.

Two holes are labeled DN and UP. Check for compliance. See Table.

Compliance Table

Application	Injector and/or Plug(s)	Main Piston	Regenerant Piston	Stack	Body
WS1CH Downflow Softener or Regenerating Filter	Injector in "DN" hole, Plug in "UP" hole	V3011	V3174	V3005	V3001 or V3001-02 (Mixing)
WS1CH Backwash Only Filter	Plug in "DN" and "UP" holes, Install Refill Port Plug	V3011	None	V3005	V3001 or V3001-02 (Mixing)
WS1CH Upflow Softener	Injector in "UP" hole, Plug in unlabeled hole	V3011-01	V3174	V3005	V3001UP or V3001-02UP (Mixing)
WS1.25CH Downflow Softener or Regenerating Filter (1.32" Distributor)	Injector in "DN" hole, Plug in "UP" hole	V3407	V3174	V3430	V3020 or V3020-01 (Mixing)
WS1.25CH Backwash Only Filter (1.32" Distributor)	Plug in "DN" and "UP" holes, Install Refill Port Plug	V3407	None	V3430	V3020 or V3020-01 (Mixing)
WS1.25CH Downflow Softener or Regenerating Filter (32mm Distributor)	Injector in "DN" hole, Plug in "UP" hole	V3407	V3174	V3430	V3020-02 or V3020-03 (Mixing)
WS1.25CH Backwash Only Filter (32mm Distributor)	Plug in "DN" and "UP" holes, Install Refill Port Plug	V3407	None	V3430	V3020-02 or V3020-03 (Mixing)

Refill Flow Control Assembly or Refill Port Plug

To clean or replace the refill flow control, pull out the elbow-locking clip and then pull straight up on the elbow. Replace the elbow locking clip in the slot so that it is not misplaced. Twist to remove the white flow control retainer. The flow control can be removed by prying upward through the side slots of the retainer with a small flat blade screwdriver.

Chemically clean the flow control or the white flow control retainer using dilute sodium bisulfite or vinegar. Do not use a wire brush. If necessary, replace the flow control, o-ring on the flow control retainer, or the o-ring on the elbow.

Reseat the flow control so the rounded end is visible in the flow control. Reseat the white flow control retainer by pushing the retainer into the elbow until the o-ring seats. Remove locking clip, push down on elbow to reseat and insert locking clip.

Do not use Vaseline, oils, or other unacceptable lubricants on o-rings. A silicone lubricant may be used on the o-ring on the elbow or the white retainer.

Water Meter or Meter Plug

The water meter assembly is connected to the PC board by a wire. If the entire water meter assembly is to be replaced, remove the control valve cover and disconnect the power source and water meter plugs from the PC board. Unlatch the drive assembly and lean it forward. Unthread the water meter wire from the side of the drive assembly and through the drive back plate. To reinstall, rethread the water meter wire through the drive back plate and the side of the drive assembly. Reattach the drive assembly and the water meter and power plugs.

THIS WATER METER SHOULD NOT BE USED AS THE PRIMARY MONITORING DEVICE FOR CRITICAL HEALTH EFFECT APPLICATIONS.

If no water meter wire is visible, then a plug is installed, not a water meter.

The water meter wire does not need to be removed from the PC board if the water meter is only being inspected and cleaned. To remove the water meter assembly, unscrew the meter cap on the left side of the control valve. Pliers may be used to unscrew the nut if necessary.

With the nut removed, a slot at the top of the water meter is visible. Twist a flat blade screwdriver in the slot between the control valve body and the meter. When the meter is part way out it is easy to remove the water meter from the housing. Once the water meter is removed from the control valve body, gently pull forward on the turbine to remove it from the shaft.

Do not use a wire brush to clean the turbine. Wipe with a clean cloth or chemically clean in dilute sodium bisulfite or vinegar. The turbine can be immersed in the chemical. Do not immerse electronics. If the turbine is scored or damaged or the bearings on the turbine are worn, replace the turbine.

Do not lubricate the turbine shaft. The turbine shaft bearings are prelubricated. Do not use Vaseline, oils, or other unacceptable lubricants on the o-ring. A silicone lubricant may be used on the black o-ring.

Snap the turbine on the shaft and reinsert the water meter into the side slot. Hand tighten the nut. Do not use a pipe wrench to tighten nut.

Mixing Valve

To clean or replace the mixing valve, unthread the mixing valve from the valve body. Chemically clean the mixing valve with a dilute sodium bisulfite or vinegar solution. Do not use Vaseline, oils, or other unacceptable lubricants on o-rings. A silicone lubricant may be used on the o-ring. Before replacing the mixing valve in the valve body turn the knob clockwise so that the mixing valve is in the open position. Failure to do this may cause damage to the mixing valve when it is screwed in to the valve body.

To adjust the blended water, close the mixing valve. Open a water faucet to the desired flow rate. Open the mixing valve until the desired hardness is reached. Close the faucet.

Bypass Valve

The working parts of the bypass valve are the rotor assemblies that are contained under the bypass valve caps. Before working on the rotors, make sure the system is depressurized. Turn the red arrow shaped handles towards the center of the bypass valve and back several times to ensure rotor is turning freely.

The nuts and caps are designed to be unscrewed or tightened by hand. If necessary a pliers can be used to unscrew the nut or cap. Do not use a pipe wrench to tighten or loosen nuts or caps. Do not place screwdriver in slots on caps and/or tap with a hammer. To access the rotor, unscrew the cap and lift the cap, rotor and handle out as one unit. Twisting the unit as you pull it out will help to remove it more easily. There are three o-rings: one under the rotor cap, one on the rotor stem and the rotor seal. Replace worn o-rings. Clean rotor. Reinstall rotor.

When reinstalling the red arrow handles be sure that:

1. The handle pointers are lined up with the control valve body arrows, and the rotor seal o-ring and retainer on both rotors face to the right when being viewed from the front of the control valve; or
2. Arrows point toward each other in the bypass position.

Since the handles can be pulled off, they could be accidentally reinstalled 180° from their correct orientation. To install the red arrow handles correctly, keep the handles pointed in the same direction as the arrows engraved on the control valve body while tightening the bypass valve caps.

After completing any valve maintenance, press and hold NEXT and REGEN buttons for 3 seconds or unplug power source jack (black wire) and plug back in. This resets the electronics and establishes the service piston position. The display should flash all wording, then flash the software version and then reset the valve to the service position.

Drawings and Part Numbers

WS1CH & WS1.25CH Front Cover and Drive Assembly

Drawing No.	Order No.	Description	Quantity
1	V3435-01	WS1CH Front Cover Assembly	1
2	V3107-01	WS1 Motor	1
3	V3106-01	WS1 Drive Bracket & Spring Clip	1
4	V3558CH	WS1/1.25/1.5/2L CH PC Board	1
5	V3110	WS1 Drive Gear 12x36	3
6	V3109	WS1 Drive Gear Cover	1
Not Shown	V3186	WS1 AC ADAPTER 110V-12V	1
	V3186EU	WS1 AC ADAPTER 220-240V-12V EU	
	V3186UK	WS1 AC ADAPTER 220-240V-12V UK	
	V3186-01	WS1 AC ADAPTER CORD ONLY	

Relay Specifications: To insure proper fit and correct operation the following relay and relay socket manufactured by Idec or the exact equivalent should be used.

	Idec Model and Description
Relay Socket	SH3B-05C 3 pole finger safe rail mount socket
Relay	RH2LB-U-AC12V 12vac, DPDT magnetic latching relay

The relay supplies 2 sets of dry contacts for user applications. The wiring of these contacts is application specific.

Wiring For Correct On/Off Operation	
PC Board Relay Terminal Block	Relay Socket
SET	#13
COM	#12 and #14
RES	#9

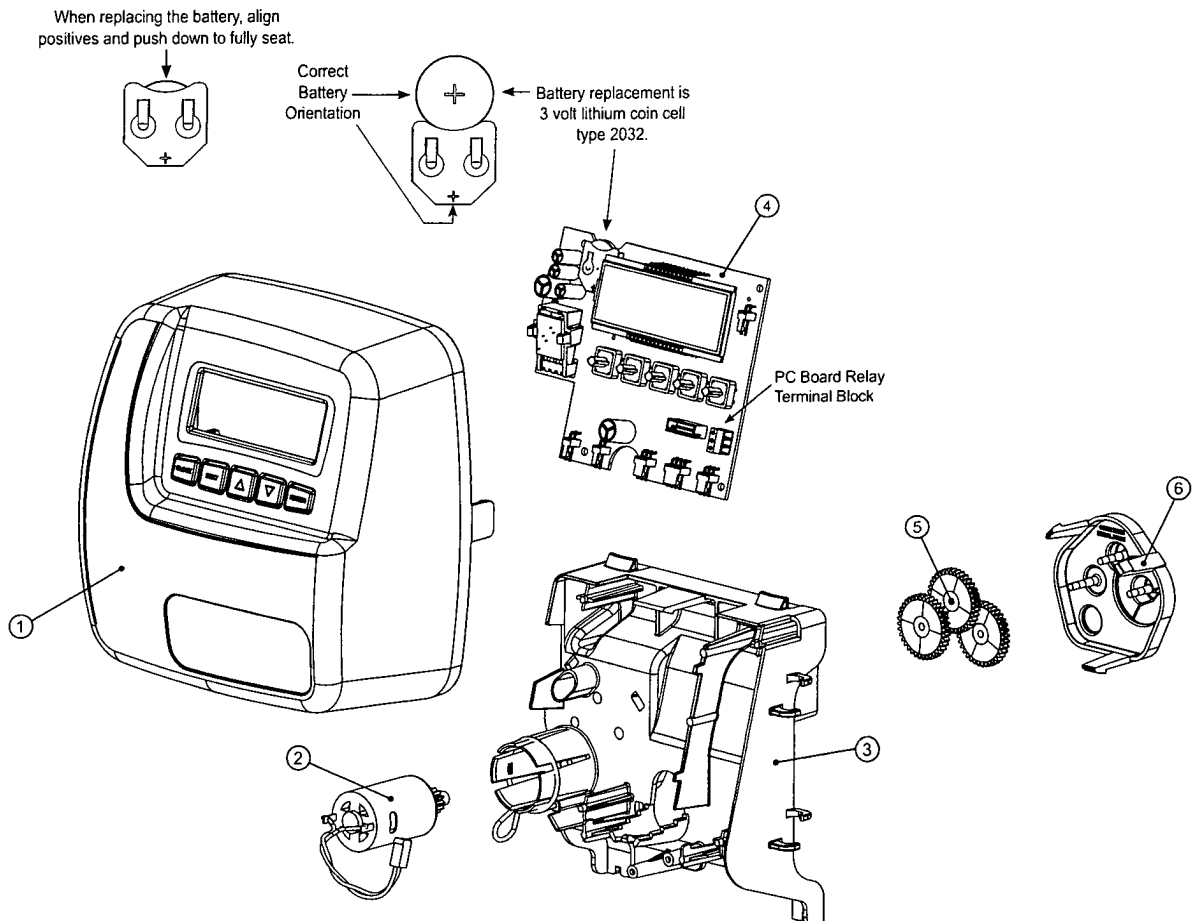

WS1CH Drive Cap Assembly, Downflow Piston, Upflow Piston, Regenerant Piston and Spacer Stack Assembly

Drawing No.	Order No.	Description	Quantity
1	V3005	WS1 Spacer Stack Assembly	1
2	V3004	Drive Cap ASY	1
3	V3178	WS1 Drive Back Plate	1
4a	V3011*	WS1 Piston Downflow ASY	1
4b	V3011-01*	WS1 Piston Upflow ASY	
5	V3174	WS1 Regenerant Piston	1
6	V3135	O-ring 228	1
7	V3180	O-ring 337	1
8	V3105	O-ring 215 (Distributor Tube)	1
Not Shown	V3001	WS1 Body ASY Downflow	1
	V3001-02	WS1 Mixing Valve Body ASY	
	V3001UP	WS1 Body ASY Upflow	
	V3001-02UP	WS1 Mixing Valve Body Upflow ASY	

*V3011 is labeled with DN and V3011-01 is labeled with UP.
 Note: The regenerant piston is not used in backwash only applications.

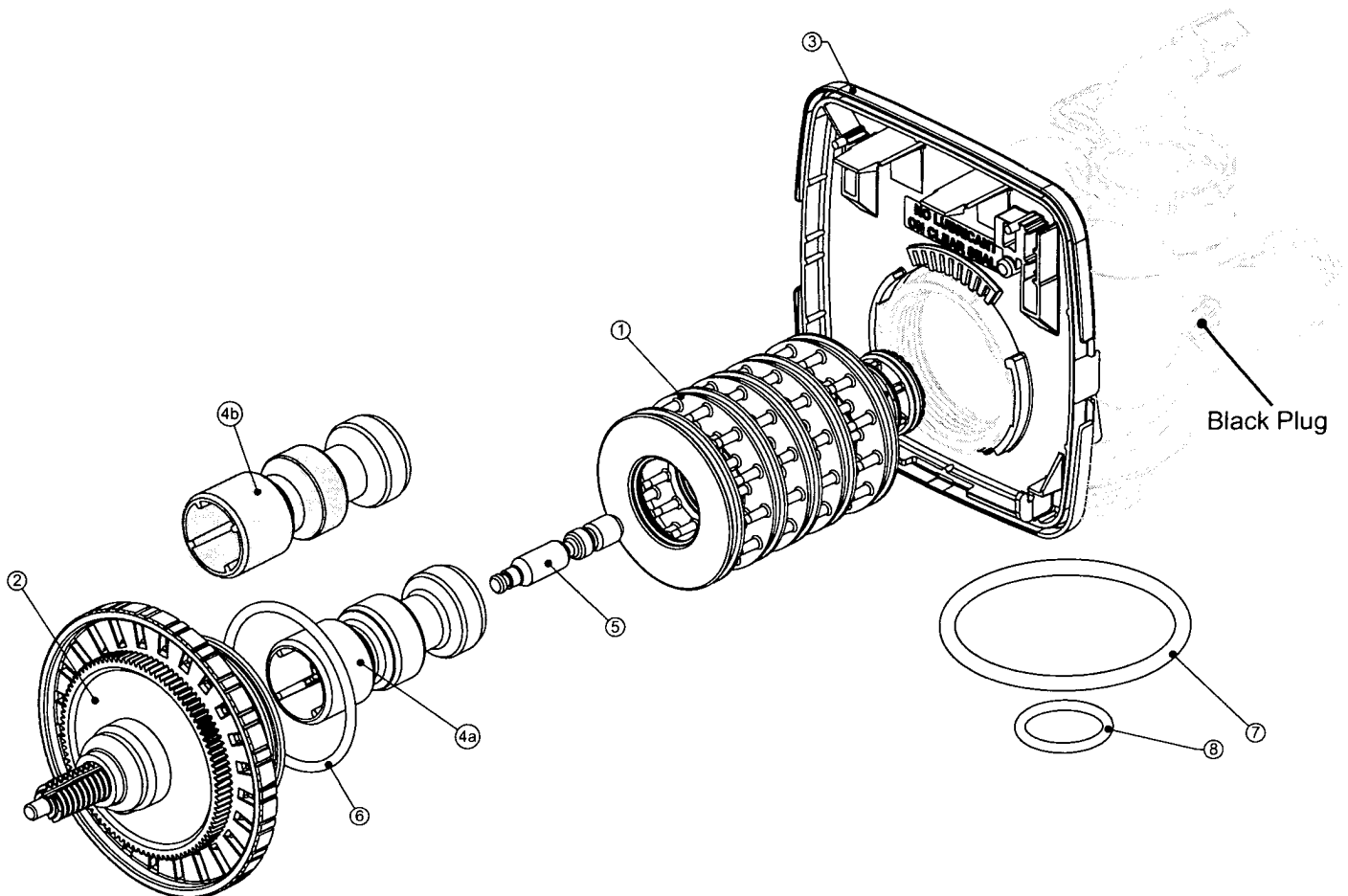

WS1.25CH Drive Cap Assembly, Downflow Piston, Regenerant Piston and Spacer Stack Assembly

Drawing No.	Order No.	Description	Quantity
1	V3430	WS1.5 Spacer Stack Assembly	1
2	V3004	Drive Cap ASY	1
3	V3178	WS1 Drive Back Plate	1
4	V3407	WS1.5 Piston Downflow ASY	1
5	V3174	WS1 Regenerant Piston	1
6	V3135	O-ring 228	1
7	V3180	O-ring 337	1
8	V3358	O-ring 219 (Distributor Tube Opening 1.32")	1
	V3357	O-ring 218 (Distributor Tube Opening 32mm)	
Not Shown	V3020	WS1.25 Body ASY Downflow (Distributor Tube Opening 1.32")	1
	V3020-01	WS1.25 Mixing Valve Body Downflow ASY (Distributor Tube Opening 1.32")	
	V3020-02	WS1.25 Body ASY Downflow (Distributor Tube Opening 32mm)	
	V3020-03	WS1.25 Mixing Valve Body Downflow ASY (Distributor Tube Opening 32mm)	

Note: The regenerant piston is not used in backwash only applications.

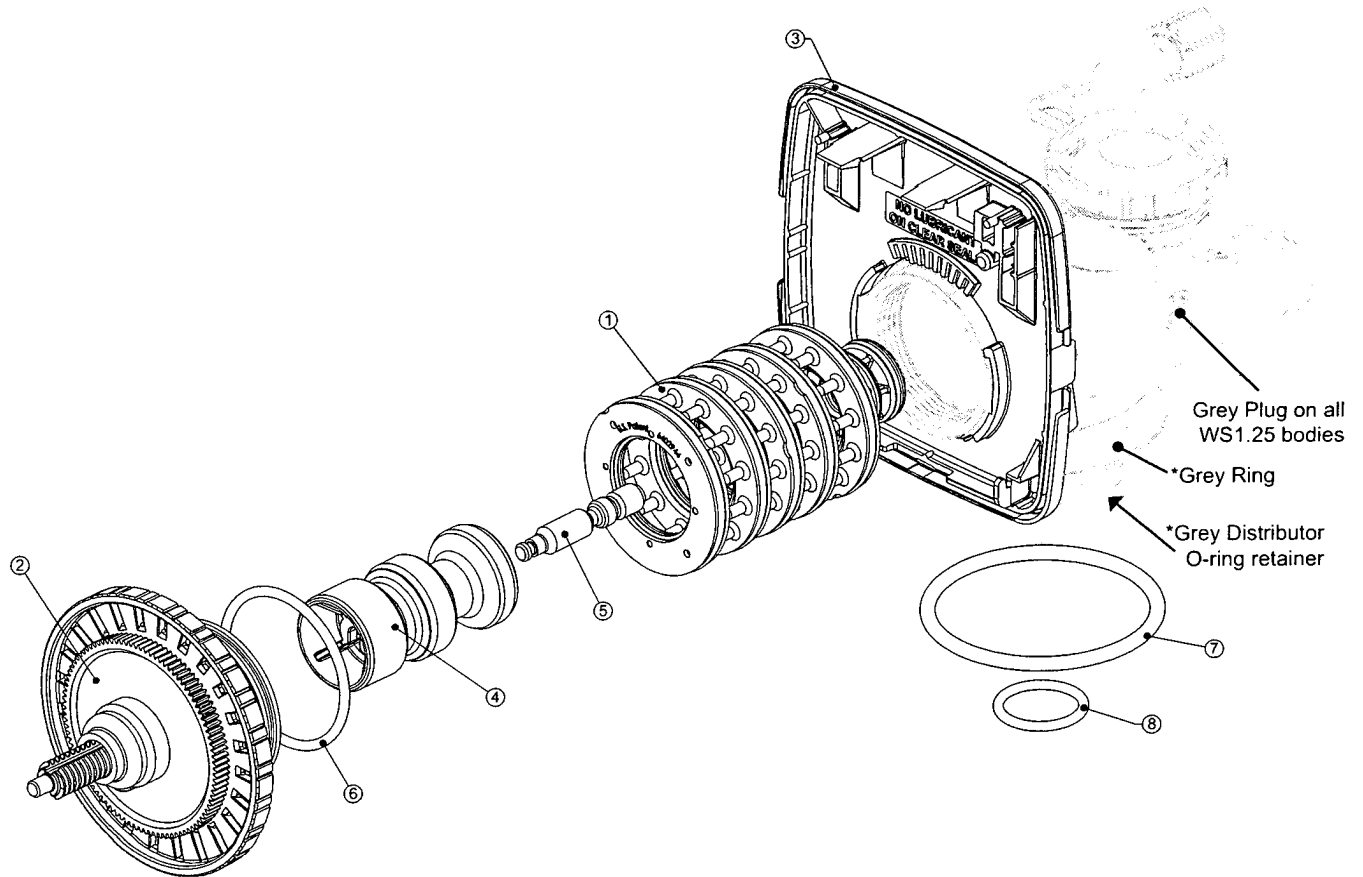

*Only for valves that have a 32mm Distributor Tube Opening

Injector Cap, Injector Screen, Injector, Plug and O-Ring

Drawing No.	Order No.	Description	Quantity
1	V3176	INJECTOR CAP	1
2	V3152	O-RING 135	1
3	V3177-01	INJECTOR SCREEN CAGE	1
4	V3010-1Z	WS1 INJECTOR ASY Z PLUG	1
5	V3010-1A	WS1 INJECTOR ASY A BLACK	1
	V3010-1B	WS1 INJECTOR ASY B BROWN	
	V3010-1C	WS1 INJECTOR ASY C VIOLET	
	V3010-1D	WS1 INJECTOR ASY D RED	
	V3010-1E	WS1 INJECTOR ASY E WHITE	
	V3010-1F	WS1 INJECTOR ASY F BLUE	
	V3010-1G	WS1 INJECTOR ASY G YELLOW	
	V3010-1H	WS1 INJECTOR ASY H GREEN	
	V3010-1I	WS1 INJECTOR ASY I ORANGE	
	V3010-1J	WS1 INJECTOR ASY J LIGHT BLUE	
V3010-1K	WS1 INJECTOR ASY K LIGHT GREEN		
Not Shown	V3170	O-RING 011	*
Not Shown	V3171	O-RING 013	*

* The injector plug and the injector each contain one 011 (lower) and 013 (upper) o-ring.

Note: For upflow position, injector is located in the up hole and injector plug is in the other hole. WS1CH upflow bodies are identified by having the DN marking removed. For a filter that only backwashes, injector plugs are located in both holes.

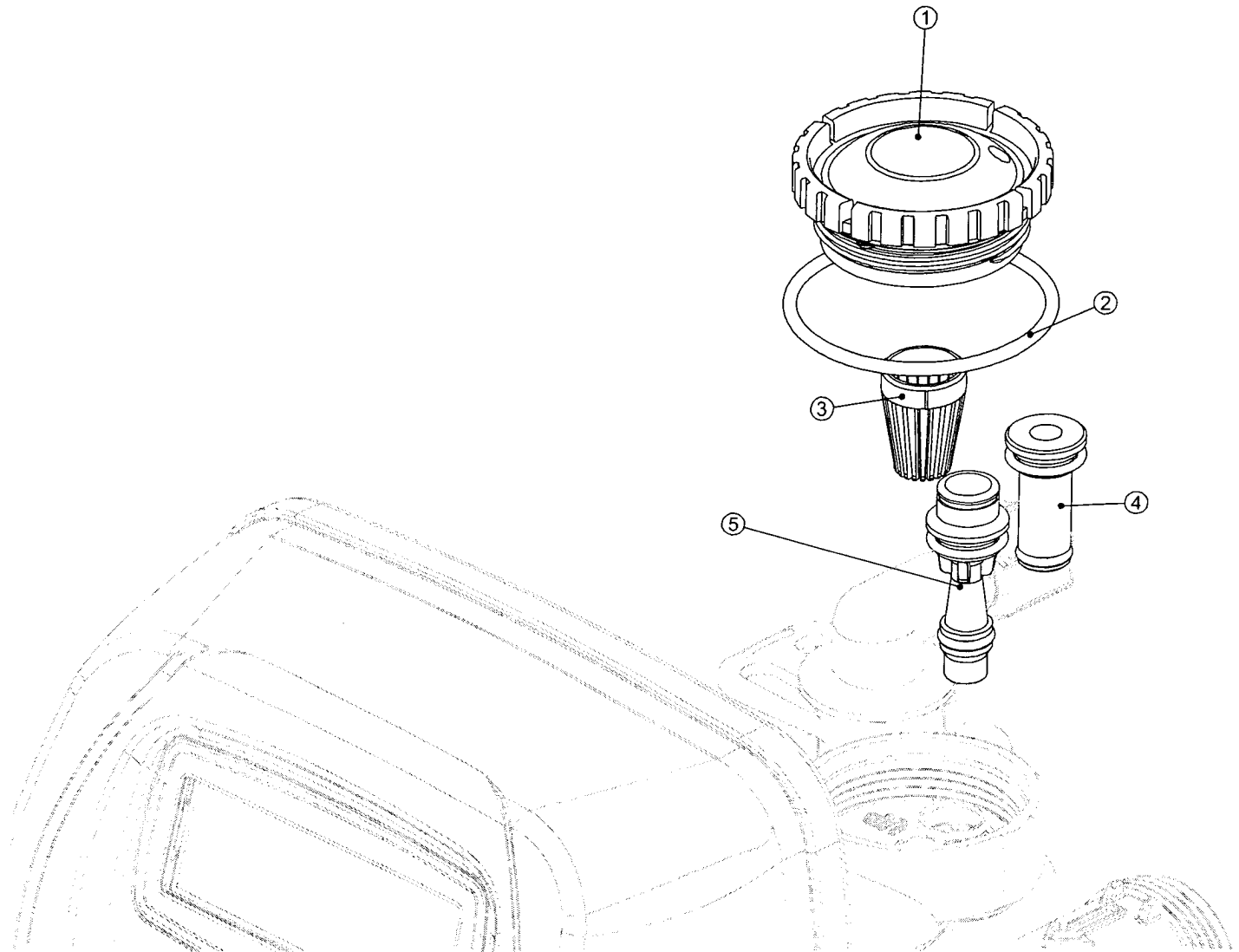

Refill Flow Control Assembly and Refill Port Plug

Drawing No.	Order No.	Description	Quantity
1	V3195-01	WS1 Refill Port Plug Asy	This part is required for backwash only systems
2	H4615	Elbow Locking Clip	1
3	JCP-P-6	Polytube insert 3/8"	1
4	JCPG-6PBLK	Nut 3/8"	1
5	H4613	Elbow Cap 3/8"	1
6	V3163	O-ring 019	1
7	V3165-01*	WS1 RFC Retainer Asy	1
8	V3182	WS1 RFC	1
9	V3330-01	WS1 Brine Elbow Asy w/RFC 3/8"	Option
Not Shown	V3552	WS1 Brine Elbow Asy w/RFC 1/2"	Option
Not Shown	H4650	Elbow 1/2" with nut and insert	Option

*Assembly includes V3182 WS1 RFC.

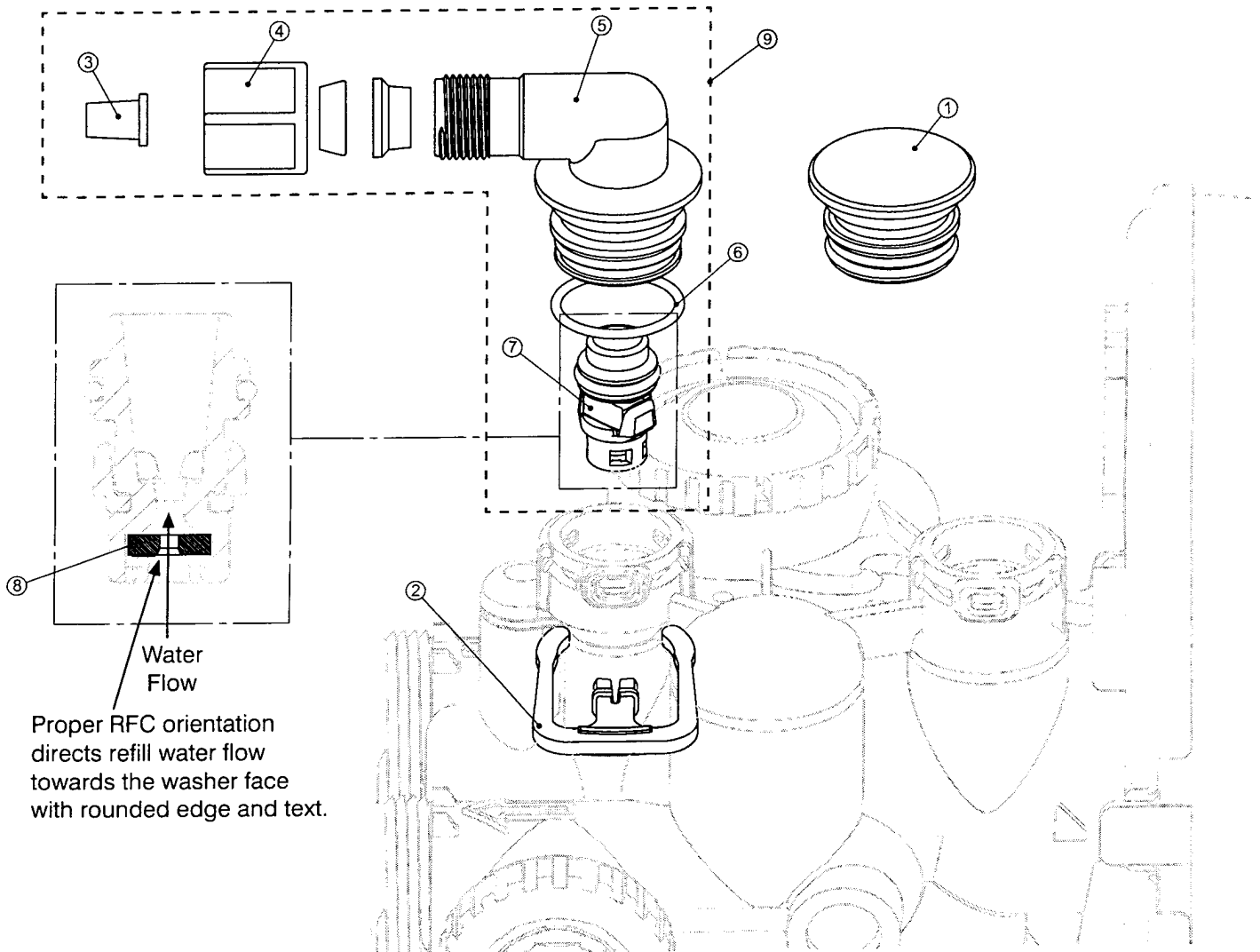

Drain Line – 3/4"

Drawing No.	Order No.	Description	Quantity
1	H4615	Elbow Locking Clip	1
2	PKP10TS8-BULK	Polytube insert 5/8	Option
3	V3192	WS1 Nut 3/4 Drain Elbow	Option
4*	V3158-01	WS1 Drain Elbow 3/4 Male	1
5	V3163	O-ring 019	1
6*	V3159-01	WS1 DLFC Retainer ASY	1
7	V3162-007	WS1 DLFC 0.7 gpm for 3/4	One DLFC must be used if 3/4 fitting is used
	V3162-010	WS1 DLFC 1.0 gpm for 3/4	
	V3162-013	WS1 DLFC 1.3 gpm for 3/4	
	V3162-017	WS1 DLFC 1.7 gpm for 3/4	
	V3162-022	WS1 DLFC 2.2 gpm for 3/4	
	V3162-027	WS1 DLFC 2.7 gpm for 3/4	
	V3162-032	WS1 DLFC 3.2 gpm for 3/4	
	V3162-042	WS1 DLFC 4.2 gpm for 3/4	
	V3162-053	WS1 DLFC 5.3 gpm for 3/4	
	V3162-065	WS1 DLFC 6.5 gpm for 3/4	
	V3162-075	WS1 DLFC 7.5 gpm for 3/4	
	V3162-090	WS1 DLFC 9.0 gpm for 3/4	
	V3162-100	WS1 DLFC 10.0 gpm for 3/4	

*4 and 6 can be ordered as a complete assembly - V3331 WS1 Drain Elbow and Retainer Asy

Valves are shipped without drain line flow control (DLFC) - install DLFC before using. Valves are shipped without 3/4 nut for drain elbow (polytube installation only) and 5/8" polytube insert (polytube installation only).

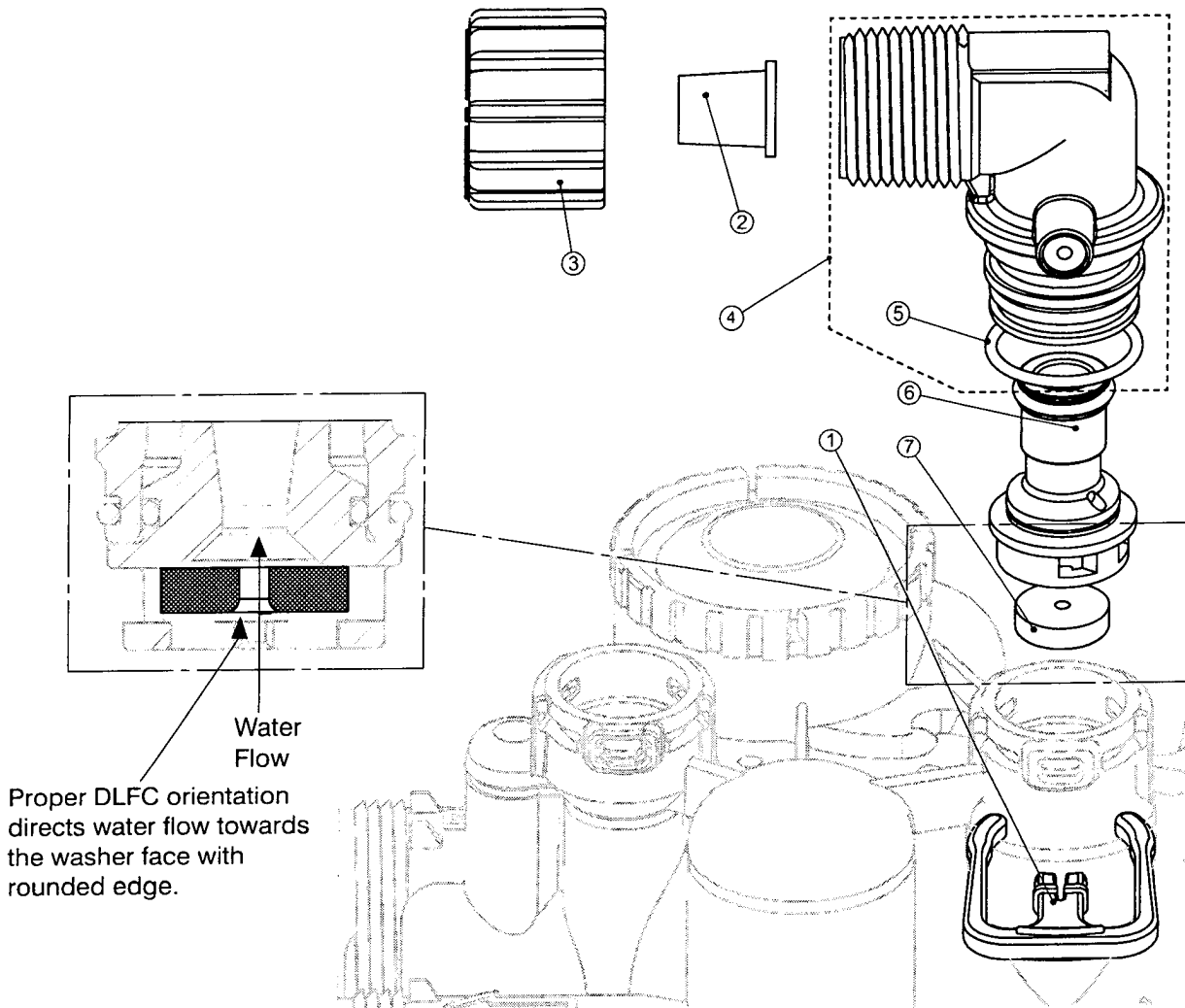

Drain Line - 1"

Drawing No.	Order No.	Description	Quantity
1	H4615	Elbow Locking Clip	1
2	V3008-02	WS1 Drain FTG 1 Straight	1
3*	V3166	WS1 Drain FTG Body 1	1
4*	V3167	WS1 Drain FTG Adapter 1	1
5*	V3163	O-ring 019	1
6*	V3150	WS1 Split Ring	1
7*	V3151	WS1 Nut 1" QC	1
8*	V3105	O-ring 215	1
9	V3190-090	WS1 DLFC 9.0 gpm for 1	One DLFC must be used if 1" fitting is used
	V3190-100	WS1 DLFC 10.0 gpm for 1	
	V3190-110	WS1 DLFC 11.0 gpm for 1	
	V3190-130	WS1 DLFC 13.0 gpm for 1	
	V3190-150	WS1 DLFC 15.0 gpm for 1	
	V3190-170	WS1 DLFC 17.0 gpm for 1	
	V3190-200	WS1 DLFC 20.0 gpm for 1	
V3190-250	WS1 DLFC 25.0 gpm for 1		

* Can be ordered as a set. Order number V3008-02, description: WS1 Drain FTG 1 Straight.

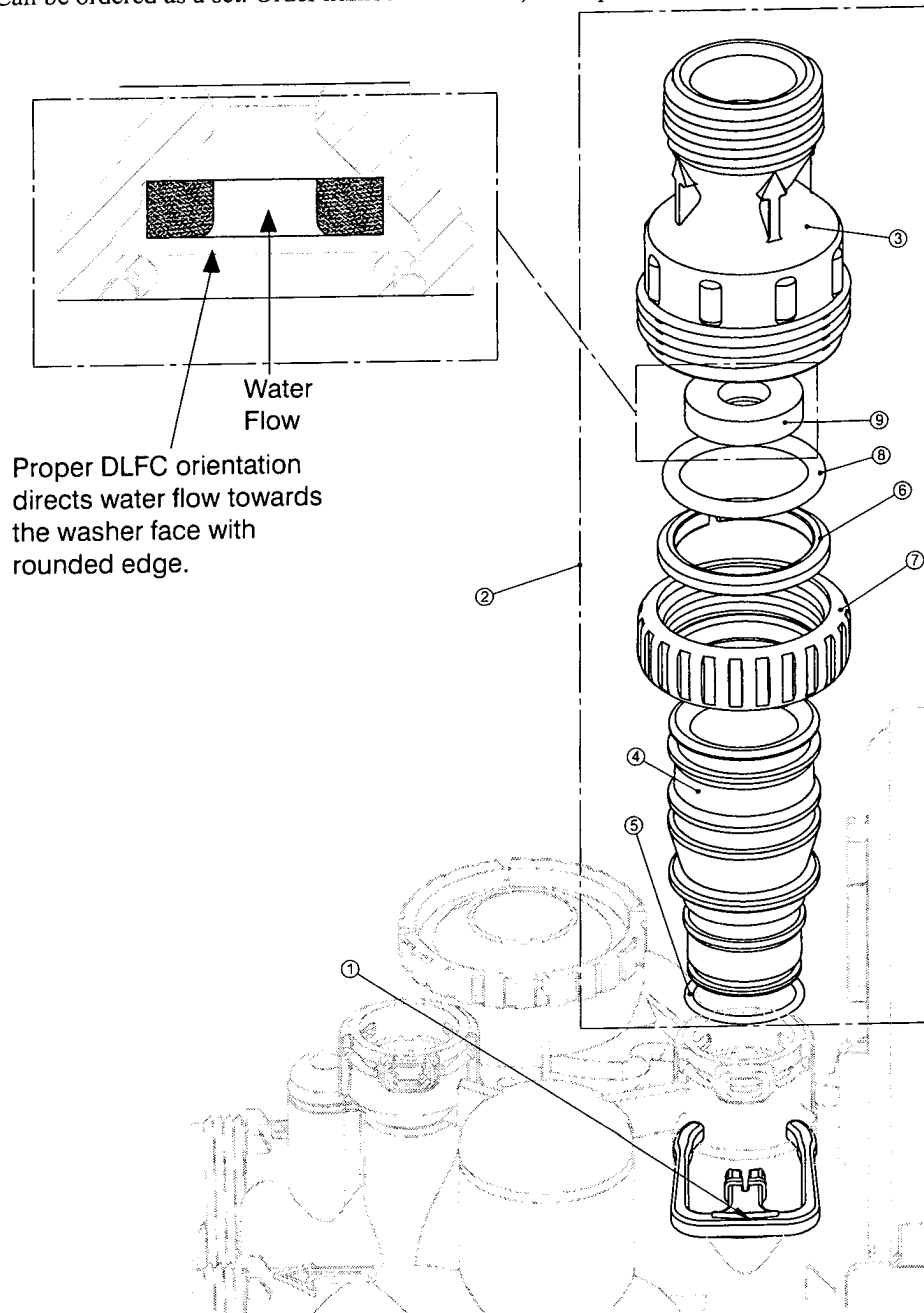

Water Meter, Meter Plug and Mixing Valve

Drawing No.	Order No.	Description	Quantity
1	V3151	WS1 Nut 1" QC	1
2	V3003*	WS1 Meter ASY	1
3	V3118-01	WS1 Turbine ASY	1
4	V3105	O-ring 215	1
5	V3003-01	WS1 Meter Plug ASY	1
6	V3013	Mixing Valve	Optional

*Order number V3003 includes V3118-01 WS1 Turbine ASY and V3105 O-ring 215.

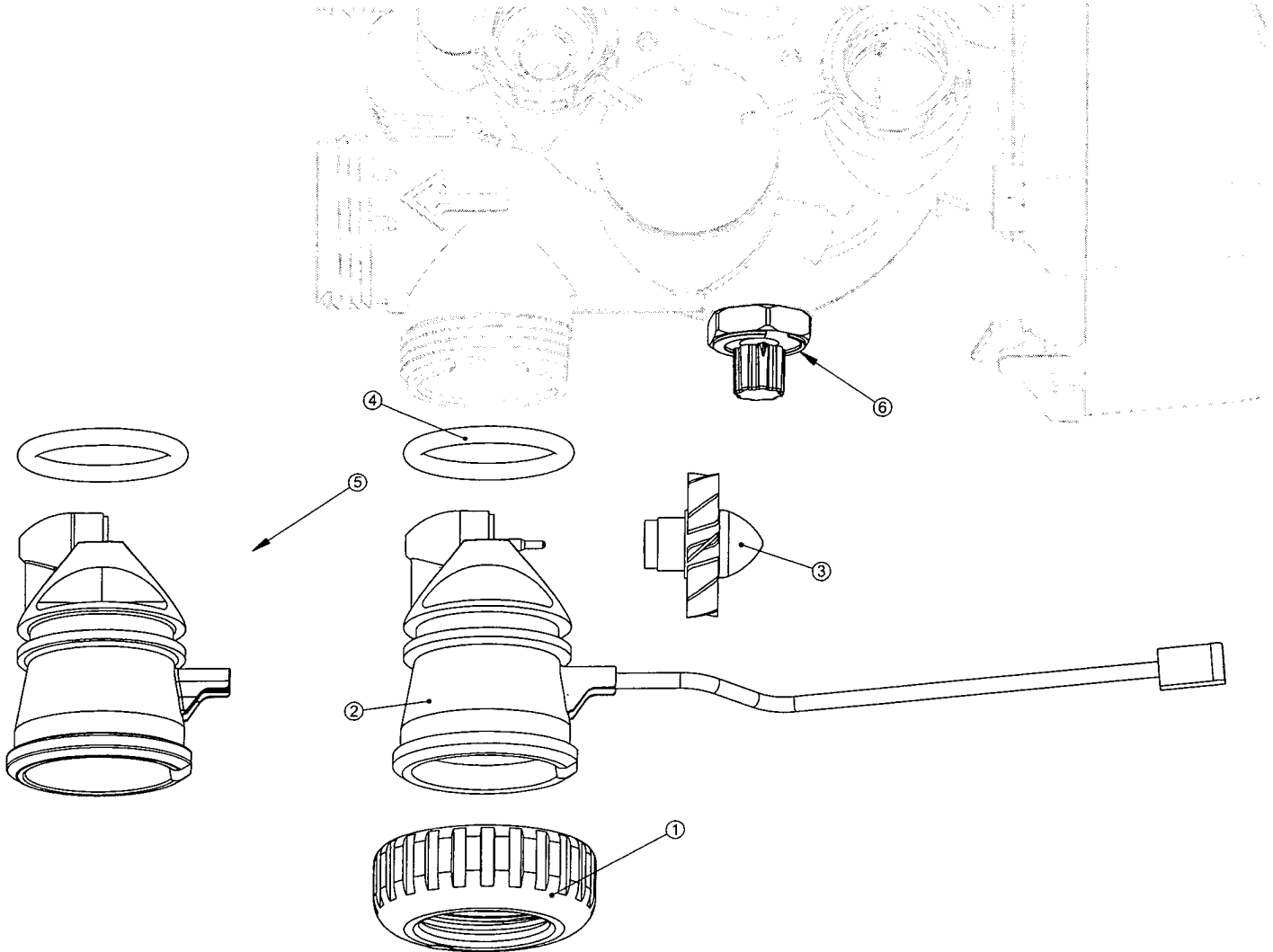

THIS WATER METER SHOULD NOT BE USED AS THE PRIMARY MONITORING DEVICE FOR CRITICAL HEALTH EFFECT APPLICATIONS.

Installation Fitting Assemblies

Order No: V3007

Description: **WS1 Fitting 1" PVC Male NPT Elbow Assembly**

Drawing No.	Order No.	Description	Quantity
1	V3151	WS1 Nut 1" Quick Connect	2
2	V3150	WS1 Split Ring	2
3	V3105	O-Ring 215	2
4	V3149	WS1 Fitting 1" PVC Male NPT Elbow	2

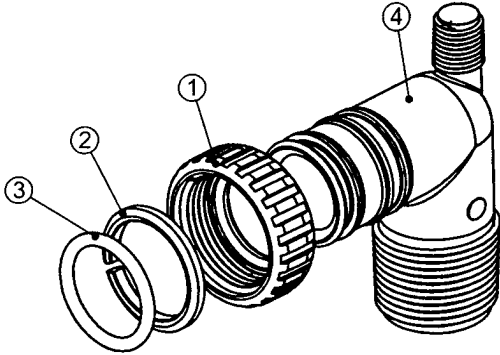

Order No: V3007-01

Description: **WS1 Fitting 3/4" & 1" PVC Solvent 90° ASY**

Drawing No.	Order No.	Description	Quantity
1	V3151	WS1 Nut 1" Quick Connect	2
2	V3150	WS1 Split Ring	2
3	V3105	O-Ring 215	2
4	V3189	WS1 Fitting 3/4" & 1" PVC Solvent 90	2

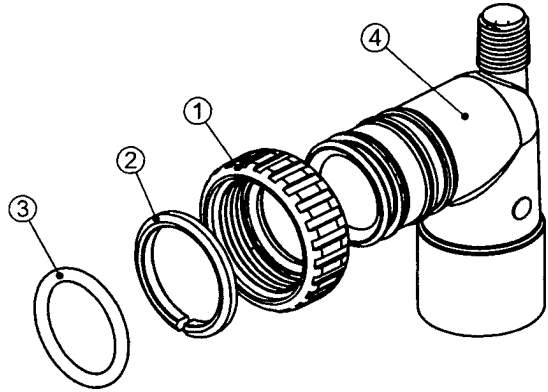

Order No: V3007-02

Description: **WS1 Fitting 1" Brass Sweat Assembly**

Drawing No.	Order No.	Description	Quantity
1	V3151	WS1 Nut 1" Quick Connect	2
2	V3150	WS1 Split Ring	2
3	V3105	O-Ring 215	2
4	V3188	WS1 Fitting 1" Brass Sweat Assembly	2

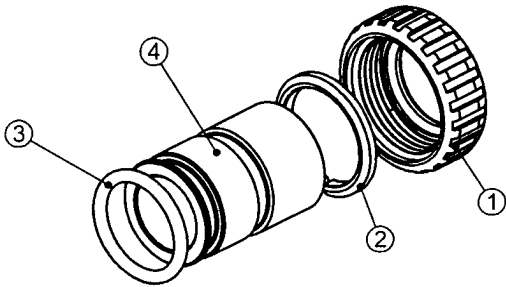

Order No: V3007-03

Description: **WS1 Fitting 3/4" Brass Sweat Assembly**

Drawing No.	Order No.	Description	Quantity
1	V3151	WS1 Nut 1" Quick Connect	2
2	V3150	WS1 Split Ring	2
3	V3105	O-Ring 215	2
4	V3188-01	WS1 Fitting 3/4" Brass Sweat	2

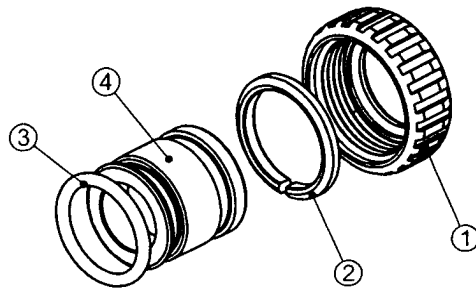

Order No: V3007-04

Description: **WS1 Fitting 1" Plastic Male NPT Assembly**

Drawing No.	Order No.	Description	Quantity
1	V3151	WS1 Nut 1" Quick Connect	2
2	V3150	WS1 Split Ring	2
3	V3105	O-Ring 215	2
4	V3164	WS1 Fitting 1" Plastic Male NPT	2

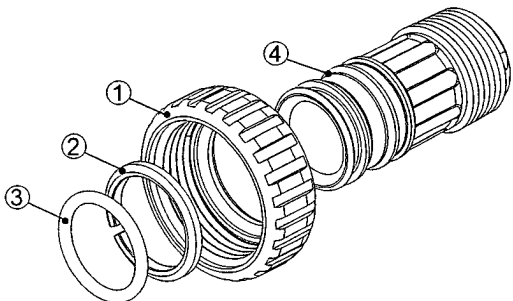

Order No: V3007-05

Description: **WS1 Fitting 1-1/4" Plastic Male Assembly**

Drawing No.	Order No.	Description	Quantity
1	V3151	WS1 Nut 1" Quick Connect	2
2	V3150	WS1 Split Ring	2
3	V3105	O-Ring 215	2
4	V3317	WS1 Fitting 1-1/4" Plastic Male NPT	2

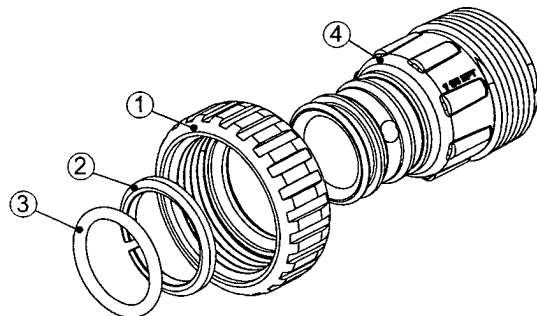

Installation Fitting Assemblies

Order No. V3007-06

Description: **WS1 Fitting 1" Plastic Male BSPT Assembly**

Drawing No.	Order No.	Description	Quantity
1	V3151	WS1 Nut 1" Quick Connect	2
2	V3150	WS1 Split Ring	2
3	V3105	O-Ring 215	2
4	V3316	WS1 Fitting 1" Plastic Male BSPT	2

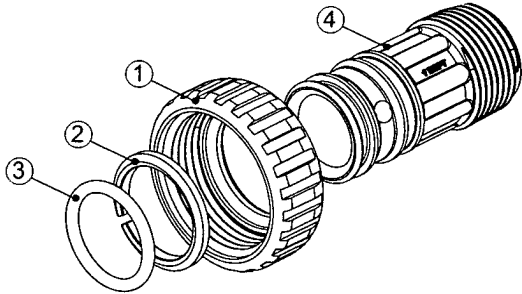

Order No. V3007-07

Description: **WS1 Fitting 1/4" & 1/2" PVC Solvent Assembly**

Drawing No.	Order No.	Description	Quantity
1	V3151	WS1 Nut 1" Quick Connect	2
2	V3150	WS1 Split Ring	2
3	V3105	O-Ring 215	2
4	V3352	WS1 Fitting 1/4" & 1/2" PVC Solvent	2

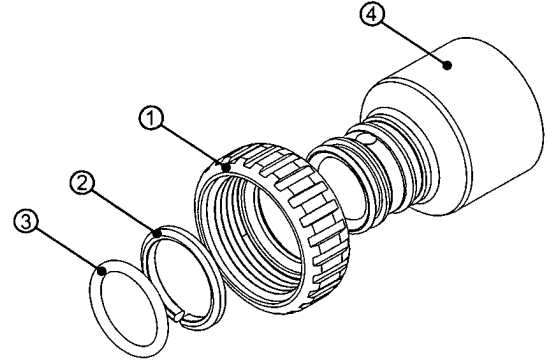

Order No. V3007-08

Description: **WS1 Fitting 1-1/4" Plastic Male BSPT Assembly**

Drawing No.	Order No.	Description	Quantity
1	V3151	WS1 Nut 1" Quick Connect	2
2	V3150	WS1 Split Ring	2
3	V3105	O-Ring 215	2
4	V3361	WS1 Fitting 1-1/4" Plastic Male BSPT	2

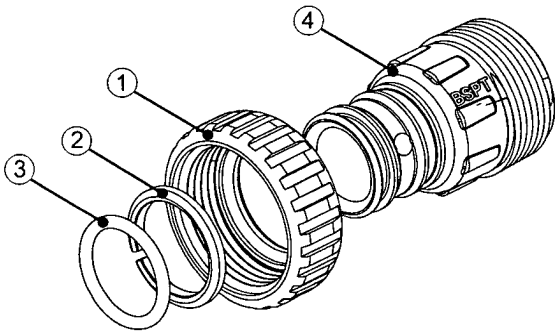

Order No. V3007-09

Description: **WS1 Fitting 1/4" & 1/2" Brass Sweat Assembly**

Drawing No.	Order No.	Description	Quantity
1	V3151	WS1 Nut 1" Quick Connect	2
2	V3150	WS1 Split Ring	2
3	V3105	O-Ring 215	2
4	V3375	WS1 Fitting 1/4" & 1/2" Brass Sweat	2

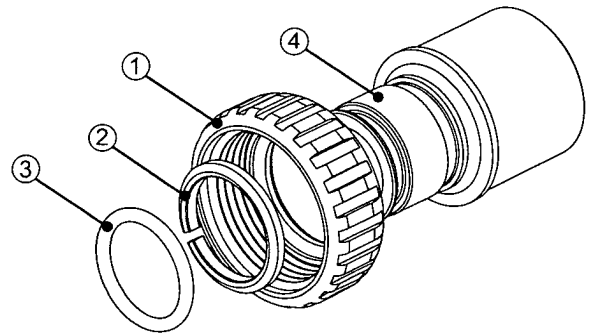

Order No. V3007-10

Description: **WS1 Fitting 3/4" PEX Assembly**

Drawing No.	Order No.	Description	Quantity
1	V3151	WS1 Nut 1" Quick Connect	2
2	V3150	WS1 Split Ring	2
3	V3105	O-Ring 215	2
4	V3535	WS1 Fitting 3/4" PEX	2

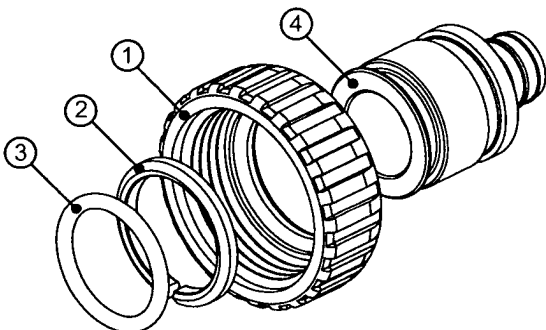

Order No. V3007-11

Description: **WS1 Fitting 1" PEX Assembly**

Drawing No.	Order No.	Description	Quantity
1	V3151	WS1 Nut 1" Quick Connect	2
2	V3150	WS1 Split Ring	2
3	V3105	O-Ring 215	2
4	V3515	WS1 Fitting 1" PEX	2

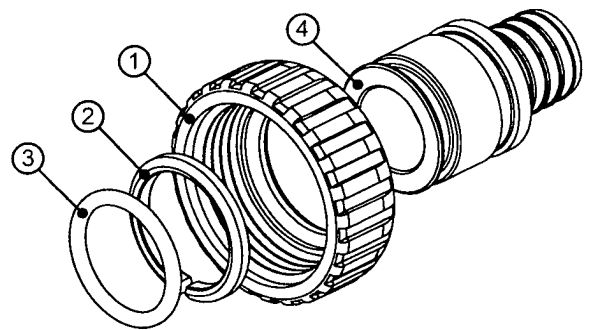

Bypass Valve

Drawing No.	Order No.	Description	Quantity
1	V3151	WS1 Nut 1" Quick Connect	2
2	V3150	WS1 Split Ring	2
3	V3105	O-Ring 215	2
4	V3145	WS1 Bypass 1" Rotor	2
5	V3146	WS1 Bypass Cap	2
6	V3147	WS1 Bypass Handle	2
7	V3148	WS1 Bypass Rotor Seal Retainer	2
8	V3152	O-ring 135	2
9	V3155	O-ring 112	2
10	V3156	O-ring 214	2

(Not Shown) Order No. V3191-01, Description: WS1 Bypass Vertical Adapter Assembly

Order No.	Description	Quantity
V3151	WS1 Nut 1" Quick Connect	2
V3150	WS1 Split Ring	2
V3105	O-Ring 215	2
V3191	WS1 Bypass Vertical Adapter	2

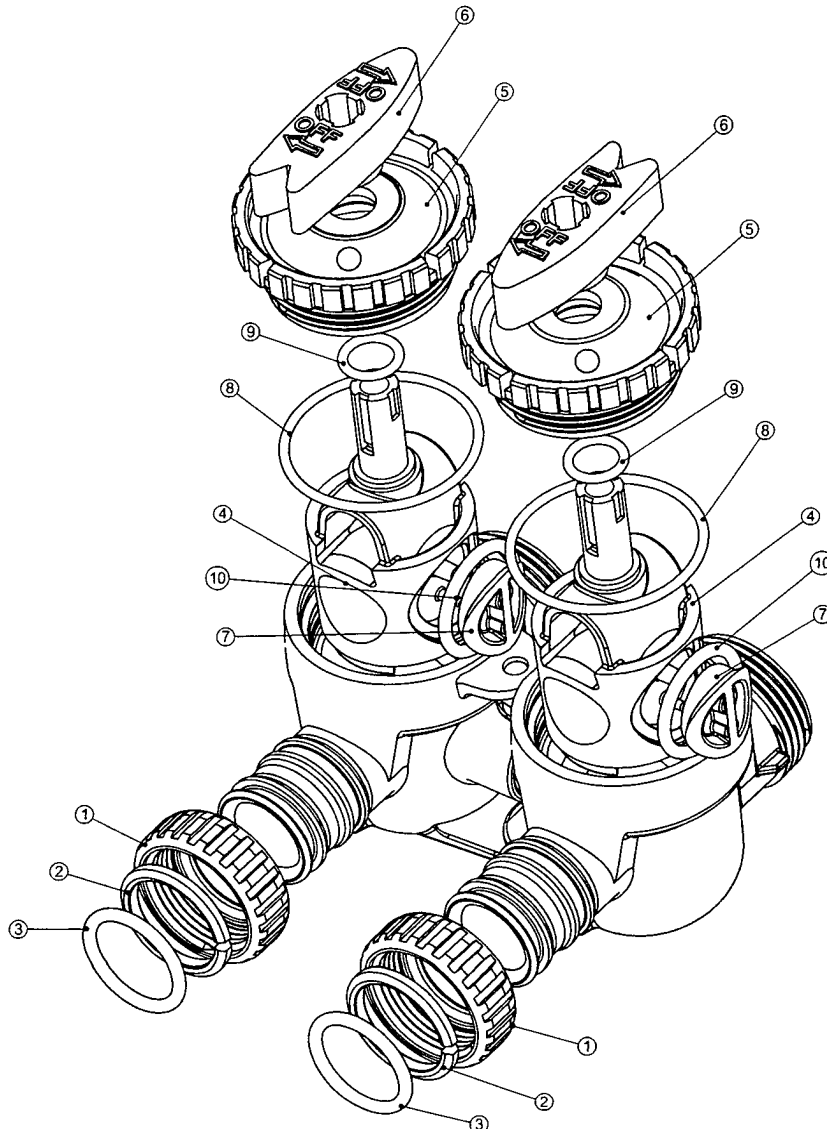

WS1 Wrench (Order No. V3193-01)

Although no tools are necessary to assemble or disassemble the valve, the WS1 wrench (shown in various positions on the valve) may be purchased to aid in assembly or disassembly.

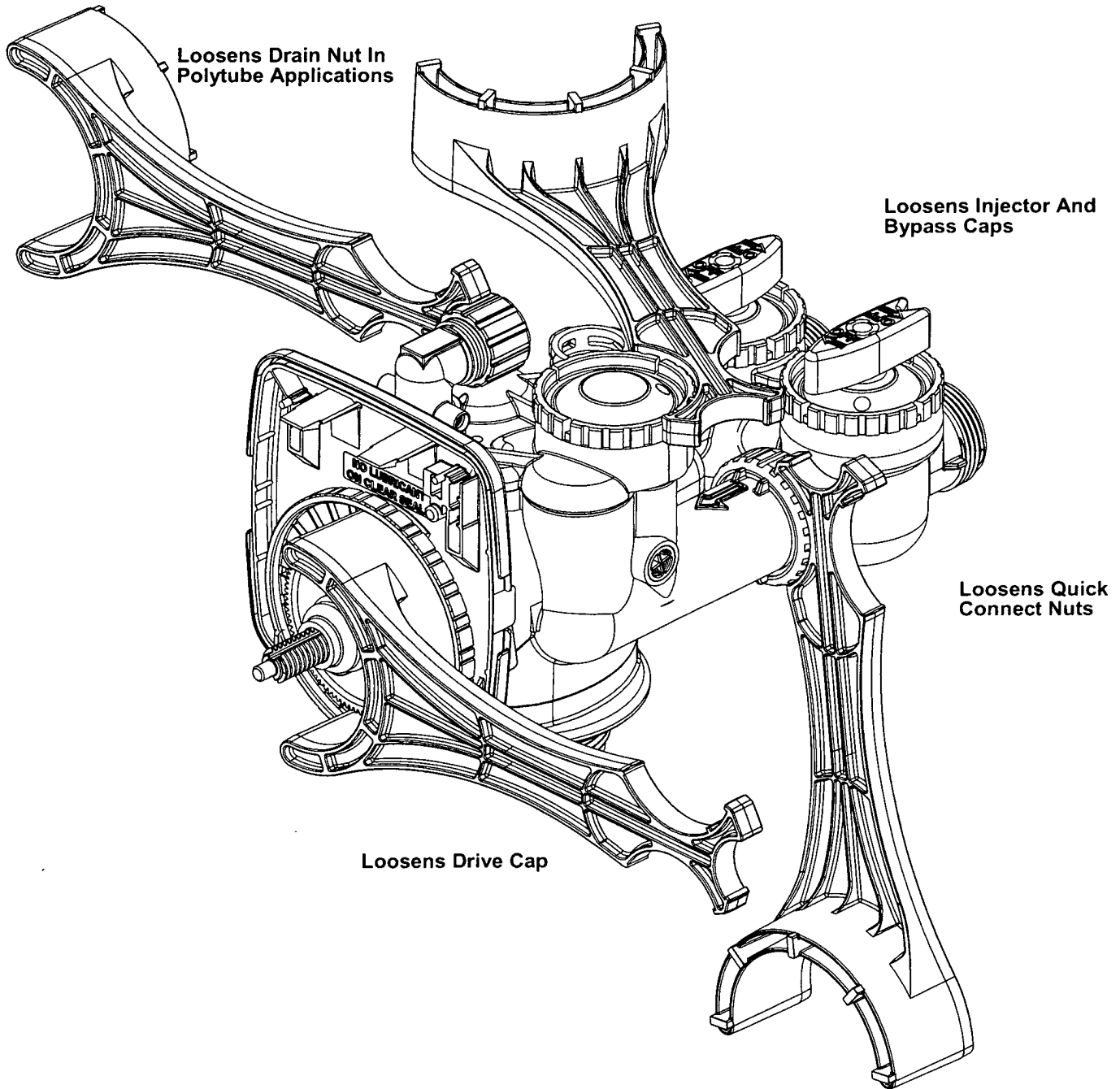
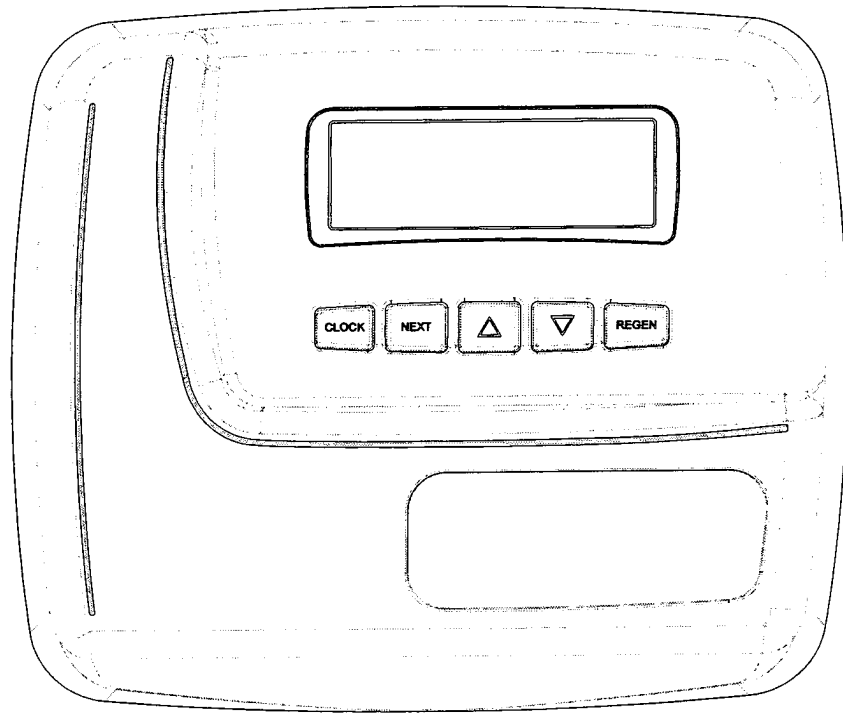

Table 10
Troubleshooting Procedures

Problem	Possible Cause	Solution
1. Timer does not display time of day	a. AC Adapter unplugged	a. Connect power
	b. No electric power at outlet	b. Repair outlet or use working outlet
	c. Defective AC Adapter	c. Replace AC Adapter
	d. Defective PC board	d. Replace PC board
2. Timer does not display correct time of day	a. Switched outlet	a. Use uninterrupted outlet
	b. Power outage	b. Reset time of day and replace battery
	c. Defective PC board	c. Replace PC board
3. No softening/filtering display when water is flowing	a. Bypass valve in bypass position	a. Put bypass valve in service position
	b. Meter connection disconnected	b. Connect meter to PC board
	c. Restricted/stalled meter turbine	c. Remove meter and check for rotation or foreign material
	d. Defective meter	d. Replace meter
	e. Defective PC board	e. Replace PC board
4. Control valve regenerates at wrong time of day	a. Power outages	a. Reset control valve to correct time of day and replace battery
	b. Time of day not set correctly	b. Reset to correct time of day
	c. Time of regeneration incorrect	c. Reset regeneration time
	d. Control valve set at "on 0" (immediate regeneration)	d. Check control valve set-up procedure regeneration time option
	e. Control valve set at NORMAL + on 0	e. Check control valve set-up procedure regeneration time option
5. ERROR followed by code number Error Code 1001 -Unable to recognize start of regeneration Error Code 1002 – Unexpected stall Error Code 1003 – Motor ran to long, timed out trying to reach next cycle position Error Code 1004 - Motor ran to long, timed out trying to reach home position If other Error Codes followed by a number display contact the factory.	a. Control valve has just been serviced	a. Press NEXT and REGEN for 3 seconds or unplug power source jack (black wire) and plug back in to reset control valve
	b. Foreign matter is lodged in control valve	b. Check piston and spacer stack assembly for foreign matter
	c. High drive forces on piston	c. Replace piston(s) and spacer stack assembly
	d. Control valve piston not in home position	d. Press NEXT and REGEN for 3 seconds or unplug power source jack (black wire) and plug back in to reset control valve
	e. Motor not inserted fully to engage pinion, motor wires broken or disconnected, motor failure	e. Check motor and wiring. Replace motor if necessary
	f. Drive gear label dirty or damaged, missing or broken gear	f. Replace or clean drive gear
	g. Drive bracket incorrectly aligned to back plate	g. Reseat drive bracket properly
	h. PC board is damaged or defective	h. Replace PC board
	i. PC board incorrectly aligned to drive bracket	i. Ensure PC board is correctly snapped on to drive bracket

Problem	Possible Cause	Solution
6. Control valve stalled in regeneration	a. Motor not operating	a. Replace motor
	b. No electric power at outlet	b. Repair outlet or use working outlet
	c. Defective AC Adapter	c. Replace AC Adapter
	d. Defective PC board	d. Replace PC board
	e. Broken drive gear or drive cap assembly	e. Replace drive gear or drive cap assembly
	f. Broken piston retainer	f. Replace drive cap assembly
	g. Broken main or regenerant piston	g. Replace main or regenerant piston
7. Control valve does not regenerate automatically when REGEN button is depressed and held	a. AC Adapter unplugged	a. Connect AC Adapter
	b. No electric power at outlet	b. Repair outlet or use working outlet
	c. Broken drive gear or drive cap assembly	c. Replace drive gear or drive cap assembly
	d. Defective PC board	d. Replace PC board
8. Control valve does not regenerate automatically but does when REGEN button is depressed	a. By-pass valve in bypass position	a. Put bypass valve in normal operation position
	b. Meter connection disconnected	b. Connect meter to PC board
	c. Restricted/stalled meter turbine	c. Remove meter and check for rotation or foreign matter
	d. Defective meter	d. Replace meter
	e. Defective PC board	e. Replace PC board
	f. Set-up error	f. Check control valve set-up procedure
9. Time of day flashes on and off	a. Power outage	a. Reset the time of day and replace battery

WS1 & WS1 CD Matrix Control Valve Programming Manual



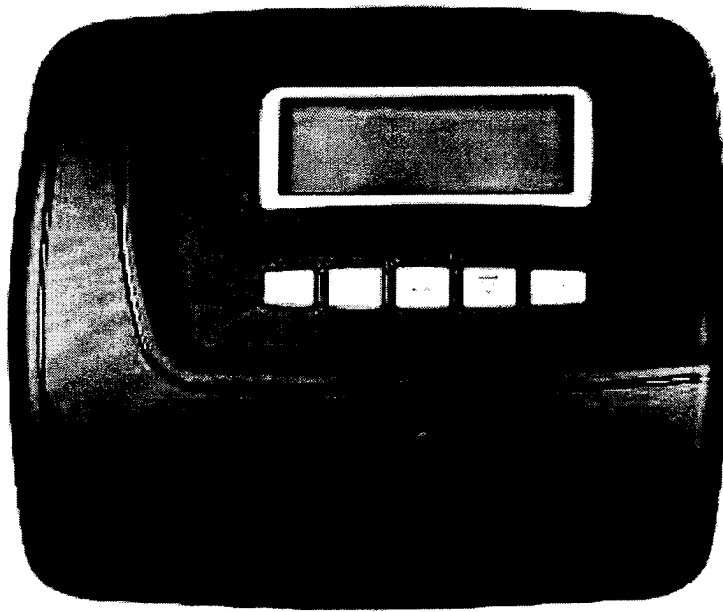

Standard Features for the “CD”

- Solid state microprocessor with soft touch silicone key pad
- Blue backlit Dot Matrix display with Energy Saver mode, backlight will automatically shut down with 5 minutes of no button actuation
- Fixed cycle sequence for Softening DN/ UP Pre or Post and Filtering Post treated water regenerant refill
- Fully programmable regeneration cycle duration times
- Four modes to initiate regeneration: meter immediate, meter delayed, time clock delayed, or pressure differential
- Auxiliary Input (dP) regeneration trigger for immediate, delayed, or hold
- Day override available from 1 to 28 days or OFF
- Can be set to operate on 1", 1.25", 1.5", or 2" valve type
- Backwash and Brining ability up to 48" diameter tanks
- Downflow / Upflow regeneration and proportional brining (1" / 1.25" valve types only)
- MAV/ NHWBP drive for ALT A, ALT B, NHWBP, Separate Source, or System Controller operation
- AUX drive for Time or Separate Source modes to operate an additional motorized MAV or NHWBP valve
- 2 on board relay drivers
- Stores all programming information and operational data in nonvolatile memory
- Coin Cell Lithium battery backup for time of day for the life of the battery
- 12-volt output UL CSA AC adapter provides safe and easy installation
- Customizable Dealer name and telephone number
- Programmable Service Call Alarm

Table of Contents

CD Front Cover and Drive Assembly	4
OEM General Programming Instructions	5
OEM Cycle Sequence	7
OEM Softener System Setup	14
Setting Options Table	17
OEM Filter System Setup	18
Installer Display Settings	20
User Display Settings.....	21
Diagnostics.....	24
Valve History	25

CD Front Cover and Drive Assembly

Drawing No.	Order No.	Description	Quantity
1	V3984-01	WS1 CD FRONT COVER ASSEMBLY	1
2	V3107-01	WS1 MOTOR ASY	1
3	V3106-01	WS1 DRIVE BRACKET & SPRING CLIP	1
4	V3985CD-BOARD	WS1 THRU 2L/2 CD PC 2 MAV BRD REPL	1
5	V3110	WS1 DRIVE REDUCING GEAR 12X36	3
6	V3109	WS1 DRIVE GEAR COVER	1
Not Shown	V3186	WS1 AC ADAPTER 120V-12V	1
	V3186AUS	WS1 AC ADAPTER 220-240V-12V AUST	
	V3186EU	WS1 AC ADAPTER 220-240V-12V EU	
	V3186UK	WS1 AC ADAPTER 220-240V-12V UK	
	V3186-01	WS1 AC ADAPTER CORD ONLY	
Not Shown	V3946	WS1 WIDE DRIVE BACK PLATE	1

Refer to Control Valve Service Manual for other drawings and part numbers.

Relay Specifications: 12V DC Relay with a coil resistance not less than 80 ohms. If mounting the relay under the cover check for proper mounting location dimensions on the backplate.

AC Adapter	U.S.	International
Supply Voltage	120 V AC	230V AC
Supply Frequency	60 Hz	50 Hz
Output Voltage	12 V AC	12 V AC
Output Current	500 mA	500 mA

Wiring For Correct On/Off Operation	
PC Board Relay Terminal Block	Relay
RLY 1	Coil -
V +	Coil +
RLY 2	Coil -

When replacing the battery, align positives and push down to fully seat.

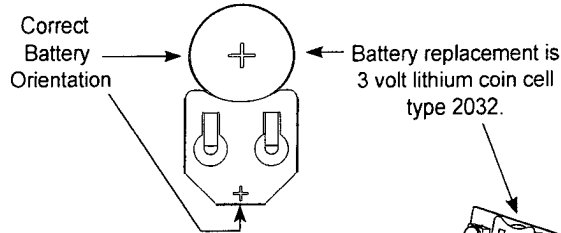
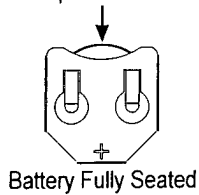

Battery replacement is 3 volt lithium coin cell type 2032.

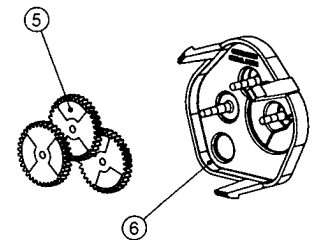
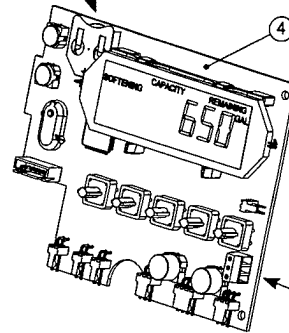
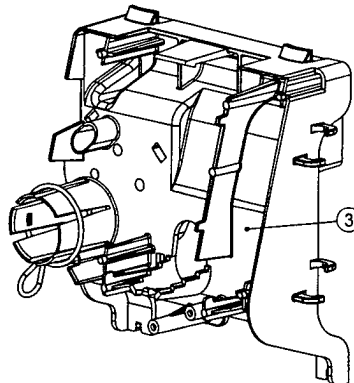
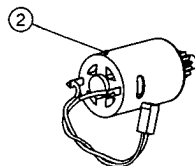
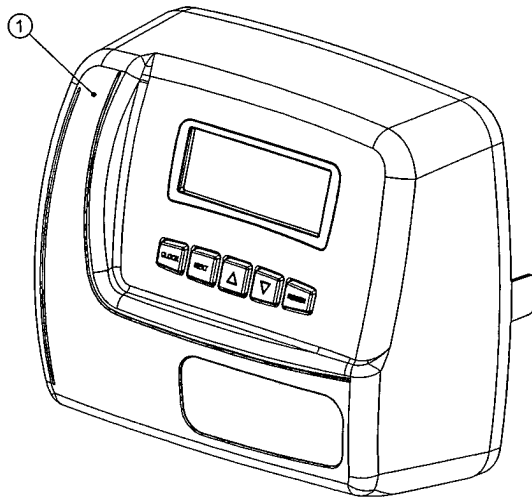

OEM General Programming Instructions

The control valve offers multiple procedures that allow the valve to be modified to suit the needs of the installation. These procedures are:

- OEM Configuration Setup
- OEM Softener System Setup
- OEM Filter System Setup
- Installer Display Settings
- User Display Settings
- Diagnostics
- Valve History

Tables 1 and 2 show examples when the valve is set up as a softener or filter.

Table 1: Regeneration Cycles Softening

Downflow Regenerant Refill After Rinse	Downflow Regenerant Prefill	WSICD only Upflow Regenerant Refill After Rinse	WSICD only Upflow Regenerant Prefill
1 st Cycle: Backwash 2 nd Cycle: dn Brine 3 rd Cycle: Backwash 4 th Cycle: Rinse 5 th Cycle: Fill	1 st Cycle: Fill 2 nd Cycle: Softening 3 rd Cycle: Backwash 4 th Cycle: dn Brine 5 th Cycle: Backwash 6 th Cycle: Rinse	1 st Cycle: UP Brine 2 nd Cycle: Backwash 3 rd Cycle: Rinse 4 th Cycle: Fill	1 st Cycle: Fill 2 nd Cycle: Softening 3 rd Cycle: UP Brine 4 th Cycle: Backwash 5 th Cycle: Rinse

Table 2: Regeneration Cycles Filtering

Downflow Regenerant Refill After Rinse
1 st Cycle: Backwash 2 nd Cycle: dn Brine 3 rd Cycle: Backwash 4 th Cycle: Rinse 5 th Cycle: Fill

The control valve with a water meter can be set for Demand Initiated Regeneration (DIR) only, Time Clock operation only or DIR and Time Clock which ever comes first, depending upon what settings are selected for Day Override and Gallon Capacity.¹ See Table 3.

If a control valve does not contain a meter, the valve can only act as a time clock, and day override should be set to any number and gallon capacity should be set to off.

**Table 3
DIR/Time Clock Options**

DIR	Time Clock	Reserve Capacity	Softener	Filter		Settings ²	
				Regenerant	Backwash Only	Days to REGEN	Gallon Capacity
Yes		Automatically calculated	Yes			Off	Auto
Yes		If desired enter a value less than estimated capacity	Yes	Yes	Yes	Off	Any Number
Yes	Yes	Automatically calculated	Yes			Any Number	Auto
Yes	Yes	If desired enter a value less than estimated capacity	Yes	Yes	Yes	Any Number	Any number
	Yes	None	Yes	Yes	Yes	Any Number	Off

For DIR Softeners, there are two options for setting the Gallons Capacity. The Gallons Capacity is automatically calculated if set to AUTO. Reserve Capacity is automatically estimated based on water usage if AUTO is used. The other option is to set the Gallons Capacity to a specific number. If a specific number is set, reserve capacity is zero, unless the value is manually set (i.e. the manufacturer intentionally sets the gallon capacity number below the calculated capacity of the system).

A unique feature of this control valve is the ability to display actual water usage for the last 63 days. The values are initially stored as "----". This means the value is unknown. As days pass values are stored as "0" for no flow or the actual number of gallons. The counting of the gallons starts at the regeneration time. If no regeneration time can be set (i.e. when the valve is set for immediate regeneration) the counting of gallons starts at 12 a.m. Day 1 is yesterday, day 2 the day before yesterday, etc. As new values are added the oldest history disappears.

Another unique feature is that the valve automatically calculates a reserve capacity when set up as a softener with "Gallons Capacity" set to "AUTO" and the "Regeneration Time Option" set to "DELAY REGEN" or "DELAY + IMMEDIATE". The actual reserve capacity is compared to the gallons capacity remaining immediately prior to the preset regeneration time. A regeneration will occur if the actual reserve capacity is less than the gallons capacity remaining. The actual reserve capacity is calculated by using the estimated reserve capacity and adjusting it up or down for actual usage.

The estimated reserve capacity for a given day of the week is the maximum value stored for the last three non-trivial water usages (i.e. more than 20 gallons/day) in seven day intervals.

¹ See Installer Display Settings, OEM Softener System Setup and OEM Filter System Setup for explanations of Day Override and Gallon Capacity.

² Days to REGEN and Gallon Capacity can not both be set to "OFF" at the same time.

Once the OEM Cycle Sequence has been set, the other procedures can be accessed in any order. Details on each of the procedures are provided on the following pages.

To “lock out” access to diagnostic and valve history displays and modifications to settings except hardness, day override, time of regeneration and time of day by anyone but the manufacturer, press ▼, NEXT, ▲, and CLOCK in sequence after settings are made. To “unlock”, so other displays can be viewed and changes can be made, press ▼, NEXT, ▲, and CLOCK in sequence.

When in operation normal user displays such as time of day, volume remaining before regeneration, present flow rate or days remaining before regeneration are shown. When stepping through a procedure, if no buttons are pressed within five minutes, the display returns to a normal user display. Any changes made prior to the five minute time out are incorporated.

To quickly exit OEM Softener Setup, OEM Filter Setup, Installer Display Settings, Diagnostics or Valve History press CLOCK. Any changes made prior to the exit are incorporated.

To clear the Service Call reminder, press ▲ and ▼ simultaneously while CALL is displayed.

When desired, all programming and information in Diagnostics may be reset to zero when the valve is installed in a new location. To reset to zero, press NEXT and ▼ buttons simultaneously to go to the Softening/Filtering screen. Press ▲ and ▼ simultaneously to reset programming and diagnostic values to zero. Screen will return to User Display.

Sometimes it is desirable to have the valve initiate and complete two regenerations within 24 hours and then return to the preset regeneration procedure. It is possible to do a double regeneration if the control valve is set to “DELAYED REGEN” or “DELAY + IMMEDIATE” in OEM Softener System Setup or OEM Filter System Setup. To do a double regeneration:

1. Press the “REGEN” button once. REGEN TODAY will flash on the display.
2. Press and hold the “REGEN” button for three seconds until the valve regeneration initiates.

Once the valve has completed the immediate regeneration, the valve will regenerate one more time at the preset regeneration time.

Proportional Brining

If the system is set up as a prefill 1” upflow softener the control valve can also be set to normal or proportional brining.

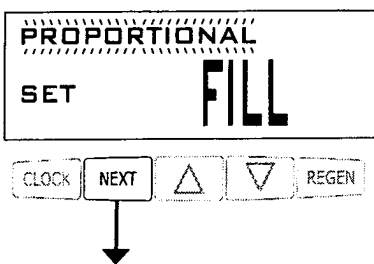

This step will appear after Step 8S and before Step 9S if the system is set up as a prefill upflow softener. The following options can be selected:

- NORMAL FILL - System always prefills with the salt level selected.
- PROPORTIONAL FILL - If proportional brining is selected, the actual salt fill time will be calculated by dividing the actual volume of treated water used by the full volumetric capacity, then multiplying this value by the maximum salt fill time.

Press NEXT to go to the next step. Press REGEN to return to the previous step.

OEM Configuration Setup

STEP 1CS

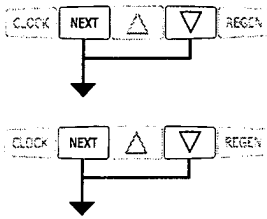

Step 1CS – Press NEXT and ▼ simultaneously for 3 seconds and release. Then press NEXT and ▼ simultaneously for 3 seconds and release. If screen in Step 2CS does not appear in 5 seconds the lock on the valve is activated. To unlock press ▼, NEXT, ▲, and CLOCK in sequence, then press NEXT and ▼ simultaneously for 3 seconds and release. Then press NEXT and ▼ simultaneously for 3 seconds and release.

STEP 2CS

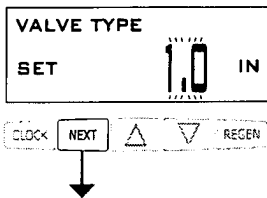

Step 2CS – Use the ▲ or ▼ to select 1.0 for 1” valve, 1.25 for 1.25” valve, 1.5 for 1.5” valve, 2.0L for 2L valve or 2.0 for 2” valve³. Press NEXT to go to Step 3CS. Press REGEN to exit OEM cycle sequence.

STEP 3CS

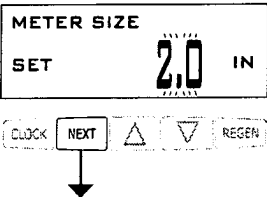

Step 3CS – When 2.0L or 2.0 is selected, an additional screen will appear. It is used to select which size flow meter is to be used with the valve, 1.5, 2.0 or 3.0. Variable meter pulses of 0.1-150.0 PPG can also be selected. Press NEXT to go to Step 4CS. Press REGEN to return to previous step.

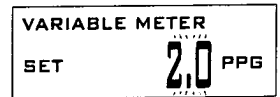

Note: When using the WS2 valve, if “2.0L” is set instead of “2.0”, when the valve is in regeneration and the piston drives to the “DRAW” cycle the piston will stall and generate a 102 error code. Clear the error code by pressing “NEXT” and “REGEN” buttons simultaneously until the valve resets, then re-program valve to proper valve type setting.

³When using the WS2 control valve, the circuit board software must have valve selection choices of 2.0 and 2.0L. The WS2 valve must be set for the 2.0 valve type during programming. If the software version does not have both the 2.0 and 2.0L selections, consult your equipment supplier for a replacement circuit board. When using the WS2L valve with older version software that does not have both 2.0 and 2.0L selection choices, the valve must be set to 2.0 during programming. If a WS2L valve is being used with newer version software that has both 2.0 and 2.0L selection choices, the valve must be set to 2.0L during programming.

STEP 4CS

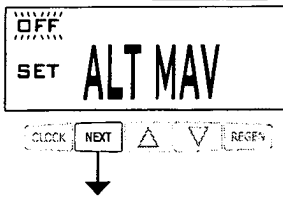

Step 4CS – Allows selection of one of the following using the ▲ or ▼ buttons:

- the Control Valve to act as an alternator; or
- the Control Valve to have a no hard water bypass; or
- the Control Valve to have a Separate Source during the regeneration cycle; or
- the Control Valve to operate with the Clack System Controller.

Select OFF when none of these features are used.

Only use Clack No Hard Water Bypass Valves or Clack Motorized Alternating Valves (MAV) with these selections. Clack No Hard Water Bypass Valves (1" or 1.25" V3070FF or V3070FM) are not designed to be used with the alternator function or separate source.

Selecting the Control Valve to act as an alternator:

Prior to starting the programming steps, connect the interconnect cable to each control valve board's three pin connector labeled "INTERCONNECT". Also connect the meter cord to either control valve to the three pin connector labeled "METER".			
		Softener valve programming steps	
OEM Configuration Setup	Step 4CS	Set to ALTA Connect ALTA valve to the MAV's A port and connect the MAV's two pin wire connector to the two pin connector labeled "MAV DRIVE" on the ALTA valve	Set to ALTB Connect ALTB valve to the MAV's B port. No connections between the ALTB valve and the MAV are made.
Softener System Setup	Step 9S	Set to "AUTO"	Set to "AUTO"
Softener System Setup	Step 10S	Set regeneration time option to "IMMEDIATE".	Set regeneration time option to "IMMEDIATE".
Installer Display Setting	Step 3I	Set Day Override to "OFF"	Set Day Override to "OFF"

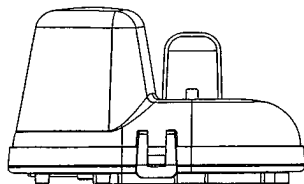

Retracted

Valve "A" in Service Position = MAV piston rod Retracted

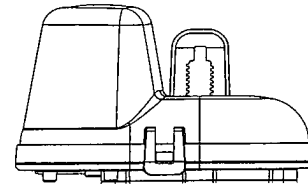

Extended

Valve "B" in Service Position = MAV piston rod Extended

Note: Clack Twin Alternator Operations

- Twin alternating systems can be programmed with a day override setting combined with the normal volume-based regeneration programming. A twin alternating system in this configuration will then regenerate based on the volume used or the day override if there is a period of low water usage.
- Twin alternating systems can be programmed as a time clock only based regenerating system. In this configuration, the days remaining are counted only on the unit that is in service. The unit in Stand-by Mode only notes days in diagnostics, which results in time clock only twin regeneration initiation.
- Twin alternating systems can be programmed for a delayed regeneration time. The system will allow an immediate transfer of the MAV to switch tanks and place a fully regenerated unit in service once a unit becomes exhausted. The exhausted unit will then be placed into Stand-by Mode and allowed to have a delayed regeneration at the pre-set time.

STEP 4CS

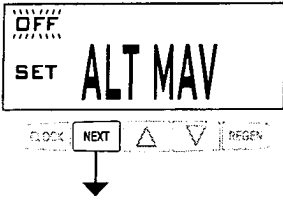

Step 4CS – Allows selection of one of the following using the ▲ or ▼ buttons:

- the Control Valve to act as an alternator; or
- the Control Valve to have a no hard water bypass; or
- the Control Valve to have a Separate Source during the regeneration cycle; or
- the Control Valve to operate with the Clack System Controller.

Select OFF when none of these features are used.

Only use Clack No Hard Water Bypass Valves or Clack Motorized Alternating Valves (MAV) with these selections. Clack No Hard Water Bypass Valves (1" or 1.25" V3070FF or V3070FM) are not designed to be used with the alternator function or separate source.

Selecting the Control Valve to act as an alternator:

Prior to starting the programming steps, connect the interconnect cable to each control valve board's three pin connector labeled "INTERCONNECT". Also connect the meter cord to either control valve to the three pin connector labeled "METER".

		Softener valve programming steps	
OEM Configuration Setup	Step 4CS	Set to ALTA Connect ALTA valve to the MAV's A port and connect the MAV's two pin wire connector to the two pin connector labeled "MAV DRIVE" on the ALTA valve	Set to ALTB Connect ALTB valve to the MAV's B port. No connections between the ALTB valve and the MAV are made.
Softener System Setup	Step 9S	Set to "AUTO"	Set to "AUTO"
Softener System Setup	Step 10S	Set regeneration time option to "IMMEDIATE".	Set regeneration time option to "IMMEDIATE".
Installer Display Setting	Step 3I	Set Day Override to "OFF"	Set Day Override to "OFF"

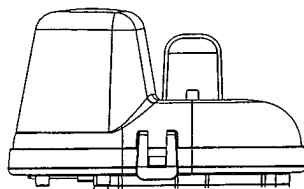

Retracted

Valve "A" in Service Position = MAV piston rod Retracted

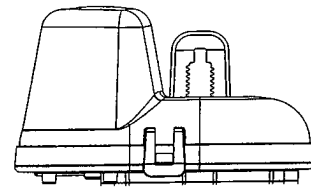

Extended

Valve "B" in Service Position = MAV piston rod Extended

Note: Clack Twin Alternator Operations

- Twin alternating systems can be programmed with a day override setting combined with the normal volume-based regeneration programming. A twin alternating system in this configuration will then regenerate based on the volume used or the day override if there is a period of low water usage.
- Twin alternating systems can be programmed as a time clock only based regenerating system. In this configuration, the days remaining are counted only on the unit that is in service. The unit in Stand-by Mode only notes days in diagnostics, which results in time clock only twin regeneration initiation.
- Twin alternating systems can be programmed for a delayed regeneration time. The system will allow an immediate transfer of the MAV to switch tanks and place a fully regenerated unit in service once a unit becomes exhausted. The exhausted unit will then be placed into Stand-by Mode and allowed to have a delayed regeneration at the pre-set time.

Step 4CS (continued) – If set up for a filter, in Step 7F set Volume Capacity in Gallons; in Step 8F select Regeneration Time Option “Immediate”; and in Step 3I select Day Override “oFF”.

For Clack Corporation alternator systems using **WS1, WS1.25, WS1.5, and WS2L** valves there will be an option to delay the last two cycles of regeneration (only “Rinse” and “Fill”). This feature splits the regeneration into two portions. The first portion of the regeneration will start immediately and all programmed cycles before the “Rinse” and “Fill” cycles will be performed. After all programmed cycles before “Rinse” and “Fill” are completed the control valve will drive to the service position (displaying “Delayed Rinse + Fill Pending”). When the volume of the on-line unit is depleted to 10% of its programmed capacity, the control valve will be triggered to finish the second portion of the regeneration. Once “Rinse” and “Fill” are completed, the valve will re-enter Standby mode until requested to come on-line for Service.

For Clack Corporation alternator systems using the **WS2** valve, when NEXT is pressed after selecting ALT A or ALT B, a display will allow the user to set the amount of pre-service rinse time for the stand by tank just prior to returning to service.

WS1, WS1.25, WS1.5, WS2L Valves

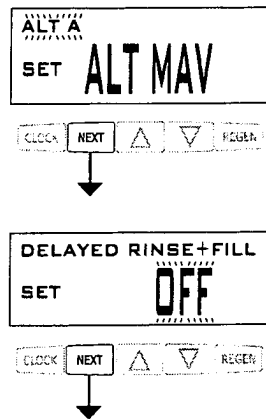

WS2 Valve

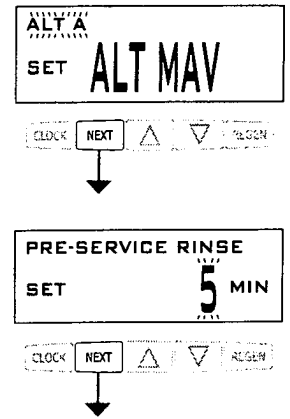

Configuring the Control Valve for No Hard Water Bypass Operation:

Select NO HARD BYPASS for control operation. For no hard water bypass operation the three wire connector is not used. Selection requires that a connection to MAV or a Clack No Hard Water Bypass Valve is made to the two pin connector labeled MAV DRIVE located on the printed circuit board. If using a MAV, the A port of the MAV must be plugged and the valve outlet connected to the B port. When set to No Hard Bypass the MAV will be driven closed before the first regeneration cycle that is not FILL or SOFTENING or FILTERING, and be driven open after the last regeneration cycle that is not FILL.

NOTE: If the control valve enters into an error state during regeneration mode, the no hard water bypass valve will remain in its current state until the error is corrected and reset.



Configuring the Control Valve for Separate Source Operation:

Select Separate Source for control operation. For separate source operation, the three wire connector is not used. Selection requires that a connection to a Clack Motorized Alternator Valve (MAV) is made to the two pin connector labeled MAV DRIVE located on the printed circuit board. The C port of the MAV must be connected to the valve inlet and the A port connected to the separate source used during regeneration. The B port must be connected to the feed water supply.

When set to Separate Source the MAV will be driven closed before the first regeneration cycle, and be driven open after the last regeneration cycle.

NOTE: If the control valve enters into an error state during regeneration mode, the MAV will remain in its current state until the error is corrected and reset.



Configuring the Control Valve to operate with Clack System Controller:

Select System Board Enabled to link the Control Valve to the Clack System Controller. For communication between the Control Valve and the System Controller a three wire communication cable is required.

Press NEXT to go to Step 5CS. Press REGEN to return to previous step.



STEP 5CS

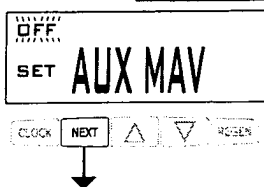

Step 5CS – Set Auxiliary Drive Output (MAV only) to operate in one of two modes:

- TIME – Output is activated at a set time after the start of regeneration, for a specified length of time.
- Set SEP SOURCE: Allows Auxiliary MAV to switch positions before the start of regeneration and then switch back at the end of regeneration.
- Set OFF: Deactivates this output.

Only use Clack Motorized Alternating Valves (MAV) with these selections. Clack No Hard Water Bypass Valves (1” or 1.25” V3070FF or V3070FM) are not designed to be used with the TIME or SEPARATE SOURCE functions.

Press NEXT to go to Step 6CS. Press REGEN to return to previous step.

STEP 6CS

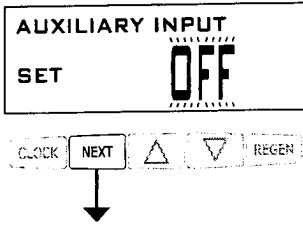

Step 6CS – This allows the use of an outside signal to control the initiation of a regeneration. Selection only matters if a connection is made to the two pin connector labeled DP SWITCH located on the printed circuit board. Following is an explanation of the options:

oFF – Feature not used.

NOTE: In a twin alternating system each control must have a separate dP signal or dP switch. One dP signal or one dP switch cannot be used for both controls.

IMMED REG – If the dP switch is closed for an accumulative time of 2 minutes a regeneration will be signaled to the unit. In a twin alternating system the MAV will transition first to switch units so that the signaled unit can start regeneration. After the MAV is fully transitioned the regeneration begins immediately. Note: For WS1 – WS2L control valves programmed for twin alternating: if the dP function “IMMED REG” is set, the Delayed Rinse and Fill feature is not available.

DELAY REG – If the dP switch is closed for an accumulative time of 2 minutes a regeneration will occur at the scheduled delayed regeneration time. In a twin alternating system once the dP switch is triggered the PC Board will display “REGEN TODAY” and when the delayed regen time comes the control will switch tanks and the triggered unit will then go into regeneration. Note: For WS1 – WS2L control valves programmed for twin alternating: if the dP function “DELAY REG” is set, the Delayed Rinse and Fill feature is not available.

HOLD REG – If the dP switch is closed a regeneration will be prevented from occurring while there is switch closure. In a twin alternating system the regeneration of a unit can be prevented upon switch closure. If the unit depletes the capacity down to zero it will not be allowed to switch tanks to regenerate until the switch is open. Note: For WS1 – WS2L control valves programmed for twin alternating the Delayed Rinse and Fill feature can be set in conjunction with the “HOLD REG” if desired.

Press NEXT to go to Step 7CS (if 1.5IN was selected in Step 2CS) or to exit Configuration Setup. Press REGEN to return to previous step.

STEP 7CS

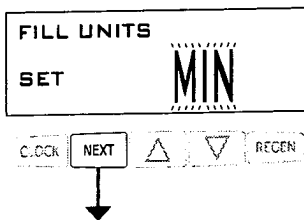

Step 7CS – If 1.5 IN was selected in Step 2CS, this screen will appear, and FILL can be set to LBS or MIN by using ▼ or ▲. Press NEXT to exit Configuration Setup. Press REGEN to return to previous step.

OEM Softener System Setup

Type	Fill	Service	Backwash	Draw	Backwash	Rinse	Fill
Softening DN Post			8	60	8	8	9.5 LBS
Softening DN Pre	9.5 LBS	240	8	60	8	8	
Softening UP Post				60	8	8	9.5 LBS
Softening UP Pre	9.5 LBS	240		60	8	8	
Softening DN Post 2.0" Valve			8	60	8	8	6 MIN
Softening DN Pre 2.0" Valve	6 MIN	240	8	60	8	8	

Cycle	Units	Range	Default
Backwash	MIN	1-120 or OFF	8
Rinse	MIN	1-120 or OFF	8
Draw (Up or Down)	MIN	1-160 or OFF	60
Fill (all but 2" valve)	LBS	0.1-200 or OFF	9.5
Fill (1.5" MIN or 2" valve)	MIN	0.1-99.0 or OFF	6
Softening	MIN	1-480 or OFF	240

STEP 1S

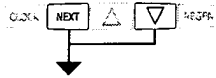

Step 1S – Press NEXT and ▼ simultaneously for 3 seconds and release. If screen in Step 2S does not appear in 5 seconds the lock on the valve is activated. To unlock press ▼, NEXT, ▲, and CLOCK in sequence, then press NEXT and ▼ simultaneously for 3 seconds and release.

STEP 2S

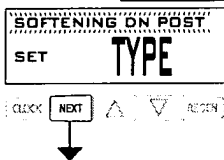

Step 2S – Choose the SOFTENING program desired (see table) using ▼ or ▲. Press NEXT to go to Step 3S. Press REGEN to exit OEM Softener System Setup.

STEP 3S

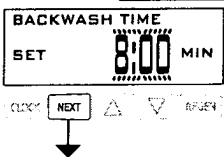

Step 3S – Select the time for the first cycle using the ▼ or ▲ button. Press NEXT to go to Step 4S. Press REGEN to return to previous step.

STEP 4S

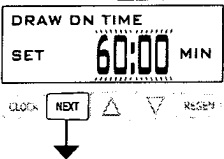

Step 4S – Select the time for the second cycle using the ▼ or ▲ button. Press NEXT to go to Step 5S. Press REGEN to return to previous step.

STEP 5S

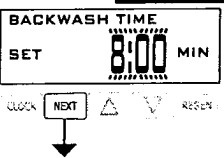

Step 5S – Select the time for the third cycle using the ▼ or ▲ button. Press NEXT to go to Step 6S. Press REGEN to return to previous step.

STEP 6S

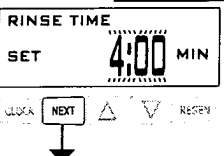

Step 6S – Select the time for the fourth cycle using the ▼ or ▲ button. Press NEXT to go to Step 7S. Press REGEN to return to previous step.

STEP 7S

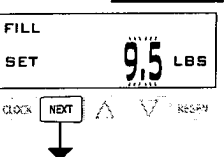

Step 7S – Select the LBS for the fifth cycle using the ▼ or ▲ button. When both 2.0L and 2.0 are options in Step 2CS, and 2.0 is selected, FILL is in minutes. If 1.5 is selected in Step 2CS, setting Step 7CS determines if the valve is in lbs. or minutes. Press NEXT to go to Step 8S. Press REGEN to return to previous step.

STEP 8S

GRAINS OF CAPACITY	
SET	24.0 X1K
CLOCK	NEXT
▲	▼
REGEN	

STEP 9S

GALLONS CAPACITY	
SET	AUTO
CLOCK	NEXT
▲	▼
REGEN	

STEP 10S

DELAY+IMMEDIATE	
SET	REGEN
CLOCK	NEXT
▲	▼
REGEN	

STEP 11S

REGEN TIME	
SET	RELAY 1
CLOCK	NEXT
▲	▼
REGEN	

STEP 12S

RELAY 1 SETPOINT	
SET	10 MIN
CLOCK	NEXT
▲	▼
REGEN	

STEP 13S

RELAY 1 DURATION	
SET	5:00 MIN
CLOCK	NEXT
▲	▼
REGEN	

Step 8S –Set Grains Capacity using the ▲ or ▼ button. The ion exchange capacity is in grains of hardness as calcium carbonate for the system based on the pounds of salt that will be used. Calculate the pounds of salt using the fill time previously selected. Grains capacity is affected by the fill time. The grains capacity for the selected fill time should be confirmed by OEM testing. The capacity and hardness levels entered are used to automatically calculate reserve capacity when volume capacity is set to AUTO. Press NEXT to go to Step 9S. Press REGEN to return to previous step.

Step 9S – Set Volume Capacity using the ▲ or ▼ button. If value is set to:

- “AUTO” capacity will be automatically calculated and reserve capacity will be automatically estimated;
 - “OFF” regeneration will be based solely on the day override set (see Installer Display Settings Step 3I); or
 - a number, regeneration initiation will be based off the value specified.
- If “OFF” or a number is used, hardness display will not be allowed to be set in Installer Display Settings Step 2I. If “OFF” is selected, Regeneration Time is automatically “Delayed”, so Step 10S will not appear. See Setting Options Table for more detail. Press NEXT to go to Step 10S. Press REGEN to return to previous step.

Step 10S – Set Regeneration Time Options using the ▼ or ▲ button. If value is set to:

- “DELAYED REGEN” means regeneration will occur at the preset time;
 - “IMMEDIATE” means regeneration will occur immediately when the volume capacity reaches 0 (zero); or
 - “DELAY + IMMEDIATE” means regeneration will occur at one of the following:
 - the preset time when the volume capacity falls below the reserve or the specified number of days between regenerations is reached whichever comes first; or
 - immediately after 10 minutes of no water usage when the volume capacity reaches 0 (zero).
- “DELAYED REGEN is the default if Step 4CS is set to ALTA or ALTB, and “DELAY + IMMEDIATE” will not be available. See Setting Options Table for more detail. Press NEXT to go to Step 11S. Press REGEN to return to previous step.

Step 11S: Set Relay 1 operation using the ▲ or ▼ button. The choices are:

- Set REGEN TIME: Relay activates after a set time at the beginning of a regeneration and then deactivates after a set period of time. The start of regeneration is defined as the first backwash cycle or Regenerant Draw UP (1” only) or DN, which ever comes first.
 - Set VOLUME: Relay activates after a set number of gallons have been used while in service and then deactivates after a set period of time or after the meter stops registering flow, whichever comes first.
 - Set REGEN VOLUME: Relay activates after a set number of gallons have been used while in service or during regeneration and then deactivates after a set period of time or after the meter stops registering flow, whichever comes first.
 - Set HOLD VOLUME: The relay closes every set number of gallons and release when any button is pressed.
 - Set OFF: If set to Off, Steps 12S and 13S will not be shown.
- Press NEXT to go to Step 12S. Press REGEN to return to previous step.

Step 12S: Set Relay 1 SETPOINT Time or Volume using the ▲ or ▼ buttons. The choices are:

- Relay Actuation Time: After the start of a regeneration the amount of time that should pass prior to activating the relay. The start of regeneration is defined as the first backwash cycle or Regenerant Draw UP (1” only) or DN, which ever comes first. Ranges from 0 to 500 minutes.
 - Relay Actuation Volume or Regen Volume: Relay activates after a set number of gallons have passed. Ranges from 1 to 20,000 gallons.
 - Relay Actuation Hold Volume: The relay and related display activate after the set number of gallons have passed. The relay output and related display are reset when any button is pressed.
- Press NEXT to go to Step 13S. Press REGEN to return to previous step.

Step 13S: Set Relay DURATION TIME using the ▲ or ▼ buttons.

- If TIME is selected in Step 11S, the relay will deactivate after the time set has expired. Ranges from 0:01 to 500:00 minutes.
 - If VOLUME or REGEN VOLUME is selected in Step 11S, the relay will deactivate after the time set has expired.
- Press NEXT to go to Step 14S. Press REGEN to return to previous step.

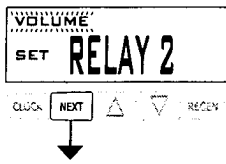
STEP 14S

Step 14S: Set Relay 2 operation using ▲ or ▼. The choices are the same as Step 11S, with the addition of ERROR MONITOR. If set to ERROR MONITOR, the relay closes whenever the valve enters error mode, and immediately deactivates when error mode is exited. If set to OFF, Steps 15S and 16S will not be shown. Press NEXT to go to Step 15S. Press REGEN to return to previous step.

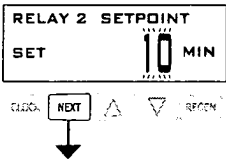
STEP 15S

Step 15S: Set Relay 2 SETPOINT Time or Volume using the ▲ or ▼ buttons. The choices are the same as Step 12S. Press NEXT to go to Step 16S. Press REGEN to return to previous step.

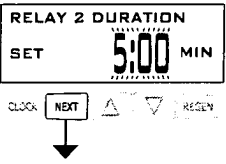
STEP 16S

Step 16S: Set Relay DURATION TIME using the ▲ or ▼ buttons.

- If TIME is selected in Step 14S the relay will deactivate after the time set has expired.
- If VOLUME or REGEN VOLUME is selected in Step 14S the relay will deactivate after the time set has expired or after the meter stops registering flow, whichever comes first.

Press NEXT to go to Step 17. Press REGEN to return to previous step.

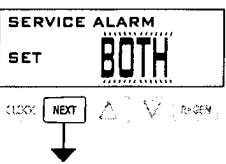
STEP 17S

Step 17S: Set scheduled service alarm using the ▲ or ▼. Available options are OFF, TIME, ON GAL or BOTH. Selecting OFF disables this feature. If OFF is selected press NEXT to exit OEM Softener System Setup. If TIME, ON GAL or BOTH is selected press NEXT to select the TIME and/or ON GAL values. See Steps 17S and/or 18S. Press REGEN to return to the previous step.

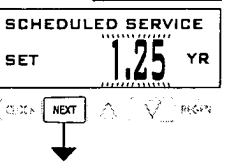
STEP 18S

Step 18S: Time remaining until Service Alarm generation. Only appears if TIME or BOTH is set in Step 16S. To change duration time, use ▲ or ▼ to select the new value. Press NEXT to exit OEM Softener System Setup or go to Step 19S if BOTH was selected in Step 17S. Press REGEN to return to the previous step.

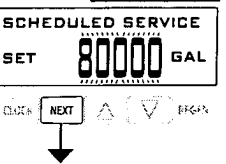
STEP 19S

Step 19S: Volume remaining until Service Alarm generation. Only appears if GAL or BOTH is set in Step 17S. To change the volume between service calls, use ▲ or ▼ to select the new value. Press NEXT to go to Step 20S. Press REGEN to return to the previous step.

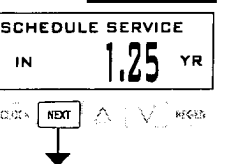
STEP 20S

Step 20S: Status display only, if Step 17S is set to TIME or BOTH. Shows time remaining to Service Alarm. Can be reset to the initial value by pressing ▲ and ▼ for approximately 3 seconds. Press NEXT to exit OEM Softener System Setup or to go to Step 21S. Press REGEN to return to previous step.

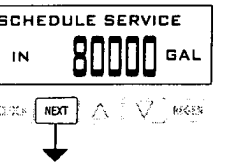
STEP 21S

Step 21S: Status display only, if Step 17S is set to TIME or BOTH. Shows time remaining to Service Alarm. Can be reset to the initial value by pressing ▲ and ▼ for approximately 3 seconds. Press NEXT to exit OEM Softener System Setup. Press REGEN to return to previous step.

RETURN TO NORMAL MODE

Setting Options Table
Filters should only use shaded options.

Volume Capacity	Regeneration Time Option	Day Override	Result ⁴
AUTO	DELAYED REGEN	OFF	Reserve capacity automatically estimated. Regeneration occurs when volume capacity falls below the reserve capacity at the next Regen Set Time
AUTO	DELAYED REGEN	Any number	Reserve capacity automatically estimated. Regeneration occurs at the next Regen Set Time when volume capacity falls below the reserve capacity or the specified number of days between regenerations is reached.
Any number	DELAYED REGEN	OFF	Reserve capacity <u>not</u> automatically estimated. Regeneration occurs at the next Regen Set Time when volume capacity reaches 0.
OFF	DELAYED REGEN	Any number	Reserve capacity <u>not</u> automatically estimated. Regeneration occurs at the next Regen Set Time when the specified number of days between regenerations is reached.
Any number	DELAYED REGEN	Any number	Reserve capacity <u>not</u> automatically estimated. Regeneration occurs at the next Regen Set Time when volume capacity reaches 0 or the specified number of days between regenerations is reached.
AUTO	IMMEDIATE	OFF	Reserve capacity <u>not</u> automatically estimated. Regeneration occurs immediately when volume capacity reaches 0. Time of regeneration will not be allowed to be set because regeneration will always occur when volume capacity reaches 0.
Any number	IMMEDIATE	OFF	Reserve capacity <u>not</u> automatically estimated. Regeneration occurs immediately when volume capacity reaches 0. Time of regeneration will not be allowed to be set because regeneration will always occur when volume capacity reaches 0.
AUTO	DELAY + IMMEDIATE	OFF	Reserve capacity automatically estimated. Regeneration occurs when volume capacity falls below the reserve capacity at the next Regen Set Time or regeneration occurs after 10 minutes of no water usage when volume capacity reaches 0.
AUTO	DELAY + IMMEDIATE	Any number	Reserve capacity automatically estimated. Regeneration occurs at the next Regen Set Time when volume capacity falls below the reserve capacity or the specified number of days between regenerations is reached or regeneration occurs after 10 minutes of no water usage when volume capacity reaches 0.
Any number	DELAY + IMMEDIATE	Any number	Reserve capacity <u>not</u> automatically estimated. Regeneration occurs at the next Regen Set Time when the specified number of days between regenerations is reached or regeneration occurs after 10 minutes of no water usage when volume capacity reaches 0.

⁴ Reserve capacity estimate is based on history of water usage

OEM Filter System Setup

Type	Backwash	Draw	Backwash	Rinse	Fill
Filtering DN Post	8	60	8	8	0.95 GAL
Filtering DN Post (1.5" MIN or 2" valve)	8	60	8	8	6 MIN

Cycle	Units	Range	Default
Backwash	MIN	1-120 or OFF	8
Rinse	MIN	1-120 or OFF	8
Draw (Up or Down)	MIN	1-160 or OFF	60
Fill (all but 2" valve)	GAL	0.05-20.00 or OFF	0.95
Fill (2" valve)	MIN	0.1-99.0 or OFF	6

STEP 1F



Step 1F – Press NEXT and ▼ simultaneously for 3 seconds and release. If screen in Step 2F does not appear in 5 seconds the lock on the valve is activated. To unlock press ▼, NEXT, ▲, and CLOCK in sequence, then press NEXT and ▼ simultaneously for 3 seconds and release.

STEP 2F

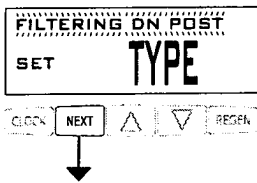

Step 2F – Choose FILTERING DN POST using the ▼ or ▲ buttons. Press NEXT to go to Step 3F. Press REGEN to exit OEM Filter System Setup.

STEP 3F

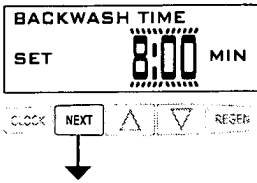

Step 3F – Select the time for the first cycle using the ▼ or ▲ button. Press NEXT to go to Step 4F. Press REGEN to return to previous step.

STEP 4F

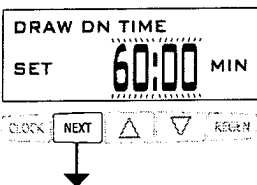

Step 4F – Select the time for the second cycle using the ▼ or ▲ button. Press NEXT to go to Step 5F. Press REGEN to return to previous step.

STEP 5F

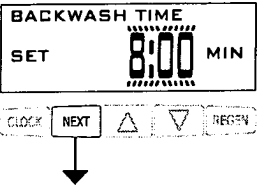

Step 5F – Select the time for the third cycle using the ▼ or ▲ button. Press NEXT to go to Step 6F. Press REGEN to return to previous step.

STEP 6F

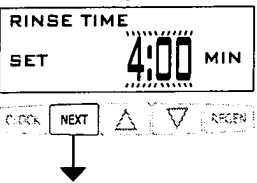

Step 6F – Select the time for the fourth cycle using the ▼ or ▲ button. Press NEXT to go to Step 7F. Press REGEN to return to previous step.

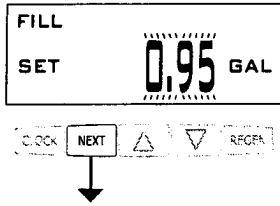
STEP 7F

Step 7F – Select the gallons for the fifth cycle using the ▼ or ▲ button. When both 2.0L and 2.0 are options in Step 2CS, and 2.0 is selected, FILL is in minutes. Press NEXT to go to Step 8F. Press REGEN to return to previous step.

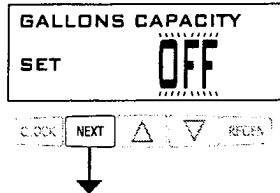
STEP 8F

Step 8F – Set Volume Capacity using the ▲ or ▼ button. If value is set to:

- “OFF” regeneration will be based solely on the day override set (see Installer Display/Settings Step 3I); or
- a number, regeneration initiation will be based off the value specified.

See Setting Options Table for more detail. Press NEXT to go to Step 9F. Press REGEN to return to previous step.

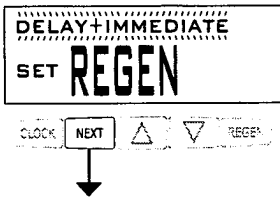
STEP 9F

Step 9F – Set Regeneration Time Options using the ▲ or ▼ button. If “OFF” was selected in Step 7F, this screen will not appear.

If value is set to:

- “DELAYED REGEN” means regeneration will occur at the preset time;
- “IMMEDIATE” means regeneration will occur immediately when the volume capacity reaches 0 (zero); or
- “DELAY + IMMEDIATE” means regeneration will occur at one of the following:
 - the preset time when the volume capacity falls below the reserve or the specified number of days between regenerations is reached whichever comes first; or
 - immediately after 10 minutes of no water usage when the volume capacity reaches 0 (zero).

“DELAYED REGEN is the default if Step 4CS is set to ALTA or ALTB, and “DELAY + IMMEDIATE” will not be available.

See Setting Options Table for more detail. Press NEXT to go to the remaining Filter System Setup screens. Refer to Softener System Setup starting at Step 11S for details. Press REGEN to return to previous step.

Installer Display Settings

STEP 1I

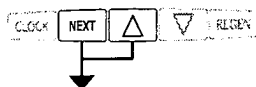

STEP 1I - Press NEXT and ▲ simultaneously for 3 seconds.

STEP 2I

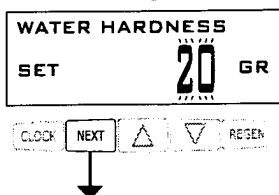

STEP 2I – Hardness: Set the amount of hardness in grains of hardness as calcium carbonate per gallon using the ▼ or ▲ buttons. The default is 20 with value ranges from 1 to 150 in 1 grain increments. Note: The grains per gallon can be increased if soluble iron needs to be reduced. This display will not show if “FILTERING” is selected in Step 2F or if ‘AUTO’ is not selected in Set Volume Capacity in OEM Softener System Setup. Press NEXT to go to step 3I. Press REGEN to exit Installer Display Settings.

STEP 3I

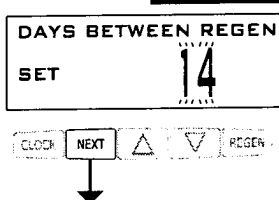

STEP 3I – Day Override: When volume capacity is set to “OFF”, sets the number of days between regenerations. When volume capacity is set to AUTO or to a number, sets the maximum number of days between regenerations. If value set to “OFF”, regeneration initiation is based solely on volume used. If value is set as a number (allowable range from 1 to 28) a regeneration initiation will be called for on that day even if sufficient volume of water were not used to call for a regeneration. Set Day Override using ▼ or ▲ buttons:

- number of days between regeneration (1 to 28); or
- “OFF”.

See Setting Options Table for more detail on setup. Press NEXT to go to step 4I. Press REGEN to return to previous step.

STEP 4I

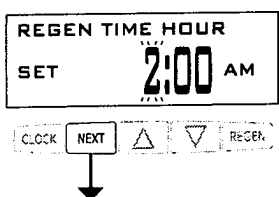

STEP 4I – Next Regeneration Time (hour): Set the hour of day for regeneration using ▼ or ▲ buttons. AM/PM toggles after 12. The default time is 2:00 AM. This display will show “REGEN IMMEDIATE ON ZERO GAL” if “IMMEDIATE” is selected in Set Regeneration Time Option in OEM Softener System Setup Step 10S. Press NEXT to go to step 5I. Press REGEN to return to previous step.

STEP 5I

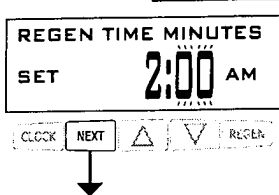

STEP 5I – Next Regeneration Time (minutes): Set the minutes of day for regeneration using ▼ or ▲ buttons. This display will not be shown if “IMMEDIATE” is selected in Set Regeneration Time Option in OEM Softener System Setup Step 10S. Press NEXT to go to Step 6I. Press REGEN to return to previous step.

STEP 6I

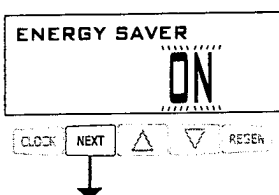

STEP 6I – As an energy-saving feature, the control will automatically turn off the display illumination after 5 minutes of keypad inactivity. Any further keypad activity or water use will re-illuminate the display for 5 minutes. The Energy Saver feature default is ON. Press NEXT to exit Installer Display Settings. Press REGEN to return to previous step.

RETURN TO NORMAL MODE

User Display Settings

General Operation

When the system is operating, one of six displays may be shown. The displays normally rotate, however pressing NEXT will pause on the selected display for 5 minutes. Pressing NEXT will alternate between the displays. One of the displays is always the current time of day. The second display is one of the following: days remaining or volume remaining. Days to a Regen is the number of days left before the system goes through a regeneration cycle. Capacity remaining is the gallons that will be treated before the system goes through a regeneration cycle. Pressing the ▼ button while in the Capacity Remaining display will decrease the capacity remaining in 10 gallon increments and will also increase the volume used impacting the recorded values in Diagnostics Steps 3D, 4D and 5D and Valve History, Step 4VH.

The third display shows the current treated water flow rate through the system. The fourth display will display the phone number and banner text if it was edited. For concerns with phone number or banner text displays, contact OEM for instructions. The fifth display will show either dP or hold if the dP switch is closed. The sixth display indicates the user should call for service. The sixth display will not appear if OFF is selected in Step 17S of OEM Softener System Setup. To clear the Service Call reminder, press the ▲ and ▼ buttons simultaneously while the number and banner text screen is displayed.

If the system has called for a regeneration that will occur at the preset time of regeneration, the words REGEN TODAY will alternate with the header on the display.

If a water meter is installed, GPM flashes on the display when water is being treated (i.e. water is flowing through the system).

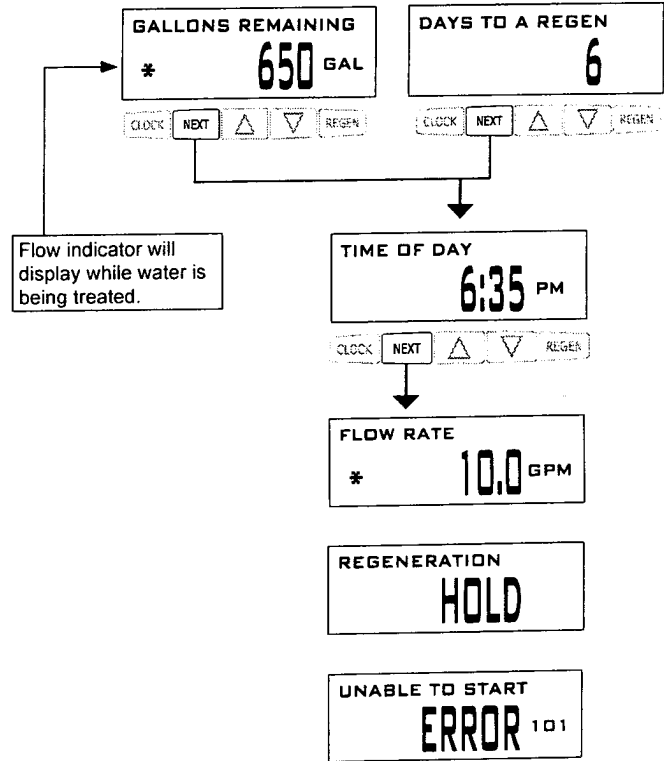

REGEN PENDING will be displayed in Alternator Systems whenever a unit is waiting to initiate the first cycle step of regeneration.

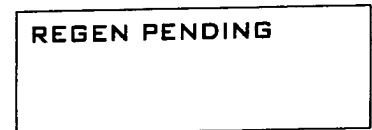

STAND BY will be displayed in Alternator Systems when a valve is in Standby state.

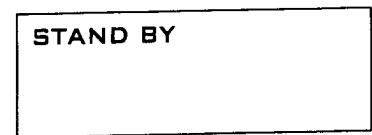

DELAYED RINSE+FILL PENDING will be displayed whenever a zero-capacity tank has transferred to an off-line state and is currently waiting to initiate the second portion of a regeneration cycle. Viewed only when Delayed Rinse and Fill is set to ON.



Regeneration Mode

Typically a system is set to regenerate at a time of low water usage. An example of a time with low water usage is when a household is asleep. If there is a demand for water when the system is regenerating, untreated water will be used.

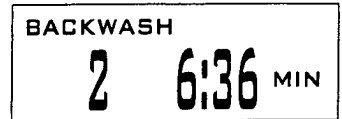

When the system begins to regenerate, the display will change to include information about the step of the regeneration process and the time remaining for that step to be completed. The system runs through the steps automatically and will reset itself to provide treated water when the regeneration has been completed.

Manual Regeneration

Sometimes there is a need to regenerate the system sooner than when the system calls for it, usually referred to as manual regeneration. There may be a period of heavy water usage because of guests or a heavy laundry day.

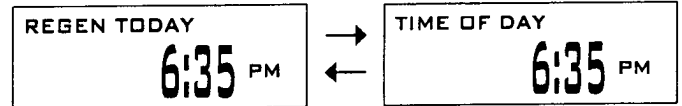

To initiate a manual regeneration at the preset delayed regeneration time, when the regeneration time option is set to “DELAYED REGEN” or “DELAY + IMMEDIATE”, press and release “REGEN”. The words “REGEN TODAY” will periodically be shown on the display to indicate that the system will regenerate at the preset delayed regeneration time. If you pressed the “REGEN” button in error, pressing the button again will cancel the request. Note: If the regeneration time option is set to “IMMEDIATE” there is no set delayed regeneration time so “REGEN TODAY” will not activate if “REGEN” button is pressed.

To initiate a manual regeneration immediately, press and hold the “REGEN” button for three seconds. The system will begin to regenerate immediately. The request cannot be cancelled.

Note: For softeners, if brine tank does not contain salt, fill with salt and wait at least two hours before regenerating.

Set Time of Day

The user can also set the time of day. Time of day should only need to be set if the battery has been depleted because of extended power outages or when daylight saving time begins or ends. If an extended power outage occurs, the time of day will flash on and off which indicates the time of day should be reset. The non rechargeable battery should also be replaced.

STEP 1U

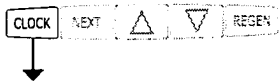

STEP 1U – Press CLOCK.

STEP 2U



STEP 2U - Current Time (hour): Set the hour of the day using ▼ or ▲ buttons. AM/PM toggles after 12. Press NEXT to go to Step 3U.

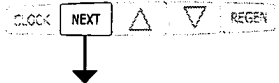

STEP 3U



STEP 3U - Current Time (minutes): Set the minutes of the day using ▼ or ▲ buttons. Press NEXT to exit Set Time of Day. Press REGEN to return to previous step.



RETURN TO NORMAL MODE

Power Loss

If the power goes out the system will keep time until the battery is depleted. If an extended power outage occurs, the time of day will flash on and off which indicates the time of day should be reset and the non rechargeable battery replaced. The system will remember the rest.

Error Message

If the word "ERROR" and a number are displayed contact the OEM for help. This indicates that the valve was not able to function properly. If the number and banner text in the Contact Screens has been edited, the two displays below will alternate.

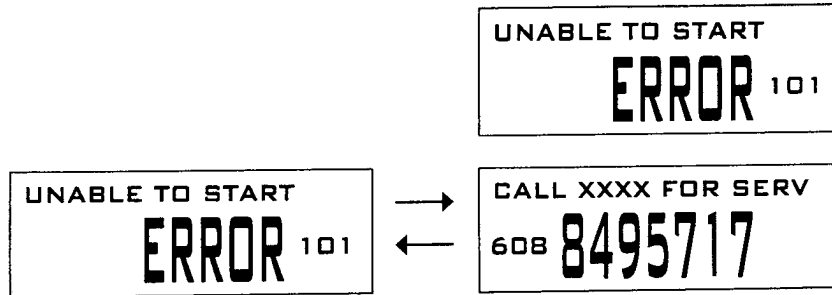

Whenever a MAV drive error occurs, press ▲ and ▼ for about 3 seconds until the Diagnostics MAV Drive History screen appears. Press ▲ or ▼ until the two screens of the MAV (ALT or AUX) with the drive error appear. After first reviewing the information contained in these screens, they must be cleared in order to restore proper MAV operation. Press ▲ and ▼ for about 3 seconds from either screen until this history is cleared. Pressing NEXT will return to the Error screen in the User Display, which is reset by pressing and holding NEXT and REGEN.

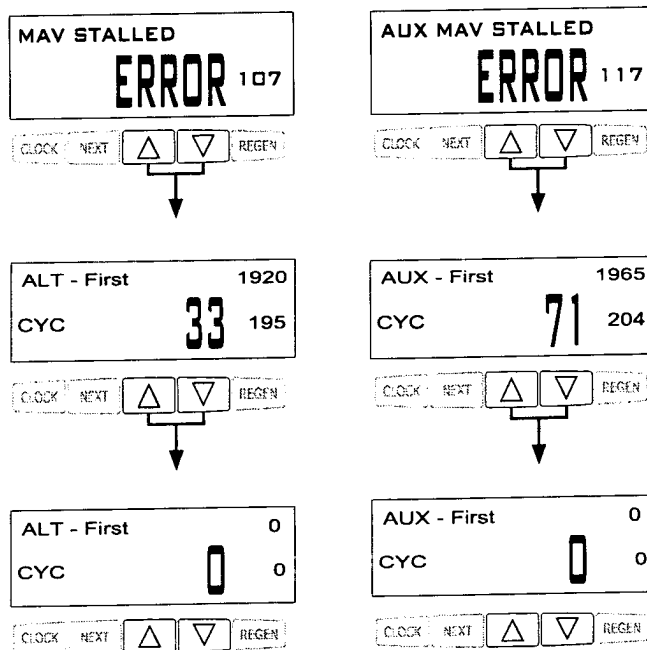

Diagnostics

STEP 1D

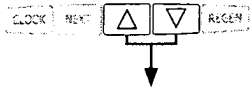

STEP 1D – Press ▲ and ▼ simultaneously for three seconds. If screen in step 2D does not appear in 5 seconds the lock on the valve is activated. To unlock press ▼, NEXT, ▲, and CLOCK in sequence, then press ▲ and ▼ simultaneously for 3 seconds.

STEP 2D

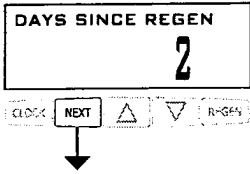

STEP 2D – Days, since last regeneration: This display shows the days since the last regeneration occurred. Press the NEXT button to go to Step 3D. Press REGEN to exit Diagnostics.

STEP 3D

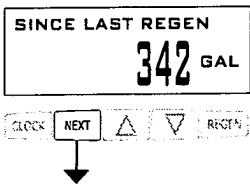

STEP 3D – Volume, since last regeneration: This display shows the volume of water that has been treated since the last regeneration. This display will equal zero if a water meter is not installed. Press the NEXT button to go to Step 4D. Press REGEN to return to previous step.

STEP 4D

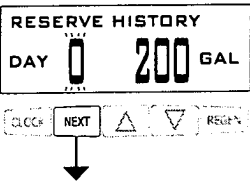

STEP 4D – Reserve History Volume used for last 7 days: If the valve is set up as a softener, a meter is installed and Set Volume Capacity is set to “Auto,” this display shows 0 day (for today) and the reserve capacity. Pressing the ▲ button will show day 1 (which would be yesterday) and the reserve capacity used. Pressing the ▲ button again will show day 2 (the day before yesterday) and the reserve capacity. Keep pressing the ▲ button to show the capacity for days 3, 4, 5 and 6. The ▼ button can be pressed to move backwards in the day series. This screen is not displayed if filter, time clock, meter immediate, alternator or volume override regeneration is selected. Press the NEXT button at any time to go to Step 5D. Press REGEN to return to previous step.

STEP 5D

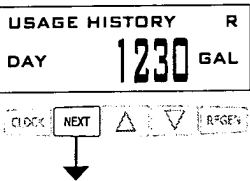

STEP 5D - Volume, 63-day usage history: This display shows day 0 (for today), day 1 (for yesterday), etc., and the volume of water treated that day. Press the ▲ button to show the volume of water treated for the last 63 days. If a regeneration occurred on the day the letter “R” will also be displayed. This display will show dashes if a water meter is not installed. Press the NEXT button at any time to go to Step 6D. Press REGEN to return to previous step.

STEP 6D

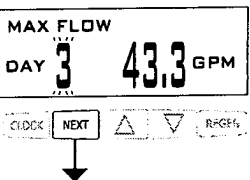

STEP 6D – Flow rate, maximum last seven days: Use the ▲ or ▼ to display the maximum flow rate in gallons per minute that occurred in each of the last seven days. This display will equal zero if a water meter is not installed. Press the NEXT button to go to Step 7D. Press REGEN to return to previous step.

STEP 7D

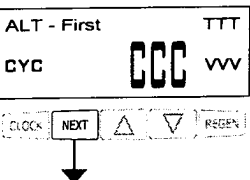

STEP 7D – MAV Drive History: Displays the drive time histories of all active MAV drives. Use ▲ or ▼ to review the history of all active MAV outputs. TTT – measured MAV drive time; VVV – measured MAV drive voltage; CCC – total number of drives (in or out); “+” indicates piston drive out of MAV; “-” indicates piston drive in to MAV. NOTE: After a drive error occurs or a MAV is replaced, it is recommended that the diagnostics screen for that MAV be cleared. That is done by selecting the + or – screen for that MAV. Press and hold ▲ and ▼ for about 3 seconds. Failure to do this may result in inconsistent MAV operation. Press NEXT to exit Diagnostics. Press REGEN to return to previous step.

RETURN TO NORMAL MODE

When desired, all programming and information in Diagnostics may be reset to zero when the valve is installed in a new location. To reset to zero, press NEXT and ▼ buttons simultaneously to go to the Softening/Filtering screen. Press ▲ and ▼ simultaneously to reset programming and diagnostic values to zero. Screen will return to User Display.

Valve History

STEP 1VH

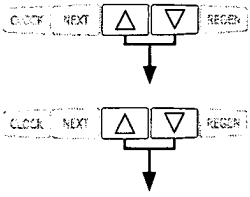

STEP 1VH – Press ▲ and ▼ simultaneously for three seconds and release. Then press ▲ and ▼ simultaneously and release. If screen in step 2VH does not appear in 5 seconds the lock on the valve is activated. To unlock press ▼, NEXT, ▲, and CLOCK in sequence, then press ▲ and ▼ simultaneously for 3 seconds and release. Then press ▲ and ▼ simultaneously and release.

STEP 2VH

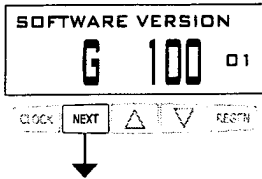

STEP 2VH – Software version. Displays the current software version. Press NEXT to go to Step 3VH. Press REGEN to exit Valve History.

STEP 3VH

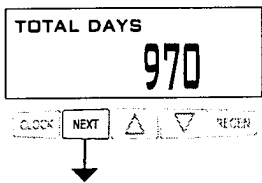

STEP 3VH⁵ – Days, total since start-up: This display shows the total days since startup. Press the NEXT button to go to Step 4VH. Press REGEN to return to previous step.

STEP 4VH

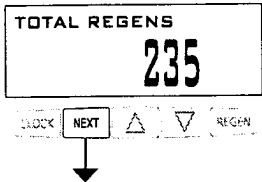

STEP 4VH – Regenerations, total number since start-up: This display shows the total number of regenerations that have occurred since startup. Press the NEXT button to go to Step 5VH. Press REGEN to return to previous step.

STEP 5VH

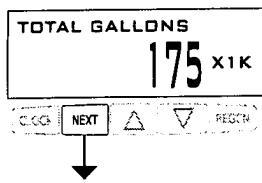

STEP 5VH – Volume, total used since start-up: This display shows the total gallons treated since startup. This display will equal zero if a water meter is not installed. Press the NEXT button to go to Step 6VH. Press REGEN to return to previous step.

STEP 6VH

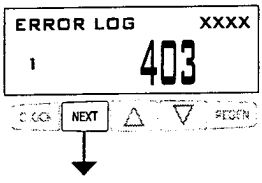

STEP 6VH – Error Log. This display shows a history of the last 10 errors generated by the control. With 102/106/116 errors, the drive position at the time of stall detection is also recorded. Press NEXT to exit Valve History. Press REGEN to return to previous step.

RETURN TO NORMAL MODE

⁵ Values in steps 2VH through 5VH cannot be reset.

NOTES:

NOTES:

NOTES:

CLACK CORPORATION
FIVE-YEAR SOFTENER AND FILTER CONTROLS
LIMITED WARRANTY

Clack Corporation ("Clack") warrants to OEM that its Softener and Filter Control Valves will be free from defects in material and workmanship under normal use and service for a period of five years from the date of shipment of such Valves from Clack's plant in Windsor, Wisconsin when installed and operated within recommended parameters. No warranty is made with respect to defects not reported to Clack within the warranty period and/or defects or damages due to neglect, misuse, alterations, accident, misapplication, physical damage, or damage caused by fire, acts of God, freezing or hot water or similar causes. For outdoor installations where the Softener and Filter Control Valves are not under cover, the weather cover must be utilized for the warranty to be valid.

Clack's obligation to OEM under this Limited Warranty shall be limited, at its option, to replacement or repair of any Softener and Filter Control valve covered by this Limited Warranty. Prior to returning a Control Valve, OEM must obtain a return goods authorization number from Clack and return the Control Valve freight prepaid. If any Control Valve is covered under this Limited Warranty, Clack shall return the Control Valve repaired, or its replacement, prepaid to the original point of shipment.

CLACK GIVES THIS WARRANTY TO OEM IN LIEU OF ALL OTHER WARRANTIES, EXPRESS OR IMPLIED, INCLUDING WITHOUT LIMITATION ANY IMPLIED WARRANTIES OF MERCHANTABILITY OR FITNESS FOR A PARTICULAR PURPOSE AND HEREBY EXPRESSLY DISCLAIMS ALL OTHER SUCH WARRANTIES. CLACK'S LIABILITY HERE UNDER SHALL NOT EXCEED THE COST OF THE PRODUCT. UNDER NO CIRCUMSTANCES WILL CLACK BE LIABLE FOR ANY INCIDENTAL OR CONSEQUENTIAL DAMAGES OR FOR ANY OTHER LOSS, DAMAGE OR EXPENSE OF ANY KIND, INCLUDING LOSS OF PROFITS, ARISING IN CONNECTION WITH THE INSTALLATION OR USE OR INABILITY TO USE THE CONTROL VALVES OR ANY WATER TREATMENT SYSTEM THE CONTROL VALVE IS INCORPORATED INTO.



CHARGER

Water Treatment Products

Illinois, Nevada, Texas, Florida & Pennsylvania
1180 Dundee Ave. • Elgin, IL 60120