

Water Specialist CH Control Valve Programming and Cover Drawing Manual

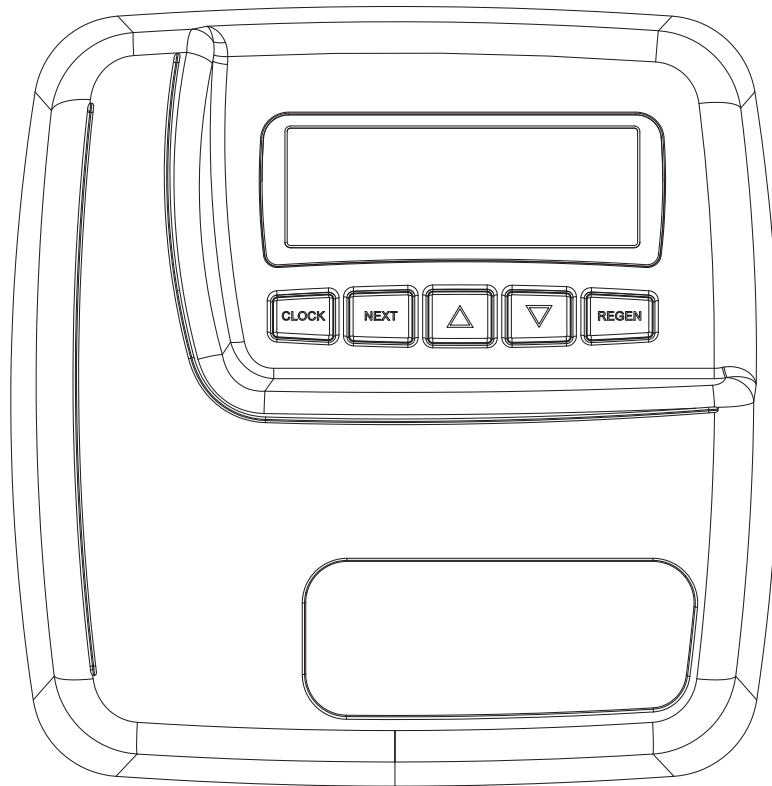

Table of Contents

CH Front Cover and Drive Assembly	4
OEM General Instructions	5
OEM Cycle Sequence	6
OEM Softener System Setup	10
Setting Options Table.....	13
OEM Filter System Setup	14
Installer Display Settings	16
User Display Settings	17
Diagnostics	20
Valve History	22

CH Front Cover and Drive Assembly

Drawing No.	Order No.	Description	Quantity
1	V3545-01	WS1CH FRONT COVER ASSEMBLY	1
2	V3107-01	WS1 MOTOR	1
3	V3106-01	WS1 DRIVE BRACKET & SPRING CLIP	1
4	V3558CH-01BOARD	WS1THRU2L/2 CH PC BRD SERCOM REPLACE	1
5	V3110	WS1 DRIVE REDUCING GEAR 12X36	3
6	V3109	WS1 DRIVE GEAR COVER	1
Not Shown	V3186	WS1 AC ADAPTER 110V-12V	1
	V3186EU	WS1 AC ADAPTER 220-240V-12V EU	
	V3186UK	WS1 AC ADAPTER 220-240V-12V UK	
	V3186-01	WS1 AC ADAPTER CORD ONLY	
Not Shown	V3178	WS1 DRIVE BACKPLATE	1

Refer to Control Valve Service Manual for other drawings and part numbers.

For software revs C100.8 and lower

Relay Specifications: To insure proper fit and correct operation use either of the Idec relay/relay socket combinations or the exact equivalents.

	Manufacturer	Option 1	Option 2
Relay Socket	Idec	SR3P-05C	SY4S-05C
Relay	Idec	RR2KP-UAC12V / RR2KP-UCAC12V	RY2KS-UAC12V

The relay supplies 2 sets of dry contacts for user applications.
The wiring of these contacts is application specific.

Wiring For Correct On/Off Operation

PC Board Relay Terminal Block	Relay Socket Model	
	SR3P-05C	SY4S-05C
SET	#2	#13
COM	#6 and #10	#12 and #14
RES	#3	#9

For software revs C102.8 and higher

Relay Specifications: 12V DC Relay with a coil resistance not less than 80 ohms. If mounting the relay under the cover check for proper mounting location dimensions on the backplate.

Wiring For Correct On/Off Operation

PC Board Relay Terminal Block	Relay
RLY 1	Coil -
COM	Coil +

AC Adapter	U.S.	International
Supply Voltage	120 V AC	230V AC
Supply Frequency	60 Hz	50 Hz
Output Voltage	12 V AC	12 V AC
Output Current	500 mA	500 mA

When replacing the battery, align positives and push down to fully seat.

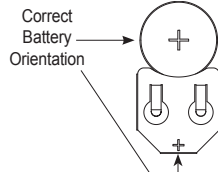
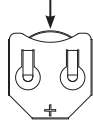

Battery replacement is 3 volt lithium coin cell type 2032.

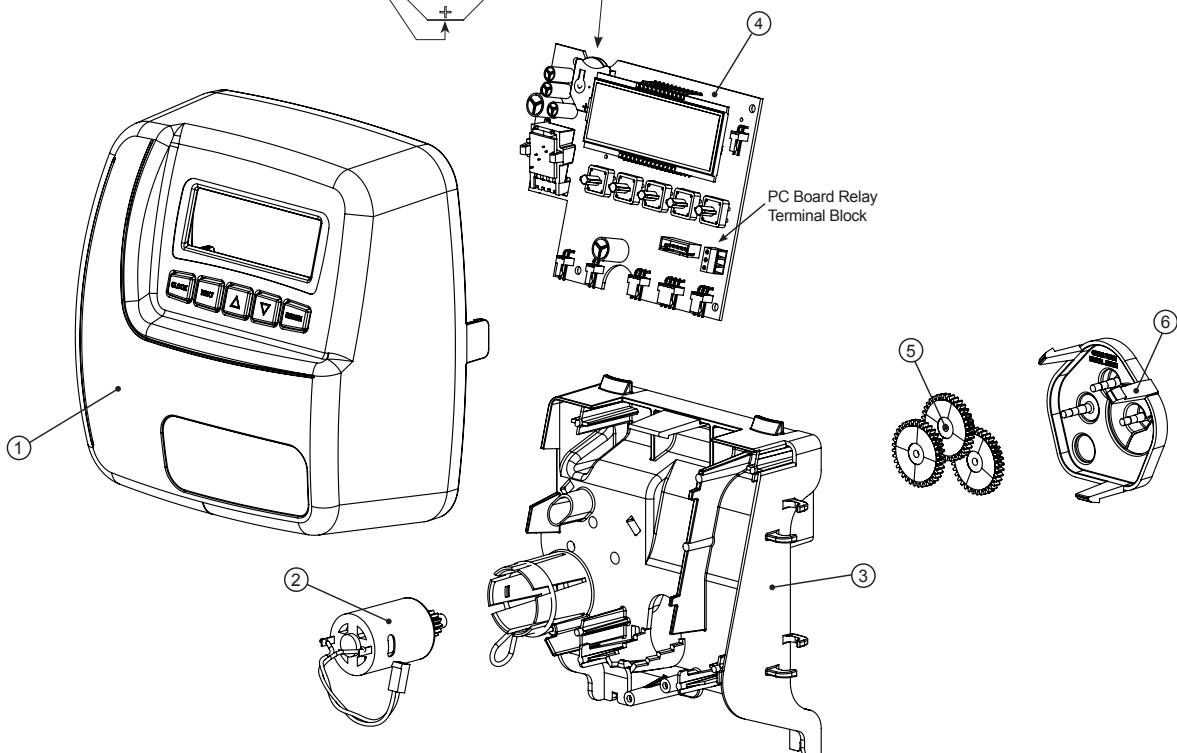

OEM General Programming Instructions

The control valve offers multiple procedures that allow the valve to be modified to suit the needs of the installation. These procedures are:

- OEM Cycle Sequence
- OEM Softener System Setup
- OEM Filter System Setup
- Installer Display Settings
- User Display Settings
- Diagnostics
- Valve History

Once the OEM Cycle Sequence has been set, the other procedures can be accessed in any order. Details on each of the procedures are provided on the following pages.

To “lock out” access to diagnostic and valve history displays and modifications to settings except hardness, day override, time of regeneration and time of day by anyone but the manufacturer, press ▼, NEXT, ▲, and CLOCK in sequence after settings are made. To “unlock”, so other displays can be viewed and changes can be made, press ▼, NEXT, ▲, and CLOCK in sequence.

When in operation normal user displays such as time of day, volume remaining before regeneration, present flow rate or days remaining before regeneration are shown. When stepping through a procedure, if no buttons are pressed within five minutes, the display returns to a normal user display. Any changes made prior to the five minute time out are incorporated.

To quickly exit OEM Softener Setup, OEM Filter Setup, Installer Display Settings, Diagnostics or Valve History press CLOCK. Any changes made prior to the exit are incorporated.

To clear the Service Call reminder, press the ▲ and ▼ buttons simultaneously while CALL is displayed.

When desired, all programming and information in Diagnostics may be reset to defaults when the valve is installed in a new location. To reset to defaults, press NEXT and ▼ buttons simultaneously to go to the Softening/Filtering Screen. Press ▲ and ▼ simultaneously to reset diagnostic values and all programming to defaults. Screen will return to User Display.

Sometimes it is desirable to have the valve initiate and complete two regenerations within 24 hours and then return to the preset regeneration procedure. It is possible to do a double regeneration if the control valve is set to “NORMAL” or “NORMAL + “On 0” in OEM Softener System Setup or OEM Filter System Setup. To do a double regeneration:

1. Press the “REGEN” button once. REGEN TODAY will flash on the display.
2. Press and hold the “REGEN” button for three seconds until the valve regeneration initiates.

Once the valve has completed the immediate regeneration, the valve will regenerate one more time at the preset regeneration time.

Proportional Brining

If the system is set up as a prefill 1” upflow softener the control valve can also be set to normal or proportional brining.

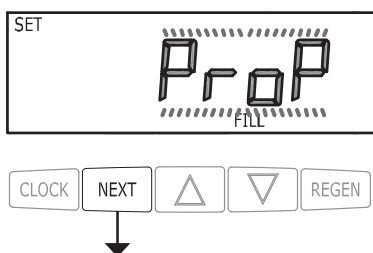

This step will appear after Step 8S and before Step 9S if the system is set up as a prefill upflow softener. The following options can be selected:

- NORMAL FILL - System always prefills with the salt level selected.
- ProP FILL - If proportional brining is selected, the actual salt fill time will be calculated by dividing the actual volume of treated water used by the full volumetric capacity, then multiplying this value by the maximum salt fill time.

Press NEXT to go to the next step. Press REGEN to return to the previous step.

OEM Cycle Sequence

STEP 1C

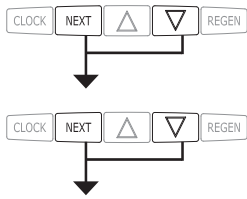

Step 1C – Press NEXT and ▼ simultaneously for 3 seconds and release. Then press NEXT and ▼ simultaneously for 3 seconds and release. If screen in Step 2C does not appear in 5 seconds the lock on the valve is activated. To unlock press ▼, NEXT, ▲, and CLOCK in sequence, then press NEXT and ▼ simultaneously for 3 seconds and release. Then press NEXT and ▼ simultaneously for 3 seconds and release.

STEP 2C

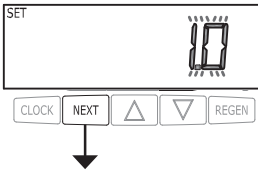

Step 2C – Use the ▲ or ▼ to select 1.0 for 1” valve, 1.25 for 1.25” valve, 1.5 for 1.5” valve, 2.0L for 2L valve or 2.0 for 2” valve¹.

Note: When using the WS2 valve, if “2.0L” is set instead of “2.0”, when the valve is in regeneration and the piston drives to the “DRAW” cycle the piston will stall and generate a 1002 error code. Clear the error code by pressing “NEXT” and “REGEN” buttons simultaneously until the valve resets, then re-program valve to proper valve type setting. Press NEXT to go to Step 3C. Press REGEN to exit OEM cycle sequence.

STEP 3C

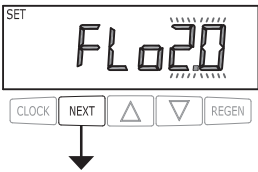

Step 3C – When 2.0L or 2.0 are selected, an additional screen will appear. It is used to select which size flow meter is to be used with the valve, 1.5 or 2.0. Press NEXT to go to Step 4C. Press REGEN to return to previous step.

¹When using the WS2 control valve, the circuit board software must have valve selection choices of 2.0 and 2.0L. The WS2 valve must be set for the 2.0 valve type during programming. If the software version does not have both the 2.0 and 2.0L selections, consult your equipment supplier for a replacement circuit board. When using the WS2L valve with older version software that does not have both 2.0 and 2.0L selection choices, the valve must be set to 2.0 during programming. If a WS2L valve is being used with newer version software that has both 2.0 and 2.0L selection choices, the valve must be set to 2.0L during programming.

STEP 4C

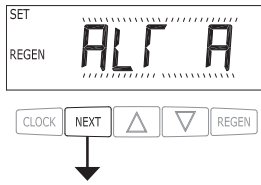

Step 4C – Allows selection of one of the following using the ▲ or ▼ buttons:

- the Control Valve to act as an alternator; or
- the Control Valve to have a no hard water bypass; or
- the Control Valve to have a Separate Source during the regeneration cycle.

Select OFF when none of these features are used.

Only use Clack No Hard Water Bypass Valves or Clack Motorized Alternating Valves (MAV) with these selections. Clack No Hard Water Bypass Valves (1" or 1.25" V3070FF or V3070FM) are not designed to be used with the alternator function or separate source mode.

Selecting the Control Valve to act as an alternator:

C102.8 and higher = Use 3-wire Interconnect Cable for all communication between units.

C100.8 and lower = Use 2-wire Interconnect Cables for twin alternators with independent flow meters.

		Softener valve programming steps	
OEM cycle sequence	Step 4C	Set to ALT A Connect ALT A valve to the MAV's A port and connect the MAV's two pin wire connector to the two pin connector labeled "MAV DRIVE" on the ALT A valve	Set to ALT B Connect ALT B valve to the MAV's B port. No connections between the ALT B valve and the MAV are made.
Softener System Setup	Step 9S	Set to "AUTO"	Set to "AUTO"
Softener System Setup	Step 10S	Set regeneration time option to "On 0".	Set regeneration time option to "On 0".
Installer Display Setting	Step 3I	Set Day Override to "OFF"	Set Day Override to "OFF"

If set up for a filter, in Step 7F set Volume Capacity in Gallons; in Step 8F select Regeneration Time Option "On 0"; and in Step 3I select Day Override "OFF".

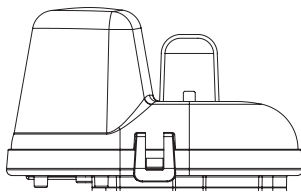

Retracted

Valve "A" in Service Position = MAV piston rod Retracted

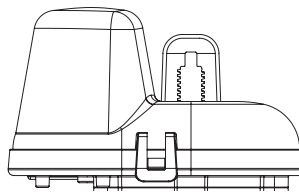

Extended

Valve "B" in Service Position = MAV piston rod Extended

NOTE: Clack twin alternators may be set up to operate with day over-ride in conjunction with the main volume-based regeneration setting. Alternator systems will only count days on the unit that is on-line, which will allow the system to alternate regeneration based exclusively on the day over-ride setting when programmed for either time-clock regeneration or volume based regeneration during periods of low usage. At zero capacity remaining, a Clack twin alternator will perform an immediate transfer of the MAV to place a fully regenerated tank on-line. The regeneration of the exhausted tank will then be delayed until the set Regeneration Time.

For Clack Corporation alternator systems using **WS1, WS1.25, WS1.5, and WS2L** valves there will be an option to delay the last two cycles of regeneration (only “Rinse” and “Fill”). This feature splits the regeneration into two portions. The first portion of the regeneration will start immediately and all programmed cycles before the “Rinse” and “Fill” cycles will be performed. After all programmed cycles before “Rinse” and “Fill” are completed the control valve will drive to the service position (displaying “Delayed Rinse + Fill Pending”). When the volume of the on-line unit is depleted to 10% of its programmed capacity, the control valve will be triggered to finish the second portion of the regeneration. Once “Rinse” and “Fill” are completed, the valve will re-enter Standby mode until requested to come on-line for Service.

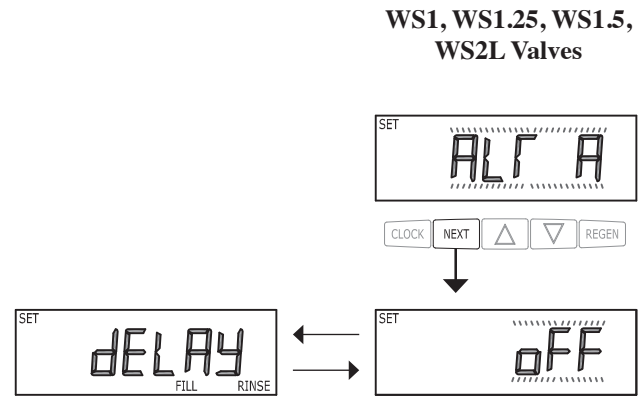

For Clack Corporation alternator systems using the **WS2** valve, when NEXT is pressed after selecting ALTA or ALTB, a display will allow the user to set the amount of pre-service rinse time for the stand by tank just prior to returning to service.

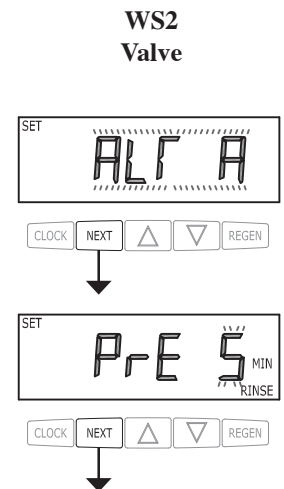

Configuring the Control Valve for No Hard Water Bypass Operation:

Select “nHbP” for control operation. For no hard water bypass operation the three wire connector is not used. Selection requires that a connection to MAV or a Clack No Hard Water Bypass Valve is made to the two pin connector labeled MAV DRIVE located on the printed circuit board. If using a MAV, the A port of the MAV must be plugged and the valve outlet connected to the B port. When set to “nHbP”, the MAV will be driven closed before the first regeneration cycle that is not FILL or SOFTENING or FILTERING, and be driven open after the last regeneration cycle that is not FILL.

NOTE: If the control valve enters into an error state during regeneration mode, the no hard water bypass valve will remain in its current state until the error is corrected and reset.



Configuring the Control Valve for Separate Source Operation:

Select “SEPS” for control operation. For separate source operation, the three wire connector is not used. Selection requires that a connection to a Clack Motorized Alternator Valve (MAV) is made to the two pin connector labeled MAV DRIVE located on the printed circuit board. The C port of the MAV must be connected to the valve inlet and the A port connected to the separate source used during regeneration. The B port must be connected to the feed water supply. When set to “SEPS”, the MAV will be driven closed before the first regeneration cycle, and be driven open after the last regeneration cycle.

NOTE: If the control valve enters into an error state during regeneration mode, the MAV will remain in its current state until the error is corrected and reset.

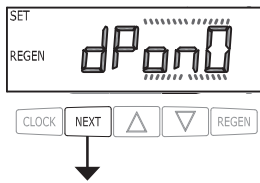

Press NEXT to go to Step 5C. Press REGEN to return to previous step.

STEP 5C

Step 5C – Allows selection of one of the following using the ▲ or ▼ buttons:

- an outside signal to initiate a regeneration
- an outside signal to prevent or delay a regeneration.

Selection only matters if a connection is made to the two pin connector labeled DP SWITCH located on the printed circuit board. Following is an explanation of the options:

OFF - Feature not used.

NOTE: In a twin alternating system, each control must have a separate dP signal or dP switch. One dP signal or one dP switch cannot be used for both controls.

dPon0 – If the dP switch is closed for an accumulative time of 2 minutes a regeneration will be signaled to the unit. In a twin alternating system the MAV will transition first to switch units so that the signaled unit can start regeneration. After the MAV has fully transitioned, the regeneration begins immediately. Note: For WS1 – WS2L control valves programmed for twin alternating; if the dP function “dPon0” is set, the Delayed Rinse and Fill feature is not available.

dPdEL – If the dP switch is closed for an accumulative time of 2 minutes a regeneration will occur at the scheduled delayed regeneration time. In a twin alternating system once the dP switch is triggered the PC Board will display “REGEN TODAY” and when the delayed regen time comes the control will switch tanks and the triggered unit will then go into regeneration.

Note: For WS1 – WS2L control valves programmed for twin alternating; if the dP function “dPdEL” is set, the Delayed Rinse and Fill feature is not available.

HoLd – If the dP switch is closed a regeneration will be prevented from occurring while there is switch closure. In a twin alternating system the regeneration of a unit can be prevented upon switch closure. If the unit depletes the capacity down to zero, it will not be allowed to switch tanks to regenerate until the switch is open.

Note: For WS1 – WS2L control valves programmed for twin alternating the Delayed Rinse and Fill feature can be set in conjunction with the “HoLd” if desired.

Press NEXT to go to Step 6C. Press REGEN to return to previous step.

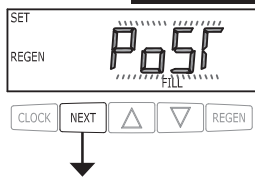
STEP 6C

STEP 6C – Set Refill option using ▼ or ▲ buttons:

- “PoST” to refill the brine tank after the final rinse; or
- “PrE” to refill the brine tank two hours before the regeneration time set.

If “Filter” is selected in Step 2F, this screen will not appear.

Press NEXT to go to Step 7C. Press REGEN to return to previous step.

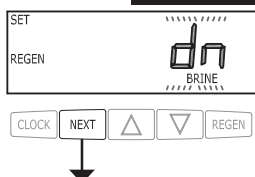
STEP 7C

STEP 7C – Set regenerant downflow or upflow using ▼ or ▲ buttons:

- “dn” if the regenerant is to flow downward through the media; or
- “UP” if the regenerant is to flow upward through the media. Step 2C must be set to 1 for a 1” valve.

Prior to selecting a regenerant flow direction, verify the correct valve body, main piston, regenerant piston, and stack are being used, and that the injector or injector plug(s) are in the correct locations. Refer to WS1 & WS1.25 Drawings and Service Manual, Valve Body Compliance Table. This screen will not display if the unit is set up as a 1.25”, 1.5”, 2”, 2L” or filter valve.

Press NEXT to exit OEM Cycle Sequence. Press REGEN to return to previous step.

RETURN TO NORMAL MODE

OEM Softener System Setup

In OEM Softener System Setup the OEM chooses the value for the specified cycles (the order of which is specified by the selections for Step 6C and Step 7C in OEM Cycle Sequence) and specifies other operating parameters for the system. If a cycle is present the value can be set to off. Fill is in pounds of salt and all other cycles are in minutes. Fill for 2" valve is in minutes.

Step 6C	Step 7C	Cycle Order
Post	dn	Backwash, Brine, Backwash, Rinse, Fill
Pre	dn	Fill, Service, Backwash, Brine, Backwash, Rinse
Post	UP	Brine, Backwash, Rinse, Fill (WS1 valves only)
Pre	UP	Fill, Service, Brine, Backwash, Rinse (WS1 valves only)

Note: If "Pre" is selected in Step 6C and "UP" is selected in Step 7C, the proportional brining display will appear after the Grains Capacity display (Step 8S).

STEP 1S

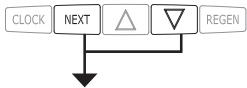

Step 1S – Press NEXT and ▼ simultaneously for 3 seconds and release. If screen in Step 2S does not appear in 5 seconds the lock on the valve is activated. To unlock press ▼, NEXT, ▲, and CLOCK in sequence, then press NEXT and ▼ simultaneously for 3 seconds and release.

STEP 2S

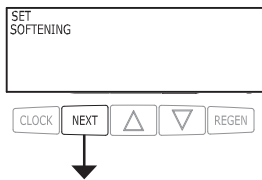

Step 2S – Choose SOFTENING using the ▼ or ▲ button. Press NEXT to go to Step 3S. Press REGEN to exit OEM Softener System Setup.

STEP 3S

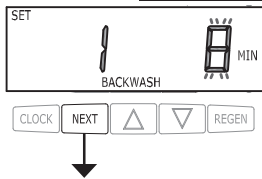

Step 3S – Select the time for the first cycle (which in this example is BACKWASH) using the ▼ or ▲ button. Press NEXT to go to Step 4S. Press REGEN to return to previous step.

STEP 4S

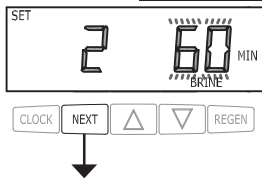

Step 4S – Select the time for the second cycle (which in this example is dn BRINE) using the ▼ or ▲ button. Press NEXT to go to Step 5S. Press REGEN to return to previous step. NOTE: The display will flash between cycle number and time, and brine direction (dn or UP).

STEP 5S

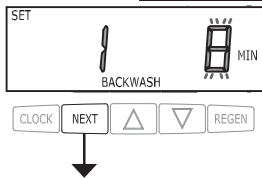

Step 5S – Select the time for the third cycle (which in this example is BACKWASH) using the ▼ or ▲ button. Press NEXT to go to Step 6S. Press REGEN to return to previous step.

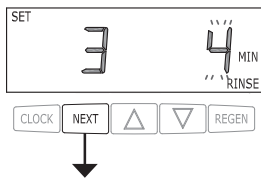
STEP 6S

Step 6S – Select the time for the fourth cycle (which in this example is RINSE) using the ▼ or ▲ button. Press NEXT to go to Step 7S. Press REGEN to return to previous step.

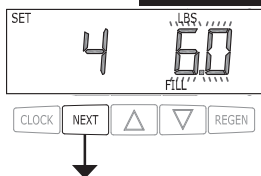
STEP 7S

Step 7S – Select the LBS for the fifth cycle (which in this example is FILL) using the ▼ or ▲ button. When both 2.0L and 2.0 are options in Step 2C, and 2.0 is selected, FILL is in minutes. Press NEXT to go to Step 8S. Press REGEN to return to previous step.

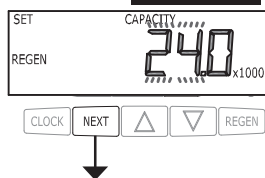
STEP 8S

Step 8S –Set Grains Capacity using the ▼ or ▲ button. The ion exchange capacity is in grains of hardness as calcium carbonate for the system based on the pounds of salt that will be used. Calculate the pounds of salt using the fill time previously selected. Grains capacity is affected by the fill time. The grains capacity for the selected fill time should be confirmed by OEM testing. The capacity and hardness levels entered are used to automatically calculate reserve capacity when gallon capacity is set to AUTO. Press NEXT to go to Step 9S. Press REGEN to return to previous step.

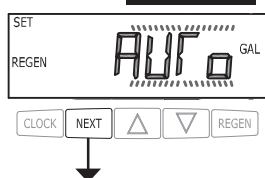
STEP 9S

Step 9S – Set Volume Capacity using the ▼ or ▲ button. If value is set to:

- “AUTO”– capacity will be automatically calculated and reserve capacity will be automatically estimated;
- “oFF”– regeneration will be based solely on the day override set (see Installer Display Settings Step 3I); or
- a number – regeneration initiation will be based off the value specified.

If “oFF” or a number is used, hardness display will not be allowed to be set in Installer Display Settings Step 2I. See Setting Options Table for more detail. Press NEXT to go to Step 10S. Press REGEN to return to previous step.

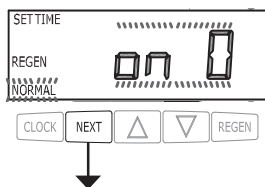
STEP 10S

Step 10S – Set Regeneration Time Options using the ▼ or ▲ button. If value is set to:

- “NORMAL” means regeneration will occur at the preset time;
- “on 0” means regeneration will occur immediately when the gallons capacity reaches 0 (zero); or
- “NORMAL + on 0” means regeneration will occur at one of the following:
 - the preset time when the gallons capacity falls below the reserve or the specified number of days between regenerations is reached, whichever comes first; or
 - after 10 minutes of no water usage when the gallons capacity reaches 0 (zero). See Setting Options Table for more detail. Press NEXT to go to Step 11S.

“NORMAL” is the default if Step 4C is set to ALTA or ALTB, and “NORMAL + on 0” is not available. Press REGEN to return to previous step.

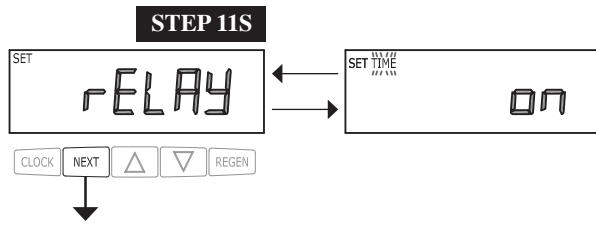

Step 11S – Set Relay operation using the ▼ or ▲ button. The choices are:

- Set Time: After the start of a regeneration the amount of time that should pass prior to activating the relay. The start of regeneration is defined as the first backwash cycle, Dn brine cycle or UP brine cycle which ever comes first.
- Set Softening Gal: Relay activates after a set number of gallons have been used while in service and then deactivates after a set period of time or after the meter stops registering flow, whichever comes first.
- Set Softening Regen Gal: Relay activates after a set number of gallons have been used while in service or during regeneration and then deactivates after a set period of time or after the meter stops registering flow, whichever comes first.
- Set HoLd Gal: Relay closes every set number of gallons and releases when the ▲ button is pressed.
- Set Off: If set to Off, Steps 12S and 13S will not be shown.

Press NEXT to go to Step 12S. Press REGEN to return to previous step.

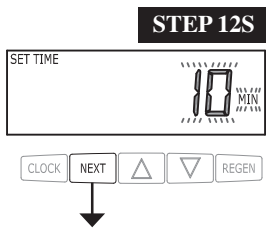

Step 12S: Set Relay Actuation Time or Gallons using the ▲ or ▼ buttons. The choices are:

- Relay Actuation Time: After the start of a regeneration the amount of time that should pass prior to activating the relay. The start of regeneration is defined as the first backwash cycle or Dn brine cycle, which ever comes first. Ranges from 1 minute to 500 minutes.
- Relay Actuation Gallons: Relay activates after a set number of gallons have passed. Ranges from 1 to 100 gallons.
- Relay HoLd: Relay closes every set number of gallons. Ranges from 1,000 to 99,000,000 gallons.

Press NEXT to go to Step 13S. Press REGEN to return to previous step.

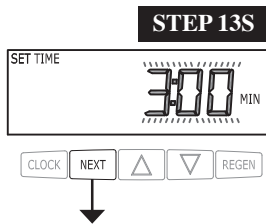

Step 13S: Set Relay Deactivate Time using the ▲ or ▼ buttons.

- If Set Time on is selected in Step 11S the relay will deactivate after the time set has expired. Ranges from 1 second to 500 minutes.
- If Set Gal Softening on or Set Gal Softening Regen on is selected in Step 11S the relay will deactivate after the time set has expired or after the meter stops registering flow, whichever comes first. Ranges from 1 second to 500 minutes.
- Does not display for HoLd Gal selection. Press NEXT to go to Step 14S. Press REGEN to return to previous step.

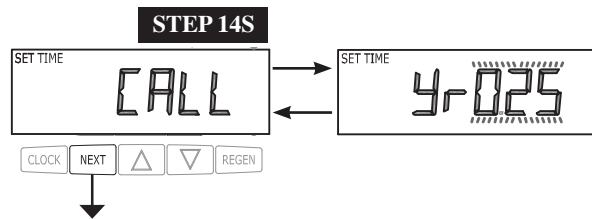

Step 14S: Set the Service Call Indicator by using the ▲ or ▼ buttons. Range is in ¼ of a year increments from 0.25 to 9.75 years. Selecting OFF will disable this feature. Press NEXT to go to Step 15S. Press REGEN to return to previous step.

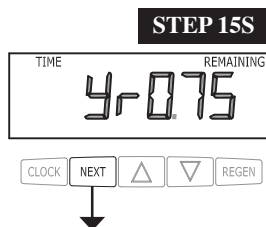

Step 15S: Displays time remaining before a service call is requested. To reset the time remaining to the original programmed value, press and hold ▲ and ▼ for approximately 3 seconds. The display will return to the value selected in Step 14S.

RETURN TO NORMAL MODE

Setting Options Table
Filters should only use shaded options.

Volume Capacity	Regeneration Time Option	Day Override	Result ²
AUTO	NORMAL	OFF	Reserve capacity automatically estimated. Regeneration occurs when volume capacity falls below the reserve capacity at the next Regen Set Time
AUTO	NORMAL	Any number	Reserve capacity automatically estimated. Regeneration occurs at the next Regen Set Time when volume capacity falls below the reserve capacity or the specified number of days between regenerations is reached.
Any number	NORMAL	OFF	Reserve capacity <u>not</u> automatically estimated. Regeneration occurs at the next Regen Set Time when volume capacity reaches 0.
OFF	NORMAL	Any number	Reserve capacity <u>not</u> automatically estimated. Regeneration occurs at the next Regen Set Time when the specified number of days between regenerations is reached.
Any number	NORMAL	Any number	Reserve capacity <u>not</u> automatically estimated. Regeneration occurs at the next Regen Set Time when volume capacity reaches 0 or the specified number of days between regenerations is reached.
AUTO	On 0	OFF	Reserve capacity <u>not</u> automatically estimated. Regeneration occurs immediately when volume capacity reaches 0. Time of regeneration will not be allowed to be set because regeneration will always occur when volume capacity reaches 0.
Any number	On 0	OFF	Reserve capacity <u>not</u> automatically estimated. Regeneration occurs immediately when volume capacity reaches 0. Time of regeneration will not be allowed to be set because regeneration will always occur when volume capacity reaches 0.
AUTO	NORMAL + On 0	OFF	Reserve capacity automatically estimated. Regeneration occurs when volume capacity falls below the reserve capacity at the next Regen Set Time or regeneration occurs after 10 minutes of no water usage when volume capacity reaches 0.
AUTO	NORMAL + On 0	Any number	Reserve capacity automatically estimated. Regeneration occurs at the next Regen Set Time when volume capacity falls below the reserve capacity or the specified number of days between regenerations is reached or regeneration occurs after 10 minutes of no water usage when volume capacity reaches 0.
Any number	NORMAL + On 0	Any number	Reserve capacity <u>not</u> automatically estimated. Regeneration occurs at the next Regen Set Time when the specified number of days between regenerations is reached or regeneration occurs after 10 minutes of no water usage when volume capacity reaches 0.

²Reserve capacity estimate is based on history of water usage

OEM Filter System Setup

In OEM Filter System Setup the order of the cycles is preset to Backwash, dn Brine, Backwash, Rinse and Fill. Fill is set in gallons and all other cycles are set in minutes. Fill for 2" valve is in minutes. Each cycle can be set to off.

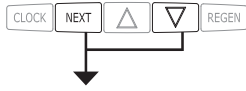
STEP 1F

Step 1F – Press NEXT and ▼ simultaneously for 3 seconds and release. If screen in Step 2F does not appear in 5 seconds the lock on the valve is activated. To unlock press ▼, NEXT, ▲, and CLOCK in sequence, then press NEXT and ▼ simultaneously for 3 seconds and release.

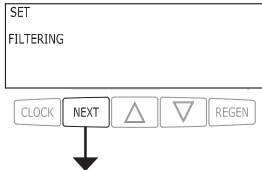
STEP 2F

Step 2F – Choose FILTERING using the ▼ or ▲ buttons. Press NEXT to go to Step 3F. Press REGEN to exit OEM Filter System Setup.

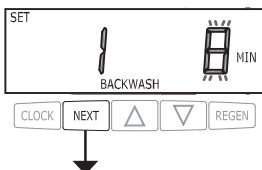
STEP 3F

Step 3F – Select the time for the first cycle using the ▼ or ▲ button. Press NEXT to go to Step 4F. Press REGEN to return to previous step.

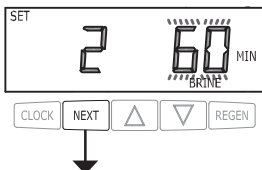
STEP 4F

Step 4F – Select the time for the second cycle using the ▼ or ▲ button. Press NEXT to go to Step 5F. Press REGEN to return to previous step.
NOTE: The display will flash between cycle number and time, and brine direction (dn or UP).

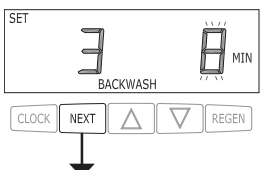
STEP 5F

Step 5F – Select the time for the third cycle using the ▼ or ▲ button. Press NEXT to go to Step 6F. Press REGEN to return to previous step.

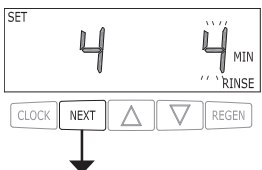
STEP 6F

Step 6F – Select the time for the fourth cycle using the ▼ or ▲ button. Press NEXT to go to Step 7F. Press REGEN to return to previous step.

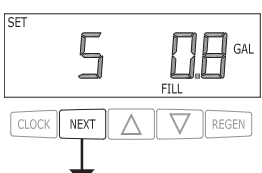
STEP 7F

STEP 7F – Enter “oFF” if regenerant is not used (i.e. backwash only) or enter the refill volume (in gallons) using ▼ or ▲ buttons. When both 2.0 and 2.0L are options in Step 2C, and 2.0 is selected, FILL is in minutes. Press NEXT to go to Step 8F. Press REGEN to return to previous step.

STEP 8F

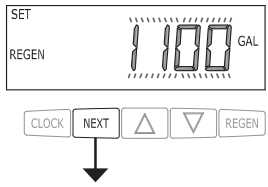

Step 8F – Set Volume Capacity using the ▼ or ▲ button. If value is set to:

- “oFF” – regeneration will be based solely on the day override set (see Installer Display/Settings Step 3I); or
- a number – regeneration initiation will be based off the value specified.

See Setting Options Table for more detail. Press NEXT to go to the remaining Filter Systems Setup screens. Refer to Softener System Setup starting at step 10S for details. Press REGEN to return to previous step.

Installer Display Settings

STEP 1I

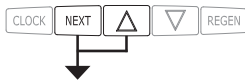

STEP 1I - Press NEXT and ▲ simultaneously for 3 seconds.

STEP 2I

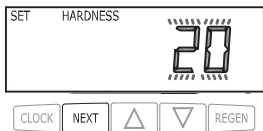

STEP 2I – Hardness: Set the amount of hardness in grains of hardness as calcium carbonate per gallon using the ▼ or ▲ buttons. The default is 20 with value ranges from 1 to 150 in 1 grain increments. Note: The grains per gallon can be increased if soluble iron needs to be reduced. This display will show “-nA-” if “FILTER” is selected in Step 2F or if ‘AUTO’ is not selected in Set Volume Capacity in OEM Softener System Setup. Press NEXT to go to step 3I. Press REGEN to exit Installer Display Settings.

STEP 3I

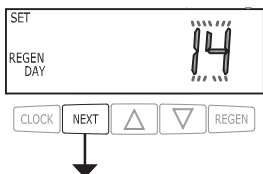

STEP 3I – Day Override: When volume capacity is set to “oFF”, sets the number of days between regenerations. When volume capacity is set to AUTO or to a number, sets the maximum number of days between regenerations. If value set to “oFF”, regeneration initiation is based solely on volume used. If value is set as a number (allowable range from 1 to 28) a regeneration initiation will be called for on that day even if sufficient volume of water were not used to call for a regeneration. Set Day Override using ▼ or ▲ buttons:

- number of days between regeneration (1 to 28); or
- “oFF”.

See Setting Options Table for more detail on setup. Press NEXT to go to step 4I. Press REGEN to return to previous step.

STEP 4I

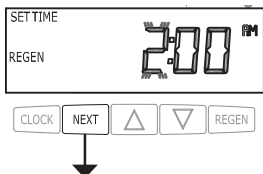

STEP 4I – Next Regeneration Time (hour): Set the hour of day for regeneration using ▼ or ▲ buttons. AM/PM toggles after 12. The default time is 2:00 AM. This display will show “on 0” if “on 0” is selected in Set Regeneration Time Option in OEM Softener System Setup or OEM Filter System Setup. Press NEXT to go to step 5I. Press REGEN to return to previous step.

STEP 5I

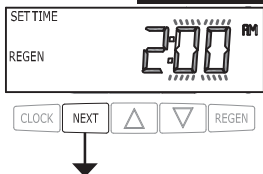

STEP 5I – Next Regeneration Time (minutes): Set the minutes of day for regeneration using ▼ or ▲ buttons. This display will not be shown if “on 0” is selected in Set Regeneration Time Option in OEM Softener System Setup or OEM Filter System Setup. Press NEXT to exit Installer Display Settings. Press REGEN to return to previous step.

To initiate a manual regeneration immediately, press and hold the “REGEN” button for three seconds. The system will begin to regenerate immediately. The control valve may be stepped through the various regeneration cycles by pressing the “REGEN” button.

RETURN TO
NORMAL MODE

User Display Settings

General Operation

When the system is operating, one of five displays may be shown. Pressing NEXT will alternate between the displays. One of the displays is always the current time of day.

The second display is one of the following: days remaining or volume remaining. Days remaining is the number of days left before the system goes through a regeneration cycle. Capacity remaining is the gallons that will be treated before the system goes through a regeneration cycle.

The third display shows the current treated water flow rate through the system. The fourth display will show either dP or hold if the dP switch is closed.

The fifth display indicates the user should call for service. The fifth display will not appear if OFF is selected in Step 14S of OEM Softener System Setup. To clear the Service Call reminder, press the ▲ and ▼ buttons simultaneously while CALL is displayed.

If the system has called for a regeneration that will occur at the preset time of regeneration, the words REGEN TODAY will appear on the display.

If a water meter is installed, the word “Softening” or “Filtering” flashes on the display when water is being treated (i.e. water is flowing through the system).

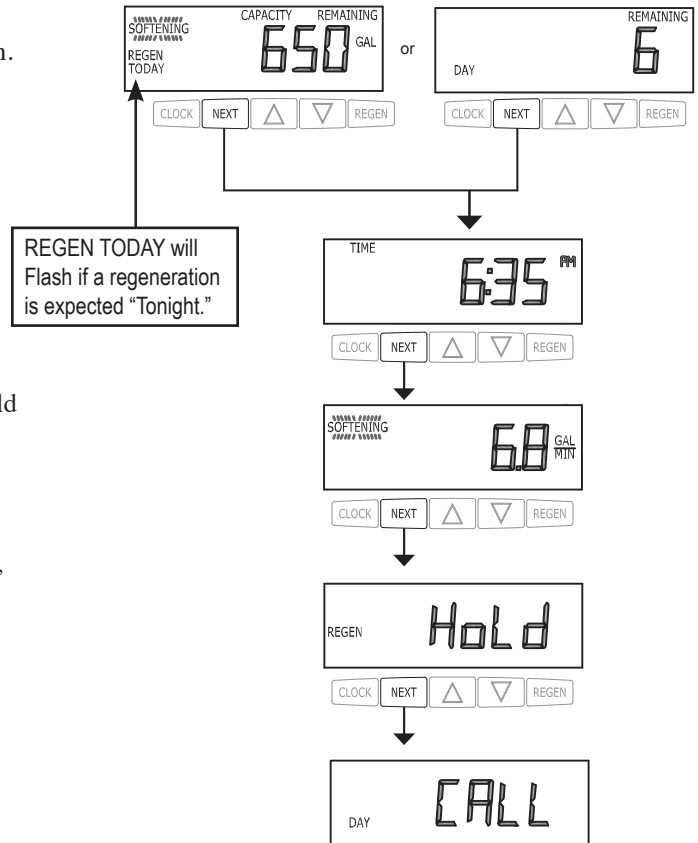

In Alternator Systems when a unit is waiting to initiate the first cycle step of regeneration, “REGEN PndG” is displayed.



“STbY” is displayed in Alternator Systems when a valve is in Standby state.



“REGEN PndG FILL RINSE” is displayed whenever a zero-capacity tank has transferred to an off-line state and is currently waiting to initiate the second portion of a regeneration cycle. Viewed only when Delayed Rinse and Fill is set to ON.



Regeneration Mode

Typically a system is set to regenerate at a time of low water usage. An example of a time with low water usage is when a household is asleep. If there is a demand for water when the system is regenerating, untreated water will be used.

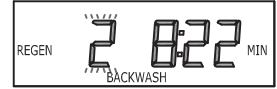

When the system begins to regenerate, the display will change to include information about the step of the regeneration process and the time remaining for that step to be completed. The system runs through the steps automatically and will reset itself to provide treated water when the regeneration has been completed.

Manual Regeneration

Sometimes there is a need to regenerate the system sooner than when the system calls for it, usually referred to as manual regeneration. There may be a period of heavy water usage because of guests or a heavy laundry day.

REGEN TODAY will Flash if a regeneration is expected "Tonight."

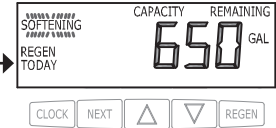

To initiate a manual regeneration at the preset delayed regeneration time, when the regeneration time option is set to "NORMAL" or "NORMAL + on 0", press and release "REGEN". The words "REGEN TODAY" will flash on the display to indicate that the system will regenerate at the preset delayed regeneration time. If you pressed the "REGEN" button in error, pressing the button again will cancel the request. Note: If the regeneration time option is set to "on 0" there is no set delayed regeneration time so "REGEN TODAY" will not activate if "REGEN" button is pressed.

To initiate a manual regeneration immediately, press and hold the "REGEN" button for three seconds. The system will begin to regenerate immediately. The request cannot be cancelled.

Note: For softeners, if the brine tank does not contain salt, fill with salt and wait at least two hours before regenerating.

Set Time of Day

The user can also set the time of day. Time of day should only need to be set if the battery has been depleted because of extended power outages or when daylight saving time begins or ends. If an extended power outage occurs, the time of day will flash on and off which indicates the time of day should be reset. The non rechargeable battery should also be replaced.

STEP 1U

STEP 1U – Press CLOCK.



STEP 2U

STEP 2U - Current Time (hour): Set the hour of the day using ▼ or ▲ buttons. AM/PM toggles after 12. Press NEXT to go to Step 3U.

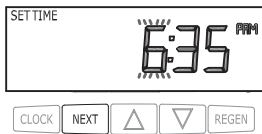

STEP 3U

STEP 3U - Current Time (minutes): Set the minutes of the day using ▼ or ▲ buttons. Press NEXT to exit Set Time of Day. Press REGEN to return to previous step.

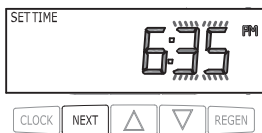

RETURN TO NORMAL MODE

RETURN TO NORMAL MODE

Power Loss

If the power goes out the system will keep time until the battery is depleted. If an extended power outage occurs, the time of day will flash on and off which indicates the time of day should be reset and the battery replaced. The system will remember the rest.

Error Message

If the word "ERROR," a number and the word "CALL" are alternately flashing on the display contact the OEM for help. A number indicates that the valve was not able to function properly.



Diagnostics

STEP 1D

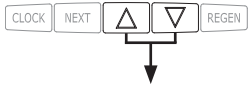

STEP 1D – Press ▲ and ▼ simultaneously for three seconds. If screen in step 2D does not appear in 5 seconds the lock on the valve is activated. To unlock press ▼, NEXT, ▲, and CLOCK in sequence, then press ▲ and ▼ simultaneously for 3 seconds.

STEP 2D

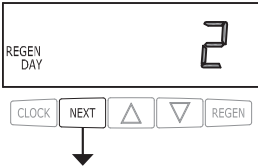

STEP 2D – Days, since last regeneration: This display shows the days since the last regeneration occurred. Press the NEXT button to go to Step 3D. Press REGEN to exit Diagnostics.

STEP 3D

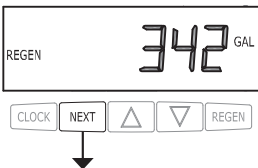

STEP 3D – Volume, since last regeneration: This display shows the volume of water that has been treated since the last regeneration. This display will equal zero if a water meter is not installed. Press the NEXT button to go to Step 4D. Press REGEN to return to previous step.

STEP 4D

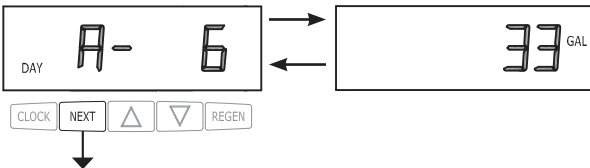

STEP 4D – Volume, reserve capacity used for last 7 days: If the valve is set up as a softener, a meter is installed and Set Volume Capacity is set to “Auto,” this display shows 0 day (for today) and flashes the reserve capacity. Pressing the ▲ button will show day 1 (which would be yesterday) and flashes the reserve capacity used. Pressing the ▲ button again will show day 2 (the day before yesterday) and the reserve capacity. Keep pressing the ▲ button to show the capacity for days 3, 4, 5 and 6. The ▼ button can be pressed to move backwards in the day series. Press the NEXT button at any time to go to Step 5D. Press REGEN to return to previous step.

STEP 5D

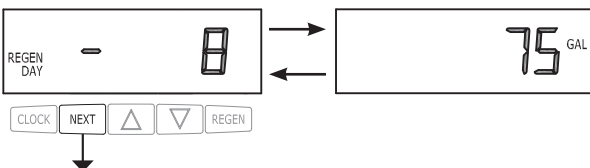

STEP 5D - Volume, 63-day usage history: This display shows day 1 (for yesterday) and flashes the volume of water treated yesterday. Pressing the ▲ button will show day 2 (which would be the day before yesterday) and flashes the volume of water treated on that day. Continue to press the ▲ button to show the maximum volume of water treated for the last 63 days. If a regeneration occurred on the day the word “REGEN” will also be displayed. This display will show dashes if a water meter is not installed. Press the NEXT button at any time to go to Step 6D. Press REGEN to return to previous step.

STEP 6D

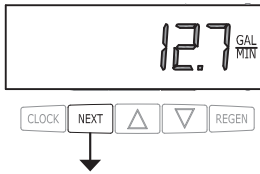

STEP 6D – Flow rate, maximum last seven days: The maximum flow rate in gallons per minute that occurred in the last seven days will be displayed. This display will equal zero if a water meter is not installed. Press the NEXT button to exit Diagnostics. Press REGEN to return to previous step.

STEP 7D

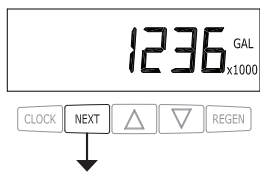

STEP 7D – Gallons, total used since start-up: This display shows the total gallons treated since startup. This display will equal zero if a water meter is not installed. Press the NEXT button to go to Step 8D. Press REGEN to return to previous step.

STEP 8D

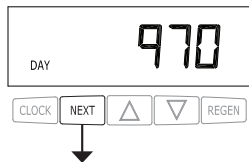

STEP 8D – Days, total since start-up: This display shows the total days since startup. Press the NEXT button to go to Step 9D. Press REGEN to return to previous step.

STEP 9D

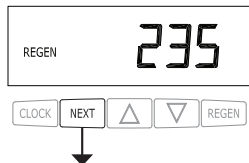

STEP 9D – Regenerations, total number since start-up: This display shows the total number of regenerations that have occurred since startup. Press the NEXT button to exit Diagnostics. Press REGEN to return to previous step.

RETURN TO NORMAL MODE

When desired, all programming and information in Diagnostics may be reset to defaults when the valve is installed in a new location. To reset to defaults, press NEXT and ▼ buttons simultaneously to go to the Softening/Filtering screen. Press ▲ and ▼ simultaneously to reset all programming and diagnostic values to defaults. Screen will return to User Display.

Valve History

STEP 1VH



STEP 1VH – Press ▲ and ▼ simultaneously for three seconds and release. Then press ▲ and ▼ simultaneously and release. If screen in step 2VH does not appear in 5 seconds the lock on the valve is activated. To unlock press ▼, NEXT, ▲, and CLOCK in sequence, then press ▲ and ▼ simultaneously for 3 seconds and release. Then press ▲ and ▼ simultaneously and release.

STEP 2VH



STEP 2VH³ – Software Version: This display shows the software version of the valve. Press the NEXT button to go to Step 3VH. Press REGEN to exit Valve History.

STEP 3VH

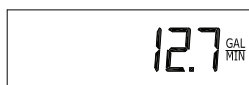

STEP 3VH – Flow rate, maximum since startup: This display shows the maximum flow rate in gallons per minute that has occurred since startup. This display will equal zero if a water meter is not installed. Press the NEXT button to go to Step 4VH. Press REGEN to return to previous step.

STEP 4VH

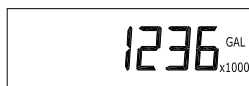

STEP 4VH – Gallons, total used since start-up: This display shows the total gallons treated since startup. This display will equal zero if a water meter is not installed. Press the NEXT button to go to Step 5VH. Press REGEN to return to previous step.

STEP 5VH



STEP 5VH – Days, total since start-up: This display shows the total days since startup. Press the NEXT button to go to Step 6VH. Press REGEN to return to previous step.

STEP 6VH

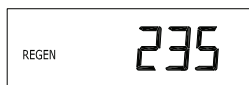

STEP 6VH – Regenerations, total number since start-up: This display shows the total number of regenerations that have occurred since startup. Press the NEXT button to go to Step 7VH. Press REGEN to return to previous step.

STEP 7VH

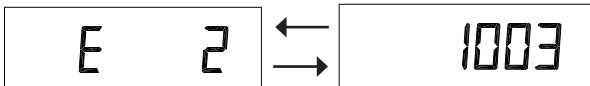

STEP 7VH – Error Log: This display shows a history of the last 10 errors generated by the control during operation. Press the ▲ or ▼ buttons to view each recorded error. Press the next button to exit Valve History. Press REGEN to return to previous step.

RETURN TO NORMAL MODE

³Values in steps 2VH through 7VH cannot be reset.

Revision History:

6/23/2010

PAGE 3:

Added Table of Contents

PAGE 4:

V3558CH-01BOARD WS1THRU2L/2 CH PC BRD SERCOM REPLACE

PAGE 5:

When desired, all programming and information in Diagnostics may be reset to defaults when the valve is installed in a new location. To reset to defaults, press NEXT and ▼ buttons simultaneously to go to the Softening/Filtering screen. Press ▲ and ▼ simultaneously to reset programming and diagnostic values to defaults. Screen will return to User Display.

If proportional brining is selected, the actual salt fill time will be calculated by dividing the actual volume of treated water used by the full volumetric capacity, then multiplying this value by the maximum salt fill time.

PAGE 6:

The upflow cycle may not be used on the WS1.25, WS1.5, WS2 or WS2L control valves, because the V3407 and V3725 pistons are designed for downflow use only. For WS1 valves, prior to selecting DN brine or UP brine or not selecting a regenerant flow cycle, verify the correct valve body, main piston, regenerant piston, and stack are being used, and that the injector or injector plug(s) are in the correct locations. See Valve Body Compliance Table in WS1 & WS1.25 Drawings and Service Manual.

Step 2C revised.

Added Step 3C, old Step 3C now 4C.

PAGES 7 & 8:

Revised Step 4C

PAGE 9:

Revised Step 5C

PAGE 10:

Fill for 2" valve is in minutes.

PAGE 11:

Revised Step 7S: When both 2.0 and 2.0L are options in Step 2CS, and 2.0 is selected, FILL is in minutes.

Step 10S: "NORMAL" is the default if Step 4C is set to ALTA or ALTB, and "NORMAL + on 0" is not available.

PAGE 12:

New drawings for Steps 12S and 13S.

Revised Step 14S and added Step 15S

PAGE 14:

Fill for 2.0" valve is in minutes.

Revised Step 7F: When both 2.0 and 2.0L are options in Step 2C, and 2.0 is selected, FILL is in minutes.

PAGE 16:

New screen displays added.

PAGE 18:

Drawing revised

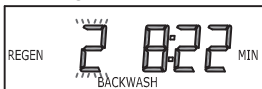

PAGE 21:

When desired, all programming and information in Diagnostics may be reset to defaults when the valve is installed in a new location. To reset to defaults, press NEXT and ▼ buttons simultaneously to go to the Softening/Filtering screen. Press ▲ and ▼ simultaneously to reset all programming and diagnostic values to defaults. Screen will return to User Display.

11/23/2010

PAGE 4:

Software and relay information

Relay Specifications: To insure proper fit and correct operation use either of the Idec relay/relay socket combinations or the exact equivalents.

	Manufacturer	Option 1	Option 2
Relay Socket	Idec	SR3P-05C	SY4S-05C
Relay	Idec	RR2KP-UAC12V / RR2KP-UCAC12V	RY2KS-UAC12V

The relay supplies 2 sets of dry contacts for user applications.
The wiring of these contacts is application specific.

Wiring For Correct On/Off Operation		
PC Board Relay Terminal Block	Relay Socket Model	
	SR3P-05C	SY4S-05C
SET	#2	#13
COM	#6 and #10	#12 and #14
RES	#3	#9

Relay Specifications: 12V DC Relay with a coil resistance not less than 80 ohms. If mounting the relay under the cover check for proper mounting location dimensions on the backplate.

Wiring For Correct On/Off Operation	
PC Board Relay Terminal Block	Relay
RLY 1	Coil -
COM	Coil 1 +

PAGE 6:

Remove text and table.

PAGE 12:

Step 15S: Displays time remaining before a service call is requested. To reset the time remaining to the original programmed value, press and hold ▲ or ▼ for approximately 3 seconds. The display will return to the value selected in Step 14S.

12/2/2010

PAGE 12:

Step 15S: Displays time remaining before a service call is requested. To reset the time remaining to the original programmed value, press and hold ▲ and ▼ for approximately 3 seconds. The display will return to the value selected in Step 14S.