

White-Rodgers™

1F89-211

Non-programmable Electronic Digital
Heat Pump Thermostat
**INSTALLATION AND
OPERATION INSTRUCTIONS**

Operator: Save these instructions for future use!

**FAILURE TO READ AND FOLLOW ALL INSTRUCTIONS CAREFULLY
BEFORE INSTALLING OR OPERATING THIS CONTROL COULD CAUSE
PERSONAL INJURY AND/OR PROPERTY DAMAGE.**

DESCRIPTION

Your new White-Rodgers Digital Thermostat uses the technology of a solid-state microcomputer to provide precise temperature control.

Features:

- Simultaneous heat and cool setpoint storage
- Setpoint storage in case of power loss
- Pre-set temperature control
- LCD continuously displays setpoint and room temperature
- Continuous Backlit display option
- °F/°C convertibility
- Temperature range 45° to 90°F
- R, C, Y, W2, G, O/B, E, and L terminals for single or two-transformer systems
- Optional "AA" batteries to provide continuous temperature display during loss of AC power

PRECAUTIONS

This thermostat is intended for use with a low voltage system; do not use this thermostat with a line voltage system. If in doubt about whether your wiring is millivolt, line, or low voltage, have it inspected by a qualified heating and air conditioning contractor or electrician.

Do not exceed the specification ratings.

All wiring must conform to local and national electrical codes and ordinances.

This control is a precision instrument, and should be handled carefully. Rough handling or distorting components could cause the control to malfunction.

CAUTION

To prevent electrical shock and/or equipment damage, disconnect electric power to system at main fuse or circuit breaker box until installation is complete.

WARNING

Do not use on circuits exceeding specified voltage. Higher voltage will damage control and could cause shock or fire hazard.

Do not short out terminals on gas valve or primary control to test. Short or incorrect wiring will damage thermostat and could cause personal injury and/or property damage.

Thermostat installation and all components of the system shall conform to Class II (current limited) circuits per the NEC code. Failure to do so could cause a fire hazard.

SPECIFICATIONS

ELECTRICAL DATA

Electrical Rating:

- 20 to 30 VAC 50/60 Hz. or D.C.
- 0.05 to 1.0 Amps (Load per terminal)
- 1.5 Amps Maximum Total Load** (All terminals combined)

THERMAL DATA

Setpoint Temperature Range:

45°F to 90°F (7°C to 32°C)

Operating Ambient Temperature Range:

32°F to 105°F

Operating Humidity Range:

0 to 90% RH (non-condensing)

Shipping Temperature Range:

-4°F to 149°F

APPLICATIONS

For use with:

- Standard heat pump systems with electric, gas or oil Aux heat with 24 VAC HOT and COMMON available
- Single-stage heat pump systems with no Aux heat with 24 VAC HOT and COMMON available

DO NOT USE WITH:

- Millivolt systems
- Systems exceeding 30 VAC and 1.5 amps
- 3-wire zoned hydronic heating systems

INSTALLATION

REMOVE OLD THERMOSTAT

1. Shut off electricity at the main fuse box until installation is complete. Ensure that electrical power is disconnected.
2. Remove the front cover of the old thermostat. **With wires still attached**, remove wall plate from the wall. If the old thermostat has a wall mounting plate, remove the thermostat and the wall mounting plate as an assembly.
3. **Identify each wire attached to the old thermostat using the labels enclosed with the new thermostat.**
4. Disconnect the wires from old thermostat one at a time. **DO NOT LET WIRES FALL BACK INTO THE WALL.**
5. Install new thermostat using the following procedures.

ATTENTION!

This product does not contain mercury. However, this product may replace a unit which contains mercury.

Do not open mercury cells. If a cell becomes damaged, do not touch any spilled mercury. Wearing nonabsorbent gloves, take up the spilled mercury and place into a container which can be sealed. If a cell becomes damaged, the unit should be discarded.

Mercury must not be discarded in household trash. When the unit this product is replacing is to be discarded, place in a suitable container. Refer to www.thermostat-recycle.org for location to send product containing mercury.

ATTACH THERMOSTAT BASE TO WALL

1. Remove the packing material from the thermostat. Gently pull the cover straight off the base. Forcing or prying on the thermostat will cause damage to the unit.
2. Connect wires beneath terminal screws on base using appropriate wiring schematic (see figs. 2 through 4).
3. Place base over hole in wall and mark mounting hole locations on wall using base as a template.
4. Move base out of the way. Drill mounting holes.
5. Fasten base loosely to wall, as shown in fig. 1, using two mounting screws. Place a level against bottom of base, adjust until level, and then tighten screws. (Leveling is for appearance only and will not affect thermostat operation.) If you are using existing mounting holes, or if holes drilled are too large and do not allow you to tighten base snugly, use plastic screw anchors to secure subbase.
6. Push excess wire into wall and plug hole with a fire-resistant material (such as fiberglass insulation) to prevent drafts from affecting thermostat operation.

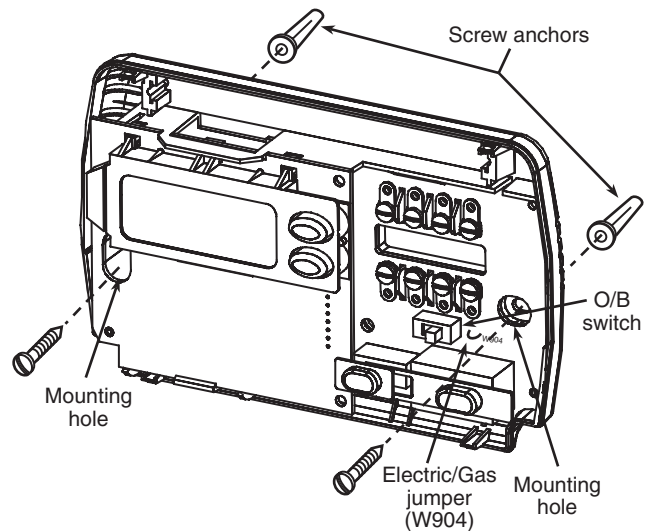

Figure 1. Thermostat Base

ELECTRIC/GAS JUMPER (Fan Option)

Read the following information before clipping the nonelectric heat jumper. If you are unsure of your application, contact a qualified service person.

If your emergency or auxiliary system will energize the blower, then jumper, W904, on the thermostat base must be cut (see fig. 1).

If your emergency or auxiliary heat system requires that the thermostat energize the fan circuit, do not cut jumper W904.

OPTIONAL BATTERIES

With two "AA" batteries installed, your thermostat will continuously display the temperature during a loss of AC power.

O/B TERMINAL SWITCH SELECTION

The O/B switch on this thermostat is factory set to the "O" position. This will accommodate the majority of heat pump applications, which require the changeover relay to be energized in COOL. If the thermostat you are replacing or the heat pump being installed with this thermostat requires a "B" terminal, to energize the changeover relay in HEAT, the O/B switch must be moved to the "B" position.

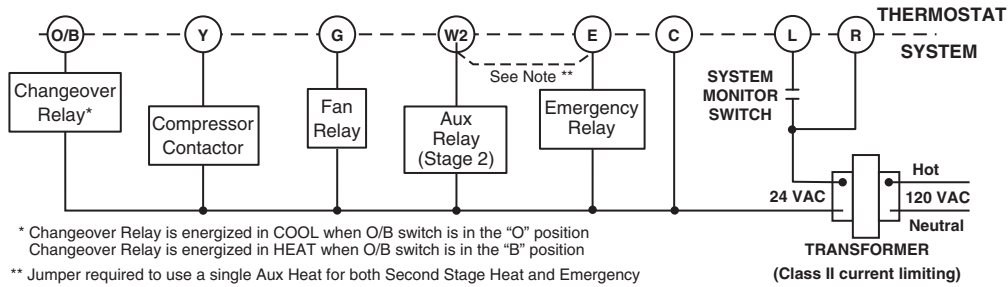

Figure 2. Typical wiring diagram for single transformer systems

NOTE
If safety circuits are in only one of the systems, remove the transformer of the system with **NO** safety circuits.

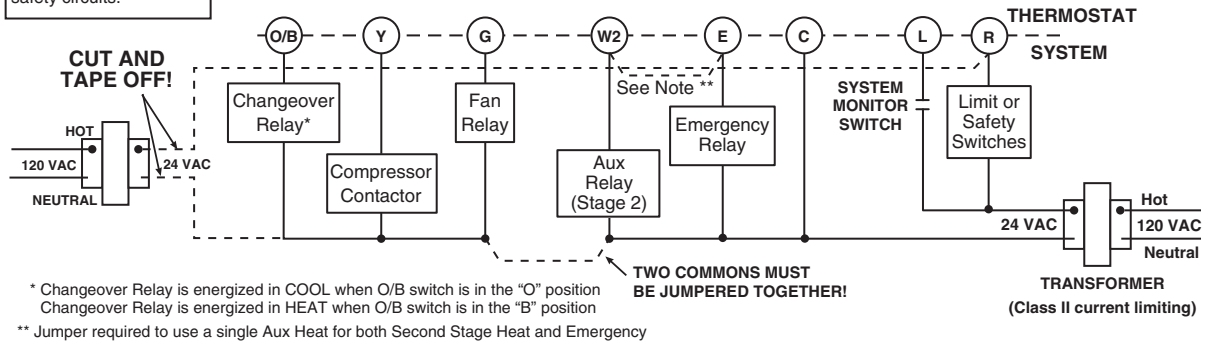

Figure 3. Typical wiring diagram for two transformer systems with NO safety circuits

NOTE
Polarity must be observed. If the HOT side of the second transformer is jumpered to the COMMON side of the first transformer a short will be made. Damage to equipment will occur when power is restored.

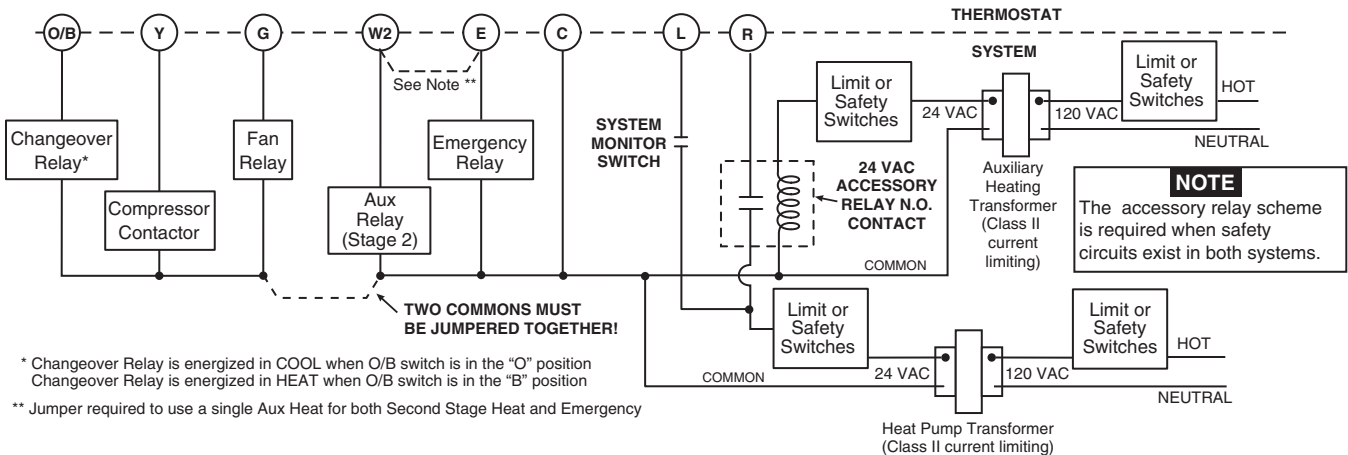

Figure 4. Typical wiring diagram for two transformer systems with safety circuits in BOTH systems

CHECK THERMOSTAT OPERATION

If at any time during testing your system does not operate properly, contact a qualified service person.



Turn on power to the system.

Fan Operation

If your system **does not** have a **G** terminal connection, skip to **Heating System**.



1. Move fan switch to **ON** position. The blower should begin to operate.
2. Move fan switch to **AUTO** position. The blower should stop immediately.

Heating System

1. Move SYSTEM switch to **HEAT** position. If the auxiliary heating system has a standing pilot, be sure to light it.
2. Press  to adjust thermostat setting to 1° above room temperature. The Heat Pump system should begin to operate. However, if the **Flame icon** (Δ) and **Snowflake icon** (✱) are flashing, the compressor lockout feature is operating.
3. Adjust temperature setting to 4° above room temperature. The auxiliary heat system should begin to operate and the **Flame icon** will be flashing.
4. Press  to adjust temperature setting below room temperature. The heating system should stop operating.

Emergency System



EMER bypasses the Heat Pump to use the heat source wired to terminal E on the thermostat. EMER is typically used when compressor operation is not desired, or you prefer back-up heat only.

1. Move SYSTEM switch to EMER position. EMER will flash on the display.
2. Press  to adjust the thermostat above room temperature. The Aux heating system will begin to operate. The **flame icon** (Δ) will display flashing to indicate that the Aux system is operating.
3. Press  to adjust the thermostat below room temperature. The Aux heating system should stop operating.

Cooling System

⚠ CAUTION

To prevent compressor and/or property damage, if the outdoor temperature is below 50°F, DO NOT operate the cooling system.

1. Move SYSTEM switch to **COOL** position.
2. Press  to adjust thermostat setting below room temperature. The blower should come on immediately on high speed, followed by cold air circulation.
3. Press  to adjust temperature setting above room temperature. The cooling system should stop operating.

⚠ CAUTION

Do not allow the compressor to run unless the compressor oil heaters have been operational for 6 hours and the system has not been operational for at least 5 minutes.

THERMOSTAT QUICK REFERENCE

Before you begin using your thermostat, you should be familiar with its features and with the display and the location and operation of the thermostat buttons. Your thermostat consists of two parts: the **thermostat cover** and the **base**. To remove the cover, pull it straight out from the base. To replace the cover, line up the cover with the base and press until the cover snaps onto the base.

THE THERMOSTAT BUTTONS AND SWITCHES

(see fig. 5)

- ① Raises temperature setting.
- ② Lowers temperature setting.
- ③ FAN switch (**ON**, **AUTO**).
- ④ SYSTEM switch (**COOL**, **OFF**, **HEAT**, **EMER**).

THE DISPLAY

- ⑤ **Flame icon** (Δ) is displayed when the SYSTEM switch is in the HEAT position. **Flame icon** (Δ) is displayed flashing when 2nd-stage heat (Aux or Emergency) is energized. **Snowflake icon** (✱) is displayed (non-flashing) when the SYSTEM switch is in the COOL position. **Snowflake** and **Flame** are displayed (flashing) if the thermostat is in lockout mode to prevent the compressor from cycling too quickly.
- ⑥ Indicates a malfunction with the system.
- ⑦ Displays current temperature.
- ⑧ **EMER** is displayed flashing when the system switch is in EMER position.

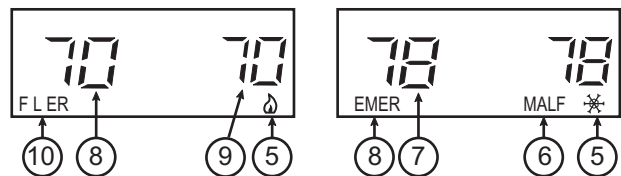
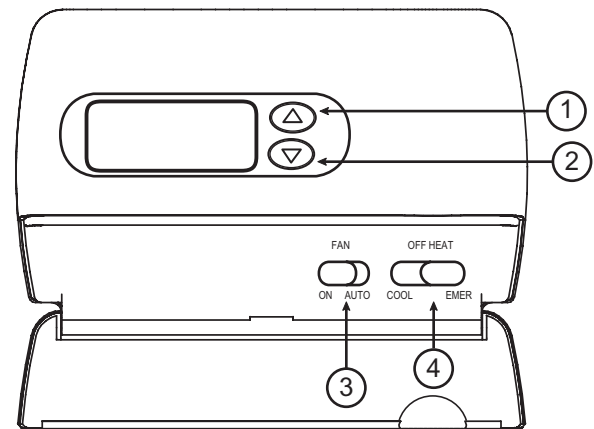



Figure 5. Thermostat display, buttons, and switches

- ⑨ Displays current set temperature (this is blank when SYSTEM switch is in the OFF position).
- ⑩ Displays **FILTER** when the system has run for the programmed filter time period as a reminder to change or clean.



INSTALLER/CONFIGURATION MENU

CONFIGURATION MENU





















The configuration menu allows you to set certain thermostat operating characteristics to your system or personal requirements.



Move SYSTEM switch to the OFF position, then press  and  at the same time to enter the configuration menu. The display will show the first item in the configuration menu.

The configuration menu chart summarizes the configuration options. An explanation of each option follows.

Press  and  to change to the next menu item. To exit the menu, move the SYSTEM switch to HEAT or COOL. If no keys are pressed within fifteen minutes, the thermostat will exit the configuration menu.

Configuration Menu

Step	Press Button(s)	Displayed (Factory Default)	Press  or  to select:	COMMENTS
1	Set SYSTEM switch to OFF			SYSTEM switch must be OFF to configure thermostat options
2	 and 	  (SL)	FA	Select FA or SL (Fast or Slow) pump cycle rate
3	 and 	EMER (FA)	SL	Select FA or SL (Fast or Slow) Auxiliary and Emergency Aux heating cycle rate
4	 and 	d-L (on)	OFF	Select display backlight OFF or ON
5	 and 	Filter (000)	0 to 1950 hours (in 50 hour increments)	Select filter replacement run time
6	 and 	LOC (OFF)	on	Select Compressor lockout OFF or ON
7	 and 	0 HI (0)	4 LO to 4 HI	Select temperature display adjustment higher or lower
8	 and 	(F)	C	Select temperature display to F or C
9	 and 	FA (on)	OFF	Select fast second-stage ON or OFF
10	Set SYSTEM switch to HEAT or COOL			Returns to normal operation

- 2) **Select FA or SL (Fast or Slow) Heat Pump stage Cycle Rate** - The FA setting is used to produce shorter heating cycles. The SL setting produces a longer heating/cooling cycle. Both settings produce very accurate temperature control and can be set to your personal preference. FA cycles the system just under .75°F and the SL setting cycles at approximately 1.2°F.
- 3) **Select FA or SL (Fast or Slow) Auxiliary or Emergency Cycle Rate** - The FA setting is frequently used for gas, oil or electric heat. The SL setting produces a longer heating cycle. Both settings produce very accurate temperature control and can be set to your personal preference. FA cycles the system just under .6°F and the SL setting cycles at approximately 1.°F.
- 4) **Select backlit display (d-L OFF or ON)** - The display backlight improves display contrast in low lighting conditions. Selecting backlight ON will keep the light on continuously. Selecting OFF will keep the light off.
- 5) **Select filter replacement run time** - The thermostat will display **FILTER** after a set time of operation. This is a reminder to change or clean your air filter. This time can be set from 0 to 1950 hours in 50 hour increments. **A selection of 000 will cancel this feature.** When **FLTR** is displayed, you can clear it by pressing  and  at the same time. This resets the timer and starts counting the hours until the next filter change. Contact your heat pump manufacturer for a specific replacement/maintenance interval.
- 6) **Select Compressor Lockout (LOC OFF or ON)** - Selecting LOC ON will cause the thermostat to wait 5 minutes before

turning on the compressor if the heating and cooling system loses power. It will also wait 5 minutes minimum between cooling cycles. This is intended to help protect the compressor from short cycling. Some newer compressors already have a time delay built in and do not require this feature. Your compressor manufacturer can tell you if the feature is already present in their system. When the thermostat compressor time delay occurs it will flash the **Snowflake** or **Flame** icon for about five minutes.

- 7) **Select Temperature Display Adjustment (4 LO to 4 HI)** - Allows you to adjust the room temperature display up to 4° higher or lower. Your thermostat was accurately calibrated at the factory but you have the option to change the display temperature to match your previous thermostat. The current or adjusted room temperature will be displayed on the right side of the display.
- 8) **Select Temperature Display (°F or °C)** - Changes the display readout to Celsius or Fahrenheit as required. The current room temperature will be displayed on the right side of the display.
- 9) **Select Fast second stage** - In the RUN mode, if the temperature is manually raised by 3°F (2°C) or more above room temperature using  and the fast second stage feature is enabled, FA on, the second stage will energize immediately. With FA off, the second stage will not energize until the setpoint temperature is 10°F or more above room temperature.



OPERATION

OPERATING FEATURES

Now that you are familiar with the thermostat buttons and display, read the following information to learn about the many features of the thermostat.

- **SIMULTANEOUS HEATING/COOLING SETPOINT STORAGE** — You can enter both your heating and cooling setpoints at the same time. There is no need to change the thermostat at the beginning of each season.
- **CONFIGURATION MENU** — Allows you to customize certain thermostat options.



SETTING THE THERMOSTAT

This thermostat is very easy to operate. Set the SYSTEM switch to either HEAT or COOL then press  and  until the temperature you want to maintain is shown on the right side of the display. If you want to turn the system off, just move the SYSTEM switch to OFF.

The FAN switch controls the fan operation. When the FAN switch is set to AUTO, the fan will cycle with the furnace or air conditioner. When the FAN switch is set to ON, the fan will run continuously, regardless of SYSTEM switch position.

TROUBLESHOOTING

Reset Operation

If a voltage spike or static discharge blanks out the display or causes erratic thermostat operation you can reset the thermostat by changing the system from Off to Heat while pressing ,  at the same time. If the thermostat has power, has been reset and still does not function correctly contact your heating/cooling service person or place of purchase.

Symptom	Possible Cause	Corrective Action
No Heat/No Cool/No Fan (common problems)	<ol style="list-style-type: none"> 1. Blown fuse or tripped circuit breaker. 2. Furnace power switch to OFF. 3. Furnace blower compartment door or panel loose or not properly installed. 	Replace fuse or reset breaker. Turn switch to ON. Replace door panel in proper position to engage safety interlock or door switch.
No Heat	<ol style="list-style-type: none"> 1. System Switch not set to Heat. 2. Loose connection to thermostat or system. 3. Heating System requires service or thermostat requires replacement. 	Set System Switch to Heat and raise setpoint above room temperature. Verify thermostat and system wires are securely attached. Diagnostic: Set System Switch to Heat and raise the setpoint above room temperature. Within five minutes the thermostat should make a soft click sound. This sound usually indicates the thermostat is operating properly. If the thermostat does not click, try the reset operation listed above. If the thermostat does not click after being reset contact your heating and cooling service person or place of purchase for a replacement. If the thermostat clicks, contact the furnace manufacturer or a service person to verify the heating system is operating properly.
No Cool	<ol style="list-style-type: none"> 1. System Switch not set to Cool. 2. Loose connection to thermostat or system. 3. Cooling System requires service or thermostat requires replacement. 	Set System Switch to Cool and lower setpoint below room temperature. Verify thermostat and system wires are securely attached. Same procedure as diagnostic for No Heat condition except set the thermostat to Cool and lower the setpoint below the room temperature. There may be up to a five minute delay before the thermostat clicks in Cooling if the compressor lock-out option is selected in the configuration menu (Item 6).
Heat, Cool or Fan Runs Constantly	<ol style="list-style-type: none"> 1. Possible short in wiring. 2. Possible short in thermostat. 3. Possible short in Heat/Cool/Fan system. 4. Fan Switch set to Fan On. 	Check each wire connection to verify they are not shorted or touching together. No bare wire should stick out from under terminal screws. Try resetting the thermostat as described above. If the condition persists, the manufacturer of your system or service person can instruct you on how to test the Heat/Cool system for correct operation. If the system operates correctly, replace the thermostat.
Furnace Cycles Too Fast or Too Slow (narrow or wide temperature swing)	<ol style="list-style-type: none"> 1. The location of the thermostat and/or the size of the Heating System may be influencing the cycle rate. 	Item 2 in the Configuration Menu is the adjustment that controls the cycle rate. If an acceptable cycle rate is not achieved using the FA (Fast) or SL (Slow) adjustment contact a local service person for additional suggestions.
Cooling Cycles Too Fast or Too Slow (narrow or wide temperature swing)	<ol style="list-style-type: none"> 1. The location of the thermostat and/or the size of the Cooling System may be influencing the cycle rate. 	The cycle rate for cooling is fixed and can not be adjusted. Contact a local service person for suggestions.
Thermostat Setting and Thermometer Disagree	<ol style="list-style-type: none"> 1. Thermostat thermometer setting requires adjustment. 	The thermometer can be adjusted +/- 4 degrees as listed in item 7 of the Configuration Menu. No other adjustment is possible.
Blank Display and/or Keypad Not Responding	<ol style="list-style-type: none"> 1. Loss of power. 2. Voltage Spike or Static Discharge. 	Check heat/cool system for power. If a voltage spike or static discharge occurs use the Reset Operation listed above.

NOTES

HOMEOWNER HELP LINE: 1-800-284-2925

White-Rodgers is a business
of Emerson Electric Co.

The Emerson logo is a
trademark and service mark
of Emerson Electric Co.

White-Rodgers™

www.white-rodgers.com
www.emersonclimate.com

EMERSON™
Climate Technologies