

CLICK ANYWHERE on THIS PAGE to RETURN to RADIANT HEAT INFORMATION at InspectApedia.com

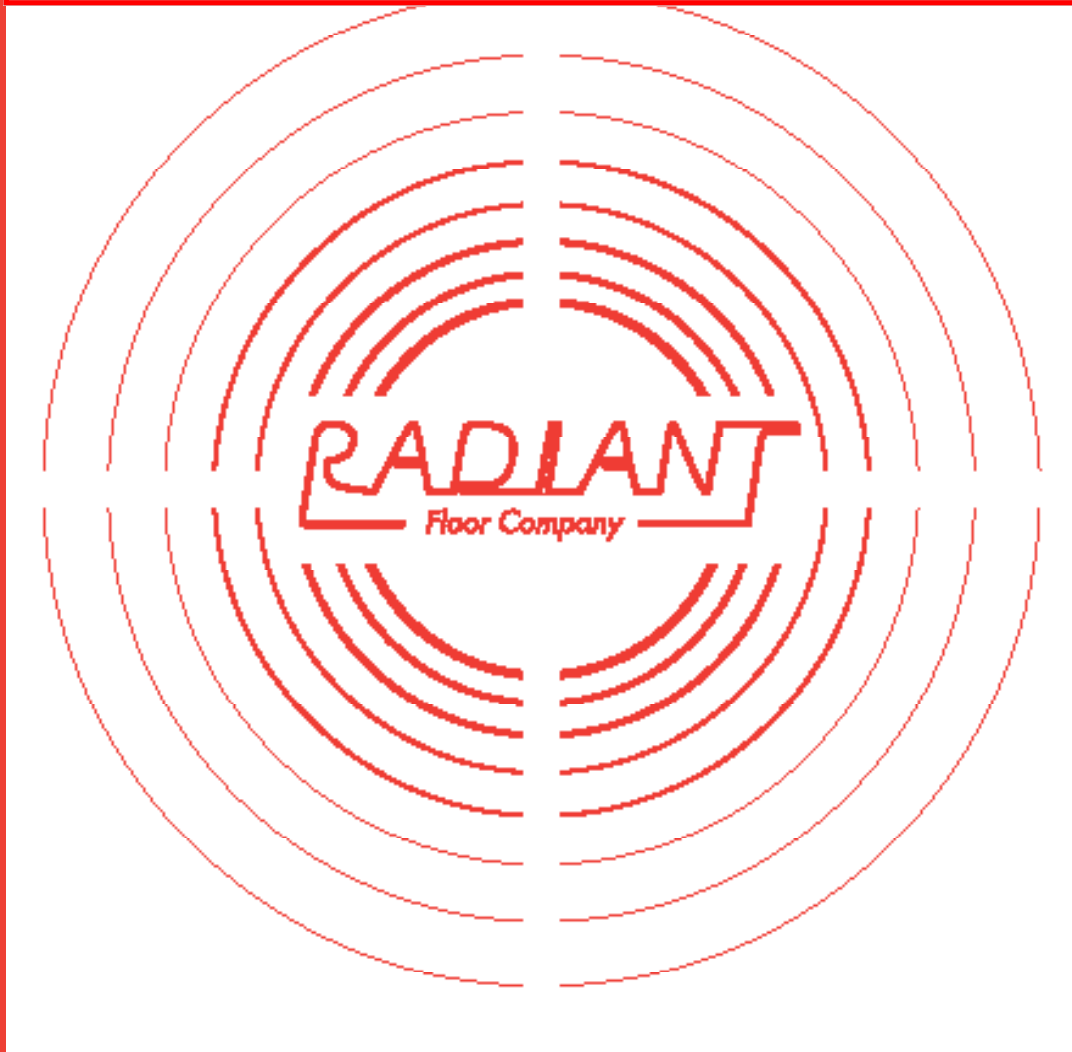

Design & Installation Manual

Contents

Pg. 2 INTRODUCTION
Pg. 2 SECTION 1
Pg. 3 TYPES OF RADIANT SYSTEMS
Pg. 9 HEATING YOUR WATER
Pg. 17 .. SECTION 2
Pg. 17 .. SLAB ON GRADE INSTALLATION
Pg. 21 .. THE SUSPENDED SLAB
Pg. 23 .. THE LEDGER METHOD
Pg. 24 .. THE FLOOR JOIST INSTALLATION
Pg. 32 .. FILLING THE RADIANT SYSTEM
pg. 35 .. RADIANT DICTIONARY

1 1th Edition

Introduction

This installation manual is written in two sections. The first part contains a general overview of radiant heat and its various applications. All the necessary components of a well-engineered and efficient hydronic radiant floor system are explained in a straight forward and non-technical manner. The second section gets down to the nitty gritty details of actual radiant floor installations. After reading this manual, you should have a clearer understanding of why radiant heat is considered the most efficient, cost-effective method of providing your home or business with state of the art heating.

SECTION 1

Getting Heat Into Your Home

Radiant heat is actually an old technology. It's common knowledge that the ancient Romans used it to heat their public baths. In more modern times, the Europeans have relied upon radiant heat for over 60 years. In fact, it was servicemen returning from World War II who first spread the word about underfloor heat to their fellow Americans. Many radiant floors, most using copper tubing buried within concrete slabs, were installed and used successfully in the 1960's and 70's. But they all suffered from one primary problem...longevity. Copper within concrete is highly susceptible to corrosion and a lifespan of 50 years for a radiant floor was considered exceptional. Today, modern plastics not only share many of the heat emitting properties of copper, but also provide greater flexibility, corrosion resistance, and a lifespan of over 100 years. Of these modern plastics, cross-linked polyethylene is by far the best and most commonly used material. Below is a photo of our most versatile and highest output tubing. With 7/8" XL PEX you can expect a heat output of at least 50 BTU's per foot in a slab on grade installation and 40 BTU's per foot in a floor joist application. It is potable and ultraviolet resistant for protection against sun damage during installation.



The 7/8" Durapoly XL PEX is a large diameter tubing with the same wall thickness as the commonly used 1/2" PEX. It's main advantage over 1/2" PEX lies in the fact that it holds more fluid, and consequently, more heat. It has a slightly lower temperature and pressure rating than 1/2" PEX, but it can be spaced as far apart as 16" on center and still heat a room insulated to modern standards (R-19 walls, R-27 ceilings). It would take twice as much 1/2" PEX to do the same job.

That makes 7/8" ID PEX the first choice for any application where it can be feasibly used. It is ideal for joists bays spaced 12", 16", or 24" on center, or virtually any slab on grade installation. It is the only **cross-linked** 7/8" PEX tubing on the market and its bending diameter is less than 20", making it easy to thread through floor joists. This flexibility factor makes 7/8" PEX much less prone to kinking than other 7/8" PEX tubings. Also, minimum tubing is required to gain maximum heating results. That saves money on materials and time.

The 1/2" ID PEX is also a polyethylene tubing with a very high temperature and pressure rating (180 degrees at 100 psi). It emits about half the heat of the 7/8" PEX, but its bending diameter is tighter. Using 1/2" PEX for small zones, tight crawl spaces, or snowmelt applications makes sense. It has a bending diameter of 15" and should be spaced 8" to 12" on center.

Various other types of tubing such as rubber, soft copper, polybutylene, or even plain, so-called "High Density Polyethylene" (not cross-linked) are used for radiant heat. But the limited longevity of rubber, the difficulty and expense of installing copper, past problems with polybutylene, and the tendency of plain polyethylene to shrink and crack in high temperature applications, make PEX the tubing of choice.

What is Cross-Linking?

According to the Radiant Panel Association, cross-linking is: "a three dimensional molecular bond created within the structure of the plastic which dramatically improves a large number of properties such as heat deformation, abrasion, chemical and stress crack resistance. Impact and tensile strength are increased, shrinkage decreased and low temperature properties improved. Cross-linked tubes also have a shape memory which only requires the

addition of heat to return it to its original shape when kinked”.

There are three types of cross-linking: **electron**, **peroxide**, and **silane**. Radiant Floor Company’s 7/8” PEX tubing is cross-linked with the electron process. It’s the cleanest, most environmentally friendly of the three methods. If you’re interested in a more detailed technical explanation of the various cross-linking processes, try this link:

[“http://www.radiantpanelassociation.org/public/articles/details.cfm?id=14”](http://www.radiantpanelassociation.org/public/articles/details.cfm?id=14)

If you’d like to see a graphic demonstration of how cross-linked Polyethylene differs from non-cross-linked Poly tubing, see the photos below.



The tubing on the left is black because the Polyethylene contains a 2% carbon element for ultraviolet protection.

The milky tubing on the right is a 7/8” ID “natural” High Density Polyethylene. It is not cross-linked, nor does it contain the pigment necessary for ultraviolet resistance. The 7/8” XL PEX in the middle is both cross-linked and UV protected.



The Oven Test

The cross-linking process greatly increases the pressure and temperature characteristics of the Poly tubing. When all three tubes were subjected to 30 minutes of 250 degree temperatures, only the PEX survived the experience

Types of Radiant Systems

It’s obvious that PEX tubing is the current industry standard. The question now becomes: What is the best way to send heated fluid through the tubing to heat my floor? There are three main methods.

Of course, as with all construction projects, consult with your local building department to guarantee conformity with local codes.

The Open System

This system uses one heat source, your domestic water heater, to provide both floor heating and domestic hot water. The two systems are basically tied together. The same water that ends up in your hot shower or dishwasher, for example, has passed through the floor first. This is a very efficient system because one heat source is doing all the work. As long as the water heater is sized appropriately and matches your heating and domestic requirements, the need for a “separate” heating system is eliminated.

Why is cold water entering the radiant system from the domestic supply?

Looking at the open system schematic you’ll notice that cold water from your domestic supply enters the water heater via the floor tubing. We plumb the radiant system this way so that there’s never any chance of stagnant water entering your domestic system. Fresh water enters the tubing every time you use hot water.

And although it looks at first glance as if cold water will be cooling down your floor, in reality that won’t happen. The only cold water that can enter the tubing will be the “make up” water to your water heater. If no hot water valves are open in your domestic system, the radiant system is essentially “closed”. In other words, cold water cannot enter the system unless it has somewhere to flow....an open hot water valve in the house somewhere. Without an open hot water valve, only the circulator pump supplying the radiant tubing can force water from the water heater into the tubing, and back, when your zone calls for heat.

So, when you use hot water, cold water enters the water heater via the floor. This assures that fresh water can always flow through the system, even in the summer. Keep in mind that any hot water displaced by the cold make-up water eventually works it’s way to the water heater, so there’s no net energy loss. And due to the large thermal mass in the floor, the small amount of cold make-up water entering the tubing has no chance of cooling down the floor....unless of course you were to take a four hour shower. That’s not likely. Also remember that if the thermostat in the zone is calling

for heat at the same time you're using hot water, then the circulator pump will still be pumping hot water through the loops and the net result will be warm water entering the tubing instead of cold. By the way, one of the easiest and least expensive ways to protect components in open systems, to say nothing of the home's plumbing fixtures, is through the use of a whole house filter. Common canister-type housings are available at any hardware store and a 20 micron filter will effectively remove silt and other particles from the home's incoming water.

But if the radiant circulators are running, will the floor steal hot water from my shower?

No. That's because our circulators are very low wattage, non self priming pumps. They can stir water around a radiant system, but they can't compete with normal domestic water pressure. As a result, domestic hot water uses always take precedence.

The Closed System



Three zone closed system

SINGLE ZONE OPEN SYSTEM Using On-Demand Water Heater

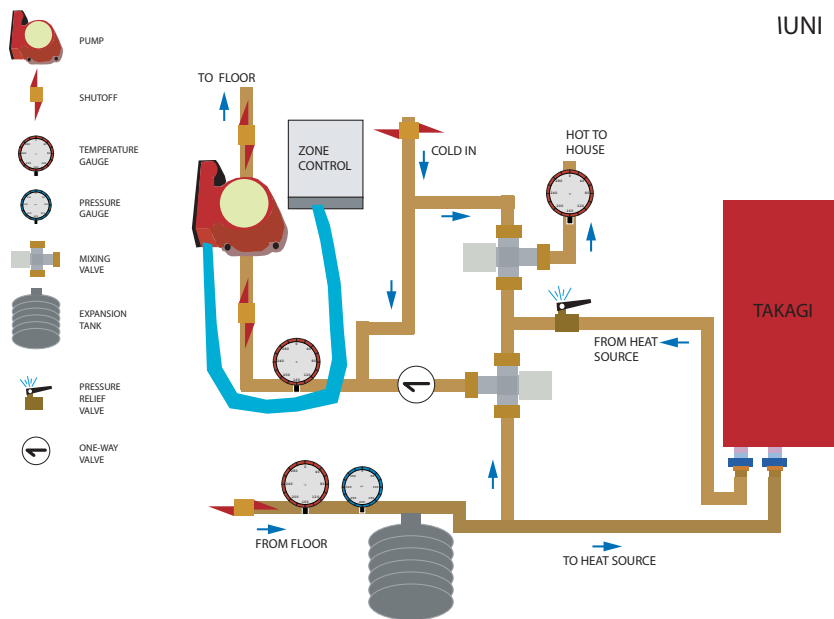

IUNI

This approach utilizes a dedicated heat source for the radiant floor. The fluid in a closed system is re-circulated around and around in a completely closed loop. There is no connection whatsoever to the domestic water supply. The main advantage to this system lies in the fact that, being closed, anti-freeze instead of water can be used as the heat transfer medium. The percentage of Propylene Glycol anti-freeze is determined by the type of heat source (on-demand heater or tank type) and by the guidelines listed on the anti-freeze container. Closed systems are often used in second homes or primary residences in areas prone to long power outages. If freeze protection is an issue, than a closed system with anti-freeze is a good idea.

The down side is two heat sources. All water heaters waste heat energy, even when the burner is off and the unit is sitting idle between heating cycles. Granted, the unit dedicated to heating the floor only wastes heat during the winter months. But standby losses for six months out of every year can add up. The other consideration is efficiency. Two low or moderately efficient water heaters are much more costly to run than one high-efficiency unit.

Radiant floors, one or several zones, are often added to existing hot water baseboard or cast iron radiator systems.

OPEN SYSTEM Using Tankless Water Heater

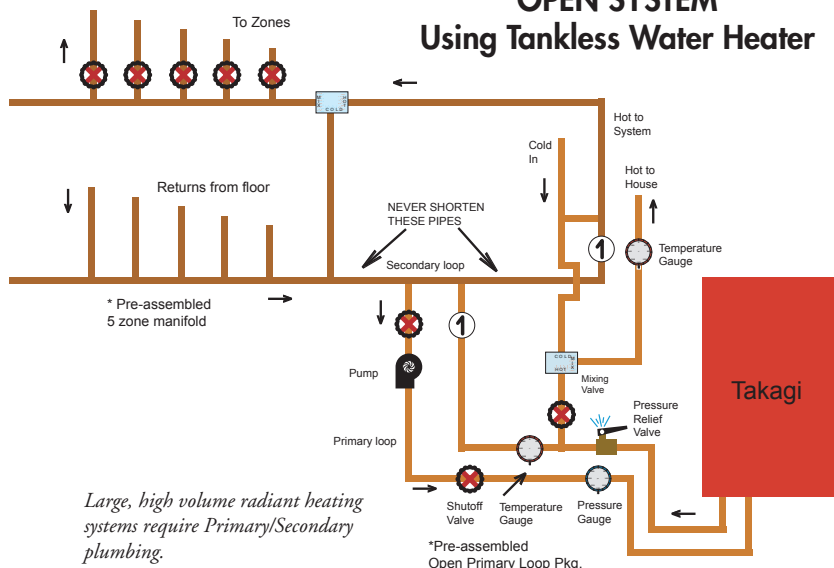

CLOSED SYSTEM

(for use with a water heater setup)

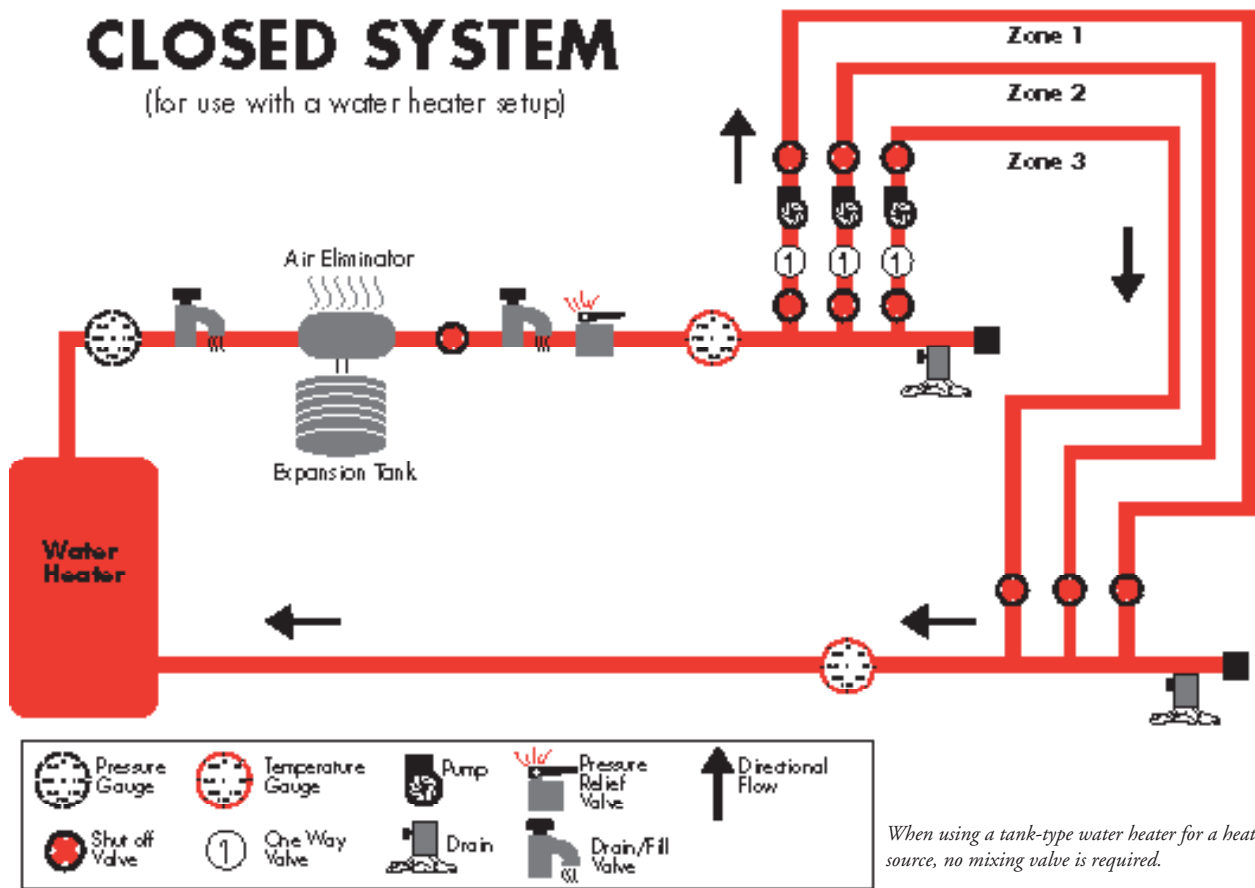

CLOSED SYSTEM

(for use with a Boiler setup)

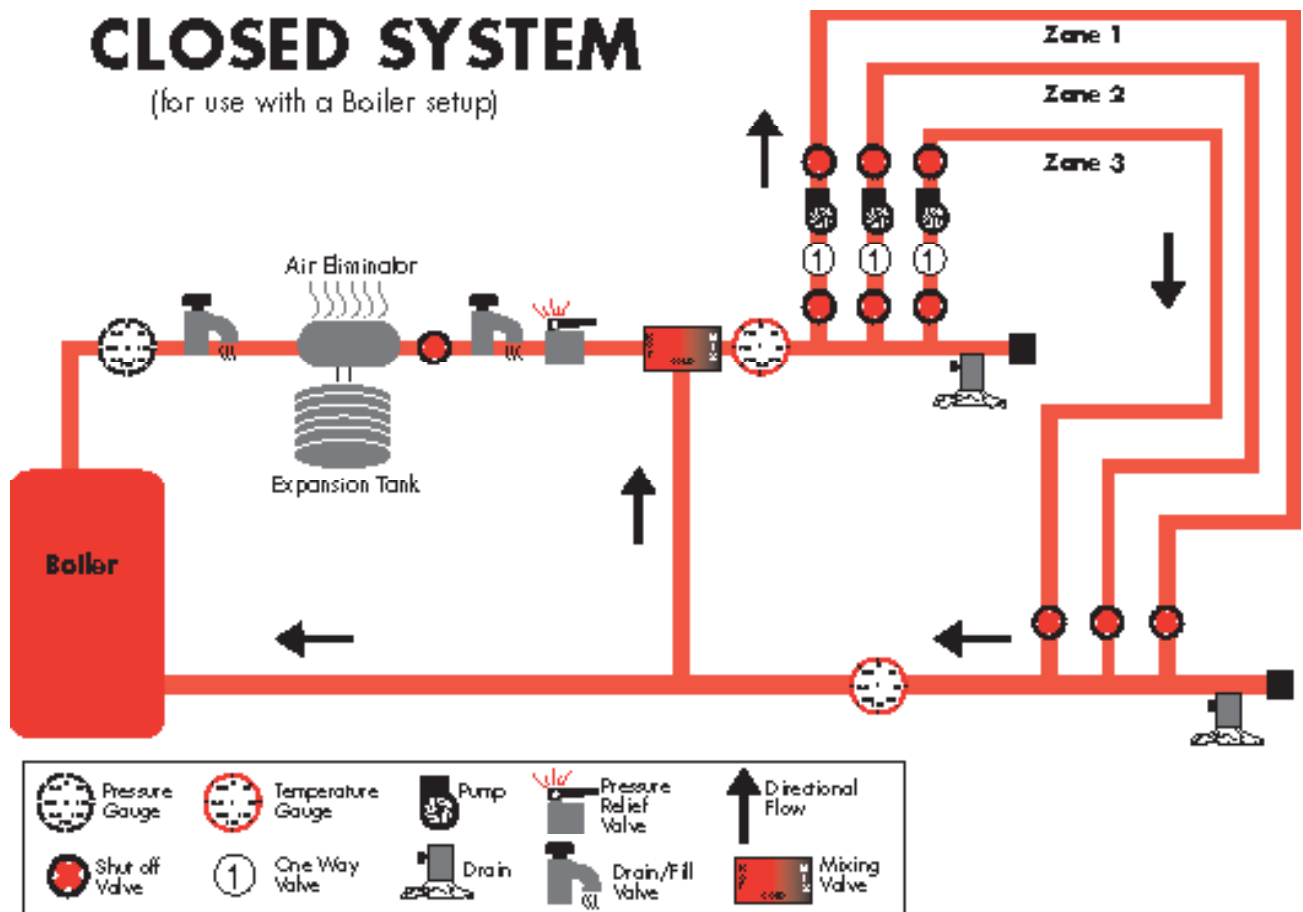



Adding a single radiant zone to an existing boiler is easy with our pre-plumbed and pre-wired "Radiant Ready" installation package.

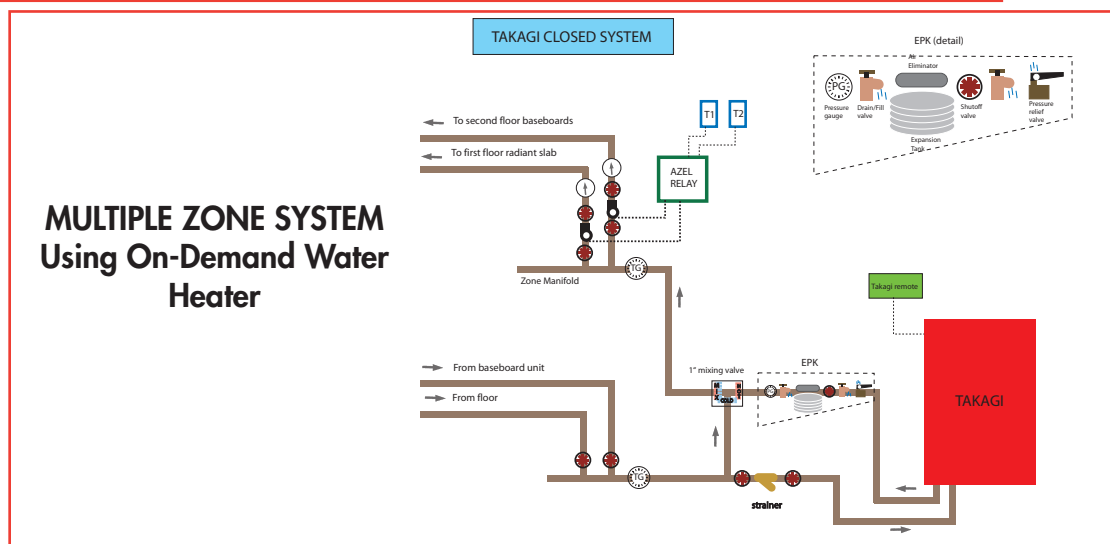
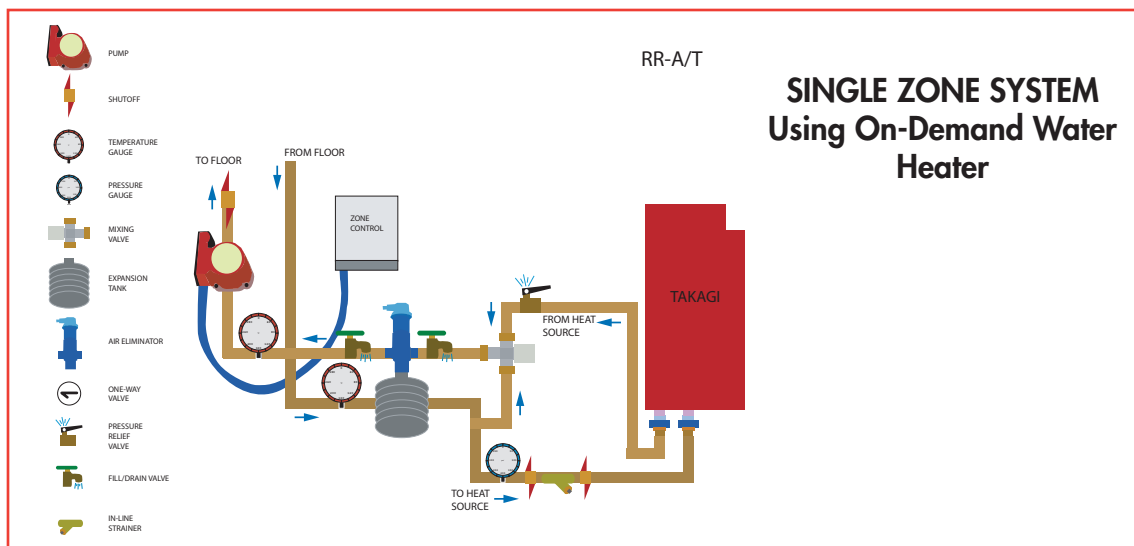

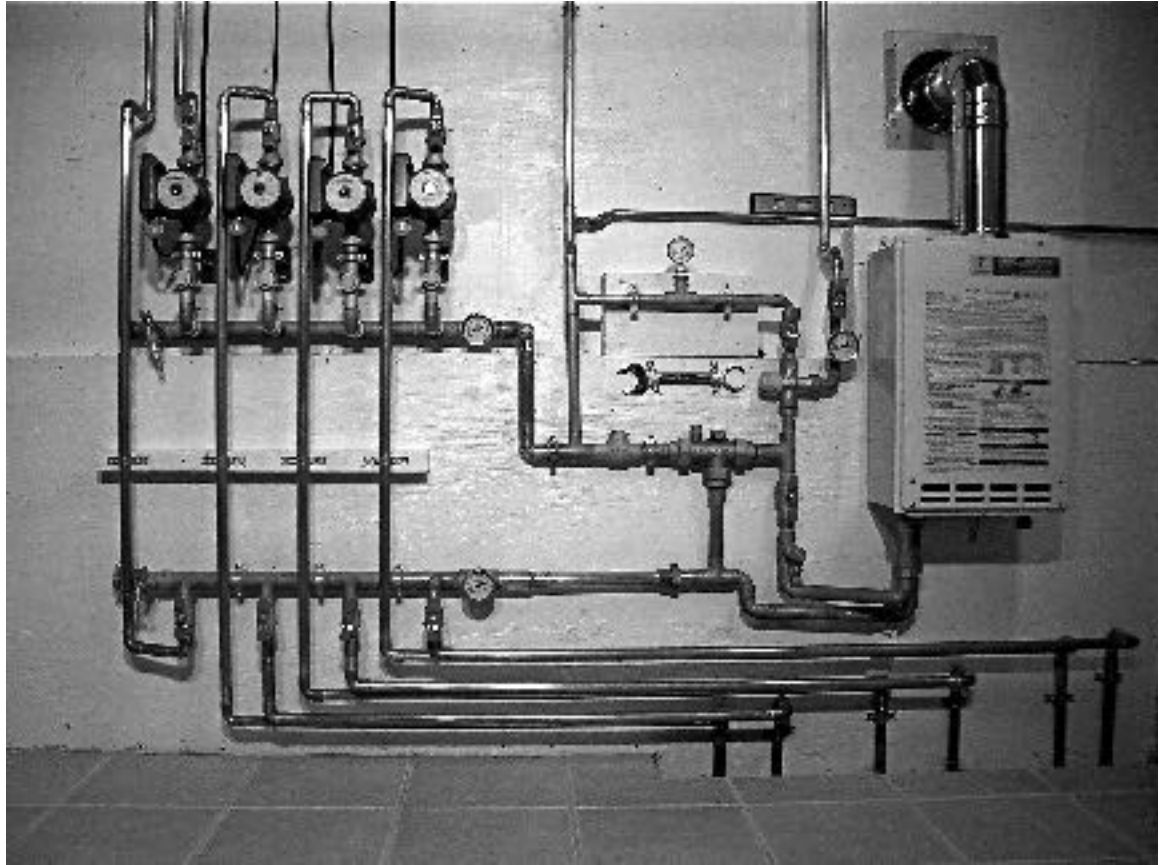

Some do-it-yourselfers create art with our installation packages. The above example uses a Takagi on-demand water heater to provide both domestic hot water and four zones of space heating



Over a mile of 7/8" PEX was installed in the floor of this state of the art dog kennel in northern Vermont. A 50 gallon, 199,000 BTU/hr., Polaris water/space heater powers a four zone open system and provides the kennel's domestic hot water.....all at 95% efficiency!

HEAT EXCHANGER

w/ STANDARD DOMESTIC WATER HEATER

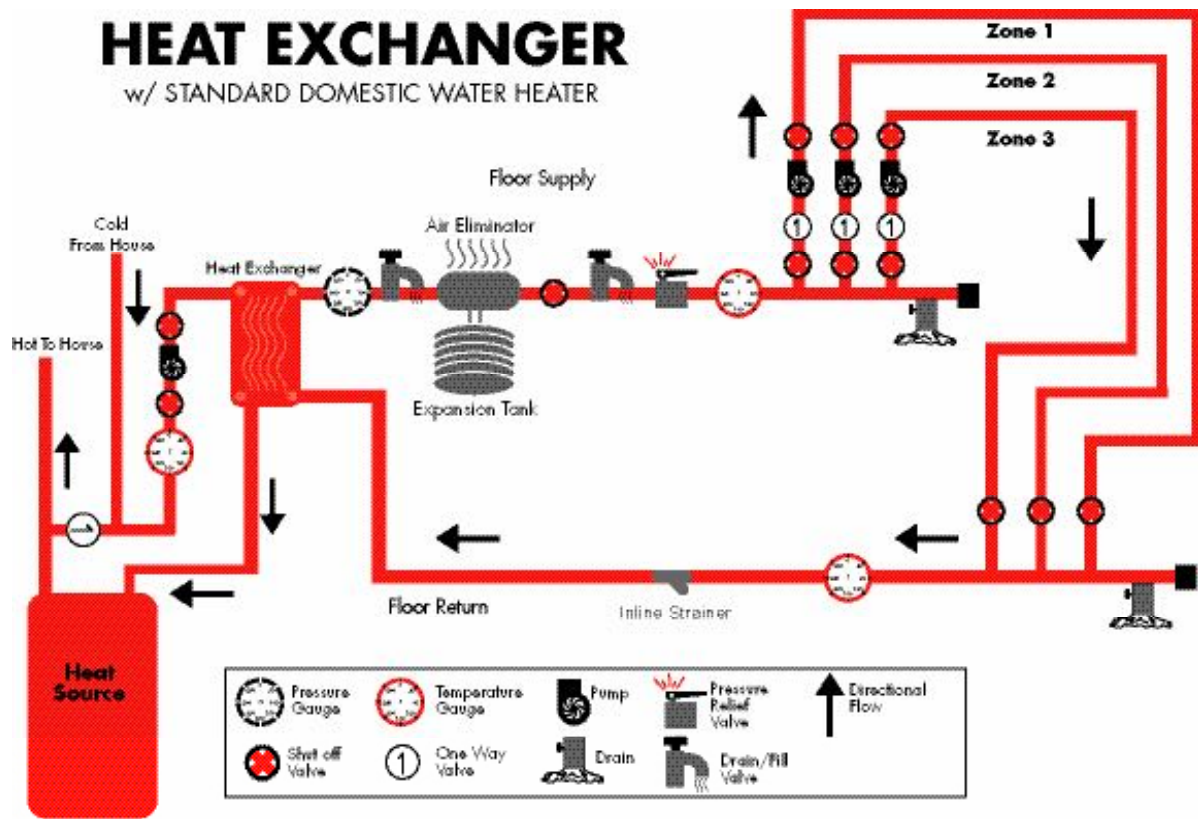

Heat Exchanger System w/ multiple zones

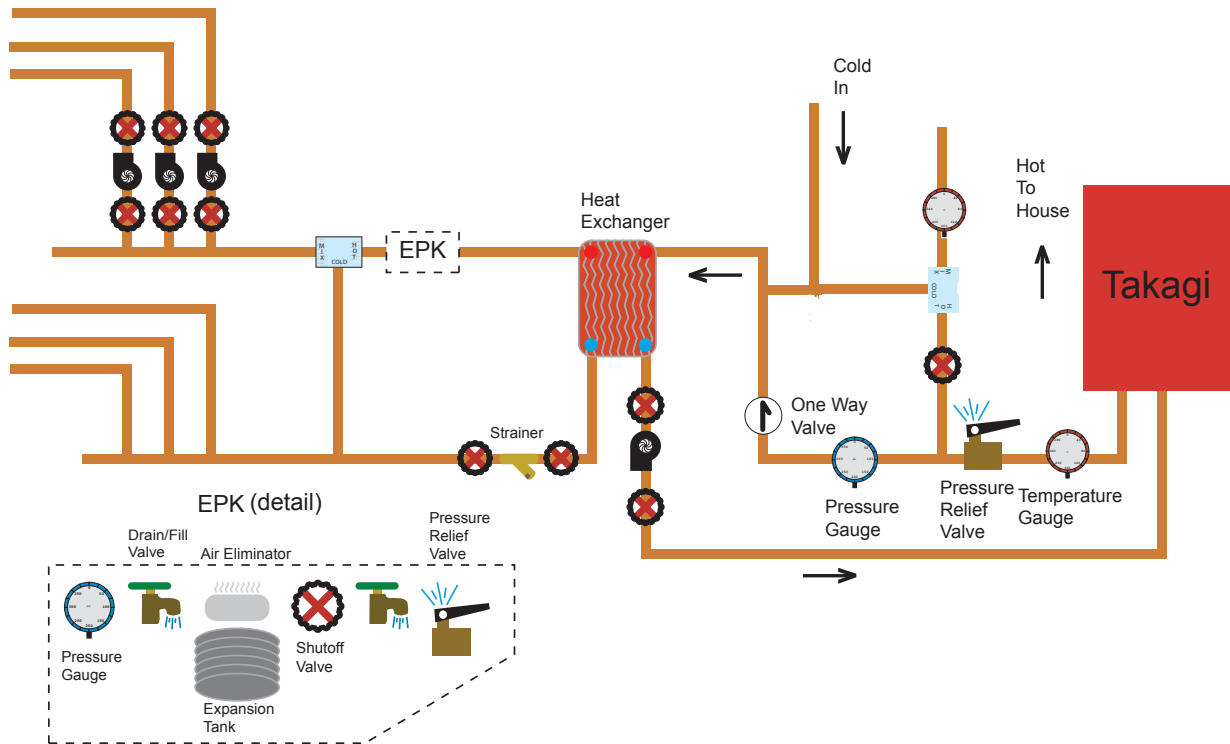

The Heat Exchanger System

This system uses an efficient heat exchanger to separate the potable domestic water supply from the floor's anti-freeze mixture. Only one heat source is used and the benefits of freeze protection can be fully utilized.

However, always ask yourself, "Do I really need a heat exchanger?"

Most often heat exchangers are used for freeze protection, but another application would be a radiant system with one heat source that, for one reason or another, must be separated from the domestic water supply. This is rare. Even the need for freeze protection is often overrated because a radiant system stores so much heat in the mass of the home.

A heat exchanger system using anti-freeze can protect the radiant heating system down to -60 below zero. But the trade-off is efficiency. Transferring heat from one medium to another (in this case, from potable water to anti-freeze via the heat exchanger) costs BTU's. The heat exchanger itself becomes warm and radiates into the surrounding air, though sometimes this heat helps warm a living space... even if that space is only a utility room. Quite often, the heat exchanger is insulated to minimize this effect. Nevertheless, any heat radiating from the heat exchanger is thermal energy that could have gone to your floors.

In addition, anti-freeze as a heat transfer medium is inferior to plain water. Overall, a heat exchanger system is 10 to 20% less efficient than an open system.

Of course, water has a nasty habit of freezing at temperatures below 32 degrees and in some situations this reality far outweighs the negatives of using a heat exchanger. Heating a second home in a remote location prone to power outages would be a perfect profile for a heat exchanger system. In this scenario, you can drain the domestic water system if you leave for weeks in the winter and the anti-freeze protects the heating system.

Heating a remote building may be another example. If you're sending water through a buried insulated pipe above the frost line, anti-freeze is essential.

Solar collectors almost always use anti-freeze, so a heat exchanger is necessary in this application also.

The important point to understand is that most of the time heat exchangers are not essential in a radiant system.

Heating Your Water

So what is the easiest, most efficient way to make hot water? The answer depends upon your needs. If the combined requirements of both your domestic hot water and space heating needs are less than 300,000 BTU's then a domestic water heater can do the job. Just remember that not all water heaters are created equal. Some are specifically engineered for domestic **and** space heating applications. A water heater purchased from your local hardware store may very well do the job...as long as your BTU requirements are low. But the cost of running such a unit

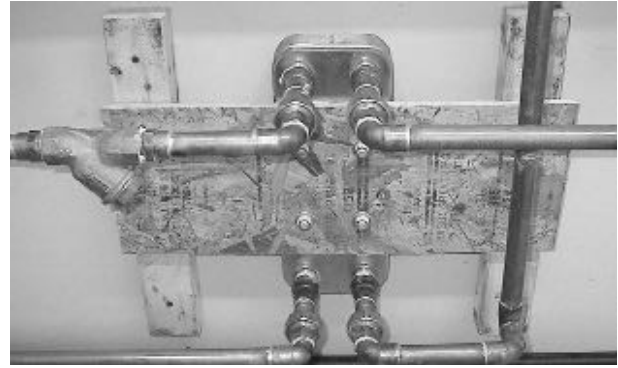

may be alarming. Until recently the efficiency rating of many water heaters has been as low as 60%. That means that a full 40% of your fuel costs are going up the flue stack. The long-term result is enough wasted money to pay for a high-efficiency water heater.....but you won't own one! It's always better to search the market for the best water heater you can afford and size it for your heating requirements.

On the other hand, if your home uses a combination of baseboard radiators and radiant heat, a situation common to retrofit projects, a boiler is your best bet. Boilers are designed to deliver lots of heat energy. They heat relatively small amounts of water to very high temperatures and vary in size from about 100,000 BTU's to as high as you want to go.

Other options include indoor and outdoor wood boilers, ground source heat pumps (sometimes called geothermal heating systems), electric boilers (if electricity in your region is inexpensive), and increasingly, on-demand water heaters.

Unlike standard, tank-type water heaters, on-demand units eliminate "standby loss" by heating water only when you need it. This feature can save up to 10% on fuel costs because standard water heaters leak heat to the surrounding air 24 hours a day. Electronic ignition eliminates the wasteful pilot light common to standard water heaters.

In addition, the latest models of on-demand heaters are condensing units. That means they condense the fuel (Natural gas or Propane) down to a trickle of water vapor, extracting 95% of the fuel's energy to heat the water. This efficiency translates to very low exhaust temperatures, so these units now vent with 3" PVC pipe. That not only eliminates the need to buy expensive stainless steel exhaust pipe, but it makes installation much easier. On-demand heaters are also lightweight, install in tight spaces, provide limitless hot water, and the most sophisticated brands, like Takagi, monitor inlet water temperature and modulate the heater's burner up or down for maximum energy efficiency. A digital remote displays incoming and outgoing temperatures, flow rate, flashes error codes for troubleshooting, and allows the user to set the unit for a variety of different temperature settings. Maintenance is simple – basically the fine mesh inlet screen should be checked periodically

and kept clean. Note: New installations may require daily cleaning until soldering flux and minor debris have been screened from the system.

Fuel Sources

Radiant floors are heated by every heat source known. The Brietenbush Resort in Oregon pumps water from natural hot springs through their floors. The rest of us probably aren't so lucky and end up using gas, oil, solar, geo-thermal, wood, or electricity to heat our water.

As long as the water flowing through the tubing is a steady temperature between 120 and 135 degrees, the method of heating it is up to the homeowner.

However, a few guidelines are important. Primarily, recovery rate should be given great consideration. Natural gas, propane, oil and wood offer the highest recovery rates. To show the importance of recovery rate, imagine this scenario.

When the heated fluid in a radiant system satisfies the room's requirements, the circulator pump shuts off. After a short time, the fluid cools down to room temperature. Some time later, when the room again calls for heat, many gallons of 70-degree water flood the water heater. This can have the effect of "diluting" the overall temperature of the heating system. Normally, this is not a problem because most water heaters can raise the temperature of the water very quickly.

But this is not the case with tank-type electric water heaters. They are efficient in the sense that most of the energy going into the unit becomes hot water. But the electric heating elements don't do their job quickly. The radiant floor system basically limps along with 90 or 100 degree water as the elements struggle to raise the water back to the desired temperature level.

So, if you live in a region of the country where electricity is so cheap that heating water is feasible, consider investing in an electric boiler. Unlike a tank-type electric water heater which heats a high volume of water (30 or more gallons), electric boilers heat a very small volume of water (1 or 2 gallons), and as a result, can provide a consistent high temperature output.

Heating Water With Solar Energy

Solar water heaters often enhance radiant floor systems. Normally, a large solar heated storage tank (with gas, oil or wood backup) supplies hot water to the radiant system and most often provides for domestic needs as well.

Solar heaters interface well with radiantly heated floors because the large thermal mass common to radiant systems provides an excellent storage medium for the energy generated during the day. At night, this stored thermal energy is slowly released into the living space and a steady, even, and consistent comfort level is maintained.

But sizing a solar heating system isn't a simple matter. Latitude, solar orientation, budget, heat loss, type of collector, domestic hot water requirements, esthetics, and performance expectations are all factors needing careful consideration. With unlimited funds, a roof covered with collectors can provide 90% of all hot water

needs. More realistically, a modest "starter" system consisting of two or more absorbers can still supply an important boost to the home's conventional heating system. The basic mechanical components (pumps, heat exchanger, controls, etc.) remain the same regardless of how many collectors may be added later.

A realistic, long term view is important with solar. Granted, the sun begins paying back the investment every time it strikes the collector. But sometimes when you really need the heat, it won't be there. Even Arizona, New Mexico, and Puerto Rico have cloudy periods. Even a full day of sun on the winter solstice will provide only a weak, short solar opportunity.

But during the spring, summer, and fall, an abundance of energy will flood your collectors. During these seasons on a good sunny day, even a modest solar array can provide 100% of the home's hot water needs.

So, what type of collector should be used?

Most people are somewhat familiar with standard flat plate solar collectors. This collector is basically a highly insulated box containing a grid of copper pipes bonded to a flat black copper absorber plate. Special glass enhances solar absorption.

Evacuated tube collectors are an entirely different approach to solar water heating. Instead of many water filled copper pipes, these collectors use multiple vacuum filled glass tubes, each with a tiny amount of antifreeze hermetically sealed within a small central copper pipe. When heated by the sun, this antifreeze converts to steam, rises to the top of the tube, transfers its heat to a collector header, then condenses back into liquid and repeats the process.

Because thermal energy doesn't easily transfer through a vacuum, 92% of the thermal energy hitting the absorber plate stays within the evacuated tube and passes to the collector header. This is a huge advantage because a standard flat plate collector radiates much of its accumulated heat to the surrounding atmosphere like any other hot object.

The evacuated tubes are also completely modular. Although rarely necessary, one or more tubes can be removed and replaced without affecting the other tubes in the array. There is no actual liquid transferred from the evacuated tube to the collector header...just heat. Evacuated tubes also start absorbing heat earlier in the day than flat plates due to their convex design and the tiny amount of antifreeze within the tube is freeze protected down to -50 degrees below zero.

The schematics on page 11 illustrate two ways solar can be incorporated into a radiant heating system. For a detailed discussion of solar thermal systems, as well as some photos of complete installations, visit the "System Types" page of our website and click on "Heating with Solar Energy".

From the Heat Source to the Floor

We've seen that virtually any method of heating water will work for radiant floors and that PEX tubing is the best heat transfer medium. So, how do we spread that heated fluid to the living space?

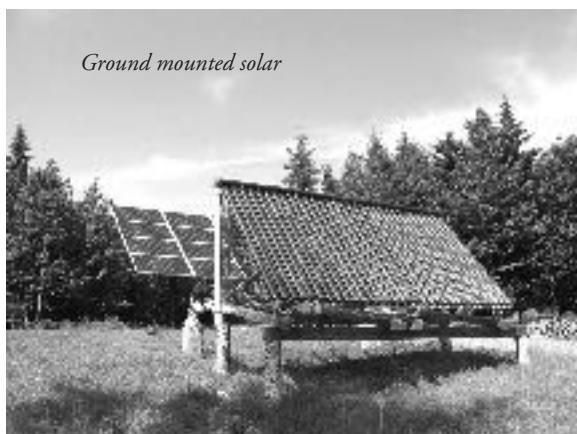
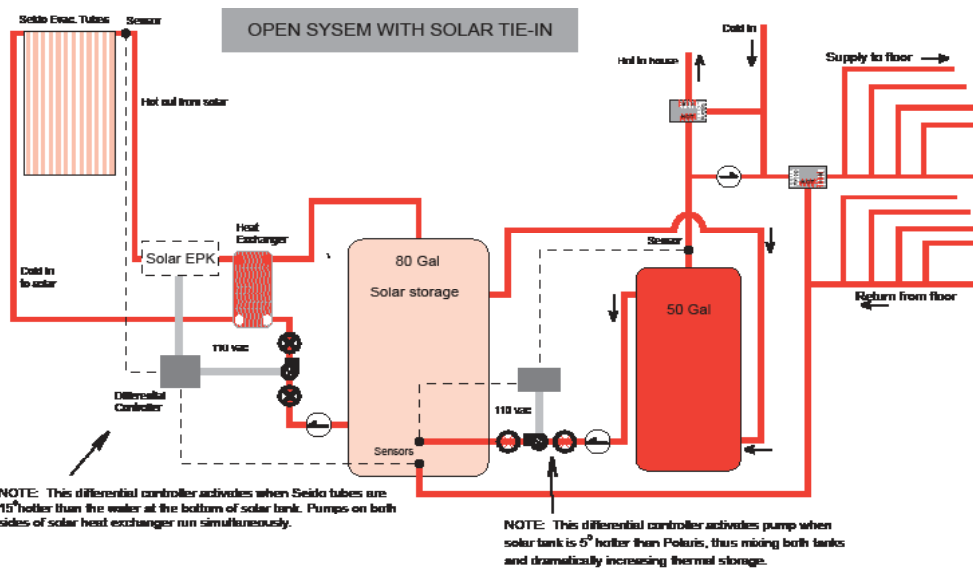
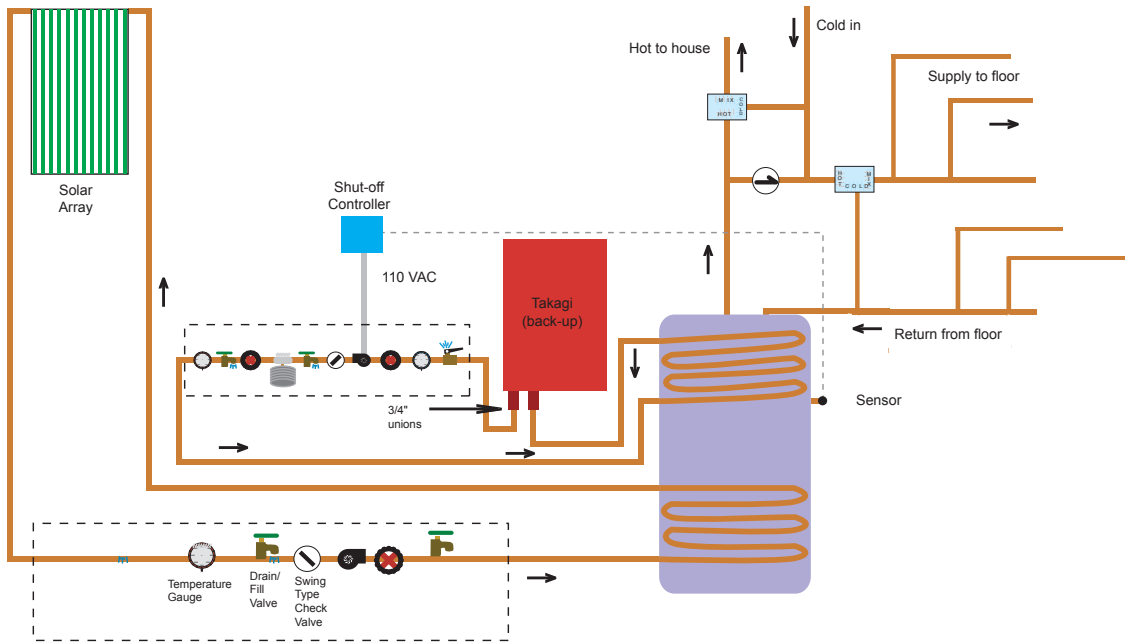

Zoning

Unless a heated area is very small, it will likely be broken up into several “zones”. A zone is any area controlled by a single thermostat and supplied by a single circulator pump. A zone can be tiny or huge. A zone can consist of many “circuits” or “loops” of tubing, or can be a single circuit. **Circuit** lengths should not exceed 400’ of tubing, but a **zone** may contain any number of circuits.

So, the question becomes: How many zones do I need? The answer depends upon your lifestyle, the size of your heated space, and the unique architectural characteristics of the building.

As a rule, keep zoning to a minimum. There’s nothing wrong with treating an entire floor as one zone. By one floor, we mean one elevation. The first and second story of one home shouldn’t share a single zone. So, if you have a two story house, your system will be a minimum of two zones.

Minimum zoning is important because radiant heating is very even. You are warming, not only the floor, but every object in the room. As a result, the entire space tends to equilibrate. Treating every room in the house as a separate zone is not only a waste of time and money, but it won’t give you much control over a space that tends to seek the same even temperature.

Zoning entire sections of a floor makes more sense. A block of rarely used bedrooms could be on their own zone, for example. Also, many people prefer to maintain their master suite at a cooler temperature than the rest of the living space. If there’s a lifestyle reason to maintain one section of a given floor at a noticeably warmer or cooler temperature, then zoning is appropriate.

Another example would be architectural features like sunrooms or great rooms with lots of glass. These rooms have a heat signature unlike the rest of the living space. During the day, a sunroom can be 20-degrees warmer than the living room. If the thermostat controlling the zone is located in the living room, the sunroom will receive heat it doesn’t need.

The reverse is also true. High glass areas give off lots of heat at night. Trying to keep the sunroom warm during a cold winter night would overheat the rest of the living area if both spaces shared the same zone. Of course, it goes without saying that window shades greatly reduce nighttime heat loss in high glass areas and should be installed whenever possible.

Multiple Circuits

If a zone can be any size, and each zone uses only one circulator pump, how far can the hot water travel before it loses all its heat?

The answer depends upon the size of the tubing used. The smaller ½” PEX is limited to a 300 ft. run, the 7/8” PEX to about 400 ft. So, if a zone is large enough to require more than, say 400 ft. of 7/8” PEX, the heated area must be broken up into multiple circuits, all approximately the same length. Similar lengths are important because you never want to give the water a “path of least resistance” to follow. If your zone consisted of three circuits, one 200 ft. long, and two 100 ft. long, the two shorter circuits would steal the water from the longer 200 ft. circuit because they would offer the pump less resistance. An inefficient heating system would result.

This is how it should be done:

For example, let’s say that your entire first floor is one evenly heated space, one zone. You need 1200 ft. of 7/8” PEX tubing, spaced 16” on center, to cover the whole area. If you tried to run the hot water continuously through 1200 ft. of tubing, you’d end up with ice water by the time it got back to your heat source. Instead, you can break up the zone into one of these configurations:

- (6) 200 ft. circuits
- (4) 300 ft. circuits, or
- (3) 400 ft. circuits

You can see that none of the circuit lengths has exceeded 400 ft. In each case, the water is returning to the heat source before or at the 400 ft. point.

Keep in mind also that these circuit lengths are just examples. A circuit length should conform to each individual situation. The installer can be flexible within the above guidelines. If you are installing tubing in your floor joists, and you determine that the ideal circuit length for your situation would work out well as (5) 240 ft. circuits...then by all means do it that way. (See section 2, The Floor Joist Installation, for detailed installation instructions.)

The Zone Manifold

(See Diagram on page 15)

A tank of efficiently heated water won’t do much heating unless it can be distributed effectively to the zones.

For this we use a Zone Manifold. This is simply a factory built manifold containing all the gauges, valves, pump flanges, etc. (see illustration page 15) necessary to mount multiple circulator pumps in one central location. It's normally installed very near the heat source so that any pump, when activated by a signal from the zone, can draw hot water and send it to the floor. *If for some reason, the Zone Manifold is not located within 6 feet (3 feet for on-demand units) of the heat source, the pipe size between heat source and manifold should be increased in direct proportion to the distance. Contact one of our technicians for specifics and never use any piping material except copper to connect the heater to the Zone Manifold, i.e. never use PEX, PVC, ABS, black iron, or garden hose for this purpose.*

Every zone always has its own circulator pump. That way, the pump can be sized to match the amount of tubing in the zone. The fluid from the pump then enters the supply line to the zone, travels through the floor, then returns to the heat source.

The “Supply” Line

In a floor joist installation, a supply header feeds the circuits within a zone. This header is simply a ¾” copper pipe that comes from the circulator pump. (See Section 2, The Floor Joist Installation, for detailed information on building the supply header.)

In a slab installation, the supply line is run to one side of a slab manifold (see photo on page 14) that has already been installed as part of the slab pour. (For more information see Section 2, The Slab Installation, for detailed information on installing the slab manifold)

The “Return” Line

Every circuit of tubing will have a beginning (supply) and an end (return). After travelling the entire length of the circuit, the fluid flows into a return pipe, also ¾” copper. This return pipe leads back to the heat source where the water is re-heated and sent back to the supply side of the circuit. This cycle repeats until enough heat has entered the space to be warmed. Only when the thermostat in the zone has been satisfied will the zone pump shut off.

Using Adaptors

Normally, all supply and return lines are insulated with foam pipe insulation or fiberglass. This is to prevent heat loss as the water travels to and from the heated floor. Most of the time, supply and return lines are made of ¾” copper

pipe. This is because you are already in copper pipe mode when you leave the circulator pump.

Getting from copper pipe mode to PEX tubing mode requires a brass fitting called an adaptor.

As the need arises, the installer can “adapt” from a copper supply line to the PEX tubing, or adapt to a copper return line from the PEX tubing by simply using a stub of pipe and a standard copper tee, 90, or coupling.

Adaptors are very handy fittings. The ability to convert from copper to PEX, and back, at any time, gives the installer a great deal of flexibility when it comes to running supply and return lines. Even while threading the radiant tubing through floor joists, adaptors can be used to overcome obstacles in the joist bays, make super tight bends, etc. (For more detailed information on using adaptors see section 2, The Floor Joist Installation page 24)

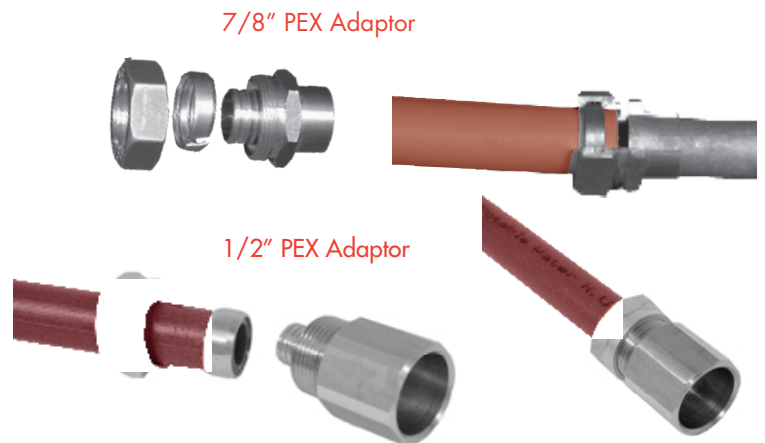

Couplings

Whenever the installer needs to connect PEX to PEX, use a coupling. Badly kinked, punctured, or crushed tubing can be easily repaired using couplings. Like adaptors, couplings are brass fittings that guarantee a tight, permanent connection.

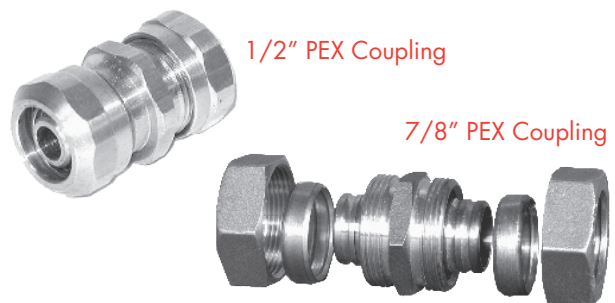

(For more information on using adaptors see section 2, Connecting Adaptors and Couplings, page 31)

The Slab Manifold

Whenever radiant tubing is poured into a concrete slab, a slab manifold should be used. More than merely a method of splitting a supply feed into two or more branch circuits, the slab manifold also doubles as a pressure test kit. Built into every manifold you'll find a pressure gauge and an air stem. Once the tubing has been installed and all the connections have been tightened, use the air stem and an air compressor to pressurize the system to 50 psi. If several hours pass without any significant drop in pressure, you can rest assured that your tubing is ready for the pour.

The manifold is also useful as a safety gauge during the pour itself. If at any time you question the integrity of the system, checking the pressure gauge will tell you instantly whether or not the tubing has been damaged.

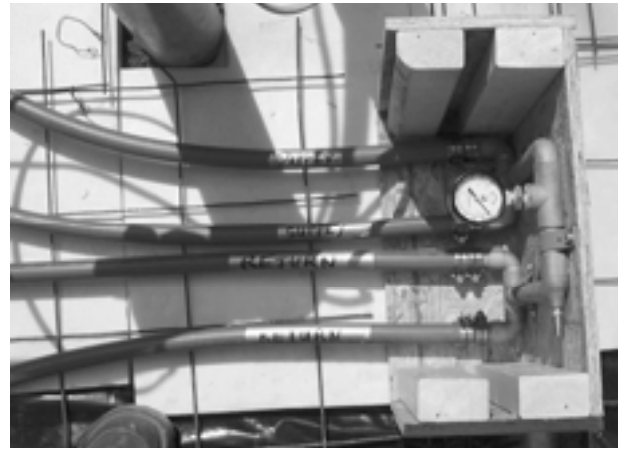

Once the pour is completed, the pressure testing assembly you see here is removed. Using a soldering torch, simply unsweat the top section of the manifold and discard it (be sure to bleed off any pressure within the manifold beforehand). This will leave two vertical pipes sticking up above slab level... your supply and return lines. The connections themselves remain below slab level within the "manifold well". They are fully accessible, untouched by concrete, and protected from possible damage during future construction.

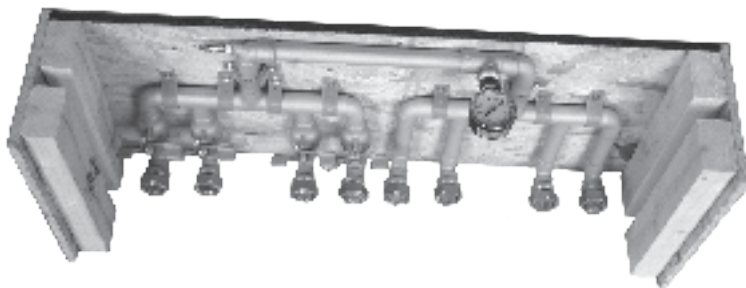

4 Loop Slab Manifold



Removing the pressure testing assembly

Narrow profile wrench for convenient Manifold installation



Installing the Zone Manifold

The zone manifold is divided into two sections...supply side and return side. Both sections should be mounted fairly close to the heat source. In multiple zone systems containing many pumps, the supply side of the manifold can be quite heavy so care should be taken to mount it securely. When you receive your manifold, you'll notice that we've included a piece of plywood. The plywood piece should be removed and mounted on the wall next to your heat source. This will provide a secure foundation for both sides of your manifold and give you a board already pre-cut to the width of your particular manifold. Also note the "test caps" soldered onto the ends of the zone manifolds & the Expansion and Purge kit. We install these for pressure testing purposes and to prevent debris from entering the manifold during shipping. *Before plumbing the manifold, remove the test caps by cutting them off, or heat them with a torch and twist them off with a pair of channel locks. You could also heat the cap and tap gently, top and bottom, with a screw driver. If you're new to plumbing and worry about overheating the soldered connections adjacent to the caps, simply wrap a damp rag around the nearest fitting and focus the torch directly onto the cap.*

Always orient the supply side of the manifold and the circulator pumps so that they point upward. Plumbing the

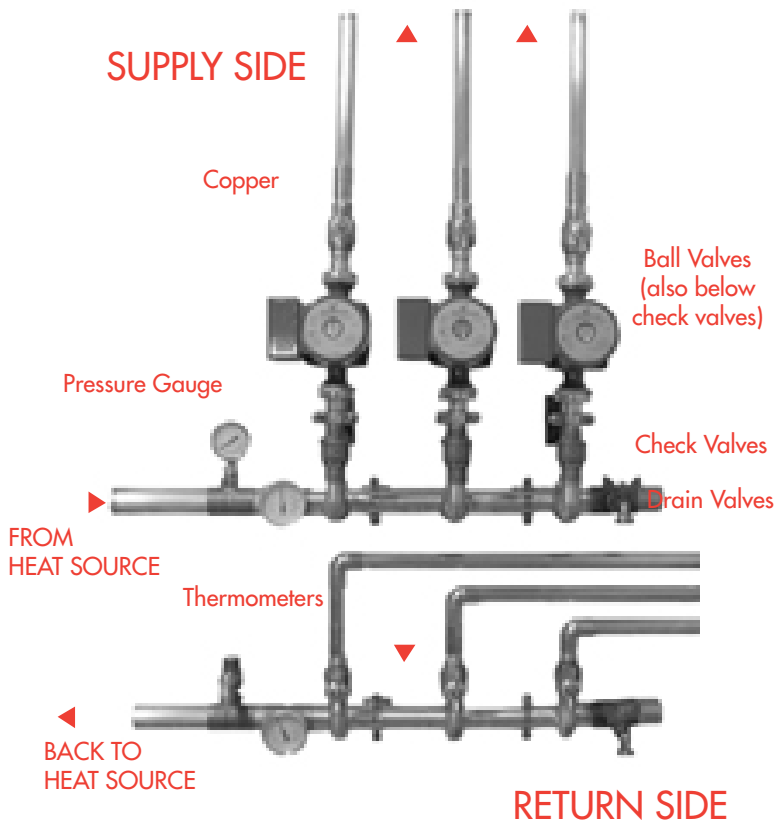

manifold upside down causes the one-way valves on each leg of the manifold to hang in the open position. The result is an imbalanced radiant system with all zones randomly drawing water from each other. So, if you have to stand on your head to read the labels on your pumps, your manifold is upside down.

In the bag of mounting hardware included with your order you will find two excellent mounting assemblies: 1) 1 1/4" bell connectors, and 2) split ring hangers, complete with pre-cut all-thread rods and the cast iron plate that the all-thread screws into.

The bell connectors are mounted to the plywood and attach to the main body of the manifold.

The split ring hangers are also mounted to the plywood, of course, but they attach to the 3/4" copper pipe just below the circulator pump. The piece of all-thread is used to bridge the gap between the plywood and the split ring hanger and provide a strong support.

You'll also notice identical brass tee fittings on each end of the zone manifold. The outlet of the tee is threaded. Depending on how you decide to orient the manifold in relation to your heat source, this threaded outlet will contain either a drain valve or an in-line thermometer.

Obviously, you'll want to install one of the in-line thermometers at a point where the hot water first enters the supply side of the manifold. This way you can monitor the fluid temperature on its way to the floor. The second in-line thermometer is installed so that you can monitor the temperature of the water as it leaves the return side of the manifold and travels back to the heat source.

Install the two drain valves and the end caps in the tees opposite your in-line thermometers. These valves are provided as a means of draining the radiant system should that ever become necessary.

The final two items manage pressure in the system. A standard dial-type gauge allows you to monitor the system pressure, and a separate pressure relief valve set to 55 psi. will trigger long before over-pressure could damage the system.

Circulator Pumps

Once the zone manifold is mounted, the circulators are very easy to install. The pump flanges are built into the manifold so attaching the pump is simply a matter of aligning the pump with the flange and bolting it in. Remember, always orient your circulator, or circulators, so that the arrow on the body of the pump is pointing upward. This way any air rising in the system is pushed up and away from the pump. You'll want to pre-wire the pumps with either 12 or 14 gauge wire **before** you install them into the manifold (except the "Alpha" series pumps – they wire from the front and are easy to wire in or out of the manifold). Follow your local codes for specific wiring guidance. Some codes require flexible conduit from the relay box to the pumps, others allow a simple Romex connection.

Pump Controller

The pump controller box is usually mounted fairly close to the rest of the mechanical components. However, some people choose to locate it some distance away. The controller displays a green light to indicate power to the system and red lights to indicate which zone or zones are currently operating. It can be a very handy way of monitoring your system and you may want to install it in some location that you frequent often. Radiant systems are silent. If you're like me and are curious about the "rhythms" of your system, you'll want your controller somewhere that you can conveniently see it.

Wiring the controller box is generally very simple and schematics are included with every system. But, if you have questions, just contact one of our technicians and they'll happily walk you through the process.

ZONE CONTROL KIT
(Pump Controller
& Thermostat)



EXPANSION AND PURGE KIT (EPK)

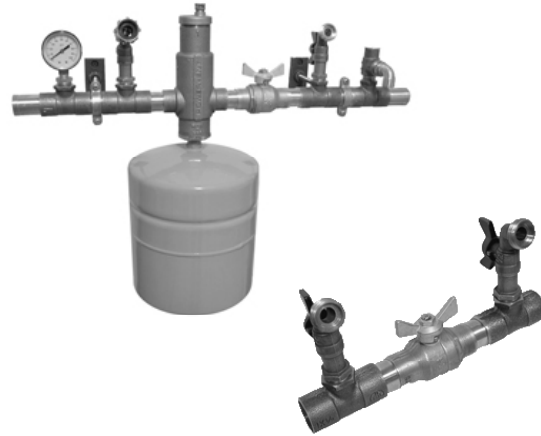

EXISTING SYSTEM FILL KIT

Expansion and Purge Kit

For "closed" and "heat exchanger" systems, you'll need the Expansion and Purge Kit (EPK). This consists of an expansion tank, an air eliminator, fill and drain valves, a pressure gauge and a pressure relief valve. The EPK is pretty much factory assembled. You'll have to screw the expansion tank into the bottom of the air eliminator because the tank is shipped in a separate box, but that is a simple operation.

The EPK makes it very easy to fill and simultaneously purge air from your newly installed tubing, and the expansion tank component acts as a sort of "shock absorber" in a closed system. When water heats up, it expands. The flexible membrane in the tank absorbs that expansion.

In addition, the pressure gauge in the EPK helps you charge the system with the proper 15-20 PSI, and during the life of the system, lets you know when more fluid needs to be added by indicating a pressure drop below 10 PSI.

The pressure relief valve is a safety device very much like the pressure and temperature relief valve on your water heater. It protects the tubing from excessive pressure.

Mounting the EPK is similar to mounting the zone manifold. Use split ring hangers and all-thread to secure the EPK to a wall next to your heat source. In "closed" and "heat exchanger" systems the EPK is installed between the heat source and the zone manifold, so that the plumbing itself offers a great deal of support to the assembly. Always install the expansion tank **after** the EPK has been mounted.

SECTION 2

This section of the installation manual deals with the nuts and bolts of radiant floor applications. Here, you'll find a very descriptive step by step guide designed to help the do-it-yourselfer install a radiant heating system. It contains many useful tips and techniques. A thorough reading will provide the installer with a fundamental understanding of various radiant floor installation procedures and prepare the installer for a pleasant and productive project.

Of course, the technicians at [Radiant Floor Company](#) have helped thousands of do-it-yourselfers and are always happy to assist in any way they can. Help is always just a toll-free call away at [\(866\) 927-6863](tel:866-927-6863).



A slab installation using 7/8" PEX tubing, 16" on center

The Slab on Grade Installation

A slab on grade is defined as any concrete slab poured over excavated soil. From a radiant heating perspective, it doesn't matter if the slab is actually "at grade" or is poured several feet *below* grade as part of a full foundation.

The fact remains that installing radiant tubing within a concrete slab is probably the easiest, most cost effective and highest performance application of the science. The thermal benefits are unsurpassed. Virtually any concrete pour should contain radiant tubing, even if you have no immediate plans to heat the space. After all, you may change your mind later and regret your lost opportunity. For most applications, the tubing and manifold are relatively inexpensive and the mechanical components can be installed even years later.

Of course, there are always exceptions to the rule. A woodshed or an outside storage shed with a concrete floor might be a waste of tubing. But even then you should think long and hard about the possibilities of converting these areas into heated space at some future date.

I say this because often we work with people faced with the task of pouring a new slab, with tubing, over an already existing slab..and they poured their existing slab only a few years before. How much easier it would have

been to install the tubing in the original slab!

But, if you're fortunate enough to be planning an original pour, the procedure is simple.

In fact, the basics of a standard pour remain the same. The compacted aggregate base is first, followed by a 6 mil polyethylene vapor barrier, then insulation, then rebar or wire mesh, or both.

The insulation phase is crucial for a radiant floor. Mainly, heated slabs radiate outward rather than downward, so insulation on the edges of the slab is most important. Remember that your slab will be about 75 degrees F. Any cooler surface in contact with the slab will try to steal its heat. If you're pouring up against your foundation walls, insulate between the slab and the walls. For a cleaner looking installation, cut the top edge of the foam board at a 45-degree angle so the concrete will flow all the way to the foundation wall and hide the foam.

How you insulate under the slab depends upon the severity of your winters. In lower, warmer latitudes, 1" XPS (Extruded Polystyrene foam, i.e. "pink" or "blue" board) works fine. In colder regions, use 2" XPS.

By the way, it's worth repeating that Radiant Floor Company recommends Extruded Polystyrene for under slab insulation. Period. Bubble wrap, foil, and various other thinner foams, with or without a vapor barrier, may be easier to use, but in our experience have never proved as effective. So, once you've insulated to suit your situation, install the rebar and/or wire mesh and use rebar ties or nylon ties to fasten your radiant tubing to the mesh. It's a good idea to use a tie about every 6 or 7 feet when first laying out the tubing. This will keep the tubing roughly in place while you're working on the layout. Then, once the tubing has been completely installed and you've made all the necessary adjustments to your layout pattern, go back and install a tie about every *two feet* to firmly attach the tubing to the rebar or mesh. If like most slabs you require more than one circuit of tubing, you'll need to install a slab manifold at some convenient spot; most often along the perimeter, but occasionally in the body of the slab if that works out best in your particular situation. The slab manifold is shipped in a plywood box that doubles as the form you pour the concrete around. Make sure the manifold box is installed plumb. Later, when the pour is complete and you remove the pressure test kit from the top of the manifold, you'll want your supply and return pipes sticking up nice and straight. Install the slab manifold very near your heat source, if possible, to keep the supply and return lines from your heat source short and easy.

Depending upon which size tubing you're using (7/8" or 1/2") you'll space the tubing either 16" on center, or 8" on center respectively. Keep in mind that while you're looping the tubing back and forth, up and down the slab and so forth, you won't be trying to make a 16" bend in the tubing. The actual bend will probably be closer to a 20" diameter....depending upon whether you're installing the tubing on a warm summer day, or a cool fall evening. In other words, warmth equals flexibility. But whatever the temperature, just allow the tubing to conform to its natural bend. You may want to experiment with a 4 ft. piece of tubing before you start. Slowly start bending until you reach the kink point. That will give you some idea of how tight your bends can be. Then later, while laying out your circuits, and after your wide, comfortable bend, you can begin spacing the tubing roughly 16" on center on the straight-aways (8" on center for 1/2" PEX).

Loop the tubing in any convenient pattern, maintaining the proper spacing. Come in about 6" from the perimeter. It's okay to cross the tubing as long as you don't create a tubing stack so thick it threatens to rise above the surface of the slab. You can see how that wouldn't be a great idea!

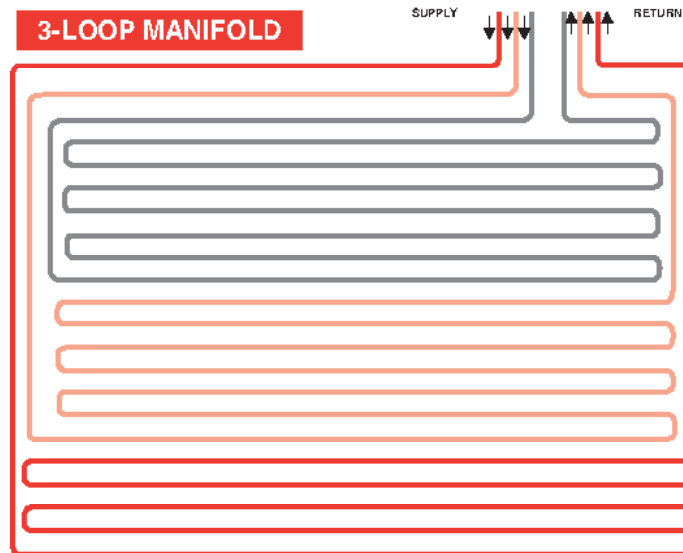

This is a commonly used layout pattern for a typical slab on grade installation. Although it's perfectly ok, and sometimes necessary, to cross one tube over another during tubing layout, notice how this simple configuration places each loop within its neighbor, starting from the outer connections of the manifold and working toward the center.

Once the tubing is run and all the connections are made to the manifold, replace the front cover of the manifold box and pressurize the system with 50 PSI. Wait several hours or overnight. Sometimes the air in the tubing cools down and a few pounds of pressure are lost. However, if the gauge indicates more than a 5-PSI drop, check for leaks in the tubing. Most of the time, the connections to the manifold just need a bit more tightening. If that doesn't solve the problem, inspect the tubing for signs of damage. A sharp piece of wire mesh may have punctured the tubing during installation. It's rare, but it can happen.

If a puncture is discovered, use a repair coupling, or if that method offends your sense of perfection, replace that circuit of tubing. In most cases, replacing a complete circuit will cost less than \$200. It will cost only pennies if you can cut out the damaged section and reuse the tubing later in a floor joist application.

It's also a good idea to stuff some scrap foam, newspaper, an old rag, or whatever, around the tubing where it enters the manifold box. That way, if your concrete is unusually soupy, it won't be able to flow into the box and touch the copper manifold.

Once the system has been tested and proven free of leaks, lower the pressure to 25- PSI. With the gauge at 25-PSI, you'll have a visual indication that the system is holding pressure during the pour itself. Should that pressure drop, find the source of the leak and either use a repair coupling, or form around the damaged area and repair it later.

Just remember that damage during the pour is rare. The tubing isn't delicate and in most cases is spaced 16" apart. There's plenty of space to walk between the tubing runs. If concrete needs to be wheeled across the floor, simply lay down some plywood planks to spread out the weight and protect the tubing.



Sensor Sleeve installed in Manifold Box

And while we're on the subject of pre-pour preparations, this would be the ideal time to install the "sensor sleeve" if a floor sensor is being used to control the zone instead of the standard wall mounted thermostat.

Briefly, a floor sensor is a small thermistor that monitors the actual floor temperature instead of the air temperature in the zone heated by the slab. It's the preferred method of control if a second heat source contributes heat to the zone. A radiant zone with a frequently used wood stove would be a common example. A forced air duct blowing into the radiant zone would be another. Obviously, if air

temperature controlled the radiant floor, it would never come on when these other heaters were activated. The air would be warm, but the floor would stay cold.

With a floor sensor controlling the radiant zone, independent of the room's air temperature, the floor maintains whatever baseline temperature you desire and the other heat sources, if used, can make up the difference.

So, when installing a floor sensor thermistor, never embed the thermistor itself into the concrete. Instead, take a ten foot piece of PEX tubing, plug one end, and embed this "sensor sleeve" into the slab. This will guarantee future access to the thermistor and make replacement an easy matter.



Pouring the slab around the manifold box



Sensor Tube

When the Unthinkable Happens

Oops!.....your concrete contractor forgot to install a key anchor bolt into your slab pour. He returns the next day with a masonry bit and a 1/2" hammer drill, then tries to remedy the error by drilling a hole in the new slab.....and, well you guessed it. He drills right into your radiant tubing. What do you do now?

Well, after you calm down (generally sometime between hiding his body and returning to the jobsite), you begin the arduous process of chipping away the concrete and installing a repair coupling. You'll need to create some wiggle room because the tubing has to be flexed enough to work the repair coupling

securely into both open ends of the PEX without kinking and further damaging the tubing. Four to eight inches on either side of the affected area is probably about right.

Then carefully cut out the damaged section with a PVC cutter. You can cut out about 1/2" of tubing and still have plenty of PEX to make a very secure connection over the coupling. The final step involves wrapping the coupling with self-vulcanizing (sticks to itself) rubber tape or vinyl tape. This prevents the concrete from coming into direct contact with the brass coupling and this procedure should be used ANY time a coupling is used in a concrete pour.

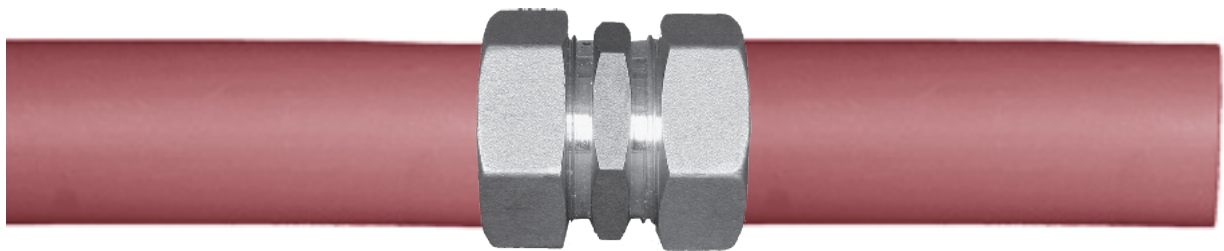
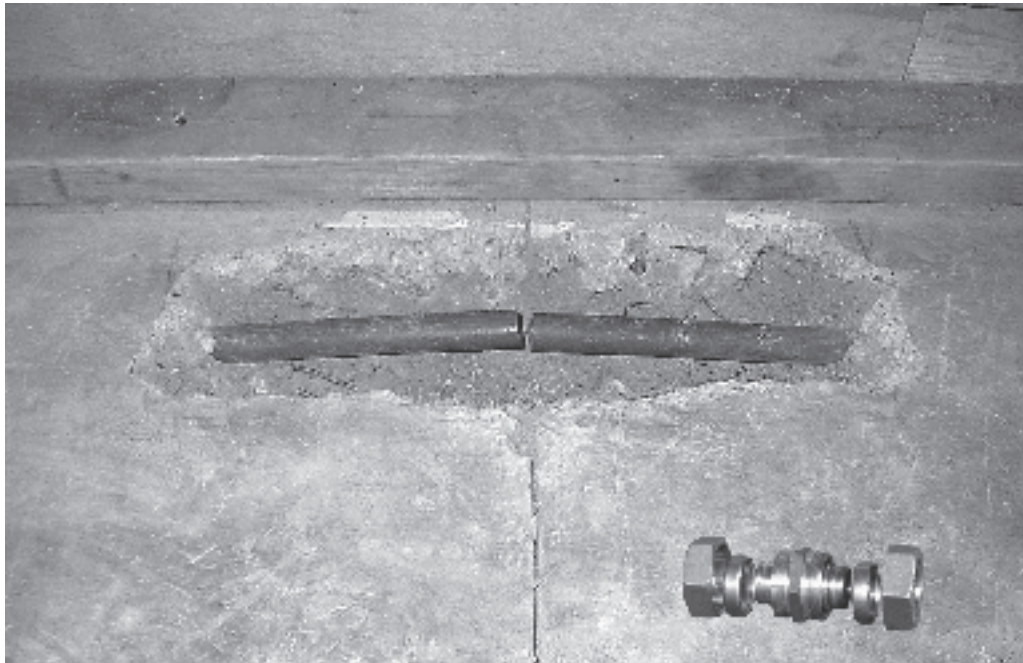

The Suspended Slab

Radiant tubing installed on top of an existing floor is called a suspended slab. Especially with new construction, this method can make a lot of sense because the thermal performance of the finished floor rivals a “slab on grade” installation...and it doesn’t get any better than that. Unlike the staple-up, within the floor joist method, the suspended slab incorporates sand, cement, or Gypcrete to store and diffuse thermal energy. The downside is added weight on the floor, possible loss of precious headroom, and (especially in retrofit situations) difficulty in making transitions into other rooms and adjusting door thresholds.

Nevertheless, should you decide that the suspended slab method is best for your situation, here are a couple of installation techniques:

Pour a New Floor

If you’re comfortable working with concrete, you can simply lay out the radiant tubing, connect your various loops to a conveniently placed manifold, pour a thin layer of concrete or Gypcrete over it, screed it level, and return hours later to your finished floor.

When pouring a suspended slab over an existing concrete floor, a layer of rigid insulation is installed, and the tubing can be attached to the old slab with tubing straps by power nailing directly into the concrete with a ram set. Or, wire mesh can be anchored to the concrete in the same manner and the tubing can be attached to the mesh. The difficulty with this method is ending up with a clean, level floor. Most do-it-yourselfers probably don’t have the experience or comfort level to tackle a concrete job using this method. If you’re the exception, this may be the easiest approach for you.

Use 2 X 4 Sleepers

With this method, 2X4’s are laid out flat across the existing floor, 16” on center, to create “sleeper bays”. Depending upon which size tubing is used, one or two runs of radiant tubing are installed between each set of sleepers. The tubing is fastened to the plywood sub-floor with electrical conduit straps or copper tubing straps. Every other sleeper is staggered away from the wall, on both ends of the room, to give the tubing a channel to pass through.

If the area to be heated is a small zone consisting of only one loop of tubing, then the beginning (supply) side of the



radiant loop is connected to an insulated copper supply line from the heat source. The end (return) side of the radiant loop connects to the insulated copper return line. A simple one loop zone like this is only possible when less than 400 ft. of 7/8” PEX tubing is required to fill a zone. Using 1/2” PEX limits that same zone to 300 ft. of tubing.

For most zones, multiple even loops (or circuits) of tubing are required. The reason is simple. If a given amount of square footage requires more than 400 ft. of tubing, say 1200 feet, and you tried to run the water continuously through that much tubing, you’d end up circulating tepid water through most of your floor. An unheated space would result.

The proper method involves constructing a site-built header (see page 26 for more info on building headers), one for the supply side, and one for the return. It’s no more difficult than running domestic water lines and it assures an even, balanced flow of heated fluid through the radiant floor.

So, using the above example of 1200 feet of tubing in this fictional zone, you can see that the loop lengths can either be (3) 400 ft. circuits, or (4) 300 ft. circuits. Which method you use depends on your particular situation. Basically, whichever is easier. For this example, we’ll use (4) 300-ft. circuits.

Okay, you’ve installed all the tubing between the sleeper bays. You’ve got four circuits, so there will be four beginnings and four ends to your circuits. Your supply header will simply connect all the beginnings together and the ends will connect to the return header. If your circuits are all the same lengths (within 10%) the water won’t find a “path of least resistance” and the fluid will flow evenly through all the circuits. No balancing valves are required. And even though you’re passing the heated fluid through a total of 1200 feet of tubing, it never has to travel more than 300 feet before it’s on its way back to the heat source.

It should be noted that the suspended slab is treated exactly like a slab on grade when it comes to the use of couplings.

In other words, don't use them. Always run solid lengths of tubing in areas that will ultimately be virtually inaccessible.

The actual placement of the supply and return headers is up to the installer. Often both headers are located beneath the sub-floor. A four inch slit, about 1" wide, can be cut into the sub-floor to allow the tubing to make a long, comfortable bend to the joist cavity below. The headers themselves, which often run perpendicular to the joists, are fastened to the bottom of the joists with tubing straps. The PEX tubing, bending down from above, can tee into the 3/4" copper header pipe by using one of the standard brass adaptors. Later, the four-inch cut in the plywood can be filled in with spray foam to seal around the tubing.

By using a long, spread out header type manifold in this fashion, the installer can create a very clean, very flexible circuit layout, especially if sleepers are used. The far less desirable alternative would be a small, centrally located manifold with each circuit of tubing leaving and returning from one spot in the room. In large zones with many circuits, that spot in the room could be at the opposite end of the house, forcing the installer to figure out how to run an unwieldy cluster of supply and return lines back to the manifold. So in this sense, the suspended slab with sleepers is like a floor joist installation when it comes to running supply and return headers. In other words, it's better to bring the headers to the tubing, instead of the tubing to a single small manifold.

Another method is to run the headers along the perimeter of the room and connect the tubing using brass adaptors.

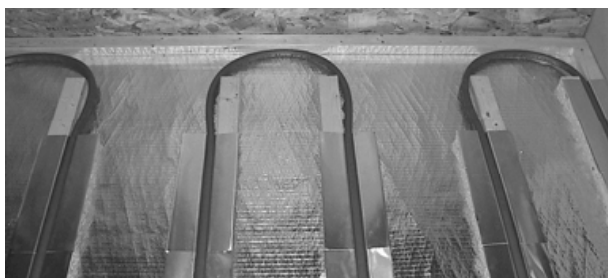
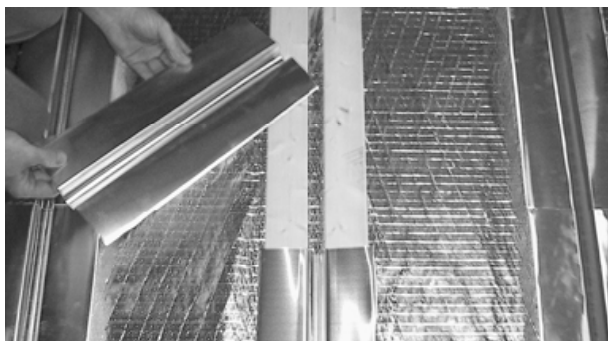

Once all the connections are made, a thin layer of thermal mass is spread over the tubing, between the sleepers. If the final floor is to be hardwood, this thermal mass can be simple dry sand. The dry sand is poured into the bays up to the top of the sleepers and the hardwood is nailed to the sleepers. If the final floor is to be carpet or tile, the mass between the sleepers needs to harden. Concrete, Gypcrete, or a dry mix of (4) parts sand (1) part Portland cement can be used. This last method involves a cement mixer and just enough water to give the mix a "sand castle" consistency. It's not wet slurry. The Portland cement will give the sand a slightly greenish tint and the mixture will dry hard as a rock. Once fully cured, you can then carpet, tile with backer board, Pergo, or whatever over it.

An alternative method involves spreading out your sand, then nailing plywood to the sleepers. The plywood can then support tile, carpet, etc. If the existing floor is concrete, the sleepers are glued to the floor using Liquid Nails and the tubing can be taped to the floor. If taping seems a little weak, then wire mesh can be fastened to the edges of the 2 by 4 sleepers, run along the bottom of the sleeper bays, and the tubing attached to the mesh. A ram set and tubing straps can also be used.

In the case of an existing, un-insulated concrete slab, rigid foam can be installed under the wire mesh to prevent heat loss downward. A pre-existing insulated slab can be utilized for its thermal storage capabilities.

One final variation of the suspended slab applies when the weight of the sand or concrete threatens to exceed the floor's desired load limits. In this event, aluminum heat diffusion plates are used as a substitute for the thermal mass of the sand/concrete. They hold the tubing to the floor and help spread the heat evenly throughout the zone. But a percentage of the floor's thermal performance is lost due to the lesser amount of thermal mass in the system.

If the suspended slab is installed over an existing plywood subfloor, insulate the joist cavity below the subfloor. This directs the thermal energy into the intended living space and prevents the heat from flowing downward.

Ledger Board Method For Radiant Tubing

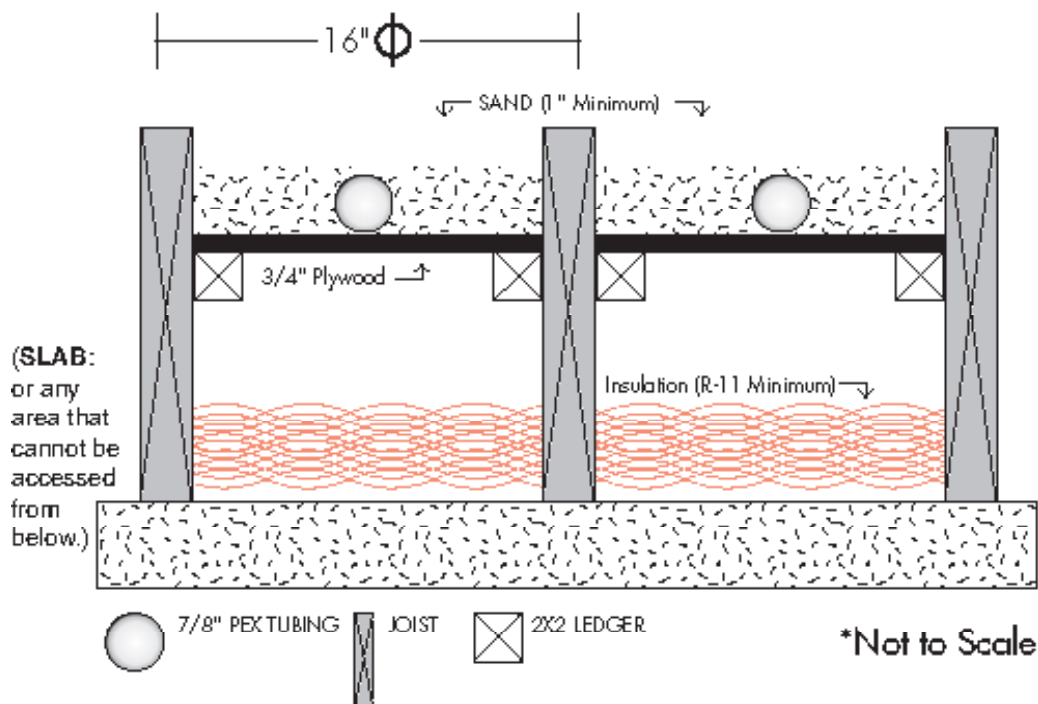

The Ledger Method

There are two primary situations in which the ledger method may work for you. The first would be an existing slab upon which you plan to add a joist floor. Let's say, for example, you were converting your garage into a new office. The garage is slab on grade and 8" below the level of the rest of the house. You want to raise the finished floor in the future office to match the house and you're doing it by building a joist system on top of the slab.

The second situation would be a re-modeling project that required, for whatever reason, the removal of the existing sub-floor...or a room where headroom is at a premium and raising the floor to accommodate radiant tubing is not an option. Of course, we're assuming here that access to the joists from below is impossible.

In both these situations, the joists are exposed and you'll be installing the tubing from above. The procedure goes like this:

Drop down about 3" from the top of the joists and install ledger boards on the inside face of the joists (see illustration). Two by two strapping should be adequate. You'll use

these ledgers to create a "false floor" below the level of the joists using 3/4" plywood. Of course, you'll want to insulate below this "false floor" to prevent the heat from travelling downward. In the case of the garage slab, you'd probably want to use rigid foam, especially if there's any chance that water could find its way under your joists. If water infiltration is not an issue, then fiberglass is fine.

Once the plywood is in place, attach the radiant tubing directly to the plywood using tubing straps. Thread the tubing through the joists just as you would with any joist system. Be certain you've sealed any cracks between the plywood and the joists, or any cracks between adjoining sheets of plywood. This is because the final step is to fill this cavity with **dry** sand. The sand will act as an excellent thermal mass, storing and diffusing heat. You don't want the sand working its way through any cracks and ending up on the floor below.

So, with the tubing installed and sand poured up to the top of the joists, you can now install the finished floor in any manner you choose.

Note: Any time sand, concrete, or Gypcrete is added to an existing floor, always consult with a structural engineer to determine the load bearing capacity of your floor.

The Floor Joist Installation

A floor joist installation presents some unique challenges not found in the wide-open, more flexible environment of the slab on grade installation. However, with a few guidelines, these challenges can be easily overcome.

First, it's important to remember that, normally, Radiant Floor Company assumes that all heat exchanger tubing, whether 1/2" PEX or 7/8" PEX, is fed by 3/4" copper supply and return lines. Because we never know how far away the heat source is from a given zone, we spec the proper amount of tubing to fill the zone only. In other words, the PEX tubing is in the heated floor and does not necessarily go back and forth to the water heater or boiler.

Having said that, keep in mind that the 7/8" PEX tubing can be used for your supply and return lines if:

1) you order extra tubing, and, 2) in your situation it makes sense to take advantage of the flexibility of the plastic.

An example of this might be an installation in a geodesic dome or other unconventionally shaped structure. The polyethylene tubing would easily conform to the radius of the structure, follow the curve as it were, and could greatly simplify getting the supply and return lines from point A to point B.

Other examples would be tight, difficult to access crawl spaces, cluttered, cramped joist cavities, or any area where running rigid copper tubing would be very difficult.

Some people use a "hybrid" method. This is a combination of copper and PEX supply and return lines. Our brass adaptors allow you to convert from copper to PEX, and back, as often as necessary.

For example, you may start your supply line from the circulator pump with 3/4" copper, run twenty feet quite easily, then encounter an obstacle you'd prefer to snake around. Using a brass adaptor, you convert to PEX, squirrel your way up, down, around, and through....reach the zone, then convert back to copper.

Since the brass adaptors are designed to solder onto a stub of 3/4" copper, it's always easier to be in copper mode when actually at the zone. This is because most zones require multiple even loops of tubing.



7/8" PEX in a floor Joist application

Running Multiple Loops of Tubing Within a Zone

Unless a zone requires 400 feet or less of tubing (300 feet for 1/2" PEX), the zone must be broken up into even multiple loops. By even, we mean loops that are within, approximately, 10% of each other in length. By keeping the loops roughly equal you don't give the water a shorter "path of least resistance" to follow and the heat in your entire zone will be balanced.

Most installations require multiple loops of tubing within one zone. If a zone is very large and requires, say, 1600 feet of tubing to adequately cover the entire floor, then that floor would be broken up into (8) roughly 200 foot loops all fed by a common 3/4" copper supply line. The copper line acts as a header, filling with water first, then simultaneously feeding all the loops. The water then travels only 200 feet before entering a similar 3/4" copper "return" header and making it's way back to the heat source. This is why it's easiest to use copper for supply and return lines.

The brass adaptors will solder into 3/4" copper at the beginning of every 7/8" PEX loop. Basically, you build a manifold as you go. Your copper header arrives at the zone, adapts to 7/8" PEX at the beginning of the first loop, the tubing snakes up and down "X" number of joist bays, then terminates using another adaptor into the copper return header. The supply header is then carried on to the beginning of loop number two, another adaptor is used, and the process is repeated. On the final loop, a 3/4" 90 is used instead of a tee. (see header drawing, page 27)

And, to take the above example a step further, keep in mind that it would be acceptable to install the same 1600 feet of tubing as (4) 400-foot loops. That's because with 7/8" PEX tubing, the hot water can travel 400 feet before it starts getting too cool to do you any good.

However, it's generally preferable to run several shorter loops, than fewer longer ones.

If your installation requires more than (3) circuits of tubing within a single zone, a ball valve must be installed on the supply side of each circuit.

OPPOSING HEADERS SETUP W/ DOUBLE TUBING

These valves will come in handy when you fill the system and purge air out of the newly installed tubing. Especially in a large zone, the air in the tubing can offer quite a bit of resistance and it's easier to purge the zone one circuit at a time

The exact length of the loops, within the above guidelines, is determined by the situation. Radiant Floor Company generally provides 200-foot rolls of tubing for floor joist applications. This is because manhandling a roll larger than 200 feet can become a hassle. But upon measuring the length of your particular joist bays, you may determine that the perfect loop length for your installation will be, say, 270 feet. If this is the case, it's perfectly acceptable to add 70 feet to each 200-foot roll. In floor joist applications, use as many couplings as you need...not only to add to a roll, but to make the job of running the tubing easier.

When Running Double the Normal Amount of Tubing Makes Sense

In situations with "fair" or "poor" insulation it may be necessary to run twice the normal amount of tubing. In other words, in the case of 7/8" PEX (normally run 16" on center) instead of running one length of tubing per joist bay, the installer will run two. The goal is to end up with the PEX installed 8" on center, but without exceeding the bending radius of the tubing.

The solution is simple. Run the tubing as you normally would...one length per joist bay...then return to the beginning of the first circuit and starting at joist bay number two (see illustration above), thread a second batch of tubing parallel with the first. This staggered threading method effectively doubles the amount of tubing in the zone without forcing the installer to drill two holes in the same end of the joist. For the second run, you'll want to mimic the first run as closely as possible in terms of length, of course, because in effect you're doing nothing more than adding additional circuits and all circuits must be equal in length.

With a ledger system, the installer also has the option of using a Sawzall to cut a radiused notch on the top of the joists, then running the tubing through the notch. Make sure the notch is rounded on the bottom, like a half-moon. This will eliminate the shear point caused by

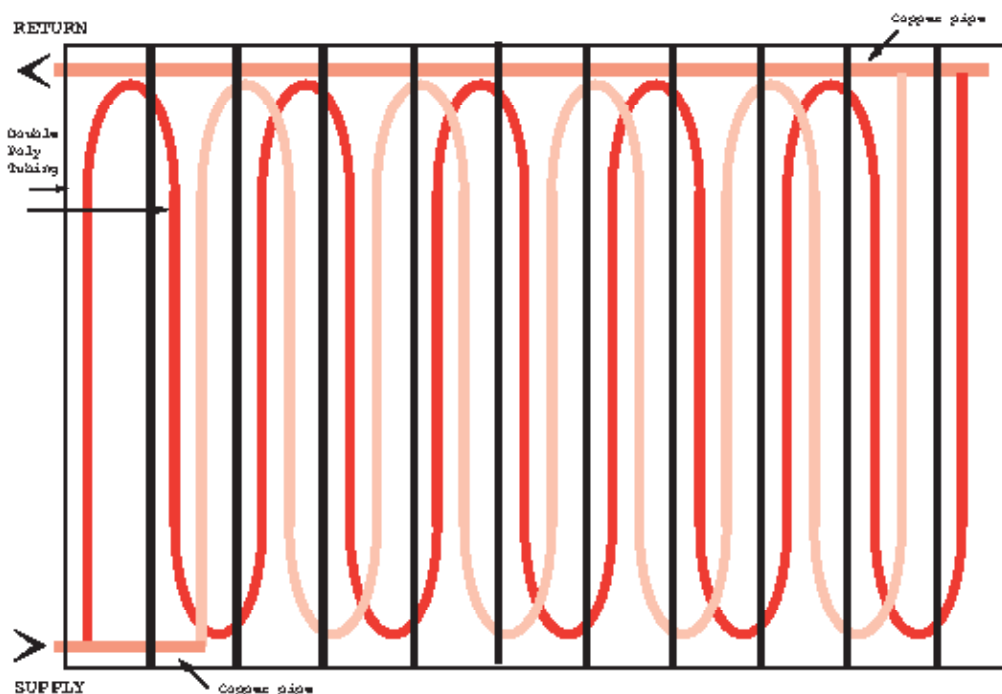

a standard V notch.

This technique makes the task of running double amounts of tubing much easier than trying to thread it through holes in the joists. Remember, the strength of a joist is primarily in the bottom half of the board, so notching won't significantly weaken the joist. However, if you want, mending bars can be fastened across the notched area of each joist once the tubing has been installed.

For both the ledger system and the standard joist installation, when running the second batch of tubing, strive for an approximate 8" on center spacing, but don't worry if you have to cross over the first batch of tubing in some spots to achieve this. Attach the tubing to the sub-floor as you normally would using aluminum heat diffusion plates.

Of course, it goes without saying that improving the insulation value of the structure is normally preferable to doubling up on tubing. But sometimes that simply isn't practical in older buildings. In addition, even modern, otherwise well insulated structures will sometimes require double tubing in certain zones. Because many people take advantage of spectacular views by designing large window walls and high cathedral ceilings, they create an equally spectacular heat loss in these areas. But, then again, nobody is suggesting that we should all live in high R-value caves either. Simply design the radiant system to accommodate the building's heat loss and all the advantages of light, spaciousness, and comfort can be enjoyed.

Building Headers

Let's start by answering the most basic question. What is a header?

A header is simply a type of manifold. You could call it a spread out, elongated manifold, if you like, but it's important to distinguish between a standard manifold and a header for the purpose of radiant floor applications because the two are used very differently.

A standard manifold (a.k.a. slab manifold) is a tight configuration of supply and return connections. If you have a "3-circuit" manifold, you'd have a manifold with (6) total connections, (3) supply and (3) return, all arrayed in a tight little package that might be about 18" wide.

In practice, a single supply line enters a standard manifold and is split into three branches. The fluid then flows through the (3) circuits in the floor and returns again to the manifold where it merges back into one return line and flows back to the heat source.

This type of manifold works well in a slab application because the installer is working in a wide open environment. The manifold can sit in one corner of the slab and all the connections can start and end in that one spot because when you're finishing up a roll, you can simply work your way back to the manifold and make your connection.

It's not so easy with a floor joist application. If you mounted a standard manifold in one corner of the room, and all your multiple circuit connections had to begin and end in that corner, you'd soon find yourself with an unwieldy cluster of supply and return lines going back and forth to and from the manifold. This is because the floor joists are continually taking you farther and farther away from that corner. Unlike a slab installation, you can't just walk across the floor with your last thirty feet of tubing and plug in.

That's why an elongated manifold, or header, is best. It's easier and cleaner to bring your supply and return lines to the tubing.... rather than running the tubing from the joist bays, back and forth, to one spot in the room.

A header brings a high level of flexibility to any floor joist installation.

For example, let's say your entire first floor is a single zone and that zone needs 1200 ft. of tubing to cover the entire area. Well, you can't run the water through one pipe 1200 ft long.....unless of course you want ice water to emerge at the other end. So, that 1200 ft of tubing needs to be

broken into smaller, equal circuits. For the sake of this example let's say you've divided the zone into (3) 400' circuits (or, (6) 200' circuits for that matter). If you imagine a 3/4" copper pipe running to your zone, and you further imagine tapping off that same pipe (6) times to feed each one of the (6) circuits, then you've just visualized a header. The return side is built in the same way. All the ends of your (6) circuits terminate into a common return header. In most applications, these headers are mounted perpendicular to your floor joists and you tap off of them wherever needed.

The Three Main Header Types

Type one we'll call the "**Parallel Header**". If for whatever reason you decide that your installation works best with both "supply" and "return" headers on the same side of the room, then the Parallel Header is for you. Both copper pipes are run side by side and you tee from the supply header at the beginning of each circuit, and you tee into the return header at the end of each circuit. (see drawing page 27)

The second type of header is called an "**Opposing Header**". With this method, the installer mounts the supply header on one side of the room and the return header on the other. This method is no better or worse than the Parallel Header. Which method is used depends strictly on the circuit length required for your particular installation. If the length of your joist bays is such that your circuits naturally terminate on the side of the room opposite from where your supplies begin, than use this kind of header. (see drawing page 28)

The last method is called the "**Random Header**". It is often used in situations where uneven joist bays are common. A geodesic dome comes to mind, or perhaps a home with lots of jigs and jags in the floor plan. In cases like these, you simply decide how long you want your circuits to be.....and let the supply and return ends fall wherever they may.

I'll give you a real world example of this method. You have a first floor that totals 725 sq. ft. Running the 7/8" PEX tubing at 16" centers will require approximately 543' of tubing. That will give you (2) circuits of 271 ft. each. You can take a 300' roll of tubing and thread it through the joists until you've reached the 271' mark on the tubing (stamped every five feet are length indicators showing how much tubing has been used). End the circuit at this point and start your next roll at this same spot. By the time you've reached the 271' mark on the second roll, you'll have covered the entire zone.

Of course, an alternate method would be to use a 200' roll and a coupling. Install the entire roll, then add 71 ft.

from another roll. The advantage would be that running a shorter roll is easier. If you're installing the tubing in the fall or winter and it's cold in your workspace, the 200' roll would be easier to thread through the joists than the 300' roll due to the decreased flexibility of the tubing at lower temperatures.

Naturally, this method can be applied to any number of circuits, and any length of circuit (as long as your circuits stay below the 400 ft. mark).

Also, with the "Random Header" it helps to keep the idea of "balance" in mind. In other words, since your supply and return locations are scattered somewhat randomly throughout the joist bays, you'll want to bring the main trunks of both your supply and return headers into the zone from some relatively central location (see drawing page 28). That way, when you branch off to connect the various "beginnings" and "endings" of your supply and return lines, you'll keep the "legs" of the header somewhat even in length.

PARALLEL HEADERS SETUP

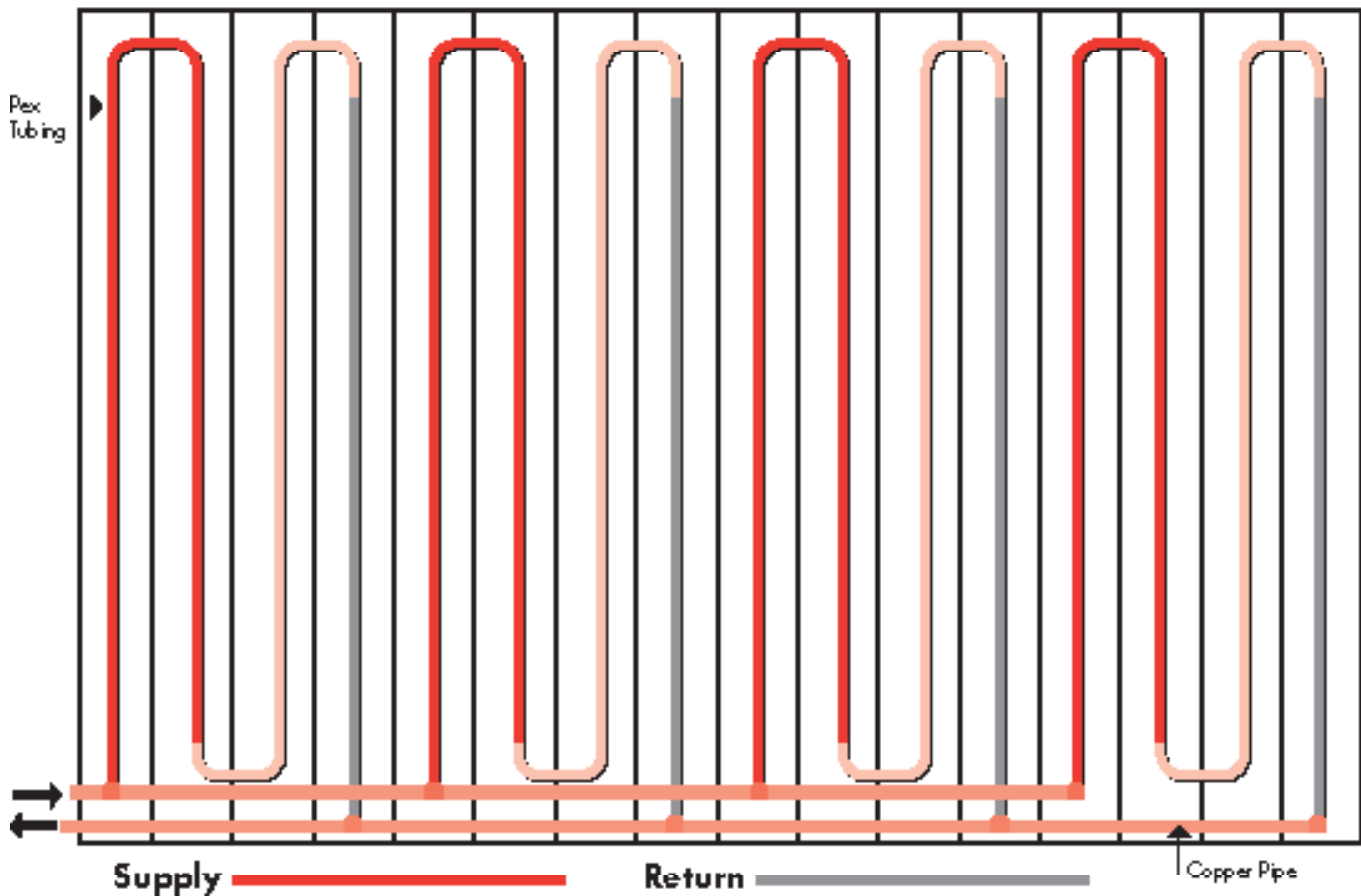

OPPOSING HEADERS SETUP

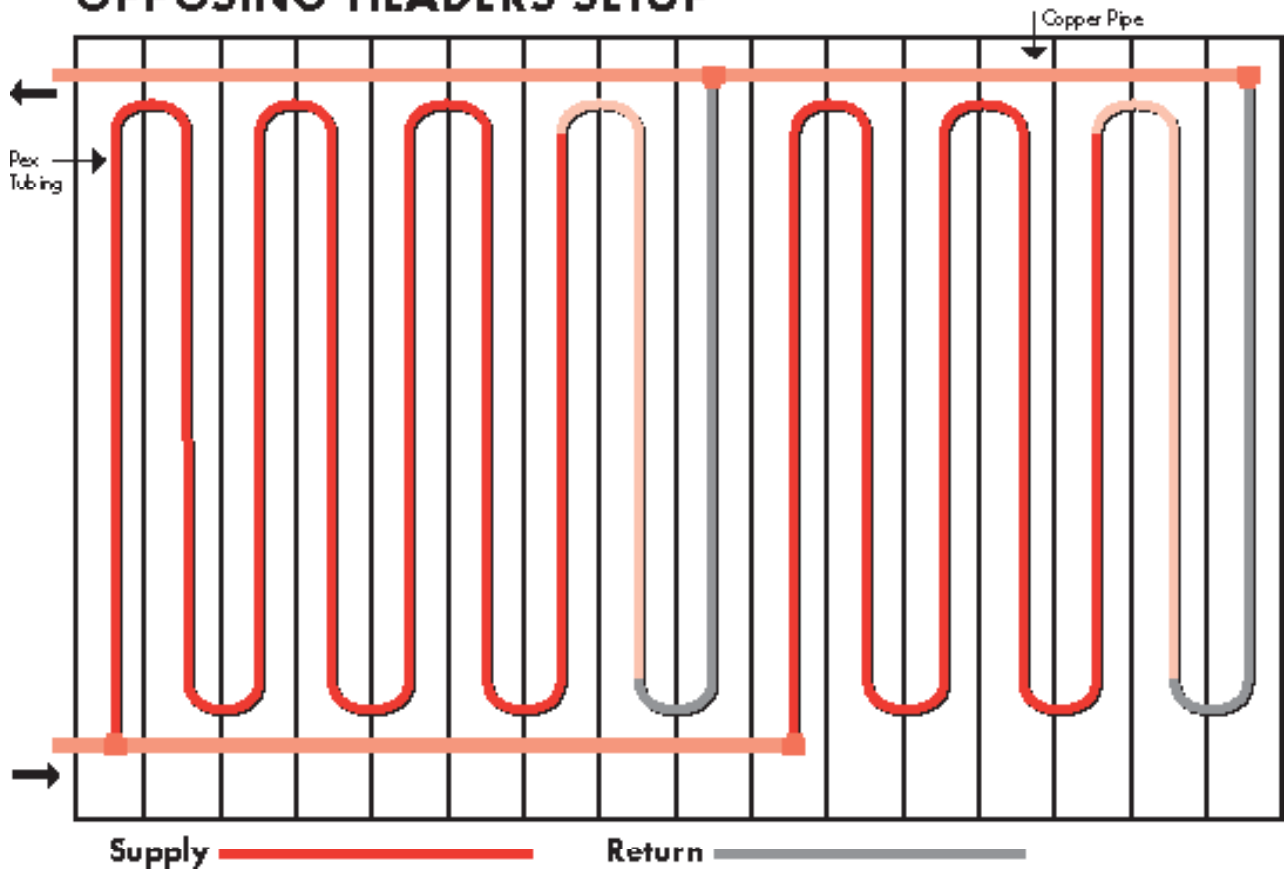

RANDOM HEADERS SETUP

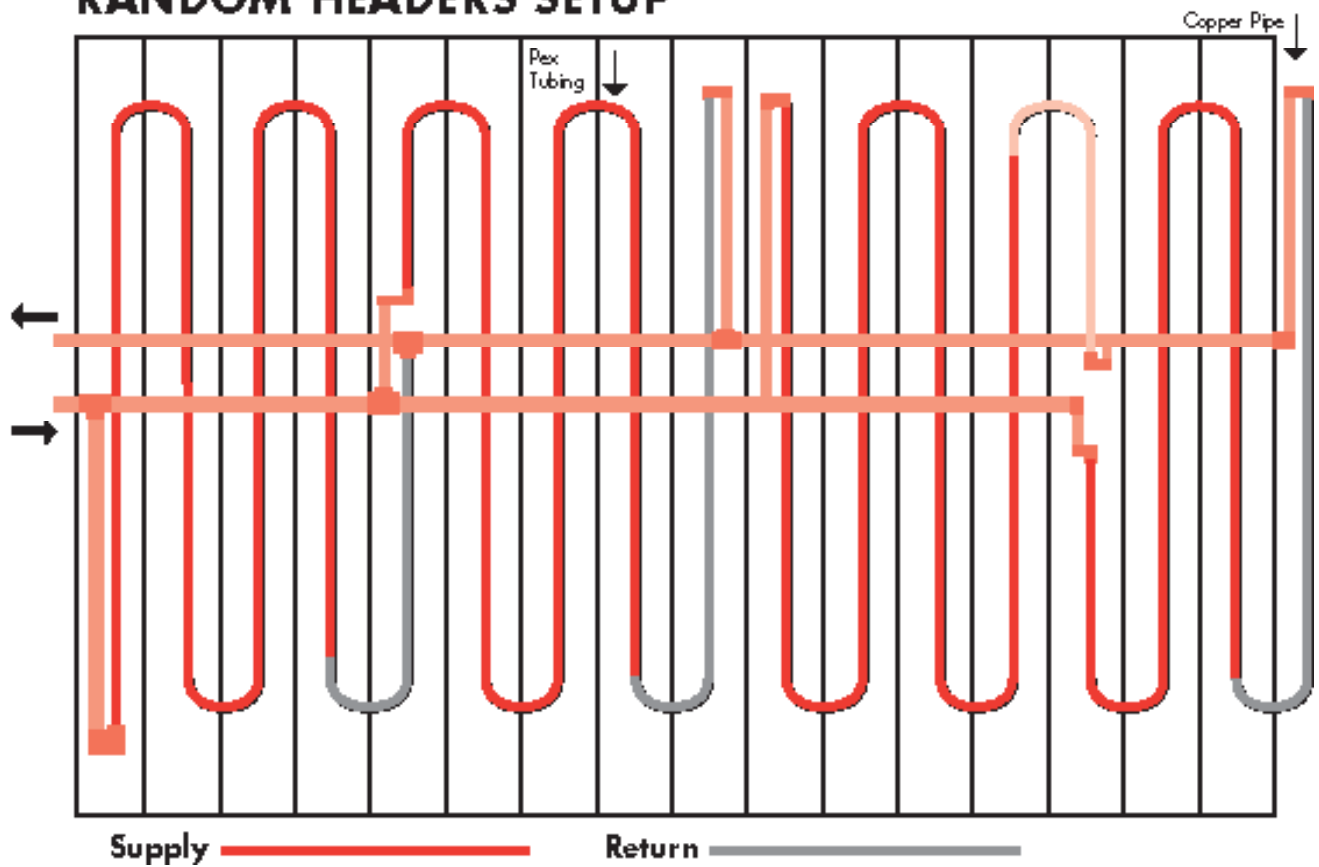

Threading the Tubing Through the Joists

The first thing to recognize about this phase of the installation is that it's not a one-person job. Many people have called us claiming to have installed the tubing by themselves and we've never questioned their honesty... just their sanity. Running multiple 200-foot loops of 7/8" PEX tubing doesn't have to be a nightmare, so why make it into one? As in most phases of construction, this project should be a two-person job.

Start by drilling your joists in the easiest possible way. A 1/2" right angle drill, with a self feed drill bit, is the best way to go. Milwaukee makes an excellent one. Use a 1.5" size, and drill the hole an inch or two below the bottom of the sub-floor.....whatever allows you to drill the holes comfortably. Remember that you'll probably be drilling a lot of them.

Now, determine which "pattern" of tubing run you wish to use. Running up and down each joist bay works fine with 16" on center joists. But, if you have 12" on center joists, you may want to try the "skip a joist" method illustrated below. This method gives the tubing the widest possible bend and, as an additional bonus, both supply and return lines will end up on the same side of the room.

If your joists are 24" on center, run one length of tubing per joist bay, then double back and repeat the process. You'll end up installing a very high performance floor, with two lengths of tubing per bay, approximately 12" on center.

Whichever method is chosen, the best results will be obtained if the tubing is used at room temperature or above. Like with all plastics, the colder the tubing, the less flexible it will be.

However, with two people working at roughly opposite ends of the room, the tubing is quite flexible enough to be snaked through the joists a few feet at a time, slowly, one worker feeding, and one taking up slack. The tubing can lie flat on the floor between the two installers. It helps to counter-spin the roll to loosen it up and help the tubing unfurl off the roll easily. Always take your tubing from the outside of the roll, never the inside.

Then, as you're slowly feeding the tubing through the joists, allow it to "gather" below the joist bay ahead of you. 15 or 20 feet of tubing can begin coiling toward the floor as you push it ahead of you. But don't "gather" too much. Give yourself just enough to get through the hole in the next joist, then feed some more, gather some more, and gradually work your way through the bays. Feed, take up slack, feed, take up slack....slowly and steadily. In this manner, two or three people can run hundreds of feet of tubing in an afternoon.

Remember, the tubing is marked every five feet and a 200-ft. roll can be cut into two 100-ft. lengths. So, figure out how many bays 100 feet will cover, then start in the center and thread the tubing 50 feet in each direction.

Another technique involves a third person whose main job is to guide the leading edge of the tubing. The two installers on opposite ends of the room feed the tubing slowly through the joist bays while the third helper prevents the tubing from snagging. Joist bays are often cluttered with blocking, wiring, drain pipes, etc. A third set of hands can make routing around these obstacles an easy task.

Our brass adaptors can be very handy also. If you find yourself needing to make a very tight bend, go up, over, or under some obstacle....or simply need to go through double joists or thick beams...then use an adaptor to convert briefly to copper pipe. While in copper mode, you can take advantage of 90's or 45's to work your way easily around trouble areas. Another adaptor will convert you back to the 7/8" PEX tubing and on you go.

In any case, if you find yourself in a situation where the tubing binds up, kinks repeatedly, or simply won't feed any further.....cut and couple later.

Skip Joist Method For Tubing Installation

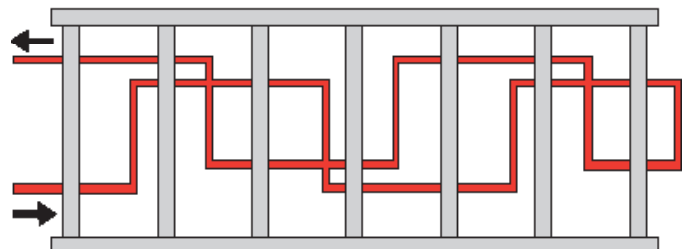

This method allows for smooth, wide turns by skipping every other joist then returning through the missed sections in one continuous loop, thus eliminating the need for a separate return run

Minor kinks, by the way, can be completely repaired by using a heat gun to almost magically return the tubing to its original form. The cross-linking process gives the tubing a sort of molecular memory. Once heat has been applied to the damaged tubing, the kink will slowly disappear.

If you don't have a heat gun, the tubing can often be repaired by using a rag and a pair of channel locks to round out the kink, then installing a couple of aluminum heat diffusion plates on either side of it. This will secure the tubing around the kinked area and prevent it from bending in any way whatsoever. Very seriously kinked tubing that appears to have lost structural integrity should be cut and repaired with a coupling.

Some people ask if they should run tubing under the refrigerator and beneath kitchen cabinets and pantries. The answer is, yes, run the tubing under the refrigerator, but wrap a length of foam insulation around the PEX to prevent the tubing from heating the floor directly beneath the refrigerator. Do the same to any tubing within 6" of your toilet's wax ring. But don't divert the tubing away from the kitchen cabinets because that only makes installation needlessly difficult. Remember, the floor is only a few degrees warmer than room temperature. The cabinets won't heat up and bake your potatoes. Instead, the cabinets become like every other object in a radiantly heated room—neutral to the touch. They will add to your comfort instead of becoming another cold mass stealing your body heat.

When all the 7/8" PEX tubing has been fed through the joists, use 1/4" staples to fasten the tubing and heat diffusion plates to the underside of the subfloor, then run your copper supply line to the beginning of each loop and connect with adaptors as described earlier. Do the same with the return line. You'll find that once the 7/8" PEX tubing has been installed, it becomes very obvious how to best run your supply and return lines. If all the supply ends of your loops have started at the same side of the room, simply run your copper there and connect, same with the return. (See page 26 "Building Headers")

If some of the loop beginnings are on one end of the room and some are on the opposite, then run a main trunk of 3/4" copper somewhere near the middle and branch off to your 7/8" PEX tubing from there. Obviously, the easiest way to run the copper supply and return lines is along the bottom of the floor joists if they need to run perpendicular to the joist bays. If they're travelling parallel with the joists, you might as well run them fairly close to the sub-floor, un-insulated, and take advantage of more floor heat.

And speaking of insulating, unless you have some reason to heat a space on the way to a zone, all supply and return lines should be insulated with wrap around foam insulation. If they run through an un-insulated crawl space or anywhere likely to be very cold, they should also have an additional wrapping of fiberglass.

Installing Radiant Tubing in Structural Trusses

Sometimes it's necessary or desirable to use trusses instead of standard floor joists. If these trusses are installed over an existing ceiling where access from below is impossible, then the tubing can be fastened to the top edge of the truss as illustrated in the photos below.



Trusses are so wide open that running 7/8" PEX through the bays becomes a very simple job.

The aluminum heat diffusion plates are heat treated to make them very malleable, like lead sheeting. They conform easily to any shape and, unlike aluminum flashing, won't spring back to their original form. That makes them ideal for many unconventional radiant tubing applications. In this instance they secure the tubing to the top edge of the truss, wrap under the lower lip where they are stapled securely, then bend over the top of the truss where they will later make direct contact with the subfloor.

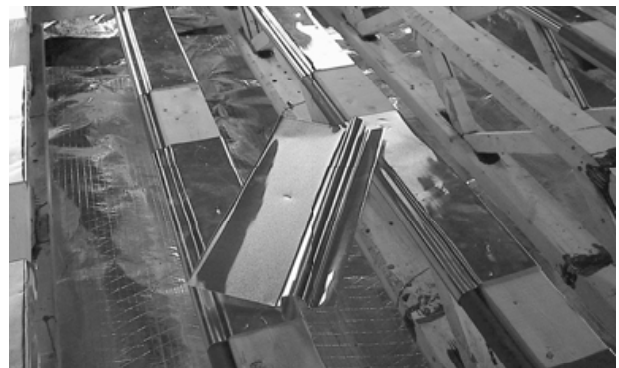

Using the plate tool provided by Radiant Floor Company, the heat diffusion plate is formed with the tubing channel offset three inches from the edge. This provides a lip for stapling along the bottom edge of the truss, a cradle for the tubing, and still allows the bulk of the plate to cover the top of the truss and transfer heat directly to the subfloor.

Because the tubing in this type of application is, by necessity, installed before the finished hardwood floor, it's very important to snap chalk lines onto the subfloor **while** it is being installed. The chalk lines indicate the exact center of the truss so that later, when the hardwood is nailed down, all floor nails follow the chalk line and stay clear of the tubing.



These 9" trusses are insulated from the floor below with 6" of fiberglass that has been covered with a layer of radiant reflective barrier. This guarantees that the radiant heat will flow up into the newly remodeled master bedroom.

The Aluminum Heat Diffusion Plates

Once the tubing has been threaded through the floor joists, aluminum heat diffusion plates are used to attach it to the bottom of the sub-floor. The plates are made of pure, heat-treated aluminum to make them very malleable like lead sheeting. They are silent, easy to staple to the subfloor and not only hold the tubing securely, but also draw its heat away and spread warmth evenly over the sub-floor. That's why a close contact between plate and tubing is very important. Recent studies by the American Society of Heating, Refrigerating and Air-Conditioning Engineers, Inc. (ASHRAE), conducted at the University of Kansas, have concluded that heat diffusion plates increase the transfer of heat to the occupied space by almost 175%.

Use the plates to fasten the tubing to the bottom of the sub-floor. Generally, the plates are stapled with 1/4" staples. Ten or twelve staples per plate will work well. Also, try to keep the plates approximately 4" away from any adaptors or couplings. Under bathrooms, pergo and carpeted areas, run the plates continuously along the tubing. Under tile, slate, wood, etc., the plates can be spaced every 8". For maximum coverage, radius plates can be installed around the bends.

Just keep in mind that running the plates continuously under any floor serves to enhance the overall performance of the system. If maximum heat diffusion and a very responsive floor are your goals, then there's no such thing as too many plates.

Connecting Adaptors and Couplings

Adaptors are the brass fittings used to connect PEX tubing to 3/4" copper pipe. Since the adaptor is designed to sweat onto a stub of pipe, it can be used in conjunction with any fitting your installation demands...a copper tee, an elbow, or a coupling.

To use an adaptor, first prep the fitting for soldering by sanding and fluxing both the female end of the adaptor, and the stub of 3/4" pipe it will be soldered to. Needless to say, never attach the PEX tubing to the adaptor before the soldering operation is completed.

Once the adaptor has cooled, the nut and ferrule (brass ring)

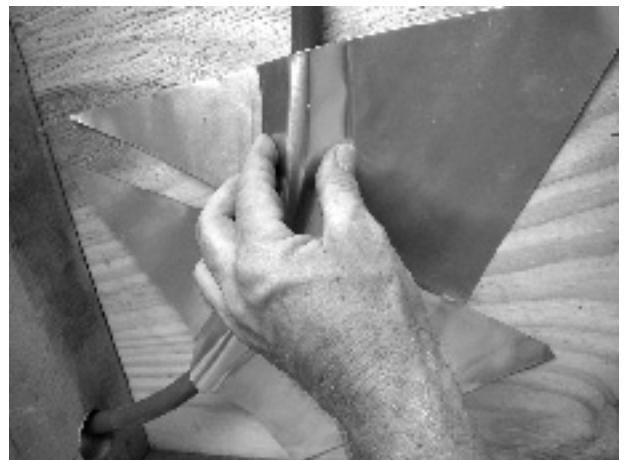

Radius plates are easily hand-formed around the bends

on the threaded end of the adaptor can be slipped onto the PEX, then the PEX can be connected to the adaptor and the nut tightened. Some people don't even take the nut and ferrule off the adaptor. They simply loosen the nut and carefully slip the PEX into the adaptor. Regardless of your approach, when you get the PEX inserted into the adaptor, hand tighten the nut, and then use a wrench to tighten the nut about $\frac{3}{4}$ of a turn further. There is no need to over-tighten, but you want the nut good and snug.

Obviously, since couplings are used to connect two pieces of PEX, there is no soldering involved. However, when it comes to attaching the PEX to the brass fitting, the coupling is pretty much identical to the adaptor... i.e., nut, ferrule, and tighten $\frac{3}{4}$ past hand tight. Whenever possible, avoid installing couplings on a tight bend. To achieve the best possible connection, the PEX should align squarely into the fitting.

Installing the Radiant Barrier

In all floor joist applications, a reflective barrier is required to direct the infrared heat spectrum up toward the radiant floor. Simple aluminum foil purchased from the supermarket will work, but its tendency to tear and puncture makes it unsuitable for construction purposes. For ease of installation, we recommend a pure aluminum reflective barrier manufactured with embedded poly fibers to resist tearing. Foil faced fiberglass or rigid foam boards are excellent too because they not only reflect the infrared heat, but also add thermal resistance and incline the heat to flow up to the floor. Unfortunately, foil faced fiberglass is often very hard to find and foil faced rigid insulation is very expensive. As a result, most people insulate below the radiant tubing in the following manner.

Drop down and install the radiant barrier at least 1" below the tubing, but ideally no lower than 2". Fill the rest of the joist bay with insulation. The best way to do this is as follows.

Since the rolls of radiant barrier are 48" wide, you'll save a lot of time by clamping the entire roll in a vise, or hanging it over a sawhorse, marking 16", and cutting the entire roll with a Sawzall or handsaw. Do this twice and you'll end up with three pre-cut sections, each 16" wide. Then, simply roll the reflective barrier out to match the length of your fiberglass insulation, lay it on top of the fiberglass so the shiny surface faces the radiant tubing, then push both the insulation and barrier material up into the joist cavity. Just be careful not to push the barrier directly up against the tubing. The 1" air space is important.

Filling the Closed System

Air trapped within a closed radiant system is the most common cause of inefficient system performance. Fortunately, it's an easy problem to solve and won't become an issue at all if care is taken during the initial filling process.

Take a moment to study the Expansion and Purge Kit. Normally, hot water enters from the left, travels through the Expansion and Purge Kit (EPK), and enters the Zone Manifold. From there, the water is drawn by the circulator pumps, through each individual zone, then back to the heat source. A closed system circulates the same fluid around and around, and is completely separate from the domestic water supply.

You will notice that there are three valves on the Expansion and Purge Kit...two boiler valves and a ball valve. (see photo page 16) The first boiler valve is located to the right of the expansion tank. For the sake of this description, we'll call this the **drain valve**. It is used to evacuate air from the radiant system. The second boiler valve we'll call the **fill valve**. It is located to the left of the expansion tank. Please note that either of these valves can act as fill or drain. Which function the valve serves depends upon whether the pump or pumps are located to the right or left of the EPK. In other words, you always want to fill the system in the direction of the circulator pumps. Between the drain and fill valves is a **shut off valve**. Closing this shut off valve during the filling process will force the water introduced into the fill valve to travel past the pumps, through the floor tubing, into the hot water tank or boiler, then out the drain valve. The close proximity of the drain and fill valves to each other guarantees no air pockets in the system.

A multi-zone closed system should be filled one zone at a time, and if the individual circuits within each zone are valved, purge one circuit at a time. The idea is to focus the water pressure as specifically as possible.

Using the ball valves located before each circulator pump on each zone, close off every zone but #1. Next, attach a garden hose to the drain valve and run it to a convenient sink, floor drain, outside, or wherever you want many gallons of discharge water to go.

An additional step that many installers find useful is to place a 5-gallon bucket in one of the above locations and let the water overflow out of the bucket before entering the drain. The advantage to this method is the visual indication of air bubbles. Often, the stream of water coming from the discharge hose looks purged of air -- simply because the hose has stopped spitting and sputtering. But I can assure you that plenty of air remains. By holding the end of the discharge hose under water in the

5-gallon bucket, stray bubbles are impossible to miss.

- Close the **shut off valve**.
- Attach a second garden hose to the **fill valve**. We've included a brass female to female hose thread fitting to make it easy to connect the male end of your garden hose to this valve. This fitting can be used on either of the boiler valves, depending upon which of the two becomes the fill valve.
- You are now ready to purge the air out of zone #1.
- Using full house pressure or a powerful utility pump, flood the zone.

If you are using a new or empty tank-type water heater, you'll be filling the tank during this procedure as well, so expect zone #1 to take the longest to fill. Any remaining zones will only be flushing air out of the floor tubing and the process will be much faster.

Observe the drain hose. Depending upon how large your hot water tank is, several minutes can pass without any water whatsoever discharging from the drain line....only air. Eventually, water will begin flowing, often in spurts and sputters. Be patient. A steady stream of water doesn't necessarily mean that all the air is out of the system. A good rule of thumb is: once it **seems** that all the air is out of the zone, let a continuous stream of water flow one minute for every 100 feet of tubing in the zone. Sometimes, water can actually flow around a pocket of air, especially in a radiant system where many curves and bends are normal. However, given a few minutes of water flow, even the most stubborn bubble will break up and flow out the discharge hose.

It's also a good idea to listen carefully to the water flowing through the system. In a floor joist system, quite often, as the water passes through the floor the air pockets are audible as they pass through the tubing. In a slab installation, the initial water and air emerging from the slab into the return manifold is quite noisy. Also, listen for any sounds coming from the hot water tank. Your goal is silence. In a properly charged radiant system, no sound whatsoever is audible.

You may also want to run your zone pump during this point of the procedure. If any air is trapped in the impeller, the force of the water now flushing the system will dislodge it. You only need to run the pump for half a minute or so to accomplish this. And remember, cast iron circulator pumps are so quiet you have to touch them to know they're on. Stainless steel pumps emit a very slight, nearly inaudible hum. In either case, if your pumps are noisy, then air is present.

So, when the water is flowing steadily out the drain hose and all audible indications of air in the zone have stopped, you're ready to repeat the procedure with the remaining **zones**.

Open the ball valve before zone pump #2, and **close** the ball valve before zone pump #1. Remember to allow at least one minute of water flow per 100 feet of tubing in the zone and, as in zone #1, be certain that all audible indications of air are absent.

When, after several minutes, the water is flowing steadily from the drain hose, close the valve before zone pump #2 and open the valve before zone pump #3. Repeat this procedure for all remaining zones.

The last step, once all the zones are flushed, is to close the **drain valve** on the Expansion and Purge Kit and observe the pressure gauge. As soon as you close the drain valve, the pressure from the house supply entering the fill valve will begin pressurizing the radiant floor system. When the pressure gauge reads 15 psi, close the fill valve. This is your cold system pressure. When the system is hot the pressure



To charge a closed system with fluid, connect a ½ hp utility pump to the Expansion and Purge Kit. Immediately after starting the pump, open both the "fill" and "drain" valves, then close the "isolation" valve between them. When the system is free of air, charge the system to 15-20 psi

will be a few psi higher. A positive pressure in the system will guarantee that any remaining air in the tubing, or any gassing off during normal operation, will be purged by the air eliminator.

Note: The cap on top of the air eliminator should always be **open** during normal operation. **Open the shut off valve between the fill and drain valve.**

Your heat source is now ready for firing.

Filling a Closed System with Anti-Freeze

The previous procedure should be followed to eliminate all air from the system. When that has been accomplished, one additional step is required.

Determine how much Propylene Glycol (not automotive Ethylene Glycol) your system requires by adding the total amount of fluid in the tubing (2.7 gallons per 100 ft. of 7/8" PEX1.3 gallons per 100ft of 1/2" PEX) plus the volume of water in the water heater or boiler.

Determine what percentage of anti-freeze to water mixture is recommended by the manufacture. Some recommend 30 % anti-freeze, other's 50%. The proper mix is also influenced by the degree of low temperature you wish to protect against. Once the proper amount of undiluted anti-freeze has been calculated, place your first few gallons into a clean five-gallon bucket and use a utility pump to pump it into the system. Continually replenish the five-gallon bucket with anti-freeze.

All the valves before all zone pumps should be open. This will help diffuse the anti-freeze evenly into each zone. When the anti-freeze is gone, close the drain valve.

Later, when the system is running, the Zone Manifold (in the case of a heat exchanger system) or the storage tank (in a standard closed system) will act as a "mixing station", further blending the anti-freeze into the pure water already in the system.

All that remains now is to pressurize the system. Reconnect the house supply to the fill valve (remember to flood the garden hose with water before reconnecting to the fill valve. This will avoid injecting air from the hose into the system), pressurize to 15 psi, then close the fill valve.

Your heat source is ready for firing.

For single zone radiant systems using heat exchangers, or for solar collector loops, the anti-freeze must be mixed in advance because, obviously, there's no tank or manifold to commingle fluid from one zone into another. By the way, some anti-freeze is pre-mixed, others are in concentrate form. Be sure to check the label before adding water. However, pre-mixing in these situations is rarely a hassle. In large systems, you pretty much need pure water and the power of house pressure to blast air from large amounts of tubing. But a single zone or a solar collector loop is usually short enough to purge with a small pump.

In these cases, simply fill a clean five gallon bucket with pre-mixed anti-freeze (if you need more than five gallons, have

one or more clean buckets mixed and handy), draw from the bucket into the zone or collector loop, and run the drain hose from the EPK into the same bucket. When the air in the zone or loop stops bubbling into the bucket, close the drain valve and pressurize the system with the pump.

How much pressure? As indicated above, a standard closed radiant system uses 15 psi. But for solar collector loops, use this formula:

Measure the height from the EPK to the highest point of the solar collector. Divide this number by 2.3. Then add 5.

Example: The header (high point) of your Seido evacuated tube collector is on your roof 27 feet above the solar EPK located in your basement. 27 divided by 2.3 equals 11.73. Add 5 to that figure and the formula tells you that the pressure in the collector loop should be about 17 psi.

Filling the Open System

The open system is plumbed into the home's domestic water supply, so the best way to fill new radiant tubing is to open a HOT water valve somewhere in the house.

When hot water is drawn from the domestic hot water tank, cold water flows in to replace it. But instead of going directly to the water heater, in an open radiant system, the fresh make-up water flows through the radiant tubing first (see P. 3 for a detailed explanation of this process). This eliminates any possibility of stagnation in the system, yet still has no detrimental effect on the heating system. So, as a result of this plumbing configuration, only the hot side of your domestic system can purge air from the newly installed radiant tubing.

Also keep in mind that, in addition to the tubing, a brand new empty water heater is full of air, so expect this purging process to last several minutes.

If you're adding a radiant zone to an existing water heater, you may have to sacrifice some hot water in order to rid your radiant tubing of air. However, once the system is charged with water, you'll most likely never have to do it again.

Open systems are basically part of the domestic plumbing system. They operate at the same pressure as the house supply, generally around 40 to 60 psi.

Radiant Dictionary

Adaptor
Air Eliminator
Anti-Freeze
Bleeding the System
BTU
Circuit
Circulator Pump
“Closed System”
Coupling
Dry Mix
Extruded Polystyrene Foam
Expansion Tank
Expansion and Purge Kit
Glycol
Gypcrete
Header
Heat Diffusion Plates
Heat Exchanger
“Heat Exchanger System”
Heat Source
Loops
Mixing Valve
“Open System”
PEX Tubing
Pressure in System
Pressure Testing
R-Value
Recovery Rate
Radiant Barrier
Resistance
Return Line
Slab Manifold
Sleepers
Staple-up System
Supply Line
Suspended Slab
Thermal Mass
Tubing Sizes
Zone
Zone Manifold

Adaptor

Brass fittings used to convert from ¾” rigid copper pipe to PEX.

Air Eliminator

A device for removing small amounts of air from a closed radiant system. An important component of the Expansion and Purge Kit.

Anti-Freeze

For the purposes of radiant heat, only Propylene Glycol is recommended.

Bleeding the System

Removing air from a closed radiant system using the Expansion and Purge Kit. For more information refer to the Installation Details, Details, Details section of this manual and read “Filling the Closed System”.

BTU

British thermal unit. A way of measuring heat energy. Or if you want to get technical: the quantity of heat required to raise the temperature of 1 pound of water by 1 degree F.

Circuit

A length of tubing within a zone. Also called a “loop”. Often many circuits of the same length constitute a zone.

Circulator Pump

A small, low wattage water pump used to circulate heated fluid through tubing in a radiant system.

“Closed System”

A radiant heating system that uses a dedicated heat source to warm a space. A closed system re-circulates the same fluid around and around in a continuous circuit, completely separate from the domestic water supply.

Coupling

A brass fitting used to repair or connect a section of PEX.

Dry Mix

A mixture of 4 parts sand and 1 part Portland cement often used as thermal mass in a “suspended slab” installation. For more information refer to the Installation Details, details, details section of this manual and read “The Suspended Slab Installation”.

Extruded Polystyrene Foam

A rigid insulation often called Pink board or Blue board and used to insulate around the edges of, and below, radiantly heated slabs. It is used primarily for its high R-value and resistance to water saturation.

Expansion Tank

A tank containing a pre-pressurized rubber membrane. It is used in closed radiant systems to absorb the expansion of water that results when liquid is heated from cold to hot.

Expansion and Purge Kit

A pre-assembled component containing fill and drain valves, expansion tank, air eliminator, pressure gauge, and pressure relief valve. Its function is to facilitate the removal of air from the newly installed radiant tubing and maintain a balanced and efficient heating system.

Glycol

Anti-freeze, either Propylene (non-toxic/domestic use) or ethylene (toxic/automotive use) glycol.

Gypcrete

A lightweight concrete product often used when pouring a thin slab over an existing floor.

Header

A copper “supply” or “return” line used mainly in radiant staple-up systems. Basically an elongated site-built manifold, headers are useful because they allow the installer to tap off of a single, long copper line to feed multiple circuits of tubing within a single zone. Headers bring the heated fluid to the circuits instead of forcing each circuit to return to a small, centralized manifold. This method prevents congestion and snarl and gives the installer more flexibility in the placement of feed and return lines.

Heat Diffusion Plates

Pure aluminum plates, 16” long by 8” wide, used to attach radiant tubing to the underside of a heated floor. The thermal properties of aluminum guarantee that heat drawn from the tubing will transfer efficiently to the floor.

Heat Exchanger

A device used in some radiant systems to separate dissimilar fluids such as anti-freeze and water. Heat exchangers transfer heat from one fluid to another without allowing direct contact between the fluids.

“Heat Exchanger System”

A type of radiant heating system that uses a heat exchanger to separate the anti-freeze in the floor from the potable domestic hot water supply. This allows one heat source to provide hot water for both applications.

Heat Source

A water heater or boiler used to provide 120 to 135 degree water to a radiant floor. A heat source can be fed by any fuel, including gas, solar, wood, geo-thermal oil, or electric.

Loops

(see circuit)

Mixing Valve

A device used to supply a consistent, much lower, pre-regulated water temperature to a radiant system. Mixing valves are most often used in conjunction with high temperature boilers, many designed to heat water to temperatures in excess of 160 degrees. In radiant floor applications, mixing valves do not lower the boiler temperature. Instead, they are plumbed so that the water returning to the boiler from the heated floor branches off to the “cold” side of the mixing valve. In this way the “return” water, after losing much of its heat to the living space, is re-heated to the proper temperature by bleeding small amounts of super hot boiler water into the mixing valve.

“Open System”

A radiant system integrated into the home’s plumbing system. In other words, the same water that ends up in your hot shower has passed through the floor first. Open systems use one heat source to heat both the floor and the domestic water. It’s an efficient system because one properly sized water heater doing two jobs eliminates the “standby loss” of a second unit.

PEX Tubing

Slang for cross-linked Polyethylene tubing. PEX tubing retains many of the heat exchanging properties of copper, but exhibits much greater flexibility and longevity. According to the Radiant Panel Association, “cross-linking dramatically improves a large number of properties such as heat deformation, abrasion, and chemical and stress resistance. Impact and tensile strength are increased, shrinkage decreased and low temperature properties are improved. Cross-linked tubes also have a shape memory which only requires the addition of heat to return it to its original shape when kinked”. PEX tubing will last well over 100 years when used in radiant heat applications.

Pressure in System

“Closed” radiant systems circulate the same fluid around and around in a closed circuit, using the fluid as a heat transfer medium. A “closed” system generally operates at a pressure of around 15-psi. “Open” systems are basically part of the domestic plumbing system. They operate at the same pressure as the house supply, generally around 40 to 60-psi.

Pressure Testing

A feature built into a slab manifold. It is used to test for leaks prior to pouring a concrete slab and for maintaining a positive pressure in the tubing during the pour.

R-Value

A material and its ability to resist heat flow. Fiberglass has a very high R-value. That’s why it’s used in walls to slow the transfer of heat to the outside. Wood has a very low R-value. That’s why the walls need the fiberglass.

Radiant Barrier

Generally a paper thin, pure aluminum material used to reflect 97% of the infrared heat spectrum back up to the heated floor. For more information refer to the Installation Details, details, details section of this manual and read “The Floor Joist Installation”.

Recovery Rate

Basically, how fast a water heater or boiler can heat water. Recovery rates are generally measured by how many gallons of water can be raised 90-degrees in one hour. If a water heater, for example, stores 50 gallons of water, a good recovery rate would be the ability to heat 1 ½ times its storage amount within one hour. In other words, it could heat 75 gallons each hour. The best water heaters on the market can heat almost three times their capacity.

Recovery rate is important in radiant systems because the water in the radiant tubing cools down to room temperature between heat cycles. Depending on the size of the “zone”, this could be as much as 20 or 30 gallons of water. So, when the system kicks on, this 70-degree water enters the water heater and “dilutes” the temperature. A water heater with a good recovery rate will heat the water back up quickly and return the radiant system to its desired operating temperature (125 degrees).

Gas and oil fired water heaters offer the quickest recovery rates, electric water heaters the slowest.

Resistance

In radiant heating applications, resistance refers to pressure within multiple circuits of tubing. In practice, this simply means that all circuits should be the same lengths, within about 10%. No single circuit should be shorter than the others and thereby offer the water a “path of least resistance” to follow. With even circuits, water flows through the system in a balanced fashion and distributes heat evenly throughout the zone.

Return Line

An insulated copper line leading back to the heat source.

Slab Manifold

A copper manifold used to distribute heated fluid to a concrete slab. Slab manifolds come in many configurations, the simplest being the “1-loop” manifold. This is simply a supply connection to a single loop of tubing and its return. A “6-loop” manifold is generally the largest. Bigger than “6-loop” and the manifold becomes unwieldy. Imagine 6 supply connections and 6 return connections on one manifold and you’ll get the idea. Super large zones will often use multiple manifolds spaced throughout the heated space to achieve coverage.

But slab manifolds should do more than split one supply and one return into multiple branches. An important component of a slab manifold is the pressure-testing feature. Testing for leaks prior to pouring a slab is mandatory.

Also, the box containing the manifold acts as the form around which you pour the concrete. This creates a “manifold well” in the finished slab and keeps the multiple connections below floor level. Everything remains visible and accessible, but only the supply and return pipes stick up above the slab. Concrete never touches the copper manifold.

Sleepers

Strapping placed on an existing floor to create “sleeper bays” in which to run radiant tubing. Most often, 2 by 4’s laying flat, 16” on center, act as the best sleepers. They raise the floor 1 ½” and allow adequate room for even the largest tubing. Sand or concrete is generally placed over the tubing, between the sleepers, and the sleepers

are then used to: 1) screed across in the case of a concrete floor, or 2) for nailing the finished floor to. Refer to the Installation Details, details, details section of this manual and read “The Suspended Slab Installation”.

Staple-up System

A radiant system attached to the bottom of the sub-floor. For more information, refer to the Installation Details, details, details section of this manual and read “The Floor Joist Installation”.

Supply Line

Generally, an insulated copper line used to feed multiple circuits of tubing. Or, any water line running from the discharge side of a radiant circulator pump.

Suspended Slab

A radiant system installed on top of an existing floor. For more information, refer to the Installation Details, details, details, section of this manual read “The Suspended Slab Installation” section.

Thermal Mass

In the context of radiant heat, materials capable of storing heat energy. Concrete, sand, slate, and tile possess a greater thermal mass than wood. The greater the mass, the longer stored heat will remain in the floor.

Tubing Sizes

For most practical applications, two tubing sizes are best. 7/8” PEX and ½” PEX offer the greatest flexibility. The 7/8” PEX provides the highest heat output (50 BTU’s per ft.) and can be spaced 16” on center. But a compromise is made when it comes to bending radius. However, in a wide open slab environment, bending radius is not a problem. In floor joists, spacing of 16” on center or greater is the most practical use for the 7/8” size.

The ½” PEX (25 BTU’s per ft.) can also be used in virtually any application, but it should be spaced 8” on center. It will heat the same as the 7/8” PEX tubing, but you have to use twice as much of it. It can raise the cost of a radiant system substantially.

Zone

Any heated area regulated by one thermostat and supplied by one circulator pump. One zone may contain many parallel circuits of tubing, literally thousands of feet of tubing, and encompass an entire living space, but the whole area will maintain the same, even temperature.

Zone Manifold

Most often a factory built manifold that contains ball valves, check valves, in line thermometers, pump flanges, drain valves, and all the plumbing hardware necessary to effectively distribute heated fluid to multiple heating zones.

*For more information, photos,
FAQ's, and a Radiant Dictionary,
go to www.radiantcompany.com*

*Most affordable "Do it yourself"
Radiant Floor Heating System
on the market!*

**HOURS:
Monday thru Friday 8am - 6pm**

**Radiant Floor Company
Barton, Vermont**

Fax: 1-802-525-3940

1- 866-WARM-TOES

1-866-927-6863

1-802-525-1132

www.radiantcompany.com