



EDUS371705A-N

R-410A

Engineering Data

VRV Aurora Series

Installation

RELQ-TATJU, 208 / 230 V, 60 Hz

RELQ-TAYDU, 460 V, 60 Hz

RELQ-TAYCU, 575 V, 60 Hz



Installation of Outdoor Units

1. Features and Benefits	2
2. Center of Gravity	3
3. Foundation Drawing	4
4. REFNET Pipe System.....	5
4.1 Layout Example.....	5
4.2 REFNET Joints and Headers	7
5. REFNET Joint and Header.....	9
5.1 REFNET Joint (Branch Kit)	9
5.2 REFNET Header (Branch Kit)	28
5.3 Outdoor Unit Multi Connection Piping Kit	48
6. Caution Label	59
6.1 RELQ72-120TATJU / RELQ72-120TAYDU / RELQ72-120TAYCU.....	59
 Appendix 1. Installation Manual	
RELQ-TATJU / RELQ-TAYDU / RELQ-TAYCU	A1

1. Features and Benefits

The new *VRV* Aurora Series heat recovery unit demonstrates Daikin's technological leadership by offering the first *VRV* air cooled system that delivers effective and efficient heating down to -22°FWB (-30°CWB).

- Available in 6, 8, 10 ton single modules and 12, 16, 20 ton multi-module systems
- First Air Cooled *VRV* system to deliver heating down to -22°F (-30°C) as standard
- Daikin's patented inverted based vapor injection compressor delivers high heating capacity of up to 100% at 0°F (-18°C), up to 85% at -13°F (-25°C) and up to 60% at -22°F (-30°C)
- Refrigerant cooled efficient and stable inverter board operation, independent of ambient conditions
- Hot gas base pan circuit allows installation without additional drain pan heater
- Added peace of mind with ability of Auto changeover to back up (auxiliary) heat
- Year round comfort and energy efficiency delivered by combing *VRV* and Variable Refrigerant Temperature (VRT) technologies
- Designed and optimized for Total Cost of Construction (TCC) and reduced Life Cycle Cost (LCC)
- Corrosion resistant, 1000 hr salt spray tested Daikin PE blue fin heat exchanger
- Ships factory standard with coil guards
- Compatible with the full suite of *VRV-IV* T-series Branch Selector Boxes
- Seamless connection to all *VRV* M, P and T series indoor units
- Ease commissioning with ability to program settings off site using new configurator tool
- 3-digit 7-segment digital display on the unit for improved and faster configuration, commissioning, and troubleshooting
- Backed by 10 year parts limited warranty and 10 years replacement compressor limited warranty *



* Complete warranty details available from local distributor or manufacturer's representative *

2. Center of Gravity

RELQ72TATJU / RELQ72TAYDU / RELQ72TAYCU

Unit : in. (mm)

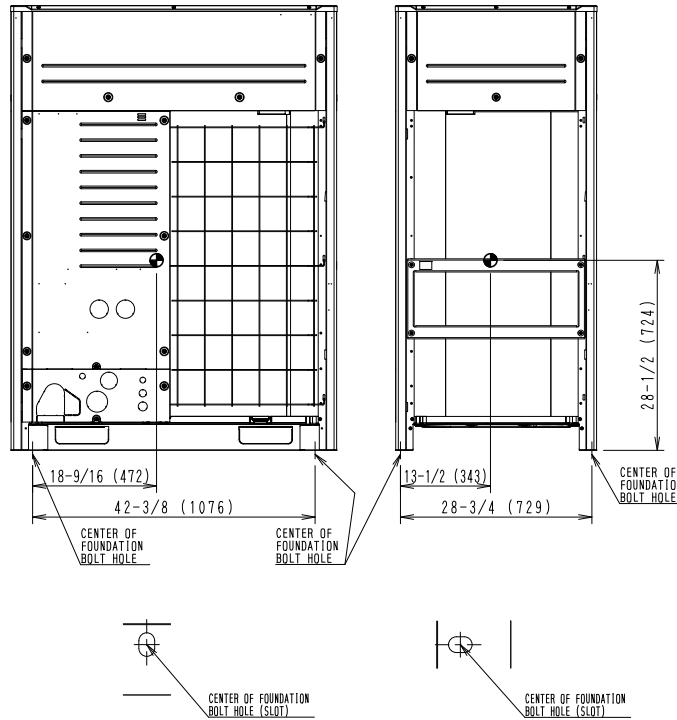

4D107384

RELQ96TATJU / RELQ96TAYDU / RELQ96TAYCU RELQ120TATJU / RELQ120TAYDU / RELQ120TAYCU

Unit : in. (mm)

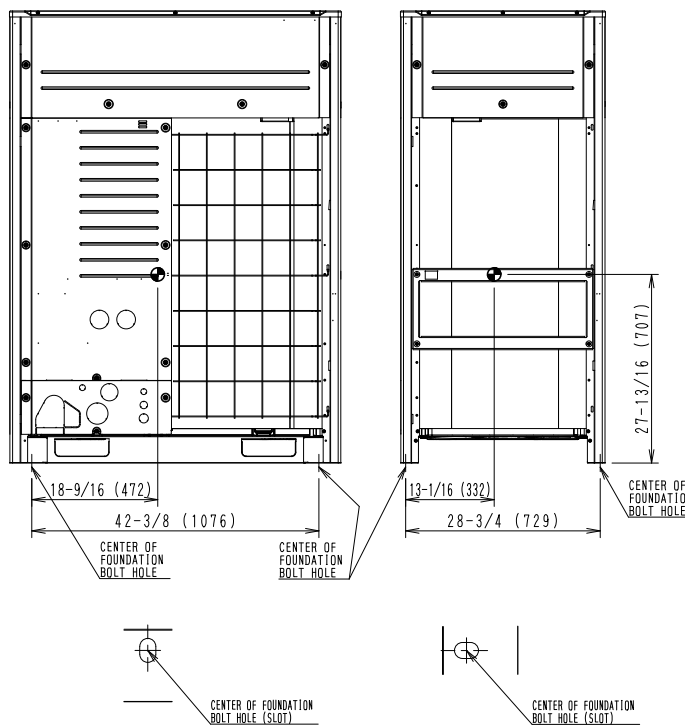

4D107385

3. Foundation Drawing

RELQ72TATJU / RELQ96TATJU / RELQ120TATJU
 RELQ72TAYDU / RELQ96TAYDU / RELQ120TAYDU
 RELQ72TAYCU / RELQ96TAYCU / RELQ120TAYCU

Unit : in. (mm)
 Foundation bolt type:JA
 Size:M12
 Four bolts are required

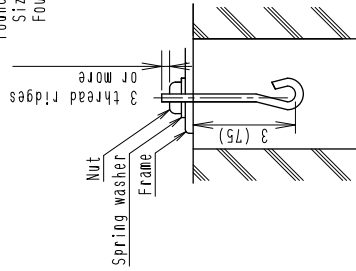

Foundation bolt executing method

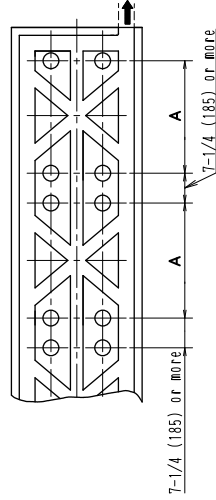

When installing multiple units in connection

Model	A	B
RELQ72, 96, 120TAYCU	42-3/8 (1076)	51-1/4 (1302)
RELQ72, 96, 120TATJU		
RELQ72, 96, 120TAYDU		

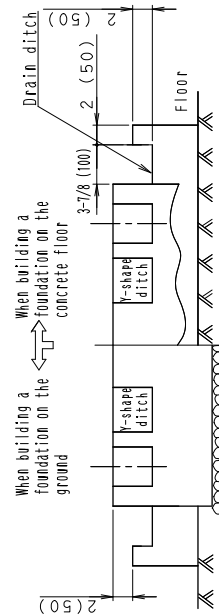
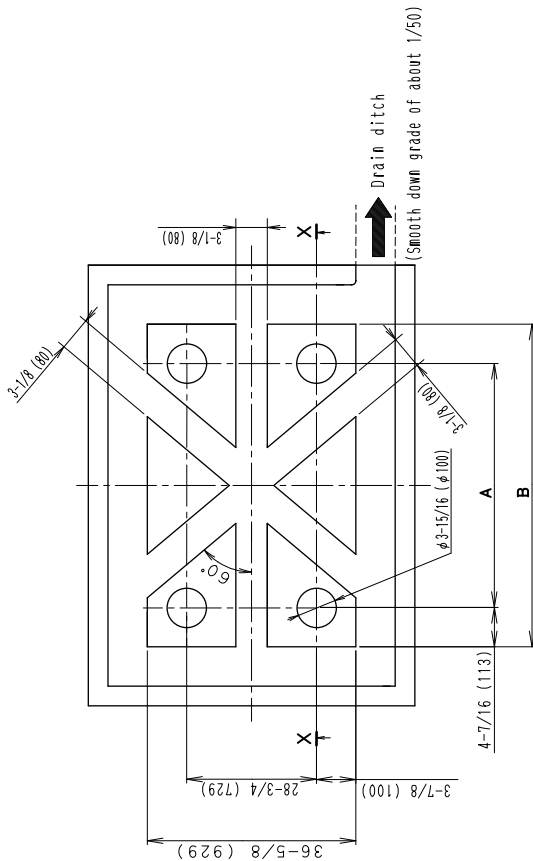

X-X cross section

(Notes)

- The proportions of cement:sand:gravel for the concrete shall be 1:2:4, and the reinforcement bars that their diameter are 3/8in (10mm), (approx. 11-3/4in. (300mm) intervals) shall be placed.
- The surface shall be finished with mortar. The corner edges shall be chamfered.
- When the foundation is built on a concrete floor, rubble is not necessary. However, the surface of the section on which the foundation is built shall have rough finish.
- A drain ditch shall be made around the foundation to thoroughly drain water from the equipment installation area.
- When installing the equipment on a roof, the floor strength shall be checked, and water-proofing measures shall be taken.

C: 3D085480C

4. REFNET Pipe System

4.1 Layout Example

4.1.1 Heat Recovery System

Use of the particular branch fitting appropriate to each individual unit type not only permits the pipes to be laid with ease but also increases the reliability of the system as a whole.

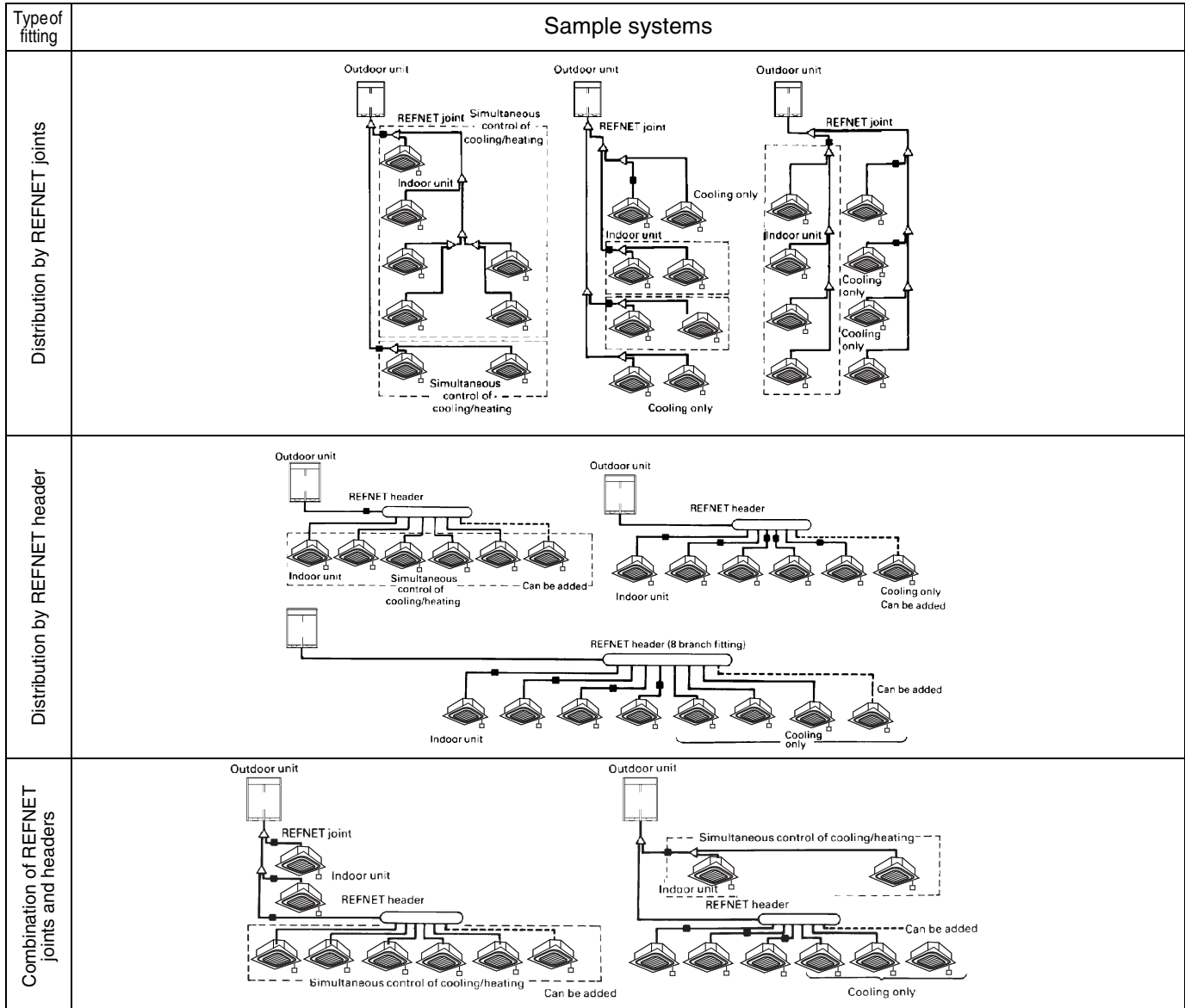



Units can be added by connecting them directly to the REFNET header or REFNET joint. Further branches cannot be included in the system below the REFNET header branch.

Notes:

1. When the capacity ratio of the indoor system to the outdoor unit is more than 100% and when all the indoor units are in operation at the same time, the rated capacity of each unit will be somewhat reduced.
2. Special purpose REFNET pipe components must be used for all the pipe work. For further details concerning choosing components, see REFNET and Piping Selection Rules.
3. The Daikin REFNET kits are supplied with insulation intended to fit over the main body of the REFNET joint after installation of the REFNET kit is complete.
4. **IMPORTANT:** In applications where the REFNET kits are installed in an environment requiring fire-rated materials to be used, it is necessary for the installer to obtain from a third party supplier and to utilize, for insulation, fire-rated materials that meet all applicable building codes and other requirements. The Factory-provided insulation that is supplied with the REFNET kit should be discarded in a manner meeting all applicable laws.

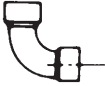
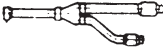
4.1.2 Equivalent Piping Length of Joints and Headers (Reference)

Pipe Size *	φ 1/4 in. (φ 6.4 mm)	φ 3/8 in. (φ 9.5 mm)	φ 1/2 in. (φ 12.7 mm)	φ 5/8 in. (φ 15.9 mm)	φ 3/4 in. (φ 19.1 mm)	φ 7/8 in. (φ 22.2 mm)	φ 1 in. (φ 25.4 mm)	φ 1-1/8 in. (φ 28.6 mm)	φ 1-1/4 in. (φ 31.8 mm)	φ 1-3/8 in. (φ 34.9 mm)	φ 1-1/2 in. (φ 38.1 mm)	φ 1-5/8 in. (φ 41.3 mm)
L Joints 	6-1/4 in. (0.16 m)	7-1/8 in. (0.18 m)	7-7/8 in. (0.20 m)	9-7/8 in. (0.25 m)	13-3/4 in. (0.35 m)	15-3/4 in. (0.40 m)	17-3/4 in. (0.45 m)	19-5/8 in. (0.50 m)	21-5/8 in. (0.55 m)	23-5/8 in. (0.60 m)	25-5/8 in. (0.65 m)	29-1/2 in. (0.75 m)
REFNET Joint 	1.6 ft. (0.5 m)											
REFNET Header 	3.3 ft. (1 m)											
Single Branch Selector Unit	BSQ36/60TVJ: 13 ft. (4 m)											
	BSQ96TVJ: 19 ft. (6 m)											
Multi Branch Selector Unit	BS4/6Q54TVJ: 19 ft. (6 m)											
	BS8 to 12Q54TVJ: 33 ft. (10 m)											

* When the equivalent piping length in cooling operation is calculated, the gas pipe size is selected.
When the equivalent piping length in heating operation is calculated, the liquid pipe size is selected.

4.2 REFNET Joints and Headers

4.2.1 REFNET Joints

For gas and liquid branch pipes

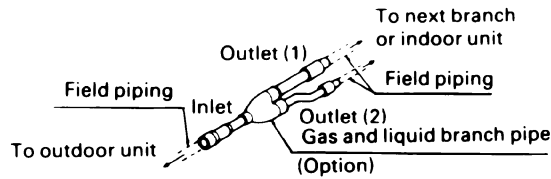

- Make sure that all branch pipes are fitted such that they branch either horizontally or vertically.

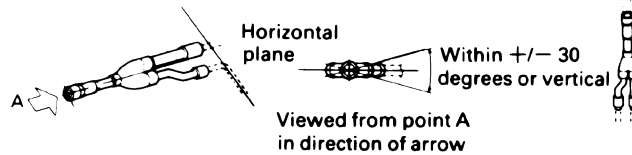

- When the size of the selected field piping is different from that of branch pipe then the connecting section should be cut with a pipe cutter as shown in the figure below.

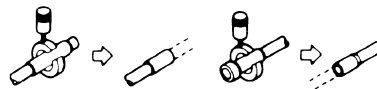

- When you are cutting an inlet or outlet pipe with a pipe cutter make sure that you make the cut in the center of the connection area.

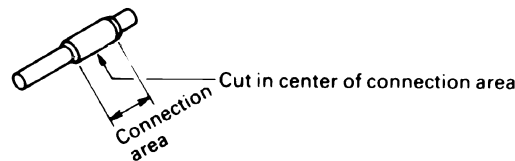

- Branch pipes must be insulated in accordance with the handbook which comes with each kit.

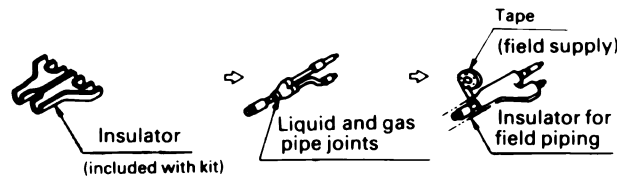

4.2.2 REFNET Headers

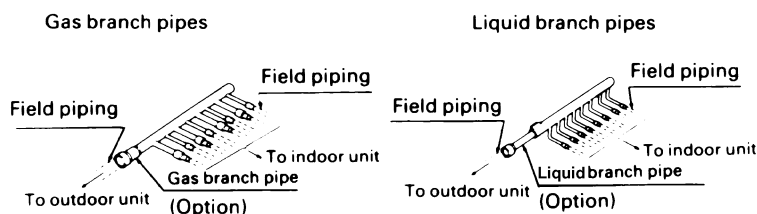

- When the number of indoor units to be connected to the branch pipes is less than the number of branch pipes available for connection then cap pipes should be fitted to the surplus branches.

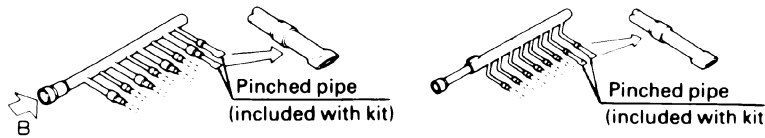

- When the size of the selected field piping is different from that of branch pipe then the connecting section should be cut with a pipe cutter as shown in the figure below.



- When field piping is connected to the B section of the inlet/outlet pipe on the outdoor unit side of the liquid pipe header.
- Cut the B section with a pipe cutter as shown below and connect it to the A section.
- Connect the flared section of the field pipe to the B section.

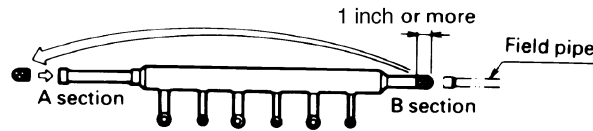

- Fit the branch pipe so that the branch lies in a horizontal plane.

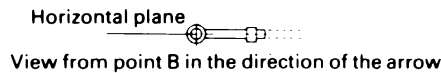

- The branch pipe must be insulated in accordance with the instruction manual which comes with each kit.
1. Use the insulator included in the kit to insulate the header.

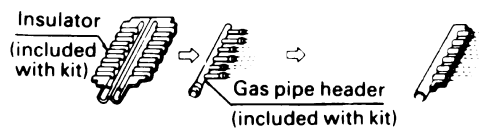

2. Joints between insulators included in the kit and those already applied to the field piping should be sealed with the tape which is also included in each kit.

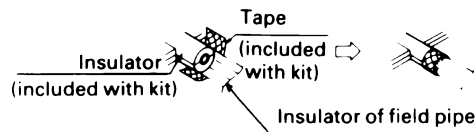

3. Any cap pipes should also be insulated using the insulator provided with each kit and then taped as described above.

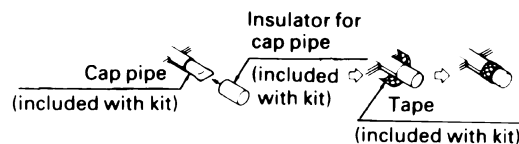

5. REFNET Joint and Header

5.1 REFNET Joint (Branch Kit)

KHRP25A22T9

Unit: in.

ACCESSORY
 REDUCER : SUCTION GAS SIDE : 1 pcs
 HP/LP GAS SIDE : 1 pcs
 INSULATION : 3 pcs
 INSTALLATION MANUAL

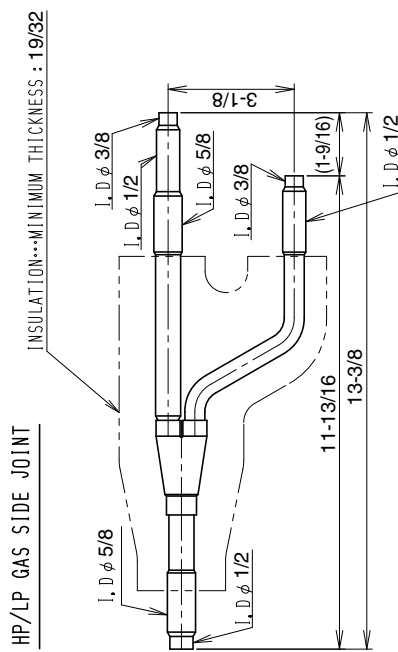
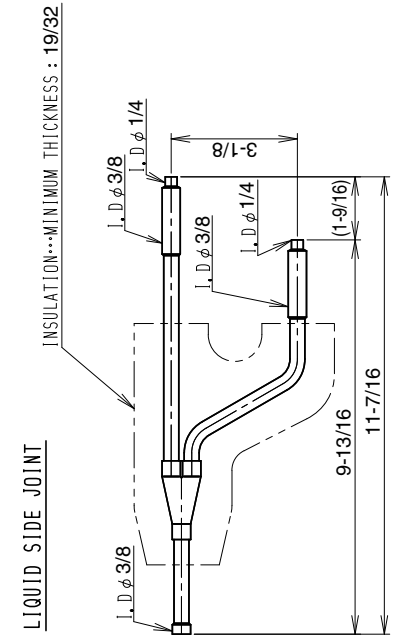
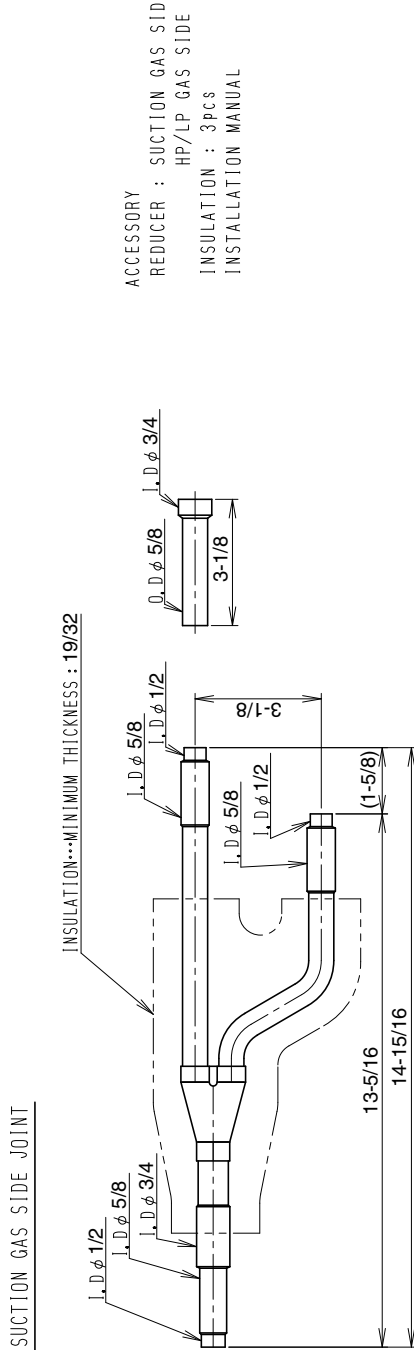

C: D3K05706A

KHRP25M72TU9

Unit: in.

- ACCESSORIES
 REDUCER: 4 pcs. (FOR SUCTION GAS SIDE)
 : 2 pcs. (FOR DISCHARGE GAS SIDE)
 : 2 pcs. (FOR LIQUID SIDE)
 INSULATION: 3 pcs.
 INSTALLATION MANUAL: 1 sheet

SUCTION GAS SIDE

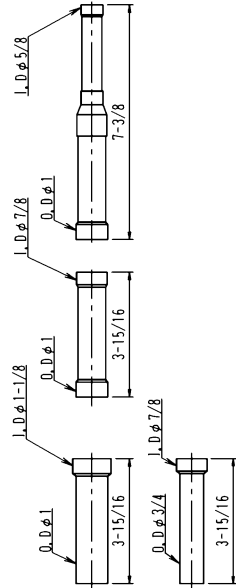
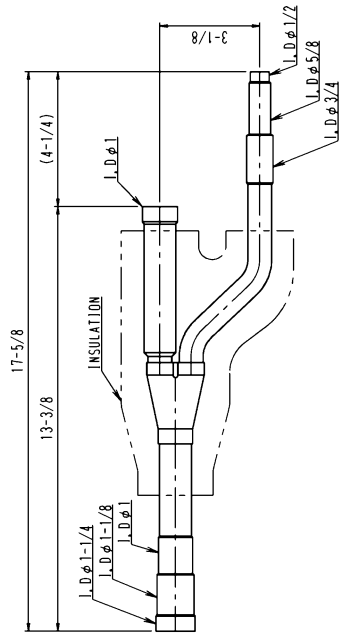

DISCHARGE GAS SIDE

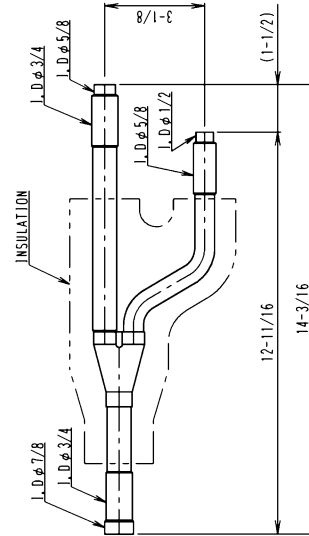

LIQUID SIDE

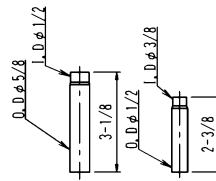
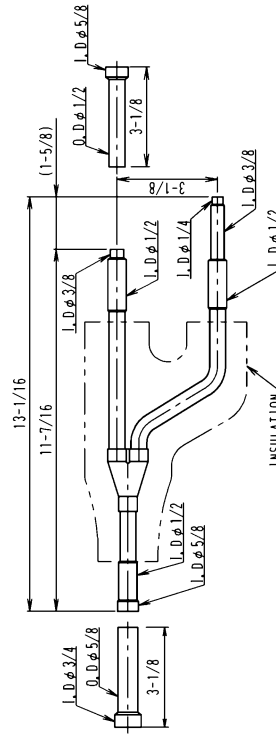

D3K04888B

KHRP25M73TU9

Unit: in.

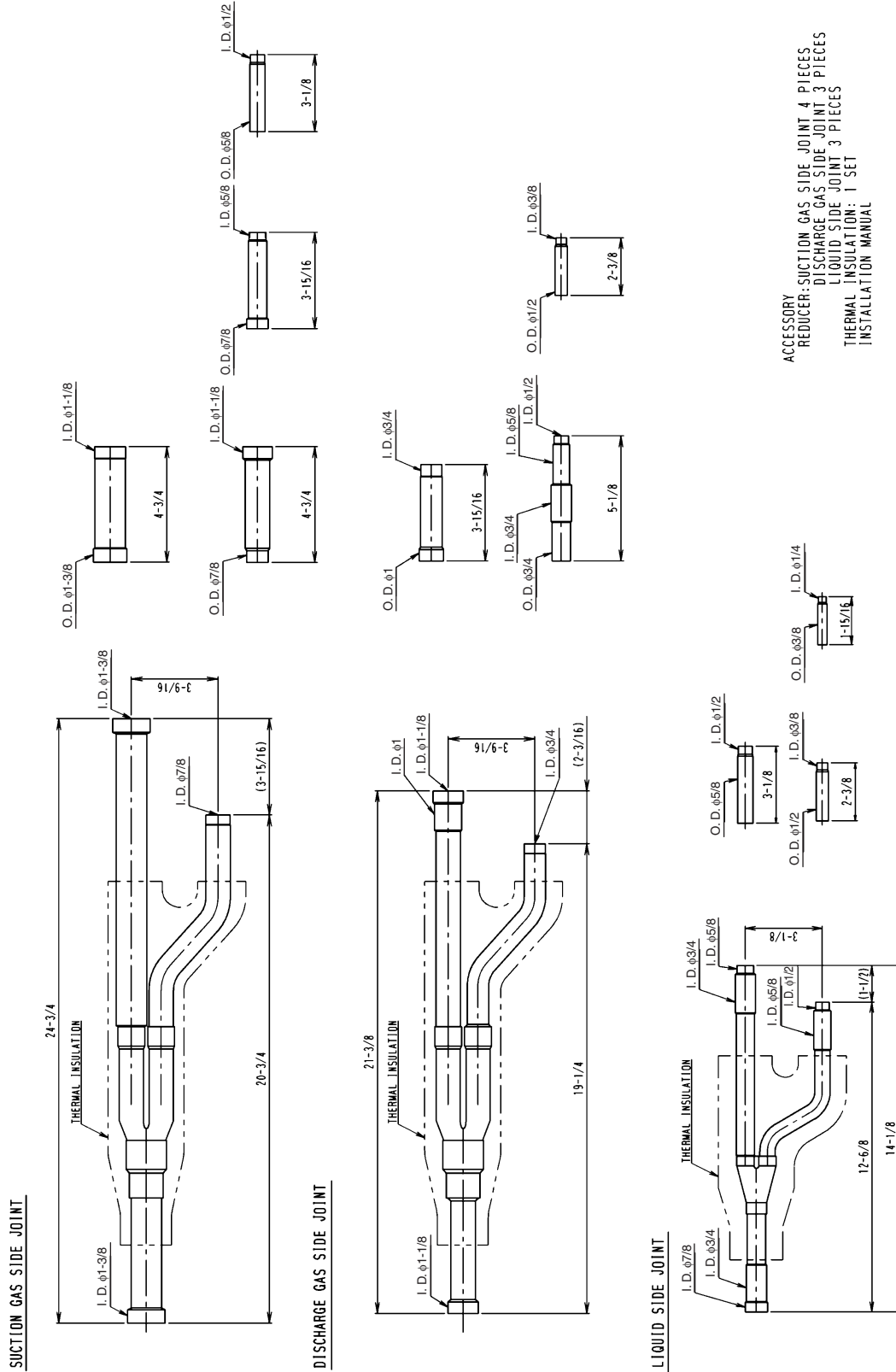

ACCESSORY: SUCTION GAS SIDE JOINT 4 PIECES
 DISCHARGE GAS SIDE JOINT 3 PIECES
 LIQUID SIDE JOINT 3 PIECES
 THERMAL INSULATION: 1 SET
 INSTALLATION MANUAL

D3K05573A

KHRP26A22T9

Unit: in.

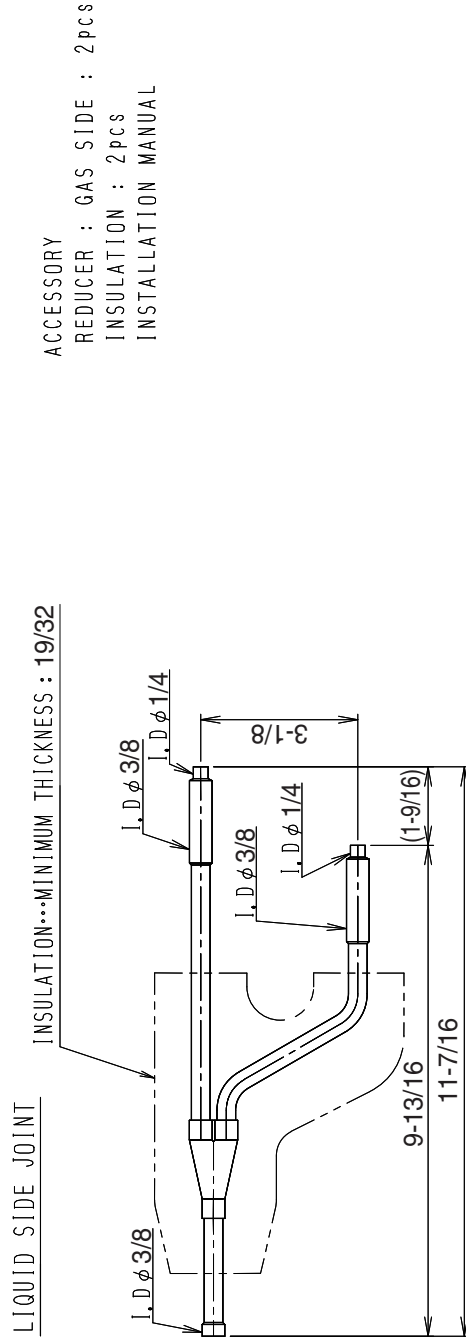
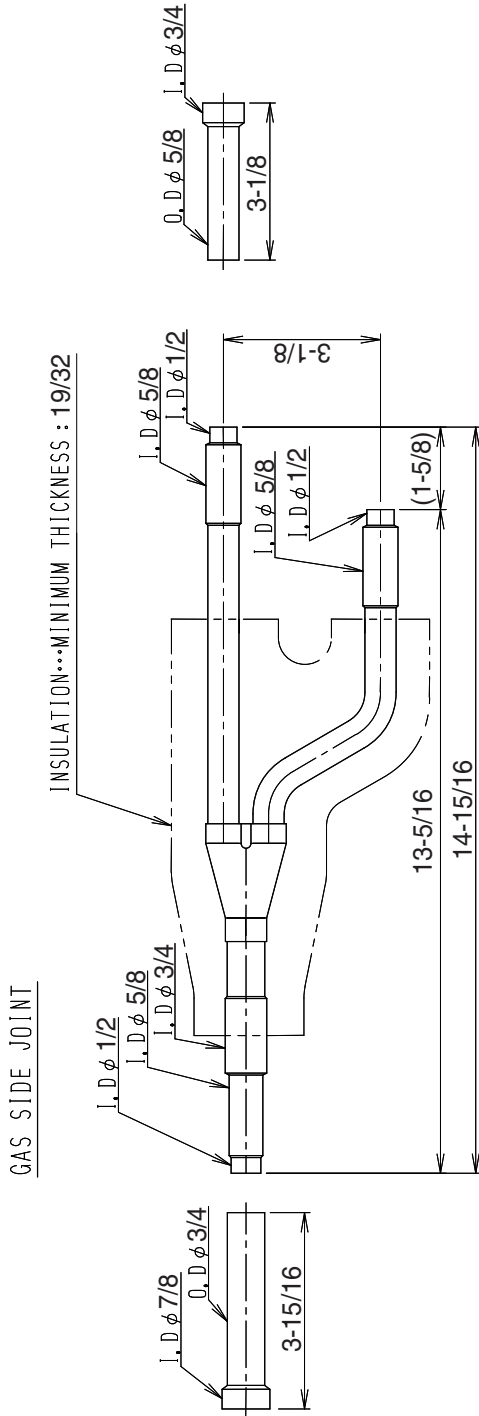

ACCESSORY
 REDUCER : GAS SIDE : 2 pcs
 INSULATION : 2 pcs
 INSTALLATION MANUAL

C: D3K05234B

KHRP26A33T9

Unit: in.

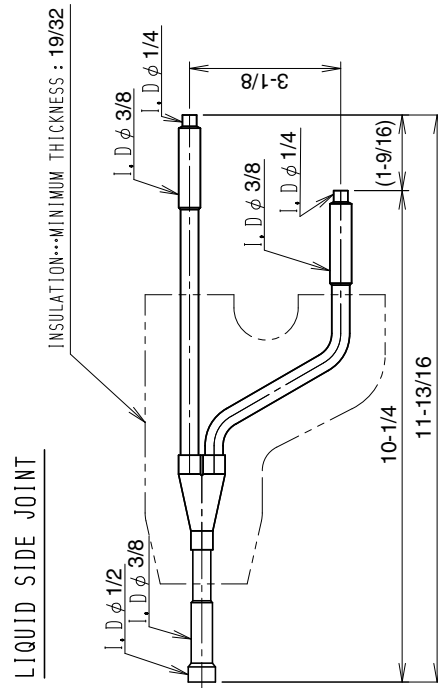
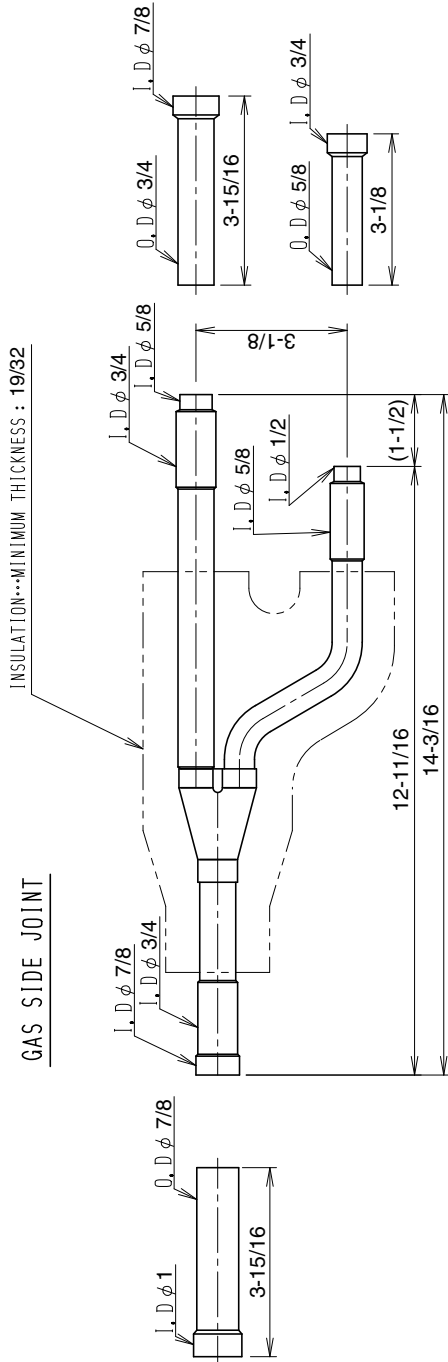

ACCESSORY
 REDUCER : GAS SIDE : 3 PCS
 INSULATION : 2 PCS
 INSTALLATION MANUAL

C: D3K05235C

KHRP26M72TU9

Unit: in.

ACCESSORIES
 REDUCER: 4 pcs. (FOR GAS SIDE)
 : 2 pcs. (FOR LIQUID SIDE)
 INSULATION: 2 pcs.
 INSTALLATION MANUAL: 1 sheet

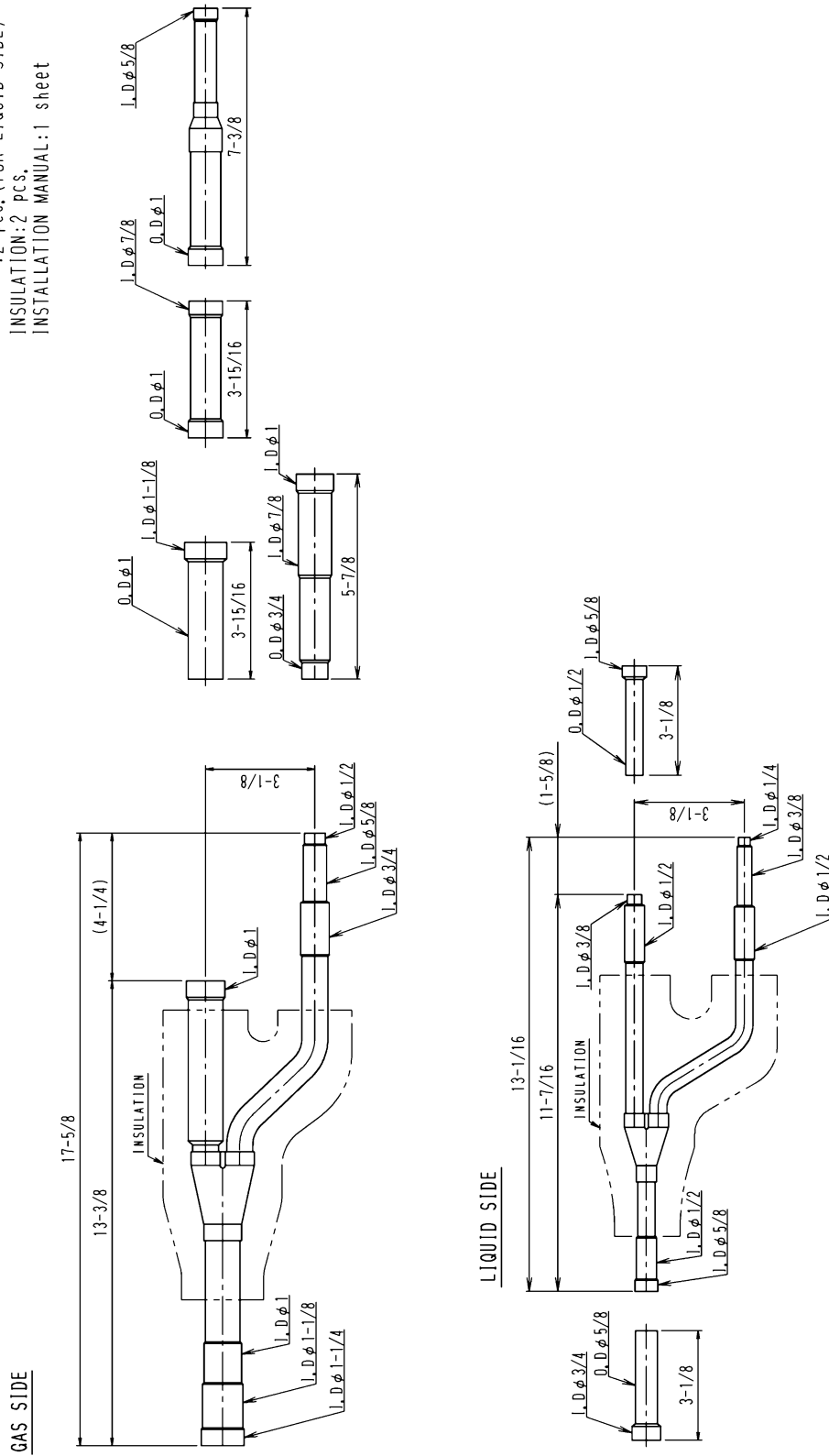





D3K04887A

KHRP25A22T9 / KHRP25A33T9

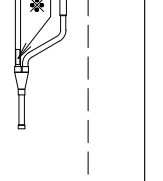
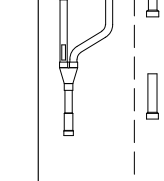
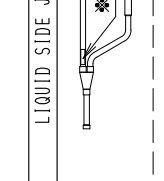
REFNET JOINT INSTALLATION MANUAL(Except for JAPAN)
KHRP25A22T • 33T • 72T • 73T(FOR R410A)

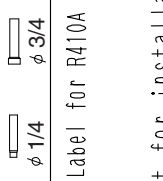
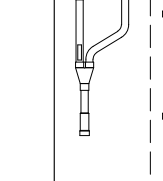
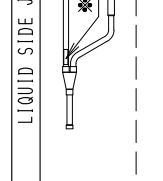
THIS KIT INCLUDES THE FOLLOWING PARTS.

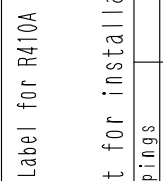
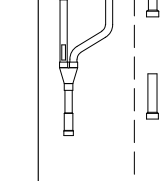
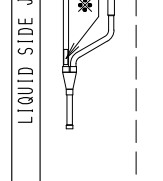
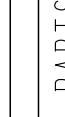
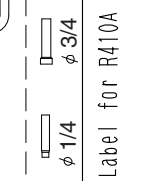
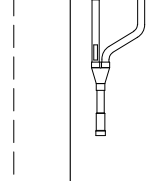
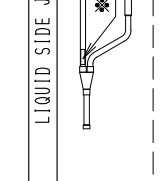
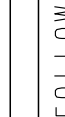
KIT NAME	S H A P E				INSULATION
	SUCTION GAS SIDE JOINT	HP/LP GAS SIDE JOINT	LIQUID SIDE JOINT		
KHRP25A 22T	 REDUCER φ 3/4	 φ 3/8	 *		 3 pcs.
KHRP25A 33T	 REDUCER φ 7/8 φ 3/4				 3 pcs.
KHRP25A 72T	 REDUCER φ 7/8 φ 1-1/8 × 2pcs.	 φ 1/78 φ 3/4	 φ 5/8 φ 3/4		 3 pcs.
KHRP25A 73T	 REDUCER φ 1/2 φ 7/8 φ 1-1/8 φ 1-1/4 φ 1-1/2	 φ 1-1/4 / 1-1/8 φ 1/78 φ 7/8 φ 3/8	 φ 1/4 φ 3/4 φ 7/8		 3 pcs.

*...Make sure suction gas side joint, HP/LP gas side and liquid side joint are for R410A, (Label for R410A is attached on each part.)

INTRODUCTION

This kit is designed as a refrigerant branching kit for HEAT RECOVERY unit for installation in buildings.

- Between outdoor unit and Branch Selector unit (upstream of Branch Selector unit), use 3 pipings. Use this kit for such branching application.
- Between Branch Selector unit and indoor unit (downstream of Branch Selector unit) and between REFNET JOINT and cooling-only indoor unit, use 2 pipings.

3 pipings		2 pipings	
Upstream of Branch Selector unit	Downstream of Branch Selector unit	To cooling-only indoor unit	
Suction gas side piping HP/LP gas side piping Liquid side piping	Gas side piping Liquid side piping	Suction gas side piping Liquid side piping	

SELECTION PROCEDURE

According to the INSTALLATION MANUAL of outdoor unit,

INSTALLATION PROCEDURE

1 The pipe size of each parts are shown below.

KIT NAME	SUCTION GAS SIDE JOINT	HP/LP GAS SIDE JOINT	LIQUID SIDE JOINT
KHRP25A 22T			
KHRP25A 33T			
KHRP25A 72T			
KHRP25A 73T			

2 According to SELECTION PROCEDURE cut the pipe with a pipe cutter for use.

- (EX)FOR KHRP25A33T

① SUCTION GAS SIDE JOINT

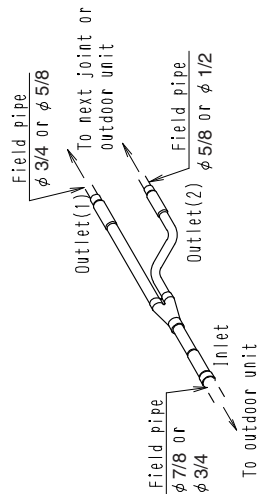

NOTE) For the size of inlet is ϕ 3/4 or the size of outlet(1) is ϕ 3/4, the size of outlet(2) is ϕ 5/8.

- Cut the pipe with a pipe cutter.

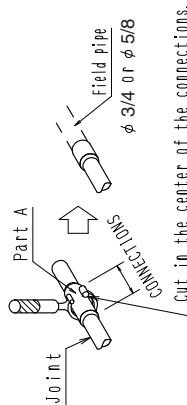

② HP/LP GAS SIDE JOINT

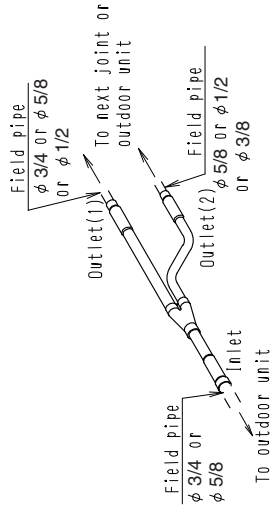

NOTE) For the size of inlet is ϕ 3/4 or the size of outlet(1) is ϕ 3/4 or ϕ 5/8, the size of outlet(2) is ϕ 5/8 or ϕ 1/2.

- Cut the pipe with a pipe cutter.

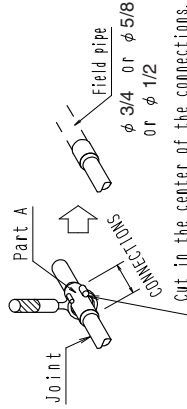

③ LIQUID SIDE JOINT

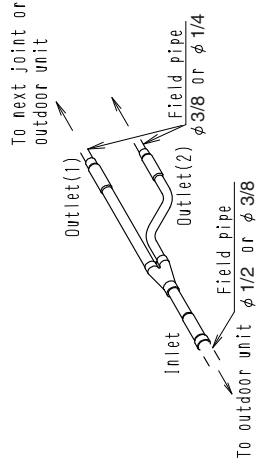

NOTE) For the size of inlet is ϕ 3/8 or the size of outlet(1) or (2) is ϕ 3/8.

- Cut the pipe with a pipe cutter.

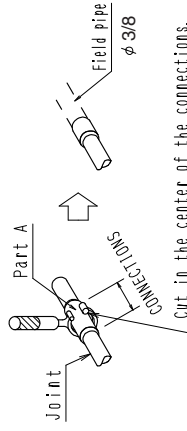

Cut in the center of the part A and connect a field pipe.

④ When the suction gas side pipe size of outlet(1) is ϕ 7/8.

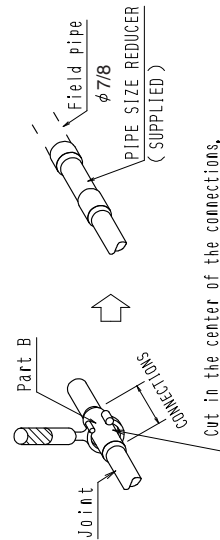

Cut in the center of the connections.

Cut the center of the part B and use PIPE SIZE REDUCER.

• Make sure to flow nitrogen gas through the pipe when brazing.

③ Insulation of JOINT

- Be sure to insulate the suction/discharge gas and liquid side JOINT.
 (Note) The insulation of the refrigerant piping must be reinforced based on the environment of installation. Otherwise, dew may condensate on the surface of the insulation. For details, see Engineering Data.
- Seal the insulation and field piping insulation joint with the field supplied tape.

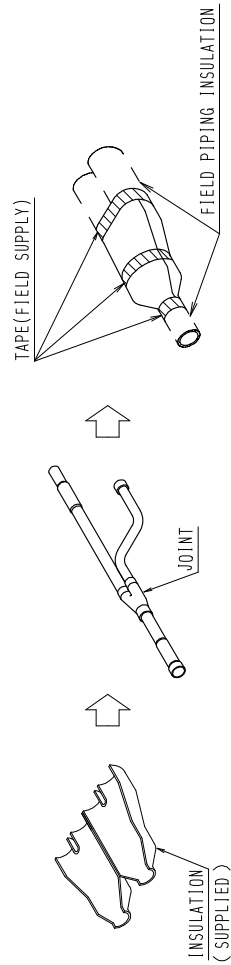

INSTALLATION PRECAUTIONS

- Install the JOINT so that it is branched vertically or horizontally.



HORIZONTAL
(INCLINATION 30° MAX)

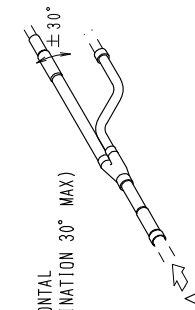

VERTICAL

"A" ARROW VIEW

- Do not apply extra force on the piping part. The brazed part may be damaged and it may result in gas leakage.

KHRP26A22T9 / KHRP26A33T9

REFNET JOINT INSTALLATION MANUAL(Except for JAPAN)
 KHRP26A22T • 33T • 72T • 73T(FOR R410A)

THIS KIT INCLUDES THE FOLLOWING PARTS.

KIT NAME	S H A P E					REDUCER(FOR LIQUID PIPE)
	GAS SIDE JOINT	LIQUID SIDE JOINT	INSULATION	REDUCER(FOR GAS PIPE)	REDUCER(FOR LIQUID PIPE)	
KHRP26A 22T			 2 PCS.	 φ3/4	 φ7/8	
KHRP26A 33T			 2 PCS.	 φ3/4	 φ7/8	
KHRP26A 72T			 2 PCS.	 φ7/8	 φ1/φ7/8	 φ5/8 φ3/4
KHRP26A 73T			 2 PCS.	 φ1/2	 φ7/8 φ1-1/8 φ1-1/4	 φ1/4 φ3/4 φ7/8

※...Make sure gas side joint and liquid side joint are for R410A. (Label for R410A is attached on each part.)

SELECTION PROCEDURE

According to the INSTALLATION MANUAL of outdoor unit.

INSTALLATION PROCEDURE

1 The pipe size of each parts are shown below.

KIT NAME	GAS SIDE JOINT	LIQUID SIDE JOINT
KHRP26A 22T		
KHRP26A 33T		
KHRP26A 72T		
KHRP26A 73T		

② According to SELECTION PROCEDURE, cut the pipe with a pipe cutter for use.

• (EX.) FOR KHRP26A33T

① GAS SIDE JOINT

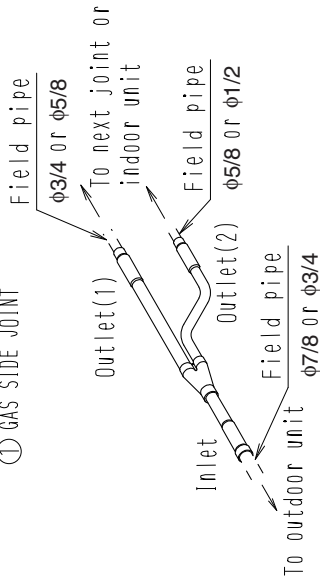

Note) For the size of inlet is $\phi 3/4$ or the size of outlet(1) is $\phi 3/4$, the size of outlet(2) is $\phi 5/8$.

• Cut the pipe with a pipe cutter.

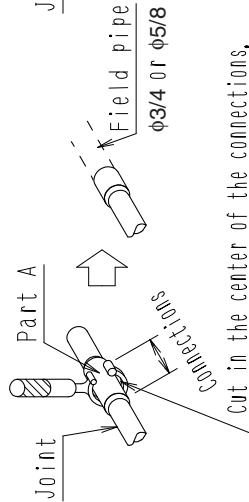

Cut in the center of the connections.

Cut in the center of the part A and connect a field pipe.

• Make sure to flow nitrogen gas through the pipe when brazing.

② LIQUID SIDE JOINT

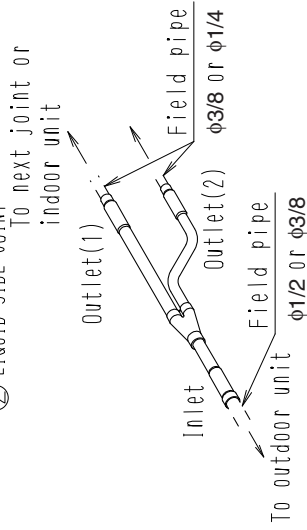

Note) For the size of inlet is $\phi 3/8$ or the size of outlet(1) is $\phi 3/8$, the size of outlet(2) is $\phi 3/8$.

• Cut the pipe with a pipe cutter.

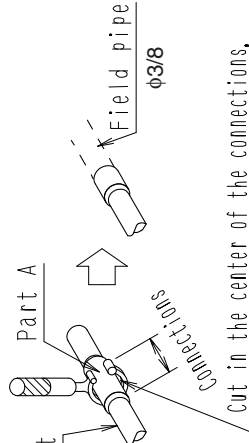

Cut in the center of the connections.

Cut in the center of the part A and connect a field pipe.

3 Insulation of Joint

Be sure to insulate the gas and liquid side Joint.

Note) The insulation of the refrigerant piping must be reinforced based on the environment of installation. Otherwise, dew may condensate on the surface of the insulation. For details, see Engineering Data.

GAS SIDE

- Set the insulation matching the joint and wind the field supplied tape from the center without any clearances on the matching face of insulation,

- Seal the insulation and field piping insulation joint with the field supplied tape.

LIQUID SIDE

- Insulate by the same method as gas side joint.

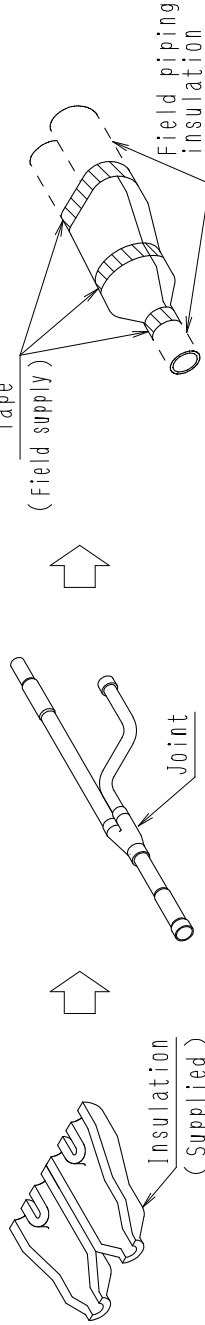

INSTALLATION PRECAUTIONS

- Install the Joint so that it is branched vertically or horizontally.

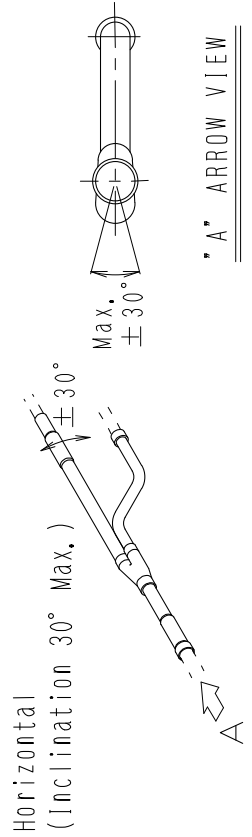

- Do not apply extra force on the piping part. The brazed part may be damaged and it may result in gas leakage.

KHRP25M72TU9 / KHRP25M73TU9 / KHRP26M72TU9

REFNET JOINT INSTALLATION MANUAL

KHRP25M72TU • 73TU, KHRP26M72TU • 73TU(FOR R410A)

■ These kits include the following parts.

KIT NAME	S H A P E				INSULATION
	SUCTION GAS SIDE JOINT / GAS SIDE JOINT	DISCHARGE GAS SIDE JOINT	LIQUID SIDE JOINT		
KHRP 25M72TU	<p>REDUCER I.D. 5/8 O.D. 1-1/8 I.D. 7/8 O.D. 3/4</p>	<p>I.D. 5/8 O.D. 1/2 O.D. 3/8</p>	<p>I.D. 3/4 O.D. 5/8 O.D. 1/2</p>		<p>3 PCS.</p>
KHRP 25M73TU	<p>REDUCER O.D. 1-3/8 I.D. 1-1/8 O.D. 7/8 O.D. 1-1/8 O.D. 7/8 I.D. 5/8 O.D. 5/8 I.D. 1/2</p>	<p>I.D. 3/4 O.D. 1 O.D. 5/8 O.D. 1/2 O.D. 1/2 O.D. 3/8</p>	<p>I.D. 1/2 O.D. 5/8 O.D. 3/8 I.D. 1/4</p>		<p>3 PCS.</p>
KHRP 26M72TU	<p>REDUCER O.D. 1 I.D. 7/8 O.D. 1 O.D. 7/8 O.D. 3/4</p>		<p>I.D. 3/4 O.D. 5/8 O.D. 1/2</p>		<p>2 PCS.</p>
KHRP 26M73TU	<p>REDUCER O.D. 1-3/8 I.D. 1-1/8 O.D. 7/8 O.D. 1-1/8 O.D. 7/8 I.D. 5/8 O.D. 5/8 I.D. 1/2</p>		<p>I.D. 1/2 O.D. 5/8 O.D. 3/8 I.D. 1/4</p>		<p>2 PCS.</p>

*...Make sure all of the joints are for R410A. (The label for R410A is attached on each joint.)

APPLICATION

- Choose between the two kits according to the system and the location.

SYSTEM	HEAT PUMP	HEAT RECOVERY
KIT NAME	KHRP26M72TU • 73TU(2 pipings)	KHRP26M72TU • 73TU(2 pipings)
LOCATION	Outdoor unit~indoor units	Upstream of Branch Selector units / Downstream of Branch Selector units
REFRIGERANT PIPING	Gas side piping Liquid side piping	Suction gas side piping Discharge gas side piping Liquid side piping

SELECTION PROCEDURE

- Refer to the installation manual of outdoor unit.

INSTALLATION PROCEDURE

- Inlet and outlet sizes of the joints

KIT NAME	(SUCTION) GAS SIDE JOINT	DISCHARGE GAS SIDE JOINT	LIQUID SIDE JOINT
KHRP 25M72TU			
KHRP 25M73TU			
KHRP 26M72TU			
KHRP 26M73TU			

2 According to SELECTION PROCEDURE, cut the pipe with a pipe cutter and / or use the reducer.

• (EX) FOR KHRP25M72TU

① SUCTION GAS SIDE JOINT

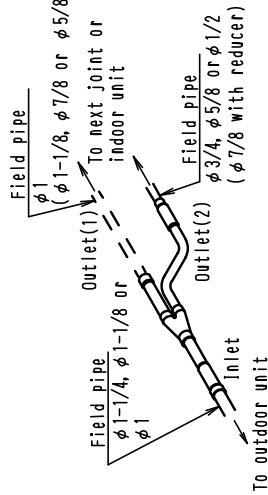

NOTE) In case of the field pipe size of inlet is $\phi 1-1/8$ or $\phi 1$, and the field pipe size of outlet(2) is $\phi 3/4$ or $\phi 5/8$, cut the pipe with a pipe cutter.

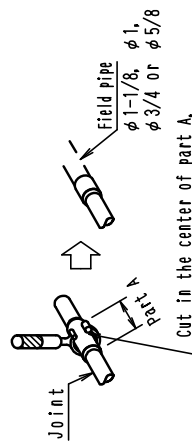

④ When the suction gas side field pipe size of outlet(2) is $\phi 7/8$, cut the center of part A and use the supplied reducer.
Do the same way when the reducer is needed for discharge gas side field pipe and liquid side field pipe.

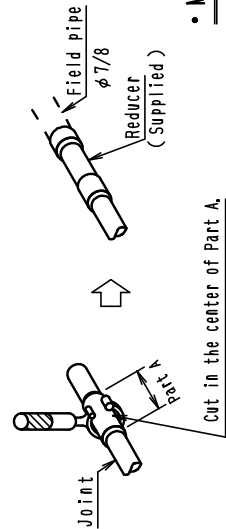

② DISCHARGE GAS SIDE JOINT

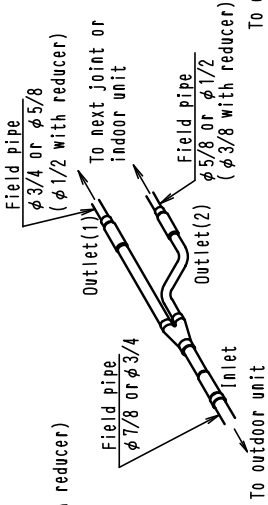

NOTE) In case of the field pipe size of inlet is $\phi 3/4$, the field pipe size of outlet(1) is $\phi 3/4$, and the field pipe size of outlet(2) is $\phi 5/8$, cut the pipe with a pipe cutter.

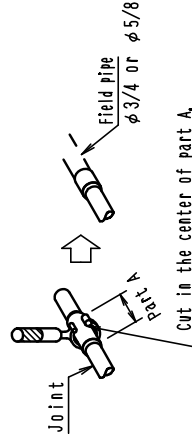

③ LIQUID SIDE JOINT

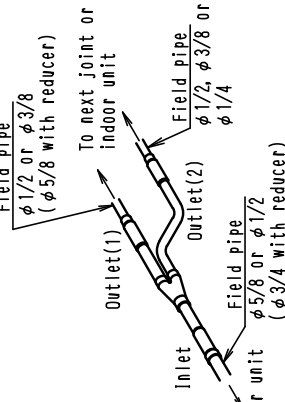

NOTE) In case of the field pipe size of inlet is $\phi 1/2$, the field pipe size of outlet(1) is $\phi 1/2$, and the field pipe size of outlet(2) is $\phi 1/2$ or $\phi 3/8$, cut the pipe with a pipe cutter.

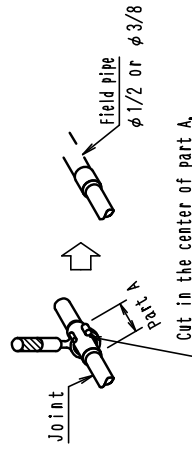

• Make sure to do nitrogen gas blowing through the pipe when brazing.

③ Insulation of joint

- Be sure to insulate all of the joints.
- Note) The insulation of the refrigerant piping must be reinforced based on the environment of installation. Otherwise, dew may condensate on the surface of the insulation. For details, see Engineering Data.
- Seal the supplied insulation and field supplied insulation with field supplied tape.

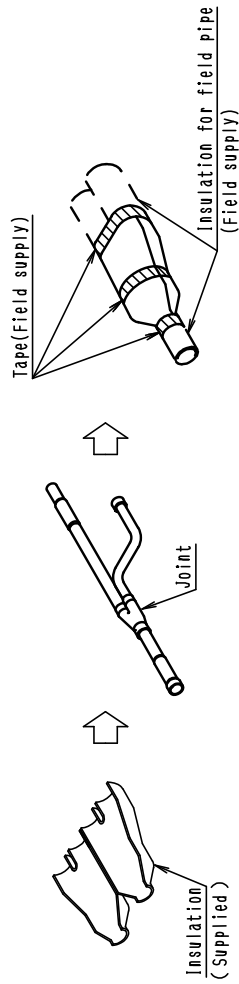

PRECAUTIONS OF INSTALLING

- Install the joint vertically or horizontally.

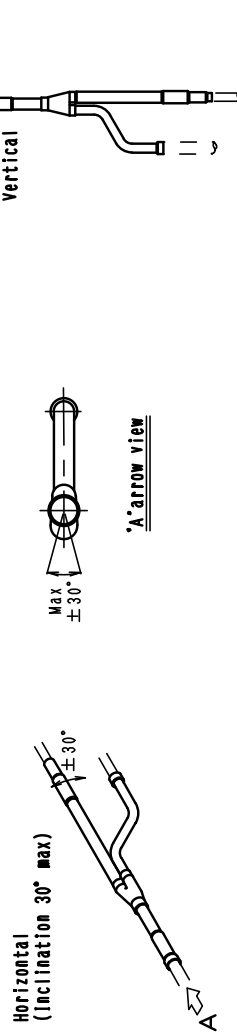

- Do not apply extra force on the piping part. The brazed part may be damaged and it may result in gas leakage.

5.2 REFNET Header (Branch Kit)

KHRP25M33H9

Unit: in.

- ACCESSORY : SUCTION GAS SIDE : 5 pcs
 REDUCER : HP/LP GAS SIDE : 4 pcs
 LIQUID SIDE : 2 pcs
 PLUGGING TUBE : 1 set
 INSULATION : 1 set
 INSTALLATION MANUAL

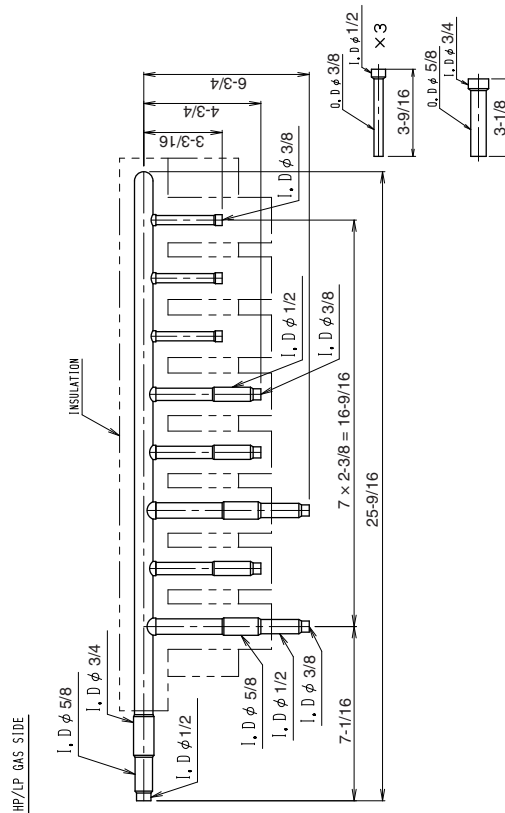
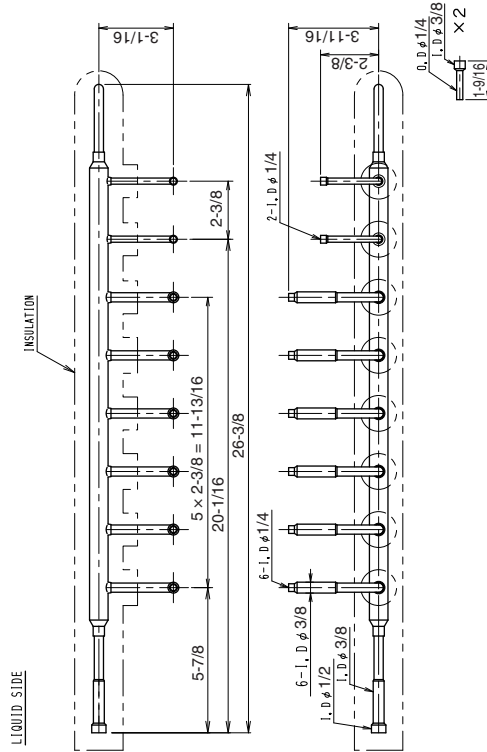
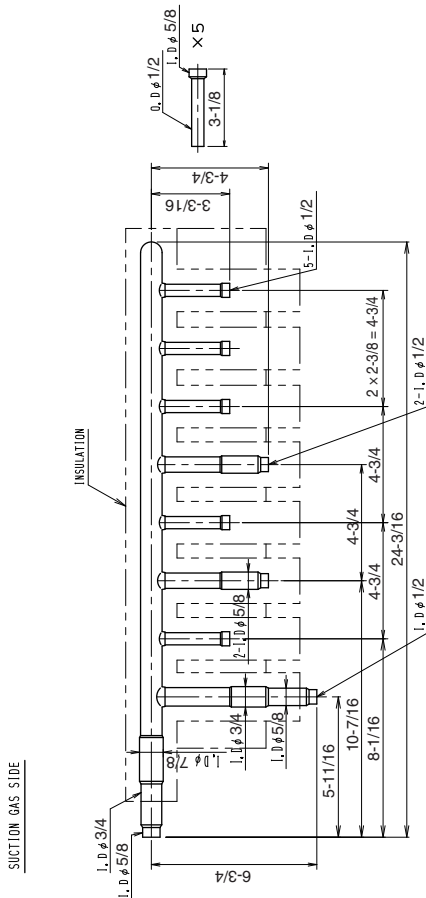

C: D3K03633D

KHRP25M72H9

Unit: in.

ACCESSORY : SUCTION GAS SIDE : 3pcs
 REDUCER : HP/LP GAS SIDE : 6pcs
 LIQUID SIDE : 2pcs
 PLUGGING TUBE : 1 set
 INSULATION : 1set
 INSTALLATION MANUAL

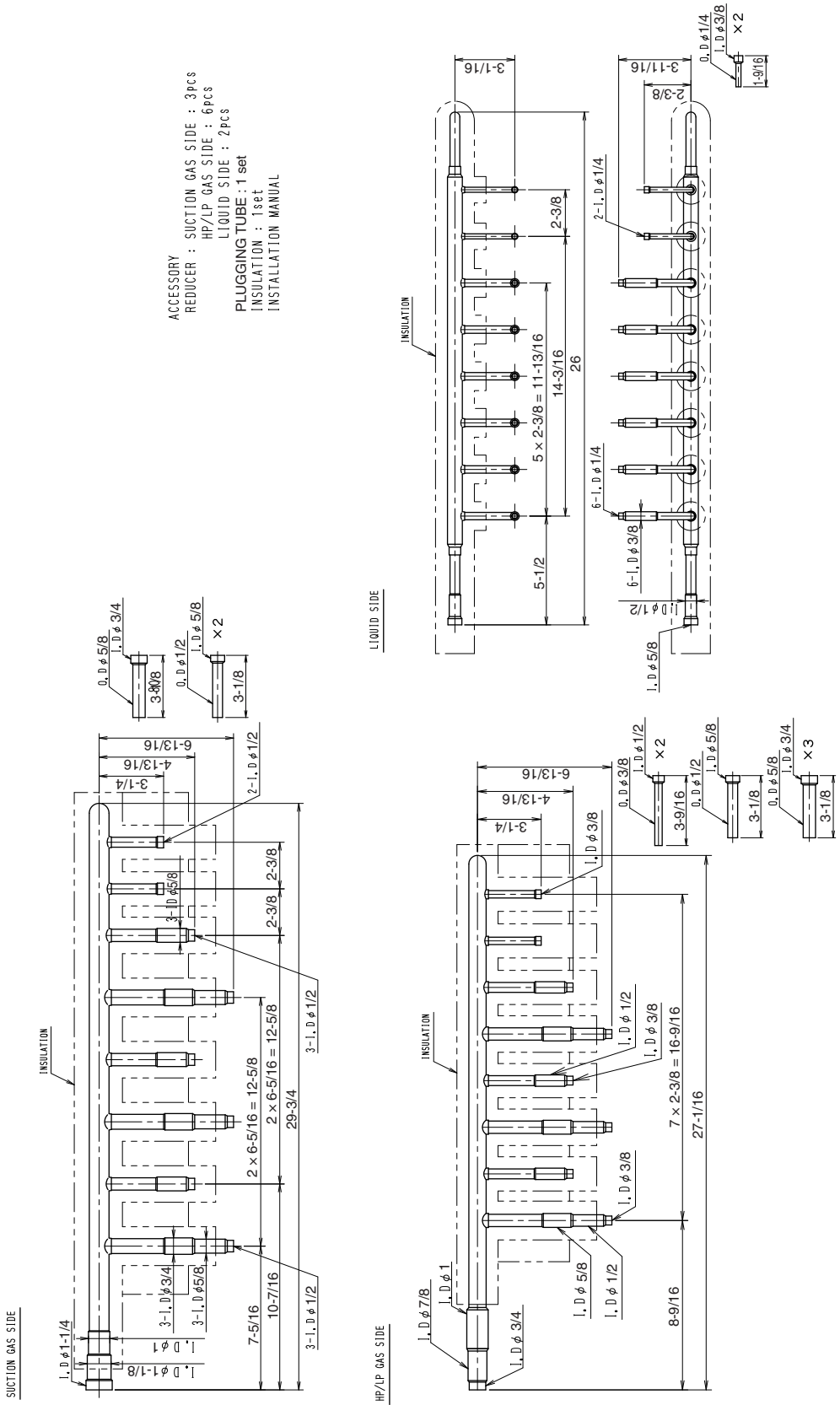

C: D3K03634D

KHRP25M73HU9

Unit: in.

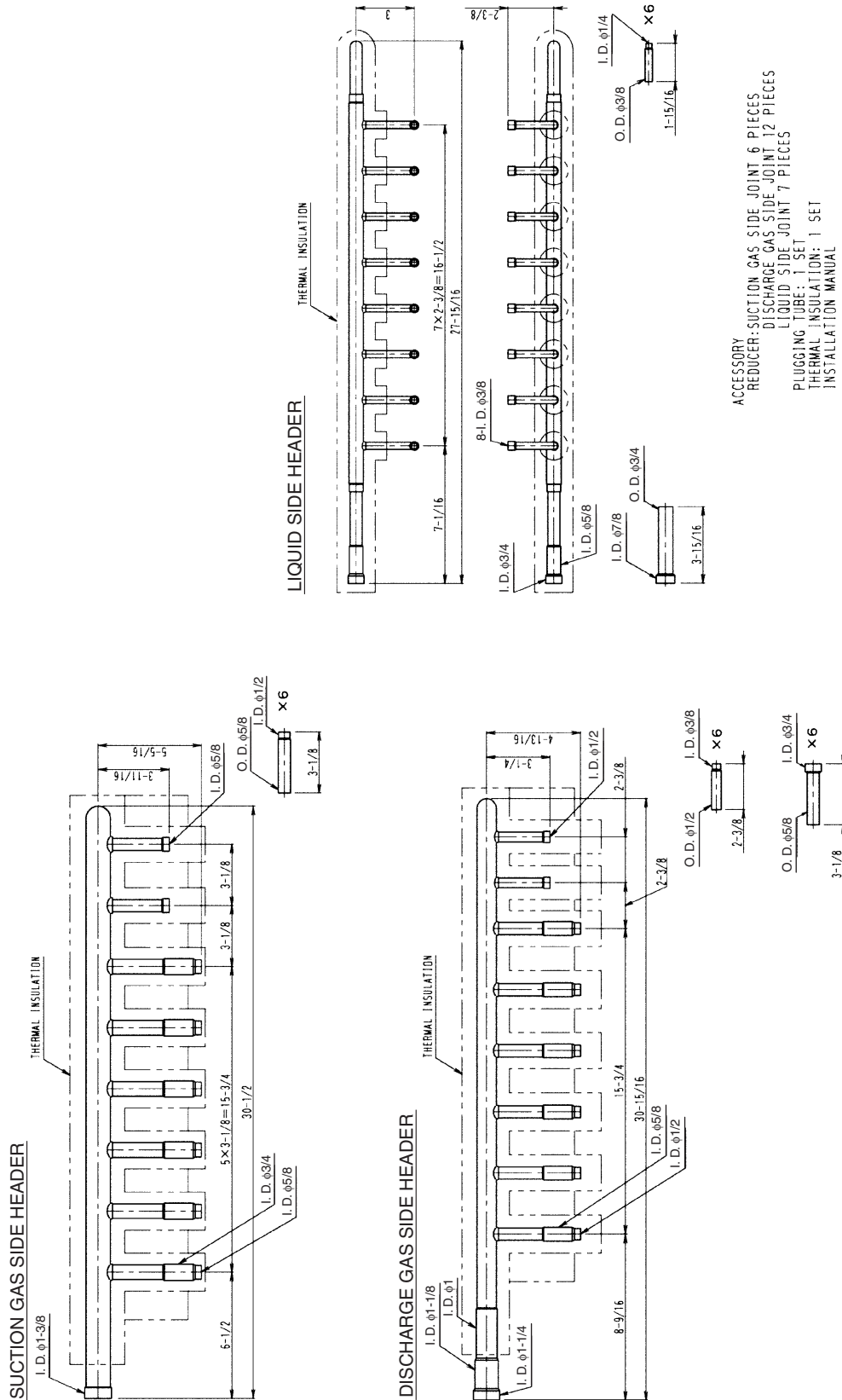

D3K05575

KHRP26M22H9

Unit: in.

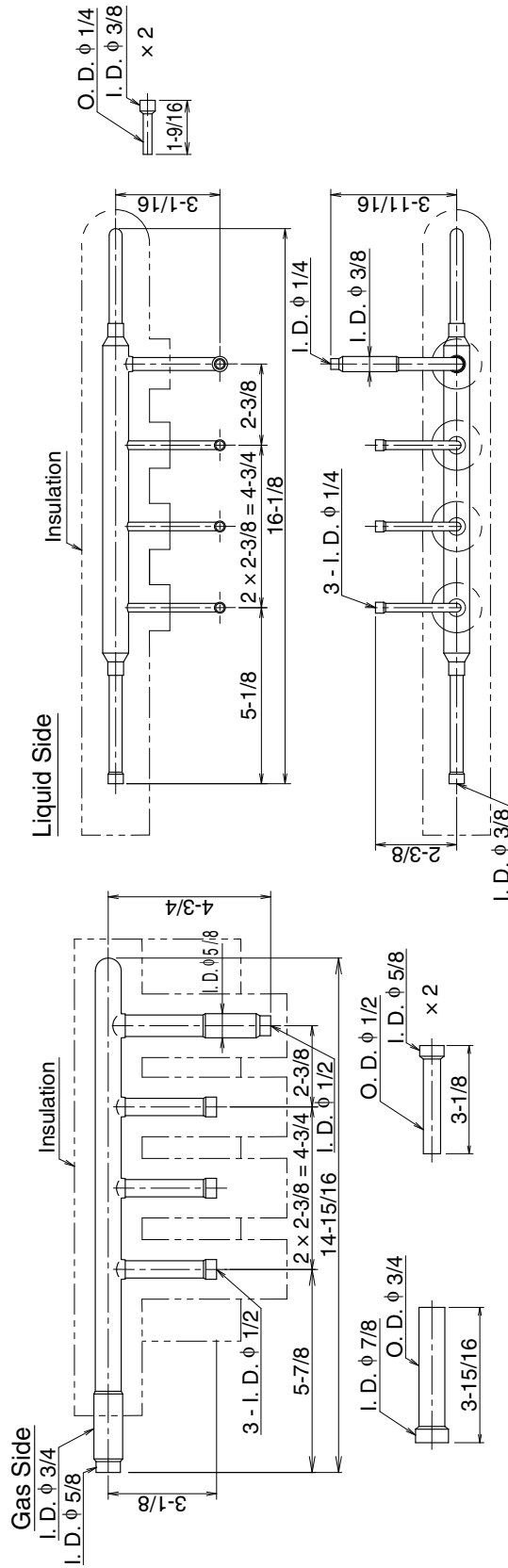

C: D3K03629C

KHRP26M72H9

Unit: in.

- ACCESSORY
- REDUCER : GAS SIDE : 2pcs
- LIQUID SIDE : 3 pcs
- PLUGGING TUBE : 1 set
- INSULATION : 1 set
- INSTALLATION MANUAL

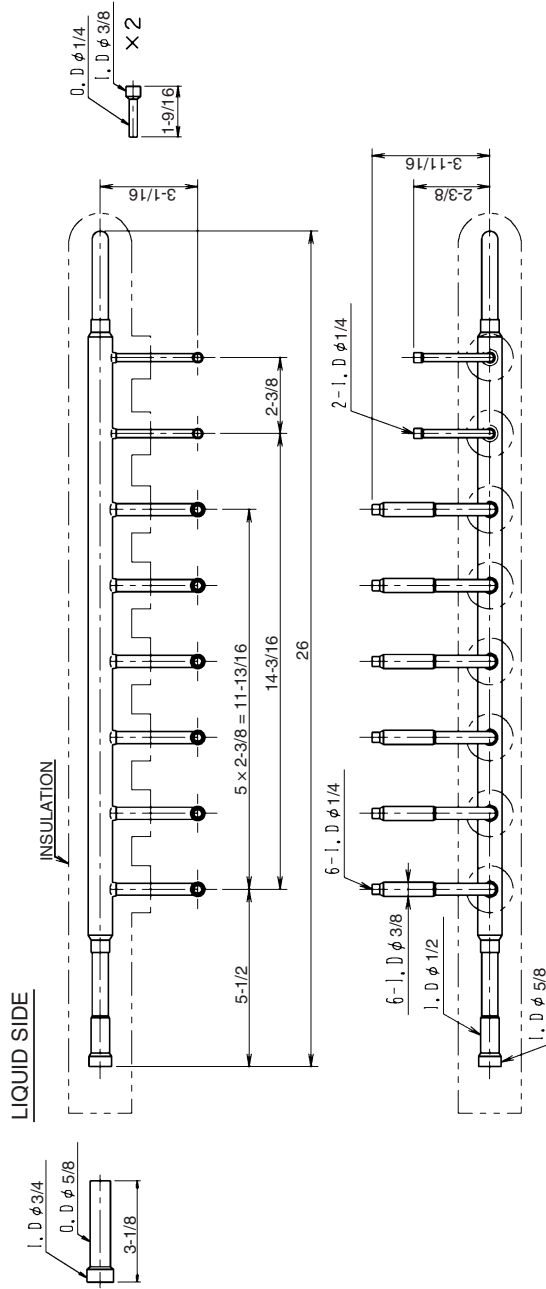
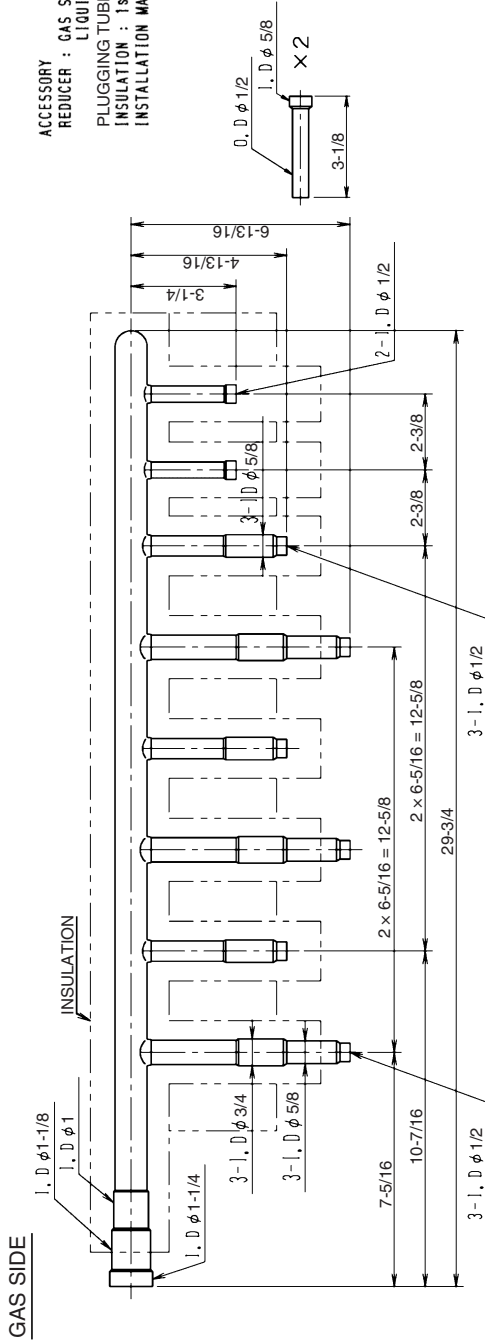





JC: D3K03631C

KHRP25M33H9 / KHRP25M72H9

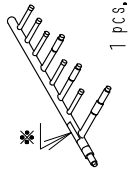
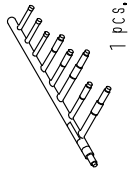
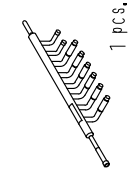
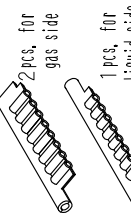
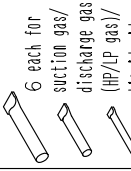
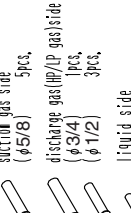
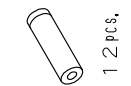
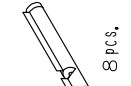
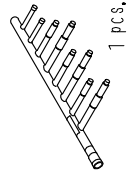
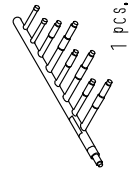
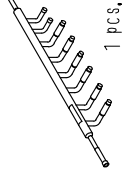
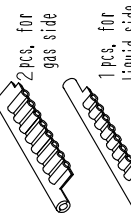
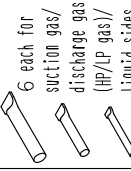
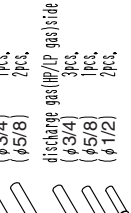
REFNET HEADER INSTALLATION MANUAL (EXCEPT FOR JAPAN)
 KHRP25M33H • 72H • 73H • 73H (FOR R410A)

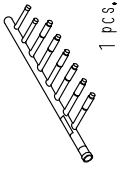
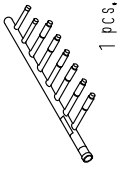
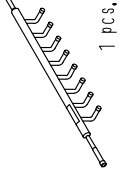
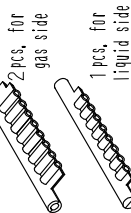
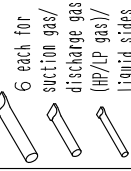
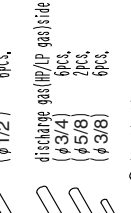
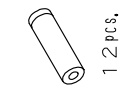
THIS KIT INCLUDES THE FOLLOWING PARTS.

KIT NAME	S H A P E							
	SUCTION GAS SIDE HEADER	DISCHARGE GAS (HP/LP GAS) SIDE HEADER	LIQUID SIDE HEADER	INSULATION FOR HEADER	PLUGGING TUBES	REDUCER	INSULATION FOR GAS SIDE ENCLOSED PIPING	INSULATION FOR LIQUID SIDE PIPING
KHRP 25W33H 8branches	 1 pcs,	 1 pcs,	 1 pcs,	 2 pcs, for gas side 1 pcs, for liquid side			 1 2 pcs,	 8 pcs,
KHRP 25W72H 8branches	 1 pcs,	 1 pcs,	 1 pcs,	 2 pcs, for gas side 1 pcs, for liquid side			 1 2 pcs,	 8 pcs,
KHRP 25W73H 8branches	 1 pcs,	 1 pcs,	 1 pcs,	 2 pcs, for gas side 1 pcs, for liquid side			 1 2 pcs,	 8 pcs,

***Make sure suction gas side header, discharge gas (HP/LP gas) side and liquid side header are for R410A. (Label for R410A is attached on each part.)

INTRODUCTION

This kit is designed as a refrigerant branching kit for HEAT RECOVERY unit for installation in buildings.

3 pipings		2 pipings	
Upstream of Branch Selector unit	Downstream of Branch Selector unit	To cooling-only indoor unit	
Suction gas side piping Discharge gas (HP/LP gas) side piping Liquid side piping	Gas side piping Liquid side piping	Suction gas side piping Liquid side piping	

- Between outdoor unit and Branch Selector unit (upstream of Branch Selector unit), use 3 pipings. Use this kit for such branching application.
- Between Branch Selector unit and indoor unit (downstream of Branch Selector unit) and between REFNET HEADER and cooling-only indoor unit, use 2 pipings.

SELECTION PROCEDURE

According to the INSTALLATION MANUAL of outdoor unit.

INSTALLATION PROCEDURE

- ① The pipe size of each parts are shown below.

KIT NAME	SUCTION GAS SIDE HEADER	DISCHARGE GAS (HP/LP GAS) SIDE HEADER	LIQUID SIDE HEADER
KHRP 25M33H 8branches			
KHRP 25M72H 8branches			
KHRP 25M73H 8branches			

- ② For the outlet/inlet pipings which can be connected in several piping sizes, cut the connections of piping diameter to be used with a pipe cutter according to the left lower table.

NOTE) 1. Cut in the center of the connections.

2. PIPE SIDE REDUCER

ex) When connecting the field pipe ($\phi 7/8$) to inlet liquid side pipe of KHRP25M73H, use PIPE SIDE REDUCER.

- ③ For non-connected outlet pipings at the indoor unit side for refrigerant branching, install the supplied plugging tube.

When connecting the field piping to inlet piping part B at the outdoor unit of liquid side header.

- Cut part B as shown with a pipe cutter and install it to part A.
- Connect the flared field piping to part B.

• Make sure to flow nitrogen gas through the pipe when brazing.

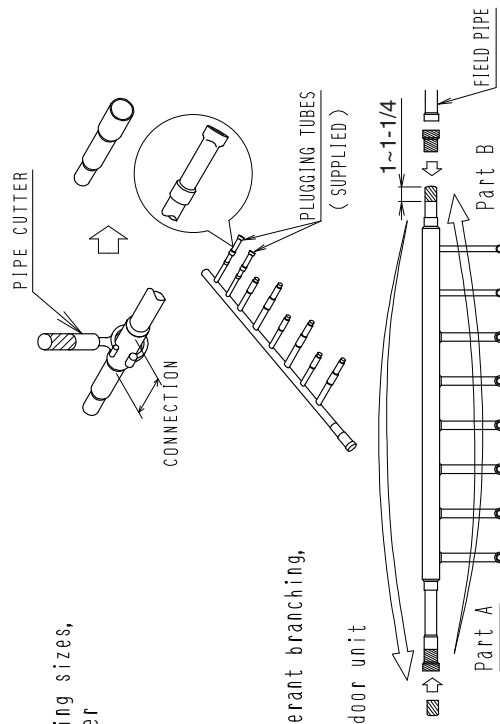

4 Insulation of HEADER

- Be sure to insulate the gas and liquid side HEADER.
- (Note) The insulation of the refrigerant piping must be reinforced based on the environment of installation. Otherwise, dew may condensate on the surface of the insulation. For details, see Engineering Data.

SUCTION/DISCHARGE GAS SIDE HEADER

i) Insulate the gas side header with the supplied insulation.

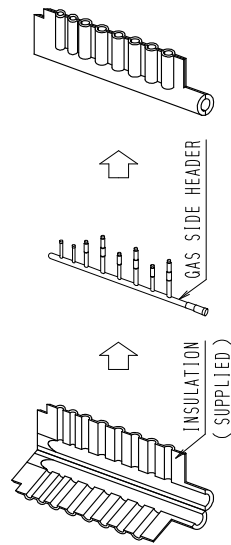

ii) Seal the supplied insulation and field piping insulation with the field supplied tape.

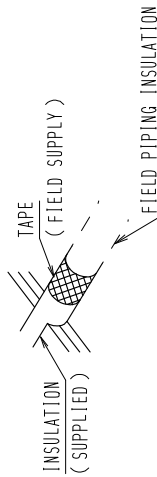

iii) Seal the plugging tube mounting part with the field supplied tape after installing the supplied plugging tube, insulation for the supplied plugging tube,

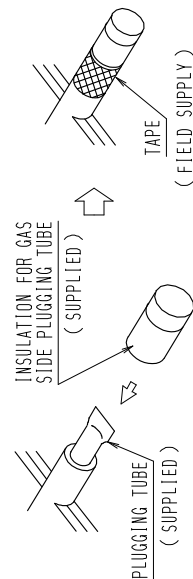

LIQUID SIDE HEADER

i) Insulate the header using the insulation for header and the insulation for liquid side piping.

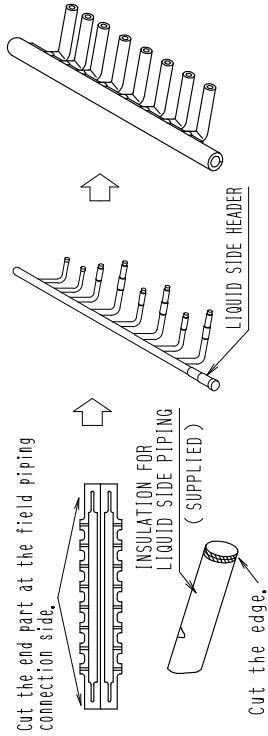

ii) Seal the supplied insulation and liquid side piping insulation joint, the supplied liquid side piping insulation bending part, and the joint with the field piping insulation, using the field supplied tape. Seal the supplied insulation with a vinyl tape, for example.

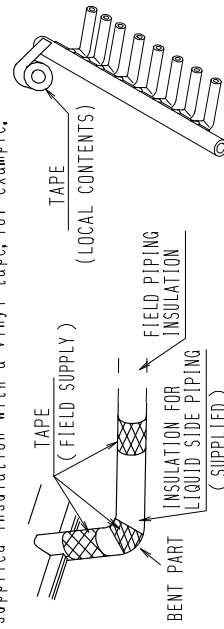

iii) Using the field supplied tape, seal the plugging tube mounting part after installing the insulation for liquid side piping (supplied).

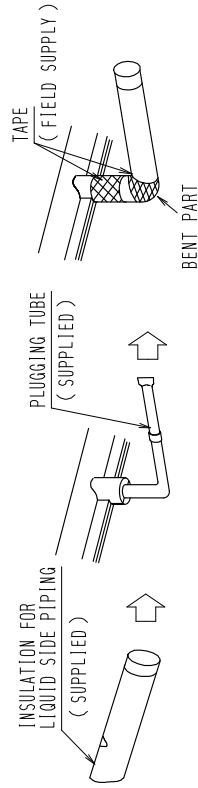

INSTALLATION PROCEDURE

- Do not apply extra force on the piping part. The brazed part may be damaged and it may result in gas leakage.

SUCTION/DISCHARGE GAS SIDE HEADER

- Place the header on the pedestal and install it so that it is horizontal.

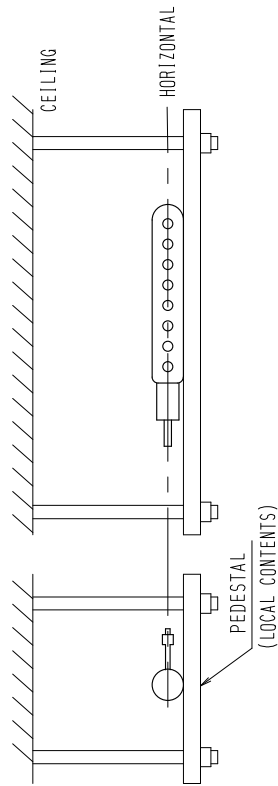

LIQUID SIDE HEADER



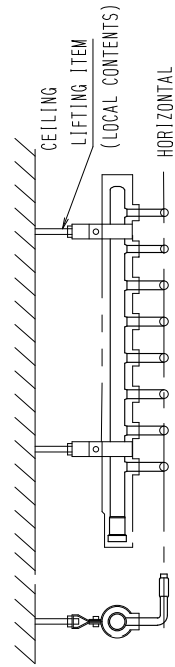





- Suspend the header from the ceiling, and be sure to install it so that the outlet/inlet pipings at the header indoor unit side are horizontal at the lower side as shown below.

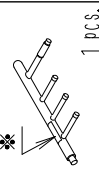
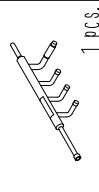
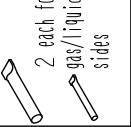
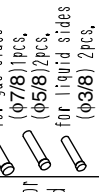
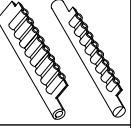

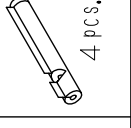
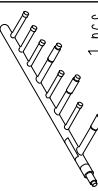
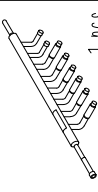
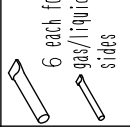
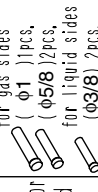
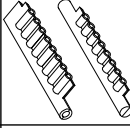
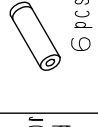
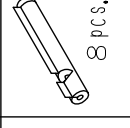
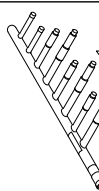
KHRP26M22H9 / KHRP26M33H9 / KHRP26M72H9

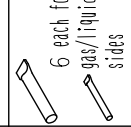
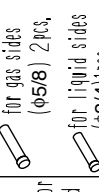
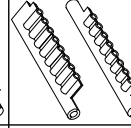
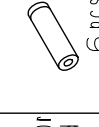
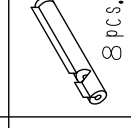
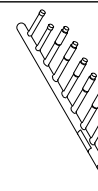
REFNET HEADER INSTALLATION MANUAL(Except for JAPAN)
KHRP26M22H • 33H • 72H • 73H • 73H(FOR R-410A)

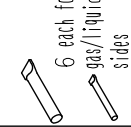
THIS KIT INCLUDES THE FOLLOWING PARTS.

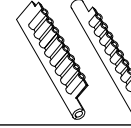
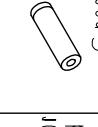
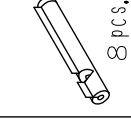
KIT NAME	S H A P E							
	GAS SIDE HEADER	LIQUID SIDE HEADER	PLUGGING TUBES	REDUCER	INSULATION FOR HEADER	INSULATION FOR GAS SIDE ENCLOSED PIPING	INSULATION FOR LIQUID SIDE PIPING	
KHRP 26M22H 4branches	 1 pcs.	 1 pcs.	 2 each for gas/liquid sides	 for gas sides (φ7/8) 2pcs, for liquid sides (φ3/8) 2pcs.	 1 each for gas/liquid sides	 2 pcs.	 4 pcs.	
KHRP 26M33H 8branches	 1 pcs.	 1 pcs.	 6 each for gas/liquid sides	 for gas sides (φ1) 1pcs, for liquid sides (φ5/8) 2pcs, (φ3/8) 2pcs.	 1 each for gas/liquid sides	 6 pcs.	 8 pcs.	
KHRP 26M72H 8branches	 1 pcs.	 1 pcs.	 6 each for gas/liquid sides	 for gas sides (φ5/8) 2pcs, for liquid sides (φ3/4) 1pcs, (φ3/8) 2pcs.	 1 each for gas/liquid sides	 6 pcs.	 8 pcs.	
KHRP 26M73H 8branches	 1 pcs.	 1 pcs.	 6 each for gas/liquid sides	 6 pcs, for gas sides(φ1/2) for liquid sides (φ1/4) 2pcs, (φ7/8) 1pcs.	 1 each for gas/liquid sides	 6 pcs.	 8 pcs.	

*...Make sure gas side header and liquid side header are for R-410A. (Label for R-410A is attached on each part.)

SELECTION PROCEDURE

According to the INSTALLATION MANUAL of outdoor unit.

INSTALLATION PROCEDURE

1 The pipe size of each parts are shown below.

KIT NAME	GAS SIDE HEADER	LIQUID SIDE HEADER
KHP26M22H 4 branches		
KHP26M33H 8 branches		
KHP26M2H 8 branches		
KHP26M73H 8 branches		

- ② For the outlet/inlet pipings which can be connected in several piping sizes, cut the connections of piping diameter to be used with a pipe cutter according to the left lower table,

NOTE) 1. Cut in the center of the connections,

2. PIPE SIDE REDUCER

ex) When connecting the field pipe(φ7/8) to inlet liquid side pipe of KHRP26W73H, use PIPE SIDE REDUCER,

- ③ For non-connected outlet pipings at the indoor unit side for refrigerant branching, install the supplied plugging tube,

When connecting the field piping to inlet piping part B at the outdoor unit of liquid side header,

- Cut part B as shown with a pipe cutter and install it to part A,
- Connect the flared field piping to part B,

- Make sure to flow nitrogen gas through the pipe when brazing.

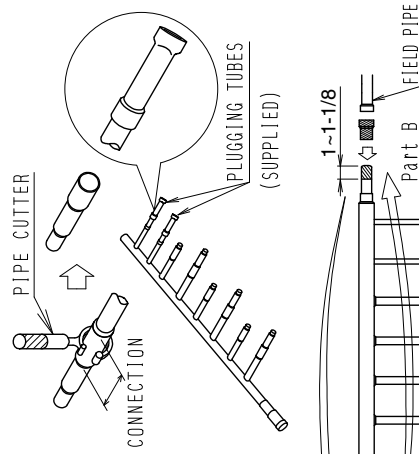

4 Insulation of HEADER

- Be sure to insulate the gas and liquid side HEADER.
- Note) The insulation of the refrigerant piping must be reinforced on the surface of the insulation. For details, see Engineering Data.

GAS SIDE HEADER

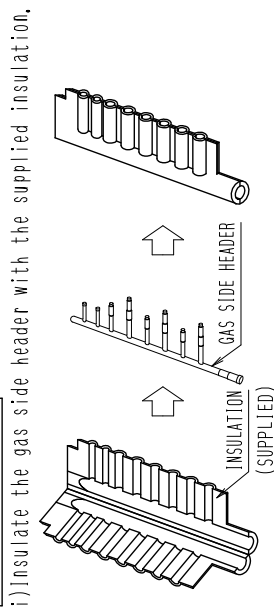

- ii) Seal the supplied insulation and field piping insulation junction with the field supplied tape.

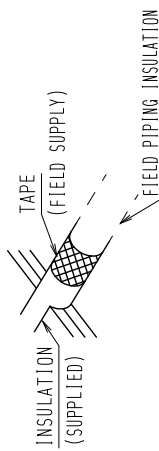

- iii) Seal the plugging tube mounting part with the field supplied tape after installing the supplied insulation for the supplied plugging tube.

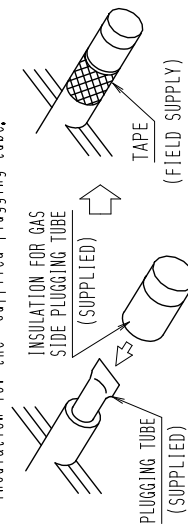

LIQUID SIDE HEADER

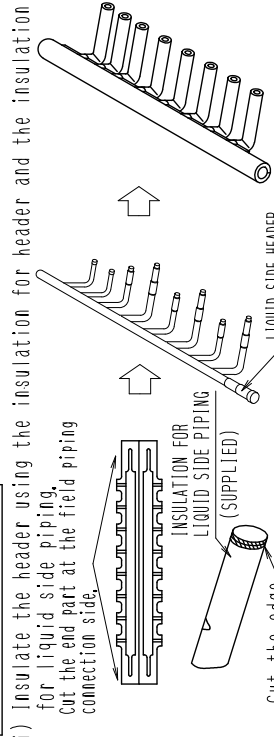

- ii) Seal the supplied insulation and liquid side piping insulation joint, the supplied liquid side piping insulation bending part, and the joint with the field piping insulation, using the field supplied tape. Seal the supplied insulation with a vinyl tape, for example.

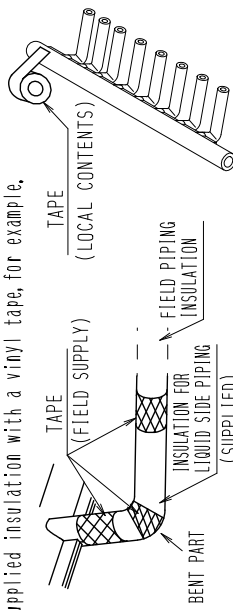

- iii) Using the field supplied tape, seal the plugging tube mounting part after installing the insulation for liquid side piping (supplied).

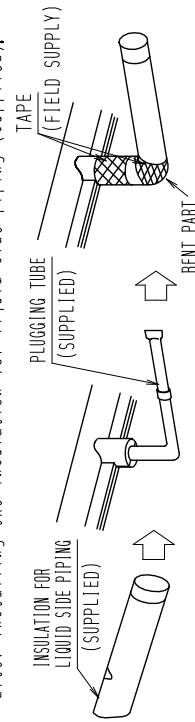

INSTALLATION PRECAUTIONS

• Do not apply extra force on the piping part. The brazed part may be damaged and it may result in gas leakage.

GAS SIDE HEADER

• Place the header on the pedestal and install it so that it is horizontal.

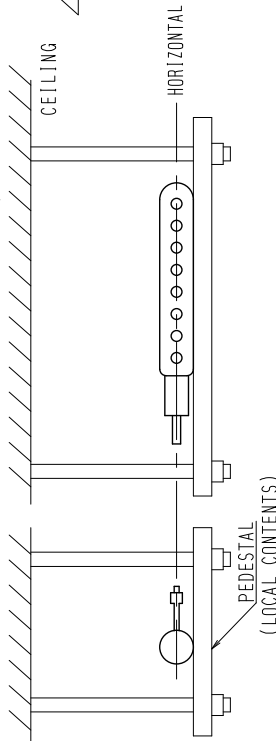

LIQUID SIDE HEADER

• Suspend the header from the ceiling, and be sure to install it so that the outlet/inlet pipings at the header indoor unit side are horizontal at the lower side as shown below.

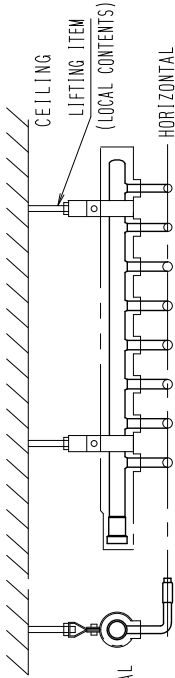

KHRP25M73HU9

REFNET HEADER INSTALLATION MANUAL
 KHRP25M73HU • KHRP26M73HU (FOR R410A)

THESE KITS INCLUDE THE FOLLOWING PARTS.

KIT NAME	S H A P E							
	(SUCTION) GAS SIDE HEADER	DISCHARGE GAS SIDE HEADER	LIQUID SIDE HEADER	INSULATION FOR HEADER	PLUG TUBE	REDUCER	INSULATION FOR GAS SIDE PLUG TUBE	INSULATION FOR LIQUID SIDE PIPING
KHRP 25M73HU (8branches)				2 pcs, for suction gas/discharge gas sides 1 pc, for liquid side 	6 pcs, each for suction gas/discharge gas/liquid sides 	6 pcs, for suction gas side (φ1/2) 6 pcs, for discharge gas side (φ3/4) 6 pcs, for liquid side (φ7/8) 1 pc, (φ1/4) 6 pcs, 	1 2 pcs, 	8 pcs,
KHRP 26M73HU (8branches)				1 pc, each for gas/liquid sides 	6 pcs, each for gas/liquid sides 	6 pcs, for gas side (φ1/2) 1 pc, for liquid side (φ7/8) 1 pc, (φ1/4) 6 pcs, 	6 pcs, 	8 pcs,

*...Make sure these headers are for R410A, (A label for R410A is stuck on them,)

APPLICATION

- Choose between the two kits according to the system and the location,

SYSTEM	HEAT PUMP		HEAT RECOVERY	
KIT NAME	KHRP26M73HU(2 pipings)	KHRP25M73HU(3 pipings)	KHRP26M73HU(2 pipings)	
LOCATION	Outdoor unit-indoor units	Upstream of Branch Selector units	Downstream of Branch Selector units	To cooling-only indoor unit
REFRIGERANT PIPING	Gas side piping Liquid side piping	Suction gas side piping Discharge gas side piping Liquid side piping	Gas side piping Liquid side piping	Suction gas side piping Liquid side piping

SELECTION PROCEDURE

According to the installation manual of outdoor unit,

INSTALLATION PROCEDURE

1 Inlet and outlet sizes of the headers

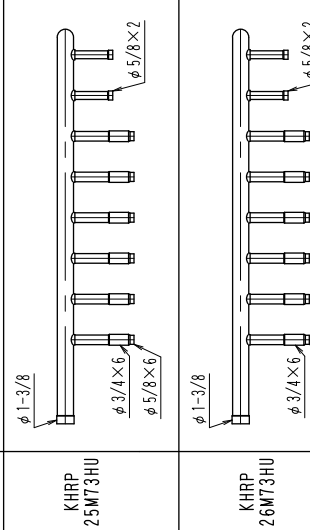
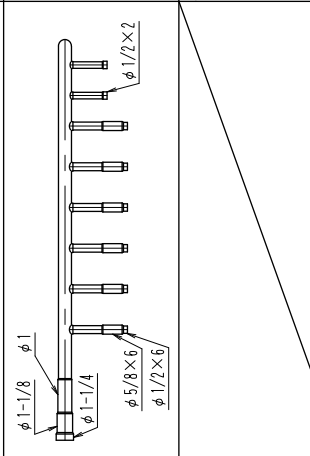
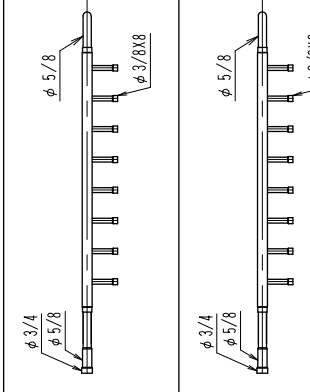
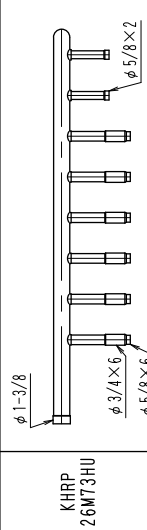
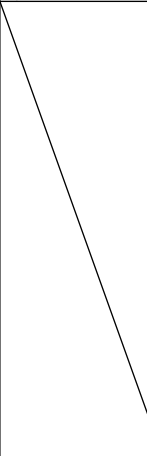
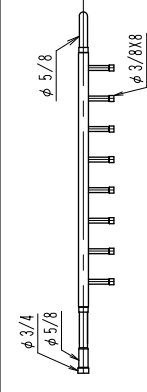
KIT NAME	(SUCTION) GAS SIDE HEADER	DISCHARGE GAS SIDE HEADER	LIQUID SIDE HEADER
KHRP 25M73HU			
KHRP 26M73HU			

2 For the outlet/inlet of headers which can be connected with several sizes of field piping, cut the connections of headers to be used with a pipe cutter according to the above table.

NOTE) 1. Cut the center of the connections.

2. Pipe size reducer

ex) When connecting a field pipe (φ7/8) to the inlet of liquid side header, use the supplied pipe size reducer.

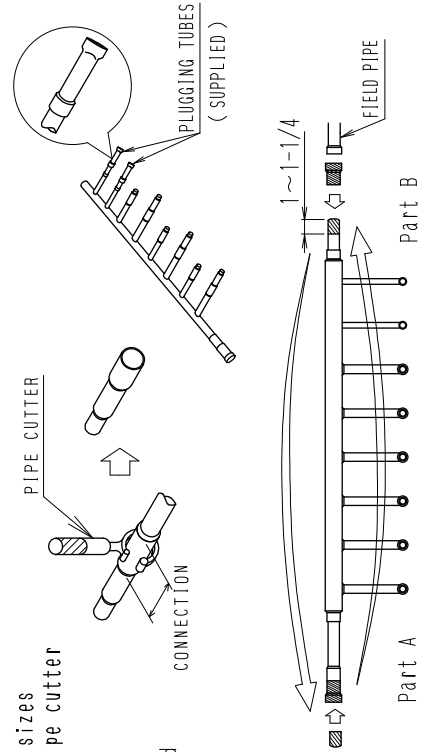

3 For non-connected outlet at the indoor unit side, install the supplied plug tubes,

When connecting a field piping to the inlet part B of liquid side header,

- Cut the part B as shown with a pipe cutter and install it to the part A.
- Connect a flared field piping to the part B.

• Make sure to flow nitrogen gas through piping when brazing.

4 Insulation of HEADER

-Be sure to insulate the gas and liquid side header.

Note) Insulation for refrigerant piping must be reinforced based on environment of installation site. Otherwise, dew may condensate on the surface of the insulation. For details, see the Engineering Data.

(SUCTION)GAS/DISCHARGE GAS SIDE HEADER

i) Insulate the gas side header with the supplied insulation.

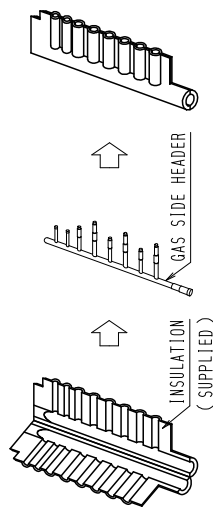

LIQUID SIDE HEADER

i) Insulate the liquid side header with the supplied insulation.

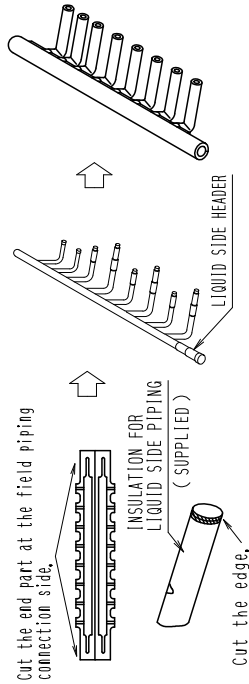

ii) Seal the supplied insulation and field piping insulation junction with field supplied tape.

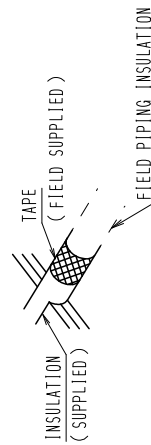

ii) Seal a joint of the insulations and a bent part with field supplied tape.

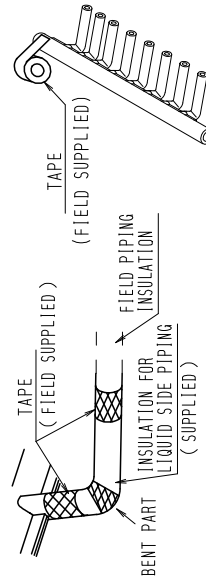

iii) Seal the plug tube with field supplied tape after installing the supplied insulation for the supplied plugging tube.

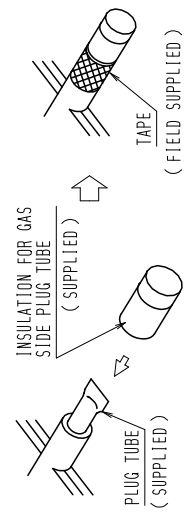

iii) Seal the plug tube after installing the insulation for liquid side piping (supplied).

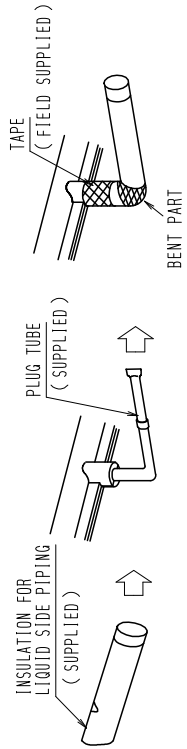

INSTALLATION PROCEDURE

(SUCTION)GAS/DISCHARGE GAS SIDE HEADER

- Place the header on the pedestal and install it horizontally.

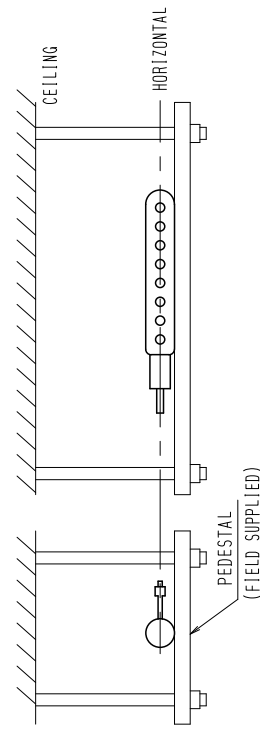

LIQUID SIDE HEADER

- Suspend the header from the ceiling and be sure to install it so that the outlet/inlet pipings at the indoor unit side are horizontal at the lower side as shown below.

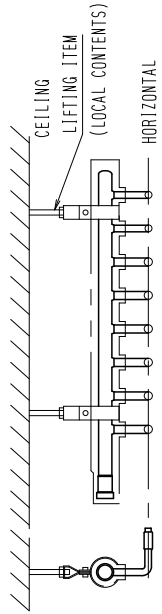

5.3 Outdoor Unit Multi Connection Piping Kit

BHFP26P100U

Unit: in.

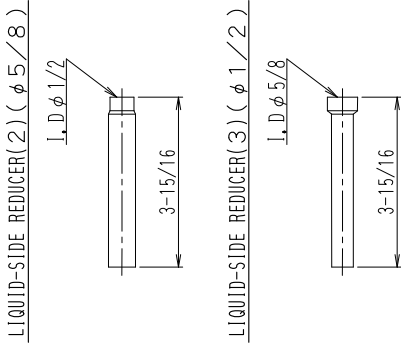

LIQUID-SIDE JOINT + LIQUID-SIDE REDUCER(1)

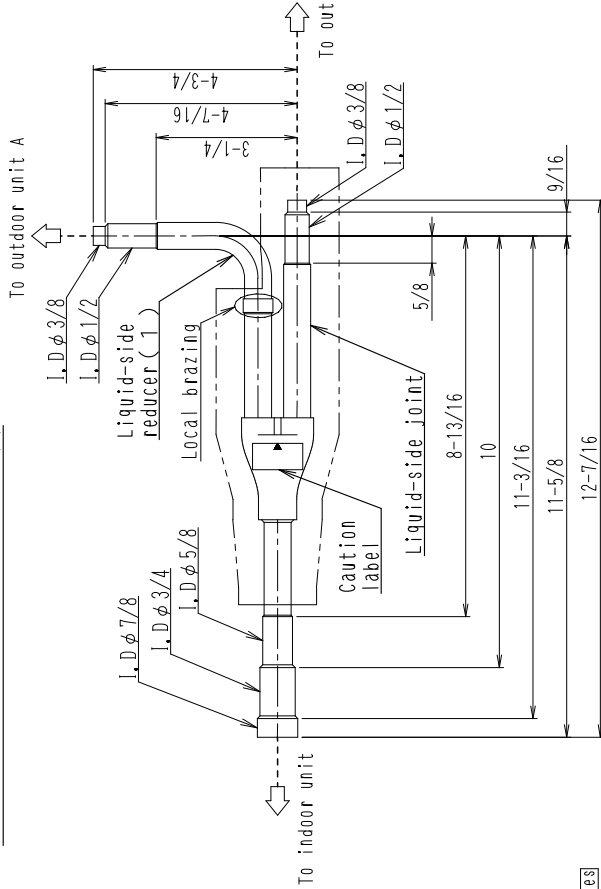

- NOTE**
1. **-----** in the figure show connecting pipes (field supply).
 2. Refer to the engineering data for the size of connecting pipes.
 3. When installing this kit, apply the following restrictions,
 - Install the joint horizontally. Do not tilt the joint more than $\pm 15^\circ$ (see Figure 1). Do not install the joint vertically (see Figure 2).
 - Make sure the piping up to the joint is straight for more than 19-11/16in. Do not bend the field piping within this range. When a straight field piping more than 4-3/4in. (suction gas-side and HP/LP gas-side) or 16-9/16in. (liquid-side) is connected, more than 19-11/16in. of straight section can be ensured (see Figure 3).
 4. Use bundled reducers as necessary.

ACCESSORIES

- SUCTION GAS-SIDE JOINT : 1
- HP/LP GAS-SIDE JOINT : 1
- LIQUID-SIDE JOINT : 1
- SUCTION GAS-SIDE REDUCER (1) : 1
- SUCTION GAS-SIDE REDUCER (2) : 1
- SUCTION GAS-SIDE REDUCER (3) : 1
- HP/LP GAS-SIDE REDUCER (1) : 1
- HP/LP GAS-SIDE REDUCER (2) : 1
- HP/LP GAS-SIDE REDUCER (3) : 2
- LIQUID-SIDE REDUCER (1) : 1
- LIQUID-SIDE REDUCER (2) : 1
- LIQUID-SIDE REDUCER (3) : 2
- INSULATION MATERIAL FOR SUCTION GAS-SIDE PIPE : 1
- INSULATION MATERIAL FOR HP/LP GAS-SIDE PIPE : 1
- INSULATION MATERIAL FOR LIQUID-SIDE PIPE : 1
- INSTALLATION MANUAL

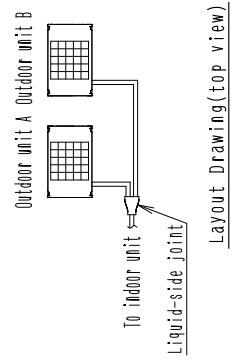
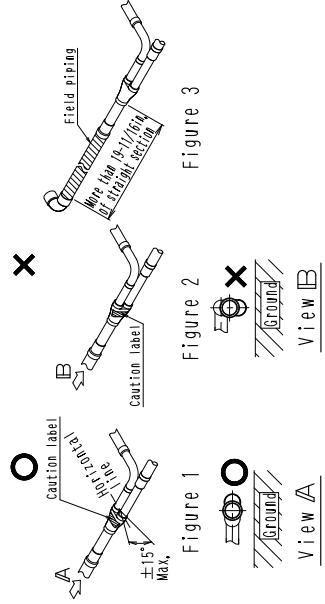

Layout Drawing(top view)

3D092470

Unit: in.

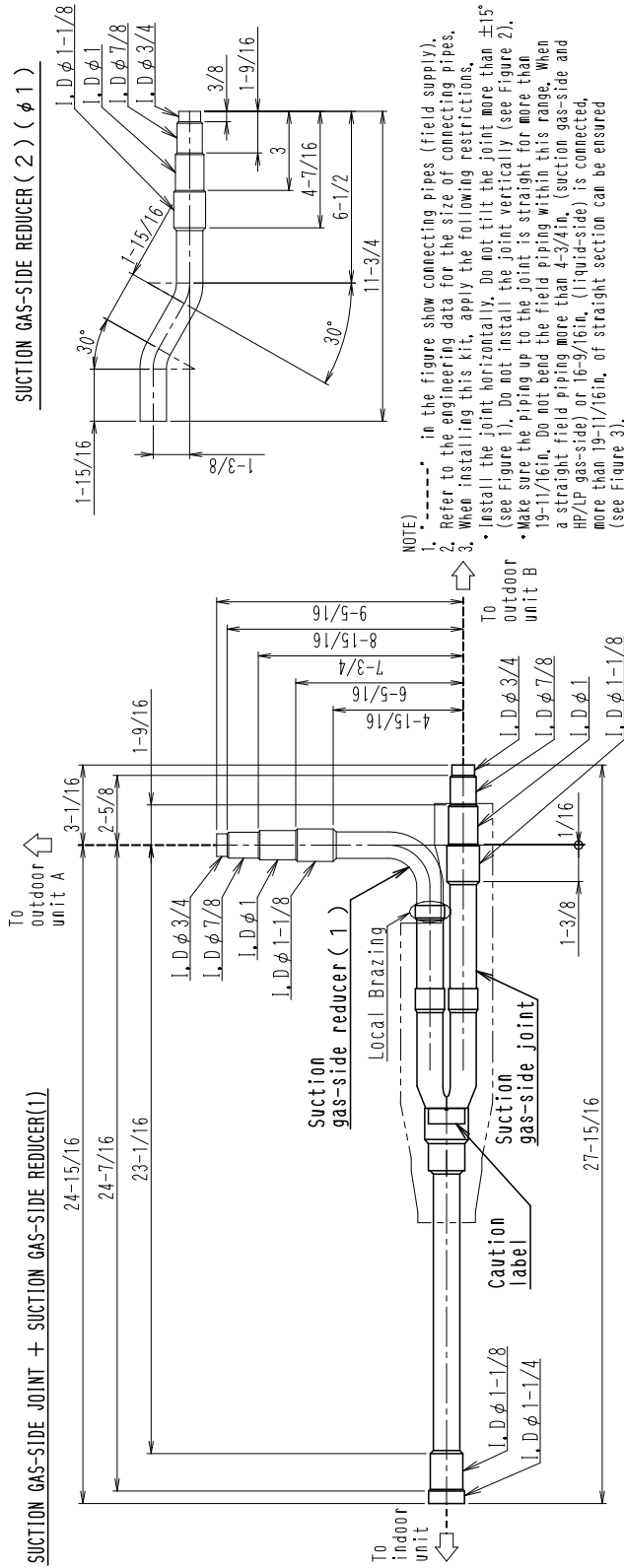

NOTE

- in the figure show connecting pipes (field supply).
- Refer to the engineering data for the size of connecting pipes.
- When installing this kit, apply the following restrictions.
 - Install the joint horizontally. Do not tilt the joint more than ±15° (see Figure 1). Do not install the joint vertically (see Figure 2).
 - Make sure the piping up to the joint is straight for more than 19-11/16in. Do not bend the field piping within this range. When a straight field piping more than 4-3/4in. (liquid-side) is connected, more than 19-11/16in. of straight section can be ensured (see Figure 3).
- Use bundled reducers as necessary.

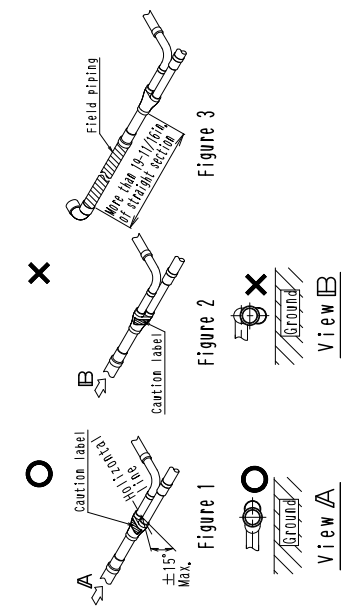

3D092468

Unit: in.

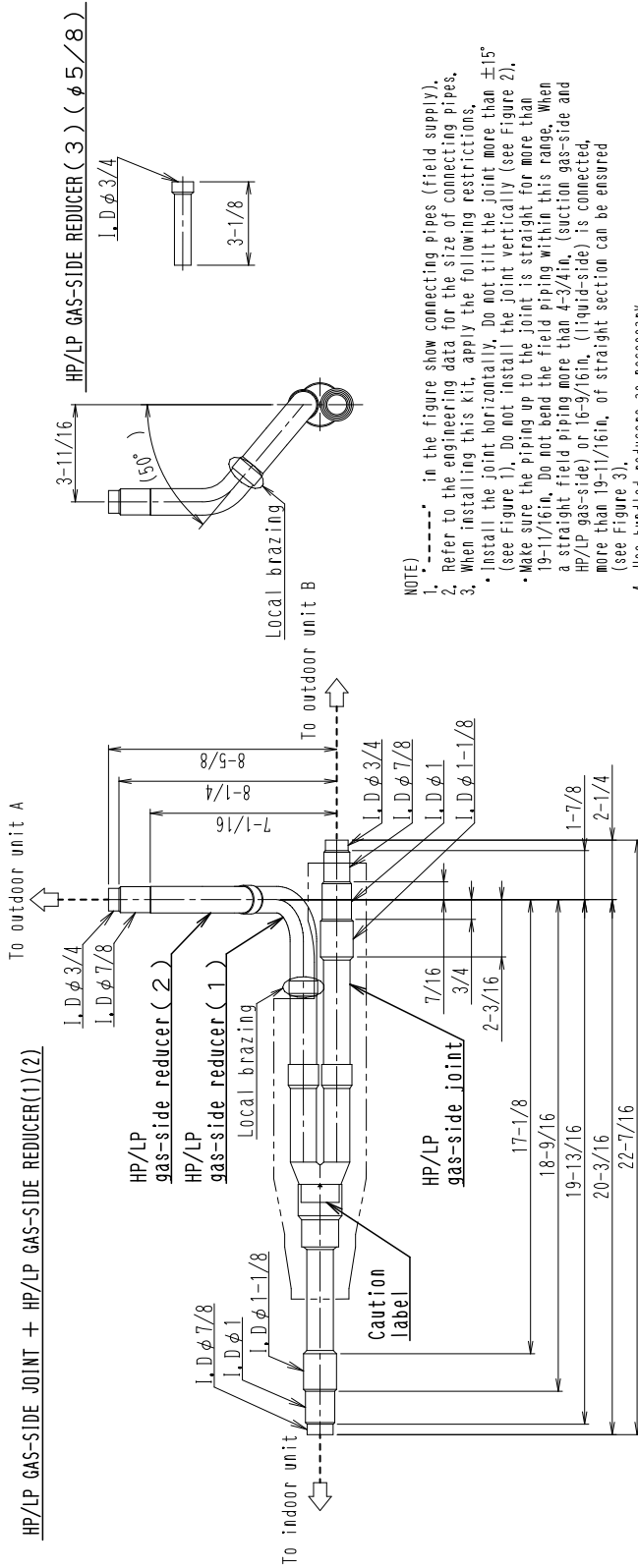

Accessories

- SUCTION GAS-SIDE JOINT : 1
 - HP/LP GAS-SIDE JOINT : 1
 - LIQUID-SIDE JOINT : 1
 - SUCTION GAS-SIDE REDUCER (1) : 1
 - SUCTION GAS-SIDE REDUCER (2) : 1
 - SUCTION GAS-SIDE REDUCER (3) : 1
 - HP/LP GAS-SIDE REDUCER (1) : 1
 - HP/LP GAS-SIDE REDUCER (2) : 1
 - HP/LP GAS-SIDE REDUCER (3) : 2
 - LIQUID-SIDE REDUCER (1) : 1
 - LIQUID-SIDE REDUCER (2) : 1
 - LIQUID-SIDE REDUCER (3) : 2
 - INSULATION MATERIAL FOR SUCTION GAS-SIDE PIPE : 1
 - INSULATION MATERIAL FOR HP/LP GAS-SIDE PIPE : 1
 - INSULATION MATERIAL FOR LIQUID-SIDE PIPE : 1
- INSTALLATION MANUAL

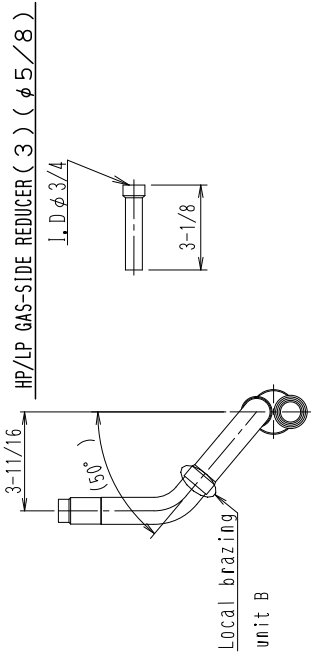
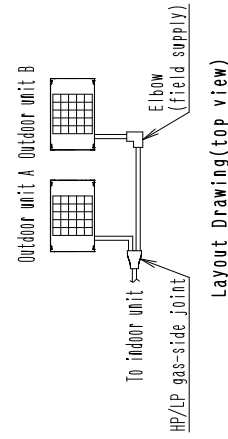

- NOTE**
1. In the figure show connecting pipes (field supply).
 2. Refer to the engineering data for the size of connecting pipes.
 3. When installing this kit, apply the following restrictions.
 - Install the joint horizontally. Do not tilt the joint more than ±15° (see Figure 1). Do not install the joint vertically (see Figure 2).
 - Make sure the piping up to the joint is straight for more than 19-11/16in. Do not bend the field piping within this range. When a straight field piping more than 4-3/4in. (suction gas-side and HP/LP gas-side) or 16-9/16in. (liquid-side) is connected, more than 19-11/16in. of straight section can be ensured (see Figure 3).
 4. Use bundled reducers as necessary.

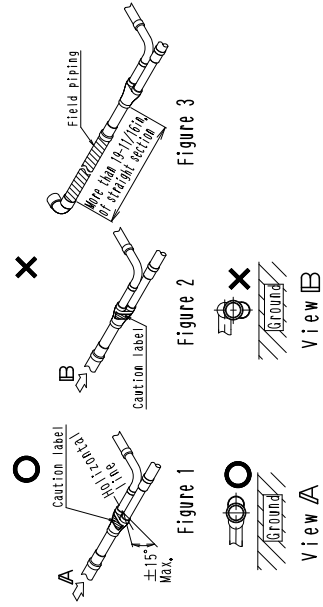

3D092469

VRV IVR Series Please be sure to read before installation and follow the instructions 1P392285-1B
 Outdoor unit Multi Connection Piping Kit Installation Manual BHF P 26 P 1 0 0 U

Component parts ■ This kit contains the following parts.
 ◀ Do not throw away any of the accessories until installation is completed. ▶

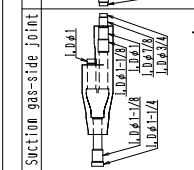
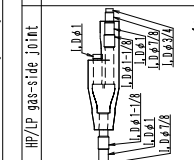
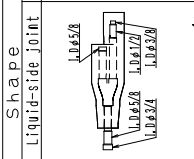
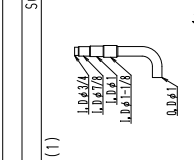
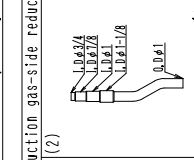
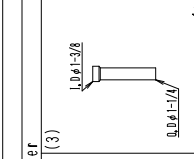
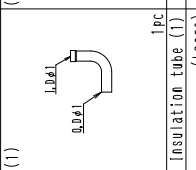
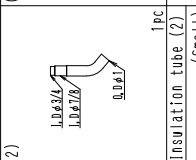
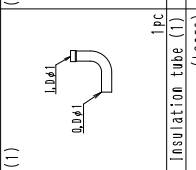
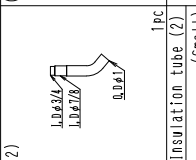
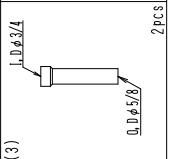
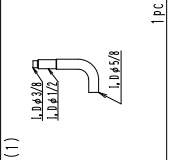
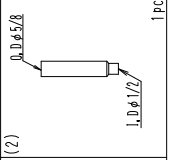
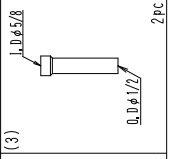
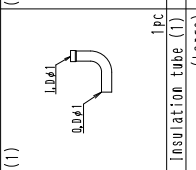
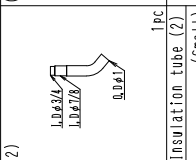
Kit Name	Suction gas-side joint	HP/IP gas-side joint	Liquid-side joint	Suction gas-side reducer	Liquid-side reducer	HP/IP gas-side reducer	Insulation tube (1)	Insulation tube (2)
BHF26P 100U	 (1)	 (1)	 (1)	 (2)	 (2)	 (3)	 (1)	 (2)
	 (1)	 (2)	 (1)	 (2)	 (2)	 (3)	 (1)	 (2)

Caution

- See the outdoor unit's installation manual for outdoor units installation.
- Installation of interconnecting piping between the outdoor and indoor units, REFNET joint or REFNET header will be needed separately.
- This kit is only for 2 outdoor units combination.
- Use bundled reducers as necessary.

Field supply parts ■ The following parts are needed to connect this kit and are not included.

Name	Field supply parts	Selection Procedure
Insulation for piping	See the "Connecting pipe sizes and location of cutting the joint" for Connection piping	
Elbow	Section gas-side details on the necessary size, HP/IP gas-side	
Tape	For insulation materials	

To the piping installer When installing this kit, apply the following restrictions.

Restrictions on installing multi connection piping kit

- Improper installation may lead to malfunction of the outdoor unit.
- Install the joint horizontally. Do not tilt the joint more than $\pm 15^\circ$ (see Figure 1). Do not install the joint vertically (see Figure 2).
- Make sure the piping up to the joint is straight for more than 19-1/16in. Do not bend the field piping within this range. When a straight field piping more than 4-3/4in. (suction gas-side and HP/IP gas-side) or 16-9/16in. (liquid-side) is connected, more than 19-1/16in. of straight section can be ensured (see Figure 3).

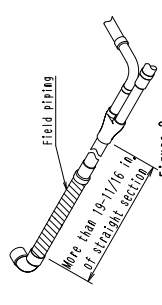
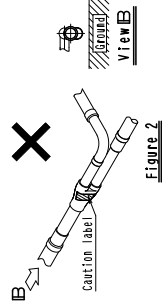
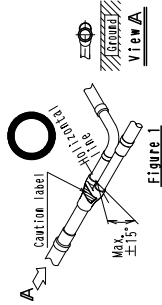

(2) Put the pipes between outdoor units horizontally (Pattern 1) or upward slopes from unit A to unit B (Pattern 2) to avoid oil accumulating in the pipes.

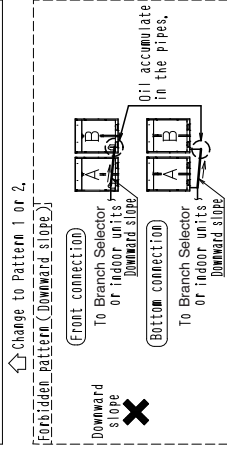
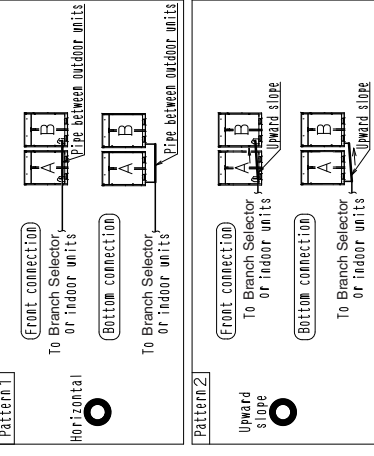

(3) Connect the stop valves and the joints as shown in below (A or B) to avoid oil accumulating in the outdoor units when not operated.

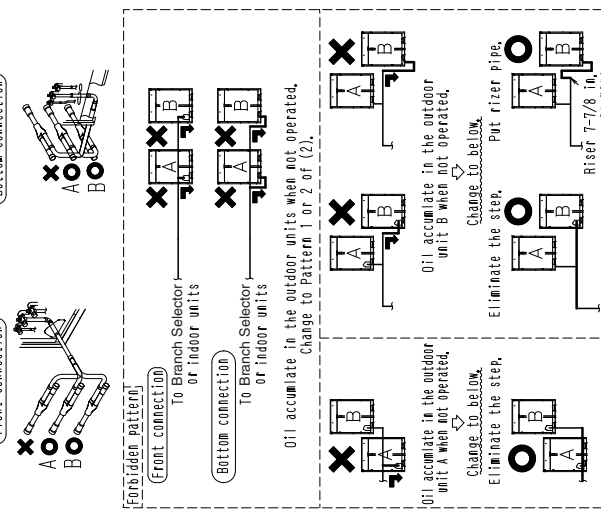

Connecting pipe sizes and location of cutting the joint

Select cutting points of joints and reducers which are suitable for the sizes of the interconnecting pipes determined according to the tables below and cut them with a pipe cutter.

Cutting procedure

- Use pipe cutter for cutting.
- Cut joints and reducers in order that their fit depths should be 5/8in. or more.

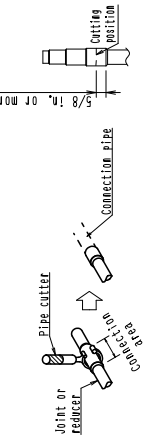

Reducers for main pipes

- Suction gas-side reducer (3) and liquid-side reducer (2) will be used when the outdoor units total capacity type are shown in right (Figure 4 and 5).

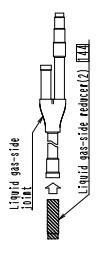
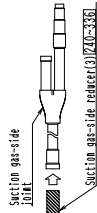

■ Main pipe Select the pipe sizes according to the total capacity of the outdoor units. (units: in.)

Outdoor units total capacity type	Suction gas-side pipe HP/IP gas-side pipe	Liquid-side pipe
144		ø1/2
168	ø1-1/8	ø7/8
192, 216		ø5/8
240	ø1-3/8	ø1-1/8
264-336		ø3/4

■ Pipes between the joint and the outdoor units Select the pipe sizes according to the capacity of the outdoor units. (units: in.)

Outdoor unit capacity type	Suction gas-side pipe HP/IP gas-side pipe	Liquid-side pipe
72	ø3/4	ø5/8
96	ø7/8	ø3/8
120		ø3/4
144	ø1-1/8	ø1/2
168		ø5/8

Oil accumulate in the outdoor unit A when not operated. Change to below. Eliminate the step.

Oil accumulate in the outdoor unit B when not operated. Change to below. Eliminate the step. Put rizer pipe. Riser 7-7/8 in. or more.

Select cutting points of joints and reducers which are suitable for the sizes of the interconnecting pipes determined according to the tables below and cut them with a pipe cutter.

1-1 Installation examples Procedure for front connection

Example of connection

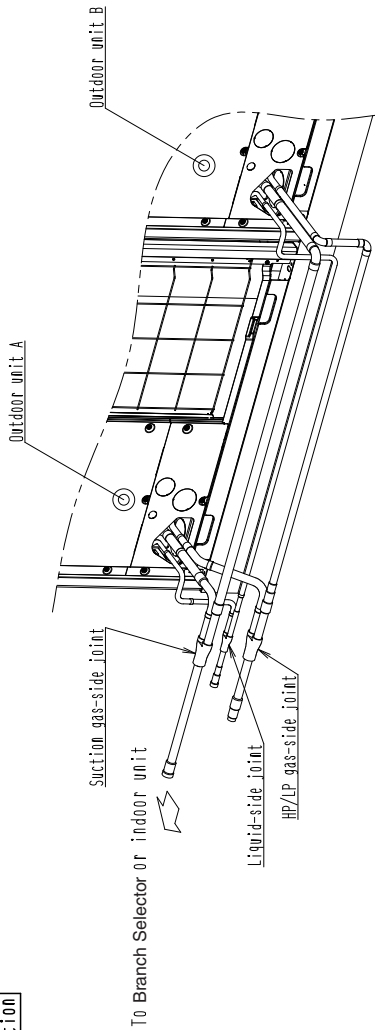

1-2 Connection of suction gas-side and HP/LP gas-side pipe

- Connect the pipes as shown in the right figure. (At first, connect the joints and reducers,)
- See the caution section in the installation manual attached to the outdoor units for brazing pipes.
- Install the joints horizontally. (See View C.)
- Connect HP/LP gas-side reducer (1) towards about 50° upward from horizontal, then connect HP/LP gas-side reducer (2). (See View C.)
- Refer to [Cutting procedure] and Table 1 for cutting points of joints and reducers.

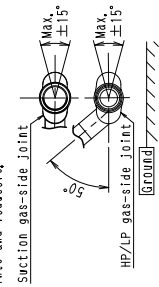
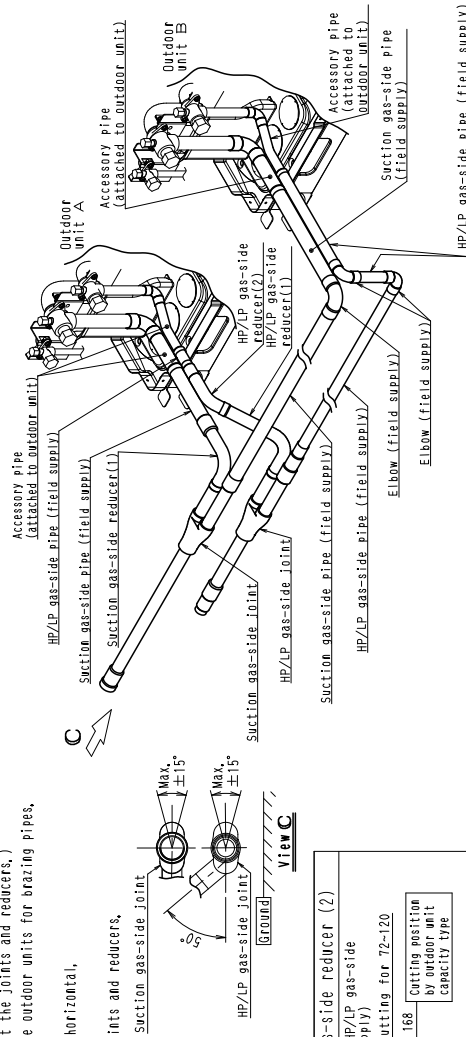

Table 1

Suction gas-side reducer (1) Connection to suction gas-side pipe (field supply)	HP/LP gas-side reducer (2) Connection to HP/LP gas-side pipe (field supply)
No cutting for 72 96 Cutting position by outdoor unit capacity type 120-168	No cutting for 72-120 144, 168 Cutting position by outdoor unit capacity type Connection to HP/LP gas-side reducer (1)

1-3 Connection of liquid-side pipe

- Connect the pipes as shown in the right figure. (At first, connect the joints and reducers.)
- See the caution section in the installation manual attached to the outdoor units for brazing pipes.
- Install the joints horizontally. (See View D.)
- Connect liquid-side reducer (1) towards vertically, then connect liquid-side pipe (field supply). (See View D.)
- Refer to [Cutting procedure] and Table 2 for cutting points of joints and reducers.

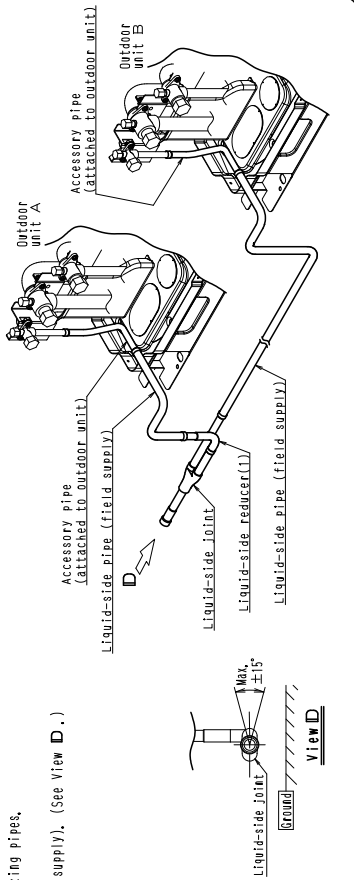

Table 2 Liquid-side reducer (1)

Connection to liquid-side pipe (field supply)	No cutting for 72, 96
Connection to liquid-side joint	Cutting position by outdoor unit capacity type

1-4 Insulation of joints

After completing all piping works and air tight test following installation manual attached to the outdoor units, insulate the joints.

- <Insulation of joints procedure> (Refer to the right figure.)
- (1) Fit the insulating tube to the reducer and temporarily keep it in place with tape.
 - (2) Fit the insulation to the joint and temporarily keep it in place with tape without leaving a gap between the insulation mating faces. (See the right figure.)
 - (3) Seal the seam between the insulation and the field supply piping insulation with the field supply tape.
 - (4) Wrap the tape around the insulation attached to the joint without leaving a gap. (See section shown in the right figure.)

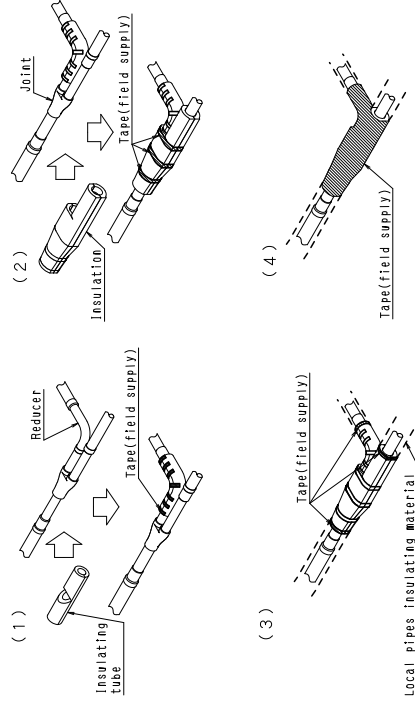

2-1 Installation examples Procedure for lower front connection

Example of connection

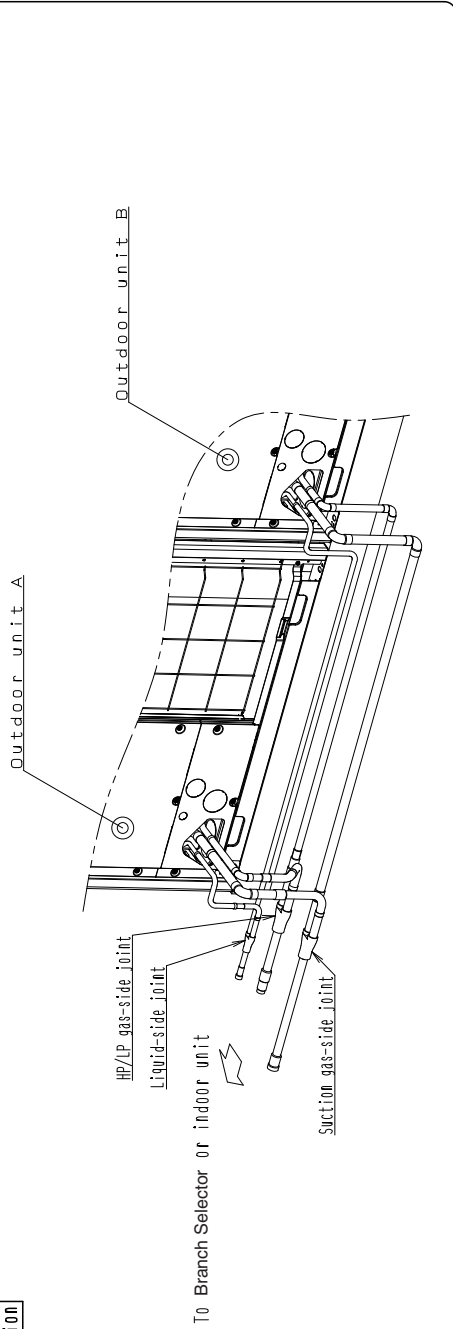

2-2 CONNECTION OF SUCTION GAS-SIDE AND HP/LP GAS-SIDE PIPE

- Connect the pipes as shown in the right figure. (At first, connect the joints and reducers.)
- See the caution section in the installation manual attached to the outdoor units for brazing pipes.
- Install the joints horizontally. (See View E.)
- Connect HP/LP gas-side reducer (1) towards about 40° upward from horizontal, then connect HP/LP gas-side reducer (2). (See View E.)
- Refer to [Cutting procedure] and Table 3 for cutting points of joints and reducers.

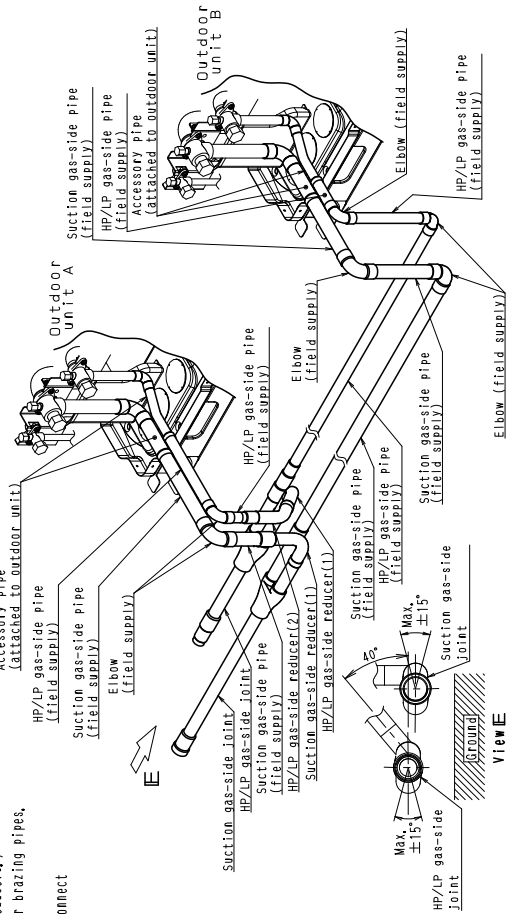

Table 3

Suction gas-side reducer (1)	HP/LP gas-side reducer (2)
Connection to suction gas-side pipe (field supply) No cutting for 72 96 Cutting position by outdoor unit capacity type 120-168	Connection to HP/LP gas-side pipe (field supply) No cutting for 72-120 144-168 Cutting position by outdoor unit capacity type Connection to HP/LP gas-side reducer (1)

2-3 Connection of liquid-side pipe

- Connect the pipes as shown in the right figure. (At first, connect the joints and reducers.)
- See the caution section in the installation manual attached to the outdoor units for brazing pipes.
- Install the joints horizontally. (See View F.)
- Connect liquid-side reducer (1) towards vertically, then connect liquid-side pipe (field supply). (See View F.)
- Refer to [Cutting procedure] and Table 4 for cutting points of joints and reducers.

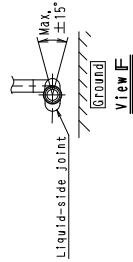
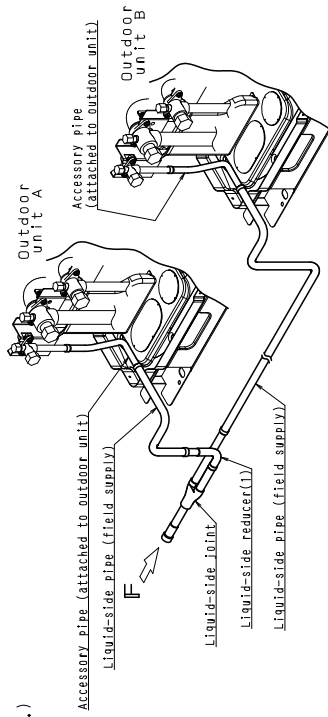

Table 4

Liquid-side reducer (1)	Cutting position by outdoor unit capacity type
Connection to liquid-side pipe (field supply)	No cutting for 72 . 96
Connection to liquid-side joint	120-168

2-4 Insulation of joints

After completing all piping works and air tight test following installation manual attached to the outdoor units, insulate the joints.

- <Insulation of joints procedure> (Refer to the right figure.)
- (1) Fit the insulating tube to the reducer and temporarily keep it in place with tape.
 - (2) Fit the insulation to the joint and temporarily keep it in place with tape without leaving a gap between the insulation mating faces. (See the right figure.)
 - (3) Seal the seam between the insulation and the field supply piping insulation with the field supply tape.
 - (4) Wrap the tape around the insulation attached to the joint without leaving a gap. (Hatched section shown in the right figure.)

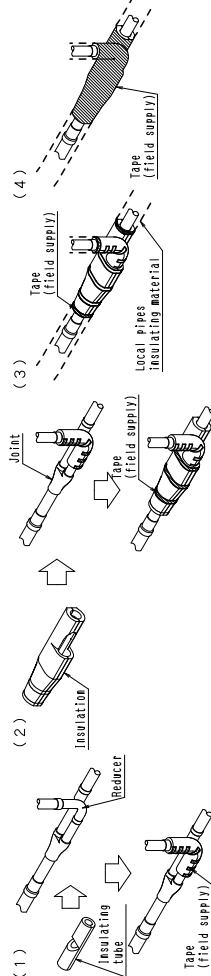

3-1 Installation examples Procedure for bottom Connection

Caution This installation is only possible if there is enough space to perform brazing and racking underneath the outdoor units.

Example of connection

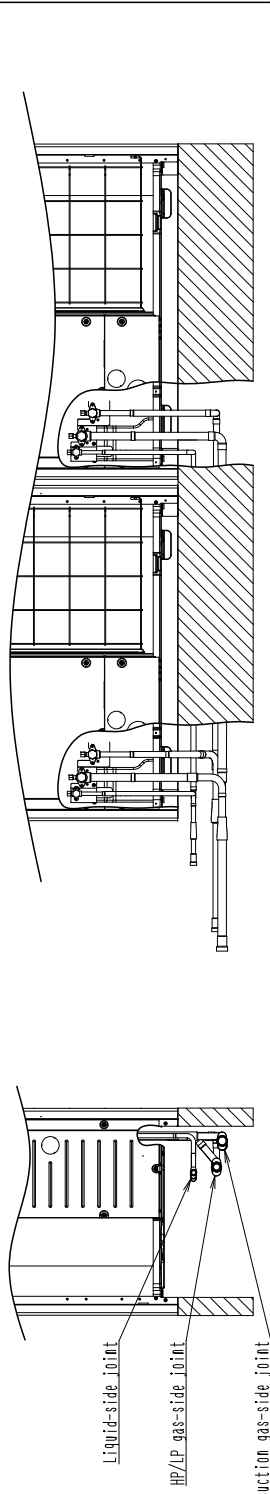

3-2 Connection of suction gas-side and HP/LP gas-side pipe

- Connect the pipes as shown in the right figure. (At first, connect the joints and reducers.)
- See the caution section in the installation manual attached to the outdoor units for brazing pipes.
- Install the joints horizontally. (See View G.)
- Connect HP/LP gas-side reducer (1) towards about 40° upward from horizontal, then connect HP/LP gas-side reducer (2). (See View G.)
- Refer to (Cutting procedure) and Table 5 for cutting points of joints and reducers.

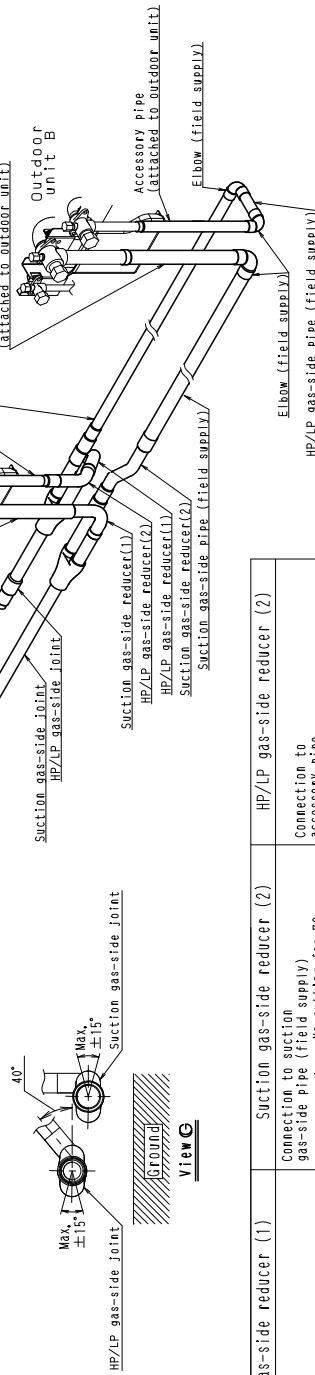
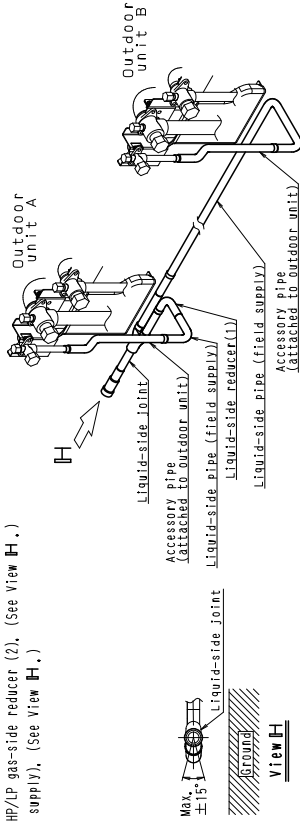
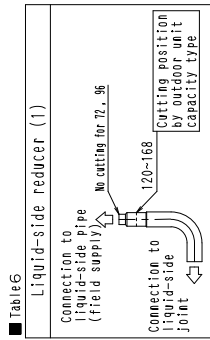

Table 5

Suction gas-side reducer (1)	Suction gas-side reducer (2)	HP/LP gas-side reducer (2)
Connection to accessory pipe No cutting for 72 36 Cutting position by outdoor unit capacity type 120-168 Connection to suction gas-side joint	Connection to suction gas-side pipe (field supply) No cutting for 72 96 Cutting position by outdoor unit capacity type 120-168 Connection to suction gas-side joint	Connection to accessory pipe No cutting for 72-120 144, 168 Cutting position by outdoor unit capacity type Connection to HP/LP gas-side reducer (1)

3-3 Connection of liquid-side pipe

- Connect the pipes as shown in the right figure. (At first, connect the joints and reducers.)
- See the caution section in the installation manual attached to the outdoor units for brazing pipes.
- Install the joints horizontally. (See View H.)
- Connect HP/LP gas-side reducer (1) towards about 15° upward from horizontal, then connect HP/LP gas-side pipe (field supply). (See View H.)
- Connect liquid-side reducer (1) towards horizontally, then connect liquid-side pipe (field supply). (See View H.)



3-4 Insulation of joints

After completing all piping works and air tight test following installation manual attached to the outdoor units, insulate the joints.

- (1) Insulation of joints procedure > (Refer to the right figure.)
 (1) Fit the insulating tube to the reducer and temporarily keep it in place with tape.
 (2) Fit the insulation to the joint and temporarily keep it in place with tape without leaving a gap between the insulation mating faces. (See the right figure.)
 (3) Seal the seam between the insulation and the field supply piping insulation with the field supply tape.
 (4) Wrap the tape around the insulation attached to the joint without leaving a gap.
 (Hatched section shown in the right figure.)

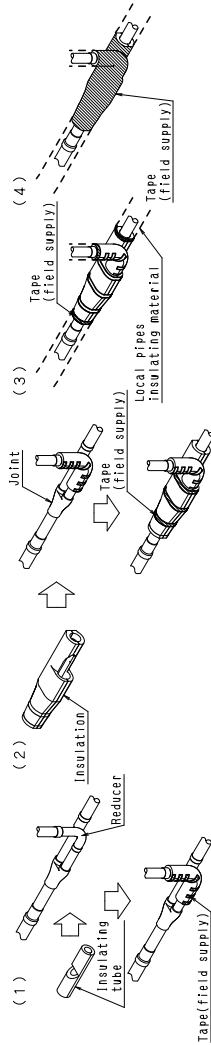

6. Caution Label

6.1 RELQ72-120TATJU / RELQ72-120TAYDU / RELQ72-120TAYCU

Service Precautions (1/2) (Touch the noncoated metal part to eliminate static electricity before performing service) (e.g. the control box cover).

CAUTION when performing service inside the control box

⚠ WARNING ⚠ Caution for electric shock

1. Make sure to turn off the power supply before remove the control box cover. (Touching electric parts may cause electric shock.)
2. Do not open the control box cover for 10 minutes after the power supply is turned off.
3. Measure the voltage between terminals on the terminal block for power supply with a tester and confirm that the power supply is turned off. In addition, measure the points shown below with a tester and confirm that the voltage of the capacitor in the main circuit is less than DC 50V.
4. To prevent a damage of the printed circuit boards, touch the noncoated metal part and make sure to eliminate static electricity before pulling out or plugging in the connector.
5. The work must be started after pulling out the junction connector X1A · X2A · X3A · X4A (X3A X4A are nothing according to the model. Please see wiring diagram for details.) for the fan motor in the outdoor unit and be careful not to touch the energized parts. (If the fan rotates by strong wind, it may cause storage of electricity in the capacitor in the main circuit and electric shock.)
6. After the service is finished, plug in the junction connector.

- For details, see the wiring diagram label on the back of the control box cover.
- Otherwise, malfunction code "E7" will be displayed on 7 segment display of outdoor unit printed circuit board (A1P) and in the remote controller due to wrong connection, and normal operation will not be performed.

ⓘ After service is complete, make sure to close the control box cover. (Water soaking or foreign object may cause failure.)

CAUTION for piping work and additional refrigerant charge

- Use the charging hose and gauge manifold designed for R410A in order to withstand the pressure and prevent impurities (such as SUNISO oil) from mixing into.
- Carry out a nitrogen blow when brazing.
- Perform the air tightness and the vacuum drying certainly. (The air tightness test pressure: 550 psi, make sure to use nitrogen gas.)
- Charge the additional refrigerant in liquid state.

CAUTION while check operation

- Make sure to turn on the power supply of all connected units (indoor · BS · outdoor) before operation.
- Make sure to close all outer panels when operating. Otherwise, the system cannot be checked properly.

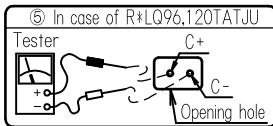

There are measurement points at the back of the opening hole.

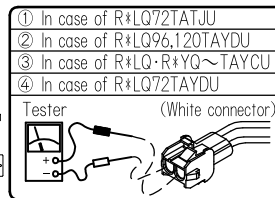
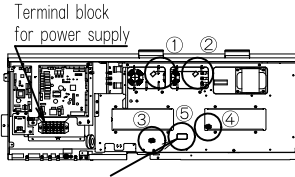

CAUTION for removing and installing the control box cover

[Method of removal]

- ① Remove the 6 screws fixing the cover.
- ② Pull the cover forward.
- ③ Slide the cover downward until the upper tip appears.

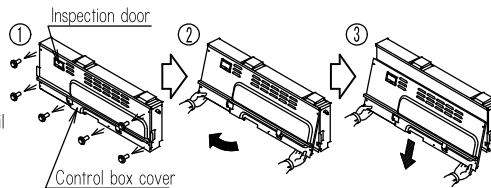

[Method of installation]

For installing the cover, follow the [Method of removal] in the reverse order.

[CAUTION]

- Do not remove the cover by force, if the cover is deformed, water may enter inside, which may cause failure.
- Install the cover so that the sealing material does not get caught in control box. (See the right figure.)

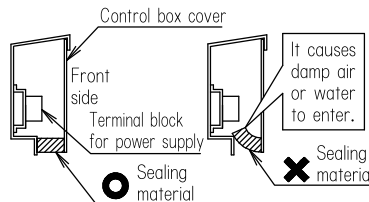

⚠ DANGER ⚠ ELECTRIC SHOCK HAZARD!
 DISCONNECT ALL REMOTE POWER SUPPLIES BEFORE INSTALLING OR SERVICING THIS EQUIPMENT.
 Failure to do so could lead to serious injury or death. Only a qualified service technician should install or service this equipment.

DANGER D' ELECTROCUTION!
 DÉCONNECTER TOUTES LES ALIMENTATIONS ÉLECTRIQUES ÉLOIGNÉES AVANT D'INSTALLER OU DE RÉPARER CET APPAREIL.
 Le non respect de cette recommandation peut entraîner des blessures graves ou la mort. Seul un technicien de service qualifié peut installer ou réparer cet appareil.

Service precautions (2/2)

Field setting

If required, carry out the field setting according to the following instructions. For details, see the service manual.

1. How to operate

- For operating the push button switch, open the inspection door as shown in the below figure with the power supply turned on, and use a resin ballpoint or non-conducting object. After the work is finished, make sure to close the inspection door.

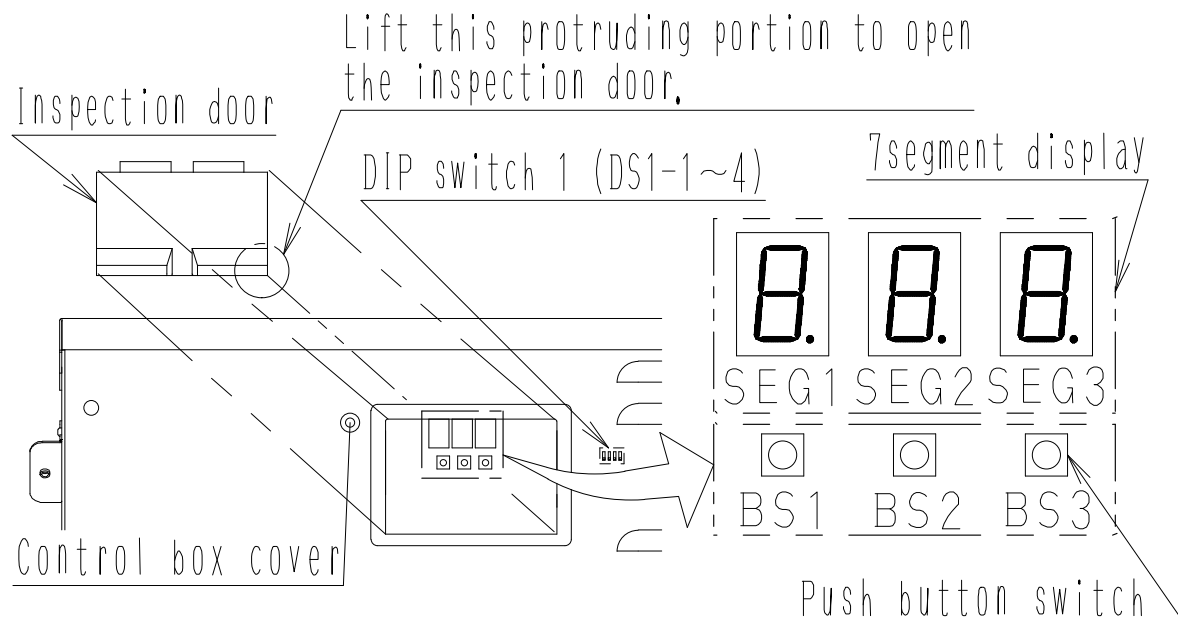

2. Setting by the push button switch (BS1~3)

●Function of the push switch

Push button	Button types	Use
BS1	New page button	For changing setting mode
BS2	Operation button	For changing field setting
BS3	Confirmation button	
BS2 long push	Operation button	For check operation
BS3 long push	Confirmation button	For resetting the address when the wiring is changed or additional indoor unit is installed

●Normal Mode, Setting Mode, Confirmation mode change method

Push new page button (BS1). It can switch confirmation mode, normal mode and setting mode.

Setting mode can use for setting (A)~(H) as shown in the right table.

Confirmation mode can use for confirmation of (K)•(L) items as shown in the right table.

(Note) About other settings and malfunction codes, see the service manual.

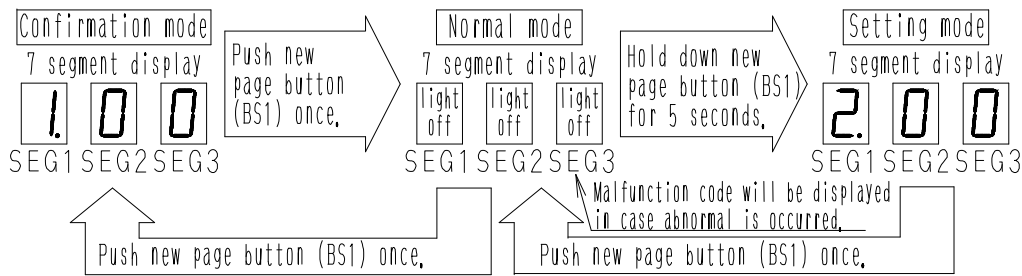

! If you get confused in the setting process, push new page button (BS1), then the system return to initial state (Normal mode).

- For each type setting, make sure to set the master unit. Sub unit setting is invalid.
- Outdoor unit which connect with BS unit (indoor unit) by transmission wiring is master unit, others are sub units.
- Master unit and sub unit can be distinguished by 7 segment display according to operation below.

		7 Segment display			
		SEG1	SEG2	SEG3	
(1)	In Normal mode, push new page button (BS1) and change to Confirmation mode. Confirm 7 segment display show right description.	1	○	○	
		Master unit	light off	light off	○
(2)	Push confirmation button(BS3) and confirm the unit master or sub (see right).	Sub unit 1	light off	light off	1
		Sub unit 2	light off	light off	2

Set [Setting mode] or [Confirmation mode] first, then perform procedure below.		Details of setting		7 Segment display			
				SEG1	SEG2	SEG3	
Setting procedure	① Push operation button (BS2) and adjust 7 segment display to the required mode shown in right. (*1) For selecting low noise operation or demand operation from outside, or performing cool/heat setting by cool/heat central remote control, external control adapter for outdoor unit (optional accessory) is required. For details, see the instruction attached to the adapter.	Ⓐ Additional refrigerant charge operation setting	2	2	0		
		Ⓑ Refrigerant recovery operation / Evacuation mode setting	2	2	1		
		Ⓒ Night time low noise setting	2	2	2		
		Ⓓ External low noise level setting(*1)	2	2	5		
		Ⓔ Demand level setting(*1)	2	3	0		
		Ⓕ External low noise demand setting (*1)	2	1	2		
		Ⓖ High static pressure setting	2	1	8		
		Ⓗ Year-round cooling (outdoor temp. -4°F(-20°C)) setting (*5)	2	4	5		
		② Push confirmation button (BS3). (The present setting is indicated,)	Either of ③				
		③ Push operation button (BS2) and adjust 7 segment display to required mode shown in right. (*2) Setting level efficiency	For ⒶⒷ ⒻⒼⒽ	ON	light off	light off	1
			OFF (Factory setting)	light off	light off	0	
		For Ⓒ (*2)	OFF (Factory setting)	light off	light off	0	
			Level A (*3) (*3) A is a number of 1~3	light off	light off	A(*3)	
		For Ⓓ (*2)	Level A (*3) (*3) A is a number of 1~3 (Factory setting:2)	light off	light off	A(*3)	
		For Ⓔ (*2)	Level B (*4) (*4) B is number of 1~8 (Factory setting:3)	light off	light off	B(*4)	
	④ Push confirmation button (BS3).	The setting in ③ is defined.			It will turn to light ON.		
	⑤ Push confirmation button again (BS3).	The system start the operation according to the setting.			2	0	0
	⑥ Push new page button (BS1).	The system return to normal mode.			light off	light off	light off
Confirmation procedure	① Push operation button (BS2) according to confirmation item (Ⓒ, Ⓓ) and adjust 7 segment display to the example shown in right according to the required mode.	Ⓒ Low noise operation	1	0	1		
		Ⓓ Demand operation	1	0	2		
	② Push confirmation button (BS3). (The present setting will be indicated,)	During setting operation	light off	light off	1		
		During normal operation	light off	light off	0		

(*5) Set Ⓗ in case of operating cooling mode in the outdoor temperature 23° (F5°C) or below. This setting is not applicable to BS unit (multi type).

Additional refrigerant charge operation

●When the outdoor unit is stopped and the entire quantity of refrigerant cannot be charged, make sure to charge the remaining quantity of refrigerant using this procedure. If the refrigerant quantity is insufficient, the unit may malfunction.

Setting procedure

- ① Connect the refrigerant charge hose and valve to the stop valve service port on the suction gas side.
- ② Make sure to completely open the stop valve on the suction gas side, the high/low pressure gas side and the liquid side.
- ③ Turn ON the power of the indoor units, BS unit and the outdoor unit. To protect the compressor, make sure to turn on the power supply for 6 hours before starting operation.

- ④ In the state of unit stopped, turn on the additional refrigerant charge operation by [Setting mode], and open refrigerant cylinder valve. About valve pulse, make sure to adjust refrigerant charging speed as 2.2 lb/minute. The operation is automatically started, 7 segment display will be changed as shown in right(up) and "Test operation" and "Under centralized control" are displayed in the remote controller. Low pressure indication may display on 7 segment display (as shown in right(down)), however, operation can be carried out continuously.

Test operation •
Under centralized control
7 segment display

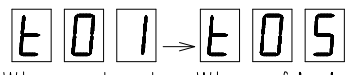

When start When finish

Example 7 Segment
display

0.17MPa ⇒ 

- ⑤ After charging the specified quantity of refrigerant, close refrigerant cylinder valve, push confirmation button (BS3).
 - The operation will be stopped. The operation is automatically stopped within 30 minutes. If charging is not completed, set and perform the additional refrigerant charging operation again.
 - If the additional refrigerant charging operation is stopped soon, the refrigerant may be overcharged. Stop additional charging and make sure to confirm charged amount again.

Check operation method

! Make sure to open the suction gas side, the high/low pressure gas side and the liquid side stop valve before starting operation.

- For multi system, make sure to confirm setting and result indication by master unit.
- Make sure to carry out the check operation after the first installation. Otherwise, the malfunction code "U3" will be displayed in the remote controller and normal operation cannot be carried.
- The check operation is automatically carried out in a cooling mode. The 7 segment will be indicated as shown in right, and "Test operation" and "Under centralized control" will be displayed in the remote controller.
- During the check operation, it is impossible to stop the unit from the remote controller. When discontinue the operation, push confirmation button (BS3). The system will stop after behind operation for 30 seconds.
- It may takes 5 minutes to bring the state of refrigerant uniform before the compressor starts. Moreover, during the check operation, the refrigerant running sound, or the magnetic sound of a solenoid valve may become loud during operation, but these are not malfunctions.
- The abnormality of each indoor unit and BS unit cannot be checked. After the check operation is finished, check the indoor units individually by normal operation using the remote controller.

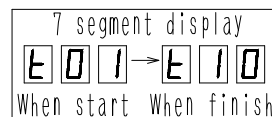

【Operation procedure】

- ① To protect the compressor, make sure to turn on the power supply for 6 hours before starting operation. (After turning on the power supply, the unit cannot start the operation until 7 segment display goes off (maximum 12 minutes).) In the state of unit stopped, set to **Normal mode**.
- ② Push operation button (BS2) for 5 seconds or more. (Then the unit will start the check operation.)
- ③ Close the front panel. (Otherwise, it may cause a wrong judgment.)
- ④ When the checks are completed (unit run for about 40 minutes), the system will stop automatically.
- ⑤ Check the operation results by the outdoor unit 7 segment display. (See the table shown in right.)

Result	7 Segment display
Normally finished	Light off
Abnormally finished	Malfunction code

! Push new page button (BS1) in case taking a wrong operation, then follow procedure since ② again.

【Measure when abnormally finished】

- ① Confirm the malfunction code by the remote controller and 7 segment display, and correct the abnormality. (For how to correct abnormality and correction method, see the installation manual, operation manual and service manual.)
- ② After correcting the abnormality, push confirmation button (BS3) and reset the malfunction code.
- ③ Carry out the check operation again and confirm that the abnormality is properly corrected.

Service mode operation method

- After turning on the power supply, the unit cannot start until 7 segment display goes off for maximum 12 minutes.
- Do not turn off the power and do not reset **Setting mode** when evacuating or recovering the refrigerant. (The expansion valves will close and the system cannot be evacuated or recovered the refrigerant.)

【Evacuation method】 (At the first installation this evacuation is not required. It is only required for service.)

- ① In the state of unit stopped and under **Setting mode**, set the **(B)** refrigerant recovery / evacuation mode. (※)
- ② Evacuate the system with a vacuum pump.
- ③ Push confirmation button (BS3) after finish evacuation and reset the evacuation mode.
- ④ Push new page button (BS1) and reset **Setting mode**.

【Refrigerant recovery operation method】 (Make sure to use a refrigerant reclaimer.)

- ① In the state of unit stopped and under **Setting mode**, set the **(B)** refrigerant recovery / evacuation mode. (※)
- ② Recover the refrigerant by a refrigerant reclaimer.
(For details, see the manual attached in refrigerant reclaimer.)
- ③ After completed, push confirmation button (BS3) and reset the refrigerant recovery mode.
- ④ Push new page button (BS1) and reset **Setting mode**.

(※) The expansion valves in the indoor and outdoor units will be opened completely, 7 segment display will be changed as shown in below and "Test operation" and "Under centralized control" will be displayed in the remote controller. The operation will be rejected.

7 Segment display **E 0 1**

R410A

For those who install or move the unit

1. When lifting the unit

- To hang the unit, use 2 slings of at least 27 ft. long. Put the belt slings into the product openings of foundation legs.
- Put cushioning plates of rags where the slings contact the casing in order to prevent the casing from being damaged.

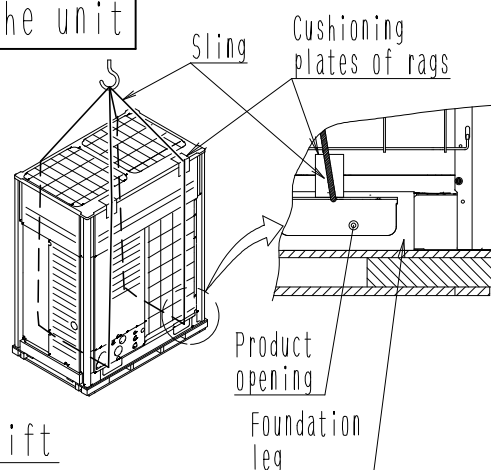

2. When carrying the unit by forklift

- If a forklift is used for carrying the unit, put the fork into wood pallet openings by let the tip out of the opposite side sufficiently.

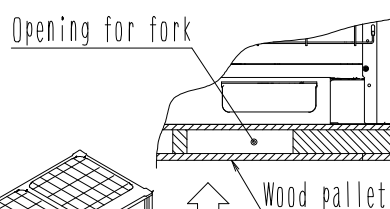

3. Electrical work

- To prevent electric shock and fire accident, be sure to perform grounding and install an earth leak breaker.
- Electrical work must be carried out by a licensed electrician in accordance with local and national regulations.
- Confirm the insulation of main power supply circuit before opening the stop valve. If stop valve remains open without turn on the power supply, insulation resistance may decline due to refrigerant accumulating in compressor.

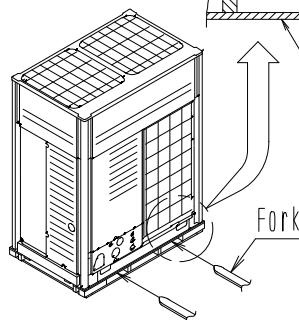

For those who carry out service and maintenance

⚠ WARNING

⚡ Caution for electric shock

- Beware of the fan rotating while inspection.
- Do not touch the energized parts while inspection.

<Front panel (Middle) removing method>

- Pull the front panel (middle) forward to take a hanging lug (bottom) off (①). Remove the panel downward (②).

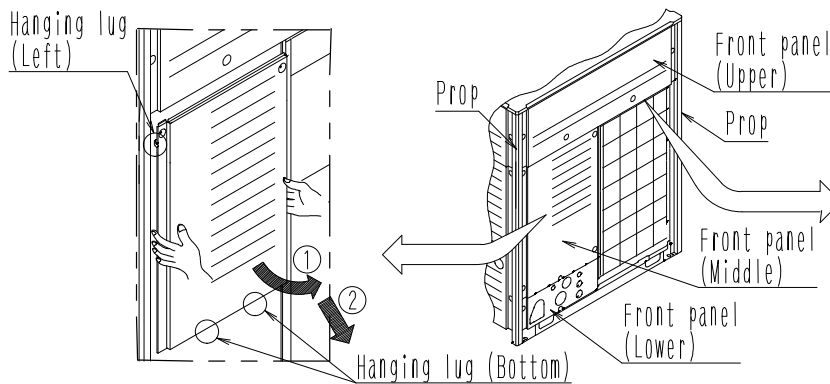

<Front panel (Upper) removing method>

- Lift up the panel a little and take a hanging lug off (①). Remove the panel forward (②).

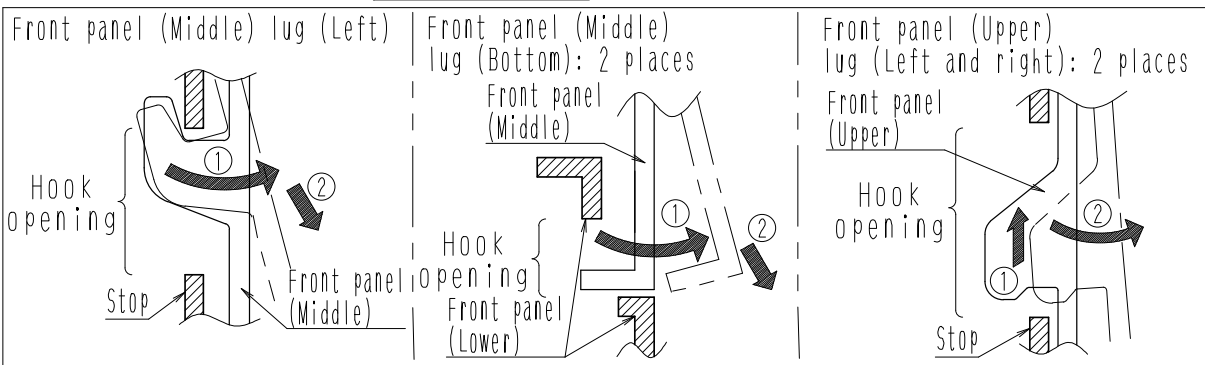
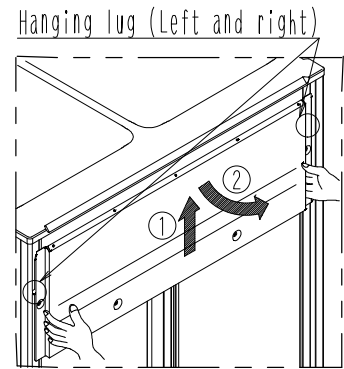

- For the location of the control box and the service ports, see below.

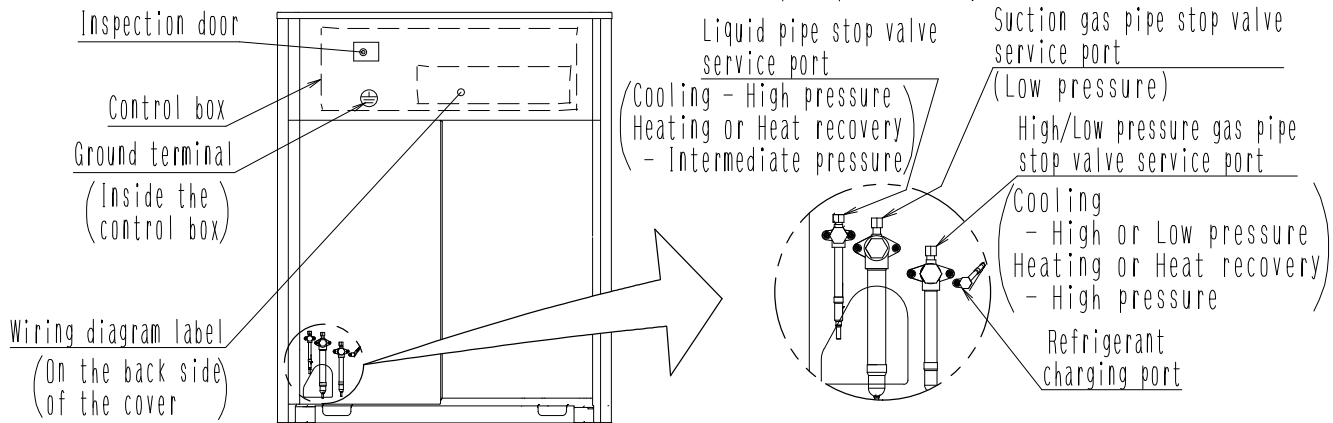

Appendix 1. Installation Manual RELQ-TATJU / RELQ-TAYDU / RELQ-TAYCU

1. Installation Manual i

1. Installation Manual

Safety considerations

Read these Safety considerations for Installation carefully before installing an air conditioner or heat pump. After completing the installation, make sure that the unit operates properly during the startup operation.

Instruct the customer on how to operate and maintain the unit.

Inform customers that they should store this Installation Manual with the Operation Manual for future reference.

Always use a licensed installer or contractor to install this product.

Improper installation can result in water or refrigerant leakage, electrical shock, fire, or explosion.

Meanings of **DANGER**, **WARNING**, **CAUTION**, and **NOTE** Symbols:

 **DANGER** Indicates an imminently hazardous situation which, if not avoided, will result in death or serious injury.

 **WARNING** Indicates a potentially hazardous situation which, if not avoided, could result in death or serious injury.

 **CAUTION** Indicates a potentially hazardous situation which, if not avoided, may result in minor or moderate injury. It may also be used to alert against unsafe practices.

 **NOTE** Indicates situations that may result in equipment or property-damage accidents only.

 **INFORMATION** . . . This symbol identifies useful tips or additional information.

DANGER

- Refrigerant gas is heavier than air and replaces oxygen. A massive leak will result in oxygen depletion, especially in basements, and an asphyxiation hazard will result in serious injury or death.
 - Do not ground units to water pipes, gas pipes, telephone wires, or lightning rods as incomplete grounding will result a severe shock hazard resulting in severe injury or death. Additionally, grounding to gas pipes will result a gas leak and potential explosion resulting in severe injury or death.
 - If refrigerant gas leaks during installation, ventilate the area immediately. Refrigerant gas will result in producing toxic gas if it comes into contact with fire. Exposure to this gas will result in severe injury or death.
 - After completing the installation work, check that the refrigerant gas does not leak throughout the system.
 - Do not install unit in an area where flammable materials are present due to risk of explosions that will result in serious injury or death.
 - Safely dispose all packing and transportation materials in accordance with federal/state/local laws or ordinances. Packing materials such as nails and other metal or wood parts, including plastic packing materials used for transportation will result in injuries or death by suffocation.
-

WARNING

- Only qualified personnel must carry out the installation work. Installation must be done in accordance with this installation manual. Improper installation could result in water leakage, electric shock, or fire.
 - When installing the unit in a small room, take measures to keep the refrigerant concentration from exceeding allowable safety limits. Excessive refrigerant leaks, in the event of an accident in a closed ambient space, could result in oxygen deficiency.
 - Use only specified accessories and parts for installation work. Failure to use specified parts could result in water leakage, electric shocks, fire, or the unit falling.
 - Install the air conditioner or heat pump on a foundation strong enough that it can withstand the weight of the unit. A foundation of insufficient strength could result in the unit falling and causing injuries.
 - Take into account strong winds, typhoons, or earthquakes when installing. Improper installation could result in the unit falling and causing accidents.
 - Make sure that a separate power supply circuit is provided for this unit and that all electrical work is carried out by qualified personnel according to local, state and national regulations. An insufficient power supply capacity or improper electrical construction could result in electric shocks or fire.
 - Make sure that all wiring is secured, that specified wires are used, and that no external forces act on the terminal connections or wires. Improper connections or installation could result in fire.
 - When wiring, position the wires so that the control box cover can be securely fastened. Improper positioning of the control box cover could result in electric shocks, fire, or the terminals overheating.
 - Before touching electrical parts, turn off the unit.
 - This equipment can be installed with a Ground-Fault Circuit Interrupter (GFCI). Although this is a recognized measure for additional protection, with the grounding system in North America, a dedicated GFCI is not necessary.
 - Securely fasten the unit terminal cover (panel). If the terminal cover/panel is not installed properly, dust or water may enter the outdoor unit and could result in fire or electric shock.
 - When installing or relocating the system, keep the refrigerant circuit free from substances other than the specified refrigerant (R410A) such as air. Any presence of air or other foreign substance in the refrigerant circuit could result in abnormal pressure rise or rupture, resulting in injury.
 - Do not change the setting of the protection devices. If the pressure switch, thermal switch, or other protection device is shorted and operated forcibly, or parts other than those specified by Daikin are used, fire or explosion could result.
-

⚠ CAUTION

- Do not touch the switch with wet fingers. Touching a switch with wet fingers may result in electric shock.
- Do not allow children to play on or around the unit or it may result in injury.
- The heat exchanger fins are sharp enough to cut, and may result in injury if improperly used. To avoid injury wear glove or cover the fins when working around them.
- Do not touch the refrigerant pipes during and immediately after operation as the refrigerant pipes may be hot or cold, depending on the condition of the refrigerant flowing through the refrigerant piping, compressor, and other refrigerant cycle parts. It may result in your hands getting burns or frostbite if you touch the refrigerant pipes. To avoid injury, give the pipes time to return to normal temperature or, if you must touch them, be sure to wear proper gloves.
- Install drain piping to proper drainage. Improper drain piping may result in water leakage and property damage.
- Insulate piping to prevent condensation.
- Be careful when transporting the product.
- Do not turn off the power immediately after stopping operation. Always wait for at least 5 minutes before turning off the power. Otherwise, water leakage may result.
- Do not use a charging cylinder. Using a charging cylinder may cause the refrigerant to deteriorate.
- Refrigerant R410A in the system must be kept clean, dry, and tight.
 - (a) Clean and Dry - Foreign materials (including mineral oils such as SUNISO oil or moisture) should be prevented from getting into the system.
 - (b) Tight - R410A does not contain any chlorine, does not destroy the ozone layer, and does not reduce the earth's protection against harmful ultraviolet radiation. R410A can contribute to the greenhouse effect if it is released. Therefore take proper measures to check for the tightness of the refrigerant piping installation. Read the chapter Refrigerant Piping and follow the procedures.
- Since R410A is a blend, the required additional refrigerant must be charged in its liquid state. If the refrigerant is charged in a state of gas, its composition can change and the system will not work properly.
- The indoor unit is for R410A. See the catalog for indoor models that can be connected. Normal operation is not possible when connected to other units.
- Remote controller (wireless kit) transmitting distance can be shorter than expected in rooms with electronic fluorescent lamps (inverter or rapid start types). Install the indoor unit far away from fluorescent lamps as much as possible.
- Indoor units are for indoor installation only. Outdoor units can be installed either outdoors or indoors. This unit is for indoor use.
- Do not install the air conditioner or heat pump in the following locations:
 - (a) Where a mineral oil mist or oil spray or vapor is produced, for example, in a kitchen.
Plastic parts may deteriorate and fall off and thus may result in water leakage.
 - (b) Where corrosive gas, such as sulfuric acid gas, is produced.
Corroding copper pipes or soldered parts may result in refrigerant leakage.

- (c) Near machinery emitting electromagnetic waves.
Electromagnetic waves may disturb the operation of the control system and cause the unit to malfunction.
 - (d) Where flammable gas may leak, where there is carbon fiber, or ignitable dust suspension in the air, or where volatile flammables such as thinner or gasoline are handled. Operating the unit in such conditions may result in a fire.
- Take adequate measures to prevent the outdoor unit from being used as a shelter by small animals. Small animals making contact with electrical parts may result in malfunctions, smoke, or fire. Instruct the customer to keep the area around the unit clean.
-

⚠ NOTE

- Install the power supply and transmission wires for the indoor and outdoor units at least 3.5 ft. (1 m) away from televisions or radios to prevent image interference or noise. Depending on the radio waves, a distance of 3.5 ft. (1 m) may not be sufficient to eliminate the noise.
 - Dismantling the unit, treatment of the refrigerant, oil and additional parts must be done in accordance with the relevant local, state, and national regulations.
 - Do not use the following tools that are used with conventional refrigerants: gauge manifold, charge hose, gas leak detector, reverse flow check valve, refrigerant charge base, vacuum gauge, or refrigerant recovery equipment.
 - If the conventional refrigerant and refrigerator oil are mixed in R410A, the refrigerant result in deterioration.
 - This air conditioner or heat pump is an appliance that should not be accessible to the general public.
 - As design pressure is 478 psi (3.3 MPa), the wall thickness of field-installed pipes should be selected in accordance with the relevant local, state, and national regulations.
-

Codes and Regulations

This product is designed and manufactured to comply with national codes. Installation in accordance with such codes and/or prevailing local codes/regulations is the responsibility of the installer. The manufacturer assumes no responsibility for equipment installed in violation of any codes or regulations. Rated performance is achieved after 72 hours of operation.

Make sure to use a DAIKIN specified checker while measuring sub cooling. Do not use the check valve or the other port to measure it.



RELQ72TATJU	RELQ72TAYDU	RELQ72TAYCU
RELQ96TATJU	RELQ96TAYDU	RELQ96TAYCU
RELQ120TATJU	RELQ120TAYDU	RELQ120TAYCU
RELQ144TATJU	RELQ144TAYDU	RELQ144TAYCU
RELQ192TATJU	RELQ192TAYDU	RELQ192TAYCU
RELQ240TATJU	RELQ240TAYDU	RELQ240TAYCU

VRV Aurora Series System air conditioner
Installation Manual

CONTENTS

Safety considerations	i		
Codes and Regulations.....	ii		
1. Introduction	2		
1.1. General information.....	2		
1.2. Combinations and options.....	2		
1.3. Indoor capacity range.....	3		
1.4. Scope of the manual	3		
2. Accessories	3		
2.1. Accessories supplied with this unit.....	3		
3. Overview of unit	4		
3.1. Opening the unit.....	4		
3.2. Technical and Electrical specifications	4		
3.3. Main components.....	4		
4. Selecting an installation location	4		
4.1. General precautions on installation.....	4		
4.2. Weather related precautions	5		
4.3. Selecting a location in cold climates	5		
5. Dimensions and service space	6		
5.1. Dimensions of outdoor unit	6		
5.2. Service space.....	6		
6. Inspecting, handling and unpacking the unit	7		
6.1. Inspection.....	7		
6.2. Handling.....	7		
6.3. Unpacking	7		
6.4. Installing the unit	8		
6.5. Method for removing shipping plates	8		
7. Refrigerant pipe size and allowable pipe length	9		
7.1. General information.....	9		
7.2. Selection of piping material	9		
7.3. Selection of piping size	9		
7.4. Selection of refrigerant branch kits.....	10		
7.5. System piping (length) limitations	11		
8. Precautions on refrigerant piping.....	14		
8.1. Caution for brazing	14		
8.2. Connecting the refrigerant piping	14		
8.3. Guidelines for handling stop valve.....	17		
9. Field wiring	18		
9.1. Power circuit, safety device and cable requirements	19		
9.2. Wiring connection example for whole system.....	19		
9.3. Leading wire procedure.....	19		
9.4. Transmission wiring connection procedure	20		
9.5. Power wiring connection procedure	21		
9.6. Procedure for Wiring Inside Units.....	21		
10. Air tight test and vacuum drying	22		
11. Pipe insulation	23		
12. Checking of device and installation conditions	24		
13. Making field settings	24		
13.1. Accessing the push buttons on the printed circuit board.....	24		
13.2. Operating the push buttons and DIP switches on the printed circuit board.....	24		
13.3. Connecting the PC configurator to the outdoor unit	26		
14. Charging refrigerant.....	26		
14.1. Precautions	26		
14.2. Calculating the additional refrigerant charge	26		
14.3. Method for adding refrigerant.....	28		
15. Start-up and configuration	30		
15.1. Checks before initial start up.....	30		
15.2. Monitoring function and field settings....	31		
15.3. Energy saving and optimum operation...	37		
15.4. Test operation.....	39		
15.5. Malfunction code list.....	40		
16. Operation of the unit	43		
17. Maintenance and service	43		
17.1. Maintenance introduction	43		
17.2. Service precautions.....	43		
17.3. Service mode operation	45		
18. Caution for refrigerant leaks	45		
18.1. Introduction	45		
19. Disposal requirements.....	45		

The original instructions are written in English. All other languages are translations of the original instructions.

1. Introduction

1.1. General information

This installation manual concerns the VRV Aurora series, full inverter driven, heat pump system.

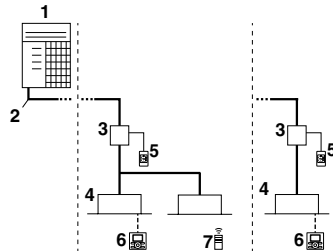

- 1 Outdoor unit
- 2 Refrigerant piping
- 3 Branch Selector unit
- 4 VRV indoor unit
- 5 Cool/Heat selector (single Branch Selector unit only)
- 6 User interface (dedicated depending on indoor unit type)
- 7 User interface (wireless, dedicated depending on indoor unit type)

I INFORMATION

Not all combinations of indoor units are allowed. For guidance, see 1.2. Combinations and options.

1.2. Combinations and options

The VRV Aurora series heat recovery system can be combined with several types of indoor units and is intended for R410A use only.

For an overview which units are available you can consult the product catalogue for VRV Aurora series.

A NOTE

To be sure your system setup (outdoor unit + Branch Selector unit(s) + indoor unit(s)) will work, you have to consult the latest technical engineering data for VRV Aurora series.

An overview is given indicating the allowed combinations of indoor units and outdoor units. Not all combinations are allowed. They are subject to rules (combination between outdoor-indoor, single outdoor unit use, multiple outdoor units use, combinations between indoor units, etc.) mentioned in the technical engineering data.

The Branch Selector units that combined with RELQ-T units for changing the refrigerant flow to indoor units are T type (BSQ-TVJ, BS-Q54TVJ) only. Do not combine the T type and P type (BSVQ-PVJU, BSV-Q36PVJU) in the system. Combination of T type and P type cause malfunction.

1.2.1. Indoor units combinations

In general VRV indoor units can be connected to RELQ-T units.

1.2.2. Outdoor units combinations

Aurora Series combination for RELQ-T units are as indicated in tables below (and right), where RELQ 144-240 consists of multiple RELQ 72-120 single modules as indicated.

	72	96	120
RELQ72TATJU/TAYDU/TAYCU	1		
RELQ96TATJU/TAYDU/TAYCU		1	
RELQ120TATJU/TAYDU/TAYCU			1
RELQ144TATJU/TAYDU/TAYCU	2		
RELQ192TATJU/TAYDU/TAYCU		2	
RELQ240TATJU/TAYDU/TAYCU			2

To install the outdoor unit, the following accessory parts are also required.

1 Refrigerant branch kit.

Description	Model name	
	(for 3 pipes)	(for 2 pipes)
REFNET header	KHRP25M33H9	KHRP26M22H9
	KHRP25M72H9	KHRP26M33H9
	KHRP25M73HU9	KHRP26M72H9
REFNET joint	KHRP25A22T9	KHRP26A22T9
	KHRP25A33T9	KHRP26A33T9
	KHRP25M72TU9	KHRP26M72TU9
	KHRP25M73TU9	—

For the selection of the optimal branch kit, refer to 7.4. Selection of refrigerant branch kits on page 10.

2 Outdoor unit multi connection piping kit.

Number of outdoor units connected
2
BHFP26P100U

3 In order to control the cooling or heating operation from a central location, the following option can be connected:

- Cool/Heat selector: KRC19-26A
- With optional fixing box for the switch: KJB111A
- Centralized control devices (e.g., intelligent Touch Manager)

4 To instruct specific operation with an external input coming from a central control the external control adaptor (DTA104A61/62) can be used. Instructions (group or individual) can be instructed for low noise operation and power consumption limitation operation.

5 For RELQ-T units it is also possible to make several commissioning field settings through a personal computer interface. For this option 999482P3 is required which is a dedicated cable to communicate with the outdoor unit. The software for the user interface program can be obtained from your local Daikin sales office.

I INFORMATION

Refer to the technical engineering data for the latest option names.

1.3. Indoor capacity range

1.3.1. Connection Ratio

Connection Ratio = Total capacity index of the indoor units / Capacity index of the outdoor units

Type	Min. connection ratio
	Types of connected outdoor units
	RELQ-T type
Single outdoor units	70%
Double outdoor units	

Type	Max. connection ratio		
	Types of connected indoor units		
	When using only FXDQ, FXMQ-PB, FXAQ	When using at least one FXZQ05TA, FXFQ07/09	When using other indoor unit models
Single outdoor units	200% (*1)	180% (*1)	200% (*1)
Double outdoor units		160% (*1)	160% (*1)

*1. If the operational capacity of indoor units is more than 130%, low airflow operation is enforced in all the indoor units.

1.3.2. Outdoor Unit Combinations

Total capacity of indoor units needs to be within the specified range.

RELQ-T type	<Outdoor unit>	<Total capacity index of indoor units>
	RELQ72TATJU/TAYDU/TAYCU	51-93
	RELQ96TATJU/TAYDU/TAYCU	68-124
	RELQ120TATJU/TAYDU/TAYCU	84-156
	RELQ144TATJU/TAYDU/TAYCU	101-187
	RELQ192TATJU/TAYDU/TAYCU	135-249
	RELQ240TATJU/TAYDU/TAYCU	168-312

NOTE
Higher capacity than the above table can be selected, this may affect heating and cooling capacity. For additional information see technical engineering data.

1.4. Scope of the manual

This manual describes the procedures for handling, installing and connecting the VRV Aurora series outdoor units. This manual has been prepared to ensure adequate maintenance of the unit, and it will provide help in case problems occur.

INFORMATION
The installation of the indoor unit(s) is described in the indoor unit installation manual provided with the indoor unit(s).

2. Accessories

2.1. Accessories supplied with this unit

Confirm the following accessories are included. The storage location of the accessories is shown in the figure below.

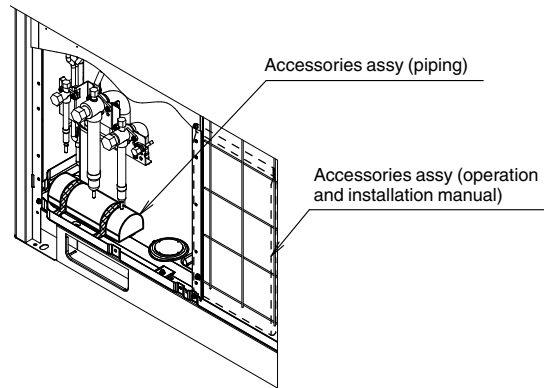

NOTE
Do not throw away any of the accessories until installation is complete. They are needed for installation work.

Name	Clamp (1)	Clamp (2)	Clamp (3)	Vinyl tube	Manuals, etc.
Quantity	7 pcs.	1 pc.	1 pc.	5 pcs.	1 pc. each
Shape	(Small)	(Large)			<ul style="list-style-type: none"> Operation Manual Installation Manual REQUEST FOR THE INDICATION label (Installation records)

Name	Liquid side accessory pipe (1)	Liquid side accessory pipe (2)	Gas side accessory pipe (1)	Gas side accessory pipe (2)
Quantity	1 pc.	1 pc.	1 pc.	1 pc.
Shape		72-120T	72,96T 120T	72,96T 120T

Name	High and low gas side accessory pipe (1)	High and low gas side accessory pipe (2)	L type accessory joint
Quantity	1 pc.	1 pc.	2 pcs.
Shape	72T 96-120T	72-120T	

3. Overview of unit

3.1. Opening the unit

To gain access to the unit, front panels need to be opened as follows:

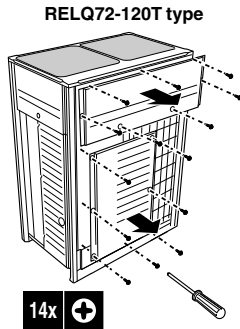

Once the front panel open, the control box can be accessed by removing the control box cover as follows.

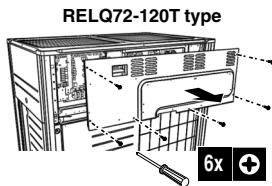

For service purposes, the push buttons on the main printed circuit board need to be accessed. To access these push buttons, the control box cover does not need to be opened. See 13. Making field settings on page 24.

⚠ DANGER: ELECTRICAL SHOCK
See Safety considerations on page i.

⚠ DANGER: DO NOT TOUCH PIPING AND INTERNAL PARTS
See Safety considerations on page i.

3.2. Technical and Electrical specifications

Refer to the Engineering Data Book for the complete list of specifications.

3.3. Main components

For main components and function of the main components, refer to the Engineering Data Book.

4. Selecting an installation location

⚠ WARNING

Be sure to provide for adequate measures in order to prevent that the unit is used as a shelter by small animals. Small animals making contact with electrical parts can cause malfunctions, smoke or fire. Please instruct the customer to keep the area around the unit clean and clear.

In a domestic environment this product may cause radio interference in which case the user may be required to take adequate measures.

⚠ CAUTION

Appliance not accessible to the general public, install it in a secured area, protected from easy access. This unit, both indoor and outdoor, is suitable for installation in a commercial and light industrial environment.

4.1. General precautions on installation

Select an installation site that meets the following requirements:

- The foundation must be strong enough to support the weight of the unit.
- Installation location is flat to prevent vibrations and noise generation and to have sufficient stability.
- The space around the unit is adequate for maintenance and servicing (refer to 5.2. Service space on page 6).
- The space around the unit allows for sufficient air circulation.
- There is no danger of fire due to leakage of inflammable gas.
- The equipment is not intended for use in a potentially explosive atmosphere.
- Select the location of the unit in such a way that the sound generated by the unit does not disturb anyone, and the location is selected according to the applicable legislation.
- All piping lengths and distances have been taken into consideration (refer to 7.5. System piping (length) limitations on page 11).
- Take care that in the event of a water leak, water cannot cause any damage to the installation space and surroundings.
- When installing the unit in a small room, take measures in order to keep the refrigerant concentration from exceeding allowable safety limits in the event of a refrigerant leak, refer to 18. Caution for refrigerant leaks on page 45.

⚠ CAUTION

Excessive refrigerant concentrations in a closed room can lead to oxygen deficiency.

⚠ NOTE

The equipment described in this manual may cause electronic noise generated from radio-frequency energy. The equipment complies to specifications that are designed to provide reasonable protection against such interference. However, there is no guarantee that interference will not occur in a particular installation.

It is therefore recommended to install the equipment and electric wires keeping proper distances away from stereo equipment, personal computers, etc

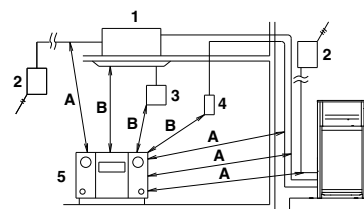

- 1 Indoor unit
- 2 Branch switch, overcurrent breaker
- 3 Remote controller
- 4 Cool/Heat selector
- 5 Personal computer or radio
- A ≥ 60 in. (1500 mm)
- B ≥ 40 in. (1000 mm)

An inverter air conditioner may cause electronic noise generated from AM broadcasting. Examine where to install the main air conditioner and electric wires, keeping proper distances away from stereo equipment, personal computers, etc.

Particularly for locations with weak reception, ensure there is a distance of at least 10 ft. (3 m) for indoor remote controllers, place power wiring and transmission wiring in conduits, and ground the conduits.

- The refrigerant R410A itself is nontoxic, non-flammable and is safe. If the refrigerant should leak however, its concentration may exceed the allowable limit depending on room size. Due to this, it could be necessary to take measures against leakage. Refer to 18. Caution for refrigerant leaks on page 45.
- Do not install in the following locations:
 - Locations where sulfurous acids and other corrosive gases may be present in the atmosphere. Copper piping and soldered joints may corrode, causing refrigerant to leak.
 - Locations where a mineral oil mist, spray or vapor may be present in the atmosphere. Plastic parts may deteriorate and fall off or cause water leakage.
 - Locations where equipment that produces electromagnetic waves is found. The electromagnetic waves may cause the control system to malfunction, preventing normal operation.
 - Locations where flammable gases may leak, where thinner, gasoline and other volatile substances are handled, or where carbon dust and other incendiary substances are found in the atmosphere. Leaked gas may accumulate around the unit, causing an explosion.
- When installing, take strong winds, hurricanes or earthquakes into account, improper installation may result in the unit turning over.

4.2. Weather related precautions

- Be sure that the air inlet of the unit is not positioned towards the main wind direction. Frontal wind will disturb the operation of the unit. If necessary, use a screen to block the wind.
- Ensure that water cannot cause any damage to the location by adding water drains to the foundation and prevent water traps in the construction.
- When installing in areas where air contains high levels of salt such as near the ocean; Contact your Daikin sales representative for additional precautions.

4.3. Selecting a location in cold climates

-
- NOTE**
- When operating the unit in a low outdoor ambient temperature, be sure to follow the instructions described below.
 - The following images are for reference only. For more details contact your local dealer.
-

To prevent exposure to wind and snow, install a baffle plates on the air side of the outdoor unit (see 5.2. Service space for space requirement):

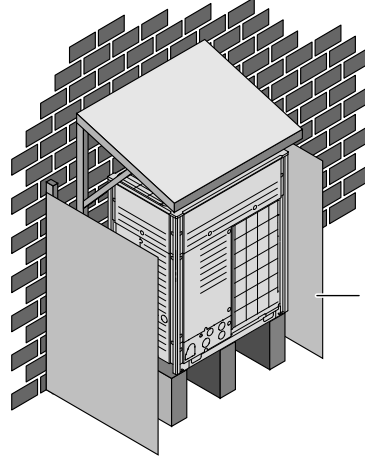

1 Baffle plates

In heavy snowfall areas it is very important to select an installation site where the snow will not affect the unit. Additionally, installation of a snow guard is recommended. When installing the unit in a location where there is heavy snowfall, remove the coil guards to prevent snow from accumulating on the fins.

If lateral snowfall is possible, make sure that the heat exchanger coil is not affected by the snow (if necessary construct a lateral canopy). Install the outdoor unit so that the bottom frame is at least 19-11/16 in. (500 mm) above predicted snowfall levels.

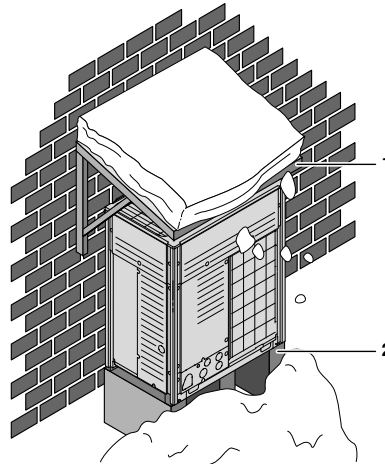

1 Construct a large canopy.
2 Construct a pedestal.

-
- NOTE**
- When operating the unit in a low outdoor ambient temperature with high humidity conditions, make sure to take precautions to keep the drainholes of the unit free.
-

5. Dimensions and service space

5.1. Dimensions of outdoor unit

RELQ72-120T type

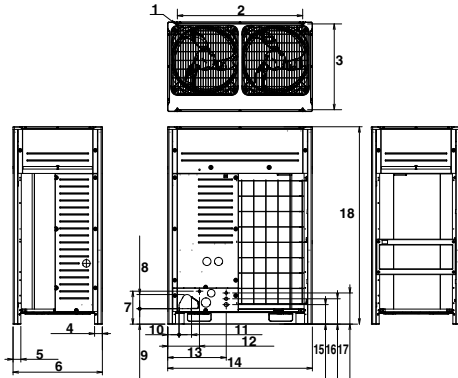

Unit: in. (mm)

RELQ72-120T type	
1	Foundation bolt holes 9/16 (15) × 7/8 (22.5) oblong holes × 4
2	Pitch of foundation bolt holes 42-3/8 (1076)
3	Pitch of foundation bolt holes 28-7/16 to 29 (722 to 737)
4	2-5/8 (67)
5	2-5/8 (67)
6	30-3/16 (767)
7	11-1/8 (282)
8	4-13/16 (122)
9	5-3/16 (132)
10	3-7/8 (98)
11	4-3/16 (107)
12	10-11/16 (272)
13	19-3/4 (502)
14	48-7/8 (1242)
15	6-9/16 (167)
16	8-9/16 (217)
17	10-1/2 (267)
18	66-11/16 (1694)

5.2. Service space

The space around the unit is adequate for servicing and the minimum space for air inlet and air outlet is available (refer to the figure below and choose one of the possibilities).

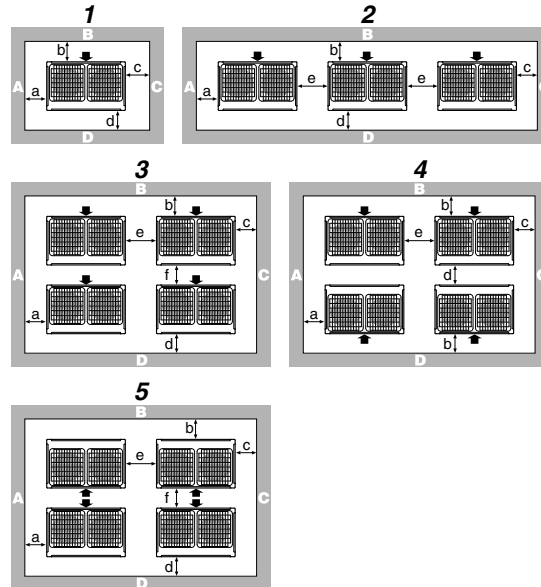

ABCD Sides along the installation site with obstacles
 ↘ Suction side

	A+B+C+D		A+B
1	a≥3/8 (10)	a≥2 (50)	a≥7-7/8 (200)
	b≥11-3/4 (300)	b≥3-7/8 (100)	b≥11-3/4 (300)
2	c≥3/8 (10)	c≥2 (50)	
	d≥19-5/8 (500)	d≥19-5/8 (500)	e≥15-3/4 (400)
3	e≥3/4 (20)	e≥3-7/8 (100)	
	f≥23-5/8 (600)	f≥19-5/8 (500)	
4	a≥3/8 (10)	a≥2 (50)	
	b≥11-3/4 (300)	b≥3-7/8 (100)	
5	c≥3/8 (10)	c≥2 (50)	
	d≥19-5/8 (500)	d≥19-5/8 (500)	

Unit: in.(mm)

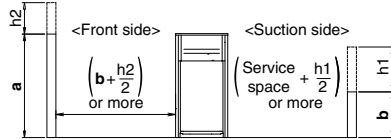

- a 59 in. (1500 mm)
- b 19-5/8 in. (500 mm)

- In case of an installation site where sides A+B+C+D have obstacles, the wall heights of sides A+C have no impact on service space dimensions. Refer to the foregoing figure for impact of wall heights of sides B+D on service space dimensions.
- In case of an installation site where only the sides A+B have obstacles, the wall heights have no influence on any indicated service space dimensions.

i INFORMATION

- Please secure enough space in front of the outdoor unit for on-site installation of the refrigerant piping.
- The service space dimensions in above figure are based on cooling operation at 95°F (35°C) ambient temperature (standard conditions).
- If the design outdoor temperature exceeds 95°F (35°C) or the heat load exceeds maximum capacity in all the outdoor unit, take an even large space on the intake shown in figure in 5.2. Service space.
- If installing snow guard (field supply), please incorporate the dimensions of the snow guard into the unit's outer dimensions in order to calculate the necessary amount of space.
- In places with low winter temperatures that may freeze the waste water created by defrosting during heating operation, please leave enough space between the bottom frame of the outdoor unit and its base. (19-11/16 in. (500 mm) to 40 in. (1000 mm) of space is recommended.)

i INFORMATION

Further specifications can be found in the Engineering Data Book.

6. Inspecting, handling and unpacking the unit

6.1. Inspection

At delivery, the unit must be checked and any damage must be reported immediately to the carrier's claims agent.

6.2. Handling

- 1 When handling the unit, take into account the following:



Fragile, handle the unit with care.



Keep the unit upright in order to avoid compressor damage.

- 2 Choose beforehand the path along which the unit is to be brought in.

- 3 Bring the unit as close as possible to its final installation position in its original package to prevent damage during transport.

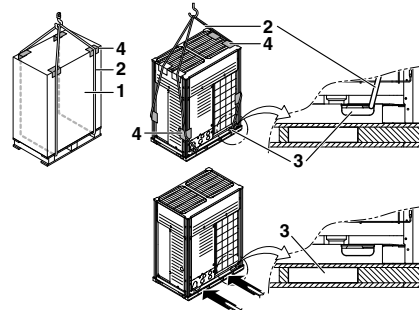

- 1 Packaging material
- 2 Belt sling
- 3 Opening
- 4 Protector

- 4 Lift the unit preferably with a crane and 2 belts of at least 27 ft. (8 m) long as shown in the figure above. Always use protectors to prevent belt damage and pay attention to the position of the unit's center of gravity.

! NOTE

Use a belt sling of $\leq 3/4$ in. (20 mm) wide that adequately bears the weight of the unit.

A forklift can only be used for transport as long as the unit remains on its pallet as shown above.

6.3. Unpacking

! CAUTION

To avoid injury, do not touch the air inlet or aluminum fins of the unit.

! WARNING

Tear apart and throw away plastic packaging bags so that children will not play with them. Children playing with plastic bags face danger of death by suffocation.

- 1 Remove the unit from its packing material. Take care not to damage the unit when unpacking.
- 2 Remove the 4 bolts fixing the unit to its pallet.
- 3 Make sure that all accessories as mentioned in 2.1. Accessories supplied with this unit on page 3 are available in the unit.

6.4. Installing the unit

Make sure the unit is installed level on a sufficiently strong base to prevent vibration and noise.

NOTE

When the installation height of the unit needs to be increased, do not use stands to only support the corners.

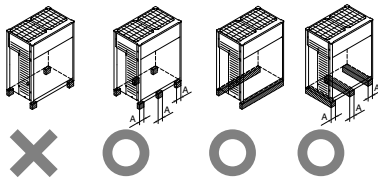

- A ≥3-7/8 in. (100 mm)
- X Not allowed
- O Allowed

- The height of the foundation must be at least 5-7/8 in. (150 mm) from the floor.
In heavy snowfall areas, this height should be increased, depending on the installation place and condition.
- The unit must be installed on a solid longitudinal foundation (steel beam frame or concrete) and make sure the base under the unit is larger than the gray marked area.

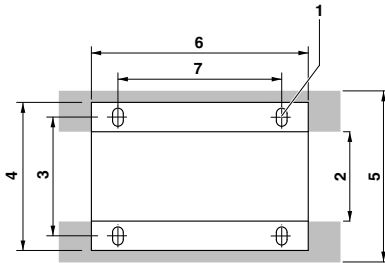

Dimensions for above figure	
1	Hole for foundation bolt $\phi 9/16$ in. (15 mm) dia: 4 positions
2	Inner dimension of the base 24-7/8 in. (631 mm)
3	Distance between foundation bolt holes 29 in. (729 mm)
4	Width of unit 30-3/16 in. (767 mm)
5	Outer dimension of the base $\geq 30-3/16$ in. (767 mm)
6	Longitudinal foundation dimension 48-7/8 in. (1242 mm)
7	Distance between foundation bolt holes 42-3/8 in. (1076 mm)

- Fasten the unit in place using 4 foundation bolts 7/16 in. (M12). It is best to screw in the foundation bolts until their length remains 13/16 in. (20 mm) above the foundation surface.

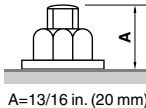

NOTE

- There are restrictions on the refrigerant pipe connecting order between outdoor units in the case of the multi system. See 1.2.2. Outdoor units combinations on page 2 for detail.
- When installing on a roof, make sure the roof floor is strong enough and be sure to waterproof all work.
- Make sure the area around the machine drains properly by setting up drainage grooves around the foundation.
- Drain water is sometimes discharged from the outdoor unit when it is running.
- For anti-corrosion type, use nuts with resin washers. If the paint on nut connections comes off, the anti-corrosion effect may decrease.

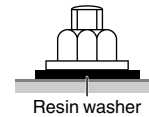

6.5. Method for removing shipping plates

The shipping plates installed over the compressor legs for protecting the unit during transport must be removed. Proceed as shown in the figure and procedure below. RELQ72T does not have the shipping plates.

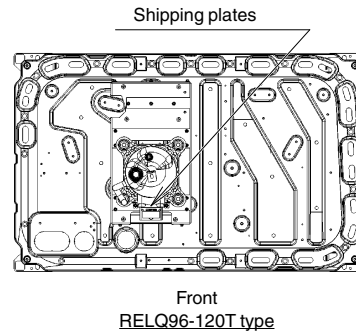

- 1 Remove bolts (2 pcs) for fixing shipping plate.
- 2 Remove all shipping plates (3 pcs).
- 3 Be sure to tighten the removed bolts back again.

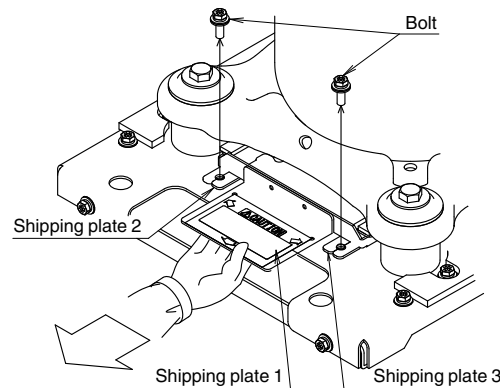

NOTE

If the unit is operated with the shipping plates still attached, abnormal vibration or noise may be generated.

7. Refrigerant pipe size and allowable pipe length

7.1. General information

- NOTE**
- The refrigerant R410A requires strict cautions for keeping the system clean, dry and tight.
- Clean and dry: foreign materials (including mineral oils or moisture) should be prevented from getting mixed into the system.
 - Tight: R410A does not contain any chlorine, does not destroy the ozone layer, and does not reduce earth's protection against harmful ultraviolet radiation. R410A can contribute slightly to the greenhouse effect if it is released. Therefore we should take special attention to check the tightness of the installation.

7.2. Selection of piping material

- NOTE**
- Piping and other pressure containing parts shall comply with the applicable legislation and shall be suitable for refrigerant. Use phosphoric acid deoxidized seamless copper for refrigerant.

- NOTE**
- All field piping must be installed by a licensed refrigeration technician and must comply with relevant local and national regulations.
 - After piping work is complete, do not under any circumstances open the stop valve until 9. Field wiring on page 18 and 12. Checking of device and installation conditions on page 24 are complete.
 - Do not use flux when brazing the refrigerant piping. Use the phosphor copper brazing filler metal (B-Cu93P-710/795 : ISO 3677) which does not require flux. Flux has extremely negative effect on refrigerant piping systems. For instance, if the chlorine based flux is used, it will cause pipe corrosion or, in particular, if the flux contains fluorine, it will damage the refrigerant oil.

- Use only pipes which are clean inside and outside and which do not accumulate harmful sulfur, oxidants, dirt, cutting oils, moisture, or other contamination. (Foreign materials inside pipes including oils for fabrication must be 0.14 gr/10 ft. (30 mg/10 m) or less.)
- Use the following items for the refrigerant piping.
 - Material** : Jointless phosphor-deoxidized copper pipe.
 - Size** : See 7.3. Selection of piping size to determine the correct size.
 - Thickness** : Select a thickness for the refrigerant piping which complies with national and local laws.
- For piping work, follow the maximum tolerated length, difference in height, and length after a branch indicated in the 7.5. System piping (length) limitations on page 11.
- Outdoor unit multi connection piping kit and refrigerant branch kit (sold separately) are needed for connection of piping between outdoor units (in case of multi system) and piping branches.
- Use only separately sold items selected specifically according to the outdoor unit multi connection piping kit, the refrigerant branch kit selection in the 7.4. Selection of refrigerant branch kits on page 10.

7.3. Selection of piping size

Determine the proper size referring to following tables and reference figure (only for indication).

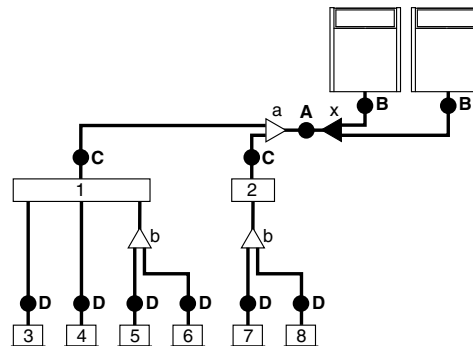

- 1 Multi Branch Selector unit
- 2 Single Branch Selector unit
- 3-8 VRV indoor units
- a, b Refrigerant branch kits
- x Outdoor unit multi connection piping kits

7.3.1. Piping between outdoor units and (first) refrigerant branch kit: A, B

Choose from the following table in accordance with the outdoor unit total capacity type, connected downstream.

Outdoor unit capacity type	Piping outer diameter size		
	Suction gas pipe	High/low pressure gas pipe	Liquid pipe
RELQ 72 T type	3/4 in. (19.1 mm)	5/8 in. (15.9 mm)	3/8 in. (9.5 mm)
RELQ 96 T type	7/8 in. (22.2 mm)	3/4 in. (19.1 mm)	
RELQ 120 T type	1-1/8 in. (28.6 mm)	7/8 in. (22.2 mm)	1/2 in. (12.7 mm)
RELQ 144 T type		1-3/8 in. (34.9 mm)	5/8 in. (15.9 mm)
RELQ 192 T type			
RELQ 240 T type			

7.3.2. Piping between refrigerant branch kits or refrigerant branch kits and Branch Selector units: C

Choose from the following table in accordance with the indoor unit total capacity, connected downstream. Do not let the connection piping exceed the refrigerant piping size chosen by the general system model name.

Indoor unit capacity index	Piping outer diameter size		
	Suction gas pipe	High/low pressure gas pipe	Liquid pipe
< 54	5/8 in. (15.9 mm)	1/2 in. (12.7 mm)	3/8 in. (9.5 mm)
54 ≤ x < 72	3/4 in. (19.1 mm)	5/8 in. (15.9 mm)	
72 ≤ x < 111	7/8 in. (22.2 mm)	3/4 in. (19.1 mm)	1/2 in. (12.7 mm)
111 ≤ x < 162	1-1/8 in. (28.6 mm)		1-1/8 in. (28.6 mm)
162 ≤ x < 230		1-3/8 in. (34.9 mm)	
230 ≤ x < 300	1-5/8 in. (41.3 mm)		
> 300			

Example:

Downstream capacity for C = capacity index of (unit 3 + unit 4 + unit 5 + unit 6)

7.3.3. Piping between refrigerant branch kits or Branch Selector units and indoor units: D

Pipe size for direct connection to indoor units must be the same as the connection size of the VRV indoor units.

Indoor unit capacity index	Piping outer diameter size	
	Gas pipe	Liquid pipe
07, 09, 12, 18	1/2 in. (12.7 mm)	1/4 in. (6.4 mm)
24, 30, 36, 42, 48, 54	5/8 in. (15.9 mm)	3/8 in. (9.5 mm)
72	3/4 in. (19.1 mm)	
96	7/8 in. (22.2 mm)	

7.4. Selection of refrigerant branch kits

For piping example, refer to 7.3. Selection of piping size on page 9.

- When using REFNET joints at the first branch from the outdoor units, choose from the following table in accordance with the capacity of the outdoor unit (example: REFNET joint a - see 7.3. Selection of piping size).

Outdoor unit capacity type	Kit name
RELQ 72, 96 T type	KHRP25A33T9
RELQ 120-192 T type	KHRP25M72TU9
RELQ 240 T type	KHRP25M73TU9

- For REFNET joints other than the first branch (example REFNET joint b - see 7.3. Selection of piping size), select the proper branch kit model based on the total capacity of all indoor units connected after the refrigerant branch.

Indoor unit capacity index	Kit name	
	(for 3 pipes)	(for 2 pipes)
< 72	KHRP25A22T9	KHRP26A22T9
72 ≤ x < 111	KHRP25A33T9	KHRP26A33T9
111 ≤ x < 246	KHRP25M72TU9	KHRP26M72TU9
≥ 246	KHRP25M73TU9	KHRP26M73TU9

- Concerning REFNET headers, choose from the following table in accordance with the total capacity of all the indoor units connected after the REFNET header.

Indoor unit capacity index	Kit name	
	(for 3 pipes)	(for 2 pipes)
< 72	KHRP25M33H9	KHRP26M22H9: maximum 4 indoor units or KHRP26M33H9: maximum 8 indoor units
72 ≤ x < 111		KHRP26M33H9
111 ≤ x < 230	KHRP25M72H9	KHRP26M72H9
≥ 230	KHRP25M73HU9	KHRP26M73H9

■ INFORMATION

Maximum 8 branches can be connected to a header.

- How to choose an outdoor multi connection piping kit (needed if the outdoor unit capacity type is 144 or more). Choose from the following table in accordance with the number of outdoor units.

Number of outdoor units	Branch kit name
2	BHFP26P100U

7.5. System piping (length) limitations

<Example of refrigerant piping (8 indoor units are connected)>

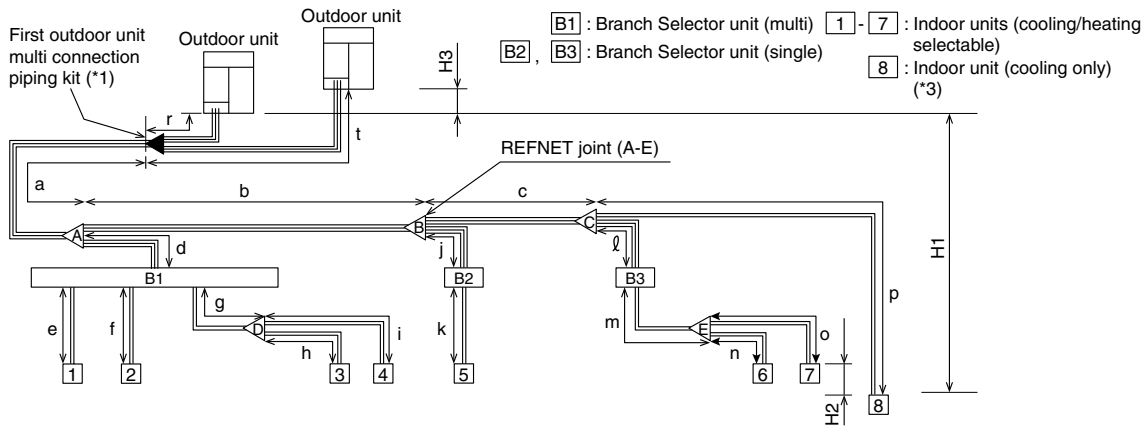

(*1) “≡” represents an outdoor unit multi connection piping kit.
 The outdoor unit multi connection piping kit must always be installed horizontally, paying attention to the installation restrictions indicated in **8. Precautions on refrigerant piping** on page 14.

<Example of connection>

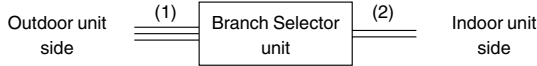

(1) Piping from outdoor units to Branch Selector units

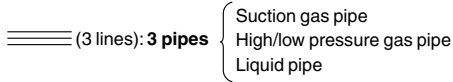

(2) Piping from Branch Selector units to the indoor units, and from refrigerant branch kits to the cooling-only indoor units (*2)

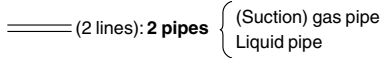

(*2) The 2-line gas pipe that is branched from the 3-line pipe and goes to the cooling-only indoor units should be connected to the suction gas pipe.
 (*3) Cooling-only units should make up ≤50% of the total capacity of indoor units.

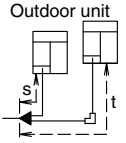
Maximum allowable length	From outdoor unit (*4) to indoor unit	Actual piping length	Actual piping length from the outdoor unit (*4) to the indoor unit: ≤540 ft. (165 m) (Example) [4]: a+d+g+i≤540 ft. (165 m), [7]: a+b+c+l+m+o≤540 ft. (165 m), [8]: a+b+c+p≤540 ft. (165 m)	
		Equivalent length	Equivalent piping length from the outdoor unit (*4) to the indoor unit: ≤623 ft. (190 m) (*6) (Calculate the equivalent piping length for the REFNET joint as 1.6 ft. (0.5 m), REFNET header as 3.3 ft. (1 m), BS4-6Q54TVJ as 19 ft. (6 m), BS8 to 12Q54TVJ as 33 ft. (10 m), BSQ36-60TVJ as 13 ft. (4 m), and BSQ96TVJ as 19 ft. (6 m).)	
		Total extension	Total actual piping length from the outdoor unit (*4) to all indoor units: ≤1640 ft. (500 m)	
	From first outdoor unit multi connection piping kit to outdoor unit (in a multi system)	Actual piping length Equivalent length	Actual piping length from the first outdoor unit multi connection piping kit to the outdoor unit: ≤33 ft. (10 m) Equivalent piping length from the first outdoor unit multi connection piping kit to the outdoor unit: ≤43 ft. (13 m)  s ≤ 33 ft. (10 m) (equivalent length ≤ 43 ft. (13 m)) t ≤ 33 ft. (10 m) (equivalent length ≤ 43 ft. (13 m))	
Allowable height difference	From outdoor unit to indoor unit	Height difference	Height difference between outdoor unit and indoor unit (H1): ≤164 ft. (50 m) (if outdoor unit is lower than indoor unit, ≤130 ft. (40 m)) (*7)	
	From indoor unit to indoor unit	Height difference	Actual piping length X	Height difference between indoor units (H2)
	From outdoor unit to outdoor unit	Height difference	Height difference between outdoor units (H3): ≤16 ft. (5 m)	
Allowable length after branch (*5)		Actual piping length	Actual piping length from the first REFNET joint or REFNET header to indoor unit: ≤130 ft. (40 m) (*8) (Example) [4]: d+g+i≤130 ft. (40 m), [7]: b+c+l+m+o≤130 ft. (40 m), [8]: b+c+p≤130 ft. (40 m)	

(*4) In the case of an outdoor units multi system, "outdoor unit" should be read as the "first outdoor unit multi connection piping kit", seen from the indoor units side.

(*5) In the case of a multi Branch Selector unit, it should be read as the "REFNET header", and the allowable length of piping should be selected. In the case where only 1 multi Branch Selector unit is included in the system, the actual piping length from each branch points of the multi Branch Selector unit to each indoor units should be ≤130 ft. (40 m).

(*6) In the case where the equivalent piping length from outdoor units to indoor units ≥295 ft. (90 m), make sure to upsize the liquid pipe of the main pipe (see the figure below), referring to the table below. (Do not upsize the high/low pressure gas pipe and the suction gas pipe.)

Outdoor unit capacity type	Liquid pipe
RELQ 72,96 T type	φ3/8 in. (9.5 mm) → φ1/2 in. (12.7 mm)
RELQ 120,144 T type	φ1/2 in. (12.7 mm) → φ5/8 in. (15.9 mm)
RELQ 192,240 T type	φ5/8 in. (15.9 mm) → φ3/4 in. (19.1 mm)

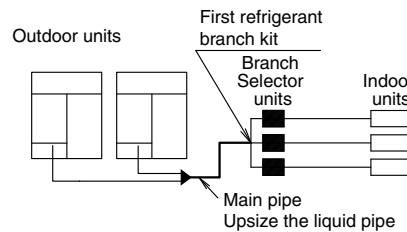

(*7) It can be extended to ≤295 ft. (90 m) (if outdoor unit is lower than indoor unit, ≤195 ft. (60 m) by field setting). See [2-49]=Height difference setting on page 34.

(*8) When conditions listed in the table below are all satisfied, the allowable length restrictions after branch is ≤ 295 ft. (90 m).

<p>Necessary conditions</p>	<p>Example: Only the allowable length after branch for the indoor unit 9 exceeds 130 ft. (40 m) in the figure in the lower right</p>	<p>Branch Selector units (B1-B7)</p> <p>Outdoor unit</p> <p>REFNET joints (A-G)</p> <p>Indoor unit (1-9)</p> <p>$b+c+d+e+f+g+p > 130$ ft. (40 m)</p> <p>From outdoor unit to the farthest indoor unit 9</p> <p>From outdoor unit to the nearest indoor unit 1</p>
<p>1. Upsize the liquid pipe from the first refrigerant branch kit to the final refrigerant branch kit for the indoor unit beyond 130 ft. (40 m).</p> <ul style="list-style-type: none"> If upsizing is impossible, the conditions are not satisfied. If the upsized line would become larger than the main pipe, then the main pipe should also be upsized. 	<p>Upsize the liquid pipes b, c, d, e, f and g in the figure in the right.</p> <p>The upsizing specifications should be as follows:</p> <p>$\phi 3/8$ in. (9.5 mm) \rightarrow $\phi 1/2$ in. (12.7 mm)</p> <p>$\phi 1/2$ in. (12.7 mm) \rightarrow $\phi 5/8$ in. (15.9 mm)</p> <p>$\phi 5/8$ in. (15.9 mm) \rightarrow $\phi 3/4$ in. (19.1 mm)</p> <p>$\phi 3/4$ in. (19.1 mm) \rightarrow $\phi 7/8$ in. (22.2 mm)</p>	
<p>2. The total piping length, calculated by doubling the piping length as upsized in 1 above, is ≤ 1640 ft. (500 m). (The main pipe, and lines that are not upsized, should not be doubled.)</p>	<p>$a + b \times 2 + c \times 2 + d \times 2 + e \times 2 + f \times 2 + g \times 2$</p> <p>$+ h + i + j + k + l + m + n + p + q + r + s$</p> <p>$\leq 1640$ ft. (500 m)</p>	
<p>3. The actual piping length from each indoor units to the nearest refrigerant branch kit are all ≤ 130 ft. (40 m).</p>	<ul style="list-style-type: none"> $i, j, \dots, p \leq 130$ ft. (40 m) $h + q + r \leq 130$ ft. (40 m) $h + q + s \leq 130$ ft. (40 m) 	
<p>4. The difference between the actual piping length from the outdoor unit to the farthest indoor unit, and the actual piping length from the outdoor unit to the nearest indoor unit, is ≤ 130 ft. (40 m).</p>	<p>Actual piping length of 9 - Actual piping length of 1</p> <p>$(a + b + c + d + e + f + g + p) - (a + h + q + r)$</p> <p>$\leq 130$ ft. (40 m)</p>	

In the case of a multi Branch Selector unit, if a junction pipe kit (separately sold) is used for combining 2 lines, the actual piping length between the multi Branch Selector unit and the indoor units should be ≤ 65 ft. (20 m).

8. Precautions on refrigerant piping

- Do not allow anything other than the designated refrigerant to get mixed into the refrigerant cycle, such as air, nitrogen, etc. If any refrigerant gas leaks while working on the unit, ventilate the room thoroughly right away.
- Use R410A only when adding refrigerant.
- Installation tools:
Make sure to use installation tools (gauge manifold, charge hose, etc.) that are exclusively used for R410A installations to withstand the pressure and to prevent foreign materials (e.g., mineral oils and moisture) from mixing into the system.
- Vacuum pump:
 - Use a 2-stage vacuum pump with a non-return valve.
 - Make sure the pump oil does not flow oppositely into the system while the pump is not working.
 - Use a vacuum pump which can evacuate to 500 microns.

Protection against contamination when installing pipes

Take measures to prevent foreign materials like moisture and contamination from mixing into the system.

	Installation	Protection method
	More than a month	Pinch the pipe
	Less than a month	Pinch or tape pipe
	Regardless of the period	

Block all gaps in the holes for passing out piping and wiring using sealing material (field supply) (the capacity of the unit will drop and small animals may enter the machine).

Example: passing piping out through the front.

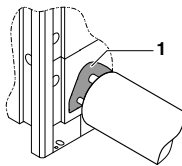

- 1 Close the areas marked with . (When the piping is routed from the front panel.)

- Use clean pipes only.
- Hold the pipe end downwards when removing burrs.
- Cover the pipe end when inserting it through a wall so that no dust or dirt enters the pipe.

NOTE

- After all the piping has been connected, make sure there is no gas leak. Use Dry Nitrogen to perform a gas leak detection.
- After knocking out the holes, we recommend you remove burrs in the knock holes and paint the edges and areas around the edges using the repair paint.

8.1. Caution for brazing

- Make sure to blow through with Dry Nitrogen when brazing. Blowing through with Dry Nitrogen prevents the creation of large quantities of oxidized film on the inside of the piping. An oxidized film adversely affects valves and compressors in the refrigerating system and prevents proper operation.
- The Dry Nitrogen pressure should be set to 2.9 psi (0.02 MPa (i.e., just enough so it can be felt on the skin)) with a pressure-reducing valve.

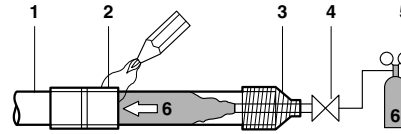

- 1 Refrigerant piping
- 2 Part to be brazed
- 3 Taping
- 4 Hands valve
- 5 Pressure-reducing valve
- 6 Dry Nitrogen

Do not use anti-oxidants when brazing the pipe joints. Residue can clog pipes and break equipment:

- Do not use flux when brazing copper-to-copper refrigerant piping. Use phosphor copper brazing filler alloy (BCuP) which does not require flux.
- Flux has an extremely harmful influence on refrigerant piping systems. For instance, if chlorine based flux is used, it will cause pipe corrosion or, in particular, if the flux contains fluorine, it will deteriorate the refrigerant oil.

8.2. Connecting the refrigerant piping

8.2.1. Decide front or side (bottom) connection

Installation of refrigerant piping is possible as front connection or side connection (when taken out from the bottom) as shown in the figure below.

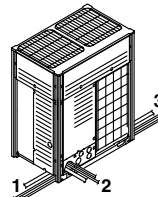

- 1 Left-side connection
- 2 Front connection
- 3 Right-side connection

- For side connections, the knockout hole on the bottom plate should be removed:

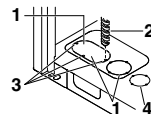

- 1 Knockout hole (Piping)
- 2 Drill
- 3 Points for drilling
- 4 Knockout hole (Power supply wiring)

NOTE

Precautions when knocking out knockout holes:

- Be sure to avoid damaging the casing.
- After knocking out the knockout holes, we recommend you remove the burrs and paint the edges and areas around the edges using repair paint to prevent rusting.
- When passing electrical wiring through the knock holes, protect the wiring with a conduit or bushings, making sure not to damage the wiring.

8.2.2. Remove the pinched pipes

WARNING

Any gas or oil remaining inside the stop valve may blow off the pinched piping.

Failure to observe the instructions in procedure below properly may result in property damage or personal injury, which may be serious depending on the circumstances.

Use the following procedure to remove the pinched piping:

- 1 Remove the valve cover and make sure that the stop valves are fully closed.

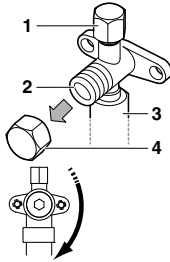

- 1 Service port and service port cover
- 2 Stop valve
- 3 Field piping connection
- 4 Stop valve cover

- 2 Connect the vacuuming/recovery unit to service ports of all stop valves.

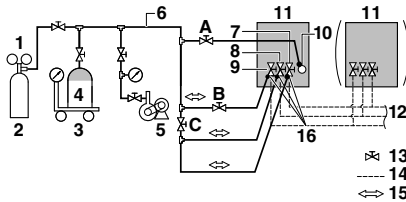

- 1 Gauge manifold
- 2 Nitrogen
- 3 Measuring instrument
- 4 Refrigerant R410A tank (siphon system)
- 5 Vacuum pump
- 6 Charge hose
- 7 High/low pressure gas pipe stop valve
- 8 Suction gas pipe stop valve
- 9 Liquid pipe stop valve
- 10 Refrigerant charge port
- 11 Outdoor unit
- 12 To Branch Selector unit (indoor unit)
- 13 Stop valve
- 14 Field piping
- 15 Gas flow
- 16 Stop valve service port
- A Valve A
- B Valve B
- C Valve C

- 3 Recover gas and oil from the pinched piping by using a recovery unit.

CAUTION
Do not vent gases into the atmosphere.

- 4 When all gas and oil is recovered from the pinched piping, disconnect the charge hose and close the service ports.

WARNING

When brazing at the proximity of the stop valves, be sure to protect the stop valves mounting plate with a protective plate to prevent from contacting with the burner flame.

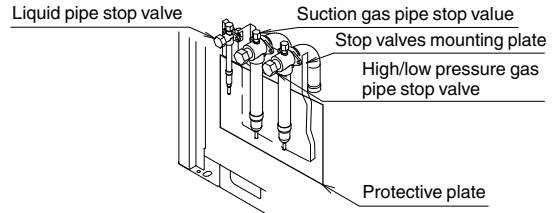

- 5 Cut off the lower part of the smaller pinched piping with an appropriate tool such as pipe cutters. Let the remaining oil drip out in case the recovery was not complete.

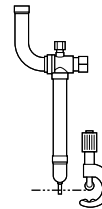

Wait until all oil is dripped out.

- 6 Cut the pinched piping off with a pipe cutter just above the brazing point or marking if there is no brazing point.

WARNING

Never remove the pinched piping by brazing. Any gas or oil remaining inside the stop valve may blow off the pinched piping.

Failure to observe the instructions in procedure below properly may result in property damage or personal injury, which may be serious depending on the circumstances.

- 7 Wait until all oil is dripped out before continuing with the connection of the field piping in case the recovery was not complete.

8.2.3. Connecting refrigerant piping to the outdoor unit

- All pipings for gas and liquid over from the field connection piping kit are field supplied.

Front connection

Remove the knockout hole of the piping intake and connect piping to the piping intake.

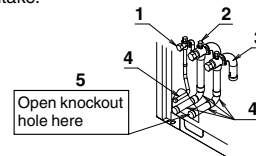

- 1 Liquid pipe stop valve
- 2 Suction gas pipe stop valve
- 3 High/low pressure gas pipe stop valve
- 4 Filed connection piping kit (accessory)
- 5 Knockout hole

Side (bottom) connection

Remove the knockout hole on the bottom frame and lead out the piping from the bottom frame.

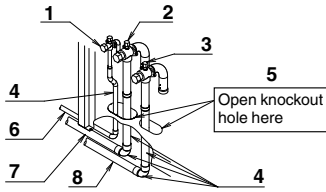

- 1 Liquid pipe stop valve
- 2 Suction gas pipe stop valve
- 3 High/low pressure gas pipe stop valve
- 4 Filed connection piping kit (accessory)
- 5 Knockout hole
- 6 Liquid side piping (field supply)
- 7 Suction gas side piping (field supply)
- 8 High/low pressure gas side piping (field supply)

INFORMATION

All local inter unit piping are field supplied except the accessory pipes.

NOTE

Precautions when connecting field piping. Add brazing material as shown in the figure.

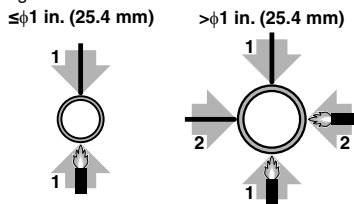

NOTE

- Be sure to use the supplied accessory pipes when carrying out piping work in the field.
- Be sure that the field installed piping does not touch other pipes, the bottom panel or side panel. Especially for the bottom and side connection, be sure to protect the piping with suitable insulation, to prevent it from coming into contact with the casing generated.

Connection from the stop valves to the field piping can be done by using accessory pipes supplied as accessory.

NOTE

Make sure that the onsite piping does not come in contact with other piping, the bottom frame or side panels of the unit.

The connections to the branch kits are the responsibility of the installer (field piping).

8.2.4. Precautions when connecting piping between outdoor units (multiple outdoor units system)

- To connect the piping between outdoor units, an optional multi connection piping kit BHFP26P100U is always required. When installing the piping, follow the instructions in the installation manual that comes with the kit.

- Only proceed with piping work after considering the limitations on installing listed here and in the chapter 8.2. Connecting the refrigerant piping on page 14 always referring to the installation manual delivered with the kit.

8.2.5. Possible installation patterns and configurations

- The piping between the outdoor units must be routed level or slightly upward to avoid the risk of oil retention into the piping.

Pattern 1

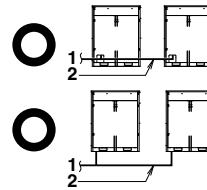

- 1 To indoor units
- 2 Piping between outdoor units

Pattern 2

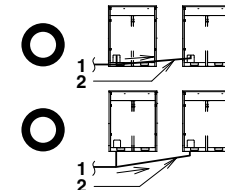

Prohibited patterns: change to pattern 1 or 2

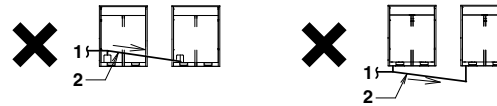

- 1 To indoor units
- 2 Piping between outdoor units

- To avoid the risk of oil retention to the outmost outdoor unit, always connect the stop valve and the piping between outdoor units as shown in the 4 correct possibilities of the figure below.

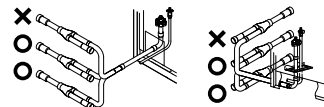

Prohibited patterns: change to pattern 1 or 2

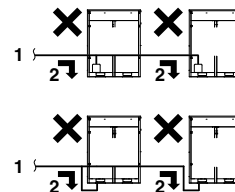

- 1 To indoor units
- 2 Oil collects to the outmost outdoor units

Change to configuration as in figure below

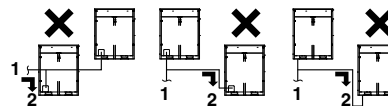

- 1 To indoor units
- 2 Oil collects to the outmost outdoor units

Correct configuration

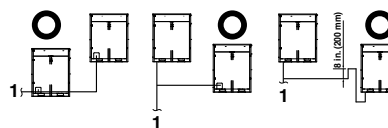

- 1 To indoor units

- If the piping length between the outdoor units exceeds 6.5 ft. (2 m), create a rise of 8 in. (200 mm) or more in the suction gas and high/low pressure gas line within a length of 6.5 ft. (2 m) from the kit.

If \leq 6.5 ft. (2 m)

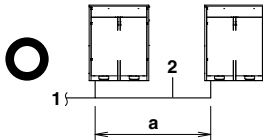

If $>$ 6.5 ft. (2 m)

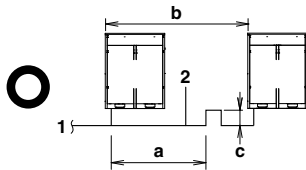

- 1 To indoor units
- 2 Piping between outdoor units
- a \leq 6.5 ft. (2 m)
- b \geq 8 in. (200 mm)
- c $>$ 6.5 ft. (2 m)

NOTE

There are restrictions on the refrigerant pipe connection order between outdoor units during installation in case of a multiple outdoor unit system. Install according to following restrictions. The capacities of outdoor units A and B must fulfill the following restriction conditions: $A \geq B$.

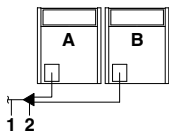

- 1 To indoor units
- 2 Outdoor unit multi connection piping kit (first branch)

8.2.6. Branching the refrigerant piping

- For installation of the refrigerant branch kit, refer to the installation manual delivered with the kit.

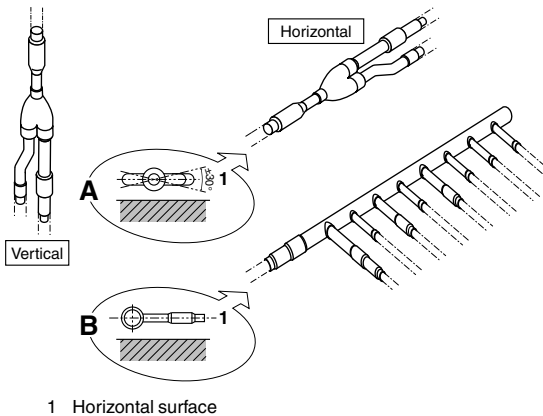

- Mount the REFNET joint so that it branches either horizontally or vertically.
- Mount the REFNET header so that it branches horizontally.

2 Installation of the multi connection piping kit.

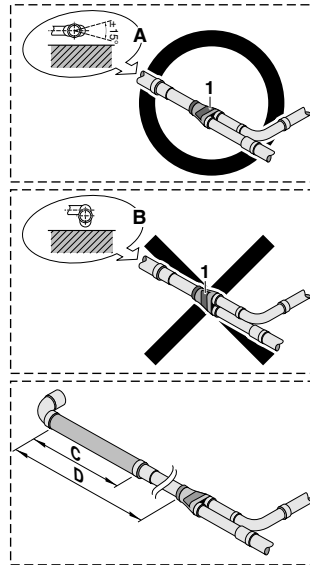

- C $>$ 4-3/4 in. (120 mm)
- D $>$ 19-11/16 in. (500 mm)

- Install the joints horizontally, so that the caution label (1) attached to the joint comes to the top.
 - Do not tilt the joint more than 15° (see view A).
 - Do not install the joint vertically (see view B).
- Make sure that the total length of the piping connected to the joint is absolute straight for more than 19-11/16 in. (500 mm). Only if a straight field piping of more than 4-3/4 in. (120 mm) is connected, more than 19-11/16 in. (500 mm) of straight section can be ensured.
- Improper installation may lead to malfunction of the outdoor unit.

8.3. Guidelines for handling stop valve

8.3.1. Cautions on handling the stop valve

- Make sure to keep all stop valves open during operation.
- The figure below shows the name of each part required in handling the stop valve.
- The stop valves are factory closed.
- When handle the stop valves, be careful not to damage the port pipes around (refer to P22).

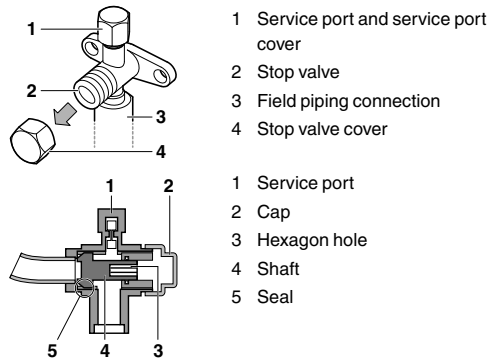

8.3.2. How to use the stop valve

Tightening torques

Stop valve size	Tightening torque (Turn clockwise to close)			Service port
	Shaft (valve body)		Cap (valve cover)	
φ1/2	5.97-7.30 ft·lbf (8.1-9.9 N·m)	Hexagonal wrench 4 mm	13.3-16.2 ft·lbf (18.0-22.0 N·m)	8.48-10.3 ft·lbf (11.5-13.9 N·m)
φ3/4		Hexagonal wrench 8 mm		
φ1	19.9-24.3 ft·lbf (27.0-33.0 N·m)	Hexagonal wrench 10 mm		
φ1-1/8				

Opening the stop valve

- 1 Remove the stop valve cover.
- 2 Insert a hexagon wrench into the stop valve and turn the stop valve counterclockwise.
- 3 When the stop valve cannot be turned any further, stop turning. The valve is now open.
 - Turn the stop valve (φ3/8, φ1/2) until the shaft stops. (Opening the valve with excessive force may damage it.)
 - Turn the stop valve (φ3/4-φ1-1/8) until the shaft stops and the designated torque is achieved.
- 4 Tighten the stop valve cover securely by applying the designated torque.

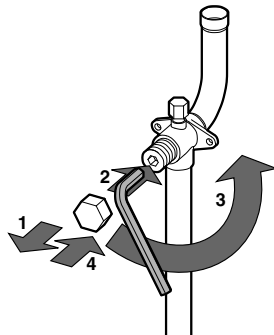

Closing the stop valve

- 1 Remove the stop valve cover.
- 2 Insert a hexagon wrench into the stop valve and turn the stop valve clockwise.
- 3 Turn until the shaft stops by applying the designated torque. The valve is now closed.
- 4 Tighten the stop valve cover securely by applying the designated torque.

Closing direction

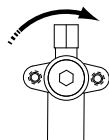

8.3.3. Cautions on handling the stop valve cover

- The stop valve cover is sealed where indicated by the arrow. Take care not to damage it.

- After handling the stop valve, make sure to tighten the stop valve cover securely. For the tightening torque, refer to 8.3.2. How to use the stop valve.
- Check for refrigerant leaks after tightening the stop valve cover.

CAUTION

- Do not open or close the stop valves if the ambient temperature is < -22°F (-30°C).

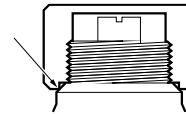

8.3.4. Cautions on handling the service port

- Always use a charge hose equipped with a valve depressor pin, since the service port is a Schrader type valve.
- After handling the service port, make sure to tighten the service port cover securely. For the tightening torque, refer to 8.3.2. How to use the stop valve.
- Check for refrigerant leaks after tightening the service port cover.

9. Field wiring

NOTE

- All field wiring and components must be installed by a licensed electrician and must comply with relevant local and national regulations.
- Be sure to use a dedicated power circuit. Never use a power supply shared by another appliance.
- Never install a phase-advancing capacitor. As this unit is equipped with an inverter, installing a phase-advancing capacitor will not only deteriorate power factor improvement effect, but also may cause capacitor abnormal heating accident due to high-frequency waves.
- Only proceed with wiring work after blocking off all power.
- Always ground wires in accordance with relevant local and national regulations.
- This machine includes an inverter device. Connect ground and leave charge to eliminate the impact on other devices by reducing noise generated from the inverter device and to prevent leaked current from being charged in the outer shell of the product.
- Do not connect the ground wire to gas pipes, sewage pipes, lightning rods, or telephone ground wires.
 - Gas pipes** can explode or catch fire if there is a gas leak.
 - Sewage pipes:** no grounding effect is possible if hard plastic piping is used.
 - Telephone ground wires and lightning rods** are dangerous when struck by lightning due to abnormal rise in electrical potential in the grounding.
- This equipment can be installed with a Ground-Fault Circuit Interrupter (GFCI). Although this is a recognized measure for additional protection, with the grounding system in North America, a dedicated GFCI is not necessary.
- Electrical wiring must be done in accordance with the wiring diagrams and the description herein.
- Do not operate until refrigerant piping work is completed. Operating the unit before completing piping work could cause the compressor to break.
- Never remove a thermistor, sensor or similar parts when connecting power wiring and transmission wiring. (If operated with a thermistor, sensor or similar parts removed, the compressor may be broken down.)
- Never connect the power supply in reverse-phase.

- Make sure the electrical imbalance ratio is no greater than 2%. If it is larger than this, the unit's lifespan will be reduced. If the ratio exceeds 4%, the unit will shut down and an malfunction code will be displayed on the indoor remote controller.
- Connect the wire securely using designated wire and fix it with attached clamp without applying external pressure on the terminal parts (terminal for power wiring, terminal for transmission wiring and ground terminal).
- If there exists the possibility of reverse-phase, lose phase, momentary blackout or the power goes on and off while the product is operating, attach a reverse-phase protection circuit locally. Running the product in reverse-phase may break the compressor and other parts.

9.1. Power circuit, safety device and cable requirements

- Make sure to apply the rated voltage of 208/230V, 460V or 575V for the unit.
- A power circuit (see the following table) must be provided for connection of the unit. This circuit must be protected with the required safety devices, i.e. a main switch, a slow blow fuse on each phase.
- When using residual current operated circuit breakers, be sure to use a high-speed type (0.1 seconds or less) 200 mA rated residual operating current.
- Use copper conductors only.
- Use insulated wire for the power cord.
- Select the power supply cable type and size in accordance with relevant local and national regulations.

Model name	Phase and frequency	Voltage	Minimum circuit amp.	Maximum overcurrent protective device	Transmission line selection
RELQ72TATJU	φ3, 60Hz	208/230V	60.8	70	AWG18-16
RELQ96TATJU	φ3, 60Hz	208/230V	76.5	80	AWG18-16
RELQ120TATJU	φ3, 60Hz	208/230V	83.4	90	AWG18-16
RELQ144TATJU	φ3, 60Hz	208/230V	60.8+60.8	70+70	AWG18-16
RELQ192TATJU	φ3, 60Hz	208/230V	76.5+76.5	80+80	AWG18-16
RELQ240TATJU	φ3, 60Hz	208/230V	83.4+83.4	90+90	AWG18-16
RELQ72TAYDU	φ3, 60Hz	460V	28.1	35	AWG18-16
RELQ96TAYDU	φ3, 60Hz	460V	39.8	45	AWG18-16
RELQ120TAYDU	φ3, 60Hz	460V	43.4	50	AWG18-16
RELQ144TAYDU	φ3, 60Hz	460V	28.1+28.1	35+35	AWG18-16
RELQ192TAYDU	φ3, 60Hz	460V	39.8+39.8	45+45	AWG18-16
RELQ240TAYDU	φ3, 60Hz	460V	43.4+43.4	50+50	AWG18-16
RELQ72TAYCU	φ3, 60Hz	575V	21.6	25	AWG18-16
RELQ96TAYCU	φ3, 60Hz	575V	28.5	35	AWG18-16
RELQ120TAYCU	φ3, 60Hz	575V	31.2	40	AWG18-16
RELQ144TAYCU	φ3, 60Hz	575V	21.6+21.6	25+25	AWG18-16
RELQ192TAYCU	φ3, 60Hz	575V	28.5+28.5	35+35	AWG18-16
RELQ240TAYCU	φ3, 60Hz	575V	31.2+31.2	40+40	AWG18-16

9.2. Wiring connection example for whole system

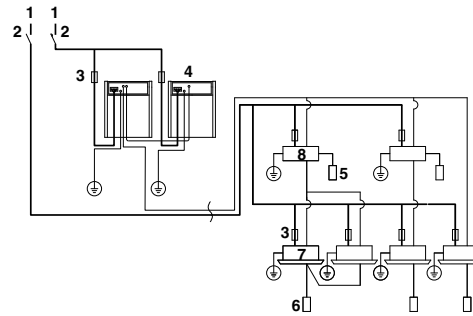

- 1 Power supply
- 2 Main switch
- 3 Fuse or circuit breaker
- 4 Outdoor unit
- 5 COOL/HEAT selector
- 6 Remote controller
- 7 Indoor unit
- 8 Branch Selector unit

This image is intended as an example only. Please follow local and national electrical code.

NOTE

- Make sure the low voltage wiring (i.e. for the remote controller, between units) and the power wiring do not pass near each other, keeping them at least 2 in. (51 mm) apart. Proximity may cause electrical interference, malfunctions, and breakage.
- Be sure to connect the power wiring to the power wiring terminal block and secure it as described in 9.5. Power wiring connection procedure.
- Transmission wiring should be secured as described in 9.4. Transmission wiring connection procedure.
- Secure wiring with clamp such as insulation lock ties to avoid contact with piping.
- Shape the wires to prevent the structure such as the control box cover deforming. And close the cover firmly.
- All field wiring is to be procured on site.

9.3. Leading wire procedure

- The power wiring and ground wiring are passed out from the power wiring hole on the front (knock hole).
- The transmission wiring is passed out from the wiring hole (knock hole) on the front of the unit.

RELQ72-120T type

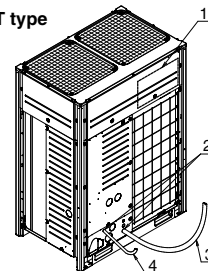

- 1 Wiring diagram printed on the back of the control box cover.
- 2 Knockout hole
- 3 Power line
- 4 Transmission line

RELQ72-120T type

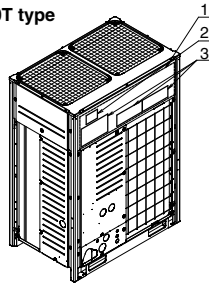

- 1 Control box cover
- 2 Inspection door
- 3 [Service precautions] Label location

NOTE

- Open the knock holes with a hammer or similar tool.
- After knocking out the holes, we recommend you remove any burrs and paint the holes with repair paint to prevent rusting. (Refer to the figure on page 19.)
- When passing wiring through the knock holes, remove burrs around the knock holes and protect the wiring with protective tape. (Refer to the figure on page 19.)
- If small animals might enter the unit, block off any gaps (hatching parts in the figure on page 19) with material (field supply).

9.4. Transmission wiring connection procedure

- Referring to the figure below, connect the transmission wiring between outdoor unit and indoor unit, outdoor unit and outdoor unit of other system, outdoor unit and outdoor unit of same system.

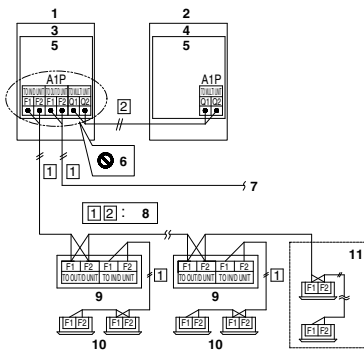

- 1 Master unit (*)
- 2 Sub unit (*)
- 3 Outdoor unit A
- 4 Outdoor unit B
- 5 Control box
- 6 Never connect the power wire.
- 7 To outdoor unit of other system
- 8 Use duplex wires (No polarity)
- 9 Branch Selector unit
- 10 Indoor unit
- 11 Indoor unit (Cooling only)

(*) : The outdoor unit that connect the transmission wiring to Branch Selector unit is Master unit of the multi system. And the other units are Sub unit. (In this figure, outdoor unit A is the Master unit.)
 Check operation in installation work, onsite settings and so on are done by operating the printed circuit board (A1P) of Master unit.

NOTE

- Do not connect the power wiring to terminals for the transmission wiring. Doing so would destroy the entire system.
 - Wiring to the indoor unit by way of Branch Selector unit should be wired to F1 and F2 on the outdoor unit's terminal block (A1P_X1M).
 - The above wiring should be wired using AWG18-16 stranded, non-shielded wiring.
 - All transmission wiring is to be procured onsite.
 - When connecting wires to the terminal block on the printed circuit board, too much heat or tightening could damage the printed circuit board. Attach with care.
- See the table below for the tightening torque of the transmission wiring terminals.

Screw size	Tightening torque
M3.5 (A1P)	0.59-0.71 ft·lbf (0.8-0.97 N·m)

- Transmission wiring (about the symbol ①-②, see the foregoing figure) should be done within the following limitations. If they are exceeded, transmission problems may occur.

- ① Between outdoor unit and Branch Selector (indoor) unit
 Between outdoor unit and outdoor unit of other systems
 Max. wiring length : 3280 ft. (1000 m)
 Max. total wiring length : 6560 ft. (2000 m)
 Max. no. of branches : 16

[Note] No branch is allowed after a branch. See the following figure.

Max. no. of outdoor units of other system that can be connected : 10

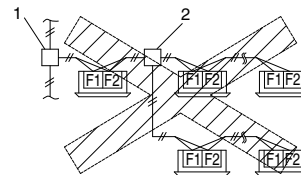

- 1 Branch
- 2 Branch after branch
- ② Between outdoor unit and outdoor unit of same system
 Max. wiring length : 98 ft. (30 m)

- The transmission wiring inside the control box should be secured using the clamp (1) as shown in the figure below.

RELQ72-120T type

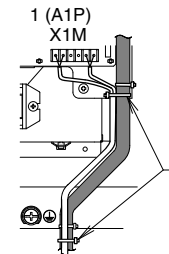

- 1 In the control box
- 2 Clamp (1) (accessory)

- Outside the units, the transmission wiring must be finished simultaneously with the local refrigerant piping, and wound with tape (field supply) as shown in the figure below.

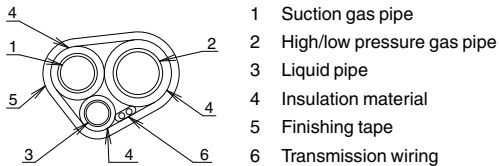

- For multi system:
 - 1 Transmission wiring between outdoor units in the same piping system must be connected to terminals Q1 and Q2 (TO MULTI UNIT).
Connecting the wires to the F1, F2 (TO OUT/D UNIT) terminals results in system malfunction.
 - 2 Wiring to other systems should be connected to terminals F1 and F2 (TO OUT/D UNIT) on the printed circuit board of the master unit. The outdoor unit that connects transmission wiring to indoor unit is the master unit. The others are sub unit.

9.5. Power wiring connection procedure

- Be sure to connect the power supply wiring to the power supply terminal block and hold it in place using the included clamp as shown in the figure below.
- The L1, L2 and L3 phases of the power wiring should be secured separately to the hook using the included clamp (1).
- The ground wiring should be bound to the power wiring using the included clamp (1) to prevent outside force from being applied to the terminal area.

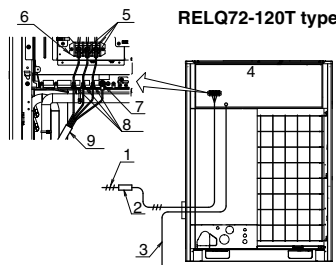

- 1 Power supply
(MODEL TATJU : 3-208/230V 60 Hz)
(MODEL TAYDU : 3-460V 60 Hz)
(MODEL TAYCU : 3-575V 60 Hz)
- 2 Branch switch, Overcurrent breaker
- 3 Ground wire
- 4 Control box
- 5 Attach insulation sleeves
- 6 Power supply terminal block
- 7 Ground terminal
- 8 Clamp (1) (accessory)
- 9 Vinyl tube (accessory)

CAUTION

- Be sure to use crimp-style terminal with insulating sleeves for connections. (See the figure below.)

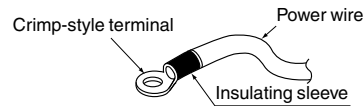

- For wiring, use the designated power wire and connect firmly, then secure to prevent outside pressure being exerted on the terminal board.
- Use an appropriate screwdriver for tightening the terminal screws. A screwdriver with a small head will strip the head and make proper tightening impossible.
- Over-tightening the terminal screws may break them.
See the following table for the tightening torque of the terminal screws.

Screw size	Tightening torque
M8 Power terminal	4.20-5.09 ft·lbf (5.7-6.9 N·m)
M8 Ground terminal	7.15-8.63 ft·lbf (9.7-8.63 N·m)

- When pulling the ground wire out, wire it so that it comes through the cut out section of the cup washer. (See the figure below.) An improper ground connection may prevent a good ground from being achieved.

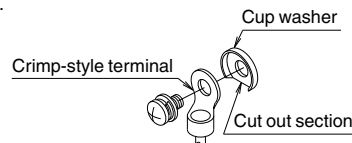

- When 2 wires are connected to a single terminal, connect them so that the rear sides of the crimp contacts face each other. Also, make sure the thinner wire is on top, securing the 2 wires simultaneously to the resin hook using the included clamp (1).

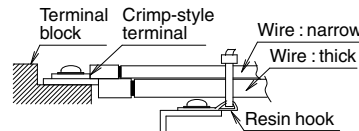

9.6. Procedure for Wiring Inside Units

- Referring to the figure below, secure and wire the power and transmission wiring using the included clamp (1), (2) and (3).
- Wire so that the ground wiring does not come into contact with the compressor lead wiring.
If they touch, this may have an adverse effect on other devices.
- The transmission wiring must be at least 2 in. (51 mm) away from the power wiring.
- Route wiring so that it does not come into contact with the high-temperature pipes (indicated by the hatching in the figure below) or the port pipes (see figure below).

RELQ72-120T type

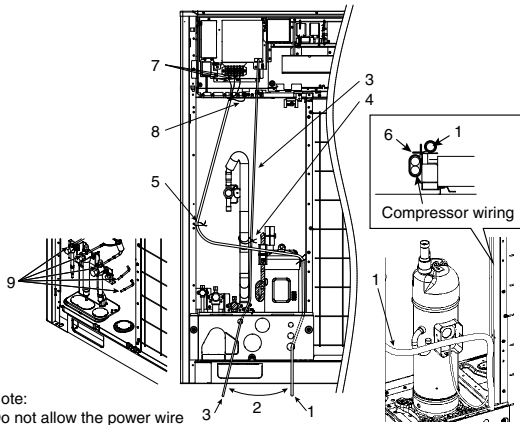

Note:
Do not allow the power wire to come into contact with the port pipe.

- | | |
|----------------------------|-------------------------|
| 1 Power/ground wires | 6 Clamp (3) (accessory) |
| 2 Clear over 2 in. (50 mm) | 7 Power wiring |
| 3 Transmission wiring | 8 Ground wire |
| 4 Clamp (1) (accessory) | 9 Port pipes |
| 5 Clamp (2) (accessory) | |

NOTE

Do not touch the port pipes during wiring work. Damages of pipes may cause refrigerant leak.

Precautions when knocking out knockout holes

- To punch out a knockout hole, hit it with a hammer.
- Open an appropriate hole as needed.
- After knocking out the holes, trim off the burr, then we recommend you to paint the edges and areas around the edges using the repair paint to prevent rusting.
- Power line: Open a knockout hole as shown at right and connect it using a conduit.
Choose an appropriate knockout hole for conduit size suitable for the power and ground line to be used.
- Transmission line: Connect it using a conduit in the knockout hole on the left.

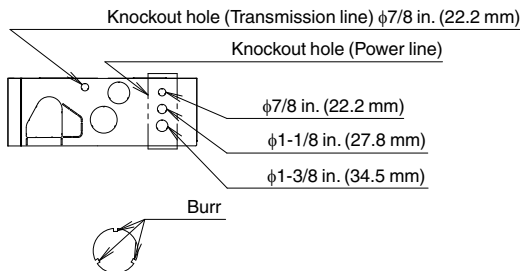

NOTE

After wiring work is completed, check to make sure there are no loose connections among the electrical parts in the control box.

10. Air tight test and vacuum drying

- After finished piping work, carry out air tight test and vacuum drying.

NOTE

- Always use nitrogen gas for the air tightness test.
- Absolutely do not open the stop valve until the main power circuit insulation measurement has been completed. (Measuring after the stop valve is opened will cause the insulation value to drop.)

<Needed tools>

Gauge manifold Charge hose valve	<ul style="list-style-type: none"> • To prevent entry of any impurities and insure sufficient pressure resistance, always use the special tools dedicated for R410A. • Use charge hose that have pushing stick for connecting to service port of stop valves or refrigerant charge port.
Vacuum pump	<ul style="list-style-type: none"> • The vacuum pump for vacuum drying should be able to lower the pressure to 500 microns. • Take care the pump oil never flow backward into the refrigerant pipe during the pump stops.

<The system for airtight test and vacuum drying>

- Referring to the figure below, connect a nitrogen tank, refrigerant tank, and a vacuum pump to the outdoor unit. The refrigerant tank and the charge hose connection to refrigerant charge port or the valve A in the figure below are needed in 14. Charging refrigerant on page 26.

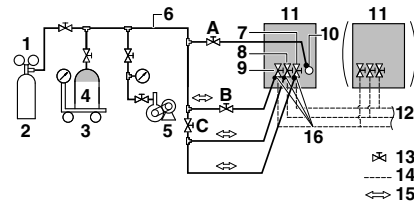

- 1 Gauge manifold
- 2 Nitrogen
- 3 Measuring instrument
- 4 Refrigerant R410A tank (siphon system)
- 5 Vacuum pump
- 6 Charge hose
- 7 High/low pressure gas pipe stop valve
- 8 Suction gas pipe stop valve
- 9 Liquid pipe stop valve
- 10 Refrigerant charge port
- 11 Outdoor unit
- 12 To Branch Selector unit (indoor unit)
- 13 Stop valve
- 14 Field piping
- 15 Gas flow
- A Stop valve service port
- B Valve A
- C Valve C

NOTE

- The air-tightness test and vacuum drying should be done using the service ports of suction gas pipe, high/low pressure gas pipe and liquid pipe stop valve. See the [R410A] Label attached to the front panel of the outdoor unit for details on the location of the service port (see the figure below).

RELQ72-120T type

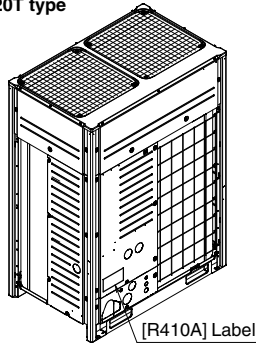

- See 14.3. Method for adding refrigerant on page 28 for details on handling the stop valve.
- The refrigerant charge port is connected to unit pipe. When shipped, the unit contains the refrigerant, so use caution when attaching the charge hose.

<Air tight test>

Pressurize the suction gas pipe, high/low pressure gas pipe and liquid pipe from the service ports of each stop valve to 550 psi (3.8 MPa) (do not pressurize more than 550 psi (3.8 MPa)). If the pressure does not drop within 24 hours, the system passes the test.

If there is a pressure drop, check for leaks, make repairs and perform the air tight test again.

<Vacuum drying>

Evacuate the system from the suction gas pipe, high/low pressure gas pipe and liquid pipe stop valve service ports by using a vacuum pump for more than 2 hours and bring the system to 500 microns or less. After keeping the system under that condition for more than 1 hour, check if the vacuum gauge rises or not. If it rises, the system may either contain moisture inside or have leaks.

NOTE

During the rainy season, moisture might enter the piping. If working during a rainy season and the work takes long enough for condensation to form inside the pipes, take the following precautions:

After evacuating the system for 2 hours, pressurize the system to 375,000 microns (vacuum break) with nitrogen gas and evacuate the system again using the vacuum pump for 1 hour to 500 microns or less (vacuum drying).

If the system cannot be evacuated to 500 microns within 2 hours, repeat the operation of vacuum break and vacuum drying.

Then, after leaving the system in a vacuum for 1 hour, confirm that the vacuum gauge does not rise.

11. Pipe insulation

NOTE

Pipe insulation thickness provided below are guidelines only. Pipes must be insulated with the appropriate thickness of insulation per applicable local/state or national codes.

- Insulation of pipes should be done after performing 10. Air tight test and vacuum drying on page 22.
- Always insulate the suction gas pipe, high/low pressure gas pipe, liquid pipe and pipe connections.
- Failing to insulate the pipes may cause leaking or burns. Be sure to use insulation designed for HVAC equipment.
- Reinforce the insulation on the refrigerant piping according to the installation environment. Condensation might form on the surface of the insulation. Refer to the below.
 - Ambient temperature : 86°F (30°C), humidity : 75% to 80% RH : minimum thickness : 9/16 in. (15 mm).
 - If the ambient temperature exceeds 86°F (30°C) and the humidity 80% RH, then the minimum thickness is 3/4 in. (20 mm). See the Engineering Data Book for detail.
- If there is a possibility that condensation on the stop valve might drip down into the indoor unit through gaps in the insulation and piping because the outdoor unit is located higher than the indoor unit, this must be prevented by caulking the connections. (Refer to the following figure.)

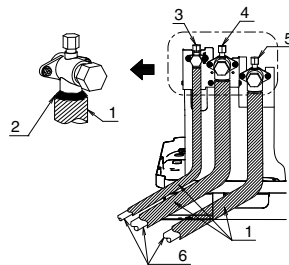

- 1 Insulation material
- 2 Caulking, etc.
- 3 Liquid pipe stop valve
- 4 Suction gas pipe stop valve
- 5 High/low pressure gas pipe stop valve
- 6 Connection pipe

12. Checking of device and installation conditions

Be sure to check the followings.

For those doing electrical work

- 1 Make sure there is no faulty transmission wiring or loosening of a nut.
See 9.4. Transmission wiring connection procedure on page 20.
- 2 Make sure there is no faulty power wiring or loosening of a nut.
See 9.5. Power wiring connection procedure on page 21.
- 3 Has the insulation of the main power circuit deteriorated?
Measure the insulation and check the insulation is above regular value in accordance with relevant local and national regulations.

For those doing pipe work

- 1 Make sure piping size is correct.
See 7.2. Selection of piping material on page 9 and 7.4. Selection of refrigerant branch kits on page 10.
- 2 Make sure insulation work is done.
See 11. Pipe insulation.
- 3 Make sure there is no faulty refrigerant piping.
See 8. Precautions on refrigerant piping on page 14.

13. Making field settings

To continue the configuration of the outdoor units, it is required to give some input to the printed circuit board of the unit. This chapter will describe how manual input is possible by operating the push buttons/ DIP switches on the printed circuit board and reading the feedback from the 7 segment displays.

For VRV Aurora series it is alternatively possible to make several commissioning field settings through a personal computer interface (for this, option 999482P3 is required). The installer can prepare the configuration (off-site) on PC and afterwards upload the configuration to the system. How to connect the cable is described in 13.3. Connecting the PC configurator to the outdoor unit on page 26.

The contents of the actual settings is discussed and explained in 15.2. Monitoring function and field settings on page 31.

13.1. Accessing the push buttons on the printed circuit board

It is not required to open the complete control box to access the push buttons on the printed circuit board and read out the 7 segment display (s).

To access you can remove the front panel (see figure). Now you can open the inspection door of the control box cover (see figure). You can see 3 push buttons and 3 seven-segment displays and DIP switches.

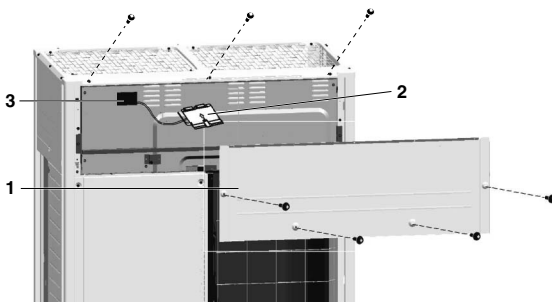

- 1 Front panel
- 2 Inspection door
- 3 Main printed circuit board with 3 seven-segment display and 3 push buttons

Operate the switches and push buttons with an insulated stick (such as a closed ballpoint pen) to avoid touching of live parts.



Location of the segment displays, buttons and DIP switches:

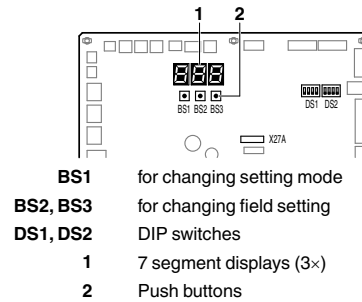

Segment display indications:

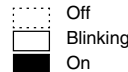

13.2. Operating the push buttons and DIP switches on the printed circuit board

13.2.1. Operating the push buttons

By operating the push buttons it is possible to:

- Perform special actions (automatic refrigerant charging, test run, etc).
- Perform field settings (demand operation, low noise, etc).

Below procedure explains how to operate the push buttons to reach the required mode in the menu, select the correct setting and modify the value of the setting. This procedure can be used any time special settings and regular field setting are discussed in this manual (see 15.2. Monitoring function and field settings on page 31).

Setting definition: [A-B]=C; A=mode; B=setting; C=setting value. A, B and C are numerical values for field settings. Parameter C has to be defined. It can be a chosen from a set (0, 1, 2, 3, 4, 5, ...) or regarded as an ON/OFF (1 or 0) depending on the contents. This is informed when the field setting is explained (see 15.2. Monitoring function and field settings on page 31).

— **I** INFORMATION —

During special operation (e.g., automatic refrigerant charging, test run, etc.) or when a malfunction happened, information will contain letters and numerical values.

Functions of the push button switches which are located on the main printed circuit board (A1P)

Turn on the power supply of the outdoor unit and all indoor units. When the communication between indoor units and outdoor unit (s) is established and normal, the segment indication state will be as follows (default situation when shipped from factory):

When turning on the power supply, the display flashes on and off. First checks of the power supply are executed (1-2 minutes).



When no trouble occurs: lighted as indicated (8-10 minutes).



Ready for operation: blank display indication as indicated.

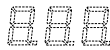

When above situation cannot be confirmed after 12 minutes, the malfunction code can be checked on the indoor unit user interface and the outdoor unit segment display. Solve the malfunction code accordingly. The communication wiring should be checked at first.

INFORMATION

Be sure to turn the power on at least 6 hours before operation in order to have power running to the crank case heater.

Accessing modes

BS1 is used to change the mode you want to access.

- Access mode 1
Push BS1 one time. Segment indication changes to:



- Access mode 2
Push BS1 for at least 5 seconds. Segment indication changes to:



INFORMATION

If you get confused in the middle of the process, push BS1. Then it returns to idle situation (no indication on segment displays: blank, refer to Functions of the push button switches which are located on the main printed circuit board (A1P) on page 24).

Mode 1

Mode 1 is used to set basic settings and to monitor the status of the unit (15.2. Monitoring function and field settings on page 31).

- Changing and access the setting in mode 1:
Once mode 1 is selected (push BS1 one time), you can select the wanted setting. It is done by pushing BS2. Accessing the selected setting's value is done by pushing BS3 one time.
- To quit and return to the initial status, press BS1.

Example:

Checking the content of parameter [1-10] (to know how many indoor units are connected to the system).

[A-B]=C in this case defined as: A=1; B=10; C=the value we want to know/monitor:

- Make sure the segment indication is displayed in operational default mode as shipped from factory.
- Push BS1 one time; result segment display:



Result: mode 1 is accessed.

- Push BS2 10 times; result segment display:



Result: mode 1 setting 10 is addressed.

- Push BS3 one time; the value which is returned (depending on the actual field situation), is the amount of indoor units which are connected to the system.
Result: mode 1 setting 10 is addressed and selected, return value is monitored information.
- To leave the monitoring function, push BS1 one time, you will return to the default situation when shipped from factory.

Mode 2

Mode 2 is used to set field settings of the outdoor unit and system.

- Changing and access the setting in mode 2:
Once mode 2 is selected (push BS1 for more than 5 seconds), you can select the wanted setting. It is done by pushing BS2. Accessing the selected setting's value is done by pushing BS3 one time.
- To quit and return to the initial status, press BS1.
- Changing the value of the selected setting in mode 2:
 - Once mode 2 is selected (push BS1 for more than 5 seconds) you can select the wanted setting. It is done by pushing BS2.
 - Accessing the selected setting's value is done by pushing BS3 one time.
 - Now BS2 is used to select the required value of the selected setting.
 - When the required value is selected, you can define the change of value by pushing BS3 one time.
 - Press BS3 again to start operation according to the chosen value.

Example:

Checking the content of parameter [2-18] (to define the high static pressure setting of the outdoor unit's fan).

[A-B]=C in this case defined as: A=2; B=10; C=the value we want to know/change

Make sure the segment indication is as during normal operation (default situation when shipped from factory).

- Push BS1 for over 5 seconds; result segment display:



Result: mode 2 is accessed.

- Push BS2 18 times; result segment display:



Result: mode 2 setting 18 is addressed.

- Push BS3 one time; the value which is returned (depending on the actual field situation), is the status of the setting. In the case of [2-18], default value is 0, which means the function is not active.
Result: mode 2 setting 18 is addressed and selected, return value is the current setting situation.
- To change the value of the setting, push BS2 till the required value appears on the segment indication. When achieved, define the setting value by pushing BS3 one time. To start operation according to the chosen setting, confirm again by pushing BS3.
- To leave the monitoring function, push BS1 two times, you will return to the default situation when shipped from factory.

13.2.2. Operating the DIP switches

By operating the DIP switches it is possible to:

What to do with DIP switch DS1	
1	Cool/Heat selector (refer to the manual of the Cool/Heat selector switch) OFF=not installed=factor setting
2-4	NOT USED DO NOT CHANGE THE FACTORY SETTING
What to do with DIP switch DS2	
1-4	NOT USED DO NOT CHANGE THE FACTORY SETTING

13.3. Connecting the PC configurator to the outdoor unit

Connection of the optional PC configurator cable to the outdoor unit has to be done on A1P. Connect the 999482P3 cable to the 5-pin blue connector X27A.

CAUTION

Works executed on the outdoor unit are best done under dry weather conditions to avoid water ingress.

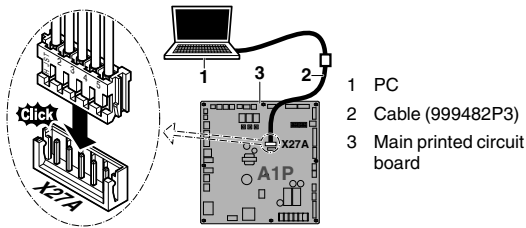

14. Charging refrigerant

14.1. Precautions

NOTE

- Refrigerant cannot be charged until field wiring has been completed.
- Refrigerant may only be charged after performing the leak test and the vacuum drying.
- When charging a system, care shall be taken that its maximum permissible charge is never exceeded, in view of the danger of liquid hammer.
- Charging a system with an unsuitable substance as refrigerant may cause explosions and accidents, so always ensure that the appropriate refrigerant R410A is charged.
- Refrigerant containers shall be opened slowly.
- Always use protective gloves and protect your eyes when charging refrigerant.
- When the refrigerant system is to be opened, refrigerant must be treated according to the applicable legislation.

DANGER

See Safety considerations on page i.

- To avoid compressor breakdown, do not charge the refrigerant more than the specified amount.
- This outdoor unit is factory charged with refrigerant and depending on pipe sizes and pipe lengths systems require additional charging of refrigerant. See 14.2. Calculating the additional refrigerant charge.
- In case recharge is required, refer to the nameplate of the unit. It states the type of refrigerant and necessary amount.

14.2. Calculating the additional refrigerant charge

NOTE

The refrigerant charge of the system must be less than 210 lbs. (100 kg). This means that in case the calculated total refrigerant charge is equal to or more than 209 lbs. (95 kg) you must divide your multiple outdoor system into smaller independent systems, each containing less than 209 lbs. (95 kg) refrigerant charge. For factory charge, refer to the unit nameplate.

14.2.1. How to calculate the additional refrigerant to be charged

Additional refrigerant to be charged=R (lbs.). R should be rounded off in units of 0.1 lbs.

$$R=[(X_1 \times \phi_{7/8}) \times 0.249+(X_2 \times \phi_{3/4}) \times 0.175+(X_3 \times \phi_{5/8}) \times 0.121+(X_4 \times \phi_{1/2}) \times 0.081+(X_5 \times \phi_{3/8}) \times 0.040+(X_6 \times \phi_{1/4}) \times 0.015] \times 1.04+[A]+[B]+[C]$$

X1...6 =Total length (ft. (m)) of liquid piping size at ϕ_a

* In units of 0.1 kg, additional refrigerant to be charged=R (kg).

$$R=[(X_1 \times \phi_{22.2}) \times 0.37+(X_2 \times \phi_{19.1}) \times 0.26+(X_3 \times \phi_{15.9}) \times 0.18+(X_4 \times \phi_{12.7}) \times 0.12+(X_5 \times \phi_{9.5}) \times 0.059+(X_6 \times \phi_{6.4}) \times 0.022] \times 1.04+[A]+[B]+[C]$$

Parameter [A] Refrigerant amount for Branch Selector units	
Branch Selector unit model	Refrigerant amount
BS4Q54T	0.7 lbs./unit (0.3 kg/unit)
BS6Q54T	0.9 lbs./unit (0.4 kg/unit)
BS8Q54T	1.1 lbs./unit (0.5 kg/unit)
BS10Q54T	1.5 lbs./unit (0.7 kg/unit)
BS12Q54T	1.8 lbs./unit (0.8 kg/unit)
BSQ36T	0.1 lbs./unit (0.05 kg/unit)
BSQ60T	0.2 lbs./unit (0.1 kg/unit)
BSQ96T	0.4 lbs./unit (0.2 kg/unit)

Parameter [B]	
Outdoor unit	Refrigerant amount
RELQ72TA	9.7 lbs./unit (4.4 kg/unit)
RELQ96TA	9.7 lbs./unit (4.4 kg/unit)
RELQ120TA	9.7 lbs./unit (4.4 kg/unit)

Field piping length	Parameter [C]		
	Total indoor unit capacity connection ratio	Refrigerant amount	
		Total outdoor unit capacity type	
		RELQ72-144T type	RELQ192-240T type
< 295.3 ft. (90 m)	≤ 85%	0.0	
	> 85%	The smaller of [D] or 5.51 lbs. (2.5 kg)	The smaller of [D] or 6.61 lbs. (3.0 kg)
≥ 295.3 ft. (90 m)	≤ 85%	0.0	
	> 85%	2.20 lbs. (1.0 kg)	

		Parameter [D]									
Indoor unit capacity type	FXMQ type										
	07	09	12	15	18	24	30	36	48	54	
Refrigerant amount (lbs. (kg)/unit)	0.06 (0.03)	0.03 (0.014)	0.14 (0.06)	0.29 (0.13)	0.25 (0.11)	0.16 (0.07)	0.33 (0.15)	0.25 (0.11)	0.08 (0.04)	0.00 (0.00)	
Indoor unit capacity type	FXFQ type									Others	
	07	09	12	15	18	24	30	36	48		
Refrigerant amount (lbs. (kg)/unit)	0.36 (0.16)	0.33 (0.15)	0.30 (0.14)	0.26 (0.12)	0.61 (0.28)	0.53 (0.24)	0.61 (0.28)	0.53 (0.24)	0.36 (0.16)	0.00 (0.00)	

Example for refrigerant branch using REFNET joint and REFNET header for systems and each pipe length is shown below. (Example 7.5. System piping (length) limitations on page 11.)

Outdoor system: RELQ240TAYCU (RELQ120TAYCU+RELQ120TAYCU)

Branch Selector units

BS4Q54T × 1, BSQ60T × 1, BSQ96T × 1

Indoor units

FXMQ type: 18 × 1, 24 × 1, 30 × 1, 36 × 2

FXFQ type: 36 × 2

Other: 48 × 1

Liquid piping

a: φ3/4 × 60 ft.	e: φ1/4 × 15 ft.	i: φ3/8 × 20 ft.	m: φ3/8 × 15 ft.	r: φ1/2 × 10 ft.
b: φ5/8 × 20 ft.	f: φ3/8 × 10 ft.	j: φ3/8 × 10 ft.	n: φ3/8 × 15 ft.	t: φ1/2 × 15 ft.
c: φ1/2 × 10 ft.	g: φ3/8 × 10 ft.	k: φ3/8 × 10 ft.	o: φ3/8 × 10 ft.	
d: φ3/8 × 15 ft.	h: φ3/8 × 15 ft.	ℓ: φ3/8 × 15 ft.	p: φ3/8 × 10 ft.	

Total length of liquid piping: 285 ft.

Total capacity of indoor unit: 110.0%

$$[D] = \boxed{0.25 \times 1} + \boxed{0.16 \times 1} + \boxed{0.33 \times 1} + \boxed{0.25 \times 2} + \boxed{0.53 \times 2} + \boxed{0.00 \times 1} = 2.30 \text{ lbs.}$$

↑ FXMQ18x1 ↑ FXMQ24x1 ↑ FXMQ30x1 ↑ FXMQ36x2 ↑ FXFQ36x2 ↑ Other48x1

[C]: The smaller of [D] or 6.61 lbs. = 2.30 lbs.

$$R = \left(\frac{60 \times 0.175}{a} + \frac{20 \times 0.121}{b} + \frac{35 \times 0.081}{c, r, t} + \frac{155 \times 0.040}{d, f, g, h, i, j, k, \ell, m, n, o, p} + \frac{15 \times 0.015}{e} \right) \times 1.04 + \boxed{1.3} + \boxed{19.4} + \boxed{2.30}$$

$$= 46.067 \Rightarrow \boxed{46.1 \text{ lbs.}}$$

Round off in units of 0.1 lbs.



INFORMATION

Piping length is considered by the distance from the outdoor unit to the farthest indoor unit.

14.3. Method for adding refrigerant

14.3.1. Flow chart

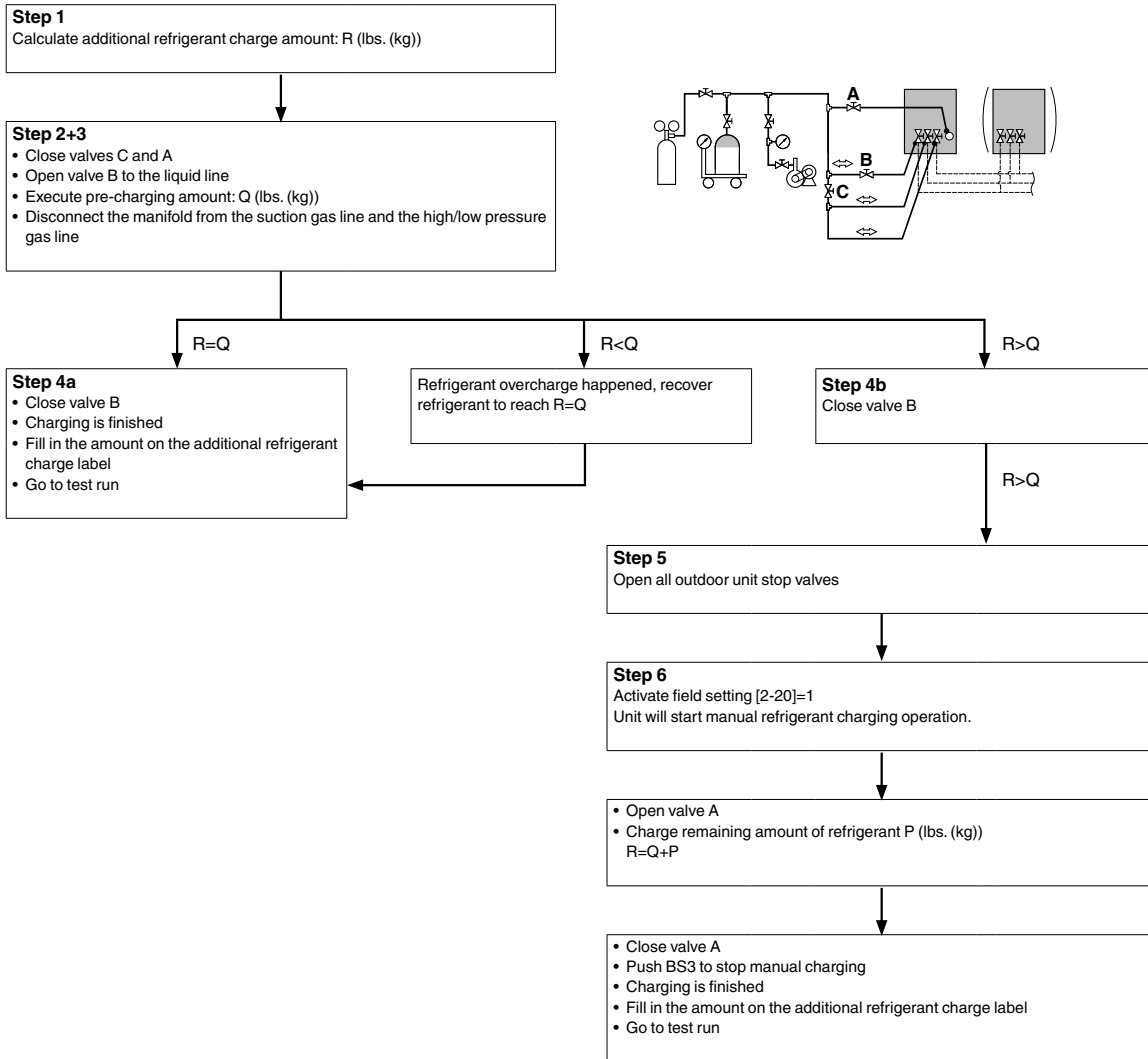

See figure location of valves next page for more information refer to the text in this chapter.

Be sure to charge the specified amount of refrigerant in liquid state. Since this refrigerant is a mixed refrigerant, adding it in gas form may cause the refrigerant composition to change, preventing normal operation.

- Before charging, check whether the refrigerant cylinder is equipped with a siphon tube or not.

If a siphon tube is equipped, change the liquid refrigerant with the cylinder in upright position.

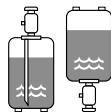

If a siphon tube is not equipped, change the liquid refrigerant with the cylinder in upside-down position.

- Be sure to use tools exclusively for R410A to ensure required pressure resistance and to prevent foreign materials from mixing into the system.

NOTE

- Charging with an unsuitable substance may cause explosions and accidents, so always make sure that the appropriate refrigerant (R410A) is charged.
- Refrigerant containers must be opened slowly.

CAUTION

- When charging a system, charging over the permissible quantity may cause liquid hammer.
- Always use protective gloves and protect your eyes when charging refrigerant.
- When the refrigerant charging procedure is done or when pausing, close the valve of the refrigerant tank immediately. If the tank is left with the valve open, the amount of refrigerant which was properly charged may get off point. More refrigerant may be charged by any remaining pressure after the unit has stopped.

NOTE

- If the power of some units is turned off, the charging procedure cannot be finished properly.
- In case of a multiple outdoor system, turn on the power of all outdoor units.
- Make sure to turn ON the power 6 hours before starting the operation. This is necessary to warm the crankcase by the electric heater.
- If operation is performed within 12 minutes after the indoor and outdoor units are turned on, the compressor will not operate before the communication is established in a correct way between outdoor unit(s) and indoor units.
- Before starting charging procedures, check if the segment display indication of the main printed circuit board (A1P) is as normal (see functions of the push button switches which are located on the main printed circuit board (A1P) on page 24). If a malfunction code is present, see 15.5. Malfunction code list on page 40.
- Make sure all connected indoor units are recognized (see 15.2. Monitoring function and field settings on page 31).
- Close the front panel before any refrigerant charge operation is executed. Without the front panel attached the unit cannot judge correctly whether it is operating properly or not.

14.3.2. Charging method

As explained during vacuum drying method, once vacuum drying is finished, additional refrigerant charging can start.

A flow chart is available which gives an overview of the possibilities and actions to be taken (see 14.3.1. Flow chart on page 28).

To speed up the process of pre-charging refrigerant for large systems, it is recommended to first charge a portion of the refrigerant before performing refrigerant charging operation of outdoor unit. This step is included in below procedure. This step can be skipped, but charging will take longer in such a case.

Follow the steps as described below.

- 1 Calculate the additional amount of refrigerant to be added using the formula mentioned in 14.2. Calculating the additional refrigerant charge on page 26.
- 2 The first 22 lbs. (10 kg) of additional refrigerant can be charged without outdoor unit operation.
If the additional refrigerant amount is smaller than 22 lbs. (10 kg), perform the pre-charging procedure as explained in step 3 and 4a below.
If the additional refrigerant charge is larger than 22 lbs. (10 kg), perform step 3 till the end of the procedure.
- 3 Pre-charging can be done without compressor running by connecting the refrigerant tank only to the liquid stop valve service port (open valve C). Make sure that all outdoor unit stop valves, as well as valves A and C are closed.

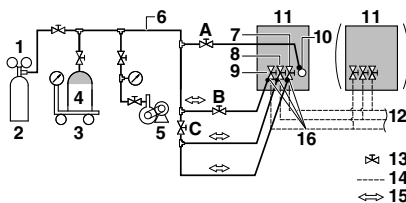

- 1 Gauge manifold
- 2 Nitrogen

- 3 Measuring instrument
- 4 Refrigerant R410A tank (siphon system)
- 5 Vacuum pump
- 6 Charge hose
- 7 High/low pressure gas pipe stop valve
- 8 Suction gas pipe stop valve
- 9 Liquid pipe stop valve
- 10 Refrigerant charge port
- 11 Outdoor unit
- 12 To Branch Selector unit (indoor unit)
- 13 Stop valve
- 14 Field piping
- 15 Gas flow
- 16 Stop valve service port
- A Valve A
- B Valve B
- C Valve C

- 4 a) If the calculated additional refrigerant amount is reached by above pre-charging procedure, close valve B.
b) If the total amount of refrigerant could not be charged by pre-charging, then close valve B and go to step 5.

INFORMATION

If the total additional refrigerant amount was reached in step 4 (by pre-charging only), record the amount of refrigerant that was added on the additional refrigerant charge label provided with the unit and attach it on the back side of the front panel. Perform the test procedure as described in 15.4. Test operation on page 39.

- 5 After pre-charging, perform the refrigerant charge operation as shown below and charge the remaining refrigerant of the additional charging amount through valve A.
Open all outdoor units stop valves. Valves A, B and C must remain closed!

NOTE

- The refrigerant charging port is connected to the piping inside the unit. The unit's internal piping is already factory charged with refrigerant, so be careful when connecting the charge hose.
- After adding the refrigerant, do not forget to close the cover of the refrigerant charging port. The tightening torque for the cover is 8.48 to 10.3 ft-lbf (11.5 to 13.9 N·m).
- In order to ensure uniform refrigerant distribution, it may take the compressor ±10 minutes to start up after the unit has started operation. This is not a malfunction.

- 6 The remaining additional refrigerant charge can be charged by operating the outdoor unit by means of the refrigerant charge operation mode:
 - Turn on the power of the indoor units and outdoor unit.
 - Take all the precautions mentioned in **start-up and configuration** into account.
 - Activate outdoor unit setting [2-20]=1 to start refrigerant charge mode. Refer to page 32 for details.

Result: The unit will start operation. Valve A can be opened. Charging of remaining additional refrigerant can be done. When the remaining calculated additional refrigerant amount is added, close valve A and push BS3 to stop the refrigerant charging procedure.

INFORMATION

The refrigerant charge operation will automatically stop within 30 minutes. If charging is not completed after 30 minutes, perform the additional refrigerant charging operation again.

Perform the test procedure as described in 15.4.2. Test operation on page 40.

INFORMATION

- When a malfunction is detected during the procedure (e.g., in case of closed stop valve), a malfunction code will be displayed. In that case, refer to 15.5. Malfunction code list on page 40 and solve the malfunction accordingly. Resetting the malfunction can be done by pushing BS3. The procedure can be restarted from 6).
 - Aborting the refrigerant charge is possible by pushing BS3. The unit will stop and return to idle condition.
-

If any malfunction code is displayed, close valve A immediately. Confirm the malfunction code and take corresponding action, 15.5. Malfunction code list on page 40.

14.3.3. Final charge adjustment

It is not necessary to do this final adjustment normally, but perform the following operation only when if the most adequate refrigerant for the best performance is required.

The outdoor temperature must be between 60°F (16°C) and 97°F (36 °C).

Purge gauge lines. Connect service gauge manifold to the service port between the compressor and the reversing valve in each outdoor unit. Run the system for 30 minutes in cooling by the forced operation using the field setting mode [2-6] (value 0: OFF, 1:ON) (Refer to 15.2. Monitoring function and field settings.) to allow pressures to stabilize, then check subcooling as detailed in the following sections.

Subcooling = Sat. Liquid Temp. – Liquid Line Temp.

- 1 Temporarily install a thermometer on the liquid line between the coil and the EV in each outdoor unit. Ensure the thermometer makes adequate contact and is insulated for best possible readings. Use liquid line temperature to determine sub cooling.
- 2 Check subcooling for each outdoor unit and calculate the average subcooling of the outdoor unit. Systems should have a subcooling of 11±3°F (6±2°C).
 - a. If average subcooling is low, add charge to raise subcooling to 11±3°F (6±2°C) (The maximum additional charge is 4.4 lbs. (2kg))
 - b. If average subcooling is high, remove charge to lower the subcooling to 11±3°F (6±2°C)

14.3.4. Checks after adding refrigerant

- Are all stop valves open?
- Is the amount of refrigerant, that has been added, recorded on the refrigerant charge label?

NOTE

Make sure to open all stop valves after (pre-) charging the refrigerant. Operating with the stop valves closed will damage the compressor.

15. Start-up and configuration

INFORMATION

It is important that all information in this chapter is read sequentially by the installer and that the system is configured as applicable.

DANGER: ELECTRICAL SHOCK

See Safety considerations on page i.

15.1. Checks before initial start up

After the installation of the unit, first check the following items. Once all below checks are fulfilled, the unit must be closed, only then can the unit be powered up.

- 1 Installation

Check that the unit is properly installed, to avoid abnormal noises and vibrations when starting up the unit.
- 2 Field wiring

Be sure that the field wiring has been carried out according to the instructions described in 9. Field wiring on page 18, according to the wiring diagrams and according to the applicable legislation.
- 3 Power supply voltage

Check the power supply voltage on the local supply panel. The voltage must correspond to the voltage on the identification label of the unit.
- 4 Ground wiring

Be sure that the ground wires have been connected properly and that the ground terminals are tightened.
- 5 Insulation test of the main power circuit

Using a megatester for 500 V, check that the insulation resistance of 1 MΩ or more is attained by applying a voltage of 500 V DC between power terminals and ground. Never use the megatester for the transmission wiring.
- 6 Fuses, circuit breakers, or protection devices

Check that the fuses, circuit breakers, or the locally installed protection devices are of the size and type specified in 9. Field wiring on page 18. Be sure that neither a fuse nor a protection device has been bypassed.
- 7 Internal wiring

Visually check the control box and the inside of the unit on loose connections or damaged electrical components.
- 8 Pipe size and pipe insulation

Be sure that correct pipe sizes are installed and that the insulation work is properly executed.
- 9 Stop valves

Be sure that all stop valves are open.
- 10 Damaged equipment

Check inside of the unit on damaged components or squeezed pipes.
- 11 Refrigerant leak

Check inside of the unit on refrigerant leakage. If there is a refrigerant leak, try to repair the leak. If the repair is unsuccessful, call your local dealer. Do not touch any refrigerant which has leaked out from refrigerant piping connections. This may result in frostbite.
- 12 Oil leak

Check the compressor for oil leakage. If there is an oil leak, try to repair the leak. If the repairing is unsuccessful, call your local dealer.

13 Air inlet/outlet

Check that the air inlet and outlet of the unit is not obstructed by paper sheets, cardboard, or any other material.

14 Record the contents of field setting.

Record them on the accessory **REQUEST FOR THE INDICATION** label.

And attach the label on the back side of the front panel.

15 Record the installation date.

Record the installation date on the accessory **REQUEST FOR THE INDICATION** label.

And attach the label on the back side of the front panel.

15.2. Monitoring function and field settings

The operation of the outdoor unit can further be defined by changing some field settings. Next to making field settings it is also possible to confirm the current operation parameters of the unit. The setting can also be performed via the PC configuration software.

Below relevant Monitoring mode (mode 1) and Field setting mode (mode 2) settings are explained in detail. How to access them, how to change the value of the settings and how to confirm them is explained in 13. Making field settings on page 24. In that chapter, an example is given on how to make a setting. It is advised to check this procedure before accessing, checking and changing below settings.

Once the default situation of the segment indication is confirmed (see 13. Making field settings on page 24), the mode 1 and mode 2 can be accessed.

Making settings is done via the master outdoor unit.

15.2.1. Mode 1

Mode 1 can be used to monitor the current situation of the outdoor unit. Some field setting contents can be monitored as well. Below the settings in mode 1 are explained.

- [1-0]= shows whether the unit you are checking is a master or sub 1 unit
- No indication=undefined situation
 - 0=outdoor unit is master unit
 - 1=outdoor unit is sub 1 unit

Master and sub 1 indications are relevant in multiple outdoor unit system configurations. The allocation of which outdoor unit is master and sub 1 are decided by the unit's logic.

The master unit must be used to input field settings in mode 2.

- [1-1]= shows the status of low noise operation.
- 1=unit is currently operating under low noise restrictions
 - 0=unit is currently not operating under low noise restrictions

Low noise operation reduces the sound generated by the unit compared to nominal operating conditions.

Low noise operation can be set in mode 2. There are two methods to activate low noise operation of the outdoor unit system.

The first method is to enable an automatic low noise operation during night time by field setting. The unit will operate at the selected low noise level during the selected time frames. The second method is to enable low noise operation based on an external input. For this operation an optional accessory is required.

- [1-2]= shows the status of power consumption limitation operation.
- 1=unit is currently operating under power consumption limitation
 - 0=unit is currently not operating under power consumption limitations

Power consumption limitation reduces the power consumption of the unit compared to nominal operating conditions. Power consumption limitation can be set in mode 2. There are two methods to activate power consumption limitation of the outdoor unit system.

The first method is to enable a forced power consumption limitation by field setting. The unit will always operate at the selected power consumption limitation.

The second method is to enable power consumption limitation based on an external input. For this operation an optional accessory is required.

- [1-5]= shows the current T_e target parameter position. Refer to 15.3. Energy saving and optimum operation on page 37 for more details about the contents of this value.

- [1-6]= shows the current T_c target parameter position. Refer to 15.3. Energy saving and optimum operation on page 37 for more details about the contents of this value.

- [1-10]= shows the total number of connected indoor units. It can be convenient to check if the total number of indoor units which are installed match the total number of indoor units which are recognized by the system. In case there is a mismatch, it is advised to check the communication wiring path between outdoor and indoor units (F1/F2 communication line).

- [1-13]= shows the total number of connected outdoor units. It can be convenient to check if the total number of outdoor units which are installed matches the total number of outdoor units which are recognized by the system. In case there is a mismatch, it is advised to check the communication wiring path between outdoor and outdoor units.

- [1-17]= shows the latest malfunction code.

- [1-18]= shows the 2nd last malfunction code.

- [1-19]= shows the 3rd last malfunction code. When the latest malfunction codes were reset by accident on an indoor unit user interface, they can be checked again through this monitoring settings. For the content or reason behind the malfunction code see 15.5. Malfunction code list on page 40, where most relevant malfunction codes are explained. Detailed information about malfunction codes can be consulted in the service manual of this unit.

- [1-40]= shows the current cooling comfort setting. See 15.3. Energy saving and optimum operation on page 37 for more details about this setting.

- [1-41]= shows the current heating comfort setting. See 15.3. Energy saving and optimum operation on page 37 for more details about this setting.

15.2.2. Mode 2

Mode 2 is used to change the field settings of the system. Consulting the current field setting value and changing the current field setting value is possible.

In general, normal operation can be resumed without special intervention after changing field settings.

Some field settings are used for special operation (e.g., 1 time operation, recovery/vacuuming setting, adding refrigerant setting, etc.). In such a case, it is required to abort the special operation before normal operation can restart. It will be indicated in below explanations.

[2-0]= Cool/Heat selection setting

Cool/Heat selection setting is used in case the optional Cool/Heat selector (KRC19-26A) is used. Depending on the outdoor unit setup (single outdoor unit setup or multi outdoor unit setup), the correct setting should be chosen. More details on how to use the Cool/Heat selector option can be found in the manual of the Cool/Heat selector.
Default value=0.

- 0=Each individual outdoor unit can select Cool/Heat operation (by Cool/Heat selector if installed).
- 1=Master unit decides Cool/Heat operation when outdoor units are connected in multiple system combination (a)
- 2=Sub unit for Cool/Heat operation when outdoor units are connected in multiple system combination (a)

Change [2-0]=0, 1 or 2 in function of required functionality.

[2-8]= T_e target temperature during cooling operation

Default value=0.

Value [2-8]	T _e target
0	Auto (default)
2	43°F (6°C)
3	45°F (7°C)
4	46°F (8°C)
5	48°F (9°C)
6	50°F (10°C)
7	52°F (11°C)

Change [2-8]=0, 2-7 in function of required operation method during cooling.

For more information and advice about the effect of these settings, see 15.3. Energy saving and optimum operation on page 37.

[2-9]= T_c target temperature during heating operation

Default value=0.

Value [2-9]	T _c target
0	Auto (default)
1	106°F (41°C)
3	109°F (43°C)
6	115°F (46°C)

Change [2-9]=0, 1, 3 or 6 in function of required operation method during heating.

For more information and advice about the effect of these settings, see 15.3. Energy saving and optimum operation on page 37.

[2-12]= Enable the low noise function and/or power consumption limitation via external control adaptor (DTA104A61/62)

If the system needs to run under low noise operation or under power consumption limitation conditions when an external signal is sent to the unit, this setting should be changed. This setting will only be effective when the optional external control adaptor (DTA104A61/62) is installed.
Default value=0.

To activate this function change [2-12]=1.

[2-18]= Fan high static pressure setting

In order to increase the static pressure the outdoor unit fan is delivering, this setting should be activated. For details about this setting, see technical specifications.
Default value=0.

To activate this function change [2-18]=1.

[2-20]= Additional refrigerant charge

In order to add the additional refrigerant charge amount following setting should be applied.
Further instructions can be found in chapter 14.3. Method for adding refrigerant on page 28.
Default value=0.

To activate this function change [2-20]=1.

To stop the additional refrigerant charge operation (when the required additional refrigerant amount is charged), push BS3. If this function was not aborted by pushing BS3, the unit will stop its operation after 30 minutes. If 30 minutes was not sufficient to add the needed refrigerant amount, the function can be reactivated by changing the field setting again.

[2-21]= Refrigerant recovery/vacuuming mode

In order to achieve a free pathway to recovering refrigerant out of the system or to remove residual substances or to vacuum the system it is necessary to apply a setting which will open required valves in the refrigerant circuit so the recovering of refrigerant or vacuuming process can be done properly.
Default value=0.

To activate function change [2-21]=1.

To stop the refrigerant recovery/vacuuming mode, push BS3. If BS3 is not pushed, the system will remain in refrigerant recovery/vacuuming mode.

[2-22]= Automatic low noise setting and level during night time

By changing this setting, you can activate the automatic low noise operation function of the unit and define the level of operation. Depending on the chosen level, the noise level will be lowered (3: Level 3<2: Level2<1: Level1). The start and stop moments for this function are defined under setting [2-26] and [2-27].
Default value=0.

Change [2-22]=1, 2 or 3 in function of required level.

[2-25]= Low noise operation level via the external control adaptor

If the system needs to run under low noise operation conditions when an external signal is sent to the unit, this setting defines the level of low noise that will be applied (3: Level 3<2: Level 2<1: Level 1).

This setting will only be effective when the optional external control adaptor (DTA104A61/62) is installed and the setting [2-12] is activated.
Default value=2.

Change [2-25]=1, 2 or 3. in function of required level.

[2-26]= Low noise operation start time

Change [2-26]=1, 2 or 3 in function of required timing.
Default value=2.

Value [2-26]	Start time automatic low noise operation (approximately)
1	8:00 p.m.
2	10:00 p.m. (default)
3	12:00 a.m.

This setting is used in conjunction with setting [2-22].

[2-27]= Low noise operation stop time

Default value=3.

Value [2-27]	Start time automatic low noise operation (approximately)
1	6:00 a.m.
2	7:00 a.m.
3	8:00 a.m. (default)

This setting is used in conjunction with setting [2-22].

[2-30]= Power consumption limitation level (step 1) via the external control adaptor (DTA104A61/62)

If the system needs to run under power consumption limitation conditions when an external signal is sent to the unit, this setting defines the level power consumption limitation that will be applied for step 1. The level is according to the table.

Default value=3.

Change [2-30]=1, 2, 3, 4, 5, 6, 7 or 8 in function of required limitation.

Value [2-30]	Power consumption limitation (approximately)
1	60%
2	65%
3	70% (default)
4	75%
5	80%
6	85%
7	90%
8	95%

[2-31]= Power consumption limitation level (step 2) via the external control adaptor (DTA104A61/62)

If the system needs to run under power consumption limitation conditions when an external signal is sent to the unit, this setting defines the level power consumption limitation that will be applied for step 2. The level is according to the table.

Default value=1.

Change [2-31]=1, 2 or 3 in function of required limitation.

Value [2-31]	Power consumption limitation (approximately)
1	40% (default)
2	50%
3	55%

[2-32]= Forced, all time, power consumption limitation operation (no external control adaptor is required to perform power consumption limitation)

If the system always needs to run under power consumption limitation conditions, this setting activates and defines the level power consumption limitation that will be applied continuously. The level is according to the table.
Default value=0 (OFF).

Value [2-32]	Restriction reference
0	Function not active (default)
1	Follows [2-30] setting
2	Follows [2-31] setting

Change [2-32]=0, 1 or 2 in function of required limitation.

[2-34]= Indoor unit fan tap setting

Indoor units fan speed limitation related to connection capacity and outdoor air temperature for energy saving.

Default value=0.

Value [2-34]	Indoor unit fan tap setting
0	Fan speed is limited to L tap when indoor units capacity \geq 130%.
1	In heating mode, fan speed is limited to L tap when indoor units capacity \geq 130%.
2	Fan speed follows the setting of remote controllers (not limited by indoor units connection capacity).
3	Fan speed is limited to L tap when outdoor air temperature goes down to below 85.1°F (29.5°C) and indoor air temperature is in condition A (*). It returns to remote controller setting when outdoor air temperature goes up to over 90.5°F (32.5°C) or indoor air temperature is in condition B (**).
4	Fan speed is limited to L tap when outdoor air temperature goes down to below 74.3°F (23.5°C) and indoor air temperature is in condition A (*). It returns to remote controller setting when outdoor air temperature goes up to over 79.7°F (26.5°C) or indoor air temperature is in condition B (**).
5	Fan speed is limited to L tap when outdoor air temperature goes down to below 66.7°F (19.3°C) and indoor air temperature is in condition A (*). It returns to remote controller setting when outdoor air temperature goes up to over 72.1°F (22.3°C) or indoor air temperature is in condition B (**).
6	Fan speed is limited to L tap when outdoor air temperature goes down to below 85.1°F (29.5°C). It returns to remote controller setting when outdoor air temperature goes up to over 90.5°F (32.5°C).
7	Fan speed is limited to L tap when outdoor air temperature goes down to below 74.3°F (23.5°C). It returns to remote controller setting when outdoor air temperature goes up to over 79.7°F (26.5°C).
8	Fan speed is limited to L tap when outdoor air temperature goes down to below 66.7°F (19.3°C). It returns to remote controller setting when outdoor air temperature goes up to over 72.1°F (22.3°C).

* Indoor condition A: Temperature difference (indoor air temperature – set temperature) is more than –2.7°F (–1.5°C) and less than 5.4°F (3°C).

** Indoor condition B: Temperature difference (indoor air temperature – set temperature) is –2.7°F (–1.5°C) or less, or 5.4°F (3°C) or more.

[2-35]= Height difference setting

Default value=1.

In case the outdoor unit is installed in the lowest position (indoor units are installed on a higher position than outdoor units) and the height difference between the highest indoor unit and the outdoor unit exceeds 130 ft. (40 m), the setting [2-35] should be changed to 0.

Other changes/limitations to the circuit apply, for more information see 7.5. System piping (length) limitations on page 11.

[2-45]= Low ambient cooling

Default value=0.

Value [2-45]	Description
0	No low ambient cooling available. (default)
1	Low ambient cooling available.

This setting is not applicable to multi Branch Selector unit. For more information about this setting, refer to the service manual.

[2-47]= T_e target temperature during heat recovery operation

Default value=0.

Value [2-47]	T _e target
0	Auto (default)
2	43°F (6°C)
3	45°F (7°C)
4	46°F (8°C)
5	48°F (9°C)
6	50°F (10°C)
7	52°F (11°C)

Change [2-47]=0, 2-7 in function of required operation method during heat recovery operation. For more information and advice about the effect of these settings, see 15.3. Energy saving and optimum operation.

[2-49]= Height difference setting

Default value=0.

In case the outdoor unit is installed in the highest position (indoor units are installed on a lower position than outdoor units) and the height difference between the lowest indoor unit and the outdoor unit exceeds 164 ft. (50 m), the setting [2-49] has to be changed to 1.

Other changes/limitations to the circuit apply, for more information see 7.5. System piping (length) limitations on page 11.

[2-81]= Cooling comfort setting

Default value=1.

Value [2-81]	Cooling comfort setting
0	Eco
1	Mild (default)
2	Quick
3	Powerful

Change [2-81]=0, 1, 2 or 3 in function of required limitation. This setting is used in conjunction with setting [2-8] and [2-47]. For more information and advice about the effect of these

settings, see 15.3. Energy saving and optimum operation.

[2-82]= Heating comfort setting

Default value=1.

Value [2-82]	Heating comfort setting
0	Eco
1	Mild (default)
2	Quick
3	Powerful

Change [2-82]=0, 1, 2 or 3 in function of required limitation. This setting is used in conjunction with setting [2-9]. For more information and advice about the effect of these settings, see 15.3. Energy saving and optimum operation.

15.2.3. Auxiliary heat control

To improve efficiency the aux heat can be lockout based on outdoor temperature.

Item	Description	Min	Max	Increments
AUX Heater Allowable Temp	Below this temperature, AUX heater can be energized based on the indoor temperature condition.	0F	65F (35F default)	5F
AUX Heater Allowable temp Release differential	When the outdoor temp recovered by this temp, AUX heater cannot be allowed.	5F, 10F (default), 15F		

[2-97]= Aux heater max allowable temp
 AUX Heater is allowed to energize when the ambient temp is smaller than the AUX Heater Max Allowable Temp.

AUX Heater Max Allowable Temp	Fahrenheit	Celsius
0	0	- 17.7
1	5	- 15
2	10	- 12.2
3	15	- 9.4
4	20	- 6.6
5	25	- 3.8
6	30	- 1.1
7	35 (default)	1.6 (default)
8	40	4.4
9	45	7.2
10	50	10
11	55	12.7
12	60	15.5
13	65	18.3
14	AUX Heater always NOT allowed	
15	AUX Heater always allowed	

[2-98]= Aux heater max allowable temp release differential
 AUX Heater is not allowed to energize when the outdoor ambient temp is recovered by differential (below) above the AUX Heater Max Allowable Temp.

AUX Heater Max Allowable temp Release differential	Fahrenheit	Celsius
0	5	2.8°C
1	10 (default)	5.6°C (default)
2	15	8.3°C

15.2.4. Heat pump lockout

- New control logic to provide more application options for cold climates.
- Outside temperature can now be measured directly from the outdoor unit coil sensor.
- VRV IV HR, VRV-S and VRV Cold Climate can also be programed to automatically switch to emergency heat is there is a system fault.

Item	Description	Min	Max	Increments
Heat Pump Lockout Temp	Below this temperature, heat pump is locked out.	- 15F (default)	50F	5F
Heat Pump Lockout Release differential	When the outdoor temp is recovered by this temp, heat pump is resumed.	5F, 10F (default), 15F		

[2-16]= Aux heater setting (Type I)

Value [2-16]	Aux heater
0	OFF
1	ON

[2-37]= Aux heater setting (Type II)

Value [2-37]	Controlling mode
1	Mode 1
2	Mode 2
3	Mode 3
4	Mode 4
5	Mode 5
6	Mode 6

Type	Description	Actions						
		Field setting	Shorted between	Heating Thermo-on		Heating Thermo-off		
				Aux heater	Indoor fan	Aux heater	Indoor fan	
I	--	Heat-pump heating is always locked out	2-16 = ON	--	ON	ON (H/L)	OFF	LL
II	Mode 1	Lockout is controlled by ABC terminals	2-37 = Mode 1	A-C	ON	ON (H/L)	OFF	LL
	B-C			OFF				
	Mode 2 (for a heater which doesn't need airflow)		2-37 = Mode 2	A-C				LL
				B-C				OFF
	Mode 3	2-37 = Mode 3	Same as 2-37 = Mode 1 & A-C shorted					
	Mode 4	2-37 = Mode 4	Same as 2-37 = Mode 1 & B-C shorted					
	Mode 5	2-37 = Mode 5	Same as 2-37 = Mode 2 & A-C shorted					
	Mode 6	2-37 = Mode 6	Same as 2-37 = Mode 2 & B-C shorted					

[2-78]= Heat pump lockout temp
Heat pump would be locked out when the outdoor ambient temp is smaller than the Heat Pump Lockout Temp below – this setting is only affective when heat pump lockout mode has been set. Unit will switch to heat pump lock out.

Heat Pump Lockout Temp	Fahrenheit	Celsius
0	- 15 (default)	- 26.1 (default)
1	- 10	- 23.3
2	- 5	- 20.5
3	0	- 17.7
4	5	- 15
5	10	- 12.2
6	15	- 9.4
7	20	- 6.6
8	25	- 3.8
9	30	- 1.1
10	35	1.6
11	40	4.4
12	45	7.2
13	50	10
14	Forced Heat pump Lock out	

[2-79]= Heat pump lockout release differential
Heat pump would be resumed when the outdoor ambient temp is recovered by differential (below) above the Heat Pump Lockout Temp.

Heat Pump Lockout Release differential	Fahrenheit	Celsius
0	5	2.8°C
1	10 (default)	5.6°C (default)
2	15	8.3°C

When HP lockout mode has been set the auto backup function will automatically be set. This will allow the auxiliary or secondary heat source to be automatically energized in the event of a system failure.
Error codes capable of auto backup are listed in the table below. Please be aware that the error codes that are not listed do not auto backup in order to protect the unit.

Error contents	Error code (Auto backup possible)
BS abnormality	A3
Actuation of high pressure switch	E3
Actuation of low pressure sensor	E4
Inv. compressor motor lock	E5
Compressor damage alarm	E6
Outdoor unit fan motor abnormality	E7
Electronic expansion valve coil abnormality	E9
Position signal abnormality of outdoor unit fan motor	H3
	H7
Outdoor air thermistor (R1T) abnormality	H9
Discharge pipe temperature abnormality	F3
Wet alarm	F4
BS electronic expansion valve abnormality	F9
Discharge pipe thermistor (R21T, R22T) and compressor surface temperature thermistor (R14T) abnormality	J3
Accumulator inlet thermistor (R10T) abnormality	J5
Heat exchanging deicer thermistor (R11T) and heat exchanger gas pipe thermistor (R8T,R9T) abnormality	J6
Receiver inlet thermistor (R3T) and sub cooling heat exchanger liquid pipe thermistor (R7T) abnormality	J7
Heat exchanger liquid pipe thermistor (R15T, R4T, R5T) abnormality	J8
Subcooling heat exchanger gas pipe thermistor (R6T) and receiver gas purge thermistor (R13T) abnormality	J9
High pressure sensor abnormality	JA
Low pressure sensor abnormality	JC
Inverter PCB abnormality	L1
Reactor temperature rise abnormality	L3
Inverter radiation fin temperature rise abnormality	L4
Inv. compressor instantaneous overcurrent	L5
Inv. compressor overcurrent	L8
Inv. compressor startup abnormality	L9
Transmission error between inverter and control PCB	LC

15.3. Energy saving and optimum operation

RELQ-T units are equipped with advanced energy saving functionality. Depending on the priority, emphasizes can be put on energy saving or comfort level. Several parameters can be selected, resulting in the optimal balance between energy consumption and comfort for the particular application.

Several patterns are available and explained below. Modify the parameters to the needs of your building and to realize the best balance between energy consumption and comfort.

15.3.1. Three main operation methods are available:

• **Basic**

The refrigerant temperature is fixed independent from the situation. It corresponds to the standard operation which is known and can be expected from/under previous VRV systems:

- To activate this operation method under cooling operation: change field setting [2-8]=2 and [2-47]=2.
- To activate this operation method under heating operation: change field setting [2-9]=6.

• **Automatic**

The refrigerant temperature is set depending on the outdoor ambient conditions. As such adjusting the refrigerant temperature to match the required load (which is also related to the outdoor ambient conditions).

E.g., when your system is operating in cooling, you do not need as much cooling under low outdoor ambient temperatures (e.g., 77°F (25°C)) as under high outdoor ambient temperatures (e.g., 95°F (35°C)).

Using this idea, the system automatically starts increasing its refrigerant temperature, automatically reducing the delivered capacity and increasing the system's efficiency.

- To activate this operation method under cooling operation: change field setting [2-8]=0 (default) and [2-47]=0 (default).

E.g., when your system is operating in heating, you do not need as much heating under high outdoor ambient temperatures (e.g., 59°F (15°C)) as under low outdoor ambient temperatures (e.g., 23°F (-5°C)).

Using this idea, the system automatically starts decreasing its refrigerant temperature, automatically reducing the delivered capacity and increasing the system's efficiency.

- To activate this operation method under heating operation: change field setting [2-9]=0 (default).

• **Hi-sensible/economic (cooling/heating)**

The refrigerant temperature is set higher/lower (cooling/heating) compared to basic operation. The focus under high sensible mode is comfort feeling for the customer.

The selection method of indoor units is important and has to be considered as the available capacity is not the same as under basic operation. For details concerning to Hi-sensible applications, please contact your dealer.

- To activate this setting under cooling operation: change field setting [2-8] and [2-47] to the appropriate value, matching the requirements of the pre-designed system containing a high sensible solution.

Value [2-8] and [2-47]	T _c target
3	45°F (7°C)
4	46°F (8°C)
5	48°F (9°C)
6	50°F (10°C)
7	52°F (11°C)

- To activate this setting under heating operation: change field setting [2-9] to the appropriate value, matching the requirements of the pre-designed system containing a high sensible solution.

Value [2-9]	T _c target
1	106°F (41°C)
3	109°F (43°C)

15.3.2. Several comfort settings are available

For each of above modes a comfort level can be selected. The comfort level is related to the timing and the effort (energy consumption) which is put in achieving a certain room temperature by temporarily changing the refrigerant temperature to different values in order to achieve requested conditions more quickly.

• **Powerful**

Overshoot (during heating operation) or undershoot (during cooling operation) is allowed compared to the requested refrigerant temperature, in order to achieve the required room temperature very fast. The overshoot is allowed from the start up moment.

In case of cooling operation the evaporating temperature is allowed to go down to 37°F (3°C) on temporary base depending on the situation.

In case of heating operation the condense temperature is allowed to go up to 120°F (49°C) on temporary base depending on the situation.

When the request from the indoor units becomes more moderate, the system will eventually go to the steady state condition which is defined by the operation method above.

- To activate the powerful comfort setting under cooling operation, change field setting [2-81]=3.

This setting is used in conjunction with setting [2-8] and [2-47].

- To activate the powerful comfort setting under heating operation, change field setting [2-82]=3.

This setting is used in conjunction with setting [2-9].

• **Quick**

Overshoot (during heating operation) or undershoot (during cooling operation) is allowed compared to the requested refrigerant temperature, in order to achieve the required room temperature very fast. The overshoot is allowed from the start up moment.

In case of cooling operation the evaporating temperature is allowed to go down to 43°F (6°C) on temporary base depending on the situation.

In case of heating operation the condense temperature is allowed to go up to 115°F (46°C) on temporary base depending on the situation.

When the request from the indoor units becomes more moderate, the system will eventually go to the steady state condition which is defined by the operation method above.

- To activate the quick comfort setting under cooling operation, change field setting [2-81]=2.

This setting is used in conjunction with setting [2-8] and [2-47].

- To activate the quick comfort setting under heating operation, change field setting [2-82]=2.

This setting is used in conjunction with setting [2-9].

Mild

Overshoot (during heating operation) or undershoot (during cooling operation) is allowed compared to the requested refrigerant temperature, in order to achieve the required room temperature very fast. The overshoot is not allowed from the start up moment. The start up occurs under the condition which is defined by the operation mode above.

In case of cooling operation the evaporating temperature is allowed to go down to 43°F (6°C) on temporary base depending on the situation.

In case of heating operation the condense temperature is allowed to go up to 115°F (46°C) on temporary base depending on the situation.

When the request from the indoor units becomes more moderate, the system will eventually go to the steady state condition which is defined by the operation method above.

The start up condition is different from the powerful and quick comfort setting.

- To activate the mild comfort setting under cooling operation, change field setting [2-81]=1.

This setting is used in conjunction with setting [2-8] and [2-47].

- To activate the mild comfort setting under heating operation, change field setting [2-82]=1.

This setting is used in conjunction with setting [2-9].

Eco

The original refrigerant temperature target, which is defined by the operation method (see above) is kept without any correction, unless for protection control.

- To activate the mild comfort setting under cooling operation, change field setting [2-81]=0.

This setting is used in conjunction with setting [2-8] and [2-47].

- To activate the mild comfort setting under heating operation, change field setting [2-82]=0.

This setting is used in conjunction with setting [2-9].

Example: Automatic mode during cooling

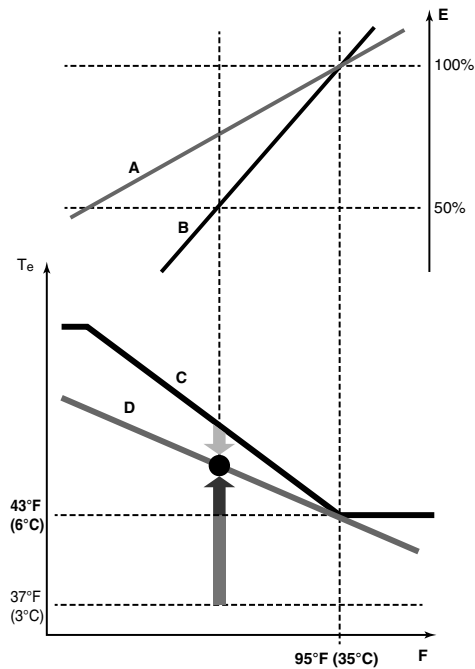

- A Actual load curve
- B Virtual load curve (initial capacity automatic mode)
- C Virtual target value (initial evaporation temperature value automatic mode)
- D Required evaporation temperature value
- E Load factor
- F Outside air temperature
- Te Evaporating temperature
- Quick
- Powerful
- Mild

Room temperature evolution:

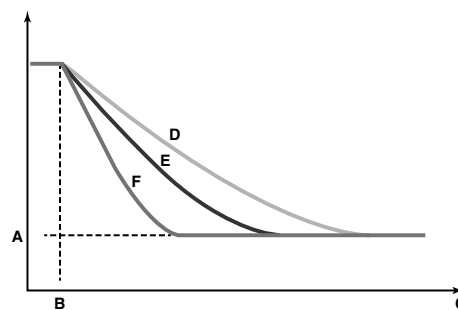

- A Indoor unit set temperature
- B Operation start
- C Operating time
- D Mild
- E Quick
- F Powerful

Example: Automatic mode during cooling

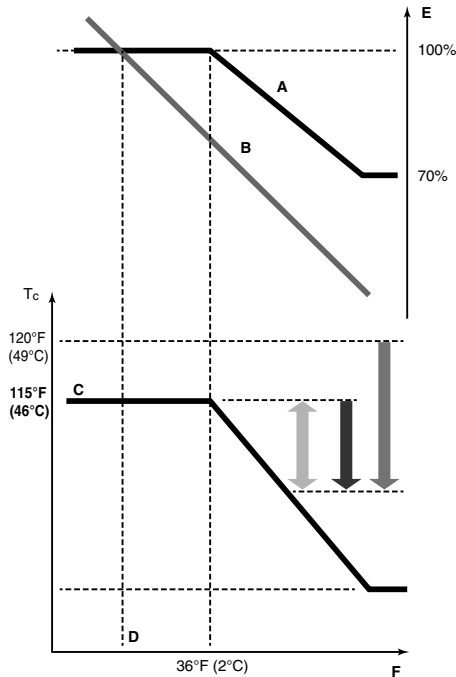

- A Virtual load curve (default automatic mode peak capacity)
- B Load curve
- C Virtual target value (initial condensation temperature value automatic mode)
- D Design temperature
- E Load factor
- F Outside air temperature
- T_c Condensing temperature
- Quick
- Powerful
- Mild

Room temperature evolution:

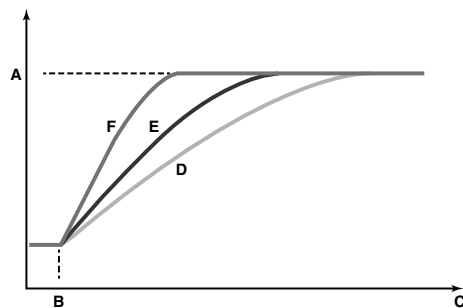

- A Indoor unit set temperature
- B Operation start
- C Operating time
- D Mild
- E Quick
- F Powerful

No matter which control is selected, variations on the behavior of the system are still possible due to protection controls to keep the unit operating under reliable conditions. The intentional target, however, is fixed and will be used to obtain the best balance between energy consumption and comfort, depending on the application type.

15.4. Test operation

After installation and once the field settings are defined, the installer is obliged to verify correct operation. Therefore a test run must be performed according to the procedures described below.

15.4.1. Precautions before starting test operation

During test operation, the outdoor units, the Branch Selector units and the indoor units will start up:

- Make sure that the preparations of all Branch Selector units and all indoor units are finished (field piping, electrical wiring, air purge, etc.). See installation manual of the Branch Selector units and the indoor units for details.

CAUTION
Do not insert fingers, rods or other objects into the air inlet or outlet. When the fan is rotating at high speed, it will cause injury.

CAUTION
Do not perform the test operation while working on the Branch Selector units and the indoor units.

When performing the test operation, not only the outdoor units, but the connected indoor units will operate as well.

Working on indoor units or Branch Selector units while performing a test operation is dangerous.

CAUTION

- During tests never pressurize the appliances with a pressure higher than the maximum allowable pressure (as indicated on the nameplate of the unit).
- If refrigerant gas leaks, ventilate the area immediately. Toxic gas may be produced if refrigerant gas comes into contact with fire.
- Never directly touch any accidental leaking refrigerant. This could result in severe wounds caused by frostbite.
- Test run is possible for ambient temperatures between -4°F and 95°F (-20°C and 35°C).

DANGER: DO NOT TOUCH PIPING AND INTERNAL PARTS
See Safety considerations on page i.

DANGER: ELECTRICAL SHOCK
See Safety considerations on page i.

- Provide a logbook and machine card.
In accordance with the applicable legislation, it may be necessary to provide a logbook with the equipment containing at least: information on maintenance, repair work, results of tests, stand-by periods, etc.

i INFORMATION

Note that during the first running period of the unit, required power input may be higher. This phenomenon originates from the compressor that requires a 50 hour run elapse before reaching smooth operation and stable power consumption. Reason is that the scroll is made out of iron and that it takes some time to smooth the surfaces that make contact.

! NOTE

To protect the compressor, be sure to turn on the power supply 6 hours before starting operation.

15.4.2. Test operation

The procedure below describes the test operation of the complete system. This operation checks and judges following items:

- Check of wrong wiring (communication check with indoor units).
- Check of the stop valves opening.
- Judgment of piping length.

On top of this system test operation, Branch Selector units and indoor units operation should also be checked separately.

- Make sure to carry out the system test operation after the first installation. Otherwise, the malfunction code U3 will be displayed on the user interface and normal operation or individual Branch Selector unit and indoor unit test run cannot be carried out.
- Abnormalities on Branch Selector units and indoor units cannot be checked for each unit separately. After the test operation is finished, check the Branch Selector units and the indoor units one by one by performing a normal operation using the user interface. Refer to the Branch Selector units and the indoor units installation manual for more details concerning the individual test run.

i INFORMATION

- It may take 10 minutes to achieve a uniform refrigerant state before the compressor starts.
- During the test operation, the refrigerant running sound or the magnetic sound of a solenoid valve may become loud and the display indication may change.
These are not malfunctions.

Procedure

- 1 Close all front panels in order to not let it be the cause of misjudgment.
- 2 Make sure all field settings you want are set; see 15.2. Monitoring function and field settings on page 31.
- 3 Turn ON the power to the outdoor units, the connected Branch Selector units and the connected indoor units.

! NOTE

Be sure to turn on the power 6 hours before operation in order to have power running to the crankcase heater and to protect the compressor.

- 4 Make sure the default (idle) situation is existing; see 13.2. Operating the push buttons and DIP switches on the printed circuit board on page 24. Push BS2 for 5 seconds or more. The unit will start test operation.

- The test operation is automatically carried out, the outdoor unit display will indicate **E3** and the indication **Test operation** and **Under centralized control** will display on the user interface of indoor units.

Steps during the automatic system test run procedure:

- **E01**: control before start up (pressure equalization)
- **E02**: cooling start up control
- **E03**: cooling stable condition
- **E04**: communication check
- **E05**: stop valve check
- **E06**: pipe length check
- **E07**: refrigerant amount check
- **E08**: detailed refrigerant situation check
- **E09**: pump down operation
- **E10**: unit stop

- During the test operation, it is not possible to stop the unit operation from a user interface. To abort the operation, press BS3. The unit will stop after ±30 seconds.

- 5 Check the test operation results on the outdoor unit segment display.

- Normal completion: no indication on the segment display (idle).
- Abnormal completion: indication of malfunction code on the segment display.
Refer to 15.4.3. Correcting after abnormal completion of the test operation to take actions for correcting the abnormality. When the test operation is fully completed, normal operation will be possible after 5 minutes.

15.4.3. Correcting after abnormal completion of the test operation

The test operation is only completed if there is no malfunction code displayed on the user interface or outdoor unit segment display. In case a malfunction code is displayed, perform correcting actions as explained in the malfunction code table. Carry out the test operation again and confirm that the abnormality is properly corrected.

i INFORMATION

Refer to the installation manual of the indoor unit for other detailed malfunction codes related to indoor units.

15.5. Malfunction code list

In case of a displayed malfunction code, perform correcting actions as explained in the malfunction code table.

After correcting the abnormality, press BS3 to reset the malfunction code and retry operation.

The malfunction code which is displayed on the outdoor unit will indicate a main malfunction code and a sub code. The sub code indicates more detailed information about the malfunction code. The malfunction code will be displayed intermittent.

Example:

Main code	Sub code
E3	01

With an interval of 1 second, the display will switch between main code and sub code.

Malfunction code		Contents	Solution
Main code	Sub code Master/sub 1		
E3	01/03	<ul style="list-style-type: none"> High pressure switch is activated. (S1PH)-A1P (X2A) High pressure switch connectors are detached. -A1P (X2A, X3A, X4A) 	<ul style="list-style-type: none"> Check stop valves situation or abnormalities in (field) piping or airflow over air cooled coil. Securely connect each connector. Refer to the wiring diagram attached to the back of the control box cover.
	02/04	<ul style="list-style-type: none"> Stop valves are closed. Refrigerant overcharge. 	<ul style="list-style-type: none"> Open stop valves. Check refrigerant amount and recharge.
	13/14	Liquid pipe stop valve is closed.	Open liquid pipe stop valve.
	18	<ul style="list-style-type: none"> Stop valves are closed. Refrigerant overcharge. 	<ul style="list-style-type: none"> Open stop valves. Check refrigerant amount and recharge.
E4	01/02	Low pressure malfunction: <ul style="list-style-type: none"> Stop valves are closed. Refrigerant shortage. Reverse connection of high/low pressure gas pipe and suction gas pipe of Branch Selector unit. 	<ul style="list-style-type: none"> Open stop valves. Check refrigerant amount and recharge.
E3	01/05	Electronic expansion valve malfunction (Y1E)-A1P (X21A)	Check connection on printed circuit board or actuator.
	03/06	Electronic expansion valve malfunction (Y2E)-A1P (X22A)	Check connection on printed circuit board or actuator.
	04/07	Electronic expansion valve malfunction (Y3E)-A1P (X23A)	Check connection on printed circuit board or actuator.
	26/27	Electronic expansion valve malfunction (Y4E)-A1P (X25A)	Check connection on printed circuit board or actuator.
	29/34	Electronic expansion valve malfunction (Y5E)-A7P (X8A)	Check connection on printed circuit board or actuator.
	31/36	Electronic expansion valve malfunction (Y6E)-A7P (X10A)	Check connection on printed circuit board or actuator.
	32/37	Electronic expansion valve malfunction (Y7E)-A7P (X11A)	Check connection on printed circuit board or actuator.
F3	01/03	Discharge temperature too high (R21T): <ul style="list-style-type: none"> Stop valves are closed. Reverse connection of high/low pressure gas pipe and suction gas pipe of Branch Selector unit. Refrigerant shortage. 	<ul style="list-style-type: none"> Open stop valves. Check refrigerant amount and recharge. Check connection of high/low pressure gas pipe and suction gas pipe.
	20/21	Compressor casing temperature too high (R14T): <ul style="list-style-type: none"> Stop valves are closed. Refrigerant shortage. 	<ul style="list-style-type: none"> Open stop valves. Check refrigerant amount and recharge.
F5	02	<ul style="list-style-type: none"> Stop valves are closed. Refrigerant overcharge. 	<ul style="list-style-type: none"> Open stop valves. Check refrigerant amount and recharge.
F3	01	Electronic expansion valve malfunction (Branch Selector units).	Check connection on printed circuit board or actuator.
	02		
	05		
H3	01/02	Temperature sensor malfunction (R1T)-A1P (X18A)	Check connection on printed circuit board or actuator.
J3	16/22	Temperature sensor malfunction (R21T)-A1P (X19A)	Check connection on printed circuit board or actuator.
	17/23		
	56/57	Temperature sensor malfunction (R14T)-A1P (X19A)	Check connection on printed circuit board or actuator.
	47/49		
48/50			
J5	01/03	Temperature sensor malfunction (R12T)-A7P (X15A)	Check connection on printed circuit board or actuator.
	18/19	Temperature sensor malfunction (R10T)-A1P (X29A)	Check connection on printed circuit board or actuator.
J5	01/02	Temperature sensor malfunction (R11T)-A7P (X15A)	Check connection on printed circuit board or actuator.
	08/09	Temperature sensor malfunction (R8T)-A1P (X29A)	Check connection on printed circuit board or actuator.
	11/12	Temperature sensor malfunction (R9T)-A1P (X29A)	Check connection on printed circuit board or actuator.

Malfunction code		Contents	Solution
Main code	Sub code Master/sub 1		
U7	01/02	Temperature sensor malfunction (R3T)-A1P (X30A)	Check connection on printed circuit board or actuator.
	06/07	Temperature sensor malfunction (R7T)-A1P (X30A)	Check connection on printed circuit board or actuator.
	18/19	Temperature sensor malfunction (R16T)-A7P (X15A)	Check connection on printed circuit board or actuator.
U8	01/02	Temperature sensor malfunction (R4T)-A1P (X30A)	Check connection on printed circuit board or actuator.
	08/09	Temperature sensor malfunction (R5T)-A1P (X30A)	Check connection on printed circuit board or actuator.
	11/12	Temperature sensor malfunction (R15T)-A7P (X15A)	Check connection on printed circuit board or actuator.
U9	01/02	Temperature sensor malfunction (R6T)-A1P (X30A)	Check connection on printed circuit board or actuator.
	11/12	Temperature sensor malfunction (R13T)-A7P (X17A)	Check connection on printed circuit board or actuator.
U8	06/08	High pressure sensor malfunction: open circuit (S1NPH)-A1P (X32A)	Check connection on printed circuit board or actuator.
	07/09	High pressure sensor malfunction: short circuit (S1NPH)-A1P (X32A)	Check connection on printed circuit board or actuator.
U7	06/08	Low pressure sensor malfunction: open circuit (S1NPL)-A1P (X31A)	Check connection on printed circuit board or actuator.
	07/09	Low pressure sensor malfunction: short circuit (S1NPL)-A1P (X31A)	Check connection on printed circuit board or actuator.
U7	14/15	Transmission trouble. 208/230, 460 V : A3P (X6A)-A1P (X28A) 575 V : A4P (X6A)-A1P (X28A)	Check connection.
	19/20	Transmission trouble. 208/230, 460 V : A5P (X3A)-A3P (X41A) 575 V : A5P (X3A)-A4P (X41A)	Check connection.
	24/25	Transmission trouble. 208/230, 460 V : A5P (X4A)-A4P (X3A) 575 V : A5P (X4A)-A6P (X3A)	Check connection.
	33/34	Transmission trouble. A7P (X2A)-A1P (X20A)	Check connection.
U1	01/02	Unbalanced power supply voltage.	Check if power supply is within the range.
U1	01/05	Power is not supplied to outdoor units or Branch Selector / indoor units (including phase loss).	<ul style="list-style-type: none"> • Check connection of power supply for outdoor / indoor units. • Correct the wiring.
	04/06		
U2	01/08	Voltage power shortage or open power supply phase.	<ul style="list-style-type: none"> • Check if power supply is within the range. • Correct phase order.
	02/09	Reversed or open power supply phase.	<ul style="list-style-type: none"> • Check if power supply is within the range. • Correct phase order.
U3	03	System test run not yet executed (system operation not possible).	Execute system test run.
	04	An error occurred during the test run.	Check the piping and re-execute the test run.
	05	Test run aborted.	Re-execute the test run.
	06		
	07	Test run aborted due to communication issues.	Check the communication wires and re-execute the test run.
U4	01	Faulty wiring to Q1/Q2 or indoor- outdoor.	Connect transmission wiring of Branch Selector units and indoor units to "TO IN/D UNIT (F1, F2)" and transmission wiring of other outdoor units to "TO OUT/D UNIT (F1, F2)".
	03	Malfunction of connected indoor unit.	Check the malfunction code of indoor unit and resolve it.

Malfunction code		Contents	Solution
Main code	Sub code Master/sub 1		
U7	01	Faulty wiring to Q1/Q2 or indoor- outdoor.	Connect transmission wiring of Branch Selector units and indoor units to "TO IN/D UNIT (F1, F2)" and transmission wiring of other outdoor units to "TO OUT/D UNIT (F1, F2)".
	02		
	03		
	11	<ul style="list-style-type: none"> Too many indoor units are connected to F1/F2 line. Faulty wiring between units. 	<ul style="list-style-type: none"> Check indoor unit amount and total capacity connected. Check connection.
U3	01	<ul style="list-style-type: none"> System mismatch. Wrong type of indoor units combined (R407C, Mini-split, etc). Indoor unit malfunction. 	Check if other indoor units have malfunction and confirm indoor unit mix is allowed.
U9	18	Connection malfunction over indoor units or type mismatch (R407C, Mini-split, etc).	Check if other indoor units have malfunction and confirm indoor unit mix is allowed.
	20	Wrong combination (different series (e.g. RXYQ and RELQ), or different type (e.g. P type and T type)).	Correct the units combination.
	27	Assembly defect of indoor, Branch Selector and outdoor units (e.g. different models, number of units or part numbers, or different series are mixed).	<ul style="list-style-type: none"> Check and modify the number of indoor units that are connected. Check the type of refrigerant for indoor and outdoor units, and replace them with adaptable indoor/outdoor units in the case of inconsistency.
	28	Different type of Branch Selector units are combined in the system. Combination of T type (BSQ-TVJ, BS-Q54TVJ) and P type (BSVQ-PVJU, BSV-Q36PVJU) cause error.	Configure the system with only T type Branch Selector units.
	31	Wrong combination of outdoor units.	Correct the units combination.
	53	<ul style="list-style-type: none"> Defect of Branch Selector units connecting position or abnormality due to wiring error. Abnormality of Branch Selector units DIP switches settings. 	<ul style="list-style-type: none"> Check that the wiring connection are correct, referring to the wiring diagram for Branch Selector units, and correct if there are any errors. Check that the DIP switches settings are correct, referring to the installation manual enclosed in Branch Selector units package, or to the "Service precautions" plate attached to the control box cover, and correct if there are any errors.
U4	01	Auto address malfunction (inconsistency)	Check if transmission wired unit amount matches with powered unit amount (by monitor mode) or wait till initialization is finished.
U5	01	Auto address malfunction (inconsistency)	Check if transmission wired unit amount matches with powered unit amount (by monitor mode) or wait till initialization is finished.
	05	Stop valves closed.	Open stop valves.

16. Operation of the unit

Once the units are installed and test operation of outdoor units, Branch Selector units and indoor units are finished, the operation of the system can start.

For operating the indoor units, the user interface of the indoor units should be switched ON. Refer to the indoor unit operation manual for more details.

17. Maintenance and service

17.1. Maintenance introduction

In order to ensure optimal operation of the unit, a number of checks and inspections should be carried out on the unit at regular intervals, preferably yearly.

This maintenance shall be carried out by the installer or service agent.

17.2. Service precautions

⚠ DANGER: DO NOT TOUCH PIPING AND INTERNAL PARTS — See Safety considerations on page i.

⚠ CAUTION —

When performing service to inverter equipment:

- Do not open the control box cover for 10 minutes after the power supply is turned off.
- Measure the voltage between terminals on the terminal block for power supply with a tester and confirm that the power supply is turned off. In addition, measure points as shown in the figure below, with a tester and confirm that the voltage of the capacitor in the main circuit is less than 50 V DC.

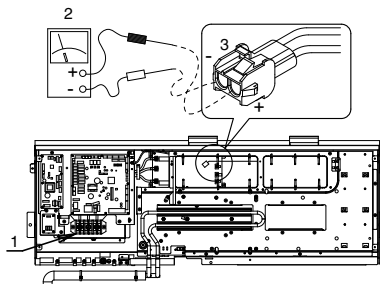
RELQ72TATJU type

- 1 Terminal block for power supply
- 2 Tester
- 3 White connector

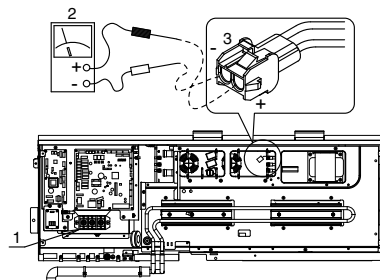
RELQ96,120TAYDU type

- 1 Terminal block for power supply
- 2 Tester
- 3 White connector

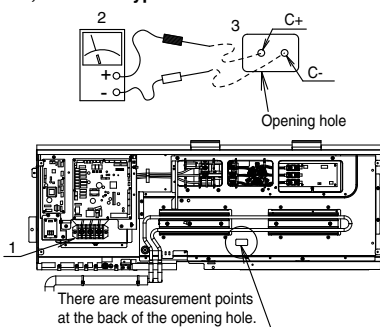
RELQ96,120TATJU type

- 1 Terminal block for power supply
- 2 Tester
- 3 Opening hole

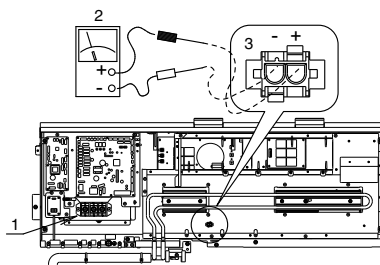
RELQ72-120TAYCU type

- 1 Terminal block for power supply
- 2 Tester
- 3 White connector

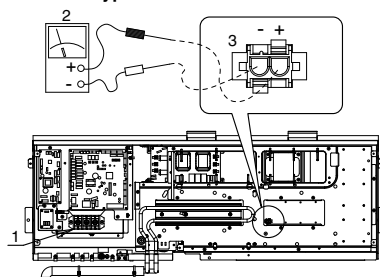
RELQ72TAYDU type

- 1 Terminal block for power supply
- 2 Tester
- 3 White connector

- 3 To prevent damaging the printed circuit board, touch a noncoated metal part to eliminate static electricity before pulling out or plugging in connectors.
- 4 Pull out junction connectors X1A, X2A (X3A, X4A) for the fan motors in the outdoor unit before starting service operation on the inverter equipment. Be careful not to touch the live parts. (If a fan rotates due to strong wind, it may store electricity in the capacitor or in the main circuit and cause electric shock.)
- 5 After the service is finished, plug the junction connector back in. Otherwise the malfunction code E7 will be displayed on the user interface or on the outdoor unit segment display and normal operation will not be performed.

For details refer to the wiring diagram labelled on the back of the control box cover.

Pay attention to the fan. It is dangerous to inspect the unit while the fan is running. Make sure to turn off the main switch and to remove the fuses from the control circuit located in the outdoor unit.

— **NOTE** —

Play it safe. For protection of the printed circuit board, touch the control box casing by hand in order to eliminate static electricity from your body before performing service.

17.3. Service mode operation

Refrigerant recovery operation/vacuumping operation is possible by applying setting [2-21]. Refer to 13.2. Operating the push buttons and DIP switches on the printed circuit board on page 24 for details how to set mode 2.

When vacuumping/recovery mode is used, check very carefully what should be vacuumped/recovered before starting. See installation manual of the indoor unit for more information about vacuumping and recovery.

17.3.1. Vacuumping method

- 1 When the unit is at standstill, set the unit in [2-21]=1.
- 2 When confirmed, the indoor units, the Branch Selector units and outdoor unit expansion valves will fully open. At that moment the segment display indication=t.01 and the user interface of all indoor units indicate TEST (test operation) and  (external control) and the operation will be prohibited.
- 3 Evacuate the system with a vacuum pump.
- 4 Press BS3 to stop vacuumping mode.

17.3.2. Refrigerant recovery operation method

This should be done by a refrigerant recovery equipment. Follow the same procedure as for vacuumping method.

18. Caution for refrigerant leaks

18.1. Introduction

The installer and system specialist shall secure safety against leakage according to local regulations or standards. The following standards may be applicable if local regulations are not available.

The VRV System, like other air conditioning systems, uses R410A as refrigerant. R410A itself is an entirely safe non-toxic, non-combustible refrigerant. Nevertheless care must be taken to ensure that air conditioning facilities are installed in a room that is sufficiently large. This assures that the maximum concentration level of refrigerant gas is not exceeded, in the unlikely event of major leak in the system and this in accordance to the local applicable regulations and standards.

Maximum concentration level

The maximum charge of refrigerant and the calculation of the maximum concentration of refrigerant is directly related to the humanly occupied space in to which it could leak.

The unit of measurement of the concentration is lbs./ft.³ (kg/m³) (the weight in lbs. (kg) of the refrigerant gas in 1 ft.³ (1 m³) volume of the occupied space).

Compliance to the local applicable regulations and standards for the maximum allowable concentration level is required.

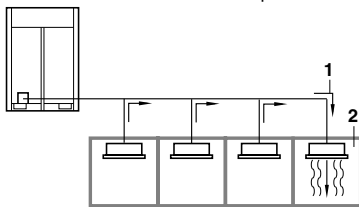

- 1 Direction of the refrigerant flow.
- 2 Room where refrigerant leak has occurred (outflow of all the refrigerant from the system).

Pay special attention to places, such as basements etc., where refrigerant could stay, since refrigerant is heavier than air.

Procedure for checking maximum concentration

Check the maximum concentration level in accordance with steps 1 to 2 below and take whatever action necessary to comply.

- 1 Calculate the amount of refrigerant (lbs. (kg)) charged to each system separately.

Amount of refrigerant in a single unit system (amount of refrigerant with which the system is charged before leav- ing the factory)	+	Additional charging amount (amount of re- frigerant added locally in accordance with the length or diameter of the refrigerant piping)	=	Total amount of refrigerant (lbs. (kg)) in the system
--	---	---	---	--

NOTE
Where a single refrigerant facility is divided into 2 entirely independent refrigerant systems then use the amount of refrigerant with which each separate system is charged.

- 2 Follow local code requirements (ASHRAE-15 2007 & ASHRAE-34 2007).

19. Disposal requirements

Dismantling of the unit, treatment of the refrigerant, of oil and of other parts must be done in accordance with relevant local and national legislation.



Warning



- Ask a qualified installer or contractor to install this product. Do not try to install the product yourself. Improper installation can result in water or refrigerant leakage, electrical shock, fire or explosion.
- Use only those parts and accessories supplied or specified by Daikin. Ask a qualified installer or contractor to install those parts and accessories. Use of unauthorized parts and accessories or improper installation of parts and accessories can result in water or refrigerant leakage, electrical shock, fire or explosion.
- Read the user's manual carefully before using this product. The user's manual provides important safety instructions and warnings. Be sure to follow these instructions and warnings.

If you have any enquiries, please contact your local importer, distributor and/or retailer.

Cautions on product corrosion

1. Air conditioners should not be installed in areas where corrosive gases, such as acid gas or alkaline gas, are produced.
2. If the outdoor unit is to be installed close to the sea shore, direct exposure to the sea breeze should be avoided. If you need to install the outdoor unit close to the sea shore, contact your local distributor.