

DGAT PROGRAM KIT 37323712001 INSTALLATION INSTRUCTIONS



FOR MODELS:

DGAM075BDD	DGAT075BDD
DGAM075BDE	DGAT075BDE
DGAM075BDF	DGAT075BDF
DGAT070BDD	DLAS075BDD
DGAT070BDE	DLAS075BDE
DGAT070BDF	DLAS075BDF

WARNING

Use of this instruction is intended for qualified individuals experienced in the proper installation and service of manufactured housing heating appliances.

Fire or explosion hazard.

Failure to properly inspect and restore appliance to proper operation may cause property damage, personal injury or loss of life.

General Information

A. Before You Start

Once you have read this instruction view the video tape.

1. Thoroughly review this instruction. Contact DGAT Program at: 1-888-665-4640 or on line at dgatprogram@york.com, if you have any questions.
2. Inspect kit contents
 - a. Three (3) piece heat exchanger liner assembly
 - i. Part A has two (2) curved hooks and four (4) stainless steel bolts.
 - ii. Parts B and C have slotted holes.
 - b. Auxiliary limit switch assembly.
 - c. Customer Packet with instructions and labels
 - d. Card board "shoehorn" for auxiliary limit switch assembly installation.
 - e. Natural gas orifice bag assembly, LP/Propane gas orifice bag assembly, and hardware bag assembly.
 - f. Wire clamps
3. Gather test equipment.
 - a. Digital Thermometer
 - b. 5/16" Hex head driver
 - c. Flashlight or droplight
 - d. Inspection mirror
 - e. Phillipshead screwdriver
 - f. Two (2) crescent wrenches
4. Tools needed to install DGAT Program Kit

- a. 1/2" Wrench
- b. 11/32" Nut driver
- c. High temperature RTV Silicone - Source 1 Part Number MA-HTSS-R

B. To Turn Off Gas to Appliance

These instructions will direct you To Turn Off Gas to Appliance during the inspection. A label with these instructions is located inside the lower door. The instructions are as follows:

1. Set the thermostat to lowest setting.
2. Turn off all power to the appliance.
3. Remove control access panel.
4. Move gas control switch to "OFF" position.

C. Operating Instructions

These instructions will direct you to follow the Operating Instructions to place the appliance in operation. A label with the Operating Instructions is located inside the lower door. The Operating Instructions are as follows:

1. Set the thermostat to lowest setting.
2. Turn off all electric power to the appliance.
3. This appliance is equipped with an ignition device which automatically lights the burner. Do NOT try to light the burner by hand.
4. Remove control access panel.
5. Move gas control switch to "OFF" position. Do not force.
6. Wait five (5) minutes to clear out any gas. If you smell gas, determine source and repair as necessary.
7. Move gas control to "ON" position. Do not force.

8. Replace control access panel.
9. Turn on all electrical power to the appliance.
10. Set thermostat to the desired setting. Burner will light, which may take 30-60 seconds.
11. After three (3) trials, if the appliance will not operate, follow the instructions TO TURN OFF GAS TO APPLIANCE and refer to troubleshooting guide in the Installation Instructions or Owner's Manual.

D. Product Specifications

Model No.	DGAT070	DGAT075
Input	70,000 Btu/hr	75,000 Btu/hr
Output	57,000 Btu/hr	61,000 Btu/hr
Air Temperature Rise Range	45-75°F	
Maximum Outlet Temperature	165°F	
Maximum External Static Pressure	0.30" wc	

Part 1: Basic Information

Record the following on the DGAT Program Claim Form. Record information clearly and legibly.

Most of this information should be available before travelling to the job site.

A. Rating Plate Data

1. Model Number

2. Serial Number

B. Customer Data

1. Customer name, street address, city, state and zip code.
2. Customer telephone number.

Part 2: Inspection

A. Inspect Roof Jack

1. Verify the proper Roof Jack is being used. The DGAT is approved for use with the 4000 Series roof jack only. See Figure 1.

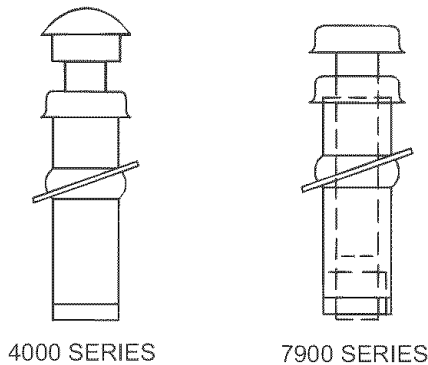

4000 SERIES

7900 SERIES

FIGURE 1: Roof Jack

NOTE: The 7900 Series Roof Jack can be converted to a 4000 Series Roof Jack by replacing crown. Use p/n 4000-6941/C.

2. Inspect Roof Jack. Replace if damaged, tilted, crooked, or shows deterioration.
3. Remove bird screens or other obstructions to combustion air inlet.

B. Remove Assembly Burner

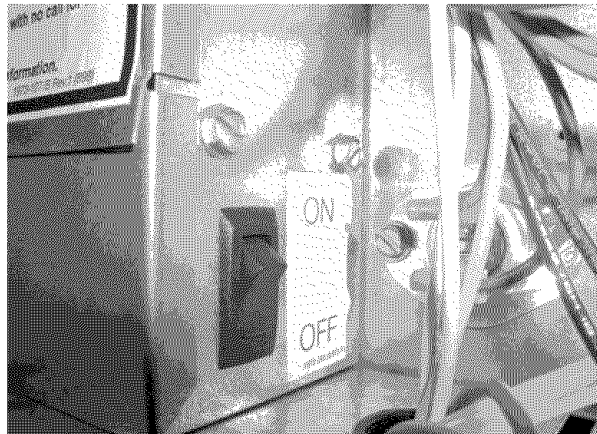

FIGURE 2: Turn power switch to off position.

1. Follow instructions TO TURN OFF GAS TO APPLIANCE.
2. Disconnect wires to gas valve, igniter, and flame sensor.
3. Turn off gas supply to furnace by closing manual shut-off valve. Disconnect gas supply piping.
4. Remove gas valve. See Figure 3.

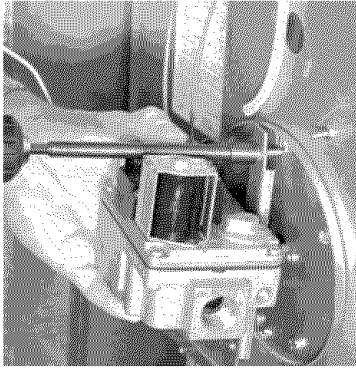

FIGURE 3: Gas valve removal

5. Remove the burner assembly. See Figure 4.

When burner is removed, check the ribbon porting, located in the end of the burner to insure it is concentric and square. Reference Figure 5. Check the seams between the burner halves to insure that they are completely closed and tight. The flame spreader needs to be checked for proper alignment and to insure that it is not distorted and the burner mounting legs should also be checked for distortion. If any of these items are found to be out of alignment, the burner should be replaced..

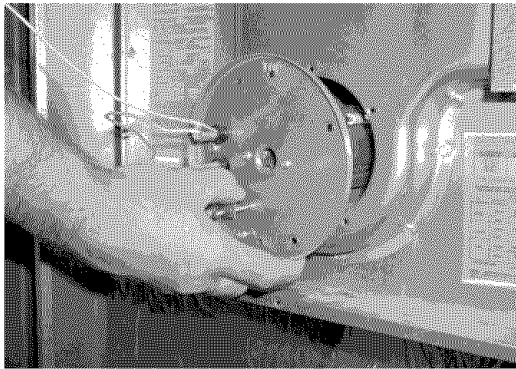

FIGURE 4: Burner assembly removal

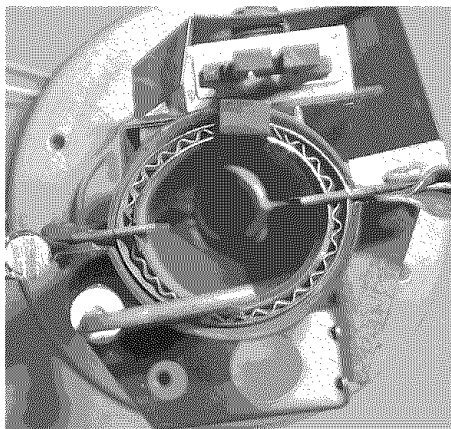

FIGURE 5: Burner inspection

C. Inspect Heat Exchanger

1. Insert inspection mirror through burner opening. Use flashlight or droplight to illuminate surface. Inspect entire interior perimeter of heat exchanger. Note condition per following guidelines.
 - a. Typical Discoloration Pattern
 - i. Surface must be smooth shape with no bumps or indentations.
 - ii. Normal heat pattern may include light to dark gray discoloration. See Figure 6.
 - iii. If visual inspection does not reveal any deformation, crack, or burn through of the heat exchanger surface, then you need to check the entire inside surface of the heat exchanger by feel. If you feel any roughness, deformation, crack or burn through, proceed with replacing the heat exchanger with 37323713001.



FIGURE 6: Typical discoloration pattern

- b. Cracked. See Figure 7.

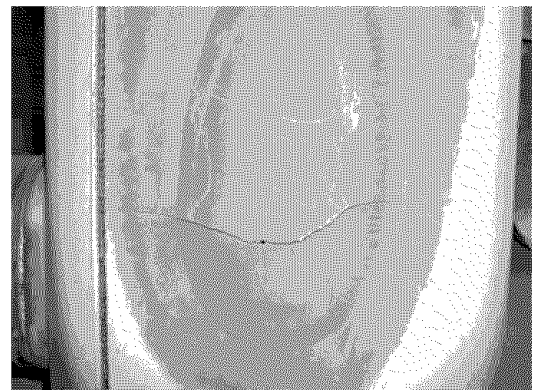

FIGURE 7: Cracked heat exchanger

- c. Deformed. See Figure 8.

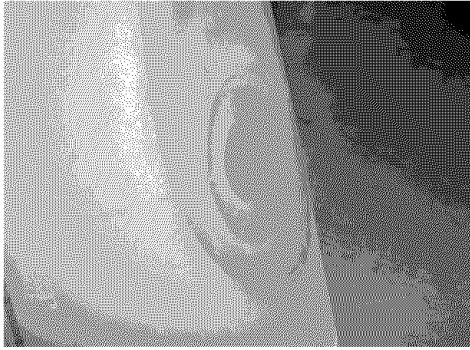

FIGURE 8: Deformed heat exchanger

d. Burn Through. See Figure 9.

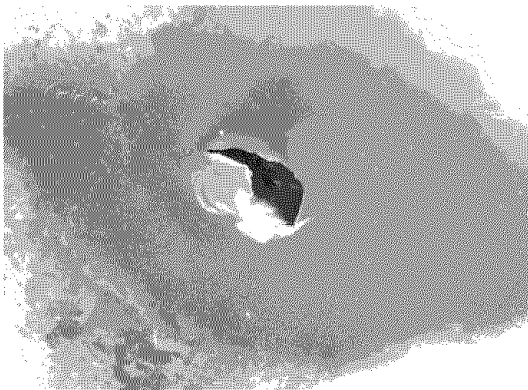

FIGURE 9: Burned through heat exchanger

While you are feeling the inside surface, you should also check the integrity of the rivets that secure the overflame baffle to the heat exchanger drum. You can check the rivets by pushing against each of the four (4) mounting legs. If any of the rivets are missing, the heat exchanger will need to be

replaced.

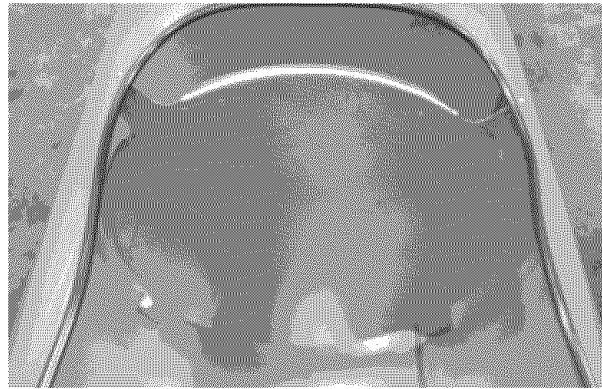

FIGURE 10: Overflame baffle located in top of heat exchanger assembly (cut-away view).

D. Corrective Actions

1. Heat Exchanger cracked, deformed or burned through or 1 or more overflame baffle pop rivets are missing. Replace heat exchanger with 37323713001 Replacement Heat Exchanger. Follow instructions provided with kit.
2. If heat exchanger burn through has resulted in damage to the furnace casing insulation and/or a breach in the furnace casing, you will need to contact the DGAT program at: 1-888-665-4640 or on line at dgat-program@york.com to receive authorization to replace furnace.
3. Heat Exchanger exhibits normal discoloration pattern with no defects.
 - a. Install DGAT Program Kit 37323712001. Follow instructions in Part 3.

Part 3: DGAT Program Kit Installation

A. Install Heat Exchanger Liner

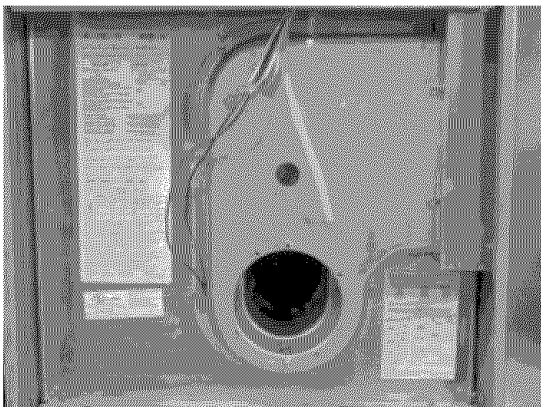

FIGURE 11: Remove pressure switch tube.

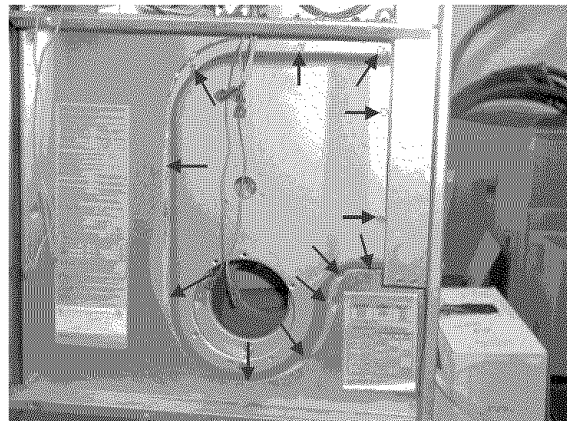

FIGURE 12: Remove burner inlet pan 12 screws as marked and remove burner inlet pan.



FIGURE 13: Remove bottom screw from air vane, loosen top screw and rotate air vane counterclockwise. Use caution when rotating air vane so that foil faced insulation is not damaged.

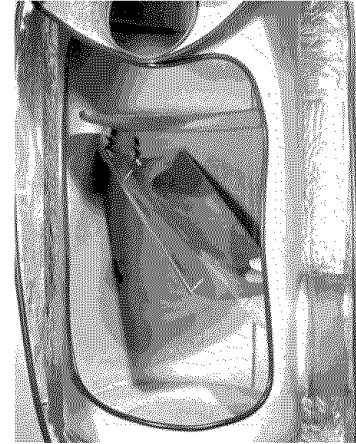

FIGURE 16: Rotate liner upward to hook on overflame baffle.



FIGURE 14: Remove burner chute mounting screws (4) and remove burner chute.



FIGURE 17: Make sure the hooks on Part A straddle the rear right-hand leg of overflame baffle.

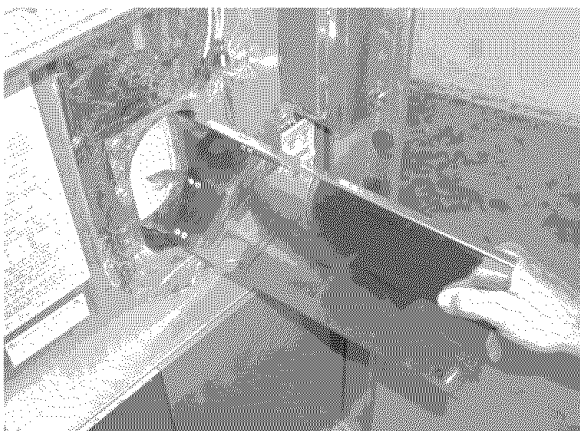

FIGURE 15: Insert stainless steel liner piece (Part A) with clips first.

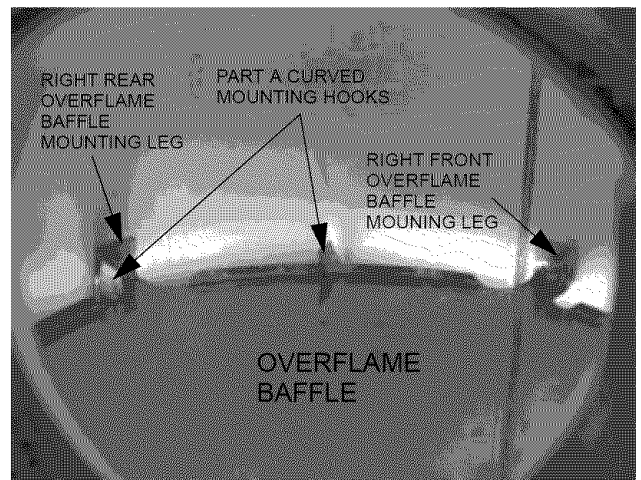

FIGURE 18: Push Part A of liner as far forward as leg will allow.

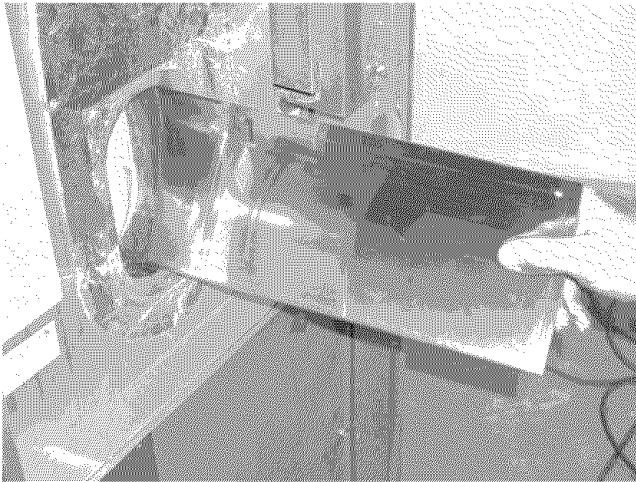

FIGURE 19: Insert Part B and rotate upwards.

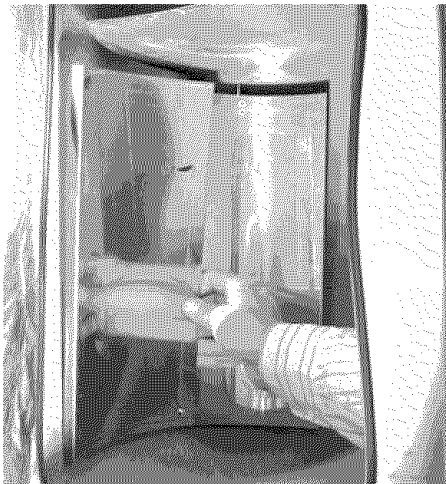

FIGURE 20: Place Part B over stud bolts in Part A.



FIGURE 21: Install stainless steel nuts found in hardware bag. Do not tighten.

Insert Part C and rotate upwards.
Place Part C over stud bolts in Part A.
Install stainless steel nuts.

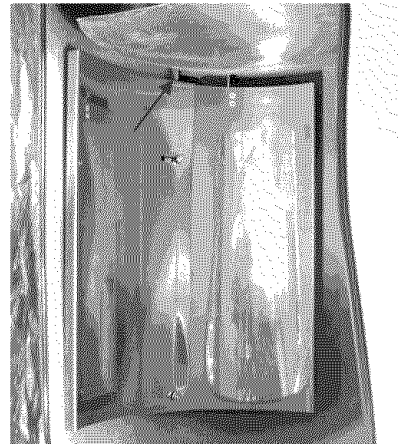

FIGURE 22: Again push assembled liner as far to front as possible and tighten all (4) stainless steel nuts.

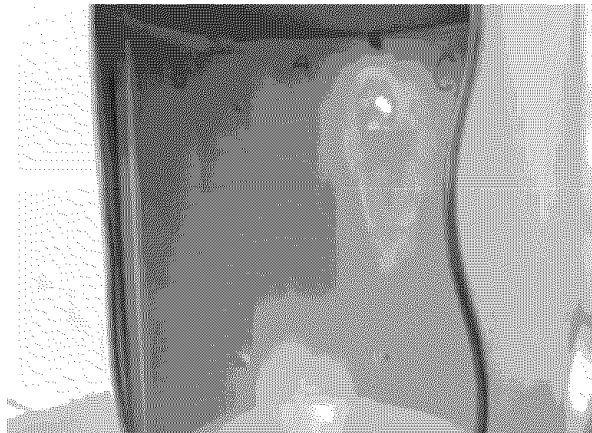

FIGURE 23: Inspect with light to make sure Part A, B, and C are pushed outward against drum.

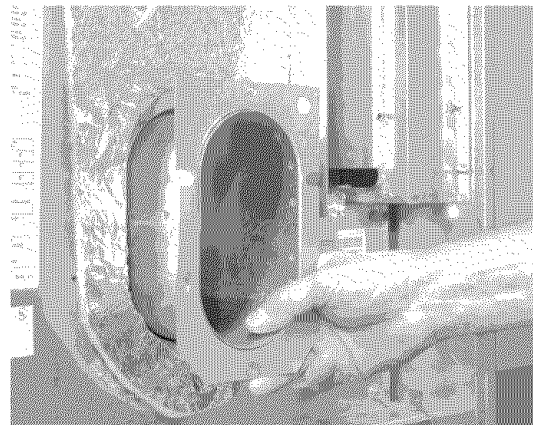

FIGURE 24: Reinstall burner chute to original position.



FIGURE 25: Reposition air vane to original position. Reinstall bottom screw and tighten top screw.

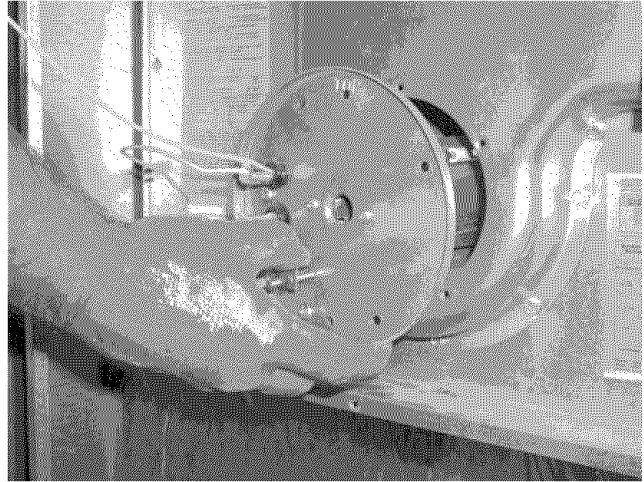

FIGURE 28: Reinstall burner.

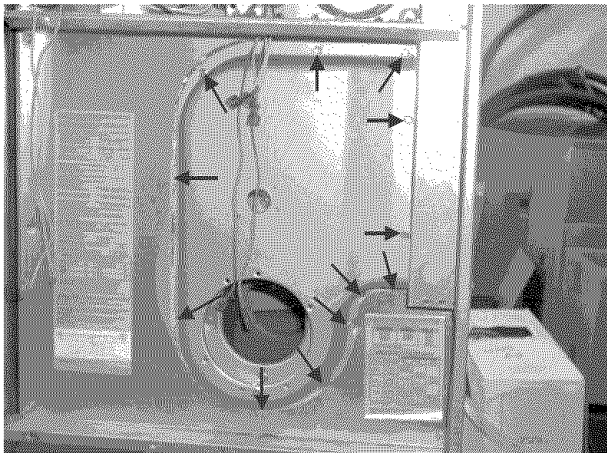

FIGURE 26: Install burner inlet pan with 12 screws. If needed, re-seal pan with high temperature RTV silicone.

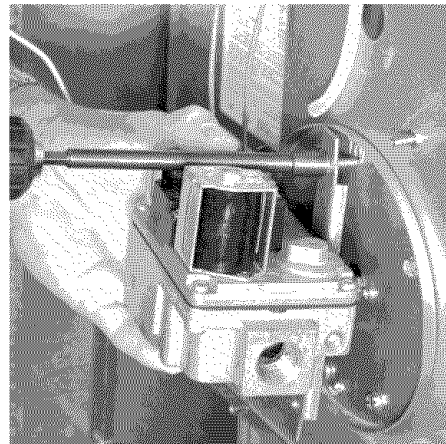

FIGURE 29: Reinstall gas valve and gas piping.

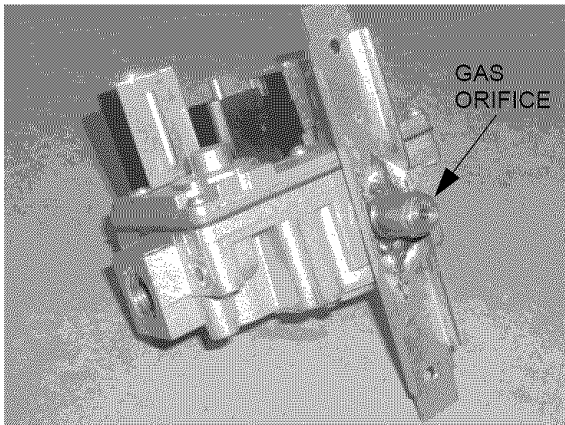

FIGURE 27: Remove old gas orifice, install new per chart.

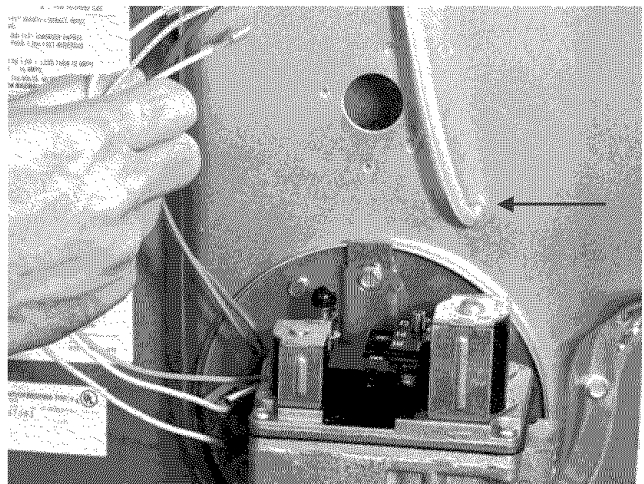

FIGURE 30: Reconnect pressure tube to pressure switch and wiring connectors to gas valve, igniter and sensor.

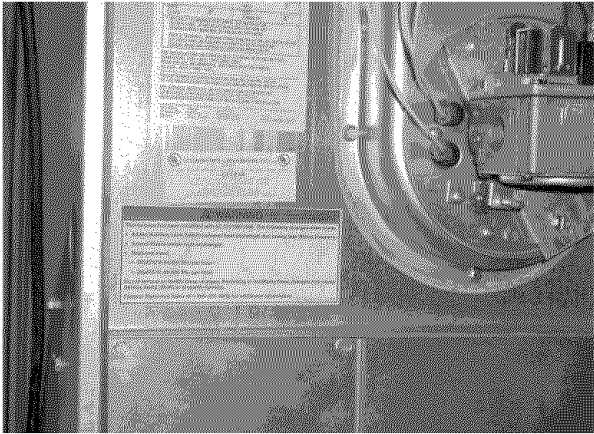

FIGURE 31: Install warning label directly below rating plate on vestibule panel.

B. Install Auxiliary Limit Switch Assembly

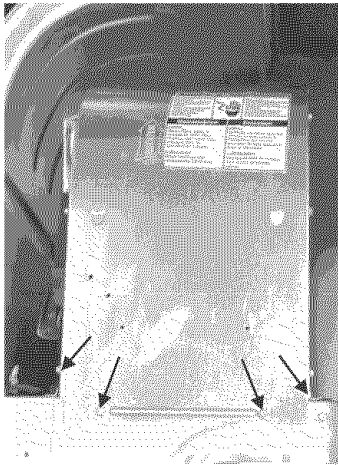

FIGURE 32: Remove Blower Assembly Mounting Screws (4). Unplug blower motor from control box. Remove wire clamp. Remove blower assembly.

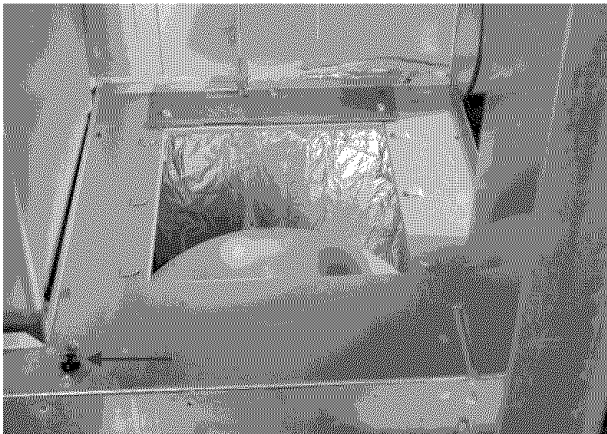

FIGURE 33: Remove wires from upper limit.

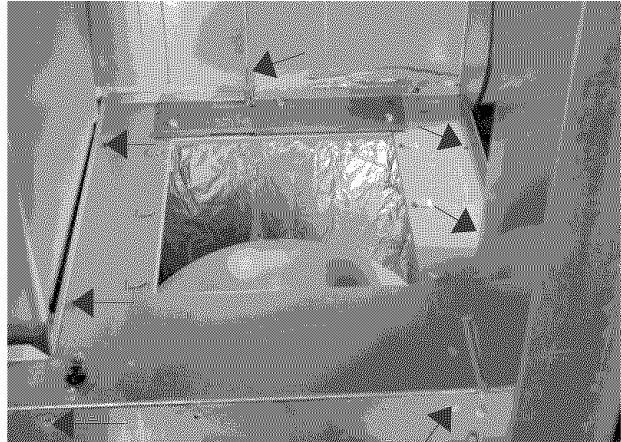

FIGURE 34: Remove blower support shelf (7 screws).

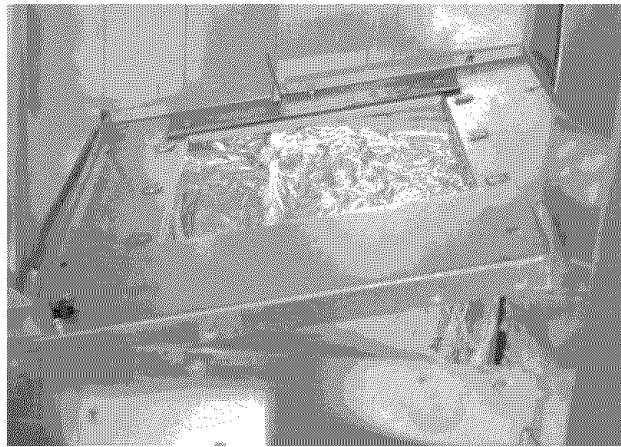

FIGURE 35: Remove blower support shelf.

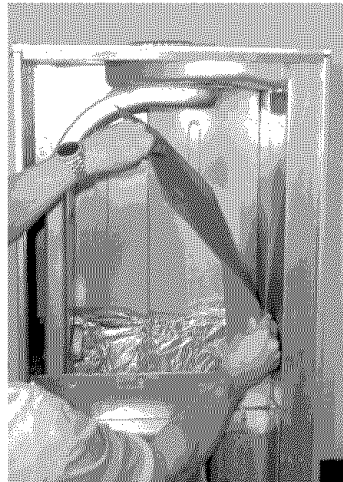

FIGURE 36: To protect side wall insulation insert cardboard sheet as a "shoe horn" to insert auxiliary limit switch assembly between insulation and heat exchanger.



FIGURE 37: Bow back plate of auxiliary limit switch assembly to insert on right-hand side of blower compartment.

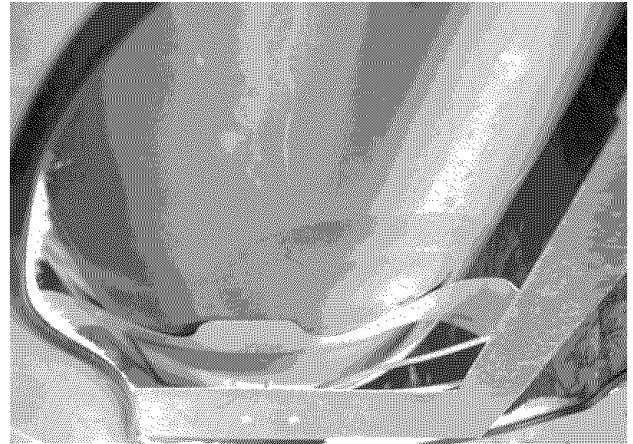

FIGURE 40: Outer plate should compress against side casing foil (Cut-away view).

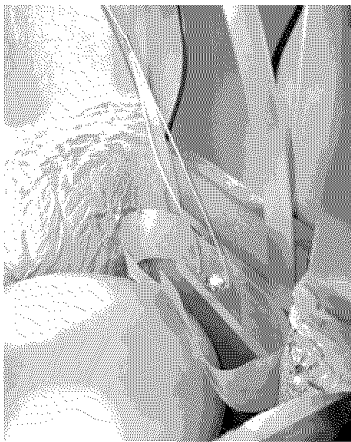

FIGURE 38: Compress stainless loop in middle to slide past heat exchanger. Do not skin or scrape foil from insulation while sliding switch down side of heat exchanger.



FIGURE 41: Push flange in until clearance holes line up with holes in blower shelf support bracket (Cut-away view).



FIGURE 39: Remove "shoe horn".

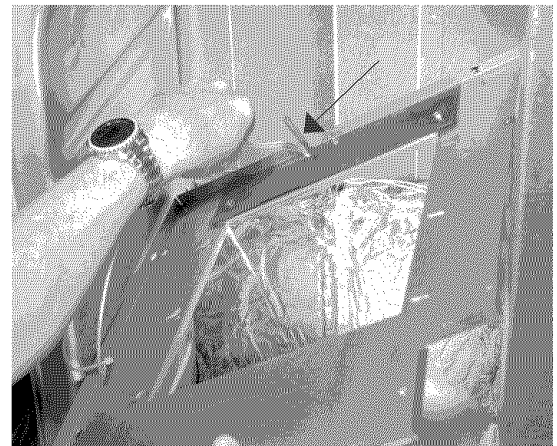

FIGURE 42: Reinstall blower shelf. Pass wires up through back slot of blower shelf before locating to final position.

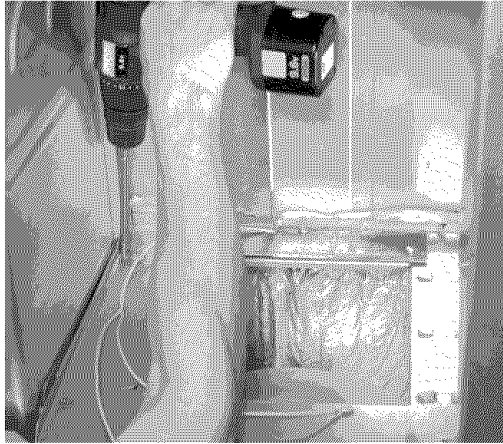

FIGURE 43: Install new wire clamp in blower shelf hole on rear left-hand side of shelf. Reinstall (7) screws to secure blower shelf.

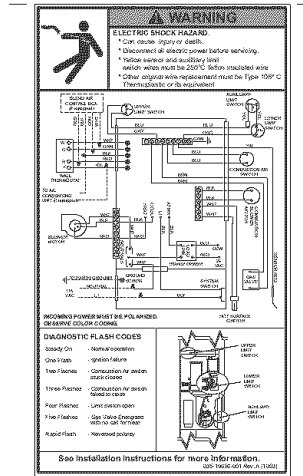

FIGURE 46: Install new wiring diagram over existing diagram.

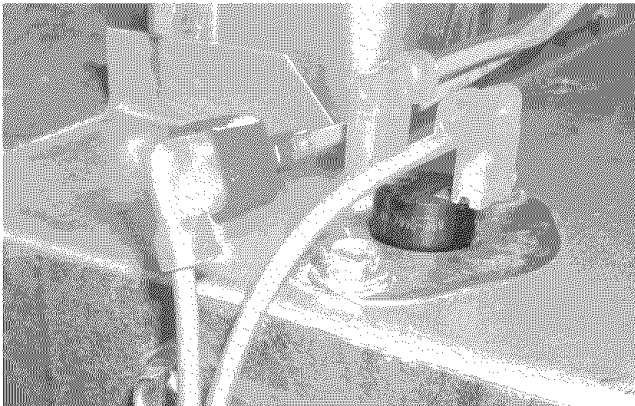

FIGURE 44: Install new auxiliary limit switch leads in series with upper limit per wiring diagram.

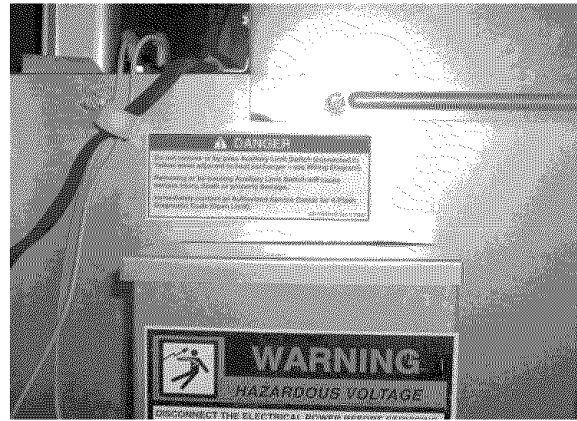

FIGURE 47: Install danger label on vestibule panel just below upper limit switch.



FIGURE 45: Install and secure blower on shelf. Plug blower motor into control box.

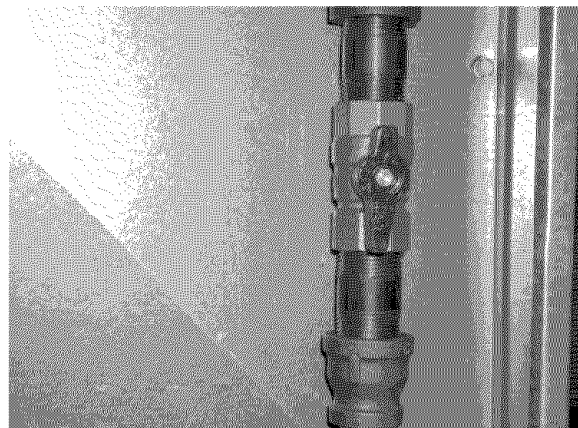

FIGURE 48: Turn gas supply back on and leak check gas valve piping connection.

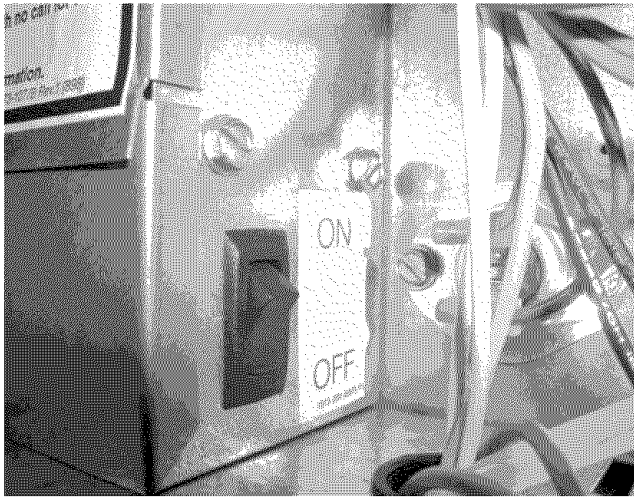

FIGURE 49: Turn electrical back on.



FIGURE 50: Install Consumer Notice on top front furnace door and instruct the consumer on how to properly maintain their furnace.

DGAT Field Inspection Program

Gas Orifice Selection Chart

Elevation	Natural Gas			LP/Propane		
	Diameter	Drill Size	Part No.	Diameter	Drill Size	Part No.
Sea Level	.1520	24	9951-1521	.0935	42	9951-0931
2,000	.1495	25	9951-1491	.0935	42	9951-0931
3,000	.1495	25	9951-1491	.0890	43	9951-0891
4,000	.1470	26	9951-1471	.0890	43	9951-0891
5,000	.1440	27	9951-1441	.0890	43	9951-0891
6,000	.1440	27	9951-1441	.0860	44	9951-0861
7,000	.1405	28	9951-1401	.0860	44	9951-0861
8,000	.1360	29	9951-1361	.0820	45	9951-0821
9,000	.1360	29	9951-1361	.0810	46	9951-0810
10,000	.1285	30	9951-1281	.0785	47	9951-0781

Part 4: Checkout Data

A. Furnace Checkout

1. Verify Cardboard Pad "Shoehorn" was removed.



Remove Cardboard Pad "Shoehorn" before operating furnace.

Fire Hazard.

Failure to remove may cause property damage, personal injury or loss of life.

2. Check Air Temperature Rise (ATR).
 - a. Make sure furnace has operated for at least 5 minutes.
 - b. Measure return air temperature at top louver openings of top furnace door.
 - c. Measure supply air temperature at the closet register/grille.
 - d. Subtract the return air temperature from the supply air temperature to obtain the ATR.
3. If measured ATR is outside parameters shown on the furnace rating plate, then you will need to determine why unit is operating beyond its design parameters. If the ATR is too low, it is an indication of an underfired furnace. Make sure that your gas pressure is set properly. If the ATR is too high, it is an indication of

an overfired furnace. Once again, you will need to make sure that your gas pressure is set properly. If found to be okay, you should then also clock the meter to determine the units firing rate, and if needed, check the supply duct system static pressure. Refer to Part 5 for information on how to measure gas pressure, determine the firing rate and measure supply static pressure.

If any items tested result in findings outside the design parameters listed on the units rating plate, it is an indication of application/installation problems that must be addressed. Since application/installation problems are not covered under the warranty, you will need to discuss this situation with the homeowner as they will be responsible for covering any charges to correct any problems found.

4. If measured ATR is within design parameters, proceed to step B and complete your on-site visit.

B. Complete On-Site Visit

1. Verify all gas-fueled appliances are returned to normal operation. Follow instructions provided by the appliance manufacturer.
2. Complete the DGAT Program Claim Form.
 - a. Record your name and company information.
 - b. Obtain homeowner's signature.
 - c. Sign claim form to certify the furnace has been properly upgraded.
3. Review the Consumer Notice with the customer.

Part 5: Additional Testing Procedures

A. Measure Gas Pressure

- a. Remove gas valve OUT PRESS TAP plug using 3/16" Allen wrench. Install 1/8 NPT hose barb fitting. See Figure 51.

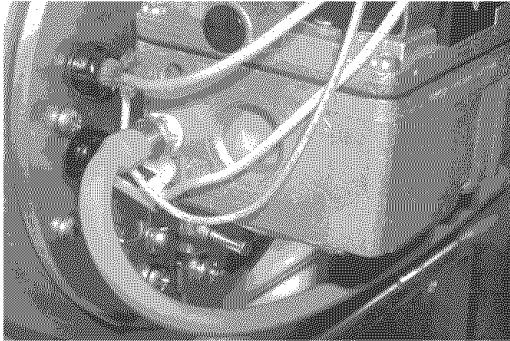

FIGURE 51: Pressure tap

- b. Connect manometer positive (+) pressure hose fitting to OUT PRESS TAP hose barb fitting.
 - c. Follow OPERATING INSTRUCTIONS to place furnace in operation.
 - d. Allow burner to operate 30-60 seconds. Measure Outlet (Manifold) Gas Pressure. Adjust pressure to 3.5" ± 0.2 w.c. for natural gas, or 10.0" ± 0.2 w.c. for LP/propane.
 - e. Follow instructions TO TURN OFF GAS TO APPLIANCE.
 - f. Remove hose barb from gas valve. Install plug.
4. Follow OPERATING INSTRUCTIONS to place furnace in operation.
 5. Operate furnace through at least one (1) complete heating cycle to confirm proper operation.

B. Measure Input Rate

1. Adjust controls on all other gas-fired appliances to prevent operation. Extinguish pilot(s), if applicable. Follow instructions provided by the appliance manufacturer.
2. Follow OPERATING INSTRUCTIONS to place furnace in operation.

3. Allow burner to operate 5 minutes.
4. Measure time required (in seconds) for gas meter 2 cubic foot dial to rotate one complete turn (or 1/2 cubic foot dial to rotate 4 complete turns).
5. Calculate input:

$$\text{Input} = \frac{[\text{Gas Heating Value}]^2 \times 7200}{\text{Time}}$$

2. Assume 1030 BTU per cubic foot for natural gas if gas supplier cannot provide exact value.

C. Measure Static Pressure

1. Verify upper door is installed and furnace burner and blower are operating in heating speed.
2. Supply Static Pressure.
 - a. Remove top screws from coil cabinet cover plates (3 total).
 - b. Connect manometer positive (+) pressure hose fitting to Static Pressure Probe.
 - c. Insert static pressure probe into each screw hole. Insert probe straight into hole 6". Probe must be level (horizontal) for proper measurement. See Figure 52.

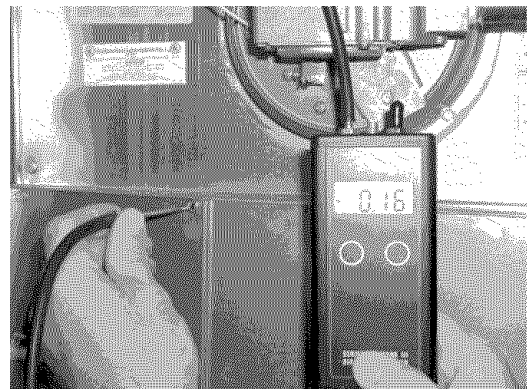

FIGURE 52: Measuring supply static pressure

Part 6: Submit Claim

A. Mail Documentation

1. Submit original DGAT Program Claim to:
York International
Attn: Warranty Dept.
P.O. Box 385
Norman, OK 73070

NOTES

NOTES

NOTES