

Quick Reference Guide

JANUARY 2014



American Standard[®]
HEATING & AIR CONDITIONING

IF YOU'D LIKE A PRODUCT NAMING SYSTEM THAT'S CLEAR, CONCISE AND EFFECTIVE,

IT'S TIME.



American Standard Heating & Air Conditioning is pleased to introduce a new product identification system that will help make your sales process more convenient, and help customers better understand the features and benefits of their products.

NEW NAMES FOR THE QUALITY, TRUST AND RELIABILITY YOU'VE ALWAYS KNOWN.

Based on feedback from dealers and distributors across the country, American Standard Heating & Air Conditioning updated their naming structure to remove SEER and AFUE designations from product names. In doing so, and by introducing in its place a consumer-friendly tiered naming system, you will be able to sell on the true benefits of the product, while giving customers clear differentiation between good, better and best. This also provides new opportunities to upsell by grouping components together as complete packages. The naming update is a rolling change that began with the launch of the new americanstandardair.com in Q4 2010. Many updates to literature, badging and other materials have been completed, and others will continue to occur over the next few months.

SERIES

American Standard Platinum Series™ The greatest number of features and the best possible performance.

American Standard Gold Series™ The best blend of performance, features and value.

American Standard Silver Series™ The most cost-effective way to enjoy comfort and reliability.

EFFICIENCY

Z = Highest efficiency
X = Mid-range efficiency
S = Standard efficiency

COMFORT

V = Variable-speed motor
M = Two-stage or multi-stage motor
I = Single-stage motor

PRODUCT NAME	FORMERLY KNOWN AS
GAS/ELECTRIC	
Platinum ZM Gas/Electric System	Triumph® 4YCZ6 Gas/Electric System
Gold XM Gas/Electric System	Triumph® 4YCY4 Gas/Electric System
Silver SI+ Gas/Electric System	Triumph® 4YCX3 Gas/Electric System
Silver SI Gas/Electric System	American Standard 4YCC3 Gas/Electric System
ALL ELECTRIC	
Platinum ZM Heat Pump System	Heritage® 4WCZ6 Heat Pump System
Gold XM Heat Pump System	Heritage® 4WCY4 Heat Pump System
Gold SI Heat Pump System	Heritage® 4WCX3 Heat Pump System
Silver SI+ Heat Pump System	American Standard 4WCC3 Heat Pump System
Silver SI Heat Pump System	American Standard WCH/ WCK Heat Pump System
A/C ONLY	
Platinum ZM Air Conditioner	Allegiance® 4TCY4 All-In-One Air Conditioner
Gold XM Air Conditioner	Allegiance® 4TCX3 All-In-One Air Conditioner System
Silver SI+ Air Conditioner	American Standard 4TCC3 All-In-One Air Conditioner System
Silver SI Air Conditioner	American Standard TCK All-In-One Air Conditioner System
HYBRID	
Platinum ZM Hybrid Comfort System	Heritage Hybrid™ Comfort System 4DCZ6
Gold XM Hybrid Comfort System	Heritage Hybrid™ Comfort System 4DCY4
AccuLink™ Platinum ZV Control	N/A
AccuLink™ Remote Control	N/A
Gold ZM Control	900 Family 7-day Digital Programmable Comfort Control
Gold XM Control	800 Family 7-day Digital Programmable Comfort Control
Silver XI Control	600 Family 5/2 Digital Programmable Comfort Control
Silver SI+ Control	400 Family Digital Non-Programmable Comfort Control
Silver SI Control	200 Family Digital Non-Programmable Comfort Control

PACKAGED SYSTEMS

CONTROLS

PRODUCT NAME	FORMERLY KNOWN AS
AIR CONDITIONERS	
Platinum ZM Air Conditioner	Allegiance® 20 Air Conditioner
Platinum XM Air Conditioner	Allegiance® 16 Air Conditioner
Gold XI Air Conditioner	Allegiance® 15 Air Conditioner
Gold SI Air Conditioner	Allegiance® 13 Air Conditioner
Silver XI Air Conditioner	American Standard 14 Air Conditioner
Silver SI Air Conditioner	American Standard 13 Air Conditioner
Silver SI Air Conditioner	N/A
HEAT PUMPS	
Platinum ZM Heat Pump	Heritage® 20 Heat Pump
Platinum XM Heat Pump	Heritage® 16 Heat Pump
Gold XI Heat Pump	Heritage® 15 Heat Pump
Gold SI Heat Pump	Heritage® 13 Heat Pump
Silver XI Heat Pump	American Standard 14 Heat Pump
Silver SI Heat Pump	American Standard 13 Heat Pump
FURNACES	
Platinum ZV Furnace	Freedom® 95 Comfort-R™ Variable Speed, Modulating Communicating Furnace
Gold ZM Furnace	Freedom® 95 Comfort-R™ Variable Speed Furnace
Gold XM Furnace	N/A
Gold XI Furnace	N/A
Silver ZI Furnace	Freedom® 95 Single-Stage Furnace
Silver SI Furnace	American Standard 90 Furnace
Platinum SV Furnace	Freedom® 80 Comfort-R™ Variable Speed Communicating Furnace
Gold SV Furnace	Freedom® 80 Comfort-R™ Furnace
Gold SM Furnace	Freedom® 80 Two-Stage Furnace
Silver XI Furnace	Freedom® 80 High Efficiency Single-Stage Furnace
Silver SI+ Furnace	Freedom® 80 Single-Stage Furnace
Silver SI Furnace	American Standard 80 Furnace
Platinum XV Oil Furnace	Freedom® 80 Comfort-R™ Variable Speed Oil Furnace
Silver SI Oil Furnace	Freedom® 80 Single-Stage Oil Furnace
FOREFRONT™ AIR HANDLERS	
Platinum ZV Air Handler	N/A
Platinum XV Air Handler	N/A
Gold SI Air Handler	N/A
Gold XI Air Handler	N/A
Silver SI Air Handler	N/A

AIR CONDITIONERS

HEAT PUMPS

FURNACES

FOREFRONT™ AIR HANDLERS

Contents - Residential

Model Nomenclature	TOC-6
Connected Home Solutions	
• Conventional 24 Volt Connected Controls.....	CHS-1
• AccuLink™ Communicating Connected Controls	CHS-2
• NEXIA™ Compatible Accessories	CHS-3
• AccuLink™ Control	CHS-4
• NEXIA™ Accessories	CHS-5
• NEXIA™ Sensors	CHS-9
• Remote Sensors	CHS-10
• Home Energy Management eMonitor™ Hardware & Accessories	CHS-11
Split System Cooling	
• Single Phase, 2-5 Tons (4A7V0, 4A7V8)	SC-1
• Single Phase, 1½-5 Tons (4A7Z0, 4A7A6, 4A7A7, 4A7A3).....	SC-3
• Single Phase, 1½-5 Tons (4TTB6, 4TTB3, 4TTM3).....	SC-5
• Three Phase and R-22 (4TTA3, 2TTB3, 2TTM3).....	SC-7
Split System Heat Pumps	
• Single Phase, 2-5 Tons (4A6V0, 4A6V8)	SH-1
• Single Phase, 1½-5 Tons (4A6Z0, 4A6H7, 4A6H3, 4A6H5)	SH-3
• Single Phase, 1½-5 Tons (4TWB4, 4TWB3).....	SH-5
• Three Phase and R-22 (2TWB3, 4TWA3)	SH-7
Air Handlers/Heaters	
• Multi-position Chart.....	AH-1
• Features and Benefits.....	AH-2
• Series 7 & 8 Variable Speed Multi-Position, 2-5 Tons (TAM7, TAM8).....	AH-3
• Series 4 Multi-Position, Single Phase, 1½-5 Tons (TAM4)	AH-6
• Series 5 Multi-Position, Single Phase, 1½-5 Tons (GAM5)	AH-8
• Series 2 Split System, Single Phase, 1½-5 Tons (GAF2, GAM2, GAT2)	AH-10
• Heaters for Multi-Position	AH-12
• Series 3 Split System, Single Phase, 1½-5 Tons (TEM3)	AH-15
• Heaters for Series 3	AH-16
• Silver Series Convertible (4FWC, 4FWH)	AH-17
• Silver Series Stud Mount (4FWM)	AH-18
• Silver Series Furr-Down (4FWD, 4FWF).....	AH-19
• Silver Series Heaters	AH-20
• Single Phase, 1½-5 Tons (4TEC).....	AH-22
• Split System and Convertible Heaters	AH-23
Coils	
• Split System Aluminum Cased Heat Pump and Cooling (4TXC-CC, 4TXC-BC, 4NXC-AC, 4NXC-AS).....	COIL-1
• Split System Aluminum Uncased Heat Pump and Cooling (4TXA-BC, 4NXA-AC)	COIL-2
• Split System Aluminum Cased Heat Pump and Cooling (4CXC-CC, 4CXC-DC, 4TXF)	COIL-3
• Split System Cased/Uncased Coil Enclosures & Features	COIL-4
• Silver Series Cased & Uncased Cooling (4FXC, 4FXA)	COIL-5
• Silver Series Flat & Horizontal Cooling (4FXFH, 4FXCH)	COIL-6

.....
This publication is for general reference information only and is not intended for systems equipment / combination selections.

Products listed in this book are not always carried in factory/distributor inventory, nor are all products available through all distribution channels. Consult your Distributor for availability and shipping information.

Since American Standard Heating & Air Conditioning has a policy of continuous product improvement, it reserves the right to change design and specification without notice.

.....

Contents - Residential

Furnaces

- Platinum ZV, Gold ZM, Gold XM, Silver ZI, Gold XI & Silver SI
 - Airflow Directions FUR-1
- Platinum ZV Modulating Communicating Variable Speed (AUHM, ADHM) FUR-2
- Gold ZM Two Stage Variable Speed (AUH2, ADH2) FUR-2
- Gold XM Two Stage (AUH2, ADH2) FUR-3
- Silver ZI Single Stage (AUH1, ADH1) FUR-3
- Gold XI Single Stage w/ High Efficiency Motor (AUH1-H, ADH1-H) FUR-4
- Silver SI Single Stage (AUC1, ADC1) FUR-4
- Platinum ZV, Gold ZM, Gold XM, Silver ZI, Gold XI & Silver SI
 - Features & Accessories FUR-5
- Special Use Furnace Accessories FUR-7
- Platinum SV, Gold SV, Gold SM, Silver XI, Silver SI+ & Silver SI
 - Airflow Directions FUR-8
- Platinum SV Two Stage Variable Speed (AUD2-ACV, ADD2-ACV) FUR-9
- Gold SV Two Stage Variable Speed (AUD-A-V-V, ADD-A-V-V) FUR-9
- Gold SM Two Stage (AUD2, ADD2) FUR-10
- Silver XI Single Stage w/ High Efficiency Motor (AUD1-H, ADD1-H) FUR-10
- Silver SI+ Single Stage (AUD1, ADD1) FUR-11
- Silver SI Single Stage (AUE1, ADE1) FUR-12
- Platinum SV, Gold SV, Gold SM, Silver XI, Silver SI+ & Silver SI
 - Features & Accessories FUR-13
- Special Use Furnace Accessories FUR-14
- High Efficiency Oil Furnaces Ordering Information FUR-15

Indoor Air Quality

- AccuClean™ Whole Home Air Cleaner (AFD) IAQ-1
- Perfect Fit™ Media Filters (TFM) IAQ-2
- Perfect Fit™ Filter Accessories IAQ-3
- AccuClean™ Filters IAQ-4
- Humidifiers Fan Powered and Bypass IAQ-6
- Energy Recovery Ventilator (ERV) IAQ-9

Comfort Controls/Zone Sensors

- Conventional 24 Volt Connected Controls CCZS-1
- AccuLink™ Communicating Connected Controls CCZS-2
- Zoning AccuLink™ Platinum ZV Control Features (AZONE950) CCZS-3
- Zoning Communicating Sensor with Display Features (AZONE940) CCZS-4
- Conventional 24 Volt HVAC System Interface Relay Panel for
 - AccuLink™ Platinum ZV Control CCZS-5
- AccuLink™ Platinum ZV Control Component Overview CCZS-6
- AccuLink™ Zoning Assembly & Zone Expander Panel CCZS-7
- AccuLink™ Zoning Component Overview CCZS-8
- 24 Volt Modulating Dampers CCZS-10
- Programmable 7 Day CCZS-15
- Programmable 5/2 Day CCZS-16
- Non-Programmable CCZS-17
- Remote Sensors CCZS-18
- Indoor Fan Delay Relay Kit & Outdoor Thermostat Kit CCZS-19

Contents - Residential

Packaged Units

- Cooling Convertible, 1½-5 Tons (4TCY4, 4TCX3, 4TCC3)..... PK-1
- Cooling Convertible, 1½-5 Tons Features & Accessories PK-2
- Cooling Convertible, 1½-5 Tons Heaters..... PK-4
- Heating Convertible, 2-5 Tons (4WCZ6, 4DCZ6)..... PK-5
- Heating Convertible, 2-5 Tons (4WCY4, 4DCY4)..... PK-6
- Heating Convertible, 2-5 Tons Features & Accessories PK-7
- Heating Convertible, 1½-5 Tons (4WCX3, 4WCC3)..... PK-9
- Heating Convertible, 1½-5 Tons Features & Accessories PK-10
- Heating Convertible, 1½-5 Tons Heaters PK-12
- Heating Over/Under 2-5 Tons (4WHC3) PK-13
- Gas/Electric Convertible, 2-5 Tons (4YCZ6, 4YCY4)..... PK-14
- Gas/Electric Convertible, 2-5 Tons Features & Accessories PK-15
- Gas/Electric Convertible, 1½-5 Tons (4YCX3)..... PK-17
- Gas/Electric Convertible, 1½-5 Tons (4YCC3)..... PK-18
- Gas/Electric Convertible, 1½-5 Tons Features & Accessories PK-19

Geothermal

- Variable Speed Packaged Units (AVGX)..... GEO-1
- Water to Air Packaged Units (1GX-2GX) GEO-4
- Water to Water Packaged Units (1GW, 2GW)..... GEO-7
- HydroZone™ Control GEO-10
- Triple Function Hybrid Water to Air Systems (GY)..... GEO-11
- Split Heat Pump Units (2GN, GE)..... GEO-13
- Split and Hydronic Air Handlers (TAMG, AGA) GEO-16
- Coils (GCX)..... GEO-16
- Standard Accessories GEO-20

Ductless

- Mini-Split Single Phase, ½-3 Tons (4TXK, 4MXW, 4TYK, 4MYW)..... DU-1
- Multi-Split Single Phase, ½-3 ½ Tons
(4TXM, 4MXW, 4MXC, 4MXL, 4MXF, 4MXD, 4MXX)..... DU-2
- Mini-Split & Multi-Split Features & Accessories DU-3

Accessories/Information

- Roof Curbs (BAYCURB050A, BAYCURB051A) AC/IN-1
- Thermal Expansion Valves..... AC/IN-2
- Equipment Date Identification AC/IN-4
- Refrigerant Line Sets AC/IN-5
- Refrigerant HFC 410A (R-410A)..... AC/IN-6
- Refrigerant Piping Information for Two Stage Split Systems..... AC/IN-7
- Split systems with Variable Speed Compressor..... AC/IN-8
- Branch Circuit Wire Sizing Table/Heater De-Rating Chart AC/IN-11
- Basic Air Conditioning Formulas AC/IN-12
- Low Ambient Accessories, Cooling & Heating Models AC/IN-13
- Wind Shields AC/IN-14

Contents - Light Commercial

Model Nomenclature	LTOC-15
Split System Cooling	
• Three Phase, 6-25 Tons, R-410A (TTA)	LSC-1
• ReliaTel™ Controls, 6-25 Tons - Protection/Operation Timings and Features	LSC-5
Split System Heat Pumps	
• Three Phase, 6-20 Tons, R-410A (TWA)	LSH-1
• ReliaTel™ Controls, 6-20 Tons - Protection/Operation Timings and Features	LSH-5
Air Handlers/Heaters	
• Single Phase 5-10 Tons (TWE)	LAH-1
• Three Phase 5-25 Tons (TWE)	LAH-1
Comfort Controls/Zone Sensors	
• Non-Programmable for ReliaTel™ Units	LCCZS-1
• Programmable for ReliaTel™ Units	LCCZS-1
• Zone Sensor Unit Installation	LCCZS-3
• Micro Control Zone Sensors	LCCZS-4
• Electronic Programmable Zone Sensors for ReliaTel™ Units	LCCZS-5
• Integrated Comfort™ Systems Sensors for ReliaTel™ Units	LCCZS-5
Packaged Cooling	
• Convertible, 3-10 Tons Features	LPC-1
• Convertible, 3-5 Tons, R-410A (THC, TSC)	LPC-2
• Convertible, 6-10 Tons, R-410A (THC, TSC)	LPC-3
• Convertible, 3-10 Tons Model Digit Numbers	LPC-4
• Convertible, 3-10 Tons, R-410A Electric Heaters	LPC-5
• Convertible, 6-10 Tons, R-410A Electric Heaters	LPC-7
• Convertible, 3-10 Tons Accessories	LPC-10
• Convertible, 3-10 Tons Zone Sensors/Thermostats	LPC-12
• ReliaTel™ Controls (Packaged Unit Protection/Operation Timings & Features)	LPC-13
• ReliaTel™ Controls (Operation with an Electromechanical Thermostat)	LPC-14
• Packaged Cooling with ReliaTel™ Controls, 12½-25 Tons, R-410A (T*D-F/T*H-F)	LPC-15
• Packaged Cooling with ReliaTel™ Controls, 12½-25 Tons Model Digit Numbers	LPC-17
• Packaged Cooling with ReliaTel™ Controls, 12½-25 Tons Zone Sensors/Thermostats	LPC-18
• Packaged Cooling with ReliaTel™ Controls, 12½-25 Tons Accessories	LPC-19
• Packaged Cooling with ReliaTel™ Controls, 12½-25 Tons Heaters	LPC-21
• Foundation™ Packaged Cooling, 15-25 Tons, R-410A (EAC)	LPC-23
• Foundation™ Packaged Cooling, 15-25 Tons, R-410A Accessories	LPC-24
• Foundation™ Packaged Cooling, 15-25 Tons, R-410A Heaters	LPC-25
Packaged Heat Pump	
• Convertible, 3-10 Tons Features	LPH-1
• Convertible, 3-10 Tons (WSC)	LPH-2
• Convertible, 3-10 Tons Model Digit Numbers	LPH-3
• Convertible, 3-5 Tons, Electric Heaters	LPH-5
• Convertible, 6-10 Tons Electric Heaters & Zone Sensors	LPH-6
• Convertible, 3-10 Tons Accessories	LPH-7
• Packaged Heat Pump with ReliaTel™ Controls, 12½-20 Tons (WSD/WSH)	LPH-9
• Packaged Heat Pump with ReliaTel™ Controls, 12½-20 Tons Model Digit Numbers	LPH-10
• Packaged Heat Pump with ReliaTel™ Controls, 12½-20 Tons Zone Sensors	LPH-11
• Packaged Heat Pump with ReliaTel™ Controls, 12½-20 Tons Accessories	LPH-12
• Packaged Heat Pump with ReliaTel™ Controls, 12½-20 Tons Heaters	LPH-13

Contents - Light Commercial

Packaged Gas/Electric

- Convertible, 3-10 Tons FeaturesLPG-1
- Convertible, 6-10 Tons, R-410A (YHC)LPG-2
- Convertible, 3-5 Tons, 15 SEER, R-410A (YHC-E).....LPG-3
- Convertible, 3-5 Tons, 13 SEER, R-410A (YSC-E).....LPG-4
- Convertible, 6-10 Tons, R-410A (YHC)LPG-5
- Convertible, 6-10 Tons, R-410A (YSC)LPG-6
- Convertible, 3-10 Tons Model Digit Numbers.....LPG-7
- Convertible, 3-10 Tons Accessories.....LPG-9
- Convertible, 3-10 Tons Zone Sensors/Thermostats.....LPG-11
- Packaged Gas/Electric with ReliaTel™ Controls 12½-25 Tons,
R-410A (YHD-F, YHH-F)LPG-12
- Packaged Gas/Electric with ReliaTel™ Controls 12½-25 Tons,
R-410A (YSD-F, YSH-F).....LPG-14
- Packaged Gas/Electric with ReliaTel™ Controls 12½-25 Tons
Model Digit NumbersLPG-16
- Packaged Gas/Electric with ReliaTel™ Controls 12½-25 Tons Accessories.....LPG-17
- Packaged Gas/Electric with ReliaTel™ Controls 12½-25 Tons
Zone Sensors/ThermostatsLPG-18
- Foundation™ Packaged Gas/Electric, 15-25 Tons, R-410A (GAC/GAD).....LPG-20
- Foundation™ Packaged Gas/Electric, 15-25 Tons, R-410A AccessoriesLPG-21

Accessories/Information

- 3-25 Ton Packaged Units Roof Curb Compatibility Information LAC/IN-1
- 6-20 Tons Split System LAC/IN-2

Model Nomenclature Residential

Outdoor Units 1 2 3 4 5 6 7 8 9 10 11 12 13 14 15
4 A 7 Z 0 0 3 6 A 1 0 0 0 A A

Refrigerant Type
2 = R-22
4 = R-410A

A, T American Standard

Product Type
6, W = Split Heat Pump
7, T = Split Cooling

Product Family
Z = Leadership - Two Stage
A = Allegiance
H = Heritage
M or B = Basic
C = Light Commercial

Family SEER
0 = 20 5 = 15
1 = 11 6 = 16
2 = 12 7 = 17
3 = 13 8 = 18
4 = 14 9 = 19

Split System Connections 1-6 Tons
0 = Brazed

Nominal Capacity in 1000's (BTUH)

Major Design Change

Power Supply
1 = 200-230/1/60 or 208-230/1/60
3 = 200-230/3/60
4 = 460/3/60

Secondary Function

Minor Design Change

Service Digit - Not Orderable

Air Handler 1 2 3 4 5 6 7 8 9 10 11 12 13 14 15
G A M 2 A 0 A 3 6 S 3 1 S A A

Brand
T = American Standard
G = Good (American Standard Branded)

Product Type
A = Air Handler

Convertability
M = Multi-poise 4-way
F = Upflow Front Return, 3-way
T = 3-way

Product Tier
2 = Good, Entry Level Feature Set
4 = Better, Retail Replacement Mid Effy.
5 = Better, Entry Level High Effy., Multi-Speed
7 = Best, Retail Replacement High Effy., Variable-Speed
8 = Best, Retail Ultimate High Effy., Variable-Speed
G = Best, Geothermal

Major Design Change

No Descriptor
0 = Air Handler / Coil

Size (Footprint)
A = 17.5 x 21.5
B = 21.0 x 21.5
C = 23.5 x 21.5

Cooling Size: Air Handler or Coil
0-9 = AH Coil - 1000 BTU's (18, 24, 30, 36, 42, 48, 60)

Airflow Type & Capability
S = Low Effy PSC, 1-5 - nom. Tonnage (cfm/ton)
M = Mid Effy Multi-Speed, 1-5 - nom. Tonnage (cfm/ton)
H = High Effy Variable, 1-5 - nom. Tonnage (cfm/ton)
V = High Effy Variable, 1-5 - nom. Tonnage (cfm/ton)

Power Supply
1 = 208-230/1/60

System Control Type
S = Standard - 24 VAC
C = CLII 13.8 VDC

Minor Design Change

Unit Parts Identifier

Accessories 1 2 3 4 5 6 7 8 9 10 11
A Y E C O N 0 1 A A

Denotes: Accessories

Accessories Type (Example: BAYCURB, AY,ASY)

ASCT = Anti-Cycle Timer	LOAM = Low Ambient Controls
BARM = Barometric Relief	LPKT = L.P. Kit
BASE = Subbase	LSDR = Low Static Drive
BRZQ = Coupling Kit Adaptors	NXKT = NOx Rod Accessory Kit
CCHT = Crankcase Heater	PANL = Panel
CLE = Coil Enclosures	PLNM = Plenum
CURB = Roof Curb	PLUS = Add-on Heat Pump
DMPR = Damper	REFLN = Refrigerant Lines
DNFLW = Downflow Conversion Kit	RLAY = Relay
ECON = Economizer	SENS = Sensor
ENTH = Enthalpy Control	SPEK = Single Power Entry Kit
FLTR = Filter	STAT = Thermostat
GARD = Coil Guard	TBKT = Thru Base Utility Kit
GRLE = Return Air Grill	TEST = Test Accessory
HALT = High Altitude Kit	TFMR = Transformer
HGBP = Hot Gas Bypass Control	TWIN = Twinning Kits
HSMT = High Static Motor	TXVA = Cooling — Bleed/Non Bleed Kits
HTRA = Electric Heater (Digit 7 Is Used To Differentiate The Products Accessory Is Used With)	TXVH = Heat Pump Non Bleed Kits
ISLT = Isolator	UTIL = Curb Ext. Kit
KSKT = Start Accessory Kit	VENT = Termination Kit
LEG = Snow Legs	WAR = Warranty
LIFT = Lifting Lug Kit	WATR = Hydronic Heat Coils
	WRKT = Wire Kit
	2STG = 2 Stage Gas

Major Design Change
Numbers Are Sequentially Assigned Except For Electric Heaters.
On Electric Heaters Digit 8 Is Used To Identify Voltage And Digit 9
And 10 Are Used To Identify Capacity In KW's.

Minor Design Change
Accessory To Unit Match-up (When Required)

Service Digit - Not Orderable

For complete equipment / combination selections, installation instructions and warranty information, please refer to Product Data/Ratings and/or Installers Guides and Limited Warranty Handbooks.

Model Nomenclature Residential

Air Handler

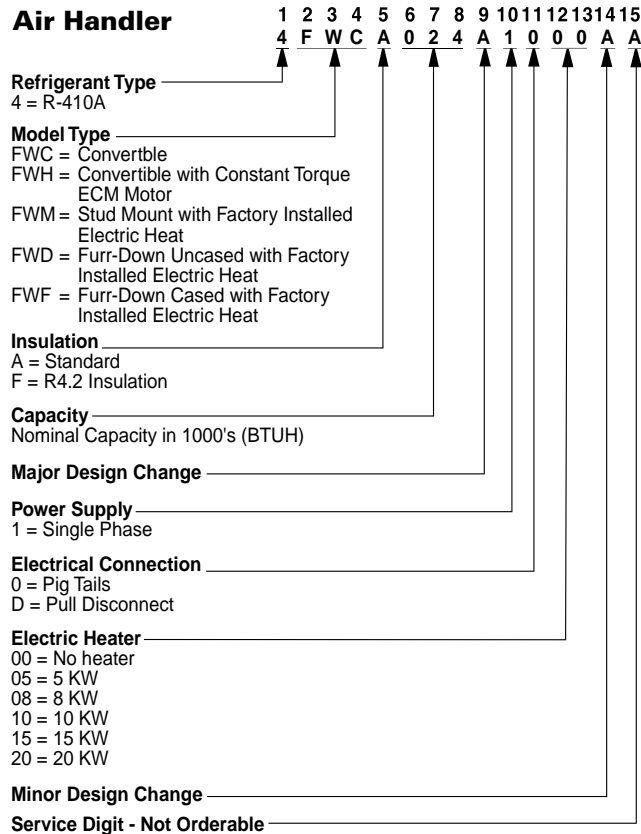

Air Handler/ Electric Furnace Heaters

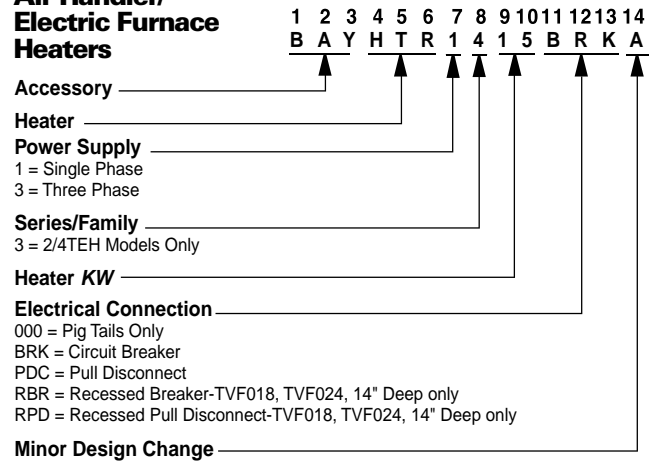

Air Handler - Residential

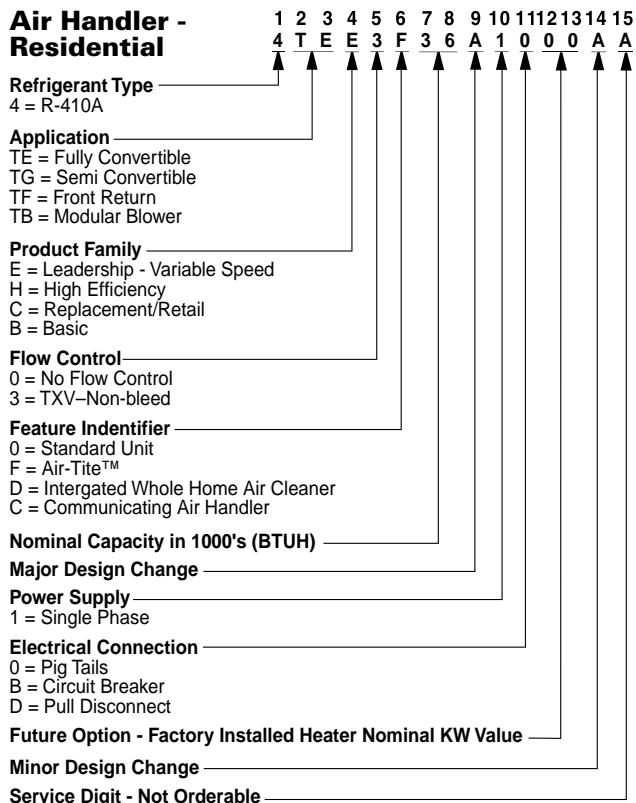

NOTE: There will be a phase-in of new model numbers for new air handlers over next 2 years.

For complete equipment / combination selections, installation instructions and warranty information, please refer to Product Data/Ratings and/or Installers Guides and Limited Warranty Handbooks.

Model Nomenclature Residential

Gas Furnaces

1 2 3 4 5 6 7 8 9 10 11 12 13 14 15
A U D 1 B 0 8 0 A 9 H 3 1 A A

Furnace Configuration

AU = Upflow/Horizontal
AD = Downflow/Horizontal

Type

E = 80% Induced Draft Standard
D = 80% Induced Draft Premium
C = 90% Condensing Standard
X = 90% Condensing Premium
H = 95% Condensing Premium

Number of Heating Stages

1 = Single Stage
2 = Two Stage
3 = Three Stage
M = Modulating

Cabinet Width

A = 14.5" Cabinet Width
B = 17.5" Cabinet Width
C = 21.0" Cabinet Width
D = 24.5" Cabinet Width

Heating Input in 1000's (BTUH)

080 = 80,000 BTUH

Major Design Change

Voltage

9 = 115 Volts / 60 Hertz / Natural Gas
A = 115 Volts / 50 Hertz / Natural Gas
C = 115 Volts / Natural Gas with Communicating System Control
F = 115 Volts / Natural Gas with Integrated Electronic Filter
D = 115 Volts / Natural Gas with Communicating System Control and Integrated Electronic Filter

Air Capacity for Cooling

Standard PSC	Variable Speed	High Efficiency
24 = 2 Tons	V3 = 3 Tons	H3 = 3 Tons
36 = 3 Tons	V4 = 4 Tons	H4 = 4 Tons
42 = 3.5 Tons	V5 = 5 Tons	H5 = 5 Tons
45 = 4 Tons		
48 = 4 Tons		
54 = 5 Tons		
60 = 5 Tons		
72 = 6 Tons		

Draft Inducer Speeds

1 = Single Speed
2 = Two Speed
V = Variable Speed

Minor Design Change

Service Digit - Not Orderable

Gas Furnaces

1 2 3 4 5 6 7 8 9 10 11 12
A U Y 0 8 0 R 9 V 3 V 0

Furnace Configuration

AU = Upflow/Horizontal
AD = Downflow/Horizontal

Type

C = Condensing
D = Induced Draft
X = Direct Vent Condensing

Heating Input in 1000's (BTUH)

080 = 80,000 BTUH

Major Design Change

C = Single Stage R = Two Stage
All other = Standard System

Power Supply and Fuel

115 Volt Natural Gas

Airflow Capacity for Cooling

Example: 36 = 3 Tons
400 CFM/Ton
400 x 3 Tons = 1200 CFM
V3 = 1 1/2 - 3 Tons, Variable Speed Motor (ICM)
V4 = 2 - 4 Tons, Variable Speed Motor (ICM)
V5 = 3 - 5 Tons, Variable Speed Motor (ICM)

Minor Design Change

V = Variable Speed Inducer

Service Digit - Not Orderable

Model Nomenclature Residential

Oil Furnaces (Legacy)

1 2 3 4 5 6 7 8 9 10 11 12 13 14 15
T H V 1 M 0 8 7 A 9 3 6 S A A

Furnace Configuration

HV = High Boy Vertical Flue
LF = Low Boy Front Flue (vertical)
LR = Low Boy Rear Flue
DF = Downflow/Horizontal Front Flue

Heating Stages

Cabinet Width

M = 22 1/4"

Heating Output in 1000's (BTUH)

087 = 87,000 BTUH

Major Design Change

Power Supply

1 = 115 v/1 ph/60hz

Nominal Capacity

Standard Variable Speed
36 = 3 Tons V3 = 3 Tons
48 = 4 Tons V4 = 4 Tons

Efficiency

S = 80% + AFUE

Minor Design Change

Service Digit - Not Roderable

Heat Pump/ Cooling Coils

1 2 3 4 5 6 7 8 9 10 11 12 13 14 15
4 T X C B 0 3 6 A C 3 H C A A

Refrigerant Type

4 = R-410A

Series

T = Premium (Heat Pump)
N = Premium (Convertible to HP)
C = Standard (Cooling Only)
F = Entry Level (Cooling Only)

Coil Design

X = Direct Expansion Evaporator Coil

Coil Feature

C = Cased A Coil
A = Uncased A Coil
F = Cased Horizontal Flat Coil

Coil Width (Cased/Uncased)

A = 14.5" / 13.3"
B = 17.5" / 16.3"
C = 21.0" / 19.8"
D = 24.5" / 23.3"
H = 10.5"

Refrigerant Line Coupling

0 = Brazed

Nominal Capacity in 1000's (BTUH)

Major Design Change

Efficiency

C = Standard
S = Hi Efficiency (derived from 10 SEER products)

Refrigerant Control

3 = TXV - Non-Bleed

Coil Circuitry

H = Heat Pump
C = Cooling

Airflow Configuration

A = Upflow Only
U = Upflow / Downflow
D = Downflow Only
R = Downflow / Horizontal Right
H = Horizontal Left/Right
C = Convertible - Upflow, Downflow, Left or Right

Minor Design Change

Service Digit - Not Orderable

Model Nomenclature Residential

Heat Pump/ Cooling Coils

1 2 3 4 5 6 7 8 9 10 11 12 13 14 15
4 T X C B 0 0 1 C C 3 H C A A

Refrigerant Type

4 = R-410A

Series

T = Premium (Heat Pump or Convertible Coil)

Coil Design

X = Direct Expansion Evaporator Coil

Coil Feature

C = Cased A Coil
A = Uncased A Coil
F = Cased Horizontal Flat Coil

Coil Width (Cased/Uncased)

A = 14.5" / 13.3"
B = 17.5" / 16.3"
C = 21.0" / 19.8"
D = 24.5" / 23.3"
H = 10.5"

Refrigerant Line Coupling

0 = Brazed

Model Number Distinguisher

Major Design Change

Efficiency

C = Standard
S = Hi Efficiency (derived from 10 SEER products)

Refrigerant Control

3 = TXV - Non-Bleed

Coil Circuitry

H = Heat Pump

Airflow Configuration

A = Upflow Only
U = Upflow /Downflow
D = Downflow Only
R = Downflow / Horizontal Right
H = Horizontal Left/Right
C = Convertible - Upflow, Downflow, Left or Right

Minor Design Change

Service Digit - Not Orderable

TXV Kits

1 2 3 4 5 6 7 8 9 10 11 12 13 14 15
2 A Y T X V H 3 A 2 5 3 1 A A

Refrigerant

4 = R-410A
2 = R-22

Accessory

Accessory Type

TXV Kit

Compatibility

Cooling & Heat Pump Compatible

Flow Control

3 = TXV - Non Bleed

Major Design Change

B = Internally Mounted (Mechanical Fittings)
C = Internally Mounted (Mechanical Fittings)
D = Internally Mounted (Mechanical Fittings)

Minimum Nominal Capacity in 000's BTU's

Maximum Nominal Capacity in 000's BTU's

Minor Design Change

Service Digit - Not Orderable

American Standard AccuClean™ Whole Home Air Cleaner

1 2 3 4 5 6 7 8 9 10 11 12 13 14 15
A F D 1 4 5 A L F R 0 0 0 A A

Brand

Filtration

ifD

Size

Furnace Upflow	Furnace Downflow	Air Handler
145 = 14.5"	14D = 14.5"	215 = 21.5"
175 = 17.5"	17D = 17.5"	235 = 23.5"
210 = 21.0"	21D = 21.0"	260 = 26.0"
245 = 24.5"	24D = 24.5"	

Major Design Series

Power Supply

L = Low Voltage

Application

AH000 = Air Handler
FR000 = Furnace

Minor Design

Service Sequence Not Orderable

Perfect Fit™ Air Cleaner

1 2 3 4 5 6 7 8 9 10 11 12
T F M 175 A 0 FR 1 1

Filter

Filter Type

M = Media, 5 Inch P = Pleated, 1 Inch

Product Dimension

145 = 14.5 Inch Furnace Width 215 = 21.5 Inch Air Handler Width
175 = 17.5 Inch Furnace Width 235 = 23.5 Inch Air Handler Width
210 = 21.0 Inch Furnace Width 260 = 26.0 Inch Air Handler Width
245 = 24.5 Inch Furnace Width

Product Development Sequence

A = 5" Cartridge Media (Rigid)
B = 5" Expandable Media

Voltage

1 = 240V 9 = 140V

Product Description

AH = Air Handler
FR = Furnace

Minor Design Change

Service Digit - Not Orderable

Perfect Fit™ Filter Accessories

1 23 45 67 89 10 11 12
B AY FT FR 17 M 2 A

Business Unit

Accessory

Filter

Product Type

AH = Air Handler
FR = Furnace

Size

14 Inch 21 Inch 24 Inch EX = Expandable
17 Inch 23 Inch 26 Inch

Type

M = Media, 5 Inch T = Throwaway, Fiberglass, 1 Inch
P = Pleated, 1 Inch W = Permanent-Washable, 1 Inch

Quantity

1 = 1 2 = 2 4 = 4 D = Dozen

Minor Design Change

For complete equipment / combination selections, installation instructions and warranty information, please refer to Product Data/Ratings and/or Installers Guides and Limited Warranty Handbooks.

Model Nomenclature Residential

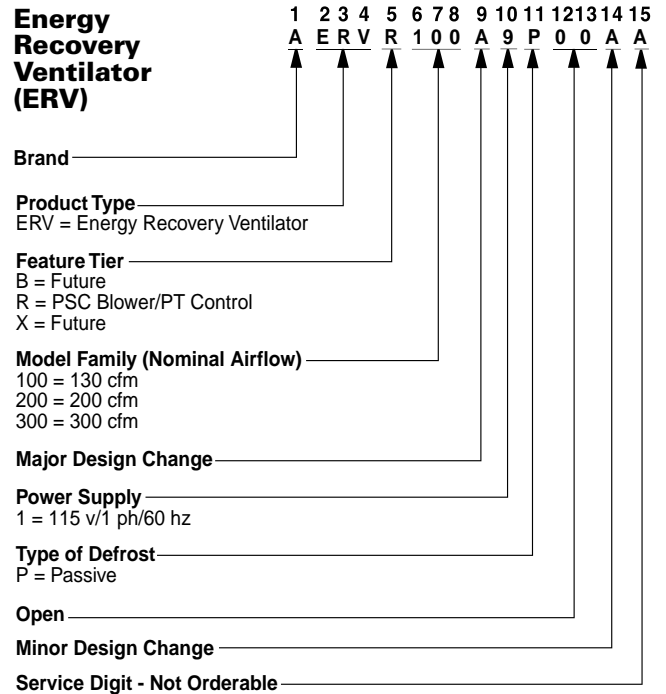
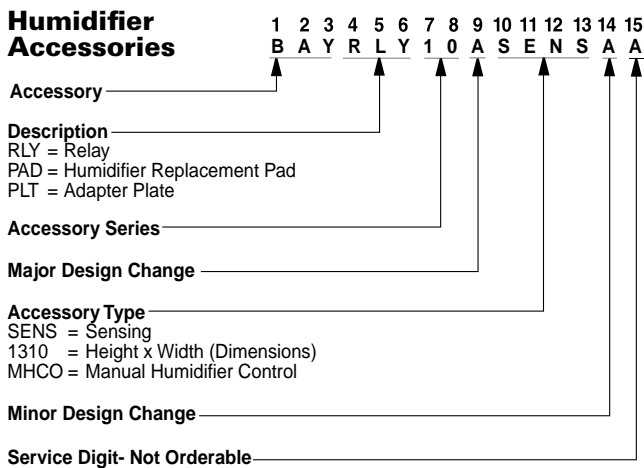
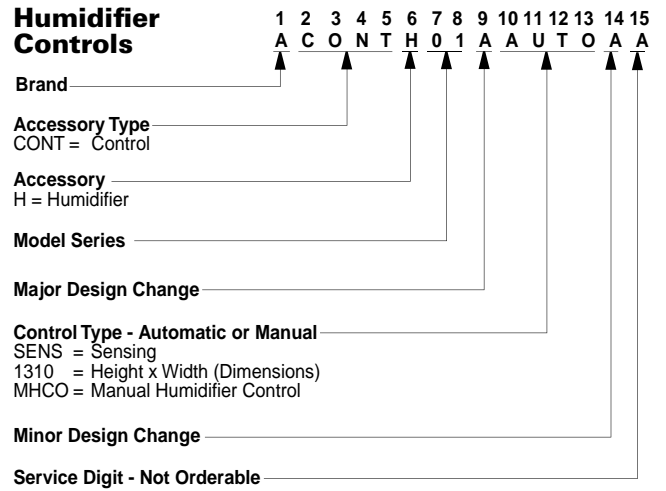
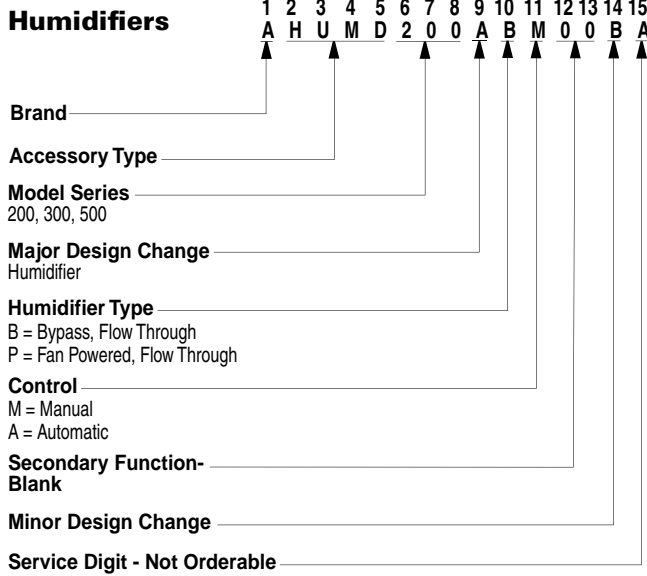

Model Nomenclature Residential

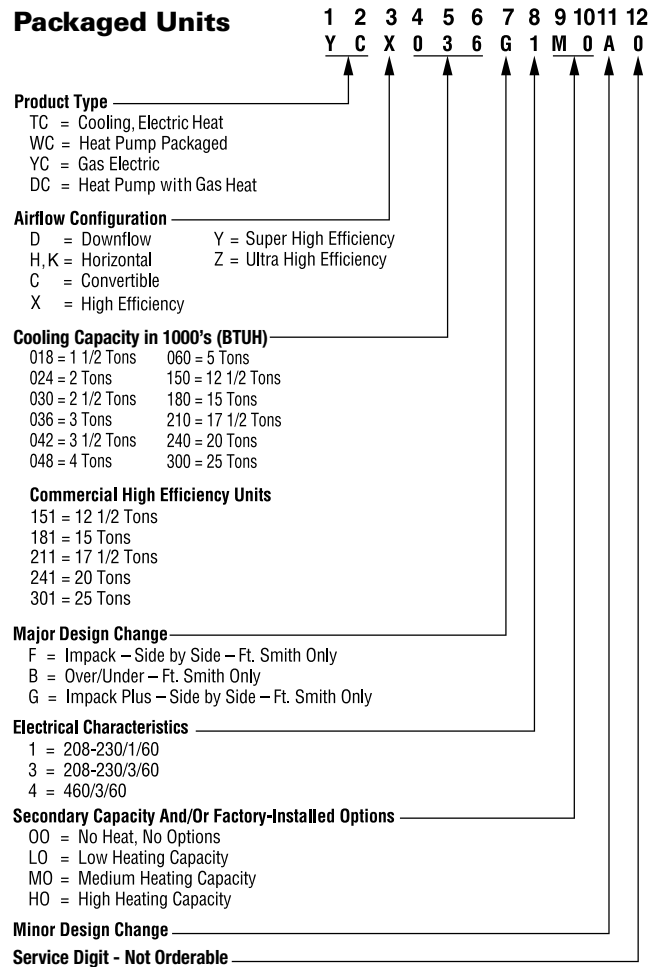
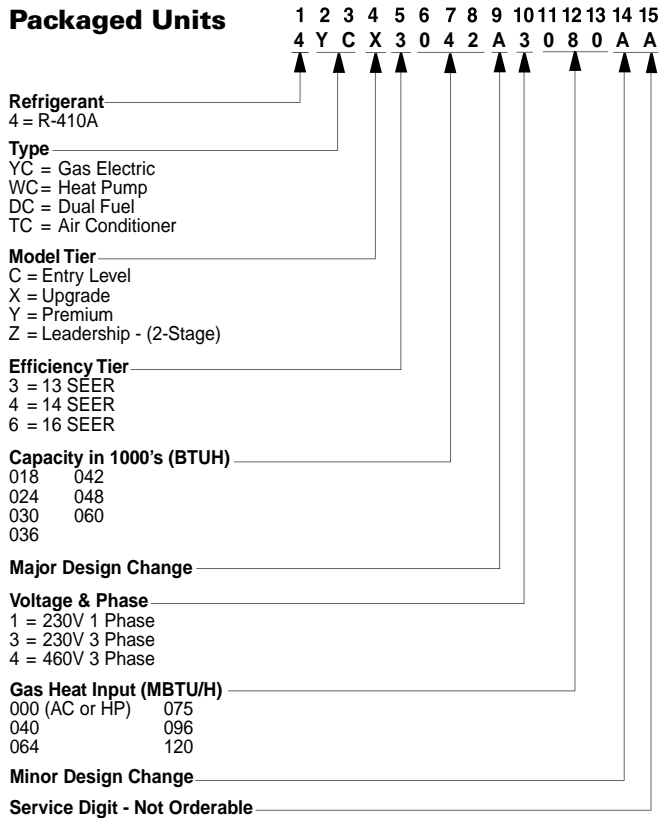

Model Nomenclature Residential

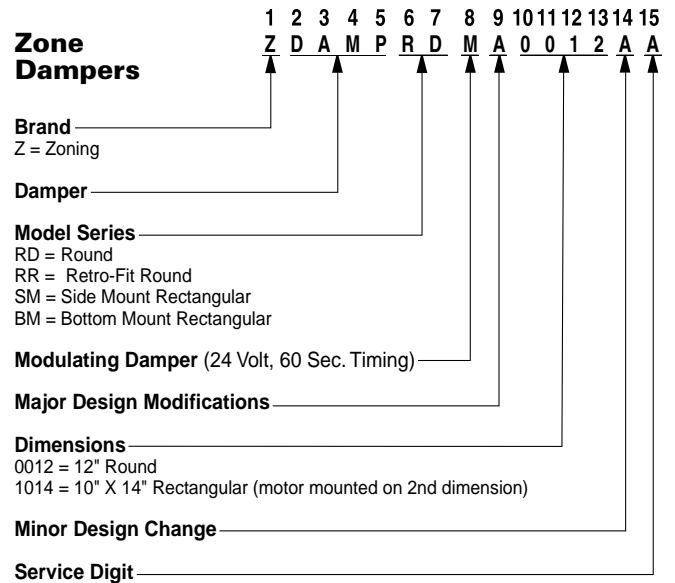
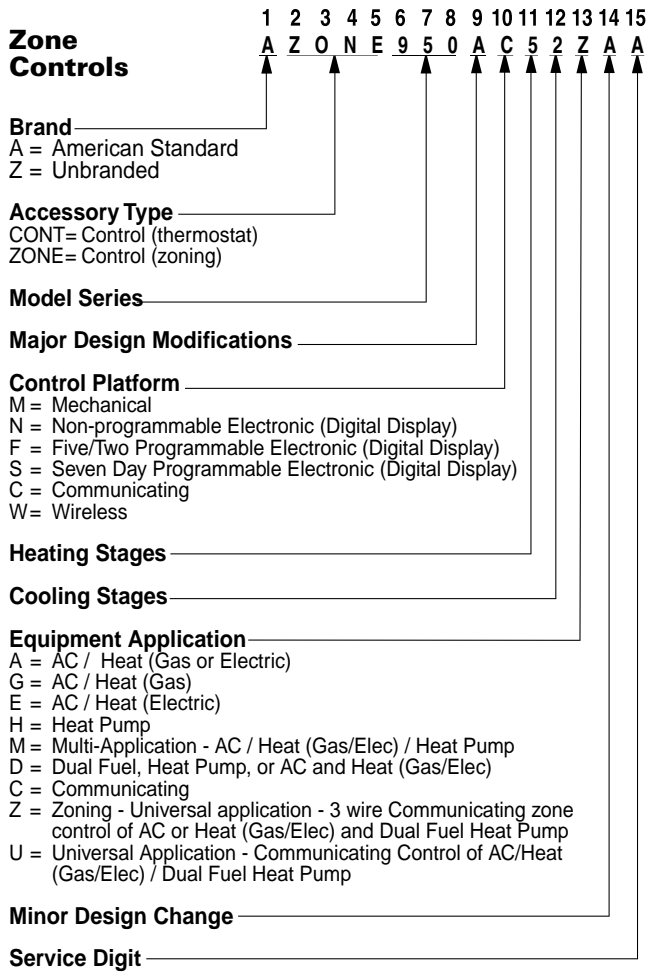

Model Nomenclature Residential

Ductless Indoor Unit

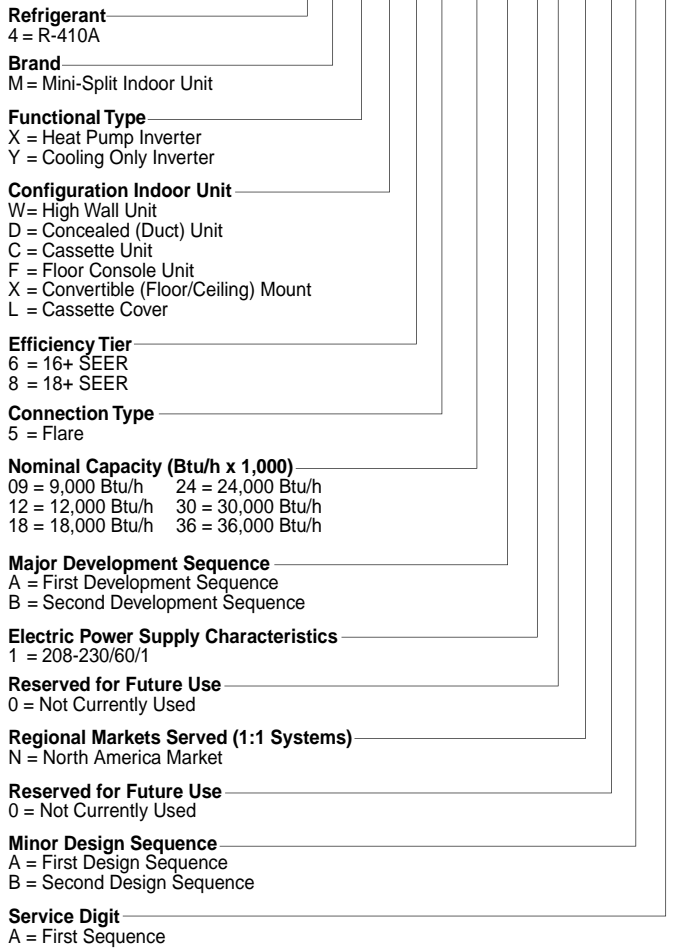

Ductless Outdoor Unit

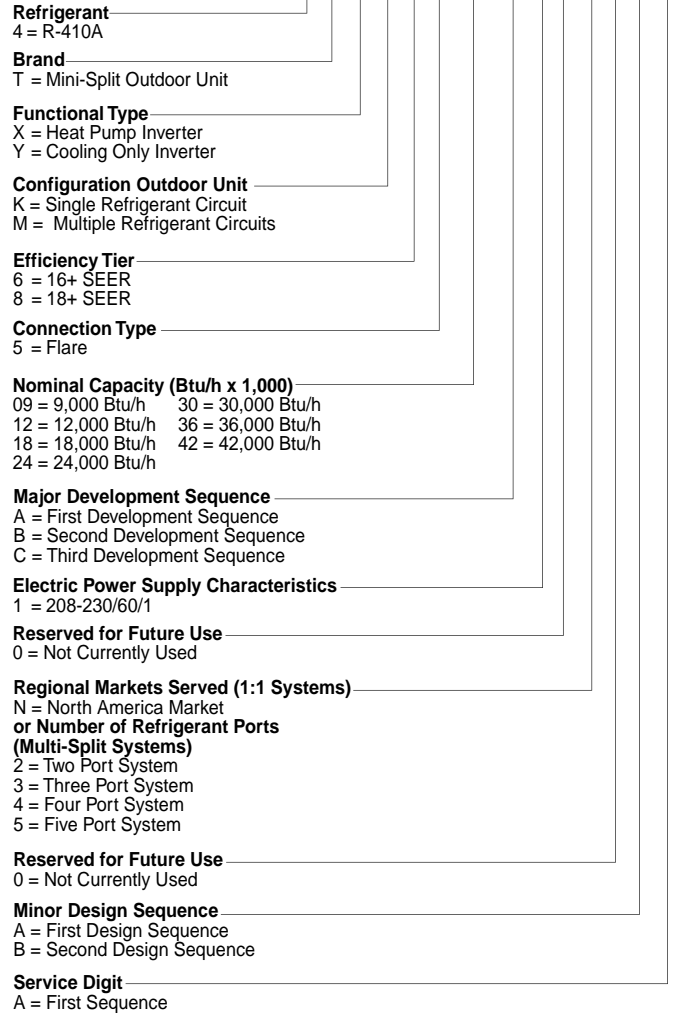

Model Nomenclature Light Commercial

Commercial Condensing Units Cooling and Heat Pump

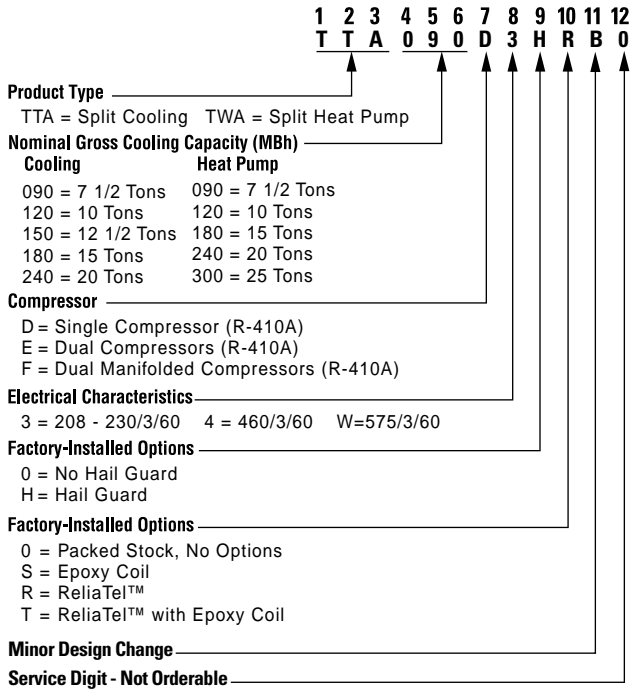

Air Handler - Commercial

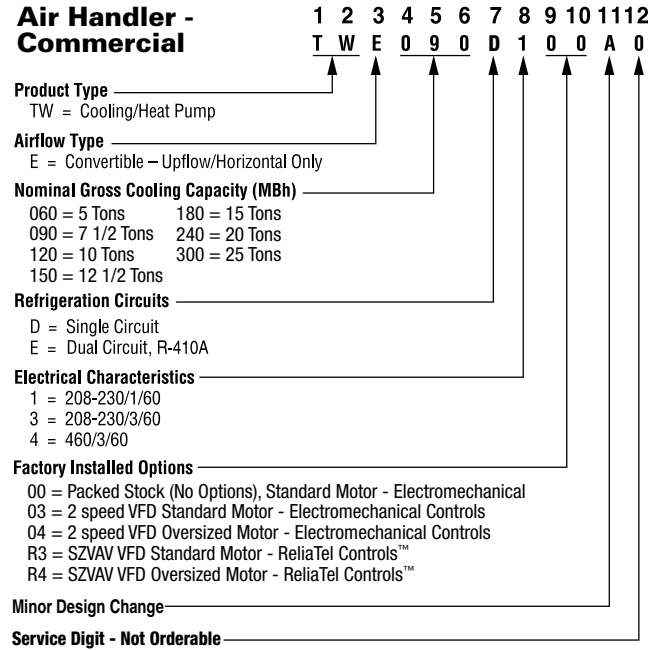

Packaged Units

Y H C 0 3 7 E 3 R Z B * * C 0 0 0 A 1 0 0 0 0 A 1
1 2 3 4 5 6 7 8 9 10 11 12 13 14 15 16 17 18 19 20 21 22 23 24 25

Digit 1 – Unit Type

T = DX Cooling
Y = DX Cooling, Gas Heat

Digit 2 – Efficiency

H = High Efficiency

Digit 3 – Airflow

C = Convertible

Digit 4,5,6 – Nominal Gross Cooling Capacity (MBh)

037 = 3 Tons
047 = 4 Tons
067 = 5 Tons

Digit 7 – Major Design Sequence

E = R-410A Refrigerant

Digit 8 – Voltage Selection

3 = 208-230/60/3
4 = 460/60/3

Digit 9 – Unit Controls

R = ReliaTel™ Microprocessor

Digit 10 – Heating Capacity

0 = No Electric Heat G = 18 kW (1&3 phase)
B = 6 kW (3 phase) J = 23 kW (3 phase)
E = 12 kW (3 phase)
L = Low Heat
M = Medium Heat
H = High Heat
X = Low Heat, Stainless Steel Heat Exchanger
Y = Medium Heat, Stainless Steel Heat Exchanger
Z = High Heat, Stainless Steel Heat Exchanger

Digit 11 – Minor Design Sequence

A = First Sequence®

Digit 12,13 – Service Sequence

**Factory Assigned

Digit 14 – Fresh Air Selection

0 = No Fresh Air
A = Manual Outside Air Damper 0-50%ⓐ
B = Motorized Outside Air Damper 0-50%
C = Economizer, Dry Bulb 0-100% without Barometric Reliefⓑ
D = Economizer, Dry Bulb 0-100% with Barometric Reliefⓑ
E = Economizer, Reference Enthalpy 0-100% without Barometric Reliefⓑ
F = Economizer, Reference Enthalpy 0-100% with Barometric Reliefⓑ
G = Economizer, Comparative Enthalpy 0-100% without Barometric Reliefⓑ
H = Economizer, Comparative Enthalpy 0-100% with Barometric Reliefⓑ

- ⓐ Standard on all variable stage units.
- ⓑ Manual outside air damper will ship factory supplied within the unit, but must be field installed.
- ⓒ High pressure control is standard on all units.
- ⓓ Constant CFM direct drive is standard for 3-5 Ton variable stage units.

Digit 15 = 0, 6

3 Phase (3-5 ton) = High Efficiency Constant CFM

- ⓔ Economizer with Barometric Relief is for downflow configured units only. Order Economizer without Barometric Relief for horizontal configuration. Barometric Relief for horizontal configured units must be ordered as field installed accessory.

Digit 15 – Supply Fan/Drive Type/Motor

0 = Standard Driveⓔ
6 = Single Zone VAV

Digit 16 – Hinged Service Access/Filters

0 = Standard Panels/Standard Filters
A = Hinged Access Panels/Standard Filters
B = Standard Panels/2" MERV 7 Filters
C = Hinged Access Panels/2" MERV 7 Filters
D = Standard Panels/2" MERV 13 Filters
E = Hinged Access Panels/2" MERV 13 Filters

Digit 17 – Condenser Coil Protection

0 = Standard Coil
1 = Standard Coil with Hail Guard
2 = Black Epoxy Pre-Coated Condenser Coil
3 = Black Epoxy Pre-Coated Condenser Coil with Hail Guard
4 = Complete Coat™ Condenser Coil
5 = Complete Coat™ Condenser Coil with Hail Guard

Digit 18 – Through the Base Provisions

Note: Applicable to Digit 1, T or Y models

0 = No Through the Base Provisions
A = Through the Base Electricⓕ
B = Through the Base Gas Pipingⓖ
C = Through the Base Electric and Gas Pipingⓖ

Digit 19 – Disconnect/Circuit Breaker

(three - phase only)

0 = No Disconnect/No Circuit Breaker
1 = Unit Mounted Non-Fused Disconnectⓗ
2 = Unit Mounted Circuit Breakerⓗ

Digit 20 – Convenience Outlet

0 = No Convenience Outlet
A = Unpowered Convenience Outlet
B = Powered Convenience Outlet (three-phase only)ⓓ

Digit 21 – Communications Options

0 = No Communications Interface
3 = Novar 2024 Controls
4 = Novar 3051 Controls without Zone Sensor
5 = Novar 3051 Controls Interface with DCV
6 = BACnet™ Communications Interface

Digit 22 – Refrigeration System Option

0 = Standard Refrigeration Systemⓓ
B = Dehumidification Optionⓓ

- ⓕ Through the base electric required when ordering disconnect/circuit breaker options.
- ⓖ Requires use of Disconnect or Circuit Breaker.

Not Available

High Efficiency
3-5 ton w/Standard Indoor Motor w/460V

- ⓔ Standard metering devices are TXVs.
- ⓕ The return air smoke detector may not fit up or work properly on the Precedent units when used in conjunction with 3rd party accessories such as bolt on heat wheels, economizers and power exhaust. Do not order the return air smoke detectors when using this type of accessory.

Digit 23 – Refrigeration Controls

Note: Applicable to Digit 7 = E

0 = No Refrigeration Controlⓓ
1 = Frostat
2 = Crankcase Heaterⓓ
3 = Frostat and Crankcase Heaterⓓ

Digit 24 – Smoke Detectorⓓ

0 = No Smoke Detector
A = Return Air Smoke Detectorⓓⓔ
B = Supply Air Smoke Detector
C = Supply and Return Air Smoke Detectorsⓓⓔ

Digit 25 – Monitoring Controls

0 = No Monitoring Controlⓓ
1 = Clogged Filter Switchⓓ
2 = Fan Failure Switchⓓ
3 = Discharge Air Sensing Tubeⓓ
4 = Clogged Filter Switch and Fan Fail Switchⓓ
5 = Clogged Filter Switch and Discharge Air Sensing Tubeⓓ
6 = Fan Fail Switch and Discharge Air Sensing Tubeⓓ
7 = Clogged Filter and Fan Fail Switches and Discharge Air Sensing Tubeⓓ
8 = Novar Return Air Sensorⓓ
9 = Novar 3051 Zone Sensorⓓ

- ⓓ Return Air Smoke Detector cannot be ordered with Novar Controls.
- ⓔ These options are standard when ordering Novar Controls.
- ⓕ This option is used when ordering Novar Controls.
- ⓖ Includes gas piping and shutoff (field assembly required).
- ⓗ Not available with high temperature duct sensor accessory.
- ⓓ Novar Sensor utilized with Digit 21 = (4) Novar 3051 Controls without Zone Sensor.
- ⓔ Available for T/Y 3,4,5 ton high efficiency models.
- ⓕ Requires selection of 2" Pleated Filters (option B or C) for Digit 16.

Model Nomenclature Light Commercial

G A C 1 8 0 A 3 E Z A 0 0
1 2 3 4 5 6 7 8 9 10 11 12 13

Digit 1 – Unit Type

E = Packaged Cooling, Electric Heat
G = Packaged Cooling, Electric Heat

Digit 2 – Efficiency

A = ASHRAE 90.1 - 2010

Digit 3 – Airflow Configuration

C = Convertible
D = Downflow Only^④

Digit 4, 5, 6 – Nominal Gross Cooling Capacity (MBh)

180 = 15 Tons
210 = 17½ Tons
240 = 20 Tons
300 = 25 Tons

Digit 7 – Major Design Sequence

A

Digit 8 – Voltage Selection

3 = 208-230/60/3
4 = 460/60/3
W = 575/60/3

Digit 9 – Unit Controls

E = Electromechanical

Digit 10 – Heating Capacity

Note: (Applicable to Digit 1 E models only)

0 = No Heat
G = 18 kW Electric Heat
N = 36 kW Electric Heat
P = 54 kW Electric Heat
R = 72 kW Electric Heat

Note: (Applicable to Digit 1 E models only)

H = Gas Heat - High^②
L = Gas Heat - Low
M = Gas Heat - Medium
X = Gas Heat - SS Ht Ex - Low
W = Gas Heat - SS Ht Ex - Medium
Z = Gas Heat - SS Ht Ex - High^②

Digit 11 – Minor Design Sequence

Digit 12-13 – Service Sequence

0 = None

Digit 14 – Fresh Air Selection

0 = No Fresh Air
A = Manual Outside Air Damper 0-50%
B = Motorized Outside Air Damper 0-50%
C = Economizer, Dry Bulb 0-100% without Barometric Relief
D = Economizer, Dry Bulb 0-100% with Barometric Relief^①
E = Economizer, Reference Enthalpy 0-100% without Barometric Relief
F = Economizer, Reference Enthalpy 0-100% with Barometric Relief^①
G = Economizer, Comparative Enthalpy 0-100% without Barometric Relief
H = Economizer, Comparative Enthalpy 0-100% with Barometric Relief^①

Digit 15 – Supply Fan/Drive Type/Motor

0 = Standard Motor
1 = Oversized Motor
7 = Multi-Speed Standard Motor
9 = Multi-Speed Oversized Motor

Digit 16 – Not Used

Digit 17 – Condenser Coil Protection

0 = Standard Coil
4 = CompleteCoat™ Condenser Coil

Digit 18 – Through The Base Provisions

Note: (Applicable to Digit 1, E models)

0 = No Through The Base Provisions
A = Through The Base Electric

Note: (Applicable to Digit 1, G models only)

0 = No Through The Base Provisions
A = Through The Base Electric
B = Through The Base Gas^①
C = Through The Base Electric/Gas

Digit 19 – Disconnect Switch

0 = No Disconnect/circuit break
1 = Unit Mounted Non-Fused Disconnect Switch^②

Digit 20 – Not Used

Digit 21 – Not Used

Digit 22 – Not Used

Digit 23 – Not Used

Digit 24 – Not Used

Digit 25 – System Monitoring Controls

0 = No Monitoring Controls
A = Condensate Drain Pan Overflow Switch

- ① Some field set up required.
② Must be ordered with Through-the-Base Electrical option.
③ All Factory Installed Options are Built-to-Order. Check order services for estimated production cycle.
④ High heat is available on dowflow units only.

Conventional 24 Volt Connected Controls

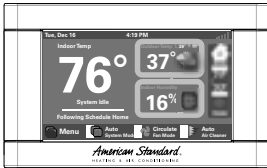

GOLD XV
ACONT824AS52DA



**AVAILABLE
SOON**

ACONT824AS42DA

- NEXIA™ Home Intelligence "Z-Wave" Bridge Inside
 - Connect up to 230 Z-Wave devices
- WiFi (802.11 b/g/n) or Ethernet connection
- Control the Gold XV from a smartphone, tablet, or computer ^{1,2}
- 4.3" diagonal HD color touchscreen
- Compatible with non-communicating conventional 24 Volt systems
 - Cooling, heating, heat pump, and dual fuel
- 7 Day programmable with up to six schedules per day
- Five day weather forecast, weather radar, and weather alerts ¹
- Indoor relative humidity display
- Enhanced dehumidification
- 2 Auxiliary dry contacts
 - Control 2 of the following: Whole house humidifier, dehumidifier, or ventilation system
- Test modes and alert diagnostics
- Nexia Dealer Portal enabled
- Upgradeable software
- Silver color
- Limited Warranty: 5 yr. base/10 yr. registered

Application:

HVAC system compatibility:

- Conventional gas/electric, heat pump, and dual fuel systems
- Conventional boiler systems (forced air only)
- Conventional HVAC systems: 2 Heat / 2 cool
- Heat Pump systems: Up to 5 stages heat / 2 stages cool (2 compressor heat - 3 auxiliary heat / 2 cooling)
- Heat Pump switchover valve: Selectable "with cool or with heat"
- Remote Indoor Sensor (optional): ZZSENSAL0400AA
- Remote Outdoor Sensor (optional): BAYSEN01ATEMPA
- PWM Circuit (BK terminal): controls indoor unit variable speed blowers

Dimensions:

- Product: 5.43"w x 3.39"h x 1.30"d
- Display: 4.15"w x 2.65"h

ACONT624AS42DA

- NEXIA™ Home Intelligence compatible
- Z-wave comfort control
- Control the Silver XM from a smartphone, tablet, or computer^{1,2} (requires SK101 for remote connectivity)
- 4.3" diagonal black and white touchscreen
- Compatible with conventional 24 volt HVAC, heat pump, dual fuel, and conventional boiler systems (baseboard and radiator)
- 7 Day programmable with up to 4 schedules per day
- Humidity sensor and RH display
- Remote temperature sensor connections (1 indoor/1 outdoor)
- Auxiliary & compressor heat lockouts
- Auxiliary dry contact
- Enhanced dehumidification (cooling)
- Adjustable variable speed fan settings (pwm)
- Energy Savings Mode (ESM)
- Screen lock and guest lock
- Service test modes
- Upgradeable software
- Silver color
- Limited Warranty: 1 yr. base/5 yr. registered

Application:

HVAC system compatibility:

- Up to 4 Stages Heat/2 Stages Cool
- Conventional gas/electric, heat pump, and dual fuel systems
- Conventional boiler systems (baseboard & radiators)
- Remote Indoor Sensor (optional): ZZSENSAL0400AA
- Remote Outdoor Sensor (optional): BAYSEN01ATEMPA

Dimensions:

- Product: 5.9"w x 3.47"h x .95"d
- Display: 3.8"w x 2.3"h

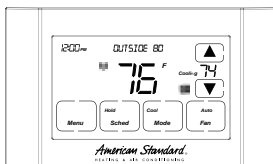

SILVER XM
ACONT624AS42DA



For complete equipment / combination selections, installation instructions and warranty information, please refer to Product Data/Ratings and/or Installers Guides and Limited Warranty Handbooks.

¹ Requires high speed router, internet service, and connection to Nexia Home Intelligence.

² Nexia Home Intelligence monthly service fee is not required to connect up to 4 (total) of the following American Standard Heating & Air Conditioning brand connected controls: a) ACONT824; b) ACONT850; c) AZONE950; d) ACONT624. The monthly service is also included for up to 4 appliance modules, one per connected control.

AccuLink™ Communicating Connected Controls

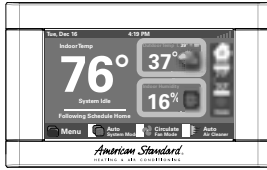

**PLATINUM XV
ACONT850AC52UA**



**AVAILABLE
SOON**

ACONT850AC52UA

- NEXIA™ Home Intelligence "Z-Wave" Bridge Inside
 - Connect up to 230 Z-Wave devices
- WiFi (802.11 b/g/n) or Ethernet connection
- Control the Platinum XV from a smartphone, tablet, or computer^{1,2}
- 4.3" diagonal HD color touchscreen
- Compatible with AccuLink™ communicating systems (variable speed and two stage)
- Compatible with conventional 24 Volt HVAC, heating, heat pump, and dual fuel systems used with accessory relay panel model BAY24VRPAC52DB
- 7 day programmable with up to six schedules per day
- Five day weather forecast, weather radar, and weather alerts¹
- Indoor relative humidity display
- Test modes and alert diagnostics
- Nexia Dealer Portal enabled
- Upgradeable software
- Silver color
- Limited Warranty: 5 yr. base/10 yr. registered

Application:

HVAC system compatibility:

- AccuLink™ communicating systems (variable speed and two stage)
- Conventional gas/electric, heat pump, dual fuel systems, or boiler systems (forced air only) with use of relay panel model BAY24VRPAC52DB. (Relay panel controls up to 5 stages heat, 2 stages cool, remote indoor and outdoor connections, humidifier, dehumidifier, and ventilation system auxiliary dry contacts)

Dimensions:

- Product: 5.43"w x 3.39"h x 1.30"d
- Display: 4.15"w x 2.65"h



**PLATINUM ZV
AZONE950AC52ZA**



TZONE950AC52ZA

- NEXIA™ Home Intelligence compatible
- WiFi (802.11 b/g/n)
- Control the Platinum ZV from a smartphone, tablet, or computer^{1,2}
- 7" diagonal HD color touchscreen
- Compatible with AccuLink™ communicating systems (variable speed and two stage)
- Compatible with conventional 24 Volt HVAC, heating, heat pump, and dual fuel systems used with accessory relay panel model BAY24VRPAC52DB
- 7 Day programmable with up to 6 schedules per day
- Five day weather forecast, weather radar, and weather alerts¹
- Indoor relative humidity display
- Control up to 3 accessory devices with relay panel model BAY24VRPAC52DB
 - Whole house humidifier, dehumidifier, or ventilation system
- Test modes and diagnostic screens
- Nexia Dealer Portal enabled
- Upgradeable software
- Silver color
- Limited Warranty: 5 yr. base/10 yr. registered

Application:

HVAC system compatibility:

- AccuLink™ communicating systems (variable speed and two stage)
- Conventional gas/electric, heat pump, dual fuel systems, or boiler systems (forced air only) with use of relay panel model BAY24VRPAC52DB. (Relay panel controls up to 5 stages heat, 2 stages cool, remote indoor and outdoor connections, humidifier, dehumidifier, and ventilation system auxiliary dry contacts)

Dimensions:

- Product: 7.3"w x 4.3"h x 1.2"d
- Display: 6.1"w x 3.6"h

¹ Requires high speed router, internet service, and connection to Nexia Home Intelligence.

² Nexia Home Intelligence monthly service fee is not required to connect up to 4 (total) of the following American Standard Heating & Air Conditioning brand connected controls: a) ACONT824; b) ACONT850; c) AZONE950; d) 624. The monthly service is also included for up to 4 appliance modules, one per connected control.

For complete equipment / combination selections, installation instructions and warranty information, please refer to Product Data/Ratings and/or Installers Guides and Limited Warranty Handbooks.

NEXIA™ Compatible Accessories

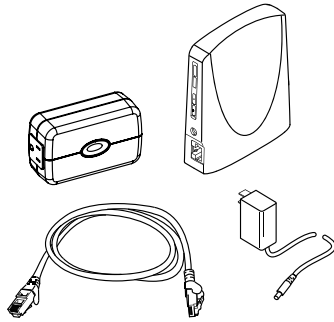

SK101

SK101

NEXIA™ Home starter bundle

- Includes NEXIA™ Home Bridge (Z-Wave to broadband), one RP100BX Home Appliance Module, ethernet cable, and power supply
- The NEXIA™ Home Bridge allows remote access of Z-Wave enabled devices through your smart phone, tablet, or P.C.
- Secure Connection with server for homeowner protection
- Easy Installation and Set-Up

Application:

- Use with ACONT624AS42DA or AZEMT500BB32MA
- Use with additional RP200RVNNSL light module and RP100BX Home Appliance Modules
- Use with Keypad and Touchscreen Deadbolts, and Keypad Lever Locks
- Window/Door Sensor RS100HCVNNSL
- Motion Sensor RS200HCVNNSL

Dimensions:

- NEXIA™ Bridge: 4.0" W x 4.8" H x 1.4" D
- Home Appliance Module: 4.0" W x 2.4" H x 1.6" D
- Shipping Weight: 2 lbs.

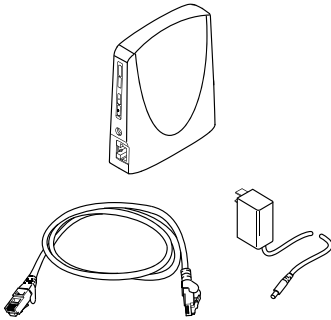

BR100

BR100

NEXIA™ Home Bridge

- Includes NEXIA™ Home Bridge (Z-Wave to broadband), ethernet cable, and power supply
- The NEXIA™ Home Bridge allows remote access of Z-Wave enabled devices through your smart phone, tablet, or P.C.
- Secure Connection with server for homeowner protection
- Easy Installation and Set-Up

Application:

- Use with ACONT624AS42DA or AZEMT500BB32MA
- Use with additional RP200RVNNSL light module and RP100BX Home Appliance Modules
- Use with Keypad and Touchscreen Deadbolts, and Keypad Lever Locks
- Window/Door Sensor RS100HCVNNSL
- Motion Sensor RS200HCVNNSL

Dimensions:

- NEXIA™ Bridge: 4.0" W x 4.8" H x 1.4" D
- Shipping Weight: 1 lbs.

AccuLink™ Control

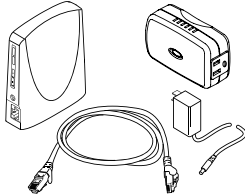
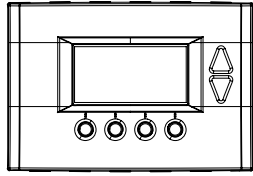

AZTSK500BB32MA

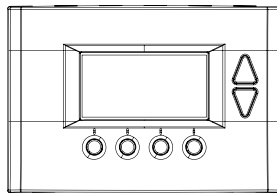

AZEMT500BB32MA



AZTSK500BB32MA

- American Standard AccuLink™ Control Kit
- Includes AZEMT500BB32MA control, NEXIA™ Bridge, RP100BX Home Appliance Module, power supply, and ethernet cable
- Remote access to control from computers connected to internet and compatible web enabled mobile platforms including Android™, Blackberry™, iPhone™ and many other web enabled phones
- Air conditioning and heating energy management
- Easy Installation and Set-Up
- Expandable for home management

AZEMT500BB32MAA

- 24 Vac, Z Wave enabled control
- Compatible with NEXIA™
- 7 day programmable, 4 schedules per day, may be scheduled from web or control
- Remotely adjust control and view temperature from computers connected to internet and compatible web enabled mobile platforms including Android™, Blackberry™, iPhone™ and many other web enabled phones
- Requires NEXIA™ Bridge and Home Appliance Module for remote access
- Service fee required for remote access
- Control Recovery
- Remote Sensing
- Dual Fuel Control
- Built in humidity sensor
- Cooling Droop
- Smart Continuous Fan
- Enhanced dehumidification with variable speed indoor products
- Filter service reminder alert
- Maintenance reminder alert
- Out of Range Temperature alert
- Keypad tamper alert
- Alerts may be sent by e-mail and/or text to mobile device
- Limited Five Year Parts Warranty
- Registered Ten Year Parts Warranty

Application:

- 3 Heat/2 Cool for Heat Pump
- 2 Heat/2 Cool for Gas Electric
- See AZEMT500BB32MA for details
- Use with additional AZEMT500BB32MA control
- Use with additional RP200RVNNSL light module and RP100BX Home Appliance Module
- Use with Keypad and Touchscreen Deadbolts, and Keypad Lever Locks
- Up to 231 devices may be wirelessly connected to one NEXIA™ Bridge

Dimensions:

- Control: 5.7" W x 4.0" H x 1.2" D
- LCD display 2.75" W x 1.5" H
- Shipping Weight: 2.35 lbs.

Application:

- 3 Heat/2 Cool for Heat Pump
- 2 Heat/2 Cool for Gas Electric
- 7 day programmable, 4 schedules per day
- Used with NEXIA™ Bridge and Home Appliance Module, included in AZTSK500BB32MA kit

Compatible Systems

- Gas/Oil Furnace
- Air Handler/Electric Furnace
- Heat Pump systems
- Cooling systems

May be Compatible

- Conventional Boilers
- Geothermal
- 24 Vac Forced Air Multi Zone Systems

Not Compatible

- Radiant Floor
- 120/240 Volt Electric Baseboard Heat
- Wall Heating systems
- Proprietary Communicating Systems

Dimensions:

- 5.7" W x 4.0" H x 1.2" D
- LCD display 2.75" W x 1.5" H
- Shipping Weight: 1 lb.

NEXIA™ Accessories

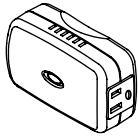

RP200RVNNSL

RP200RVNNSL

- Signal Repeater and Dimmer Light Module
- Used to control and dim plug-in incandescent lighting

Application:

- Use with NEXIA™ Bridge (bridge included in AZTSK500BB32MA, SK101, and BR100 kits)
- Max load both outlets = 15 Amps, 1800 Watt resistive
- Max load Z Wave controlled outlet = 300 Watts incandescent only
- Shipping Weight: 1 lb.

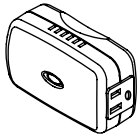

RP100BX

RP100BX

- Signal Repeater and Home Appliance Module
- Used to control small appliances and plug-in incandescent, fluorescent, and LED lighting. On/Off control
- May be used to control/reduce standby loss from plug-in power supplies and small electronic loads

Application:

- Use with NEXIA™ Bridge (bridge included in AZTSK500BB32MA, SK101, and BR100 kits)
- Max load both outlets = 15 Amps, 1800 Watt resistive
- Max load Z Wave controlled outlet = 600 Watts incandescent, 1/2 HP, 1800 Watt resistive
- Shipping Weight: 1 lb.

NEXIA™ Accessories

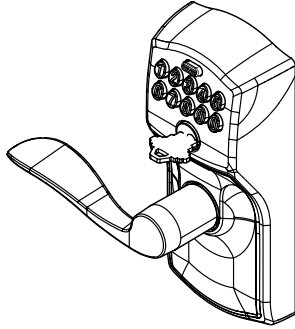

BAY599BBALLFEA
BAY599SNALLFEA
BAY599ABALLFEA

BAY599 (Lever Lock)

- Wireless Home Keypad Locks can be added to a the Z-Wave network within your home
- Remotely lock or unlock the door from computers connected to internet and compatible web enabled mobile platforms including Android™, Blackberry™, iPhone™ and many other web enabled phones
- Confirm lock status from internet enabled computer or web enabled mobile device
- Assign up to 19 personalized 4 digit codes for each member of your household
- Up to 3 year battery life
- Provides battery level status at the lock and on the web
- Available in 3 finishes: Bright Brass, Satin Nickel, Aged Bronze
- Class 2 rated door lock
- Lifetime limited mechanical and finish warranty
- 1-year limited electronics warranty

Model number and finish:

- BAY599BBALLFEA - Bright Brass
- BAY599SNALLFEA - Satin Nickel
- BAY599ABALLFEA - Aged Bronze

Application:

- Use with NEXIA™ Bridge (bridge included in AZTSK500AB32MA, AZTSK500BB32MA, SK101, and BR100 kits)
- Carton Size: 6" x 7.75" x 9.56"
- Shipping Weight: 5.5 lbs.

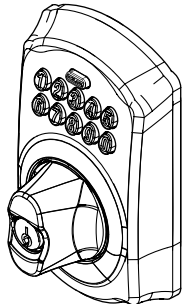

BAY369BBADBBEA
BAY369SNADBBEA
BAY369ABADBBEA

BAY369 (Deadbolt)

- Wireless Home Keypad Deadbolt Locks can be added to the Z-Wave network within your home
- Remotely lock or unlock the door from computers connected to internet and compatible web enabled mobile platforms including Android™, Blackberry™, iPhone™ and many other web enabled phones
- Confirm lock status from internet enabled computer or web enabled mobile device
- Assign up to 19 personalized 4 digit codes for each member of your household
- Up to 3 year battery life
- Provides battery level status at the lock and on the web
- Available in 3 finishes: Bright Brass, Satin Nickel, Aged Bronze
- Class 2 rated door lock
- Lifetime limited mechanical and finish warranty
- 1-year limited electronics warranty

Model number and finish:

- BAY369BBADBBEA - Bright Brass
- BAY369SNADBBEA - Satin Nickel
- BAY369ABADBBEA - Aged Bronze

Application:

- Use with NEXIA™ Bridge (bridge included in AZTSK500AB32MA, AZTSK500BB32MA, SK101, and BR100 kits)
- Carton Size: 5.75" x 7.93" x 8.5"
- Shipping Weight: 6 lbs.

NEXIA™ Accessories

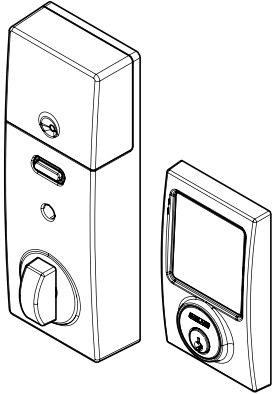

BAY469SNACENEA
Century

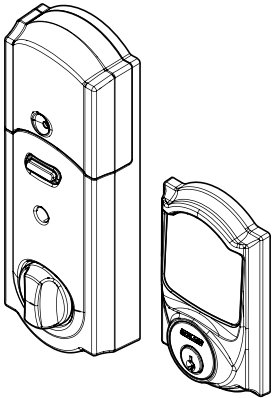

BAY469SNACAMEA
BAY469ABACAMEA
Camelot

BAY469 (Touchscreen Deadbolt)

- Century touchscreen deadbolt available in Satin Nickel finish only
- Camelot touchscreen deadbolt available in Satin Nickel or Aged Bronze finish
- Motorized bolt automatically locks and unlocks when code is entered
- Anti-pick shield protects against tampering
- Built-in alarm technology
- With NEXIA™ Home Intelligence, receive text or e-mail alerts when codes are used
- Unlock doors remotely for someone when you cannot be there to let them in
- Set NEXIA™ to conveniently turn on lights when you enter your access code
- Lifetime limited mechanical and finish warranty
- 1-year limited electronics warranty

Model number and finish:

- BAY469SNACENEA - Satin Nickel
- BAY469SNACAMEA - Satin Nickel
- BAY469ABACAMEA - Aged Bronze

Application:

- Use with NEXIA™ Bridge (bridge included in AZTSK500BB32MA, SK101, and BR100 kits)

Dimensions:

- Century: Outside 3.0"W x 5.0" H
Inside 3.0"W x 8.17"H
- Camelot: Inside 3.0"W x 5.0" H
Inside 3.0"W x 8.28"H
- Shipping Weight: 3.8 lbs.

NEXIA™ Accessories

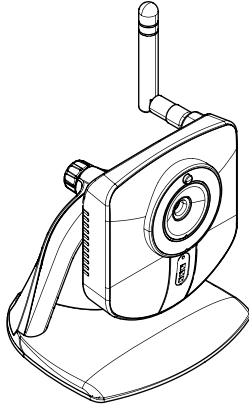

WCW100NNSL

WCW100NNSL

- NEXIA™ Web Camera - Wireless
- Indoor, fixed camera (power supply included)
- Remotely monitor your home from any PC with internet access and most internet enabled devices and smart phones
- Secure Connection with server for homeowner protection
- Plug and Play with System
- Privacy button

Application:

- VGA (640x480) resolution
- Operating Temp -5C to 50C
- Wireless
 - 802.11b/g
 - WEP 64/128, WPA-PSK, WPA2

Dimensions:

- 3.8" W x 3.5" H x 1.4" D
- Shipping Weight: 1 lb

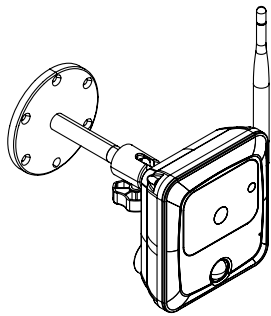

WCO100NXNNSL

WCO100NXNNSL

- NEXIA™ Web Camera - Wireless
- Outdoor, fixed camera (power supply included)
- Remotely monitor your home from any PC with internet access and most internet enabled cell phones
- Secure Connection with server for homeowner protection
- Plug and Play with System
- Privacy button

Application:

- VGA (640x480) resolution
- Operating Temp -10C to 45C
- Wireless
 - 802.11b/g
 - WEP 64/128, WPA-PSK, WPA2

Dimensions:

- 1.5" W x 3.7" H x 4.1" D
- Shipping Weight: 2 lbs

NEXIA™ Sensors

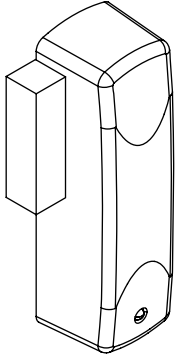

RS100HCVNNSL

RS100HCVNNSL

- Door / Window Sensor
- Check in to see if the doors and windows are closed at night
- Set NEXIA™ to notify you when doors or windows have been opened in the home
- Set NEXIA™ to change the temperature inside the home when windows have been opened or closed
- Simple installation and set up - easy to non do-it-yourselfers
- Up to 3 year battery life for normal usage, no wiring required
- For indoor use
- White and brown cover available to match your door or window

Application:

- Use with NEXIA™ Bridge (bridge included in AZTSK500AB32MA, AZTSK500BB32MA, SK101, and BR100 kits)
- Operating Temp -0°C to 49°C
- Range: 60 ft
- Operating frequency: 908.41 MHz

Dimensions:

- 3.5"W x 1.75"H x 1"D
- Shipping weight: 1 lb

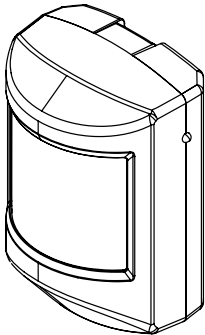

RS200HCVNNSL

RS200HCVNNSL

- Motion Sensor
- Text or e-mail alert when activity is detected
- Set to record short video when activity is present
- Set up to turn on lights when there is activity present
- Simple installation and set up
- Up to 3 year battery life
- For indoor use

Application:

- Use with NEXIA™ Bridge (bridge included in AZTSK500AB32MA, AZTSK500BB32MA, SK101, and BR100 kits)
- Operating Temp -0°C to 49°C
- Range: 60 ft
- Detection area: 20' * 39' (radial distance)
- Detection angle: 90 degrees
- Operating frequency: 908.41 MHz
- Pet immunity: Set at approx. 50 lbs / 22.7 kg. This can be disabled.

Dimensions:

- 3.5"W x 2.5"H x 2"D
- Shipping weight: 1 lb

Remote Sensors

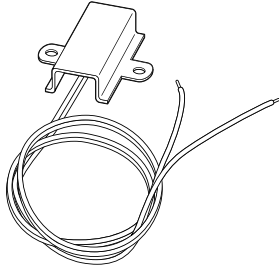

BAYSEN01ATEMPA

- Outdoor Temperature Sensor for Use with ACONT624AS or AZEMT500BB
- Accuracy
+/- 1.5°F over 32°F to 100°F
- Display Range
-40°F to 140°F

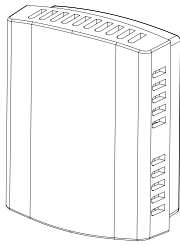

ZZSENSAL0400AA

- Indoor Sensor for Use with ACONT624AS or AZEMT500BB
- Operating Ambient Temperature Range: 20° to 120°F (-6.7° to 48.9°C)
- Display Range: 20° to 120°F (-6.7° to 48.9°C)
- Sensor Accuracy: +/- .5°F at 75°F
- Operating Relative Humidity: 5% to 90% non-condensing

Dimensions in in. (mm):

- 1.54 (39)w x 1.93 (49)h x .625 (1.6)d
- Storage Temperature: -40° to 140°F (-40° to 60°C)
- Finish: White

Table CHS-11-A — eMonitor™ Energy Management Kit

Model No.	Description	Dimensions (in.) H x W x D	Weight (lbs.)
eMonitor 4-14	14 Circuit energy monitor with factory confi. WiFi gateway ^①	17 ¹¹ / ₁₆ X 7 ¹ / ₁₆ X 9 ¹⁵ / ₁₆	5
eMonitor 4-14s	14 Circuit subpanel energy monitor without gateway ^①	17 ¹¹ / ₁₆ X 7 ¹ / ₁₆ X 9 ¹⁵ / ₁₆	5
eMonitor 4-24	24 Circuit energy monitor with factory confi. WiFi gateway ^①	17 ¹¹ / ₁₆ X 7 ¹ / ₁₆ X 9 ¹⁵ / ₁₆	7
eMonitor 4-24s	24 Circuit subpanel energy monitor without gateway ^①	17 ¹¹ / ₁₆ X 7 ¹ / ₁₆ X 9 ¹⁵ / ₁₆	7
eMonitor 4-44	44 Circuit energy monitor with factory confi. WiFi gateway ^①	17 ¹¹ / ₁₆ X 7 ¹ / ₁₆ X 9 ¹⁵ / ₁₆	10
eMonitor 4-44s	44 Circuit subpanel energy monitor without gateway ^①	17 ¹¹ / ₁₆ X 7 ¹ / ₁₆ X 9 ¹⁵ / ₁₆	10
eMonitor 4-24demo	24 Circuit energy monitor with factory confi. WiFi gateway ^② (5 year license key)	17 ¹¹ / ₁₆ X 7 ¹ / ₁₆ X 9 ¹⁵ / ₁₆	7
eMonitor 4-44demo	44 Circuit energy monitor with factory confi. WiFi gateway ^② (5 year license key)	17 ¹¹ / ₁₆ X 7 ¹ / ₁₆ X 9 ¹⁵ / ₁₆	10

① Requires Nexia account and supplemental eMonitor service plan.

② Requires Nexia account - includes 5 year license key - For dealer demo use only; limit 3 per dealership.

Table CHS-11-B — eMonitor™ Energy Management Kit Components

MODEL	150A CT's	50A CT's	20A CT's	EXPANSION PODS	BASE UNIT	GATEWAY	POWER SUPPLY	INSTALLATION INSTRUCTIONS
eMonitor 4-14	2	6	6	0	1	1	1	1
eMonitor 4-14s	0	6	8	0	1	0	1	1
eMonitor 4-24	2	6	16	1	1	1	1	1
eMonitor 4-24s	0	6	18	1	1	0	1	1
eMonitor 4-44	2	10	32	3	1	1	1	1
eMonitor 4-44s	0	10	34	3	1	0	1	1
eMonitor 4-24demo	2	6	16	1	1	1	1	1
eMonitor 4-44demo	2	10	32	3	1	1	1	1

Table CHS-11-C — eMonitor™ Energy Accessories

Model No.	Description
CT150A-6PACK	150 Amp clip on current transformer (CT) - 6 per package (3 pairs)
CT50A-10PACK	50 Amp clip on current transformer (CT) - 10 per package (5 pairs)
CT20A-10PACK	20 Amp clip on current transformer (CT) - 10 per package (5 pairs)
XPOD-W-CTS	10 Circuit expansion module with 8-20 Amp CT's and 2-50 Amp CT's
XPOD-R	10 Circuit expansion module without CT's

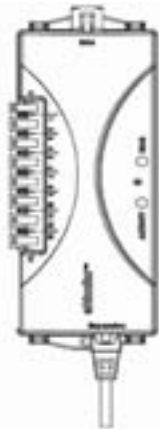

Base Module

Base Module

Connections

- 14 CT Sensor ports
- Six Pin eMonitor™ expansion module
- Modular power connector (120 VAC)

Communication Protocols

- Elink wireless 2.4GHz connection to eMonitor™ gateway
- RS485 LiNK protocol to Pin eMonitor™ expansion pod

Power Requirements

- 120 VAC, 60 Hz connection

Dimensions and Weight

- 7" x 2.5" x 1.875" (L x H x W)
- Weight - 4 oz.

Home Energy Management Accessories

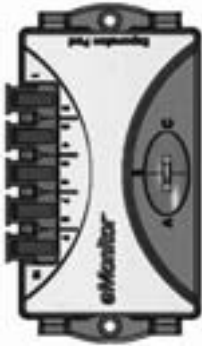

XPOD

XPOD Expansion Pack Connections

- 10 CT Sensor ports
- 2 x Six Pin eMonitor expansion module

Communication Protocols

- RS485 LiNK protocol to Pin eMonitor expansion pod

Power Requirements

- 120 VAC, 60 Hz, 2.5 W

Dimensions and Weight

- 3.75" x 1.875" x 0.875" (L x H x W)
- Weight - 2 oz.

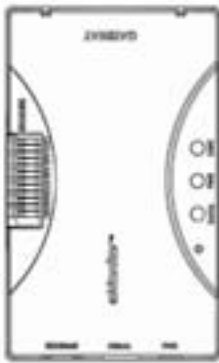

Gateway

Gateway Connections

- 1 x 10/100 RJ-45 Ethernet port
- 1 x High speed RJ-14 serial port
- 3 Analog inputs - Wire pair +/- 2V; 3 digital input/outputs

Communication Protocols

- Wi-Fi/802.11/B (Field convertible to ethernet. Contact Nexia customer support for assistance)
- Wireless 2.4 GHz connection to base module
- TCP-IP via ethernet (802.3) 10/100BASE-T

Power Requirements

- 120 VAC, 60 Hz connection

Dimensions and Weight

- 5.25" x 3.25" x 1.5" (L x H x W)
- Weight - 6 oz.

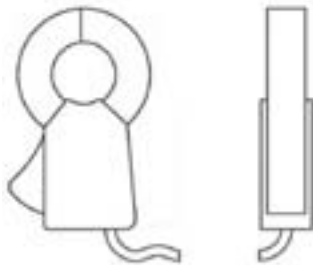

CT150A

150A CT

- Maximum operating voltage: 600 VAC
- Frequency: 50 Hz to 400 Hz
- Leads: 0.61m (2 ft), AWM 1015, twisted pair, 0.34mm² (22AWG), 600V

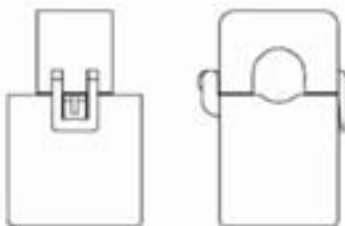

CT50A or CT20A

CT50A or CT20A

- Maximum operating voltage: 720 VAC
- Frequency: 50 Hz to 400 Hz
- Leads: 0.61m (2 ft), AWM 1015, twisted pair, 0.34mm² (22AWG), 600V

Split System Variable Speed Cooling Single Phase – 2-5 Tons

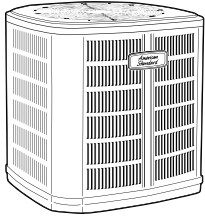

**Platinum ZV - 4A7V0
(Variable Speed)**

Table SC-1-A — Platinum ZV R-410A Split System Variable Speed Cooling (30–100% capacity)—with AccuLink™ ①

Model Number	Power Supply	Uncrated Dimensions(in.)			Shipping Weight (lbs.)	Sound** Rating	MCA*	Max. Fuse*	Line Size (in)	
		H	W	D					OD Gas	OD Liq.
4A7V0024A1000A	208/230/1/60	41	33	30	217	57/66	17	25	5/8	3/8
4A7V0036A1000A	208/230/1/60	41	33	30	228	55/70	18	25	3/4	3/8
4A7V0048A1000A	208/230/1/60	41	37	34	270	57/74	23	35	7/8	3/8
4A7V0060A1000A	208/230/1/60	45	37	34	284	62/75	27	40	1 1/8	3/8

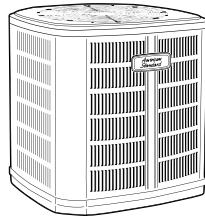

**Platinum XV - 4A7V8
(Variable Speed)**

Table SC-1-B — Platinum XV R-410A Split System Variable Speed Cooling (30–100% capacity)—with AccuLink™ ①

Model Number	Power Supply	Uncrated Dimensions(in.)			Shipping Weight (lbs.)	Sound** Rating	MCA*	Max. Fuse*	Line Size (in)	
		H	W	D					Gas	Liq.
4A7V8024A1000A	208/230/1/60	41	33	30	217	57/66	17	25	5/8	3/8
4A7V8036A1000A	208/230/1/60	41	33	30	228	55/70	18	25	3/4	3/8
4A7V8048A1000A	208/230/1/60	41	37	34	270	57/74	23	35	7/8	3/8
4A7V8060A1000A	208/230/1/60	45	37	34	284	62/75	27	40	1 1/8	3/8

① Must use ACONT850 or AZONE950 control.

* Information subject to change. Please confirm with current Product Data/Service Facts for current factory production.

** Rated in accordance with AHRI Standard 270-2008 (Min/Max when applicable).

Split System Variable Speed Cooling Single Phase – 2-5 Tons

Split System Cooling

Table SC-2-A — Features	(4A7V0)	(4A7V8)
• SEER up to	21.00	18.00
• Duration™ compressor	1	1
• Number of stages	Variable	Variable
• Comfort-R™ mode approved	✓	✓
• AccuLink™ system	✓	✓
• Charge Assist™ fast/accurate charging every time	—	—
• DuraBase™ base, fast complete drain, weatherproof	✓	✓
• Easy-Sess™ cabinet, service access	✓	✓
• Spine Fin™ coil	✓	✓
• Compressor sound enclosure	✓	✓
• Compressor sump heat - factory installed	✓	✓
• Factory supplied charge	R-410A	R-410A
• Glossy corrosion resistant finish	✓	✓
• High pressure switch	✓	✓
• Low pressure switch	✓	✓
• Internal high / low pressure & temperature protection	✓	✓
• Liquid line filter drier - factory installed or factory supplied for field install	✓	✓
• Quick start kit-factory installed	NA	NA
• Seacoast shield - factory installed	✓	—
• Spinnaker gray cabinet	✓	✓
• 12-year registered limited warranty on compressor, 10-year on outdoor coil & all other functional parts (Residential Use)①	✓	—
• 10-year registered limited warranty on compressor, outdoor coil & all other functional parts (Residential Use)①	—	✓
• Extended warranties available	✓	✓

Table SC-2-B — Optional Accessories

Model Number	Description	Shipping Weight	(4A7V0)	(4A7V8)
AY28X079.....	Evaporator defrost control	1	—	—
BAYACHP024A.....	24 Volt Wiring Harness	1	—	—
BAYCAKT001	Charge Assist™ Solenoid Kit	3	—	—
BAYCCHT300	Crankcase Heater Kit (Reciprocating).....	1	—	—
BAYCCHT301	Crankcase Heater Kit (Scroll).....	1	—	—
BAYCCHT302	Crankcase Heater Kit (Scroll).....	1	—	—
BAYECMT023	Extreme Conditions Mounting Kit (Base 2/3)	2	2-3	2-3
BAYECMT004	Extreme Conditions Mounting Kit (Base 4)	2	4-5	4-5
BAYISLT101	Rubber Isolators	1	✓	✓
BAYKSKT263	Start kit	1	—	—
BAYKSKT266	Start kit	1	—	—
BAYLEGS002.....	Snow Legs - Base and Cap 6" High (Black).....	1	✓	✓
BAYLEGS003.....	4" Extension (Black)	1	✓	✓
BAYSEAC001.....	Seacoast Kit	1	—	✓
TAYASCT501A②③.....	Anti-Short Cycle Timer	2	—	—
PAI00309④.....	Heresite Spraypaint.....	1	✓	✓

Comfort Controls — See Comfort Controls/Zone Sensors Section

① Registered Limited Warranty terms are available when you register within 60 days of installation. You can register online at americanstandardair.com or by phone at 800-554-8005; otherwise American Standard Heating & Air Conditioning's Base Limited Warranty terms will apply. Base Limited Warranty information on specific products can be found on ASDealerNet.com.
 ② Not for use with programmable thermostats.
 ③ Activated on power off.
 ④ Used for additional seacoast corrosion protection. Refer to bulletin number UN-SVB11A-EN for application information.

Split System Cooling Single Phase - 1½-5 Tons

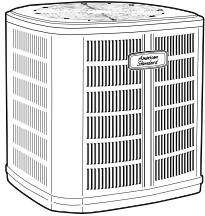

**Platinum ZM - 4A7Z0
(Two Stage)**

Table SC-3-A — Platinum ZM R-410A Split System Two Stage Cooling (50/100% capacity) — with AccuLink™^{①②}

Model Number	Power Supply	Nom. Cap. Cooling (BTUH)	Uncrated Dimensions(in.)			Shipping Weight (lbs.)	Sound** Rating	MCA*	Max. Fuse*	Line Size	
			H	W	D					OD Gas	OD Liq.
4A7Z0024A1000C	208/230/1/60	24,000	45	37	34	375	68	14	20	¾	¾
4A7Z0036B1000A	208/230/1/60	36,000	45	37	34	375	72	19	30	¾	¾
4A7Z0048B1000A	208/230/1/60	48,000	45	37	34	460	76	26	40	7/8	¾
4A7Z0060A1000C	208/230/1/60	60,000	45	37	34	460	76	31	50	7/8	¾

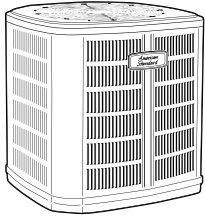

**Platinum XM - 4A7A7
(Two Stage)**

Table SC-3-B — Platinum XM R-410A Split System Two Stage Cooling (70/100% capacity) — with AccuLink™^{①②}

Model Number	Power Supply	Nom. Cap. Cooling (BTUH)	Uncrated Dimensions(in.)			Shipping Weight (lbs.)	Sound** Rating	MCA*	Max. Fuse*	Line Size (in)	
			H	W	D					OD Gas	OD Liq.
4A7A7024A1C00A	208/230/1/60	24,000	41	37	34	276	72	18	20	5/8	¾
4A7A7036A1C00A	208/230/1/60	36,000	45	37	34	283	72	24	35	¾	¾
4A7A7048A1C00A	208/230/1/60	48,000	45	37	34	308	73	28	45	7/8	¾
4A7A7060A1C00A	208/230/1/60	60,000	45	37	34	312	74	37	60	1 1/8	¾

Platinum XM 4A7A7 - Coming Soon as AccuLink™ Communicating Systems!

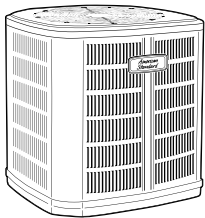

**Platinum XM - 4A7A7
(Two Stage)**

Table SC-3-C — Platinum XM R-410A Split System Two Stage Cooling (70/100% capacity)

Model Number	Power Supply	Nom. Cap. Cooling (BTUH)	Uncrated Dimensions(in.)			Shipping Weight (lbs.)	Sound** Rating	MCA*	Max. Fuse*	Line Size (in)	
			H	W	D					OD Gas	OD Liq.
4A7A7024A1000A	208/230/1/60	24,000	41	37	34	276	72	18	20	5/8	¾
4A7A7036A1000A	208/230/1/60	36,000	45	37	34	283	72	24	35	¾	¾
4A7A7048A1000A	208/230/1/60	48,000	45	37	34	308	73	28	45	7/8	¾
4A7A7060A1000A	208/230/1/60	60,000	45	37	34	312	74	37	60	1 1/8	¾

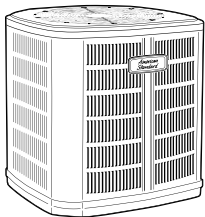

**Gold XI - 4A7A6
(Single Stage)**

Table SC-3-D — Gold XI R-410A Split System Single Stage Cooling

Model Number	Power Supply	Nom. Cap. Cooling (BTUH)	Uncrated Dimensions(in.)			Shipping Weight (lbs.)	Sound** Rating	MCA*	Max. Fuse*	Line Size	
			H	W	D					OD Gas	OD Liq.
4A7A6018H1000A	208/230/1/60	18,000	29	33	30	200	75	9	15	5/8	¾
4A7A6024H1000A	208/230/1/60	24,000	29	33	30	201	75	9	15	¾	¾
4A7A6030H1000A	208/230/1/60	30,000	33	37	34	234	75	12	20	¾	¾
4A7A6036H1000A	208/230/1/60	36,000	37	37	34	228	75	19	30	¾	¾
4A7A6042H1000A	208/230/1/60	42,000	41	37	34	272	75	23	40	7/8	¾
4A7A6048H1000A	208/230/1/60	48,000	45	37	34	282	75	26	45	7/8	¾
4A7A6049H1000B	208/230/1/60	48,000	45	37	34	304	74	26	45	7/8	¾
4A7A6060H1000A	208/230/1/60	60,000	45	37	34	285	75	34	60	7/8	¾
4A7A6061H1000A ^③	208/230/1/60	60,000	45	37	34	312	75	45	60	1 1/8	¾

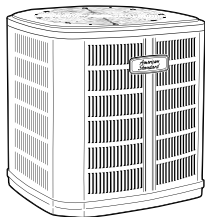

**Gold SI - 4A7A3
(Single Stage)**

Table SC-3-E — Gold SI R-410A Split System Single Stage Cooling

Model Number	Power Supply	Nom. Cap. Cooling (BTUH)	Uncrated Dimensions(in.)			Shipping Weight (lbs.)	Sound** Rating	MCA*	Max. Fuse*	Line Size	
			H	W	D					OD Gas	OD Liq.
4A7A3018G1000A	208/230/1/60	17,000	29	33	30	167	70	12	20	5/8	¾
4A7A3024G1000A	208/230/1/60	23,000	29	33	30	169	71	17	25	5/8	¾
4A7A3030G1000A	208/230/1/60	28,500	29	33	30	180	71	19	30	¾	¾
4A7A3036E1000A	208/230/1/60	34,500	33	33	30	197	71	22	35	¾	¾
4A7A3042D1000A	208/230/1/60	40,500	29	37	34	228	74	26	45	¾	¾
4A7A3048D1000A	208/230/1/60	46,500	29	37	34	235	75	28	50	7/8	¾
4A7A3060D1000A	208/230/1/60	58,500	37	37	34	261	75	35	60	7/8	¾

① Must use ACONT850, ACONT900 or AZONE950 control. ② BAYACHP024A required for 24 volt mode. ③ 1 compressor, 2 stages.
* Information subject to change. Please confirm with current Product Data/Service Facts for current factory production.
** Rated in accordance with AHRI Standard 270-2008 (Min/Max when applicable).

Split System Cooling Single Phase - 1½-5 Tons

Split System Cooling

Table SC-4-A — Features	(4A7Z0)	(4A7A7)	(4A7A7)	(4A7A6)	(4A7A3)
• SEER up to	20.00	18.00	18.00	17.00	14.50
• Duration™ compressor	2	1	1	1	1
• Number of stages	2	2	2	1	1
• Comfort-R™ mode approved	✓	✓	✓	✓	✓
• AccuLink™ system	✓	✓	—	—	—
• Charge Assist™ fast/accurate charging every time	✓	—	—	—	—
• DuraBase™ base, fast complete drain, weatherproof	✓	✓	✓	✓	✓
• Easy-Sess™ cabinet, service access	✓	✓	✓	✓	✓
• Spine Fin™ coil	✓	✓	✓	✓	✓
• Compressor sound enclosure	✓	—	—	018-048,060	—
• Compressor sump heat - factory installed	✓	—	—	—	—
• Factory supplied charge	R-410A	R-410A	R-410A	R-410A	R-410A
• Glossy corrosion resistant finish	✓	✓	✓	✓	✓
• High pressure switch	✓	✓	✓	✓	✓
• Low pressure switch	✓	✓	✓	—	—
• Internal high / low pressure & temperature protection	✓	✓	✓	✓	✓
• Liquid line filter drier - factory installed or factory supplied for field install	✓	✓	✓	✓	✓
• Quick start kit-factory installed	✓	—	—	018-030	—
• Seacoast shield - factory installed	✓	✓	✓	✓	✓
• Spinnaker gray cabinet	✓	✓	✓	—	—
• 12-year registered limited warranty on compressor, 10-year on outdoor coil & all other functional parts (Residential Use)①	✓	✓	✓	—	—
• 10-year registered limited warranty on compressor, outdoor coil & all other functional parts (Residential Use)①	—	—	—	✓	✓
• Extended warranties available	✓	✓	✓	✓	✓

Table SC-4-B — Optional Accessories

Model Number	Description	Shipping Weight	(4A7Z0)	(4A7A7)	(4A7A7)	(4A7A6)	(4A7A3)
AY28X079.....	Evaporator defrost control	1.....	—	—	—	—	✓
BAYACHP024A.....	24 Volt Wiring Harness	1.....	✓	✓	—	—	—
BAYCAKT001.....	Charge Assist™ Solenoid Kit	3.....	✓	—	—	—	—
BAYCCHT300.....	Crankcase Heater Kit (Reciprocating)	1.....	—	—	—	—	1½-3
BAYCCHT301.....	Crankcase Heater Kit (Scroll)	1.....	—	✓	✓	✓	3½-5
BAYECMT023.....	Extreme Conditions Mounting Kit (Base 2/3).....	2.....	—	—	—	—	1½-3
BAYECMT004.....	Extreme Conditions Mounting Kit (Base 4).....	2.....	✓	✓	✓	✓	3½-5
BAYISLT101.....	Rubber Isolators.....	1.....	✓	✓	✓	✓	✓
BAYKSKT263.....	Start kit.....	1.....	—	2-3	2-3	036-060	✓
BAYKSKT266.....	Start kit.....	1.....	—	4-5	4-5	061	✓
BAYLEGS002.....	Snow Legs - Base and Cap 6" High (Black)	1.....	✓	✓	✓	✓	✓
BAYLEGS003.....	4" Extension (Black)	1.....	✓	✓	✓	✓	✓
BAYLOAM103.....	Low Ambient Kit	1.....	—	—	—	—	✓
BAYSEAC001.....	Seacoast Kit	1.....	—	—	—	✓	✓
TAYASCT501A②③.....	Anti-Short Cycle Timer	2.....	—	—	—	✓	✓
PAI00309④.....	Heresite Spraypaint.....	1.....	✓	✓	✓	✓	✓

Comfort Controls — See Comfort Controls/Zone Sensors Section

- ① Registered Limited Warranty terms are available when you register within 60 days of installation. You can register online at americanstandardair.com or by phone at 800-554-8005; otherwise American Standard Heating & Air Conditioning's Base Limited Warranty terms will apply. Base Limited Warranty information on specific products can be found on ASDealerNet.com.
- ② Not for use with programmable thermostats.
- ③ Activated on power off.
- ④ Used for additional seacoast corrosion protection. Refer to bulletin number UN-SVB11A-EN for application information.
- ⑤ For applications requiring BAYLOAM103, an 8x8 weather proof electrical enclosure is required in order to locate the low ambient controller external to the unit.

Split System Cooling Single Phase - 1½-5 Tons

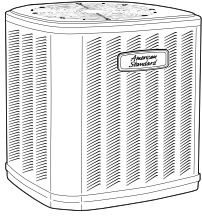

**Silver XI - 4TTB6
(Single Stage)**

Table SC-5-A — Silver XI R-410A Split System Single Stage Cooling

Model Number	Power Supply	Nom. Cap. Cooling (BTUH)	Uncrated Dimensions(in.)			Shipping Weight (lbs.)	Sound** Rating	MCA*	Max. Fuse*	Line Size (in)	
			H	W	D					OD Gas	OD Liq.
4TTB6018A1000A	208/230/1/60	18,000	29	33	30	200	79	9	15	5/8	3/8
4TTB6024A1000A	208/230/1/60	24,000	29	33	30	201	79	9	15	3/4	3/8
4TTB6030A1000A	208/230/1/60	30,000	33	37	34	234	80	15	25	3/4	3/8
4TTB6036A1000A	208/230/1/60	36,000	37	37	34	228	78	19	30	3/4	3/8
4TTB6042A1000A	208/230/1/60	42,000	41	37	34	272	80	23	40	7/8	3/8
4TTB6048A1000A	208/230/1/60	48,000	45	37	34	282	80	26	45	7/8	3/8
4TTB6049A1000A	208/230/1/60	48,000	45	37	34	304	76	26	45	7/8	3/8
4TTB6060A1000A	208/230/1/60	60,000	45	37	34	285	80	34	60	7/8	3/8
4TTB6061A1000A①	208/230/1/60	60,000	45	37	34	312	76	45	60	1½	3/8

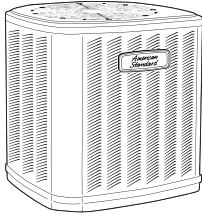

**Silver SI - 4TTB3
(Single Stage)**

Table SC-5-B — Silver SI R-410A Split System Single Stage Cooling

Model Number	Power Supply	Nom. Cap. Cooling (BTUH)	Uncrated Dimensions(in.)			Shipping Weight (lbs.)	Sound** Rating	MCA*	Max. Fuse*	Line Size (in)	
			H	W	D					OD Gas	OD Liq.
4TTB3018H1000A	208/230/1/60	17,000	29	29	26	150	74	12	20	3/4	3/8
4TTB3024H1000A	208/230/1/60	23,000	29	29	26	150	74	18	30	3/4	3/8
4TTB3030G1000A	208/230/1/60	28,500	29	33	30	180	76	19	30	3/4	3/8
4TTB3036E1000A	208/230/1/60	34,500	29	33	30	186	74	20	35	3/4	3/8
4TTB3042D1000C	208/230/1/60	40,500	29	37	34	228	79	26	45	3/4	3/8
4TTB3048D1000C	208/230/1/60	46,500	29	37	34	235	79	28	50	7/8	3/8
4TTB3060D1000C	208/230/1/60	58,500	37	37	34	261	80	35	60	7/8	3/8

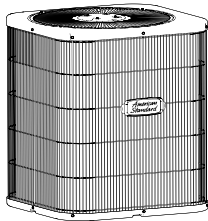

**Silver SI - 4TTM3
(Single Stage)**

Table SC-5-C — Silver SI R-410A Split System Single Stage Cooling

Model Number	Power Supply	Nom. Cap. Cooling (BTUH)	Uncrated Dimensions(in.)			Shipping Weight (lbs.)	Sound** Rating	MCA*	Max. Fuse*	Line Size (in)	
			H	W	D					OD Gas	OD Liq.
4TTM3018A1000C	208/230/1/60	18,000	29	25½	23½	177	78	10	15	5/8	3/8
4TTM3024B1000A	208/230/1/60	24,000	29	25½	23½	155	78	16.9	30	5/8	3/8
4TTM3030B1000A	208/230/1/60	29,400	29	25½	23½	156	78	18.5	30	3/4	3/8
4TTM3036A1000C	208/230/1/60	34,400	29	25½	23½	184	78	18	30	3/4	3/8
4TTM3042A1000D	208/230/1/60	42,000	29	29	28½	190	79	27	45	7/8	3/8
4TTM3048A1000D	208/230/1/60	47,000	29	29	28½	191	79	29	50	7/8	3/8
4TTM3060A1000D	208/230/1/60	58,000	29	29	28½	194	79	35	60	7/8	3/8

① 1 compressor, 2 stages.

* Information subject to change. Please confirm with current Product Data/Service Facts for current factory production.

** Rated in accordance with AHRI Standard 270-2008.

Split System Cooling Single Phase – 1½-5 Tons

Split System Cooling

Table SC-8-A — Features

	(4TTB6)	(4TTB3)	(4TTM3)
• SEER up to	16.00	14.00	14.00
• Comfort-R™ mode approved.....	✓	✓	✓
• Charge Assist™ fast/accurate charging every time	—	—	✓
• DuraBase™ base, fast complete drain, weatherproof	✓	✓	—
• Easy-Sess™ cabinet, service access & refrigerant connections with full coil protection	✓	✓	—
• Spine Fin™ coil	✓	✓	—
• Refrigerant	R-410A	R-410A	R-410A
• Glossy corrosion resistant finish	✓	✓	✓
• High pressure switch	✓	✓	✓
• Compressor sound enclosure	1½-2½	—	—
• Internal high / low pressure & temperature protection	✓	✓	✓
• Liquid line filter drier - factory installed or factory supplied for field install	✓	✓	✓
• Polyslate gray cabinet	✓	✓	—
• Tarpolin gray cabinet	—	—	✓
• Start kit - factory installed.....	1½-2½	—	1½,3,5
• 10-year registered limited warranty on compressor, outdoor coil & all other functional parts (Residential Use)®	✓	✓	✓
• Extended warranties available	✓	✓	✓

Table SC-8-B — Optional Accessories

Model Number	Description	Shipping Weight	(4TTB6)	(4TTB3)	(4TTM3)
AY28X079.....	Evap. Defrost Control Kit	1	✓	✓	✓
BAYCAKT001.....	Charge Assist™ Solenoid Kit.....	3	—	—	✓
BAYCCHT300.....	Crankcase Heater Kit (Reciprocating)	1	1½-2½	—	1½,3
BAYCCHT301.....	Crankcase Heater Kit (Scroll)	1	3½-5	✓	2,2½,3½,4,5
BAYCCHT302.....	Crankcase Heater Kit (Scroll)	1	3	—	—
BAYECMT023.....	Extreme Conditions Mounting Kit (Base 2/3).....	2	1½-2	1½-3	—
BAYECMT004.....	Extreme Conditions Mounting Kit (Base 4)	2	2½-5	3½-5	—
BAYECMT021.....	Extreme Conditions Mounting Kit.....	2	—	—	✓
BAYISLT101.....	Rubber Isolators.....	1	✓	✓	✓
BAYKSKT263.....	Start Kit	036-060	✓	2,2½,3½,4
BAYKSKT266.....	Start Kit	1	061	—	—
BAYLEGS002.....	Snow Legs - Base and Cap 6" High (Black)	1	✓	✓	—
BAYLEGS003.....	4" Extension (Black)	1	✓	✓	—
BAYLOAM103.....	Low Ambient Kit	1	✓	✓	✓ ^⑤
BAYSEAC001.....	Seacoast Kit	1	✓	✓	—
TAYASCT501A ^{①②}	Anti-Short Cycle Timer	2	✓	✓	—
PAI00309 ^④	Heresite Spraypaint.....	1	✓	✓	—

Comfort Controls — See Comfort Controls/Zone Sensors Section

- ① Not for use with programmable thermostats.
- ② Activated on Power Off.
- ③ Registered Limited Warranty terms are available when you register within 60 days of installation. You can register online at trane.com or by phone at 800-554-6413; otherwise Trane Base Limited Warranty terms will apply. Base Limited Warranty information on specific products can be found on Comfordsite.com.
- ④ Used for additional seacoast corrosion protection. Refer to bulletin number UN-SVB11A-EN for application information.
- ⑤ For applications requiring BAYLOAM103, an 8x8 weather proof electrical enclosure is required in order to locate the low ambient controller external to the unit.

Split System Cooling Three Phase and R-22

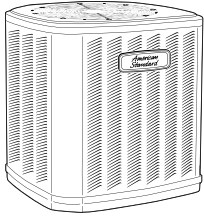

**Silver SI - 4TTA3
(Single Stage)**

Table SC-7-A — Silver SI R-410A Split System Single Stage Cooling

Model Number	Power Supply	Nom. Cap. Cooling (BTUH)	Uncrated Dimensions(in.)			Shipping Weight (lbs.)	Sound** Rating	MCA*	Max. Fuse*	Line Size (in)	
			H	W	D					OD Gas	OD Liq.
4TTA3030A3000C	208/230/3/60	30,000	33	33	30	224	78	10	15	3/4	3/8
4TTA3036B3000A	208/230/3/60	36,000	29	33	30	176	78	14	20	3/4	3/8
4TTA3042D3000C	208/230/3/60	42,000	29	37	34	228	79	18	30	3/4	3/8
4TTA3048D3000C	208/230/3/60	48,000	29	37	34	235	79	18	30	7/8	3/8
4TTA3060D3000C	208/230/3/60	60,000	37	37	34	261	80	21	35	7/8	3/8
4TTA3030A4000C	460/3/60	30,000	33	33	30	222	78	5	15	3/4	3/8
4TTA3036B4000A	460/3/60	36,000	29	33	30	176	78	8	15	3/4	3/8
4TTA3042D4000C	460/3/60	42,000	33	37	34	228	79	8	15	3/4	3/8
4TTA3048D4000C	460/3/60	48,000	33	37	34	235	79	8	15	7/8	3/8
4TTA3060D4000C	460/3/60	60,000	41	37	34	261	80	10	15	7/8	3/8

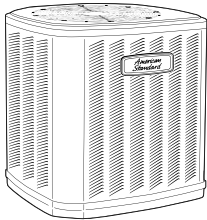

**Silver SI - 2TTB3
(Single Stage)**

Table SC-7-B — Silver SI R-22 Split System Dry Ship Replacement Single Stage Cooling

Model Number	Power Supply	Nom. Cap. Cooling (BTUH)	Uncrated Dimensions(in.)			Shipping Weight (lbs.)	Sound** Rating	MCA*	Max. Fuse*	Line Size	
			H	W	D					OD Gas	OD Liq.
2TTB3018A1000C	208/230/1/60	17,000	26	29	26	182	76	8	15	5/8	1/4
2TTB3024A1000C	208/230/1/60	23,000	33	29	26	195	78	12	20	3/4	5/16
2TTB3030A1000C	208/230/1/60	28,500	33	33	30	225	78	13	20	3/4	5/16
2TTB3036A1000C	208/230/1/60	34,500	33	33	30	205	76	21	35	7/8	3/8
2TTB3042A1000C	208/230/1/60	40,500	33	37	34	283	79	21	35	7/8	3/8
2TTB3048A1000C	208/230/1/60	46,500	41	37	34	307	79	25	40	1 1/8	3/8
2TTB3060A1000C	208/230/1/60	58,500	41	37	34	280	79	33	50	1 1/8	3/8

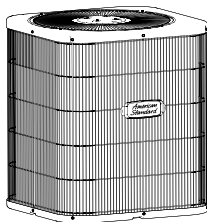

**Silver SI - 2TTM3
(Single Stage)**

Table SC-7-C — Silver SI R-22 Split System Dry Ship Replacement Single Stage Cooling

Model Number	Power Supply	Nom. Cap. Cooling (BTUH)	Uncrated Dimensions(in.)			Shipping Weight (lbs.)	Sound** Rating	MCA*	Max. Fuse*	Line Size (in)	
			H	W	D					OD Gas	OD Liq.
2TTM3018A1000A①	208/230/1/60	18,000	29	25 1/2	23 1/2	161	72	11.5	20	5/8	3/8
2TTM3024A1000A①	208/230/1/60	24,000	29	25 1/2	23 1/2	161	72	11.5	20	5/8	3/8
2TTM3030A1000A①	208/230/1/60	29,400	29	25 1/2	23 1/2	170	77	13.9	20	3/4	3/8
2TTM3036A1000A	208/230/1/60	34,400	29	25 1/2	23 1/2	152	77	20.6	35	3/4	3/8
2TTM3042A1000A	208/230/1/60	42,000	29	29	28 1/2	192	79	26.6	45	7/8	3/8
4TTM3048A1000A	208/230/1/60	47,000	29	29	28 1/2	192	79	26.6	45	7/8	3/8
2TTM3060A1000A	208/230/1/60	58,000	29	29	28 1/2	198	79	33.3	50	7/8	3/8

① 2TTM3018-030 units combined with indoor coils having non-equalizing expansion valves may require the use of a hard start or start assist kit. Follow the outdoor unit manufacturer's guidelines.

* Information subject to change. Please confirm with current Product Data/Service Facts for current factory production.

** Rated in accordance with AHRI Standard 270-2008.

Split System Cooling Three Phase and R-22

Split System Cooling

Table SC-8-A — Features

	4TTA3	(2TTB3)	(2TTM3)
• SEER up to	14.50	13.25	14.75
• Comfort-R™ mode approved.....	✓	✓	✓
• DuraBase™ base, fast complete drain, weatherproof	✓	✓	✓
• Easy-Sess cabinet, service access & refrigerant connections with full coil protection	✓	✓	✓
• Spine Fin™ coil	✓	✓	✓
• Duration™ coil	✓	—	✓
• Refrigerant - (R-22 not factory supplied).....	R-410A	R-22	R-22
• Glossy corrosion resistant finish	✓	✓	✓
• Compressor sound enclosure	—	3½-4	✓
• Internal high / low pressure & temperature protection	✓	✓	✓
• Liquid line filter drier - factory installed or factory supplied for field install	✓	✓	✓
• Polyslate gray cabinet	✓	✓	✓
• Start kit - factory installed.....	—	1½-2½,3½-4	✓
• High and low pressure switch	✓	—	✓
• Tarpolin gray cabinet	—	✓	✓
• 5-year registered limited warranty on compressor, outdoor coil and 1-year on all other functional parts (Commercial Use)	✓	—	✓
• 5-year registered limited warranty on compressor, outdoor coil & all other functional parts (Residential Use)③	—	✓	✓
• Extended warranties available	✓	✓	✓

Table SC-8-B — Optional Accessories

Model Number	Description	Shipping Weight	4TTA3	(2TTB3)	(2TTM3)
AY28X079.....	Evap. Defrost Control Kit	1	✓	✓	✓
BAYCCHT300	Crankcase Heater Kit (Reciprocating)	1	—	1½-2½,3½-4	1½-2½
BAYCCHT301	Crankcase Heater Kit (Scroll)	1	—	3,5	3-5
BAYECMT023	Extreme Conditions Mounting Kit (Base 2/3).....	2	2½-3	1½-3	—
BAYECMT004	Extreme Conditions Mounting Kit (Base 4)	2	3½-5	3½-5	—
BAYECMT021	Extreme Conditions Mounting Kit.....	—	—	—	✓
BAYISLT101	Rubber Isolators.....	1	✓	✓	✓
BAYKSKT260.....	Start Kit	1	—	3	1½-2½
BAYKSKT263	Start kit.....	—	—	5	3-5
BAYLEGS002	Snow Legs - Base and Cap 6" High (Black)	1	✓	✓	—
BAYLEGS003	4" Extension (Black)	1	✓	✓	—
BAYLOAM103	Low Ambient Kit	1	✓	✓	✓④
BAYSDEN001	Single Cylinder Compressor Enclosures	8	2½	1½-2½	—
BAYSDEN003	Small Scroll Compressor Enclosures.....	8	3-4	3	—
BAYSDEN004	Large Scroll Compressor Enclosures	8	5	5	—
BAYSEAC001	Seacoast Kit	1	✓	✓	—
TAYASCT501A①②	Anti-Short Cycle Timer	2	✓	✓	—

Comfort Controls — See Comfort Controls/Zone Sensors Section

- ① Not for use with programmable thermostats.
- ② Activated on Power Off.
- ③ Registered Limited Warranty terms are available when you register within 60 days of installation. You can register online at americanstandardair.com or by phone at 800-554-8005; otherwise American Standard Heating & Air Conditioning's Base Limited Warranty terms will apply. Base Limited Warranty information on specific products can be found on ASDealerNet.com.
- ④ For applications requiring BAYLOAM103, an 8x8 weather proof electrical enclosure is required in order to locate the low ambient controller external to the unit.

Split System Variable Speed Heat Pumps Single Phase – 2-5 Tons

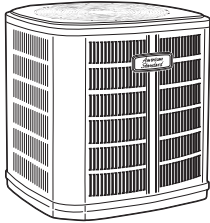

**Platinum ZV - 4A6V0
(Variable Speed)**

Table SH-1-A — Platinum ZV R-410A Split System Variable Speed Heat Pump (25–100% capacity)—with AccuLink™ ①

Model Number	Power Supply	Uncrated Dimensions(in.)			Shipping Weight (lbs.)	Sound** Rating		MCA*	Max. Fuse*	Line Size (in)	
		H	W	D		(Cool)	(Heat)			OD Gas	OD Liq.
4A6V0024A1000A	208/230/1/60	41	33	30	216	54/65	60/69	17	25	5/8	3/8
4A6V0036A1000A	208/230/1/60	41	37	34	254	59/70	60/72	26	40	3/4	3/8
4A6V0048A1000A	208/230/1/60	41	37	34	266	61/74	62/76	29	45	7/8	3/8
4A6V0060A1000A	208/230/1/60	45	37	34	276	57/73	61/74	37	50	1 1/8	3/8

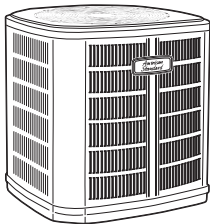

**Platinum XV - 4A6V8
(Variable Speed)**

Table SH-1-B — Platinum XV R-410A Split System Variable Speed Heat Pump (25–100% capacity)—with AccuLink™ ①

Model Number	Power Supply	Uncrated Dimensions(in.)			Shipping Weight (lbs.)	Sound** Rating		MCA*	Max. Fuse*	Line Size (in)	
		H	W	D		(Cool)	(Heat)			OD Gas	OD Liq.
4A6V8024A1000A	208/230/1/60	41	33	30	216	54/65	60/69	17	25	5/8	3/8
4A6V8036A1000A	208/230/1/60	41	33	30	229	56/70	60/74	25	35	3/4	3/8
4A6V8037A1000A	208/230/1/60	41	37	34	254	56/70	60/74	26	40	3/4	3/8
4A6V8048A1000A	208/230/1/60	41	37	34	259	61/74	62/76	28	40	7/8	3/8
4A6V8049A1000A	208/230/1/60	41	37	34	266	61/74	62/76	29	45	7/8	3/8
4A6V8060A1000A	208/230/1/60	45	37	34	276	57/73	61/74	37	50	1 1/8	3/8

① Must use ACONT850 or AZONE950 control.

* Information subject to change. Please confirm with current Product Data/Service Facts for current factory production.

** Rated in accordance with AHRI Standard 270-2008 (Min/Max when applicable).

Split System Variable Speed Heat Pumps Single Phase - 2-5 Tons

Table SH-2-A — Features	(4A6V0)	(4A6V8)
• SEER up to	20.00	18.00
• HSPF up to	10.00	10.00
• Duration™ compressor	1	1
• Number of stages	Variable	Variable
• Comfort-R™ mode approved	✓	✓
• AccuLink™ system	✓	✓
• Charge Assist™ fast/accurate charging every time	—	—
• DuraBase™ base, fast complete drain, weatherproof	✓	✓
• Easy-Sess™ cabinet, service access & refrigerant connections with full coil protection	✓	✓
• Spine Fin™ coil	✓	✓
• Compressor sound enclosure	✓	✓
• Compressor sump heat - factory installed	✓	✓
• Factory supplied charge	R-410A	R-410A
• Glossy corrosion resistant finish	✓	✓
• High pressure switch	✓	✓
• Low pressure switch	✓	✓
• Internal high / low pressure & temperature protection	✓	✓
• Liquid line filter drier - factory installed or factory supplied for field install	✓	✓
• Start kit-factory installed	NA	NA
• Seacoast shield - factory installed	✓	—
• Tarpaulin gray cabinet	✓	✓
• 12-year registered limited warranty on compressor, 10-year on outdoor coil & all other functional parts (Residential Use)③	✓	—
• 10-year registered limited warranty on compressor, outdoor coil & all other functional parts (Residential Use)③	—	✓
• Extended warranties available	✓	✓

Table SH-2-B — Optional Accessories

Model Number	Description	Shipping Weight	(4A6V0)	(4A6V8)
AY28X079	Evaporator defrost control kit	1	—	—
BAYACHP024A	24 Volt Wiring Harness	1	—	—
BAYCAKT001	Charge Assist™ Solenoid Kit	3	—	—
BAYECMT023	Extreme Conditions Mounting Kit (Base 2/3)	2	2	024-036
BAYECMT004	Extreme Conditions Mounting Kit (Base 4)	2	3-5	037-060
BAYISLT101	Rubber Isolators	1	✓	✓
BAYLEGS002	Snow Legs - Base and Cap 6" High (Black)	1	✓	✓
BAYLEGS003	4" Extension (Black)	1	✓	✓
BAYSEAC001	Seacoast Kit	1	—	✓
TAYASCT501A①②	Anti-Short Cycle Timer	2	—	—
PAI00309④	Heresite Spraypaint	1	✓	✓

Comfort Controls — See Comfort Controls/Zone Sensors Section

① Not for use with programmable thermostats.

② Activated on Power Off.

③ Registered Limited Warranty terms are available when you register within 60 days of installation. You can register online at trane.com or by phone at 800-554-6413; otherwise Trane Base Limited Warranty terms will apply. Base Limited Warranty information on specific products can be found on Comfortsite.com.

④ Used for additional seacoast corrosion protection. Refer to bulletin number UN-SVB11A-EN for application information.

Split System Heat Pumps Single Phase – 1½-5 Tons

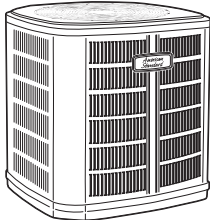

**Platinum ZM - 4A6Z0
(Two Stage)**

Table SH-3-A — Platinum ZM R-410A Split System Two Stage Heat Pump (50/100% capacity) — with AccuLink™^{①②}

Model Number	Power Supply	Nom. Cap. Cooling (BTUH)	Uncrated Dimensions(in.)			Shipping Weight (lbs.)	Sound** Rating	MCA*	Max. Fuse*	Line Size	
			H	W	D					OD Gas	OD Liq.
4A6Z0024A1000C	208/230/1/60	24,000	45	37	34	380	70	14	20	5/8	3/8
4A6Z0036B1000A	208/230/1/60	36,000	45	37	34	385	72	20	30	3/4	3/8
4A6Z0048B1000A	208/230/1/60	48,000	45	37	34	470	76	26	40	3/4	3/8
4A6Z0060A1000C	208/230/1/60	60,000	45	37	34	470	76	31	50	3/4	3/8

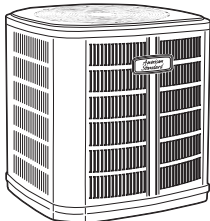

**Platinum XM - 4A6H7
(Two Stage)**

Table SH-3-B — Platinum XM R-410A Split System Two Stage Heat Pump (70/100% capacity) — with AccuLink™^{①②}

Model Number	Power Supply	Nom. Cap. Cooling (BTUH)	Uncrated Dimensions(in.)			Shipping Weight (lbs.)	Sound** Rating	MCA*	Max. Fuse*	Line Size (in)	
			H	W	D					Gas	Liq.
4A6H7024A1C00A	208/230/1/60	24,000	41	37	34	272	72	15	25	5/8	3/8
4A6H7036B1C00A	208/230/1/60	36,000	45	37	34	274	72	22	35	3/4	3/8
4A6H7048A1C00A	208/230/1/60	48,000	45	37	34	329	73	28	45	7/8	3/8
4A6H7060A1C00A	208/230/1/60	60,000	45	37	34	330	74	41	60	1 1/8	3/8

Platinum XM 4A6H7 - Coming Soon as AccuLink™ Communicating Systems!

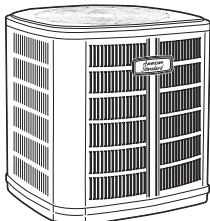

**Platinum XM - 4A6H7
(Two Stage)**

Table SH-3-C — Platinum XM R-410A Split System Two Stage Heat Pump (70/100% capacity)

Model Number	Power Supply	Nom. Cap. Cooling (BTUH)	Uncrated Dimensions(in.)			Shipping Weight (lbs.)	Sound** Rating	MCA*	Max. Fuse*	Line Size (in)	
			H	W	D					Gas	Liq.
4A6H7024A1000A	208/230/1/60	24,000	41	37	34	272	72	15	25	5/8	3/8
4A6H7036B1000A	208/230/1/60	36,000	45	37	34	274	72	22	35	3/4	3/8
4A6H7048A1000A	208/230/1/60	48,000	45	37	34	329	73	28	45	7/8	3/8
4A6H7060A1000A	208/230/1/60	60,000	45	37	34	330	74	41	60	1 1/8	3/8

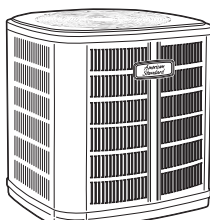

**Gold XI - 4A6H5
(Single Stage)**

Table SH-3-D — Gold XI R-410A Split System Single Stage Heat Pump

Model Number	Power Supply	Nom. Cap. Cooling (BTUH)	Uncrated Dimensions(in.)			Shipping Weight (lbs.)	Sound** Rating	MCA*	Max. Fuse*	Line Size	
			H	W	D					OD Gas	OD Liq.
4A6H5018G1000A	208/230/1/60	18,000	29	33	30	204	75	9	15	5/8	3/8
4A6H5024G1000A	208/230/1/60	24,000	33	33	30	236	75	11	15	5/8	3/8
4A6H5030G1000A	208/230/1/60	30,000	33	37	34	273	75	15	25	3/4	3/8
4A6H5036G1000A	208/230/1/60	36,000	33	37	34	261	75	18	30	3/4	3/8
4A6H5042G1000A	208/230/1/60	41,500	37	37	34	277	75	23	40	3/4	3/8
4A6H5049E1000B	208/230/1/60	48,000	45	37	34	331	75	28	50	7/8	3/8
4A6H5061E1000B	208/230/1/60	60,000	45	37	34	332	75	36	60	1 1/8	3/8

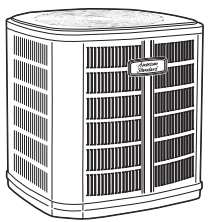

**Gold SI - 4A6H3
(Single Stage)**

Table SH-3-E — Gold SI R-410A Split System Single Stage Heat Pump

Model Number	Power Supply	Nom. Cap. Cooling (BTUH)	Uncrated Dimensions(in.)			Shipping Weight (lbs.)	Sound** Rating	MCA*	Max. Fuse*	Line Size	
			H	W	D					OD Gas	OD Liq.
4A6H3018D1000A	208/230/1/60	17,200	29	33	30	185	71	12	20	5/8	3/8
4A6H3024D1000A	208/230/1/60	22,000	29	33	30	184	71	17	25	5/8	3/8
4A6H3030C1000A	208/230/1/60	29,400	33	33	30	221	76	15	25	3/4	3/8
4A6H3036C1000A	208/230/1/60	35,800	33	37	34	229	73	22	35	3/4	3/8
4A6H3042B1000A	208/230/1/60	41,500	33	37	34	253	75	26	45	3/4	3/8
4A6H3048B1000A	208/230/1/60	47,000	37	37	34	269	75	28	50	7/8	3/8
4A6H3060B1000A	208/230/1/60	57,500	41	37	34	284	75	34	60	7/8	3/8

① Must use TCONT850, TCONT900 or TZONE950 control. ② BAYACHP024A required for 24 volt mode.

* Information subject to change. Please confirm with current Product Data/Service Facts for current factory production.

** Rated in accordance with AHRI Standard 270-2008.

For complete equipment / combination selections, installation instructions and warranty information, please refer to Product Data/Ratings and/or Installers Guides and Limited Warranty Handbooks.

Split System Heat Pumps Single Phase – 1½-5 Tons

Table SH-4-A — Features

	(4A6Z0)	(4A6H7)	(4A6H7)	(4A6H5)	(4A6H3)
• SEER up to	19.00	18.00	18.00	16.25	14.50
• HSPF up to	10.00	9.50	9.50	9.70	8.50
• Duration™ compressor	2	1	1	1	1
• Number of stages	2	2	2	1	1
• AccuLink™ system	✓	✓	—	—	—
• Charge Assist™ fast/accurate charging every time	✓	—	—	—	—
• Comfort-R™ mode approved	✓	✓	✓	✓	✓
• DuraBase™ base, fast complete drain, weatherproof	✓	✓	✓	✓	✓
• Easy-Sess™ cabinet, service access & refrigerant connections with full coil protection	✓	✓	✓	✓	✓
• Spine Fin™ coil	✓	✓	✓	✓	✓
• Demand Defrost Control w/ Lite Port™ /Stored Diagnostics	—	—	—	✓	✓
• Electronic Expansion Valve (EEV)	✓	✓	✓	—	—
• Compressor sound enclosure	✓	—	—	2½-3½	—
• Compressor sump heat - factory installed	✓	✓	✓	✓	—
• Factory supplied charge	R-410A	R-410A	R-410A	R-410A	R-410A
• Glossy corrosion resistant finish	✓	✓	✓	✓	✓
• High pressure switch	✓	✓	✓	✓	—
• Low pressure switch	✓	✓	✓	—	—
• Liquid line filter drier - factory installed	✓	✓	✓	✓	✓
• Quick start kit - factory installed	✓	—	—	1½-3,5	2½
• Seacoast shield - factory installed	✓	✓	✓	✓	✓
• Spinnaker gray cabinet	✓	✓	✓	✓	✓
• 12-year registered limited warranty on compressor, 10-year on outdoor coil & all other functional parts (Residential Use) ③	✓	✓	✓	—	—
• 10-year registered limited warranty on compressor, outdoor coil & all other functional parts (Residential Use) ③	—	—	—	✓	✓
• Extended warranties available	✓	✓	✓	✓	✓

Table SH-4-B — Optional Accessories

Model Number	Description	Shipping Weight	(4A6Z0)	(4A6H7)	(4A6H7)	(4A6H5)	(4A6H3)
AY28X084.....	Evaporator Defrost Control	1	—	—	—	✓	✓
BAYCCHT300	Crankcase Heater Kit (Reciprocating).....	1	—	—	—	—	2½
BAYCCHT301	Crankcase Heater Kit (Scroll).....	1	—	—	—	—	3½-5
BAYCCHT302	Crankcase Heater Kit (Scroll).....	1	—	—	—	—	1½,2,3
BAYACHP024A.....	24 Volt Wiring Harness	1	✓	✓	—	—	—
BAYCAKT001.....	Charge Assist™ Solenoid Kit.....	3	✓	—	—	—	—
BAYECMT023	Extreme Conditions Mounting Kit (Base 2/3).....	2	—	—	—	—	1½-2½
BAYECMT004	Extreme Conditions Mounting Kit (Base 4).....	2	✓	✓	✓	—	3-5
BAYINS001.....	Insulation Kit.....	1	—	—	—	✓	✓
BAYISLT101	Rubber Isolators.....	1	✓	✓	✓	✓	✓
BAYKSKT260	Start kit (Scroll)	1	—	✓	✓	3½-4	✓
BAYLEGS002	Snow Legs - Base and Cap 6" High (Black)	1	✓	✓	✓	✓	✓
BAYLEGS003.....	4" extension (Black)	1	✓	✓	✓	✓	✓
BAYLOAM103	Low Ambient Kit	1	—	—	—	✓ ^④	✓
TAYASCT501A ^{①②}	Anti-Short Cycle Timer	2	—	—	✓	✓	✓
BAYSDEN004.....	Large Scroll Compressor Enclosures	8	—	—	—	5	✓
TAYPLUS103A	Heat Pump Control Kit	3	—	—	—	✓	✓
PAI00309 ^⑤	Heresite Spraypaint.....	1	✓	✓	✓	✓	✓

Comfort Controls — See Comfort Controls/Zone Sensors Section

- ① Do not use with programmable thermostats.
- ② Activated on Power Off.
- ③ Registered Limited Warranty terms are available when you register within 60 days of installation. You can register online at americanstandardair.com or by phone at 800-554-8005; otherwise American Standard Heating & Air Conditioning's Base Limited Warranty terms will apply. Base Limited Warranty information on specific products can be found on ASDealerNet.com.
- ④ For operation to 20°F outdoor ambient.
- ⑤ Used for additional seacoast corrosion protection. Refer to bulletin number UN-SVB11A-EN for application information.

For complete equipment / combination selections, installation instructions and warranty information, please refer to Product Data/Ratings and/or Installers Guides and Limited Warranty Handbooks.

Split System Heat Pumps Single Phase – 1½-5 Tons

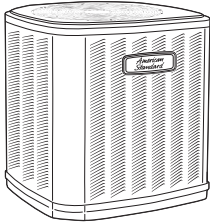

**Silver XI - 4TWB4
(Single Stage)**

Table SH-5-A— Silver XI R-410A Split System Single Stage Heat Pump

Model Number	Power Supply	Nom. Cap. Cooling (BTUH)	Uncrated Dimensions(in.)			Shipping Weight (lbs.)	Sound** Rating	MCA*	Max. Fuse*	Line Size (in)	
			H	W	D					OD Gas	OD Liq.
4TWB4018G1000B	208/230/1/60	18,000	29	33	30	204	76	9	15	5/8	3/8
4TWB4024G1000B	208/230/1/60	24,000	33	33	30	236	76	11	15	5/8	3/8
4TWB4030G1000B	208/230/1/60	30,000	33	37	34	273	78	15	25	3/4	3/8
4TWB4036G1000B	208/230/1/60	36,000	33	37	34	261	76	18	30	3/4	3/8
4TWB4042G1000B	208/230/1/60	41,500	37	37	34	277	76	23	40	3/4	3/8
4TWB4049E1000C	208/230/1/60	48,000	45	37	34	331	76	28	50	7/8	3/8
4TWB4061E1000C	208/230/1/60	60,000	45	37	34	332	76	36	60	1 1/8	3/8

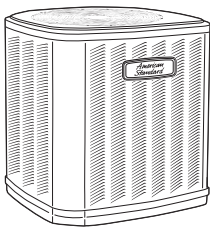

**Silver SI - 4TWB3
(Single Stage)**

Table SH-5-B — Silver SI R-410A Split System Single Stage Heat Pump

Model Number	Power Supply	Nom. Cap. Cooling (BTUH)	Uncrated Dimensions(in.)			Shipping Weight (lbs.)	Sound** Rating	MCA*	Max. Fuse*	Line Size (in)	
			H	W	D					OD Gas	OD Liq.
4TWB3018D1000A	208/230/1/60	17,000	29	33	30	184	76	12	20	5/8	3/8
4TWB3024D1000A	208/230/1/60	23,000	29	33	30	184	76	17	25	5/8	3/8
4TWB3030C1000A	208/230/1/60	28,500	33	33	30	221	79	15	25	3/4	3/8
4TWB3036C1000A	208/230/1/60	34,500	33	37	34	229	76	22	35	3/4	3/8
4TWB3042B1000C	208/230/1/60	40,500	33	37	34	253	79	26	45	3/4	3/8
4TWB3048B1000C	208/230/1/60	46,500	37	37	34	269	78	28	50	7/8	3/8
4TWB3060B1000C	208/230/1/60	58,500	41	37	34	284	78	34	60	7/8	3/8

* Information subject to change. Please confirm with current Product Data/Service Facts for current factory production.

** Rated in accordance with AHRI Standard 270-2008.

Split System Heat Pumps Single Phase – 1½-5 Tons

Table SH-6-A — Features

	(4TWB4)	(4TWB3)
• SEER up to	15.00	14.00
• HSPF up to	9.0	8.5
• Comfort-R™ mode approved.....	✓	✓
• DuraBase™ base, fast complete drain, weatherproof	✓	✓
• Easy-Sess™ cabinet, service access & refrigerant connections with full coil protection	✓	✓
• Spine Fin™ coil	✓	✓
• Compressor sound enclosure	3	—
• Compressor sump heat - factory installed	4-5	—
• Refrigerant - (R-22 not factory supplied).....	R-410A	R-410A
• Glossy corrosion resistant finish	✓	✓
• High pressure switch	✓	✓
• Low pressure switch.....	3½-5	1½-2, 3-5
• Liquid line filter drier - factory installed.....	✓	✓
• Polyslate gray cabinet	✓	✓
• Start kit - factory installed.....	1½-3	2½
• 10-year registered limited warranty on compressor, outdoor coil & all other functional parts (Residential Use)③	✓	✓
• Extended warranties available	✓	✓

Table SH-6-B — Optional Accessories

Model Number	Description	Shipping Weight		
AY28X084.....	Evaporator Defrost Control HP	1	✓	✓
BAYCCHT300	Crankcase Heater Kit (Recip)	1	1½-3½	2½
BAYCCHT301	Crankcase Heater Kit (Scroll).....	—	3½-5
BAYCCHT302	Crankcase Heater Kit (Scroll).....	—	1½,2,3
BAYECMT023	Extreme Conditions Mounting Kit (Base 2/3).....	2	—	1½-2½
BAYECMT004	Extreme Conditions Mounting Kit (Base 4)	2	✓	3-5
BAYISLT101	Rubber Isolators	1	✓	✓
BAYKSKT263	Start Kit (Scroll)	1	3½-5	1½-2,3-5
BAYLEGS002	Snow Legs - Base and Cap 6" High (Black)	1	✓	✓
BAYLEGS003.....	4" Extension (Black).....	1	✓	✓
BAYLOAM103	Low Ambient Kit	1	✓④	✓
BAYSDEN001	Single Cylinder Compressor Enclosures	8	1½-2½	—
BAYSDEN003	Small Scroll Compressor Enclosures.....	8	3½-5	1½-4
BAYSDEN004	Large Scroll Compressor Enclosures	8	—	5
BAYSEAC001.....	Seacoast Kit	1	✓	✓
TAYASCT501A①②	Anti-short cycle timer	2	✓	✓
PAI00309⑤.....	Heresite Spraypaint.....	1	✓	✓

Comfort Controls — See Comfort Controls/Zone Sensors Section

- ① Do not use with programmable thermostats.
- ② Activated on Power Off.
- ③ Registered Limited Warranty terms are available when you register within 60 days of installation. You can register online at americanstandardair.com or by phone at 800-554-8005; otherwise American Standard Heating & Air Conditioning's Base Limited Warranty terms will apply. Base Limited Warranty information on specific products can be found on ASDealerNet.com.
- ④ For operation to 20°F outdoor ambient.
- ⑤ Used for additional seacoast corrosion protection. Refer to bulletin number UN-SVB11A-EN for application information.

Split System Heat Pumps

Split System Heat Pumps Three Phase and R-22

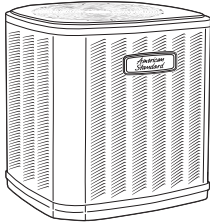

**Silver SI - 4TWA3
(Single Stage)**

Table SH-7-A — Silver SI R-410A Split System Single Stage Heat Pump - Three Phase

Model Number	Power Supply	Nom. Cap. Cooling (BTUH)	Uncrated Dimensions(in.)			Shipping Weight (lbs.)	Sound** Rating	MCA*	Max. Fuse*	Line Size (in)	
			H	W	D					OD Gas	OD Liq.
4TWA3030A3000C	208/230/3/60	30,000	37	33	30	233	80	11	15	3/4	3/8
4TWA3036A3000C	208/230/3/60	36,000	37	37	34	264	79	16	25	3/4	3/8
4TWA3042B3000A	208/230/3/60	40,500	33	37	34	248	80	18	30	3/4	3/8
4TWA3048B3000A	208/230/3/60	46,500	41	37	34	279	78	18	30	7/8	3/8
4TWA3060B3000A	208/230/3/60	58,500	41	37	34	280	78	20	35	7/8	3/8
4TWA3030A4000C	460/3/60	30,000	37	33	30	231	80	5	15	3/4	3/8
4TWA3036A4000C	460/3/60	36,000	37	37	34	263	79	7	15	3/4	3/8
4TWA3042B4000A	460/3/60	40,500	33	37	34	248	80	8	15	3/4	3/8
4TWA3048A4000A	460/3/60	46,500	41	37	34	278	78	8	15	7/8	3/8
4TWA3060B4000A	460/3/60	58,500	41	37	34	280	78	10	15	7/8	3/8

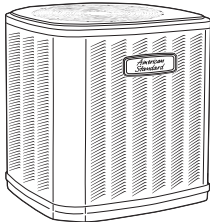

**Silver SI - 2TWB3
(Single Stage)**

Table SH-7-B — Silver SI R-22 Split System Dry Ship Replacement Single Stage Heat Pump

Model Number	Power Supply	Nom. Cap. Cooling (BTUH)	Uncrated Dimensions(in.)			Shipping Weight (lbs.)	Sound** Rating	MCA*	Max. Fuse*	Line Size	
			H	W	D					Gas	Liq.
2TWB3018A1000C	208/230/1/60	17,000	33	29	26	182	74	8	15	5/8	1/4
2TWB3024A1000C	208/230/1/60	23,000	33	29	26	195	79	12	20	3/4	5/16
2TWB3030A1000C	208/230/1/60	28,500	37	33	30	225	79	13	20	3/4	5/16
2TWB3036A1000C	208/230/1/60	34,500	37	37	34	297	79	19	30	7/8	3/8
2TWB3042A1000C	208/230/1/60	40,500	41	37	34	312	80	21	35	7/8	3/8
2TWB3048A1000C	208/230/1/60	46,500	41	37	34	313	78	25	40	1 1/8	3/8
2TWB3060A1000C	208/230/1/60	58,500	41	37	34	291	79	32	50	1 1/8	3/8

* Information subject to change. Please confirm with current Product Data/Service Facts for current factory production.

** Rated in accordance with AHRI Standard 270-2008.

Split System Heat Pumps Three Phase and R-22

Table SH-8-A — Features

	(4TWA3)	(2TWB3)
• SEER up to	15.00	13.00
• HSPF up to	8.50	7.70
• Comfort-R™ mode approved	✓	✓
• DuraBase™ base, fast complete drain, weatherproof	✓	✓
• Easy-Sess™ cabinet, service access & refrigerant connections with full coil protection	✓	✓
• Spine Fin™ coil	✓	✓
• Compressor sound enclosure	—	3-4
• Compressor sump heat - factory installed	✓	—
• Demand Defrost Control w/ Lite Port™ /Stored Diagnostics	✓	✓
• Refrigerant (R-22 not factory supplied)	R-410A	R-22
• Glossy corrosion resistant finish	✓	✓
• Liquid line filter drier - factory installed	✓	✓
• Low pressure switch	✓	✓
• Internal high / low pressure & temperature protection	✓	✓
• Polyslate gray cabinet	✓	✓
• Start kit - factory installed	—	1½-4
• 5-year registered limited warranty on compressor, outdoor coil & 1-year on all other functional parts (Commercial Use)	✓	—
• 5-year registered limited warranty on compressor, outdoor coil & 5-year on all other functional parts (Residential Use)	✓	✓
• Extended warranties available	✓	✓

Table SH-8-B — Optional Accessories

Model Number	Description	Shipping Weight		
AY28X084.....	Evaporator defrost control	1	✓	✓
BAYCCHT300	Crankcase Heater Kit (Recip)	1	—	1½-4
BAYCCHT302	Crankcase Heater Kit (Scroll).....	1	—	5
BAYECMT023	Extreme Conditions Mounting Kit (Base 2/3)	2	2½	1½-2½
BAYECMT004	Extreme Conditions Mounting Kit (Base 4)	2	3-5	3-5
BAYINS001	Insulation Kit	1	✓	—
BAYKSKT260	Start Kit (Scroll)	1	—	5
BAYISLT101	Rubber Isolators	1	✓	✓
BAYLEGS002	Snow Legs - Base and Cap - 6" (Black).....	1	✓	✓
BAYLEGS003	4" Extension (used with BAYLEGS002) (Black).....	1	✓	✓
BAYLOAM103	Low Ambient Kit	1	✓	✓
BAYSEAC001	Seacoast Kit	1	✓	✓
TAYASCT501A①②	Anti-Short Cycle Timer	2	✓	✓
PAI00309③.....	Heresite Spraypaint.....	1	✓	✓

Comfort Controls — See Comfort Controls/Zone Sensors Section

- ① Do not use with programmable thermostats.
- ② Activated on Power Off.
- ③ Used for additional seacoast corrosion protection. Refer to bulletin number UN-SVB11A-EN for application information.

Split System Heat Pumps

Multi-position Air Handler

*** Note: No internal modifications required for any position.**
① Badge rotation will keep brand in correct position

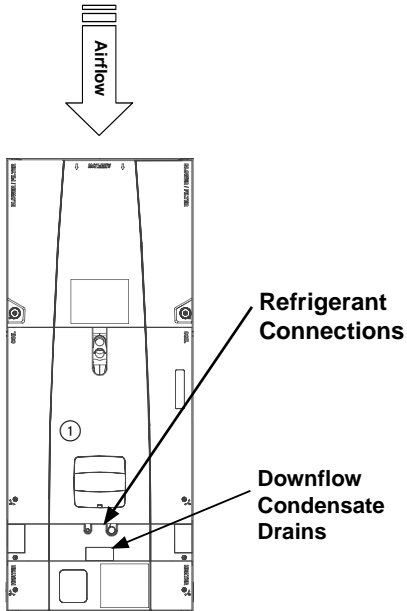

Vertical Downflow*

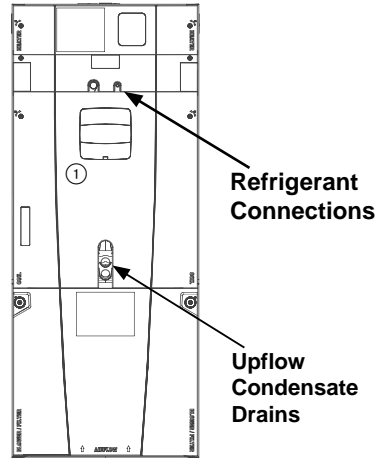

**Vertical Upflow*
(as shipped)**

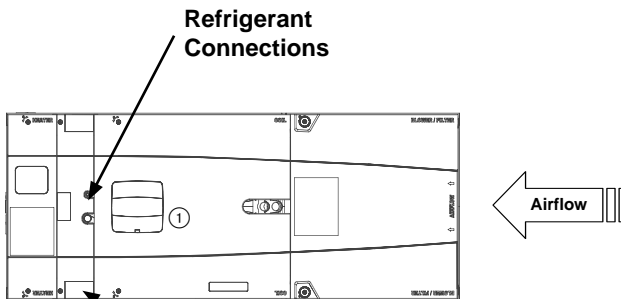

Horizontal Left*

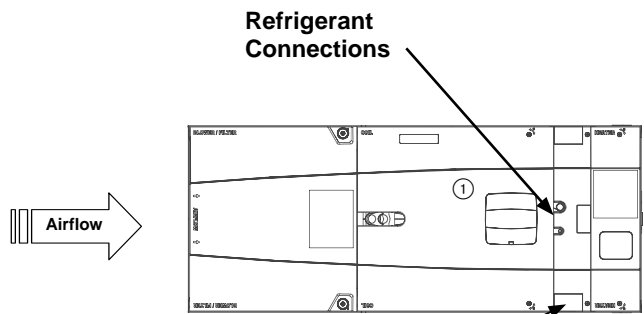

Horizontal Right*

For complete equipment / combination selections, installation instructions and warranty information, please refer to Product Data/Ratings and/or Installers Guides and Limited Warranty Handbooks.

Features and Benefits

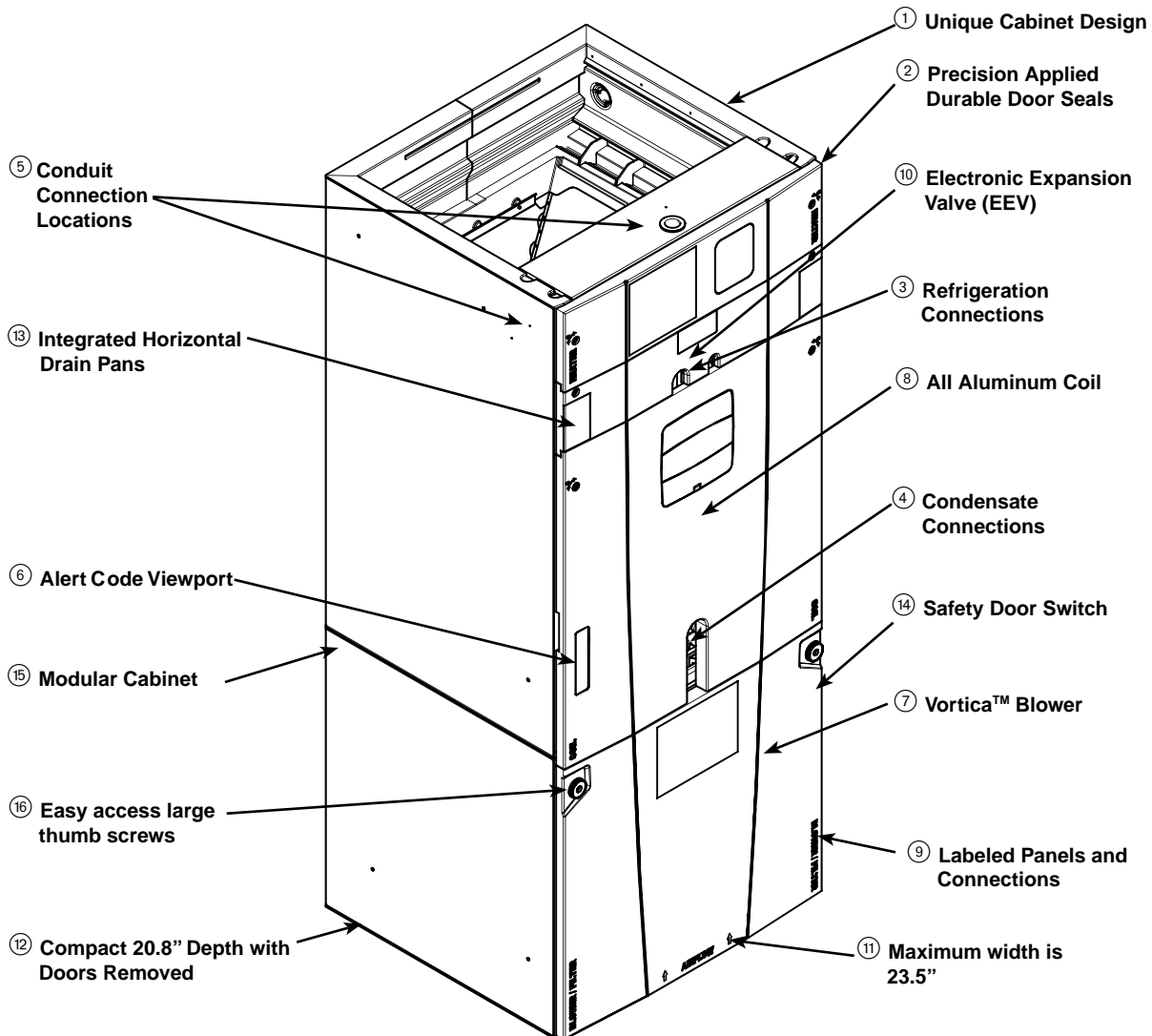

① Unique Cabinet Design

- Double wall foamed cabinet system
- Waterproof Cabinet Design (No Thermal Breakage)
- $\geq R-4.2$ Insulating Value (Avg. Insulating Value R-8.2)
- Composite Foamed Cabinet Doors
- Sweat Eliminating Cabinet Design
- Loose Fiber Eliminating Design
- Smooth Cleanable Cabinet Design

② Precision Applied Durable Door Seals

③ Refrigeration Connections

④ Condensate Connections

⑤ Conduit Connection Locations - Dimples in cabinet mark Conduit Connection Locations for Left, Right, and Top

⑥ Alert Code Viewport

- Alert Codes can be Viewed Without Door Removal
- Control Protection Pocket

⑦ Vortica™ Blower

- Polarized Plug Connections
- Integrated Slide Deck for Easy Removal

⑧ All Aluminum Coil

- Integrated Slide Deck for Easy Removal
- Polarized Plug connections on Coil EEV
- Patented Enhanced Coil Fin

⑨ Labeled Panels and Connections

⑩ Electronic Expansion Valve (EEV)

- Low Ambient and Low Superheat Compressor Protection
- Dual Refrigerant Compatible as Shipped

⑪ Maximum width is 23.5"

⑫ Compact 20.8" Depth with Doors Removed

⑬ Integrated Horizontal Drain Pans

⑭ Safety Door Switch - Fused 24V Power

⑮ Modular Cabinet

⑯ Easy access large thumb screws

Series 8 Variable Speed Multi-Position Air Handlers 2-5 Tons

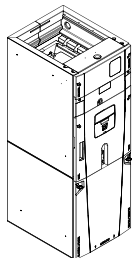

Table AH-3-A — AccuLink™ Variable Speed R-410A with Smart Fan Options 200-230/1/60

Unit Model No.	Cooling Capacity (Btuh)	Dimensions (in.) H x W x D	Shipping Weight (lbs.)	Supply Opening	Return Opening	Filter Sizes	Line Size	
							Gas	Liquid
TAM8C0A24V21CA	24000	49.9 x 17.5 x 21.8	126	14.5 x 14.35	14.5 x 17.15	16 x 20 x 1	3/4	3/8
TAM8C0B30V21CA	30000	55.7 x 21.3 x 21.8	150	18.4 x 14.35	18.4 x 17.15	20 x 20 x 1	3/4	3/8
TAM8C0C36V31CA	36000	56.9 x 23.5 x 21.8	157	20.5 x 14.35	20.5 x 17.15	22 x 20 x 1	7/8	3/8
TAM8C0C42V31CA	42000	56.9 x 23.5 x 21.8	162	20.5 x 14.35	20.5 x 17.15	22 x 20 x 1	7/8	3/8
TAM8C0C48V41CA	48000	61.7 x 23.5 x 21.8	174	20.5 x 14.35	20.5 x 17.15	22 x 20 x 1	7/8	3/8
TAM8C0C60V51CA	60000	61.7 x 23.5 x 21.8	175	20.5 x 14.35	20.5 x 17.15	22 x 20 x 1	7/8	3/8

Series 7 Variable Speed Multi-Position Air Handlers 2-5 Tons

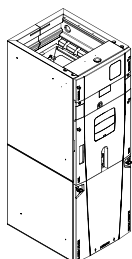

Table AH-3-B — Variable Speed R-410A with Comfort-R™ Enhanced Mode Option 200-230/1/60

Unit Model No.	Cooling Capacity (Btuh)	Dimensions (in.) H x W x D	Shipping Weight (lbs.)	Supply Opening	Return Opening	Filter Sizes	Line Size	
							Gas	Liquid
TAM7A0A24H21SC	24000	49.9 x 17.5 x 21.8	126	14.5 x 14.35	14.5 x 17.15	16 x 20 x 1	3/4	3/8
TAM7A0B30H21SC	30000	55.7 x 21.3 x 21.8	150	18.4 x 14.35	18.4 x 17.15	20 x 20 x 1	3/4	3/8
TAM7A0C36H31SC	36000	56.9 x 23.5 x 21.8	157	20.5 x 14.35	20.5 x 17.15	22 x 20 x 1	7/8	3/8
TAM7A0C42H31SC	42000	56.9 x 23.5 x 21.8	162	20.5 x 14.35	20.5 x 17.15	22 x 20 x 1	7/8	3/8
TAM7A0C48H41SC	48000	61.7 x 23.5 x 21.8	174	20.5 x 14.35	20.5 x 17.15	22 x 20 x 1	7/8	3/8
TAM7B0C60H51SB	60000	61.7 x 23.5 x 21.8	175	20.5 x 14.35	20.5 x 17.15	22 x 20 x 1	7/8	3/8

Series 7 & 8 Variable Speed Multi-Position Air-Tite™ Air Handlers

Table AH-4-A — Features

	TAM7 2-5	TAM8 2-5
• Unique cabinet design	✓	✓
– 2% or less air leakage	✓	✓
– Precision applied - durable door seals	✓	✓
– Specially designed air seal around refrigerant, condensate and conduit connections	✓	✓
– Double wall foamed cabinet system	✓	✓
– ≥ R-4.2 insulating value (Avg. Insulating Value R-8.2)	✓	✓
– No loose fiber design	✓	✓
– Smooth cleanable interior design	✓	✓
– Sweat eliminating design	✓	✓
– Composite foamed cabinet doors	✓	✓
– Water proof cabinet design	✓	✓
– Integrated horizontal drain pans	✓	✓
– Modular cabinet	✓	✓
• Multi-position up/down flow horizontal left/right	✓	✓
• Side return option (sold as accessory)	✓	✓
• Control board protection pocket built into cabinet wall	✓	✓
• Alert port to view control board codes without door removal	✓	✓
• AccuLink™ control	✓	✓
• Alert code notification	✓	✓
• 5 button user interface and clear description of set up	✓	✓
• Service diagnostic with alert reported at user interface	✓	✓
• Low voltage terminal connection point	✓	✓
• Vortica® blower with polarized plug connections and integrated slide deck for easy removal	✓	✓
• Aluminum coil with integrated slide deck for easy removal and polarized plug connections on coil EEV	✓	✓
• Patented enhanced coil fin	✓	✓
• Electronic Expansion Valve (EEV) with low ambient and low superheat compressor protection	✓	✓
• Dual refrigerant compatible as shipped	✓	✓
• Slide in electric heaters with polarized plug connections (sold as accessory)	✓	✓
• Slide in hot water coils with polarized plug connections (sold as accessory)	✓	✓
• UVC light kit with safety switch and polarized plug connections (sold as accessory)	✓	✓
• Labeled panels and connections	✓	✓
• Molded in 1" standard filter rail	✓	✓
• Variable speed ECM motor	✓	✓
• Soft start fan motor operation	✓	✓
• Comfort R™ mode	✓	✓
• Built in fan delay modes	✓	✓
• Maximum width of 23.5"	✓	✓
• Compact 20.8" depth with doors removed	✓	✓
• Fused 24v power	✓	✓
• Safety door switch	✓	✓
• 10-year warranty registered	✓	✓
• Optional extended warranty available	✓	✓

Series 7 & 8 Variable Speed Multi-Position Air-Tite™ Air Handlers

Table AH-5-A — Optional Accessories

Model Number	Description	Matches Cabinet Size(s) ^①	TAM7	TAM8
BAYCC24VK01A	Compressor Module Kit		—	✓
BAYWVAA05SC1AA	Hydronic Heater, 40,000 BTUH, Nominal, Slide-in, RS-485 Control ^③	A	✓	✓
BAYWVBB07SC1AA	Hydronic Heater, 50,000 BTUH, Nominal, Slide-in, RS-485 Control ^③	B	✓	✓
BAYWVCC08SC1AA	Hydronic Heater, 65,000 BTUH, Nominal, Slide-in, RS-485 Control ^③	C	✓	✓
BAYWACC11SC1AA	Hydronic Heater, 100,000 BTUH, Nominal, External, No Control ^③	C	✓	✓
BAYWVBRD485	RS-485 Control for BAYWACC11SC1AA	C	✓	✓
BAYSUPFLGAA	Supply Duct Flange A	A	✓	✓
BAYSUPFLGBA	Supply Duct Flange B	B	✓	✓
BAYSUPFLGCA	Supply Duct Flange C	C	✓	✓
BAYRETFLGAA	Return Duct Flange A	A	✓	✓
BAYRETFLGBA	Return Duct Flange B	B	✓	✓
BAYRETFLGCA	Return Duct Flange C	C	✓	✓
BAYFLR1620A	Washable high velocity filter, 16" x 20" x 1" (10 filters)	A	✓	✓
BAYFLR2020A	Washable high velocity filter, 20" x 20" x 1" (10 filters)	B	✓	✓
BAYFLR2220A	Washable high velocity filter, 22" x 20" x 1" (10 filters)	C	✓	✓
TASB175SB ^{②⑤}	Plenum Stand with Integrated Sound Baffle A	A	✓	✓
TASB215SB ^{②⑤}	Plenum Stand with Integrated Sound Baffle B	B	✓	✓
TASB235SB ^{②⑤}	Plenum Stand with Integrated Sound Baffle C	C	✓	✓
BAYSRKIT100	Side Return Kit		✓	✓
BAYFRKIT175	Front Return Kit	A	✓	✓
BAYFRKIT210	Front Return Kit	B	✓	✓
BAYFRKIT235	Front Return Kit	C	✓	✓
MTISRKIT1620 ^②	Side Return Kit with 16"x20" Filter	A-C	✓	✓
TASSBK175 ^{②④⑥}	Sound Baffle Kit 17.5" Cabinet	A	✓	✓
TASSBK215 ^{②④⑥}	Sound Baffle Kit 21.5" Cabinet	B	✓	✓
TASSBK235 ^{②④⑥}	Sound Baffle Kit 23.5" Cabinet	C	✓	✓
BAYSPEKT200	Single Power Entry Kit		✓	✓
BAYICKSKIT01	Internal Condensate Switch Kit		✓	✓
BAYHHKIT001	Horizontal Hanger Kit		✓	✓
BAYUVCLK001	UVC Lights		✓	✓
BAYLVKIT100	Low Voltage Conduit Entry Kit		✓	✓
BAYBAFKT175A ^⑦	Baffle Kit 17.5" Cabinet	A	✓	✓
BAYBAFKT215A ^⑦	Baffle Kit 21.5" Cabinet	B	✓	✓
BAYBAFKT235A ^⑦	Baffle Kit 23.5" Cabinet	C	✓	✓
BAYINSKT175A	Sound Insulation Kit 17.5" Cabinet	A	✓	✓
BAYINSKT215A	Sound Insulation Kit 21.5" Cabinet	B	✓	✓
BAYINSKT235A	Sound Insulation Kit 23.5" Cabinet	C	✓	✓
BAYCNDPIP01A	3/4" PVC Threaded Pipe Kit with foam seal (10 kits)		✓	✓

① A Cabinet is 17.5" wide, B Cabinet is 21.5" wide, C Cabinet is 23.5" wide.
 ② Contact your distributor for information.
 ③ ACONT900 Thermostat can not be used with Hydronic heating.
 ④ In return plenum applications, use TASSBK kits for sound reduction.
 ⑤ In open air applications, Plenum Stand with Sound Baffle provides sound reduction.
 ⑥ Mounts to TASB original plenum stands without integrated sound baffle.
 ⑦ Mounts inside air filter channel on air handler.

Series 4 Multi-Position Air Handlers Single Phase 1½-5 Tons

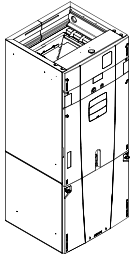

Table AH-6-A — Multi-Speed PSC Motor 200-230/1/60

Unit Model No.	Cooling Capacity (Btuh)	Dimensions (in.) H x W x D	Shipping Weight (lbs.)	Supply Opening	Return Opening	Filter Sizes	Line Size Gas	Line Size Liquid
TAM4A0A18S11SC	18000	49.9 x 17.5x 21.8	123	14.5 x 14.35	14.5 x 17.15	16 x 20 x 1	¾	¾
TAM4A0A24S21SC	24000	49.9 x 17.5x 21.8	126	14.5 x 14.35	14.5 x 17.15	16 x 20 x 1	¾	¾
TAM4A0A30S21SC	30000	49.9 x 17.5x 21.8	127	14.5 x 14.35	14.5 x 17.15	16 x 20 x 1	7/8	¾
TAM4A0A36S31SC	36000	49.9 x 17.5x 21.8	130	14.5 x 14.35	14.5 x 17.15	16 x 20 x 1	7/8	¾
TAM4A0B42S31SC	42000	55.7 x 21.3x 21.8	144	18.4 x 14.35	18.4 x 17.15	20 x 20 x 1	7/8	¾
TAM4A0C48S41SC	48000	56.9 x 23.5x 21.8	155	20.5 x 14.35	20.5 x 17.15	20 x 20 x 1	7/8	¾
TAM4A0C60S51SC ^①	60000	61.7 x 23.5x 21.8	171	20.5 x 14.35	20.5 x 17.15	22 x 20 x 1	7/8	¾

① High efficiency ECM motor.

Table AH-6-B — Features

	TAM4 1 1/2-5
• Unique cabinet design.....	✓
– 2% or less air leakage.....	✓
– Precision applied - durable door seals.....	✓
– Specially designed air seal around refrigerant, condensate and conduit connections.....	✓
– Double wall foamed cabinet system.....	✓
– ≥ R-4.2 insulating value (Avg. Insulating Value R-8.2).....	✓
– No loose fiber design.....	✓
– Smooth cleanable interior design.....	✓
– Sweat eliminating design.....	✓
– Composite foamed cabinet doors.....	✓
– Water proof cabinet design.....	✓
– Integrated horizontal drain pans.....	✓
– Modular cabinet.....	✓
• Multi-position up/down flow horizontal left/right.....	✓
• Side return option (sold as accessory).....	✓
• Alert code notification.....	✓
• Low voltage terminal connection point.....	✓
• Vortica ® blower with polarized plug connections and integrated slide deck for easy removal.....	✓
• Aluminum coil with integrated slide deck for easy removal and polarized plug connections on coil EEV.....	✓
• Enhanced coil fin patented.....	✓
• Electronic Expansion Valve (EEV) with low ambient and low superheat compressor protection.....	✓
• Dual refrigerant compatible as shipped.....	✓
• Slide in electric heaters with polarized plug connections (sold as accessory).....	✓
• UVC light kit with safety switch and polarized plug connections (sold as accessory).....	✓
• Labeled panels and connections.....	✓
• Molded in 1" standard filter rail.....	✓
• PSC 3 speed motor.....	1½-4
• High efficiency ECM motor.....	5
• Maximum width of 23.5".....	✓
• Compact 20.8" depth with doors removed.....	✓
• Fused 24v power.....	✓
• Safety door switch.....	✓
• 10-year warranty registered	✓
• Optional extended warranty available	✓

Air Handlers/Heaters

For complete equipment / combination selections, installation instructions and warranty information, please refer to Product Data/Ratings and/or Installers Guides and Limited Warranty Handbooks.

Series 4 Multi-Position Air Handlers Single Phase 1½-5 Tons

Table AH-7-A — Optional Accessories

Model Number	Description	Matches Cabinet Size(s) ^①	TAM4
BAYSUPFLGAA	Supply Duct Flange A	A	✓
BAYSUPFLGBA	Supply Duct Flange B	B	✓
BAYSUPFLGCA	Supply Duct Flange C	C	✓
BAYRETFLGAA	Return Duct Flange A	A	✓
BAYRETFLGBA	Return Duct Flange B	B	✓
BAYRETFLGCA	Return Duct Flange C	C	✓
BAYFLR1620A	Washable high velocity filter, 16" x 20" x 1" (10 filters)	A	✓
BAYFLR2020A	Washable high velocity filter, 20" x 20" x 1" (10 filters)	B	✓
BAYFLR2220A	Washable high velocity filter, 22" x 20" x 1" (10 filters)	C	✓
TASB175SB ^{②④}	Plenum Stand with Integrated Sound Baffle A	A	✓
TASB215SB ^{②④}	Plenum Stand with Integrated Sound Baffle B	B	✓
TASB235SB ^{②④}	Plenum Stand with Integrated Sound Baffle C	C	✓
MTISRKIT1620 ^②	Side Return Kit with 16"x20" Filter	A-C	✓
TASSBK175 ^{②③⑤}	Sound Baffle Kit 17.5" Cabinet	A	✓
TASSBK215 ^{②③⑤}	Sound Baffle Kit 21.5" Cabinet	B	✓
TASSBK235 ^{②③⑤}	Sound Baffle Kit 23.5" Cabinet	C	✓
BAYSPEKT200	Single Power Entry Kit		✓
BAYSRKIT100	Side Return Kit		✓
BAYFRKIT175	Front Return Kit	A	✓
BAYFRKIT210	Front Return Kit	B	✓
BAYFRKIT235	Front Return Kit	C	✓
BAYICKIT01	Internal Condensate Switch Kit		✓
BAYHHKIT001	Horizontal Hanger Kit		✓
BAYUVCLK001	UVC Lights		✓
BAYLVKIT100A	Low Voltage Conduit Entry Kit		✓
BAYBAFKT175A ^⑥	Sound Baffle Kit 17.5" Cabinet	A	✓
BAYBAFKT215A ^⑥	Sound Baffle Kit 21.5" Cabinet	B	✓
BAYBAFKT235A ^⑥	Sound Baffle Kit 23.5" Cabinet	C	✓
BAYINSKT175A	Sound Insulation Kit 17.5" Cabinet	A	✓
BAYINSKT215A	Sound Insulation Kit 21.5" Cabinet	B	✓
BAYINSKT235A	Sound Insulation Kit 23.5" Cabinet	C	✓
BAYCNDPIP01A	¾" PVC Threaded Pipe Kit with foam seal (10 kits)		✓

① A Cabinet is 17.5" wide, B Cabinet is 21.5" wide, C Cabinet is 23.5" wide.
 ② Contact your distributor for information.
 ③ In return plenum applications, use TASSBK kits for sound reduction.
 ④ In open air applications, Plenum Stand with Sound Baffle provides sound reduction.
 ⑤ Mounts to TASB original plenum stands without integrated sound baffle.
 ⑥ Mounts inside air filter channel on air handler.

Series 5 Multi-Position Air Handlers Single Phase 1½-5 Tons

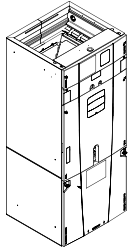

Table AH-8-A — Multi-Speed High Efficiency Motor 200-230/1/60

Unit Model No.	Cooling Capacity (Btuh)	Dimensions (in.) H x W x D	Shipping Weight (lbs.)	Supply Opening	Return Opening	Filter Sizes	Line Size Gas	Line Size Liquid
GAM5B0A18M11SA	18000	49.9 x 17.5 x 21.8	126	14.5 x 14.35	14.5 x 17.15	16 x 20 x 1	¾	¾
GAM5B0A24M21SA	24000	49.9 x 17.5 x 21.8	126	14.5 x 14.35	14.5 x 17.15	16 x 20 x 1	¾	¾
GAM5B0B30M21SA	30000	51.5 x 21.3 x 21.8	140	18.4 x 14.35	18.4 x 17.15	20 x 20 x 1	¾	¾
GAM5B0B36M31SA	36000	55.7 x 21.3 x 21.8	150	18.4 x 14.35	18.4 x 17.15	20 x 20 x 1	7/8	¾
GAM5B0C42M31SA	42000	56.9 x 23.5 x 21.8	163	20.5 x 14.35	20.5 x 17.15	22 x 20 x 1	7/8	¾
GAM5B0C48M41SA	48000	61.7 x 23.5 x 21.8	176	20.5 x 14.35	20.5 x 17.15	22 x 20 x 1	7/8	¾
GAM5B0C60M51SA	60000	61.7 x 23.5 x 21.8	180	20.5 x 14.35	20.5 x 17.15	22 x 20 x 1	7/8	¾

Table AH-8-B — Features

Table AH-8-B — Features	GAM5B 1 1/2-5
• Unique cabinet design.....	✓
– 2% or less air leakage.....	✓
– Precision applied - durable door seals.....	✓
– Specially designed air seal around refrigerant, condensate and conduit connections.....	✓
– Double wall foamed cabinet system.....	✓
– ≥ R-4.2 insulating value (Avg. Insulating Value R-8.2).....	✓
– No loose fiber design.....	✓
– Smooth cleanable interior design.....	✓
– Sweat eliminating design.....	✓
– Composite foamed cabinet doors.....	✓
– Water proof cabinet design.....	✓
– Integrated horizontal drain pans.....	✓
– Modular cabinet.....	✓
• Multi-position up/down flow horizontal left/right.....	✓
• Side return option (sold as accessory).....	✓
• Low voltage terminal connection point.....	✓
• Vortica ® blower with polarized plug connections and integrated slide deck for easy removal.....	✓
• Aluminum coil with integrated slide deck for easy removal.....	✓
• Patented enhanced coil fin.....	✓
• R-410A TXV.....	✓
• Slide in electric heaters with polarized plug connections (sold as accessory).....	✓
• UVC light kit with safety switch and polarized plug connections (sold as accessory).....	✓
• Labeled panels and connections.....	✓
• Molded in 1" standard filter rail.....	✓
• High efficiency ECM motor.....	✓
• Maximum width of 23.5".....	✓
• Compact 20.8" depth with doors removed.....	✓
• Fused 24v power.....	✓
• Safety door switch.....	✓
• 10-year warranty registered	✓
• Optional extended warranty available	✓

Series 5 Multi-Position Air Handlers Single Phase 1½-5 Tons

Table AH-9-A — Optional Accessories

Model Number	Description	Matches Cabinet Size(s) ^①	GAM5
BAYWAAA05SC1AA	Hydronic Heater, 40,000 BTUH, Nominal, Slide-in, No Control	A	✓
BAYWABB07SC1AA	Hydronic Heater, 50,000 BTUH, Nominal, Slide-in, No Control	B	✓
BAYWACC08SC1AA	Hydronic Heater, 65,000 BTUH, Nominal, Slide-in, No Control	C	✓
BAYWACC11SC1AA	Hydronic Heater, 100,000 BTUH, Nominal, Slide-in, No Control	C	✓
BAYSUPFLGAA	Supply Duct Flange A	A	✓
BAYSUPFLGBA	Supply Duct Flange B	B	✓
BAYSUPFLGCA	Supply Duct Flange C	C	✓
BAYRETFLGAA	Return Duct Flange A	A	✓
BAYRETFLGBA	Return Duct Flange B	B	✓
BAYRETFLGCA	Return Duct Flange C	C	✓
BAYFLR1620A	Washable high velocity filter, 16" x 20" x 1" (10 filters)	A	✓
BAYFLR2020A	Washable high velocity filter, 20" x 20" x 1" (10 filters)	B	✓
BAYFLR2220A	Washable high velocity filter, 22" x 20" x 1" (10 filters)	C	✓
TASB175SB ^{②④}	Plenum Stand with Integrated Sound Baffle A	A	✓
TASB215SB ^{②④}	Plenum Stand with Integrated Sound Baffle B	B	✓
TASB235SB ^{②④}	Plenum Stand with Integrated Sound Baffle C	C	✓
MTISRKIT1620 ^②	Side Return Kit with 16"x20" Filter	A-C	✓
TASSBK175 ^{②③⑤}	Sound Baffle Kit 17.5" Cabinet	A	✓
TASSBK215 ^{②③⑤}	Sound Baffle Kit 21.5" Cabinet	B	✓
TASSBK235 ^{②③⑤}	Sound Baffle Kit 23.5" Cabinet	C	✓
BAYSPEKT200	Single Power Entry Kit		✓
BAYSRKIT100	Side Return Kit		✓
BAYFRKIT175	Front Return Kit	A	✓
BAYFRKIT210	Front Return Kit	B	✓
BAYFRKIT235	Front Return Kit	C	✓
BAYHHKIT001	Horizontal Hanger Kit		✓
BAYUVCLK001	UVC Lights		✓
BAYLVKIT100A	Low Voltage Conduit Entry Kit		✓
BAYBAFKT175A	Baffle Kit 17.5" Cabinet	A	✓
BAYBAFKT215A	Baffle Kit 21.5" Cabinet	B	✓
BAYBAFKT235A	Baffle Kit 23.5" Cabinet	C	✓
BAYINSKT175A ^⑥	Sound Insulation Kit 17.5" Cabinet	A	✓
BAYINSKT215A ^⑥	Sound Insulation Kit 21.5" Cabinet	B	✓
BAYINSKT235A ^⑥	Sound Insulation Kit 23.5" Cabinet	C	✓
BAYCNDPIP01A	¾" PVC Threaded Pipe Kit with foam seal (10 kits)		✓
Model Number	Description		GAM5B
BAYATXV1836A	R-22 TXV conversion kit		1½-2
BAYATXV4248A	R-22 TXV conversion kit		2½-3½
BAYATXV6060A	R-22 TXV conversion kit		4-5

- ① A Cabinet is 17.5" wide, B Cabinet is 21.5" wide, C Cabinet is 23.5" wide.
- ② Contact your distributor for information.
- ③ In return plenum applications, use TASSBK kits for sound reduction.
- ④ In open air applications, Plenum Stand with Sound Baffle provides sound reduction.
- ⑤ Mounts to TASB original plenum stands without integrated sound baffle.
- ⑥ Mounts inside air filter channel on air handler.

Series 2 Split System Air Handlers Single Phase 1 1/2-5 Tons

Table AH-11-A — Features (Continued)

	GAF2 1 1/2-3	GAT2 3 1/2-5	GAM2 1 1/2-5
• Front return option.....	✓	✓	✓
• Low voltage terminal connection point.....	✓	✓	✓
• Vortica ® blower with polarized plug connections and integrated slide deck for easy removal.....	✓	✓	✓
• Aluminum coil with integrated slide deck for easy removal and polarized plug connections on coil EEV (GAF2A0A36M311SA).....	3	—	—
• Patented enhanced coil fin.....	✓	✓	✓
• R-410A TXV (except GAF2A0A36M311SA).....	✓	✓	✓
• Slide in electric heaters with polarized plug connections (sold as accessory).....	—	—	—
• UVC light kit with safety switch and polarized plug connections (sold as accessory).....	—	—	—
• Labeled panels and connections.....	✓	✓	✓
• Molded in 1" standard filter rail.....	—	—	—
• PSC 3 speed motor.....	✓	✓	✓
• High efficiency constant torque ECM motor (GAF2A0A36M311SA, GAT2A0C60S51SA, and GAM2A0C60S51SA).....	3	5	5
• Maximum width of 23.5".....	✓	✓	✓
• Compact 20.8" depth with doors removed.....	✓	✓	✓
• Fused 24v power.....	✓	✓	✓
• Safety door switch.....	✓	✓	✓
• 10-year warranty registered	✓	✓	✓
• Optional extended warranty available	✓	✓	✓

Table AH-11-B — Optional Accessories

Model	Description	Matches Cabinet Size(s) ①②③	GAF2	GAT2	GAM2
BAYATXV1836.....	R-22 TXV conversion kit 1-1/2 to 3 ton.....		✓	—	✓
BAYATXV4248.....	R-22 TXV conversion kit 3-1/2 to 4 ton.....		—	✓	✓
BAYATXV6060.....	R-22 TXV conversion kit 5 ton.....		—	✓	✓
BAYBRFBX100.....	Bottom Return Filter Box.....		✓	—	—
BAYFRKIT100.....	Front Return Kit.....		✓	—	—
BAYHHKIT001.....	Horizontal Hanger Kit.....		✓	—	—
BAYICKIT01.....	Internal Condensate Switch Kit (GAF2A0A36M311SA).....		3	—	—
BAYLVKIT100.....	Low Voltage Conduit Entry Kit.....		✓	—	—
BAYRETFLLGAA.....	Return Duct Flange A, A1.....	A, A1	✓	—	—
BAYRETFLLGBA.....	Return Duct Flange B.....	B	—	✓	—
BAYRETFLLGCA.....	Return Duct Flange C.....	C	—	✓	—
BAYSFSCABAA.....	Supply Duct Flange A1.....	A1	✓	—	—
BAYFLR1620A.....	Washable high velocity filter, 16" x 20" x 1" (10 filters).....	A	—	—	✓
BAYFLR2020A.....	Washable high velocity filter, 20" x 20" x 1" (10 filters).....	B	—	—	✓
BAYFLR2220A.....	Washable high velocity filter, 22" x 20" x 1" (10 filters).....	C	—	—	✓
BAYSPEKT200.....	Single Power Entry Kit.....		—	—	✓
BAYSRKIT100.....	Side Return Kit.....		—	—	✓
BAYFRKIT175.....	Front Return Kit.....	A	—	—	✓
BAYFRKIT210.....	Front Return Kit.....	B	—	—	✓
BAYFRKIT235.....	Front Return Kit.....	C	—	—	✓
BAYSUPFLGAA.....	Supply Duct Flange A.....	A	—	—	✓
BAYSUPFLGBA.....	Supply Duct Flange B.....	B	—	—	✓
BAYSUPFLGCA.....	Supply Duct Flange C.....	C	—	—	✓
BAYUVCLK001.....	UVC Lights.....		—	—	✓
BAYWMKIT001.....	Wall Mount Kit.....		—	—	✓
TASB175SB②④.....	Plenum Stand with Integrated Sound Baffle A.....	A	✓	—	—
TASB215SB②④.....	Plenum Stand with Integrated Sound Baffle B.....	B	—	✓	—
TASB235SB②④.....	Plenum Stand with Integrated Sound Baffle C.....	C	—	✓	—
MTISRKIT1620②.....	Side Return Kit with 16"x20" Filter.....	A-C	✓	—	—
TASSBK175②④.....	Sound Baffle Kit 17.5" Cabinet (mounts to TASB plenum stands).....	A	✓	—	—
TASSBK215②④.....	Sound Baffle Kit 21.5" Cabinet (mounts to TASB plenum stands).....	B	—	✓	—
TASSBK235②④.....	Sound Baffle Kit 23.5" Cabinet (mounts to TASB plenum stands).....	C	—	✓	—
BAYECPDKIT1.....	Pull disconnect kit.....	A1	✓	—	—
BAYBAFKT175A.....	Baffle Kit 17.5" Cabinet (mounts in air handler filter channel).....	A	✓	—	—
BAYBAFKT215A.....	Baffle Kit 21.5" Cabinet (mounts in air handler filter channel).....	B	—	✓	—
BAYBAFKT235A.....	Baffle Kit 23.5" Cabinet (mounts in air handler filter channel).....	C	—	✓	—
BAYINSKT175A.....	Sound Insulation Kit 17.5" Cabinet.....	A, A1	✓	—	—
BAYINSKT215A.....	Sound Insulation Kit 21.5" Cabinet.....	B	—	✓	—
BAYINSKT235A.....	Sound Insulation Kit 23.5" Cabinet.....	C	—	✓	—
BAYCNDPIP01A.....	3/4" PVC Threaded Pipe Kit with foam seal (10 kits).....		✓	—	—

① A and A1 Cabinets are 17.5" wide, B Cabinet is 21.5" wide, C Cabinet is 23.5" wide. The A1 cabinet is used on the GAF2 air handlers only.

② Contact your distributor for information.

③ In return plenum applications, use TASSBK kits for sound reduction.

④ In open air applications, Plenum Stand with Sound Baffle provides sound reduction.

Heaters for Multi-Position Air Handlers

Table AH-12-A — BAYEA — Heater, Standard, for 4 Series, 5 Series, GAT2, and GAM2 Air Handlers

Heater Model Number	Capacity @ 240 Volts		Capacity @ 208 Volts		Voltage	Control Stages	Number of Heater Racks	Number of Circuits	Heater Amps per Circuit		Contains Circuit Breakers
	kW	BTUH	kW	Rated BTUH					208 Volts	240Volt	
BAYEAC04BK1AA	3.84	13100	2.88	9800	208/240/1/60	1	1	1	13.8	16	Yes
BAYEAC04LG1AA	3.84	13100	2.88	9800	208/240/1/60	1	1	1	13.8	16	No
BAYEAC05BK1AA	4.80	16400	3.60	12300	208/240/1/60	1	1	1	17.3	20	Yes
BAYEAC05LG1AA	4.80	16400	3.60	12300	208/240/1/60	1	1	1	17.3	20	No
BAYEAC08BK1AA	7.68	26200	5.76	19700	208/240/1/60	2	2	1	27.7	32	Yes
BAYEAC08LG1AA	7.68	26200	5.76	19700	208/240/1/60	2	2	1	27.7	32	No
BAYEAC10BK1AA	9.60	32800	7.20	24600	208/240/1/60	2	2	1	34.6	40	Yes
BAYEAC10LG1AA	9.60	32800	7.20	24600	208/240/1/60	2	2	1	34.6	40	No
BAYEABC15BK1AA	14.40	49200	10.80	36900	208/240/1/60	3	3	2	34.6/17.3	40/20	Yes
BAYEABC20BK1AA	19.20	65600	14.40	49200	208/240/1/60	3	4	2	34.6/34.6	40/40	Yes
BAYEACC25BK1AA	24.00	82000	18.00	61500	208/240/1/60	3	5	3	34.6/34.6/17.3	40/40/20	Yes

BK = Contains circuit breakers
LG = Contains lug connections

Table AH-12-B — BAYEV — Heater, Standard, for 7 and 8 Series Air Handlers

Heater Model Number	Capacity @ 240 Volts		Capacity @ 208 Volts		Voltage	Control Stages	Number of Heater Racks	Number of Circuits	Heater Amps per Circuit		Contains Circuit Breakers
	kW	BTUH	kW	Rated BTUH					208 Volts	240Volt	
BAYEVAC04BK1AA	3.84	13100	2.88	9800	208/240/1/60	1	1	1	13.8	16	Yes
BAYEVAC04LG1AA	3.84	13100	2.88	9800	208/240/1/60	1	1	1	13.8	16	No
BAYEVAC05BK1AA	4.80	16400	3.60	12300	208/240/1/60	1	1	1	17.3	20	Yes
BAYEVAC05LG1AA	4.80	16400	3.60	12300	208/240/1/60	1	1	1	17.3	20	No
BAYEVAC08BK1AA	7.68	26200	5.76	19700	208/240/1/60	2	2	1	27.7	32	Yes
BAYEVAC08LG1AA	7.68	26200	5.76	19700	208/240/1/60	2	2	1	27.7	32	No
BAYEVAC10BK1AA	9.60	32800	7.20	24600	208/240/1/60	2	2	1	34.6	40	Yes
BAYEVAC10LG1AA	9.60	32800	7.20	24600	208/240/1/60	2	2	1	34.6	40	No
BAYEVBC15BK1AA	14.40	49200	10.80	36900	208/240/1/60	3	3	2	34.6/17.3	40/20	Yes
BAYEVBC20BK1AA	19.20	65600	14.40	49200	208/240/1/60	3	4	2	34.6/34.6	40/40	Yes
BAYEVCC25BK1AA	24.00	82000	18.00	61500	208/240/1/60	3	5	3	34.6/34.6/17.3	40/40/20	Yes

BK = Contains circuit breakers
LG = Contains lug connections

Table AH-12-C — BAYEC — Heater, Compact, with Lugs, for GAF2 Air Handlers

Heater Model Number	Capacity @ 240 Volts		Capacity @ 208 Volts		Voltage	Control Stages	Number of Heater Racks	Number of Circuits	Heater Amps per Circuit		Contains Circuit Breakers
	kW	BTUH	kW	Rated BTUH					208 Volts	240Volt	
BAYECAA05LG1AA	4.80	16400	3.60	12300	208/240/1/60	1	1	1	17.3	20	No
BAYECAA08LG1AA	7.68	26200	5.76	19700	208/240/1/60	2	2	1	27.7	32	No
BAYECAA10LG1AA	9.60	32800	7.20	24600	208/240/1/60	2	2	1	34.6	40	No

BAYECPDKIT1 - Optional pull disconnect used with BAYEC heaters only

Table AH-12-D — BAYEA — Heater, 3-Phase, for 4 Series, 5 Series, GAT2, and GAM2 Air Handlers 1

Heater Model Number	Capacity @ 240 Volts		Capacity @ 208 Volts		Voltage	Control Stages	Number of Heater Racks	Number of Circuits	Heater Amps per Circuit		Contains Circuit Breakers
	kW	BTUH	kW	Rated BTUH					208 Volts	240Volt	
BAYEAC10LG3AA	9.60	32800	7.20	24600	208/240/3/60	1	3	1	20.0	23.1	No
BAYEABC15LG3AA	14.40	49200	10.80	36900	208/240/3/60	1	3	1	30.0	34.6	No

① 3-Phase - W1, W2, W3 must be jumpered at low voltage connector

Table AH-12-E — BAYEV — Heater, 3-Phase, for 7 and 8 Series Air Handlers

Heater Model Number	Capacity @ 240 Volts		Capacity @ 208 Volts		Voltage	Control Stages	Number of Heater Racks	Number of Circuits	Heater Amps per Circuit		Contains Circuit Breakers
	kW	BTUH	kW	Rated BTUH					208 Volts	240Volt	
BAYEVAC10LG3AA	9.60	32800	7.20	24600	208/240/3/60	1	3	1	20.0	23.1	No
BAYEVBC15LG3AA	14.40	49200	10.80	36900	208/240/3/60	1	3	1	30.0	34.6	No

Air Handlers/Heaters

For complete equipment / combination selections, installation instructions and warranty information, please refer to Product Data/Ratings and/or Installers Guides and Limited Warranty Handbooks.

Heaters for Multi-Position Air Handlers

Table AH-13-A — Air Handler/Heater Matrix

AIR HANDLER	HEATER MODEL NUMBER BAYEA-										
	AC04BK1AA	AC04LG1AA	AC05BK1AA	AC05LG1AA	AC08BK1AA	AC08LG1AA	AC10BK1AA	AC10LG1AA	BC15BK1AA	BC20BK1AA	CC25BK1AA
	3.84 Kw BK	3.84 Kw LG	4.80 Kw BK	4.80 Kw LG	7.68 Kw BK	7.68 Kw LG	9.60 Kw BK	9.60 Kw LG	14.40 Kw BK	19.20 Kw BK	24.00 Kw BK
GAM5B0A18M11SA	Y	Y	Y	Y	Y	Y	Y	Y	—	—	—
GAM5B0A24M21SA	Y	Y	Y	Y	Y	Y	Y	Y	—	—	—
GAM5B0B30M21SA	Y	Y	Y	Y	Y	Y	Y	Y	Y	—	—
GAM5B0B36M31SA	Y	Y	Y	Y	Y	Y	Y	Y	Y	—	—
GAM5B0C42M31SA	Y	Y	Y	Y	Y	Y	Y	Y	Y	—	—
GAM5B0C48M41SA	Y	Y	Y	Y	Y	Y	Y	Y	Y	Y	Y
GAM5B0C60M51SA	Y	Y	Y	Y	Y	Y	Y	Y	Y	Y	Y
HEATER MODEL NUMBER BAYEA-											
TAM4A0A18S11SC	Y	Y	Y	Y	Y	Y	Y	Y	—	—	—
TAM4A0A24S21SC	Y	Y	Y	Y	Y	Y	Y	Y	—	—	—
TAM4A0A30S21SC	Y	Y	Y	Y	Y	Y	Y	Y	Y	—	—
TAM4A0A36S31SC	Y	Y	Y	Y	Y	Y	Y	Y	Y	—	—
TAM4A0B42S31SC	Y	Y	Y	Y	Y	Y	Y	Y	Y	Y	—
TAM4A0C48S41SC	Y	Y	Y	Y	Y	Y	Y	Y	Y	Y	Y
TAM4A0C60S51SC	Y	Y	Y	Y	Y	Y	Y	Y	Y	Y	Y
HEATER MODEL NUMBER BAYEB-											
GAM2A0A18S11SB	Y	Y	Y	Y	Y	Y	Y	Y	—	—	—
GAM2A0A24S21SB	Y	Y	Y	Y	Y	Y	Y	Y	—	—	—
GAM2A0A30S21SB	Y	Y	Y	Y	Y	Y	Y	Y	Y	—	—
GAM2A0A36S31SB	Y	Y	Y	Y	Y	Y	Y	Y	Y	—	—
GAM2A0B42S31SB	Y	Y	Y	Y	Y	Y	Y	Y	Y	Y	—
GAM2A0C48S41SB	Y	Y	Y	Y	Y	Y	Y	Y	Y	Y	Y
GAM2A0C60S51SB	Y	Y	Y	Y	Y	Y	Y	Y	Y	Y	Y
HEATER MODEL NUMBER BAYEV-											
TAM8A0A24V21CC	Y	Y	Y	Y	Y	Y	Y	Y	—	—	—
TAM8A0B30V21CC	Y	Y	Y	Y	Y	Y	Y	Y	Y	—	—
TAM8A0C36V31CC	Y	Y	Y	Y	Y	Y	Y	Y	Y	Y	—
TAM8A0C42V31CC	Y	Y	Y	Y	Y	Y	Y	Y	Y	Y	—
TAM8A0C48V41CC	Y	Y	Y	Y	Y	Y	Y	Y	Y	Y	Y
TAM8B0C60V51CB	Y	Y	Y	Y	Y	Y	Y	Y	Y	Y	Y
HEATER MODEL NUMBER BAYEH-											
TAM7A0A24H21SC	Y	Y	Y	Y	Y	Y	Y	Y	—	—	—
TAM7A0B30H21SC	Y	Y	Y	Y	Y	Y	Y	Y	Y	—	—
TAM7A0C36H31SC	Y	Y	Y	Y	Y	Y	Y	Y	Y	Y	—
TAM7A0C42H31SC	Y	Y	Y	Y	Y	Y	Y	Y	Y	Y	—
TAM7A0C48H41SC	Y	Y	Y	Y	Y	Y	Y	Y	Y	Y	Y
TAM7B0C60H51SB	Y	Y	Y	Y	Y	Y	Y	Y	Y	Y	Y

BK = Contains circuit breakers
 LG = Contains lug connections
 BK = Contains circuit breakers
 LG = Contains lug connections

For complete equipment / combination selections, installation instructions and warranty information, please refer to Product Data/Ratings and/or Installers Guides and Limited Warranty Handbooks.

Heaters for Multi-Position Air Handlers

Table AH-14-A — Air Handler/Heater Matrix (continued)

AIR HANDLER MODEL NUMBER	HEATER MODEL NUMBER BAYEC-		
	AA05LG1AA 4.80 Kw BK	AA08LG1AA 7.68 Kw LG	AA10LG1AA 9.60 Kw LG
GAF2A0A18S11SB	Y	Y	Y
GAF2A0A24S21SB	Y	Y	Y
GAF2A0A30S21SB	Y	Y	Y
GAF2A0A36M31SB	Y	Y	Y
GAF2A0A36S31SB	Y	Y	Y
GAF2A0A36S3ASB	Y	Y	Y

AIR HANDLER MODEL NUMBER	HEATER MODEL NUMBER BAYEA-	
	AC10LG3AA 9.60 Kw LG	BC15LG3AA 9.60 Kw LG
GAM5B0A18M11SA	Y	—
GAM5B0A24M21SA	Y	—
GAM5B0B30M21SA	Y	Y
GAM5B0B36M31SA	Y	Y
GAM5B0C42M31SA	Y	Y
GAM5B0C48M41SA	Y	Y
GAM5B0C60M51SA	Y	Y
TAM4A0A18S11SC	Y	—
TAM4A0A24S21SC	Y	—
TAM4A0A30S21SC	Y	Y
TAM4A0A36S31SC	Y	Y
TAM4A0B42S31SC	Y	Y
TAM4A0C48S41SC	Y	Y
TAM4A0C60S51SC	Y	Y
GAM2A0A18S11SB	Y	—
GAM2A0A24S21SB	Y	—
GAM2A0A30S21SB	Y	Y
GAM2A0A36S31SB	Y	Y
GAM2A0B42S31SB	Y	Y
GAM2A0C48S41SB	Y	Y
GAM2A0C60S51SB	Y	Y
GAT2A0B42S31SB	Y	Y
GAT2A0C48S41SB	Y	Y
GAT2A0C60S51SB	Y	Y

AIR HANDLER MODEL NUMBER	HEATER MODEL NUMBER BAYEV-	
	AC10LG3AA 9.60 Kw LG	BC15LG3AA 14.4 Kw LG
TAM8A0A24V21CC	Y	—
TAM8A0B30V21CC	Y	Y
TAM8A0C36V31CC	Y	Y
TAM8A0C42V31CC	Y	Y
TAM8A0C48V41CC	Y	Y
TAM8B0C60V51CB	Y	Y
TAM7A0A24H21SC	Y	—
TAM7A0B30H21SC	Y	Y
TAM7A0C36H31SC	Y	Y
TAM7A0C42H31SC	Y	Y
TAM7A0C48H41SC	Y	Y
TAM7B0C60H51SB	Y	Y

Series 3 Split System Air Handlers Single Phase 1½-5 Tons

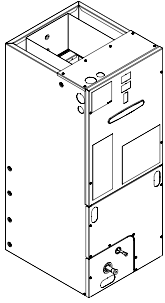

Table AH-15-A — R-410A Convertible Air Handler 208-230/1/60

Unit Model No.	Cooling Capacity (Btuh)	Dimensions (in.) H x W x D	Shipping Weight (lbs.)	Supply Opening	Return Opening	Filter Sizes	Line Size Gas	Line Size Liquid
TEM3A0B18S21SA	18000	45.02 x 18.5 x 21.13	116	16.5 x 12.15	16.75 x 18.75	①	¾	⅜
TEM3A0B24S21SA	24000	45.02 x 18.5 x 21.13	116	16.5 x 12.15	16.75 x 18.75	①	¾	⅜
TEM3A0B30S31SA	30000	45.02 x 18.5 x 21.13	116	16.5 x 12.15	16.75 x 18.75	①	¾	⅜
TEM3A0B36S31SA	36000	45.02 x 18.5 x 21.13	116	16.5 x 12.15	16.75 x 18.75	①	¾	⅜
TEM3A0C42S41SA	42000	51.27 x 23.5 x 21.13	145	21.5 x 12.15	21.75 x 18.75	①	7/8	⅜
TEM3A0C48S41SA	48000	51.27 x 23.5 x 21.13	145	21.5 x 12.15	21.75 x 18.75	①	7/8	⅜
TEM3A0C60S51SA	60000	51.27 x 23.5 x 21.13	145	21.5 x 12.15	21.75 x 18.75	①	7/8	⅜

① Filter not supplied. Remote filter required.

Table AH-15-B — Features

	TEM3 1 1/2-5
• Painted metal cabinet with captured foil face insulation	✓
• 2% or less air leakage	✓
• R-4.2 Insulating Value	✓
• Multi-Position UP/Down Flow*, Horizontal Left /Right	✓
• ALL Aluminum Coil with Enhanced Patented Coil Fin	✓
• Electric Heaters with polarized plug connections (sold as accessory)	✓
• R-410A Thermal Expansion Valve	✓
• Low Voltage Pigtail Connections	✓
• Draw Through Design	✓
• Horizontal Drain pan	✓
• Single Color	✓
• Fused 24V Power	✓
• 1 year warranty	✓
• 10-year warranty registered	✓
• Optional extended warranty available	✓

Table AH-15-C — Optional Accessories

Model Number	Description	Matches Cabinet Size(s)	TEM3
BAYTEMSPFG1A.....	Supply Duct Flange Kit.....	18.5" and 23.5".....	✓
BAYSPEKT201A.....	Single Point Power Entry Kit.....	18.5" and 23.5".....	✓
TAYBASE185.....	Air Handler Downflow Sub-Bases.....	18.5".....	✓
TAYBASE235 (TAYBASE100)....	Air Handler Downflow Sub-Bases.....	23.5".....	✓
BAYTEMDFKT1A.....	Downflow Condensate Management Kit.....	23.5" ①.....	✓
BAYATXV1836B.....	R-22 TXV conversion kit.....		1½-3
BAYATXV4248B.....	R-22 TXV conversion kit.....		3½-4
BAYATXV6161B.....	R-22 TXV conversion kit.....		5

① Downflow condensate management kit is required for 5 Ton downflow models.

Heaters for Series 3 Split System Air Handlers

Table AH-16-A — BAYHTR15 — Heater, Standard, for Series 3 Air Handlers

Heater Model Number	Capacity @ 240 Volts		Capacity @ 208 Volts		Voltage	Control Stages	Number of Heater Racks	Number of Circuits	Heater Amps per Circuit		Contains Circuit Breakers
	kW	BTUH	kW	Rated BTUH					208 Volts	240Volt	
BAYHTR1504BRKA	3.84	13100	2.88	9800	208/240/1/60	1	1	1	13.8	16	Yes
BAYHTR1504PDCA	3.84	13100	2.88	9800	208/240/1/60	1	1	1	13.8	16	No
BAYHTR1505BRKA	4.80	16400	3.60	12300	208/240/1/60	1	1	1	17.3	20	Yes
BAYHTR1505PDCA	4.80	16400	3.60	12300	208/240/1/60	1	1	1	17.3	20	No
BAYHTR1508BRKA	7.68	26200	5.76	19700	208/240/1/60	1	1	1	27.7	32	Yes
BAYHTR1508PDCA	7.68	26200	5.76	19700	208/240/1/60	1	1	1	27.7	32	No
BAYHTR1510BRKA	9.60	32800	7.20	24600	208/240/1/60	1	2	1	34.6	40	Yes
BAYHTR1510PDCA	9.60	32800	7.20	24600	208/240/1/60	1	2	1	34.6	40	No
BAYHTR1515BRKA	14.4	49200	10.8	36900	208/240/1/60	2	3	2	51.9	60	Yes
BAYHTR1519BRKA	19.2	65500	14.4	49200	208/240/1/60	2	4	2	69.2	80	Yes
BAYHTR1520BRKA	19.2	65500	14.4	49200	208/240/1/60	2	4	2	69.2	80	Yes

BRK = Contains circuit breakers
PDC = Pull Disconnects

Table AH-16-B — BAYHTR35 — Heater, 3-Phase, for Series 3 Air Handlers ①

Heater Model Number	Capacity @ 240 Volts		Capacity @ 208 Volts		Voltage	Control Stages	Number of Heater Racks	Number of Circuits	Heater Amps per Circuit		Contains Circuit Breakers
	kW	BTUH	kW	Rated BTUH					208 Volts	240Volt	
BAYHTR3510LUGA	9.60	32800	7.20	24600	208/240/1/60	1	3	1	20.0	23.1	No
BAYHTR3515LUGA	14.4	49200	10.8	36900	208/240/1/60	1	3	1	30.0	34.6	No

LUG = Contains Lug terminals

① 3-Phase - W1 and W2 must be jumpered at low voltage connector

Table AH-16-C — Series 3 Air Handler and Heater matches

TEM3 MINIMUM HEATER AIRFLOW CFM - HEATER MATRIX						
Model No.	BAYHTR1504BRK* BAYHTR1504PDC* BAYHTR1505BRK* BAYHTR1505PDC*	BAYHTR1508BRK* BAYHTR1508PDC* BAYHTR1510BRK* BAYHTR1510PDC* BAYHTR3510LUG*	BAYHTR1515BRK*	BAYHTR1519BRK*	BAYHTR1520BRK*	BAYHTR3515LUG*
TEM3A0B18S21S*	L / L	L / L	--	--	--	--
TEM3A0B24S21S*	L / L	L / L	--	--	--	--
TEM3A0B30S31S*	L / L	L / L	L / L	L / L	--	L / L
TEM3A0B36S31S*	L / L	L / L	L / L	L / L	--	L / L
TEM3A0C42S41S*	L / L	L / L	L / L	--	L / L	L / L
TEM3A0C48S41S*	L / L	L / L	L / L	--	L / L	L / L
TEM3A0C60S51S*	L / L	L / L	L / L	--	L / L	L / L

Cooling / HP Airflow
* = Followed by two digits
Note: On the TEM3A0C60S51S model, taps 1-3 = Low, tap 4 = Med, tap 5 = High

Silver Series Air Handlers

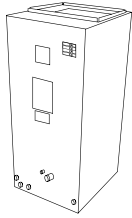

Table AH-17-A — Convertible Air Handler

Unit Model No.	Cooling Capacity (Btuh)	Dimensions (in.) H x W x D	Shipping Weight (lbs.)	Supply Opening	Return Opening	Filter Sizes	Line Size	
							Gas	Liquid
4FWCA024A1000①	24000	45.0 x 19.75 x 21.5	73	18.25 x 15.0	15.75 x 18.75	Remote*	3/4	3/8
4FWCA025A1000①	24000	45.0 x 19.75 x 21.5	73	18.25 x 15.0	15.75 x 18.75	Remote*	3/4	3/8
4FWCA030A1000①	30000	45.0 x 19.75 x 21.5	73	18.25 x 15.0	15.75 x 18.75	Remote*	3/4	3/8
4FWCA031A1000①	30000	45.0 x 19.75 x 21.5	73	18.25 x 15.0	15.75 x 18.75	Remote*	3/4	3/8
4FWCA036A1000①	36000	45.0 x 19.75 x 21.5	73	18.25 x 15.0	15.75 x 18.75	Remote*	3/4	3/8
4FWCA048A1000①	48000	51.0 x 23.0 x 22.5	94	21.75 x 15.5	19 x 19.5	Remote*	7/8	3/8
4FWCA049A1000①	48000	51.0 x 23.0 x 22.5	94	21.75 x 15.5	19 x 19.5	Remote*	7/8	3/8
4FWCA060A1000①	60000	51.0 x 23.0 x 22.5	94	21.75 x 15.5	19 x 19.5	Remote*	7/8	3/8
4FWCA061A1000①	60000	51.0 x 23.0 x 22.5	94	21.75 x 15.5	19 x 19.5	Remote*	7/8	3/8

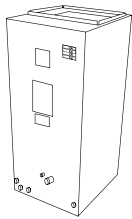

Table AH-17-B — Convertible Air Handler - R4.2 models

Unit Model No.	Cooling Capacity (Btuh)	Dimensions (in.) H x W x D	Shipping Weight (lbs.)	Supply Opening	Return Opening	Filter Sizes	Line Size	
							Gas	Liquid
4FWCF024A1000①	24000	45.0 x 19.75 x 21.5	73	18.25 x 15.0	15.75 x 18.75	Remote*	3/4	3/8
4FWCF025A1000①	24000	45.0 x 19.75 x 21.5	73	18.25 x 15.0	15.75 x 18.75	Remote*	3/4	3/8
4FWCF030A1000①	30000	45.0 x 19.75 x 21.5	73	18.25 x 15.0	15.75 x 18.75	Remote*	3/4	3/8
4FWCF031A1000①	30000	45.0 x 19.75 x 21.5	73	18.25 x 15.0	15.75 x 18.75	Remote*	3/4	3/8
4FWCF036A1000①	36000	45.0 x 19.75 x 21.5	73	18.25 x 15.0	15.75 x 18.75	Remote*	3/4	3/8
4FWCF048A1000①	48000	51.0 x 23.0 x 22.5	94	21.75 x 15.5	19 x 19.5	Remote*	7/8	3/8
4FWCF049A1000①	48000	51.0 x 23.0 x 22.5	94	21.75 x 15.5	19 x 19.5	Remote*	7/8	3/8
4FWCF060A1000①	60000	51.0 x 23.0 x 22.5	94	21.75 x 15.5	19 x 19.5	Remote*	7/8	3/8
4FWCF061A1000①	60000	51.0 x 23.0 x 22.5	94	21.75 x 15.5	19 x 19.5	Remote*	7/8	3/8

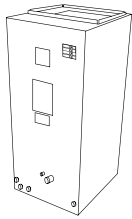

Table AH-17-C — Convertible Air Handler - Constant Torque ECM Motor

Unit Model No.	Cooling Capacity (Btuh)	Dimensions (in.) H x W x D	Shipping Weight (lbs.)	Supply Opening	Return Opening	Filter Sizes	Line Size	
							Gas	Liquid
4FWHA024A1000①	24000	45.0 x 19.75 x 21.5	73	18.25 x 15.0	15.75 x 18.75	Remote*	3/4	3/8
4FWHA025A1000①	24000	45.0 x 19.75 x 21.5	73	18.25 x 15.0	15.75 x 18.75	Remote*	3/4	3/8
4FWHA030A1000①	30000	45.0 x 19.75 x 21.5	73	18.25 x 15.0	15.75 x 18.75	Remote*	3/4	3/8
4FWHA036A1000①	30000	45.0 x 19.75 x 21.5	73	18.25 x 15.0	15.75 x 18.75	Remote*	3/4	3/8
4FWHA042A1000①	42000	51.0 x 23.0 x 22.5	94	21.75 x 15.5	19 x 19.5	Remote*	7/8	3/8
4FWHA048A1000①	48000	51.0 x 23.0 x 22.5	94	21.75 x 15.5	19 x 19.5	Remote*	7/8	3/8
4FWHA060A1000①	60000	51.0 x 23.0 x 22.5	94	21.75 x 15.5	19 x 19.5	Remote*	7/8	3/8
4FWHA061A1000①	60000	51.0 x 23.0 x 22.5	94	21.75 x 15.5	19 x 19.5	Remote*	7/8	3/8

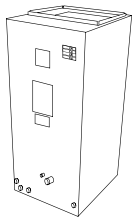

Table AH-17-D — Convertible Air Handler - Constant Torque ECM Motor - R4.2 Models

Unit Model No.	Cooling Capacity (Btuh)	Dimensions (in.) H x W x D	Shipping Weight (lbs.)	Supply Opening	Return Opening	Filter Sizes	Line Size	
							Gas	Liquid
4FWHF024A1000①	24000	45.0 x 19.75 x 21.5	73	18.25 x 15.0	15.75 x 18.75	Remote*	3/4	3/8
4FWHF025A1000①	24000	45.0 x 19.75 x 21.5	73	18.25 x 15.0	15.75 x 18.75	Remote*	3/4	3/8
4FWHF030A1000①	30000	45.0 x 19.75 x 21.5	73	18.25 x 15.0	15.75 x 18.75	Remote*	3/4	3/8
4FWHF036A1000①	36000	45.0 x 19.75 x 21.5	73	18.25 x 15.0	15.75 x 18.75	Remote*	3/4	3/8
4FWHF042A1000C②	42000	51.0 x 22.0 x 22.75	94	20.75 x 15.5	19 x 19.5	Remote*	7/8	3/8
4FWHF042A1000①	42000	51.0 x 23.0 x 22.5	94	21.75 x 15.5	19 x 19.5	Remote*	7/8	3/8
4FWHF048A1000C②	48000	51.0 x 22.0 x 22.75	94	20.75 x 15.5	19 x 19.5	Remote*	7/8	3/8
4FWHF048A1000①	48000	51.0 x 23.0 x 22.5	94	21.75 x 15.5	19 x 19.5	Remote*	7/8	3/8
4FWHF060A1000C②	60000	51.0 x 22.0 x 22.75	94	20.75 x 15.5	19 x 19.5	Remote*	7/8	3/8
4FWHF060A1000①	60000	51.0 x 23.0 x 22.5	94	21.75 x 15.5	19 x 19.5	Remote*	7/8	3/8
4FWHF061A1000C②	60000	51.0 x 22.0 x 22.75	94	20.75 x 15.5	19 x 19.5	Remote*	7/8	3/8
4FWHF061A1000①	60000	51.0 x 23.0 x 22.5	94	21.75 x 15.5	19 x 19.5	Remote*	7/8	3/8

*Field Supplied

① 14th digit "A" models are phased out. 14th digit "B" models are shipped pressurized.

② 14th digit "B" models are phasing out. 14th digit "C" models are shipped pressurized.

For complete equipment / combination selections, installation instructions and warranty information, please refer to Product Data/Ratings and/or Installers Guides and Limited Warranty Handbooks.

Silver Series Air Handlers

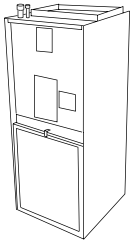

Table AH-18-A — Stud Mount Air Handler with Factory Installed Electric Heat

Unit Model No.	Cooling Capacity (Btuh)	Dimensions (in.) H x W x D	Shipping Weight (lbs.)	Supply Opening	Return Opening	Filter Sizes	Line Size	
							Gas	Liquid
4FWMA024A1005①	24000	36.75 x 18.25 x 18	57	11 x 16.5	18 x 18	18 x 18 x 1	3/4	3/8
4FWMA024A1DS5①	24000	36.75 x 18.25 x 18	57	11 x 16.5	18 x 18	18 x 18 x 1	3/4	3/8
4FWMA024A1008①	24000	36.75 x 18.25 x 18	57	11 x 16.5	18 x 18	18 x 18 x 1	3/4	3/8
4FWMA024A1DS8①	24000	36.75 x 18.25 x 18	57	11 x 16.5	18 x 18	18 x 18 x 1	3/4	3/8
4FWMA024A1010①	24000	36.75 x 18.25 x 18	57	11 x 16.5	18 x 18	18 x 18 x 1	3/4	3/8
4FWMA024A1DS10①	24000	36.75 x 18.25 x 18	57	11 x 16.5	18 x 18	18 x 18 x 1	3/4	3/8
4FWMA030A1008①	30000	36.75 x 18.25 x 18	57	11 x 16.5	18 x 18	18 x 18 x 1	3/4	3/8
4FWMA030A1DS8①	30000	36.75 x 18.25 x 18	57	11 x 16.5	18 x 18	18 x 18 x 1	3/4	3/8
4FWMA030A1010①	30000	36.75 x 18.25 x 18	57	11 x 16.5	18 x 18	18 x 18 x 1	3/4	3/8
4FWMA030A1DS10①	30000	36.75 x 18.25 x 18	57	11 x 16.5	18 x 18	18 x 18 x 1	3/4	3/8
4FWMA031A1008①	30000	40 x 20.5 x 22	65	15 x 19	20 x 20	20 x 20 x 1	3/4	3/8
4FWMA031A1DS8①	30000	40 x 20.5 x 22	65	15 x 19	20 x 20	20 x 20 x 1	3/4	3/8
4FWMA031A1010①	30000	40 x 20.5 x 22	65	15 x 19	20 x 20	20 x 20 x 1	3/4	3/8
4FWMA031A1DS10①	30000	40 x 20.5 x 22	65	15 x 19	20 x 20	20 x 20 x 1	3/4	3/8
4FWMA036A1010①	36000	40 x 20.5 x 22	65	15 x 19	20 x 20	20 x 20 x 1	3/4	3/8
4FWMA036A1DS10①	36000	40 x 20.5 x 22	65	15 x 19	20 x 20	20 x 20 x 1	3/4	3/8
4FWMA036A1015①	36000	40 x 20.5 x 22	65	15 x 19	20 x 20	20 x 20 x 1	3/4	3/8

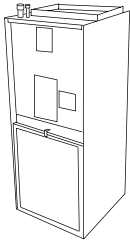

Table AH-18-B — Stud Mount Air Handler with Factory Installed Electric Heat - R4.2 Models

Unit Model No.	Cooling Capacity (Btuh)	Dimensions (in.) H x W x D	Shipping Weight (lbs.)	Supply Opening	Return Opening	Filter Sizes	Line Size	
							Gas	Liquid
4FWMF024A1005①	24000	36.75 x 18.25 x 18	57	11 x 16.5	18 x 18	18 x 18 x 1	3/4	3/8
4FWMF024A1DS5①	24000	36.75 x 18.25 x 18	57	11 x 16.5	18 x 18	18 x 18 x 1	3/4	3/8
4FWMF024A1008①	24000	36.75 x 18.25 x 18	57	11 x 16.5	18 x 18	18 x 18 x 1	3/4	3/8
4FWMF024A1DS8①	24000	36.75 x 18.25 x 18	57	11 x 16.5	18 x 18	18 x 18 x 1	3/4	3/8
4FWMF024A1010①	24000	36.75 x 18.25 x 18	57	11 x 16.5	18 x 18	18 x 18 x 1	3/4	3/8
4FWMF024A1DS10①	24000	36.75 x 18.25 x 18	57	11 x 16.5	18 x 18	18 x 18 x 1	3/4	3/8
4FWMF030A1008①	30000	36.75 x 18.25 x 18	57	11 x 16.5	18 x 18	18 x 18 x 1	3/4	3/8
4FWMF030A1DS8①	30000	36.75 x 18.25 x 18	57	11 x 16.5	18 x 18	18 x 18 x 1	3/4	3/8
4FWMF030A1010①	30000	36.75 x 18.25 x 18	57	11 x 16.5	18 x 18	18 x 18 x 1	3/4	3/8
4FWMF030A1DS10①	30000	36.75 x 18.25 x 18	57	11 x 16.5	18 x 18	18 x 18 x 1	3/4	3/8
4FWMF031A1008①	30000	40 x 20.5 x 22	65	15 x 19	20 x 20	20 x 20 x 1	3/4	3/8
4FWMF031A1DS8①	30000	40 x 20.5 x 22	65	15 x 19	20 x 20	20 x 20 x 1	3/4	3/8
4FWMF031A1010①	30000	40 x 20.5 x 22	65	15 x 19	20 x 20	20 x 20 x 1	3/4	3/8
4FWMF031A1DS10①	30000	40 x 20.5 x 22	65	15 x 19	20 x 20	20 x 20 x 1	3/4	3/8
4FWMF036A1010①	36000	40 x 20.5 x 22	65	15 x 19	20 x 20	20 x 20 x 1	3/4	3/8
4FWMF036A1DS10①	36000	40 x 20.5 x 22	65	15 x 19	20 x 20	20 x 20 x 1	3/4	3/8
4FWMF036A1015①	36000	40 x 20.5 x 22	65	15 x 19	20 x 20	20 x 20 x 1	3/4	3/8

Table AH-18-C — Optional Accessories

Model Number	Description	4FWMA/F
BAYFPNLWAL01AA.....	Wall Return Grill, Louvered	024-030
BAYFPNLWAL02AA.....	Wall Return Grill, Louvered	031-036
BAYFPNLLOU01AA.....	Unit Return Grill, Louvered	024-030
BAYFPNLLOU02AA.....	Unit Return Grill, Louvered	031-036
BAYFPNLSOL01AA.....	Lower Coil Panel, Solid	024-030
BAYFPNLSOL02AA.....	Lower Coil Panel, Solid	031-036

*Field Supplied

① 14th digit "A" models are phased out. 14th digit "B" models are shipped pressurized.

Silver Series Air Handlers

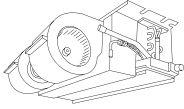

Table AH-19-A — Furr-Down Air Handlers - Uncased with Factory Installed Electric Heat

Unit Model No.	Cooling Capacity (Btuh)	Dimensions (in.) H x W x D	Shipping Weight (lbs.)	Supply Opening	Return Opening	Filter Sizes	Line Size	
							Gas	Liquid
4FWDA022A1005①	24000	10.25 x 37.25 x 22	60	7 x 30	37.25 x 22	Remote*	3/4	3/8
4FWDA022A1008①	24000	10.25 x 37.25 x 22	60	7 x 30	37.25 x 22	Remote*	3/4	3/8
4FWDA022A1010①	24000	10.25 x 37.25 x 22	60	7 x 30	37.25 x 22	Remote*	3/4	3/8
4FWDA024A1005①	24000	10.25 x 43.25 x 22	64	7 x 36	43.25 x 22	Remote*	3/4	3/8
4FWDA024A1008①	24000	10.25 x 43.25 x 22	64	7 x 36	43.25 x 22	Remote*	3/4	3/8
4FWDA024A1010①	24000	10.25 x 43.25 x 22	64	7 x 36	43.25 x 22	Remote*	3/4	3/8
4FWDA030A1008①	30000	10.25 x 43.25 x 22	64	7 x 36	43.25 x 22	Remote*	3/4	3/8
4FWDA030A1010①	30000	10.25 x 43.25 x 22	64	7 x 36	43.25 x 22	Remote*	3/4	3/8
4FWDA036A1010①	36000	10.25 x 43.25 x 22	74	7 x 42	43.25 x 22	Remote*	3/4	3/8

Table AH-19-B — Furr-Down Uncased Air Handlers and Heater Matrix — 4FWDA

AIR HANDLER MODEL NUMBER WITH FACTORY INSTALLED HEATER			
Model +	5 Kw Terminal Block	8 Kw Terminal Block	10 Kw Terminal Block
4FWDA022①	A1005A	A1008A	A1010A
4FWDA024	A1005A	A1008A	A1010A
4FWDA030	N/A	A1008A	A1010A
4FWDA036	N/A	N/A	A1010A

Note: Complete model number includes air handler size plus factory installed heater selection.
Example: 4FWDA024A1005A = a 2 ton air handler with 5 Kw electric heater with terminal block
① This model for AC applications only.

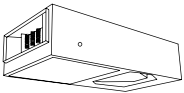

Table AH-19-C — Furr-Down Air Handlers - Cased with Factory Installed Electric Heat

Unit Model No.	Cooling Capacity (Btuh)	Dimensions (in.) H x W x D	Shipping Weight (lbs.)	Supply Opening	Return Opening	Filter Sizes	Line Size	
							Gas	Liquid
4FWFA024A1005①	24000	12 x 47 x 22.5	55	8 x 20.75	21 x 21.5	22 x 22 x 1	3/4	3/8
4FWFA024A1008①	24000	12 x 47 x 22.5	55	8 x 20.75	21 x 21.5	22 x 22 x 1	3/4	3/8
4FWFA024A1010①	24000	12 x 47 x 22.5	55	8 x 20.75	21 x 21.5	22 x 22 x 1	3/4	3/8
4FWFA030A1008①	30000	12 x 47 x 22.5	55	8 x 20.75	21 x 21.5	22 x 22 x 1	3/4	3/8
4FWFA030A1010①	30000	12 x 47 x 22.5	60	8 x 20.75	21 x 21.5	22 x 22 x 1	3/4	3/8
4FWFA031A1008①	30000	12 x 51 x 22.5	60	8 x 20.75	21 x 21.5	22 x 22 x 1	3/4	3/8
4FWFA031A1010①	30000	12 x 51 x 22.5	60	8 x 20.75	21 x 21.5	22 x 22 x 1	3/4	3/8
4FWFA036A1010①	36000	12 x 51 x 22.5	60	8 x 20.75	21 x 21.5	22 x 22 x 1	3/4	3/8

*Field Supplied

Table AH-19-D — Furr-Down Air Handlers - Cased with Factory Installed Electric Heat — 4FWFA

AIR HANDLER MODEL NUMBER WITH FACTORY INSTALLED HEATER			
Model +	5 Kw Terminal Block	8 Kw Terminal Block	10 Kw Terminal Block
4FWFA024	A1005A	A1008A	A1010A
4FWFA030,31	N/A	A1008A	A1010A
4FWFA036	N/A	N/A	A1010A

Note: Complete model number includes air handler size plus factory installed heater selection.
Example: 4FWFA024A1005A = a 2 ton air handler with 5 Kw electric heater with terminal block.

*Field Supplied

① 14th digit "A" models are phased out. 14th digit "B" models are shipped pressurized.

Heaters Silver Series Air Handlers

Table AH-20-A — Heaters Silver Series Air Handlers

BAYHTR -- HEATER DATA											
HEATER MODEL NUMBER	CAPACITY @ 240 VOLT		CAPACITY @ 208 VOLT		VOLTAGE	CONTROL STAGES	NUMBER OF HEATER RACKS	NO. OF CIRCUITS	HEATER AMPS PER CIRCUIT 208 VOLT	HEATER AMPS PER CIRCUIT 240 VOLT	CONTAINS CIRCUIT BREAKERS
	kW	BTUH	kW	BTUH							
	BAYHTR**1403SL0	3	10200	2.25							
BAYHTR**1405SL0	4.8	16400	3.6	12300	208/240/1/60	1	1	1	17.3	20	No
BAYHTR**1406SL0	6	20500	4.5	15400	208/240/1/60	1	1	1	21.6	25	No
BAYHTR**1408SL0	8	27300	6	20500	208/240/1/60	1	2	1	28.8	33.3	No
BAYHTR**1410SL0	9.6	32800	7.2	24600	208/240/1/60	1	2	1	34.6	40	No
BAYHTRBK1415SL0	14.4	49100	10.8	36800	208/240/1/60	1	3	2	34.6/17.3	40/20	Yes
BAYHTRBK1420SL0	19.2	65500	14.4	49100	208/240/1/60	1	4	2	34.6/34.6	40/40	Yes
BAYHTRDS1405BL0	4.8	16400	3.6	12300	208/240/1/60	1	1	1	17.3	20	No
BAYHTRDS1408BL0	8	27300	6	20500	208/240/1/60	1	2	1	28.8	33.3	No
BAYHTR**1410BL0	9.6	32800	7.2	24600	208/240/1/60	1	2	1	34.6	40	No
BAYHTRBK1415BL0	14.4	49100	10.8	36800	208/240/1/60	1	3	2	34.6/17.3	40/20	Yes
BAYHTRBK1420BL0	19.2	65500	14.4	49100	208/240/1/60	1	4	2	34.6/34.6	40/40	Yes

Note: Heaters with two circuits are displayed as Circuit 1/Circuit 2 (Minimum Circuit Ampacity for Circuit 1 includes Blower Motor Amp)

** = DS or Blank (DS = Pull Disconnect, Blank = terminal block)

Heaters Silver Series Air Handlers

Table AH-21-A — Heaters Silver Series Air Handlers

MINIMUM HEATING AIRFLOW CFM - HEATER MATRIX												
4FWCA, 4FWCF AIR HANDLER	HEATER											
MODEL NUMBER	BAYHTR1403SLO BAYHTRDS1403SLO 3 kW	BAYHTR1405SLO BAYHTRDS1405SLO 5 kW	BAYHTR1406SLO BAYHTRDS1406SLO 6 kW	BAYHTR1408SLO BAYHTRDS1408SLO 8 kW	BAYHTR1410SLO BAYHTRDS1410SLO 10 kW	BAYHTRBK1415SLO 15 kW	BAYHTRBK1420SLO 20 kW	BAYHTR1405BLO - 5 kW	BAYHTR1408BLO - 8 kW	BAYHTR1410BLO BAYHTRDS1410BLO 10 kW	BAYHTRBK1415BLO 15 kW	BAYHTRBK1420BLO 20 kW
4FWCA024A1000Ⓞ / 4FWCF024A1000Ⓞ 4FWCA025A1000Ⓞ / 4FWCF025A1000Ⓞ	L / L	L / L	L / L	L / L	M / L							
4FWCA030A1000Ⓞ / 4FWCF030A1000Ⓞ 4FWCA031A1000Ⓞ / 4FWCF031A1000Ⓞ	L / L	L / L	L / L	L / L	L / L	L / L						
4FWCA036A1000Ⓞ / 4FWCF036A1000Ⓞ	L / L	L / L	L / L	L / L	L / L	M / L	M / L					
4FWCA048A1000Ⓞ / 4FWCF048A1000Ⓞ 4FWCA049A1000Ⓞ / 4FWCF049A1000Ⓞ								L / L	L / L	L / L	M / L	H / M
4FWCA060A1000Ⓞ / 4FWCF060A1000Ⓞ 4FWCA061A1000Ⓞ / 4FWCF061A1000Ⓞ								L / L	L / L	L / L	L / L	M / M
HEAT PUMP / COOLING												

MINIMUM HEATING AIRFLOW CFM - HEATER MATRIX												
4FWHA, 4FWHF AIR HANDLER	HEATER											
MODEL NUMBER	BAYHTR1403SLO BAYHTRDS1403SLO 3 kW	BAYHTR1405SLO BAYHTRDS1405SLO 5 kW	BAYHTR1406SLO BAYHTRDS1406SLO 6 kW	BAYHTR1408SLO BAYHTRDS1408SLO 8 kW	BAYHTR1410SLO BAYHTRDS1410SLO 10 kW	BAYHTRBK1415SLO 15 kW	BAYHTRBK1420SLO 20 kW	BAYHTR1405BLO - 5 kW	BAYHTR1408BLO - 8 kW	BAYHTR1410BLO BAYHTRDS1410BLO 10 kW	BAYHTRBK1415BLO 15 kW	BAYHTRBK1420BLO 20 kW
4FWHA024A1000Ⓞ / 4FWHF024A1000Ⓞ 4FWHA025A1000Ⓞ / 4FWHF025A1000Ⓞ	Tap 1 / Tap 1	Tap 1 / Tap 1	Tap 1 / Tap 1	Tap 2 / Tap 1	Tap 3 / Tap 2							
4FWHA030A1000Ⓞ / 4FWHF030A1000Ⓞ	Tap 1 / Tap 1	Tap 1 / Tap 1	Tap 1 / Tap 1	Tap 1 / Tap 1	Tap 2 / Tap 1	Tap 3 / Tap 2						
4FWHA036A1000Ⓞ / 4FWHF036A1000Ⓞ	Tap 1 / Tap 1	Tap 1 / Tap 1	Tap 1 / Tap 1	Tap 1 / Tap 1	Tap 2 / Tap 1	Tap 3 / Tap 2	Tap 3 / Tap 3					
4FWHA042A1000Ⓞ / 4FWHF042A1000Ⓞ								Tap 1 / Tap 1	Tap 1 / Tap 1	Tap 1 / Tap 1	Tap 2 / Tap 1	Tap 3 / Tap 2
4FWHA048A1000Ⓞ / 4FWHF048A1000Ⓞ								Tap 1 / Tap 1	Tap 1 / Tap 1	Tap 1 / Tap 1	Tap 1 / Tap 1	Tap 2 / Tap 1
4FWHA060A1000Ⓞ / 4FWHF060A1000Ⓞ 4FWHA061A1000Ⓞ / 4FWHF061A1000Ⓞ								Tap 1 / Tap 1	Tap 1 / Tap 1	Tap 1 / Tap 1	Tap 2 / Tap 1	Tap 3 / Tap 2
HEAT PUMP / COOLING												

*Field Supplied
Ⓞ 14th digit "A" models are phased out. 14th digit "B" models are shipped pressurized.

Split System Air Handlers Single Phase 1½-5 Tons

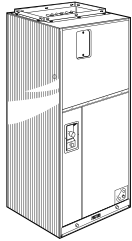

4TEH3F

Table AH-22-A — R-410A Standard Efficiency Fully Convertible (200-230/1/60)Ⓣ

Unit Model No.	Cooling Capacity (Btuh)	Dimensions (in.) H x W x D	Shipping Weight (lbs.)	Supply Opening ^{①②}	Return Opening ^①	Filter Sizes	Line Size Gas	Line Size Liquid
4TEC3F24B1000A ^⑤	24,000	43x21.5x21	121	18.22x11.02	19.5x18.07	20x20x1	5/8	5/16
4TEC3F36B1000A ^⑤	36,000	45x21.5x21	135	18.22x11.02	19.5x18.07	20x20x1	3/4	3/8
4TEC3F42C1000A ^⑥	42,000	51.8x23.5x21	165	20.22x11.02	21.5x18.07	20x20x1	3/4	3/8
4TEC3F48B1000A ^{④⑤}	48,000	57.9x23.5x21	188	20.22x11.02	21.5x18.07	20x20x1	7/8	3/8
4TEC3F60B1000A ^{④⑥}	60,000	57.9x23.5x21	193	20.22x11.02	21.5x18.07	20x22x1	7/8	3/8

- ① Actual opening does not include flange.
- ② Adjustable duct flange allows for a flush fit with 1½ inch insulation or ¾ inch or 1 inch insulation.
- ③ Two piece cabinet.
- ④ Two piece cabinet with Vortica™.
- ⑤ 3 fan speed.
- ⑥ 4 fan speed.
- ⑦ Metering Device = TXV-NB.

Split System Air Handlers Single Phase 1½-5 Tons

Table AH-22-B — Features

- 200/230 volt primary & 24 volt secondary transformer
- **Air-Tite™** cabinet meets or exceeds Florida's 2% leakage criteria
- Approved for modular or manufactured homes.....
- Compact 21" depth for easy installation.....
- Corrosion resistant galvanized metal with attractive finish
- Enhanced internally finned coil tubes
- External access to heater circuit boards.....
- Factory installed non-bleed TXV with mechanical fittings.....
- Full line 1-1/2 - 5 tons.....
- Insulated cabinet
- Low voltage wire nut connectors.....
- Multi-speed blower motor; five ton model with direct drive ECM motor
- Polarized plugs for making electrical connections from air handler control box to heaters
- Ships vertical - converts to horizontal by laying on side
- Six-way convertibility: horizontal (left & right); front & rear access; upflow, downflow
- Superior condensate performance.....
- Versatile duct flange - allows flush fit 3/4", 1" or 1.5" duct insulation.....
- **10-year warranty registered**
- **Optional extended warranties available**

4TEC3F
2-5

INSISTANT

See Heater Tables on Pages AH-20 and AH-21

Split System Air Handlers Single Phase 1½-5 Tons

Table AH-23-A — Optional Accessories

Model Number	Description	Shipping Weight	4TEC3F
AY28X079.....	Evaporator Defrost Control.....	1	✓
AY28X084.....	Evaporator Defrost Control.....	1	✓
BAY99X123①.....	Knockout Cover Plate②.....		✓
BAYSPEK140B.....	Single Power Entry Kit.....	5	✓
TAYBASE100.....	Downflow Subbase.....	16	3½-5
TAYBASE101.....	Downflow Subbase.....	16	2-3
TAYPLNM100.....	Pedestal Plenum Upflow.....	10	✓
BAYPLNM120.....	Pedestal Plenum Upflow.....		2-5
TASB215③.....	21.5" Cabinet Mounting Stand.....		2-3
TASB235③.....	23.5" Cabinet Mounting Stand.....		3½-5

- ① Minimum order 1 unit (1 unit = 50 pieces).
- ② Required if no electric heat is used.
- ③ Contact your distributor for information.

Comfort Controls — See Comfort Controls/Zone Sensors Section

Heaters for Split System and Convertible Air Handlers

Table AH-23-B — Heaters - 4 TEC

Heater Model Number	Capacity @ 240 Volts		Capacity @ 208 Volts		Voltage	Control Stages	Heater Amps per Circuit		Contains Circuit Breakers
	kW	BTUH	kW	BTUH			208 Volts	240 Volt	
BAYHTR1405000	4.80	16,400	3.6	12,300	208/240/1/60	1	17.3	20	No
BAYHTR1405BRKC	4.80	16,400	3.6	12,300	208/240/1/60	1	17.3	20	Yes
BAYHTR1405PDC	4.80	16,400	3.6	12,300	208/240/1/60	1	17.3	20	No
BAYHTR1408000	7.68	26,200	5.76	19,700	208/240/1/60	1	27.7	32	No
BAYHTR1408BRKC	7.68	26,200	5.76	19,700	208/240/1/60	1	27.7	32	Yes
BAYHTR1408PDC	7.68	26,200	5.76	19,700	208/240/1/60	1	27.7	32	No
BAYHTR1410000	9.60	32,800	7.20	24,600	208/240/1/60	1	34.6	40	No
BAYHTR1410BRKC	9.60	32,800	7.20	24,600	208/240/1/60	1	34.6	40	Yes
BAYHTR1410PDC	9.60	32,800	7.20	24,600	208/240/1/60	1	34.6	40	No
BAYHTR1415BRKC	15.36	52,400	11.53	39,300	208/240/1/60	2	34.6/20.8①②	40/24①	Yes
BAYHTR1419BRKC	19.20	65,500	14.42	44,200	208/240/1/60	2	27.8/41.6①②	32/48①	Yes
BAYHTR1425BRKC	24.96	85,200	18.73	63,900	208/240/1/60	3	38.1/34.6/17.3①	44/40/20①	Yes
Three Phase									
BAYHTR3410000	9.60	32,800	7.20	24,600	208/240/3/60	1	30	34.6	No
BAYHTR3415000	15.36	52,400	11.53	39,300	208/240/3/60	1	33	38.2	No

- ① Circuit 1/Circuit 2/Circuit 3*
- ② Heater can be converted to single circuit power entry by using BAYSPEK140B. This kit allows a single power circuit to be used with electric heaters that contain two (2) circuit breakers.

BAYSPEK140B to be used with BAYHTR1415BRKC,C/ BAYHTR1419BRKC,C only.

CAUTION: Any power supply and/or combination power supply, circuit or circuits must be wired and protected in accordance with local electrical codes.

*On model BAYHTR1425 only.

Heaters for Split System and Convertible Air Handlers

Table AH-24-A — Heaters Minimum Airflow

MINIMUM HEATING AIRFLOW CFM COOLING/HEAT PUMP AIR FLOW - HEATER MATRIX						
AIR HANDLER	HEATER MODEL NUMBER BAYHTR—					
MODEL NUMBER	1405 000 BRK PDC 4.80kW	1408 000 BRK PDC 7.68kW	1410 000 BRK PDC 3410 000 9.60kW	1415 BRK 15.36kW 3415 000	1419 BRK 19.20kW	1425 BRK 24.96kW
NUMBER OF HEATER RACKS	1	2	2	2	4	5
NUMBER OF CIRCUITS	1	1	1	2	2	3
4TEC3F24B	L/L	L/L	L/L	L/M	—	—
4TEC3F36B	L/L	L/L	L/L	L/H	L/H	—
4TEC3F42C	ML/ML	ML/ML	ML/ML	ML/PS	ML/H	—
4TEC3F48B	L/L	L/L	L/L	L/L	PS/PS	—
4TEC3F60B	ML/ML	ML/ML	ML/ML	ML/PS	ML/MH	—

(Example: L=Low, M=Medium, H=High Speed)

PS = Minimum speed tap varies based on air handler installation position.

000 = Pigtails, **BRK** = Contains circuit breakers,

PDC = Contains Pull Disconnect

Split System – Cased Heat Pump and Cooling Coils

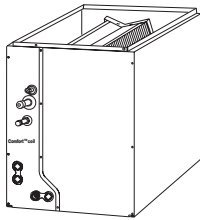

4TXC-CC Comfort™ Coil

Table COIL-1-A — Aluminum High Efficiency Staged System Cased Coil Convertible (Upflow/ Downflow/ Horizontal Left or Right) R-410A Refrigerant

Model Number	Nom. Cap. Cooling (Btuh)	Coil Type	Refrigerant Control	Outlet Dim. (in.) W/H x D	Overall Dim. (in.) H x W x D	Shipping Weight (lbs.)	Line Size OD Gas	Line Size OD Liq.
4TXCB003CC3HCB	24,000	A	TXVNB①	15 ⁵ / ₈ x 19 ³ / ₈	22.6 x 17.5 x 21.5	45	5/8	3/8
4TXCB004CC3HCB	36,000	A	TXVNB①	15 ⁵ / ₈ x 19 ³ / ₈	26.9 x 17.5 x 21.5	49	3/4	3/8
4TXCC005CC3HCB	36,000	A	TXVNB①	19 ¹ / ₈ x 19 ³ / ₈	26.9 x 21 x 21.5	51	3/4	3/8
4TXCC006CC3HCB	24,000	A	TXVNB①	19 ¹ / ₈ x 19 ³ / ₈	22.6 x 21 x 21.5	48	5/8	3/8
4TXCC007CC3HCB	36,000	A	TXVNB①	19 ¹ / ₈ x 19 ³ / ₈	26.9 x 21 x 21.5	51	3/4	3/8
4TXCC008CC3HCB	60,000	A	TXVNB①	19 ¹ / ₈ x 19 ³ / ₈	30.1 x 21 x 21.5	65	3/4	3/8
4TXCD009CC3HCB	60,000	A	TXVNB①	22 ⁵ / ₈ x 19 ³ / ₈	30.1 x 24.6 x 21.5	68	3/4	3/8
4TXCD010CC3HCB	60,000	A	TXVNB①	22 ⁵ / ₈ x 19 ³ / ₈	30.1 x 24.6 x 21.5	68	3/4	3/8

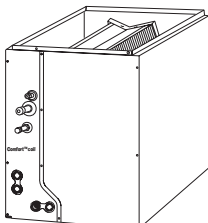

4TXC-BC Comfort™ Coil

Table COIL-1-B — Aluminum Cased Coil Convertible (Upflow/ Downflow/ Horizontal Left or Right) R-410A Refrigerant

Model Number	Nom. Cap. Cooling (Btuh)	Coil Type	Refrigerant Control	Outlet Dim. (in.) W/H x D	Overall Dim. (in.) H x W x D	Shipping Weight (lbs.)	Line Size OD Gas	Line Size OD Liq.
4TXCA018BC3HCB	18,000	A	TXVNB①	12 ⁵ / ₈ x 19 ³ / ₈	22.6 x 14.5 x 21.5	34	5/8	5/16
4TXCA024BC3HCB	24,000	A	TXVNB①	12 ⁵ / ₈ x 19 ³ / ₈	22.6 x 14.5 x 21.5	34	5/8	5/16
4TXCB025BC3HCB	24,000	A	TXVNB①	15 ⁵ / ₈ x 19 ³ / ₈	17.6 x 17.5 x 21.5	38	5/8	5/16
4TXCB031BC3HCB	30,000	A	TXVNB①	15 ⁵ / ₈ x 19 ³ / ₈	17.6 x 17.5 x 21.5	38	5/8	5/16
4TXCB032BC3HCB	36,000	A	TXVNB①	15 ⁵ / ₈ x 19 ³ / ₈	22.6 x 17.5 x 21.5	45	3/4	3/8
4TXCB036BC3HCB	36,000	A	TXVNB①	15 ⁵ / ₈ x 19 ³ / ₈	22.6 x 17.5 x 21.5	45	3/4	3/8
4TXCC037BC3HCB	37,000	A	TXVNB①	19 ¹ / ₈ x 19 ³ / ₈	22.6 x 21 x 21.5	48	3/4	3/8
4TXCB042BC3HCB	42,000	A	TXVNB①	15 ⁵ / ₈ x 19 ³ / ₈	22.6 x 17.5 x 21.5	45	3/4	3/8
4TXCC043BC3HCB	43,000	A	TXVNB①	19 ¹ / ₈ x 19 ³ / ₈	22.6 x 21 x 21.5	48	3/4	3/8
4TXCC044BC3HCB	48,000	A	TXVNB①	19 ¹ / ₈ x 19 ³ / ₈	26.9 x 21 x 21.5	49	7/8	3/8
4TXCB048BC3HCB	48,000	A	TXVNB①	15 ⁵ / ₈ x 19 ³ / ₈	26.9 x 17.5 x 21.5	49	7/8	3/8
4TXCC049BC3HCB	48,000	A	TXVNB①	19 ¹ / ₈ x 19 ³ / ₈	26.9 x 21 x 21.5	51	7/8	3/8
4TXCD050BC3HCB	48,000	A	TXVNB①	22 ⁵ / ₈ x 19 ³ / ₈	26.9 x 24.6 x 21.5	55	7/8	3/8
4TXCC060BC3HCB	60,000	A	TXVNB①	19 ¹ / ₈ x 19 ³ / ₈	30.1 x 21 x 21.5	65	7/8	3/8
4TXCD061BC3HCB	60,000	A	TXVNB①	22 ⁵ / ₈ x 19 ³ / ₈	30.1 x 24.6 x 21.5	68	7/8	3/8
4TXCD063BC3HCB	60,000	A	TXVNB①	22 ⁵ / ₈ x 19 ³ / ₈	30.1 x 24.6 x 21.5	68	7/8	3/8
4TXCD064BC3HCB	60,000	A	TXVNB①	22 ⁵ / ₈ x 19 ³ / ₈	30.1 x 24.6 x 21.5	68	7/8	3/8

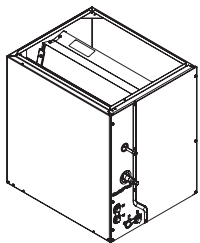

4NXC-AS Comfort™ Coil

Table COIL-1-C — Aluminum High Efficiency Staged System Cased Coil Convertible (Downflow/ Horizontal-Right Only) R-410A Refrigerant

Model Number	Nom. Cap. Cooling (Btuh)	Coil Type	Refrigerant Control	Outlet Dim. (in.) W/H x D	Overall Dim. (in.) H x W x D	Shipping Weight (lbs.)	Line Size OD Gas	Line Size OD Liq.
4NXC003AS3HRA	18,000	A	TXVNB①	15 ³ / ₄ x 19 ¹¹ / ₃₂	22.5 x 17.5 x 21.5	54	3/4	3/8
4NXC004AS3HRA	24,000	A	TXVNB①	15 ³ / ₄ x 19 ¹¹ / ₃₂	26.8 x 17.5 x 21.5	63	3/4	3/8
4NXCC005AS3HRA	36,000	A	TXVNB①	19 ¹ / ₄ x 19 ¹¹ / ₃₂	26.8 x 21.0 x 21.5	68	3/4	3/8
4NXCC008AS3HRA	48,000	A	TXVNB①	19 ¹ / ₄ x 19 ¹¹ / ₃₂	30.0 x 21.0 x 21.5	72	3/4	3/8
4NXCD009AS3HRA	60,000	A	TXVNB①	22 ³ / ₄ x 19 ³ / ₈	30.0 x 24.5 x 21.5	82	7/8	3/8

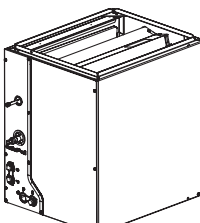

4NXC-AC Comfort™ Coil

Table COIL-1-C — Aluminum Cased Coil Convertible (Upflow/ Downflow/ Horizontal Left or Right) R-410A Refrigerant

Model Number	Nom. Cap. Cooling (Btuh)	Coil Type	Refrigerant Control	Outlet Dim. (in.) W/H x D	Overall Dim. (in.) H x W x D	Shipping Weight (lbs.)	Line Size OD Gas	Line Size OD Liq.
4NXCA018AC3HCA	18,000	A	TXVNB①	12 ⁵ / ₈ x 19 ³ / ₈	17.6 x 14.5 x 21.5	34	3/4	3/8
4NXCA024AC3HCA	24,000	A	TXVNB①	12 ⁵ / ₈ x 19 ³ / ₈	17.6 x 14.5 x 21.5	34	3/4	3/8
4NXC025AC3HCA	24,000	A	TXVNB①	15 ⁵ / ₈ x 19 ³ / ₈	18.4 x 17.5 x 21.5	38	3/4	3/8
4NXC031AC3HCA	30,000	A	TXVNB①	15 ⁵ / ₈ x 19 ³ / ₈	18.4 x 17.5 x 21.5	38	3/4	3/8
4NXC032AC3HCA	30,000	A	TXVNB①	15 ⁵ / ₈ x 19 ³ / ₈	22.6 x 17.5 x 21.5	45	3/4	3/8
4NXC036AC3HCA	36,000	A	TXVNB①	15 ⁵ / ₈ x 19 ³ / ₈	22.6 x 17.5 x 21.5	45	3/4	3/8
4NXCD063BC3HCA	60,000	A	TXVNB①	22 ⁵ / ₈ x 19 ³ / ₈	30.1 x 24.6 x 21.5	68	7/8	3/8

① Start Kit may be required on outdoor unit.

For complete equipment / combination selections, installation instructions and warranty information, please refer to Product Data/Ratings and/or Installers Guides and Limited Warranty Handbooks.

Split System – Uncased Heat Pump and Cooling Coils

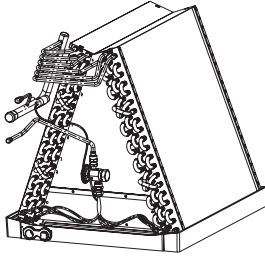

**4TXA-BC
Comfort™ Coil**

Table COIL-2-A — Aluminum Uncased Coil (Upflow/Downflow) R-410A Refrigerant

Model Number	Nom. Cap. Cooling (Btuh)	Coil Type	Refrigerant Control	Overall Dim. (in.) H x W x D	Shipping Weight (lbs.)	Line Size OD Gas	OD Liq.
4TXAA018BC3HUB	18,000	A	TXVNB ^①	17.4 x 13.3 x 21.1	21	5/8	5/16
4TXAA024BC3HUB	24,000	A	TXVNB ^①	17.4 x 13.3 x 21.1	21	5/8	5/16
4TXAB025BC3HUB	24,000	A	TXVNB ^①	15.9 x 16.3 x 21.1	24	5/8	5/16
4TXAB031BC3HUB	30,000	A	TXVNB ^①	15.9 x 16.3 x 21.1	24	5/8	5/16
4TXAB032BC3HUB	36,000	A	TXVNB ^①	21.2 x 16.3 x 21.1	32	3/4	3/8
4TXAB036BC3HUB	36,000	A	TXVNB ^①	21.2 x 16.3 x 21.1	32	3/4	3/8
4TXAC037BC3HUB	36,000	A	TXVNB ^①	20.8 x 19.8 x 21.1	33	3/4	3/8
4TXAB042BC3HUB	42,000	A	TXVNB ^①	21.2 x 16.3 x 21.1	32	3/4	3/8
4TXAC043BC3HUB	42,000	A	TXVNB ^①	20.8 x 19.8 x 21.1	33	3/4	3/8
4TXAC044BC3HUB	48,000	A	TXVNB ^①	25.3 x 19.8 x 21.1	38	7/8	3/8
4TXAB048BC3HUB	48,000	A	TXVNB ^①	25.3 x 16.3 x 21.1	36	7/8	3/8
4TXAC049BC3HUB	48,000	A	TXVNB ^①	24.9 x 19.8 x 21.1	38	7/8	3/8
4TXAD050BC3HUB	48,000	A	TXVNB ^①	24.4 x 23.3 x 21.1	39	7/8	3/8
4TXAC060BC3HUB	60,000	A	TXVNB ^①	29.1 x 19.8 x 21.1	44	7/8	3/8
4TXAD061BC3HUB	60,000	A	TXVNB ^①	28.6 x 23.3 x 21.1	45	7/8	3/8
4TXAD064BC3HUB	60,000	A	TXVNB ^①	28.6 x 23.3 x 21.1	45	7/8	3/8

Table COIL-2-B — 13 SEER Split System - Uncased Coil Enclosures

Model Number	Coils	Used With Furnaces Flush on Both Sides	Dimensions (in.) H x W x D	Shipping Weight (lbs.)
BAYCLE14A1422A	4TXAA018BC 4TXAA024BC	14½" Wide Furnace	22½ x 14½ x 21½	12
BAYCLE17A1722A	4TXAB025AS 4TXAB031AS 4TXAB036AS 4TXAB025BC 4TXAB031BC 4TXAB032BC 4TXAB036BC 4TXAB042BC 4TXAB048BC	17½" Wide Furnace	22 ⁵ / ₈ x 17½ x 21½	14
BAYCLE21A2130A	4TXAC037AS 4TXAC054AS 4TXAC037BC 4TXAC043BC 4TXAC044BC 4TXAC049BC 4TXAC060BC	21" Wide Furnace	30 x 21 x 21½	18
BAYCLE24A2430A	4TXAD065AS 4TXAD050BC 4TXAD061BC 4TXAD064BC	24½" Wide Furnace	30 x 24½ x 21½	22

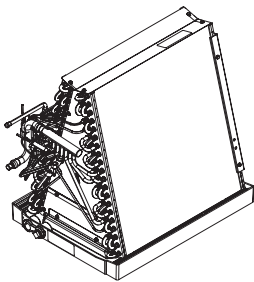

4NXA-AC

Table COIL-2-C — Aluminum Uncased Coil (Upflow/Downflow) R-410A Refrigerant

Model Number	Nom. Cap. Cooling (Btuh)	Coil Type	Refrigerant Control	Overall Dim. (in.) H x W x D	Shipping Weight (lbs.)	Line Size OD Gas	OD Liq.
4NXAA018AC3HUA	18,000	A	TXVNB ^①	15.2 x 13.3 x 21.1	21	3/4	3/8
4NXAA024AC3HUA	24,000	A	TXVNB ^①	15.2 x 13.3 x 21.1	21	3/4	3/8
4NXAB025AC3HUA	24,000	A	TXVNB ^①	16.9 x 16.3 x 21.1	24	3/4	3/8
4NXAB031AC3HUA	30,000	A	TXVNB ^①	16.9 x 16.3 x 21.1	24	3/4	3/8
4NXAB032AC3HUA	30,000	A	TXVNB ^①	21.0 x 16.3 x 21.1	32	3/4	3/8
4NXAB036AC3HUA	36,000	A	TXVNB ^①	21.0 x 23.3 x 21.1	32	3/4	3/8

^① Start Kit may be required on outdoor unit.

Split System – Cased Heat Pump and Cooling Coils

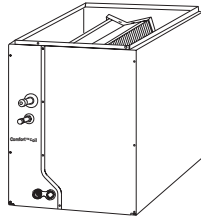

4CXC-CC
Comfort™ Coil

Table COIL-3-A — Aluminum Cooling ONLY Cased Coils- Upflow R-410A Refrigerant

Model Number	Nom. Cap. Cooling (Btuh)	Coil Type	Refrigerant Control	Outlet Dim. (in.) H x D	Overall Dim. (in.) H x W x D	Shipping Weight (lbs.)	Line Size	
							OD Gas	OD Liq.
4CXCA024CC3CUB	24,000	A	TXVNB①	12 ⁵ / ₈ x 19 ³ / ₈	22.6x14.5x21.5	33	5/8	3/8
4XCXB025CC3CUB	24,000	A	TXVNB①	15 ⁵ / ₈ x 19 ³ / ₈	17.6x17.5x21.5	43	3/4	3/8
4XCXB031CC3CUB	30,000	A	TXVNB①	15 ⁵ / ₈ x 19 ³ / ₈	17.6x17.5x21.5	43	3/4	3/8
4XCXB036CC3CUB	36,000	A	TXVNB①	15 ⁵ / ₈ x 19 ³ / ₈	22.6x17.5x21.5	45	3/4	3/8
4XCXC037CC3CUB	37,000	A	TXVNB①	19 ¹ / ₈ x 19 ³ / ₈	22.6x21x21.5	48	3/4	3/8
4XCXB042CC3CUB	42,000	A	TXVNB①	15 ⁵ / ₈ x 19 ³ / ₈	22.6x17.5x21.5	45	3/4	3/8
4XCXC043CC3CUB	43,000	A	TXVNB①	19 ¹ / ₈ x 19 ³ / ₈	22.6x21x21.5	48	3/4	3/8
4XCXC049CC3CUB	48,000	A	TXVNB①	19 ¹ / ₈ x 19 ³ / ₈	26.9x21x21.5	52	7/8	3/8
4CXCD061CC3CUB	60,000	A	TXVNB①	22 ⁵ / ₈ x 19 ³ / ₈	30.1x24.5x21.5	67	7/8	3/8

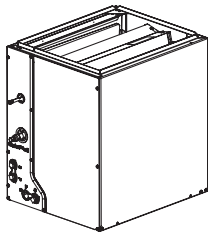

4CXC-DC
Comfort™ Coil

Table COIL-3-B — Aluminum Cooling ONLY Cased Coils- Upflow R-410A Refrigerant

Model Number	Nom. Cap. Cooling (Btuh)	Coil Type	Refrigerant Control	Outlet Dim. (in.) W/H x D	Overall Dim. (in.) H x W x D	Shipping Weight (lbs.)	Line Size	
							OD Gas	OD Liq.
4CXCA018DC3CAA	18,000	A	TXVNB①	12 ⁵ / ₈ x 19 ³ / ₈	17.6 x 14.5 x 21.5	34	3/4	3/8
4CXCA024DC3CAA	24,000	A	TXVNB①	12 ⁵ / ₈ x 19 ³ / ₈	17.6 x 14.5 x 21.5	34	3/4	3/8
4XCXB025DC3CAA	24,000	A	TXVNB①	15 ⁵ / ₈ x 19 ³ / ₈	18.4 x 17.5 x 21.5	38	3/4	3/8
4XCXB031DC3CAA	30,000	A	TXVNB①	15 ⁵ / ₈ x 19 ³ / ₈	18.4 x 17.5 x 21.5	38	3/4	3/8
4XCXB032DC3CAA	30,000	A	TXVNB①	15 ⁵ / ₈ x 19 ³ / ₈	22.6 x 17.5 x 21.5	45	3/4	3/8
4XCXB036DC3CAA	36,000	A	TXVNB①	15 ⁵ / ₈ x 19 ³ / ₈	22.6 x 17.5 x 21.5	45	3/4	3/8

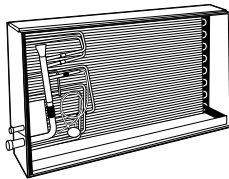

4TXF

Table COIL-3-C — Aluminum Cased Horizontal Flat Coils R-410A Refrigerant

Model Number	Nom. Cap. Cooling (Btuh)	Coil Type	Refrigerant Control	Outlet Dim. (in.) H x D	Overall Dim. (in.) H x W x D	Shipping Weight (lbs.)	Line Size	
							OD Gas	OD Liq.
4TXFH024CZ3HHB	24,000	Flat	TXVNB①	21 x 33 ¹ / ₄	22.7 x 10.2 x 37.5	48	5/8	3/8
4TXFH033CC3HHB	34,000	Flat	TXVNB①	21 x 24	22.7 x 10.2 x 28.2	49	3/4	5/16
4TXFH036CZ3HHB	36,000	Flat	TXVNB①	21 x 33 ¹ / ₄	22.7 x 10.2 x 37.5	53	3/4	3/8
4TXFH041CC3HHB	44,000	Flat	TXVNB①	21 x 33 ¹ / ₄	22.7 x 10.2 x 37.5	57	3/4	3/8
4TXFH054CC3HHB	58,000	Flat	TXVNB①	21 x 33 ¹ / ₄	22.7 x 10.2 x 37.5	55	7/8	3/8
4TXFH063CZ3HHB	61,000	Flat	TXVNB①	27 x 33 ¹ / ₄	28.7 x 10.2 x 37.5	63	7/8	3/8

Important: This table applies to all outdoor units except the 4TTZ0 or 4TWZ0.

Table COIL-3-D — Aluminum Cased Horizontal Flat Coils R-410A Refrigerant

Model Number	Nom. Cap. Cooling (Btuh)	Coil Type	Refrigerant Control	Outlet Dim. (in.) H x D	Overall Dim. (in.) H x W x D	Shipping Weight (lbs.)	Line Size	
							OD Gas	OD Liq.
4TXFH024CZ3HHB	24,000	Flat	TXVNB①	21 x 33 ¹ / ₄	22.7 x 10.2 x 37.5	48	5/8	3/8
4TXFH036CZ3HHB	36,000	Flat	TXVNB①	21 x 33 ¹ / ₄	22.7 x 10.2 x 37.5	53	3/4	3/8
4TXFH063CZ3HHB	61,000	Flat	TXVNB①	27 x 33 ¹ / ₄	28.7 x 10.2 x 37.5	63	7/8	3/8

Important: Only these Flat Coils may be used with the 4TTZ0 or 4TWZ0 outdoor units.

① Start Kit may be required on outdoor unit.

Split System – Cased/Uncased Heat Pump and Cooling Coils

Table COIL-4-A — Features

	4TXC-CC	4TXC-BC	4TXA-BC	4CXC-CC	4TXF
• All aluminum coil	✓	✓	✓	✓	✓
• 100% foil lined insulation.....	✓	✓	—	✓	✓
• Internally checked non-bleed* thermal expansion valve with mechanical fittings (heat pump operation)	✓	✓	✓	—	✓
• Non-Bleed* thermal expansion valve with mechanical fittings (cooling only operation)	—	—	—	✓	—
• Easy case attachment to furnace.....	✓	✓	—	✓	—
• Upflow only application	—	—	—	✓	—
• Upflow/Downflow application	—	—	✓	—	—
• 4 way application - Upflow/Downflow/Horizontal (left/right)	✓	✓	—	—	—
• Horizontal application with Bi-Direction airflow	—	—	—	—	✓
• Suction pressure service port	✓	✓	✓	✓	✓
• Double sloped non-corrosive drain pan - UL rated 400°F.....	✓	✓	✓	✓	—
• Sloped non-corrosive drain pan	—	—	—	—	✓
• Optimized for high efficiency with staged systems	✓	—	—	—	—
• Split inner and outer doors for easy coil inspection and cleaning.....	✓	✓	—	✓	—
• Painted galvanized steel cabinet to match furnace.....	✓	✓	—	✓	—
• Unpainted galvanized steel cabinet	—	—	—	—	✓
• 10-year registered limited warranty on coil, & all other functional parts (Residential Use)**	✓	✓	✓	✓	✓

*Start kit may be required on outdoor unit.

**Registered limited warranty terms are available when you register within 60 days of installation. You can register online at trane.com or by phone at 800-544-6413; otherwise, Trane Base Limited Warranty terms will apply. Base Limited Warranty information on specific products can be found on ComfortSite.com.

Table COIL-4-B — Features - Enhanced Fin Models

	4NXC-AS	4NXC-AC	4NXA-AC	4CXC-DC
• All aluminum coil	✓	✓	✓	✓
• Enhanced Fin Surface.....	✓	✓	✓	✓
• 100% foil lined insulation.....	✓	✓	—	✓
• Internally checked non-bleed* thermal expansion valve with mechanical fitting on distributor side, brazed on liquid side (heat pump operation)	✓	✓	✓	—
• Non-Bleed* thermal expansion valve with mechanical fitting on distributor side, brazed on liquid side (cooling only operation).....	—	—	—	✓
• Easy case attachment to furnace.....	✓	✓	—	✓
• Upflow only application	—	—	—	✓
• Downflow/Horizontal Right only application	✓	—	—	—
• Upflow/Downflow application	—	—	✓	—
• 4 way application - Upflow/Downflow/Horizontal (left/right)	—	✓	—	—
• Suction pressure service port	✓	✓	✓	✓
• Double sloped non-corrosive drain pan - UL rated 400°F.....	✓	✓	✓	✓
• Optimized for high efficiency with staged systems	✓	—	—	—
• Split inner and outer doors for easy coil inspection and cleaning.....	✓	✓	—	✓
• Painted galvanized steel cabinet to match furnace.....	✓	✓	—	✓
• 10-year registered limited warranty on coil, & all other functional parts (Residential Use)**	✓	✓	✓	✓

*Start kit may be required on outdoor unit.

**Registered limited warranty terms are available when you register within 60 days of installation. You can register online at trane.com or by phone at 800-544-6413; otherwise, Trane Base Limited Warranty terms will apply. Base Limited Warranty information on specific products can be found on ComfortSite.com.

Silver Series Cased & Uncased Cooling Only Coils

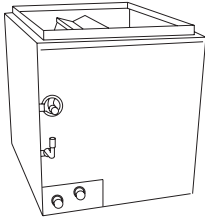

4FXC

Table COIL-5-A — 4FXC Cooling Only Cased Coils - Upflow/Downflow R-410A Refrigerant

Model Number	Nom. Cap. Cooling (Btuh)	Coil Type	Refrigerant Control	Outlet Dim. (in.) W/H x D	Overall Dim. (in.) H x W x D	Shipping Weight (lbs.)	Line Size OD Gas	Line Size OD Liq.
4FXCA024AC3CAB	24,000	A	TXVNB①	12 ³ / ₄ x 19 ³ / ₄	19 x 14.5 x 21.5	37	³ / ₄	³ / ₈
4FXCB024AC3CAB	24,000	A	TXVNB①	15 ³ / ₄ x 19 ³ / ₄	19 x 17.5 x 21.5	39	³ / ₄	³ / ₈
4FXCC024AC3CAB	24,000	A	TXVNB①	19 ¹ / ₄ x 19 ³ / ₄	19 x 21 x 21.5	41	³ / ₄	³ / ₈
4FXCB036AC3CAB	36,000	A	TXVNB①	15 ³ / ₄ x 19 ³ / ₄	22.63 x 17.5 x 21.5	47	³ / ₄	³ / ₈
4FXCC036AC3CAB	36,000	A	TXVNB①	19 ¹ / ₄ x 19 ³ / ₄	22.63 x 21 x 21.5	50	³ / ₄	³ / ₈
4FXCD036AC3CAB	36,000	A	TXVNB①	22 ³ / ₄ x 19 ³ / ₄	22.63 x 24.5 x 21.5	52	³ / ₄	³ / ₈
4FXCB042AC3CAB	42,000	A	TXVNB①	15 ³ / ₄ x 19 ³ / ₄	22.63 x 17.5 x 21.5	47	⁷ / ₈	³ / ₈
4FXCC042AC3CAB	42,000	A	TXVNB①	19 ¹ / ₄ x 19 ³ / ₄	22.63 x 21 x 21.5	50	⁷ / ₈	³ / ₈
4FXCD042AC3CAB	42,000	A	TXVNB①	22 ³ / ₄ x 19 ³ / ₄	22.63 x 24.5 x 21.5	52	⁷ / ₈	³ / ₈
4FXCB048AC3CAB	48,000	M	TXVNB①	15 ³ / ₄ x 19 ³ / ₄	22.63 x 17.5 x 21.5	48	⁷ / ₈	³ / ₈
4FXCC048AC3CAB	48,000	M	TXVNB①	19 ¹ / ₄ x 19 ³ / ₄	22.63 x 21 x 21.5	50	⁷ / ₈	³ / ₈
4FXCD048AC3CAB	48,000	M	TXVNB①	22 ³ / ₄ x 19 ³ / ₄	22.63 x 24.5 x 21.5	52	⁷ / ₈	³ / ₈
4FXCB060AC3CAB	60,000	M	TXVNB①	15 ³ / ₄ x 19 ³ / ₄	28.75 x 17.5 x 21.5	58	⁷ / ₈	³ / ₈
4FXCC060AC3CAB	60,000	M	TXVNB①	19 ¹ / ₄ x 19 ³ / ₄	28.75 x 21 x 21.5	58	⁷ / ₈	³ / ₈
4FXCD060AC3CAB	60,000	M	TXVNB①	22 ³ / ₄ x 19 ³ / ₄	28.75 x 24.5 x 21.5	62	⁷ / ₈	³ / ₈
4FXCB061AC3CAB	60,000	M	TXVNB①	15 ³ / ₄ x 19 ³ / ₄	25 x 17.5 x 21.5	51	⁷ / ₈	³ / ₈
4FXCC061AC3CAB	60,000	M	TXVNB①	19 ¹ / ₄ x 19 ³ / ₄	25 x 21 x 21.5	51	⁷ / ₈	³ / ₈
4FXCD061AC3CAB	60,000	M	TXVNB①	22 ³ / ₄ x 19 ³ / ₄	25 x 24.5 x 21.5	55	⁷ / ₈	³ / ₈

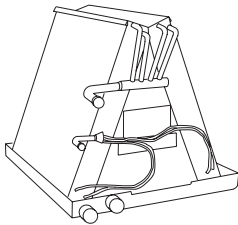

4FXA

Table COIL-5-B — 4FXA Cooling Only Uncased Coils - Upflow/Downflow R-410A Refrigerant

Model Number	Nom. Cap. Cooling (Btuh)	Coil Type	Refrigerant Control	Overall Dim. (in.) H x W x D	Shipping Weight (lbs.)	Line Size OD Gas	Line Size OD Liq.
4FXAA024AC3CAB	24,000	A	TXVNB①	17.5 x 13 x 19.5	17	³ / ₄	³ / ₈
4FXAB024AC3CAB	24,000	A	TXVNB①	17.5 x 17 x 19.5	19	³ / ₄	³ / ₈
4FXAC024AC3CAB	24,000	A	TXVNB①	17.5 x 20 x 19.5	21	³ / ₄	³ / ₈
4FXAN036AC3CAB	36,000	A	TXVNB①	21.5 x 15 x 19.5	28	³ / ₄	³ / ₈
4FXAB036AC3CAB	36,000	A	TXVNB①	21.5 x 17 x 19.5	28	³ / ₄	³ / ₈
4FXAC036AC3CAB	36,000	A	TXVNB①	21.5 x 20 x 19.5	30	³ / ₄	³ / ₈
4FXAD036AC3CAB	36,000	A	TXVNB①	21.5 x 24 x 19.5	32	³ / ₄	³ / ₈
4FXAN042AC3CAB	42,000	A	TXVNB①	21.5 x 15 x 19.5	28	³ / ₄	³ / ₈
4FXAB042AC3CAB	42,000	A	TXVNB①	21.5 x 17 x 19.5	28	⁷ / ₈	³ / ₈
4FXAC042AC3CAB	42,000	A	TXVNB①	21.5 x 20 x 19.5	30	⁷ / ₈	³ / ₈
4FXAD042AC3CAB	42,000	A	TXVNB①	21.5 x 24 x 19.5	32	⁷ / ₈	³ / ₈
4FXAB048AC3CAB	48,000	M	TXVNB①	19.5 x 17 x 19.5	28	⁷ / ₈	³ / ₈
4FXAC048AC3CAB	48,000	M	TXVNB①	19.5 x 20 x 19.5	30	⁷ / ₈	³ / ₈
4FXAD048AC3CAB	48,000	M	TXVNB①	19.5 x 24 x 19.5	32	⁷ / ₈	³ / ₈
4FXAB060AC3CAB	60,000	M	TXVNB①	25.5 x 17 x 19.5	38	⁷ / ₈	³ / ₈
4FXAC060AC3CAB	60,000	M	TXVNB①	25.5 x 20 x 19.5	40	⁷ / ₈	³ / ₈
4FXAD060AC3CAB	60,000	M	TXVNB①	25.5 x 24 x 19.5	42	⁷ / ₈	³ / ₈
4FXAB061AC3CAB	60,000	M	TXVNB①	21.5 x 17 x 19.5	31	⁷ / ₈	³ / ₈
4FXAC061AC3CAB	60,000	M	TXVNB①	21.5 x 20 x 19.5	33	⁷ / ₈	³ / ₈
4FXAD061AC3CAB	60,000	M	TXVNB①	21.5 x 24 x 19.5	35	⁷ / ₈	³ / ₈

① Start Kit may be required on outdoor unit.

Silver Series Flat & Horizontal Cooling Only Coils

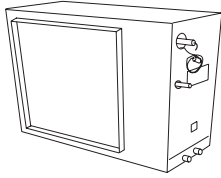

4FXFH

Table COIL-6-A — 4FXFH Cooling Only Flat Coils R-410A Refrigerant

Model Number	Nom. Cap. Cooling (Btuh)	Coil Type	Refrigerant Control	Outlet Dim. (in.) W/H x D	Overall Dim. (in.) H x W x D	Shipping Weight (lbs.)	Line Size OD Gas	Line Size OD Liq.
4FXFH024AC3CHB	30,000	Flat	TXVNB①	16 x 21	24.5 x 24.5 x 10	27	3/4	3/8
4FXFH036AC3CHB	36,000	Flat	TXVNB①	30 x 21	24.5 x 36 x 10	33	3/4	3/8
4FXFH048AC3CHB	48,000	Flat	TXVNB①	30 x 21	24.5 x 36 x 10	40	7/8	3/8
4FXFH060AC3CHB	60,000	Flat	TXVNB①	30 x 21	24.5 x 36 x 10	40	7/8	3/8
4FXFH063AC3CHB	63,000	Flat	TXVNB①	34 x 21	24.5 x 37 x 10	45	7/8	3/8

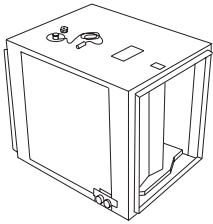

4FXCH

Table COIL-6-B — 4FXCH Cooling Only Horizontal Coils R-410A Refrigerant

Model Number	Nom. Cap. Cooling (Btuh)	Coil Type	Refrigerant Control	Outlet Dim. (in.) W/H x D	Overall Dim. (in.) H x W x D	Shipping Weight (lbs.)	Line Size OD Gas	Line Size OD Liq.
4FXCH024AC3CHB	30,000	A	TXVNB①	16.5 x 18.5	18.25 x 25 x 20.25	42	3/4	3/8
4FXCH036AC3CHB	36,000	A	TXVNB①	16.5 x 18.5	18.25 x 34.75 x 20.25	49	3/4	3/8
4FXCH048AC3CHB	48,000	A	TXVNB①	20.5 x 18.5	20.25 x 34.75 x 20.25	52	7/8	3/8
4FXCH060AC3CHB	60,000	A	TXVNB①	20.5 x 18.5	20.25 x 34.75 x 20.25	55	7/8	3/8

① Start Kit may be required on outdoor unit.

Platinum ZV, Gold ZM, Gold XM, Silver ZI, Gold XI, and Silver SI Convertible Gas Furnaces Airflow Directions

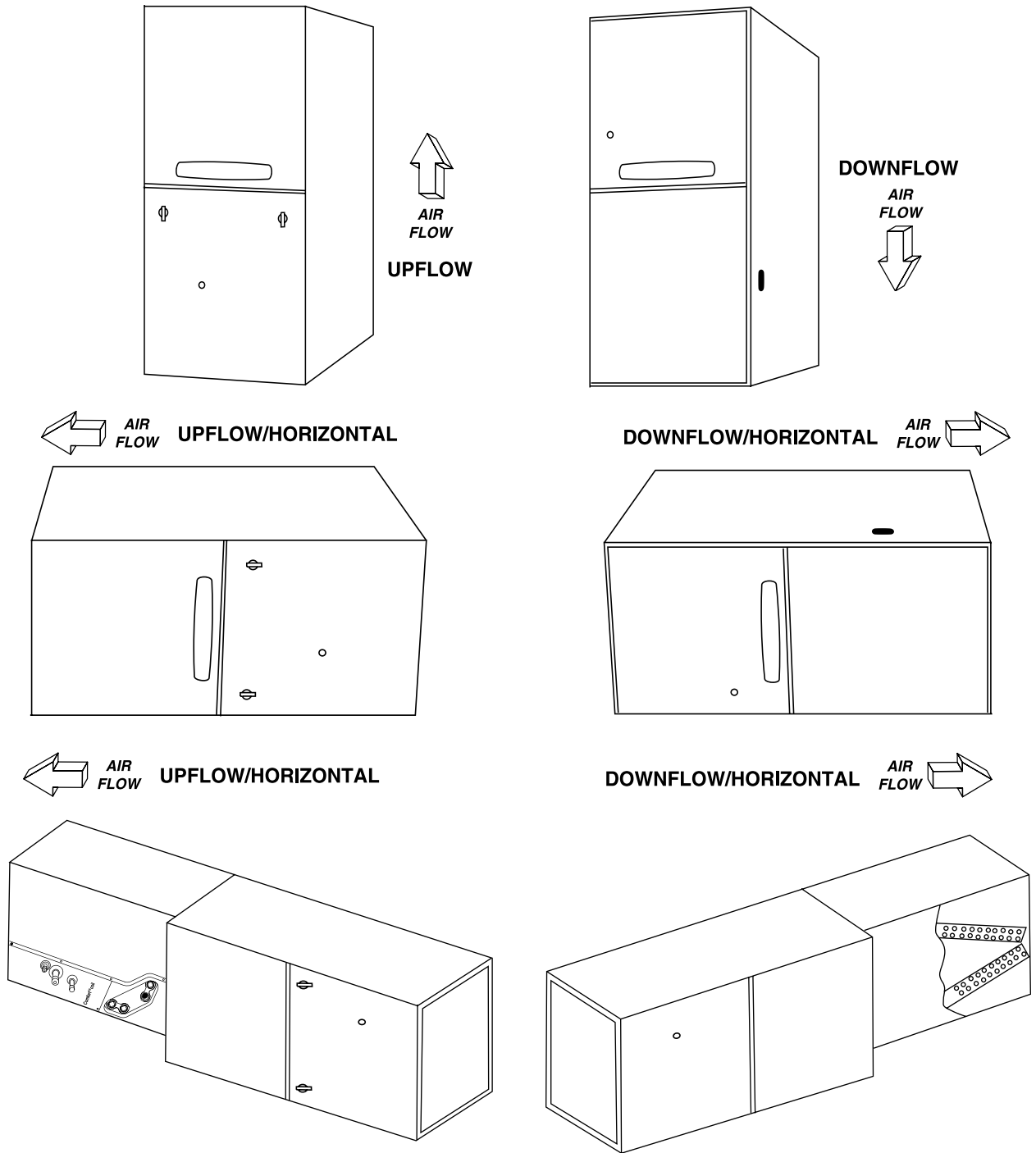

Furnaces

Note: The forty inch (40") height condensing downflow/horizontal and upflow/horizontal furnaces may only be rotated onto their left side. Connection brackets for coil/furnace alignment are included with the furnaces. The apex of the coil may point into or away from the airflow.

Platinum ZV – Modulating, Communicating ECM Variable Speed

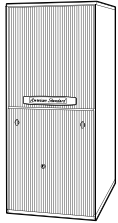

**Platinum ZV
Direct/Non-Direct
Vent**

**Table FUR-2-A — Variable Speed, Communicating, Modulating Direct/Non-Direct Vent, Upflow/Horizontal Left
Condensing Gas Furnace (115/1/60)^{④⑤⑦}**

Unit Model No.	Airflow In Tons	Output (Btuh)		ICS ^① AFUE	Flue Size (in)	Ignition Device	Uncrated Dimensions (in.) H x W x D	Shipping Weight (lbs.)	Max Fuse*	Filter Sizes
		Stage 3 High Stage/100%	Stage 1 Low Stage/40% ^③							
AUHMB060ACV3VB	3	58,380	23,352	97.3 ^②	2, 2 1/2, 3	⑥	40 x 17 1/2 x 28	158	15	17 x 25 x 1
AUHMB080ACV3VB	3	77,360	30,944	96.7 ^②	2, 2 1/2, 3	⑥	40 x 17 1/2 x 28	168	15	17 x 25 x 1
AUHMC100ACV4VB	4	96,000	38,400	96.0	2 1/2, 3	⑥	40 x 21 x 28	197	15	20 x 25 x 1
AUHMD120ACV5VB	5	116,400	52,380	97.0 ^②	3	⑥	40 x 24 1/2 x 28	206	15	24 x 25 x 1

Note: Variable speed furnaces should not be twinned and are not approved for twinning applications.

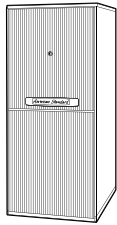

**Platinum ZV
Direct/Non-Direct
Vent**

**Table FUR-2-B — Variable Speed, Communicating, Modulating Direct/Non-Direct Vent, Downflow/Horizontal
Right Condensing Gas Furnace (115/1/60)^{④⑤⑦}**

Unit Model No.	Airflow In Tons	Output (Btuh)		ICS ^① AFUE	Flue Size (in)	Ignition Device	Uncrated Dimensions (in.) H x W x D	Shipping Weight (lbs.)	Max Fuse*	Filter Sizes
		Stage 3 High Stage/100%	Stage 1 Low Stage/40%							
ADHMB060BCV3VB	3	57,000	22,800	95.0 ^②	2, 2 1/2, 3	⑥	40 x 17 1/2 x 28	160	15	(2)14 x 20 x 1
ADHMB080ACV3VB	3	76,000	30,400	96.0 ^②	2, 2 1/2, 3	⑥	40 x 17 1/2 x 28	168	15	(2)14 x 20 x 1
ADHMC100ACV4VB	4	96,000	38,400	96.0	2 1/2, 3	⑥	40 x 21 x 28	185	15	(2)16 x 20 x 1
ADHMD120BCV5VB	5	114,000	51,300	95.0 ^②	3	⑥	40 x 24 1/2 x 28	206	15	(2)16 x 20 x 1

Note: Variable speed furnaces should not be twinned and are not approved for twinning applications.

Furnaces

Gold ZM – Two Stage ECM Variable Speed

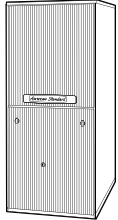

**Gold ZM
Direct/Non-Direct
Vent**

**Table FUR-2-C — Variable Speed, Direct/Non-Direct Vent, Upflow/Horizontal Left Condensing Gas Furnace
(115/1/60)**

Unit Model No.	Airflow In Tons	Output (Btuh)		ICS ^① AFUE	Flue Size (in)	Ignition Device	Uncrated Dimensions (in.) H x W x D	Shipping Weight (lbs.)	Max Fuse*	Filter Sizes
		Stage 2	Stage 1							
AUH2B060A9V3VB	3	58,200	37,830	97.0 ^②	2, 2 1/2, 3	⑥	40 x 17 1/2 x 28	158	15	17 x 25 x 1
AUH2B080A9V3VB	3	77,600	50,440	97.0 ^②	2, 2 1/2, 3	⑥	40 x 17 1/2 x 28	168	15	17 x 25 x 1
AUH2B080A9V4VB	4	77,600	50,440	97.0 ^②	2, 2 1/2, 3	⑥	40 x 17 1/2 x 28	170	15	17 x 25 x 1
AUH2C100A9V4VB	4	96,700	62,855	96.7 ^②	2 1/2, 3	⑥	40 x 21 x 28	197	15	20 x 25 x 1
AUH2C100A9V5VB	5	96,700	62,855	96.7 ^②	2 1/2, 3	⑥	40 x 21 x 28	199	20	20 x 25 x 1
AUH2D120A9V5VB	5	116,040	75,426	96.7 ^②	3	⑥	40 x 24 1/2 x 28	206	20	24 x 25 x 1

Note: Variable speed furnaces should not be twinned and are not approved for twinning applications.

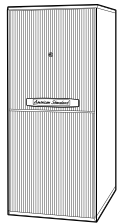

**Gold ZM
Direct/Non-Direct
Vent**

**Table FUR-2-D — Variable Speed, Direct/Non-Direct Vent, Downflow/Horizontal Right Condensing Gas Furnace
(115/1/60)**

Unit Model No.	Airflow In Tons	Output (Btuh)		ICS ^① AFUE	Flue Size (in)	Ignition Device	Uncrated Dimensions (in.) H x W x D	Shipping Weight (lbs.)	Max Fuse*	Filter Sizes
		Stage 2	Stage 1							
ADH2B060A9V3VB	3	57,600	37,440	96.0 ^②	2, 2 1/2, 3	⑥	40 x 17 1/2 x 28	160	15	(2)14 x 20 x 1
ADH2B080A9V3VB	3	76,800	49,920	96.0 ^②	2, 2 1/2, 3	⑥	40 x 17 1/2 x 28	168	15	(2)14 x 20 x 1
ADH2B080A9V4VB	4	76,000	49,400	95.0 ^②	2, 2 1/2, 3	⑥	40 x 17 1/2 x 28	172	15	(2)14 x 20 x 1
ADH2C100A9V4VB	4	96,000	62,400	96.0 ^②	2 1/2, 3	⑥	40 x 21 x 28	185	15	(2)16 x 20 x 1
ADH2D120A9V5VB	5	115,200	74,880	96.0 ^②	3	⑥	40 x 24 1/2 x 28	206	20	(2)16 x 20 x 1

① Isolated Combustion System.

② Energy Star.

③ Low stage is equal to 45% for AUHMD120 model.

④ Furnace use in 24, non-communicating mode.

⑤ Direct drive variable speed motor is an ECM constant airflow blower motor.

⑥ Silicon Nitride

⑦ Must use ACONT900 or AZONE950 control in communicating mode.

* Information subject to change. Please confirm with current Product Data/Service Facts for current factory production.

** Filters are not shipped with furnace.

Note: Variable speed furnaces should not be twinned and are not approved for twinning applications

Gold XM – Two Stage

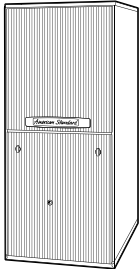

**Gold XM Direct/
Non-Direct Vent**

Table FUR-3-A — Direct/Non-Direct Vent, Upflow/Horizontal Left Condensing Gas Furnace (115/1/60)

Unit Model No.	Airflow In Tons	Output (Btuh)		ICS ^① AFUE	Flue Size (in)	Ignition Device	Uncrated Dimensions (in.) H x W x D	Shipping Weight (lbs.)	Max Fuse*	Filter** Sizes
		Stage 2	Stage 1							
AUH2B060A936VA	3	57,600	37,440	96.0	2, 2 ¹ / ₂ , 3	②	40 x 17 ¹ / ₂ x 28	150	15	17 x 25 x 1
AUH2B080A942VA	3 ¹ / ₂	76,800	49,920	96.0	2, 2 ¹ / ₂ , 3	②	40 x 17 ¹ / ₂ x 28	158	15	17 x 25 x 1
AUH2C100A948VA	4	96,000	62,400	96.0	2 ¹ / ₂ , 3	②	40 x 21 x 28	171	20	20 x 25 x 1
AUH2D120A960VA	5	115,200	74,880	96.0	3	②	40 x 24 ¹ / ₂ x 28	205	20	24 x 25 x 1

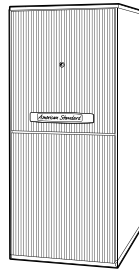

**Gold XM Direct/
Non-Direct Vent**

Table FUR-3-B — Direct/Non-Direct Vent, Downflow/Horizontal Right Condensing Gas Furnace (115/1/60)

Unit Model No.	Airflow In Tons	Output (Btuh)		ICS ^① AFUE	Flue Size (in)	Ignition Device	Uncrated Dimensions (in.) H x W x D	Shipping Weight (lbs.)	Max Fuse*	Filter** Sizes
		Stage 2	Stage 1							
ADH2B060A936VA	2	57,000	37,000	95.0	2, 2 ¹ / ₂ , 3	②	40 x 17 ¹ / ₂ x 28	155	15	(2)14 x 20 x 1
ADH2B080A942VA	3 ¹ / ₂	76,000	49,400	95.0	2, 2 ¹ / ₂ , 3	②	40 x 17 ¹ / ₂ x 28	168	15	(2)14 x 20 x 1
ADH2C100A948VA	4	95,000	61,800	95.0	2 ¹ / ₂ , 3	②	40 x 21 x 28	185	20	(2)16 x 20 x 1
ADH2D120A960VA	5	115,200	74,880	96.0	3	②	40 x 24 ¹ / ₂ x 28	206	20	(2)16 x 20 x 1

① Isolated Combustion System.

② Silicon Nitride.

* Information subject to change. Please confirm with current Product Data/Service Facts for current factory production.

** Filters are not shipped with furnace.

Silver ZI – Single Stage

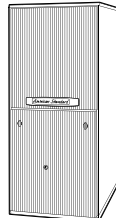

**Silver ZI
Direct/Non-Direct
Vent**

Table FUR-3-C — Direct/Non-Direct Vent, Upflow/Horizontal Left Condensing Gas Furnace (115/1/60)

Unit Model No.	Airflow In Tons	Nominal Output (Btuh)	ICS ^① AFUE	Flue Size (in)	Ignition Device	Uncrated Dimensions (in.) H x W x D	Shipping Weight (lbs.)	Max Fuse*	Filter** Sizes
AUH1B040A9241A	2	38,000	95.0	2, 2 ¹ / ₂ , 3	②	40 x 17 ¹ / ₂ x 28	139	15	17 x 25 x 1
AUH1B060A9361A	3	57,000	95.0	2, 2 ¹ / ₂ , 3	②	40 x 17 ¹ / ₂ x 28	150	15	17 x 25 x 1
AUH1B080A9421B	3 ¹ / ₂	73,150	95.0	2, 2 ¹ / ₂ , 3	②	40 x 17 ¹ / ₂ x 28	158	15	17 x 25 x 1
AUH1C080A9601A	5	76,000	95.0	3	②	40 x 21 x 28	171	20	20 x 25 x 1
AUH1C100A9481A	4	92,150	95.0	3	②	40 x 21 x 28	171	20	20 x 25 x 1
AUH1D100A9601A	5	92,150	95.0	3	②	40 x 24 ¹ / ₂ x 28	197	20	24 x 25 x 1
AUH1D120A9601A	5	104,500	95.0	3	②	40 x 24 ¹ / ₂ x 28	205	20	24 x 25 x 1

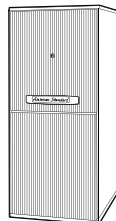

**Silver ZI
Direct/Non-Direct
Vent**

Table FUR-3-D — Direct/Non-Direct Vent, Downflow/Horizontal Right Condensing Gas Furnace (115/1/60)

Unit Model No.	Airflow In Tons	Nominal Output (Btuh)	ICS ^① AFUE	Flue Size (in)	Ignition Device	Uncrated Dimensions (in.) H x W x D	Shipping Weight (lbs.)	Max ^② Fuse*	Filter** Sizes
ADH1B040A9241A	2	38,000	95.0	2, 2 ¹ / ₂ , 3	②	40 x 17 ¹ / ₂ x 28	155	15	(2)14 x 20 x 1
ADH1B065A9421A	3 ¹ / ₂	57,000	95.0	2, 2 ¹ / ₂ , 3	②	40 x 17 ¹ / ₂ x 28	168	15	(2)14 x 20 x 1
ADH1C085A9481A	4	76,000	95.0	2 ¹ / ₂ , 3	②	40 x 21 x 28	185	15	(2)16 x 20 x 1
ADH1D110A9601A	5	104,500	95.0	2 ¹ / ₂ , 3	②	40 x 24 ¹ / ₂ x 28	206	20	(2)16 x 20 x 1

① Isolated Combustion System.

② Silicon Nitride

* Information subject to change. Please confirm with current Product Data/Service Facts for current factory production.

** Filters are not shipped with furnace.

Gold XI - Single Stage with ECM Multi-Speed Motor

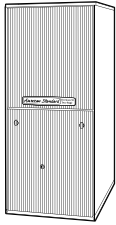

Gold XI
Direct/Non-Direct Vent

Table FUR-4-A — Direct/Non-Direct Vent, Upflow/Horizontal Left Condensing Gas Furnace with Filter

Unit Model No.	Airflow In Tons	Nominal Output (Btuh)	ICS ^① AFUE	Flue Size (in)	Ignition Device	Uncrated Dimensions (in.) H x W x D	Shipping Weight (lbs.)	Max Fuse*	Filter Sizes
AUH1B040A9H21B	2	38,000	95.0	2, 2 ¹ / ₂ , 3	②	40 x 17 ¹ / ₂ x 28	139	15	17 x 25 x 1
AUH1B060A9H31B	3	57,000	95.0	2, 2 ¹ / ₂ , 3	②	40 x 17 ¹ / ₂ x 28	150	15	17 x 25 x 1
AUH1B080A9H31C	3	73,150	95.0	2, 2 ¹ / ₂ , 3	②	40 x 17 ¹ / ₂ x 28	158	15	17 x 25 x 1
AUH1C100A9H41B	3 ¹ / ₂	92,150	95.0	3	②	40 x 21 x 28	171	15	20 x 25 x 1
AUH1D120A9H51B	5	104,500	95.0 ^③	3	②	40 x 24 ¹ / ₂ x 28	205	15	24 x 25 x 1
ADH1B040A9H21B	2	38,000	95.0	2, 2 ¹ / ₂ , 3	②	40 x 17 ¹ / ₂ x 28	145	15	(2) 14 x 20 x 1
ADH1B065A9H31B	3	57,000	95.0	2, 2 ¹ / ₂ , 3	②	40 x 17 ¹ / ₂ x 28	158	15	(2) 14 x 20 x 1
ADH1C085A9H41B	4	76,000	95.0	2 ¹ / ₂ , 3	②	40 x 21 x 28	171	15	(2) 16 x 20 x 1
ADH1D110A9H51B	5	104,500	95.0	2 ¹ / ₂ , 3	②	40 x 24 ¹ / ₂ x 28	205	15	(2) 16 x 20 x 1

- ① Isolated Combustion System.
- ② Silicon Nitride.
- ③ Energy Star

Furnaces

Silver SI - Single Stage

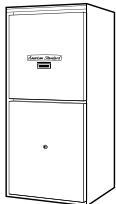

Silver SI

Table FUR-4-B — Direct/Non-Direct Vent, Upflow/Horizontal Left Condensing Gas Furnace (115/1/60)

Unit Model No.	Airflow In Tons	Nominal Output (Btuh)	AFUE	Flue Size (in)	Ignition Device	Uncrated Dimensions (in.) H x W x D	Shipping Weight (lbs.)	Max Fuse*	Filter** Sizes
AUC1B040A9241A	2	37,000	92.1	2, 2 ¹ / ₂ , 3	Silicon Nitride	40 x 17 ¹ / ₂ x 28	139	15	17 x 25 x 1
AUC1B060A9361A	3	56,000	92.1	2, 2 ¹ / ₂ , 3	Silicon Nitride	40 x 17 ¹ / ₂ x 28	150	15	17 x 25 x 1
AUC1B080A9421A	3 ¹ / ₂	74,000	92.1	2, 2 ¹ / ₂ , 3	Silicon Nitride	40 x 17 ¹ / ₂ x 28	158	15	17 x 25 x 1
AUC1C100A9481A	4	94,000	92.1	2 ¹ / ₂ , 3	Silicon Nitride	40 x 21 x 28	171	20	20 x 25 x 1
AUC1D100A9601A	5	93,000	92.1	2 ¹ / ₂ , 3	Silicon Nitride	40 x 24 ¹ / ₂ x 28	197	20	24 x 25 x 1
AUC1D120A9601A	5	113,000	92.1	2 ¹ / ₂ , 3	Silicon Nitride	40 x 24 ¹ / ₂ x 28	205	20	24 x 25 x 1

Table FUR-4-C — Direct/Non-Direct Vent, Downflow/Horizontal Right Condensing Gas Furnace (115/1/60)

Unit Model No.	Airflow In Tons	Nominal Output (Btuh)	AFUE	Flue Size (in)	Ignition Device	Uncrated Dimensions (in.) H x W x D	Shipping Weight (lbs.)	Max Fuse*	Filter** Sizes
ADC1B040A9241A	2	37,000	92.1	2, 2 ¹ / ₂ , 3	Silicon Nitride	40 x 17 ¹ / ₂ x 28	145	15	(2) 14 x 20 x 1
ADC1B060A9361A	3	56,000	92.1	2, 2 ¹ / ₂ , 3	Silicon Nitride	40 x 17 ¹ / ₂ x 28	155	15	(2) 14 x 20 x 1
ADC1B080A9421A	3 ¹ / ₂	74,000	92.1	2, 2 ¹ / ₂ , 3	Silicon Nitride	40 x 17 ¹ / ₂ x 28	168	15	(2) 14 x 20 x 1
ADC1C100A9481A	4	93,000	92.1	2 ¹ / ₂ , 3	Silicon Nitride	40 x 21 x 28	185	20	(2) 16 x 20 x 1
ADC1D120A9601A	5	112,000	92.1	2 ¹ / ₂ , 3	Silicon Nitride	40 x 24 ¹ / ₂ x 28	206	20	(2) 16 x 20 x 1

- * Information subject to change. Please confirm with current Product Data/Service Facts for current factory production.
- ** Filters are not shipped with furnace.

Platinum ZV, Gold ZM, Gold XM, Silver ZI, Gold XI, and Silver SI Convertible Gas Furnace

Airflow Directions:

Downflow models when placed in horizontal position provide left to right airflow. Upflow models when placed in horizontal position provide right to left airflow.

Table FUR-5-A — Features

	AUHM/ ADHM Modulating 1 or 2 Pipe Variable Speed	AUH2/ ADH2 2 Stage 1 or 2 Pipe Variable Speed	AUH1-H/ ADH1-H 1 Stage 1 or 2 Pipe Variable Speed	AUH2/ ADH2 1 Stage 1 or 2 Pipe PSC	AUH1/ ADH1 1 Stage 1 or 2 Pipe	AUC1/ ADC1 1 Stage 1 or 2 Pipe
• Comfort-R™ enhanced mode (cooling).....	✓	✓	—	—	—	—
• AccuLink™ system②	✓	—	—	—	—	—
• Adjustable heating fan off timing.....	✓	✓	✓	✓	✓	✓
• Alternate bottom/left/right return air (upflow models only)	✓	✓	✓	✓	✓	✓
• Blower door safety switch	✓	✓	✓	✓	✓	✓
• Bottom panel (upflow models only)	✓	✓	✓	✓	✓	—
• Cleanable/Reusable high velocity filters	✓	✓	✓	—	—	—
• Complete front service access	✓	✓	✓	✓	✓	✓
• Direct drive, multi-speed (PSC) blower motor.....	✓	—	—	✓	✓	✓
• Direct drive, multi-speed ECM blower motor (high efficiency)*	—	—	✓	—	—	—
• Direct drive, variable speed ECM blower motor**	✓	✓	—	—	—	—
• Downflow horizontal right (downflow models only)	✓	✓	✓	✓	✓	✓
• Dual PVC pipe venting (1 or 2 pipe option)	✓	✓	✓	✓	✓	✓
• Two stage combination gas valve and regulator.....	—	✓	—	—	—	—
• One stage combination gas valve and regulator	—	—	✓	—	✓	✓
• Modulating gas valve and regulator.....	✓	—	—	—	—	—
• Gasketed blower door (upflow models only).....	✓	✓	✓	✓	✓	—
• Heavy gauge reinforced wrap-around steel cabinet	✓	✓	✓	✓	✓	✓
• Humidifier/EAC hook-up capability	✓	✓	✓	✓	✓	—
• Inner blower door panel (downflow models only)	✓	✓	✓	✓	✓	—
• Insulated blower compartment 4 sides	✓	✓	✓	✓	✓	—
• Integrated solid state control w/self diagnostics	✓	—	—	—	—	—
• Left/right condensate drain capability in vertical application	✓	✓	✓	✓	✓	✓
• Service diagnostics with faults reported at the user interface	✓	—	—	—	—	—
• Lite Port™/Stored diagnostics.....	✓	✓	—	—	—	—
• Manual reset flame roll out switches.....	✓	✓	✓	✓	✓	✓
• Mobile home approved w/BAYMFGH100A.....	—	✓	✓	✓	✓	✓
• Multi-port in shot burners.....	✓	✓	✓	✓	✓	✓
• Painted cabinet single color.....	—	—	—	—	—	✓
• Painted cabinet two tone color.....	✓	✓	✓	✓	✓	—
• Perfect fit door latches (upflow models only).....	✓	—	—	—	—	—
• Service diagnostic capabilities.....	✓	✓	✓	✓	✓	✓
• Slide out blower assembly	✓	✓	✓	✓	✓	✓
• Side return duct starter tabs (upflow models only)	✓	✓	✓	✓	✓	✓
• Silicon Nitride hot surface igniter	✓	✓	✓	✓	✓	✓
• Single wire twinning	—	—	✓	✓	✓	—
• Solid burner door (quiet operation)	✓	✓	✓	✓	✓	—
• 20 gauge aluminized steel heat exchanger	✓	✓	✓	✓	✓	✓
• 24 volt secondary fuse.....	✓	✓	✓	✓	✓	✓
• Multiple heating blower speeds.....	✓	✓	✓	—	—	—
• Two heating blower speeds.....	—	—	—	✓	—	—
• Type 29-4C™ stainless steel secondary heat exchanger.....	✓	✓	✓	✓	✓	✓
• Upflow horizontal left (upflow models only)	✓	✓	✓	✓	✓	✓
• Variable speed venter motor.....	✓	✓	—	✓	—	—
• Meets requirements for 2% or less air leakage	✓	✓	✓	—	—	—
• Registered limited lifetime heat exchanger warranty and 10-year on all other functional parts (Residential Use)①.....	✓	✓	✓	—	✓	✓
• Optional extended warranties available	✓	✓	✓	✓	✓	✓

① Registered Limited Warranty terms are available when you register within 60 days of installation. You can register online at americanstandardair.com or by phone at 800-554-8005; otherwise American Standard Heating & Air Conditioning's Base Limited Warranty terms will apply. Base Limited Warranty information on specific products can be found on ASDealerNet.com.

② Field configurable to 24V non-communicating mode.

Note: Variable speed furnaces should not be twinned and are not approved for twinning applications.

*Constant torque ECM (electronically commutated motor).

**Constant airflow ECM (electronically commutated motor).

Platinum ZV, Gold ZM, Gold XM, Silver ZI, Gold XI, and Silver SI Convertible Gas Furnace

Furnaces

Airflow Directions:

Downflow models when placed in horizontal position provide left to right airflow. Upflow models when placed in horizontal position provide right to left airflow.

Table FUR-6-A — Optional Accessories

Model Number	Description	Shipping Weight	AUHM/ADHM Modulating 1 or 2 Pipe Variable Speed	AUH2/ADH2 2 Stage 1 or 2 Pipe Variable Speed
BAYBASE205	Downflow subbase for downflow models only	8	✓	✓
BAYFLTR200	External side filter rack	5	✓	✓
BAYFLTR203	Filter kit horiz conversion for 17.5" cabinet	3	✓	✓
BAYFLTR204	Filter kit horiz conversion for 21" cabinet	3	✓	✓
BAYFLTR205	Filter kit horiz conversion for 24.5" cabinet	3	✓	✓
BAYFLTR317①	Cleanable filter for 17.5" cabinet upflow only	2	✓	✓
BAYFLTR321①	Cleanable filter for 21" cabinet upflow only	2	✓	✓
BAYFLTR324①	Cleanable filter for 24.5" cabinet upflow only	2	✓	✓
BAYLPKT210B	Propane conversion kit	1	—	✓
BAYLPKT220B	Propane conversion kit	2	✓	—
BAYLPSS210B	LP Kit with Stainless Steel Burners	1	—	✓
BAYLPSS220B	LP Kit with Stainless Steel Burners	2	✓	—
BAYMFGH100A	Manufactured/mobil home kit	2	—	✓
BAYRACK960A	Filter rack kit for upflow models only (internal)②	5	✓	✓
BAYAIR30AVENTA	Concentric vent kit for 2, 2½ and 3" ven system	11	✓	✓
BAYVENT200B	Sidewall vent Termination Kit fo Direct vent furnaces	2	✓	✓
BAYVENT500A	Side vent kit for downflow models only	3	✓	✓
BAYACCECOMM101	..AccuClean™ hookup kit for communicating furnaces	1	✓	—

① Contains one (1) high velocity filter.

② Internal filter rack for side or bottom return air. Includes 17 x 25" cleanable filter for use in side return applications. Bottom return applications require different sizes of filters which are not included. Airflow requirements over 1800 CFM require filters on both sides or a side and bottom or bottom only.

Note: Variable speed furnaces should not be twinned and are not approved for twinning applications.

Airflow Directions:

Downflow models when placed in horizontal position provide left to right airflow. Upflow models when placed in horizontal position provide right to left airflow.

Table FUR-6-B — Optional Accessories

Model Number	Description	Shipping Weight	AUH1-H/ ADH1-H 2 Stage 1 or 2 Pipe	AUH2/ADH2 2 Stage 1 or 2 Pipe PSC	AUH1/ADH1/ AUX1/ADX1 1 Stage 1 or 2 Pipe	AUC1/ADC1 1 Stage 1 or 2 Pipe
BAYBASE205	Downflow subbase for downflow models only	8	✓	✓	✓	✓
BAYFLTR200	External side filter rack	5	✓	✓	✓	✓
BAYFLTR203	Filter kit horiz conversion for 17.5" cabinet	3	✓	✓	✓	✓
BAYFLTR204	Filter kit horiz conversion for 21" cabinet	3	✓	✓	✓	✓
BAYFLTR205	Filter kit horiz conversion for 24.5" cabinet	3	✓	✓	✓	✓
BAYFLTR206	Filter kit	2	—	—	✓	✓
BAYFLTR317①	Cleanable filter for 17.5" cabinet upflow only	2	✓	✓	✓	✓
BAYFLTR321①	Cleanable filter for 21" cabinet upflow only	2	✓	✓	✓	✓
BAYFLTR324①	Cleanable filter for 24.5" cabinet upflow only	2	✓	✓	✓	✓
BAYLPKT210B	Propane conversion kit	1	✓	✓	✓	✓
BAYLPSS210B	LP Kit with Stainless Steel Burners	1	✓	✓	✓	✓
BAYMFGH100A	Manufactured/mobil home kit	2	✓	✓	✓	✓
BAYRACK960A	Filter rack kit for upflow models only (internal)②	5	✓	✓	✓	✓
BAYAIR30AVENTA	Concentric vent kit for 2, 2½ and 3" vent system	11	✓	✓	✓	✓
BAYVENT200B	Sidewall vent Termination Kit fo Direct vent furnaces	2	✓	✓	✓	✓
BAYVENT500A	Side vent kit for downflow models only	3	✓	✓	✓	✓

① Contains one (1) high velocity filter.

② Internal filter rack for side or bottom return air. Includes 17 x 25" cleanable filter for use in side return applications. Bottom return applications require different sizes of filters which are not included. Airflow requirements over 1800 CFM require filters on both sides or a side and bottom or bottom only.

Note: Variable speed furnaces should not be twinned and are not approved for twinning applications.

Special Use Furnace Accessories

Table FUR-7-A — High Altitude Pressure Switch 90%

Model Number	Description	Used With	Shipping Weight
BAYHALT225	1 Switch	AUC080,100C948,120C,ADC080,120C	2
BAYHALT226	1 Switch	AUC,ADC060C	2
BAYHALT227	1 Switch	AUC100C948	2
BAYHALT228	1 Switch	AUC/ADC040C	2
BAYHALT230	1 Switch	AUX/ADX040C,AUX1B040,D100/ADX1B040	2
BAYHALT231	1 Switch	AUX060C,AUX1060C	2
BAYHALT232	1 Switch	AUX080C,AUX1B080C	2
BAYHALT233	1 Switch	AUX100,120C/ADX080,120C,AUX1C100,D120/ADX1B080,D120	2
BAYHALT234	1 Switch	ADX100C,ADX1C100	2
BAYHALT241	1 Switch	ADX060C,ADX1B060	2
BAYHALT245	2 Switches	ADX/AUX/ADY/AUY060-R	2
BAYHALT246	2 Switches	ADX/AUX/ADY/AUY080,100-R	2
BAYHALT247	2 Switches	ADX/AUX/ADY/AUY120-R	2
BAYHALT248	1 Switch	AUD1/ADD1,AUE1/ADE	2
BAYHALT249	1 Switch	AUD2,AUD-R-K,ADD-R-F,ADD2	2

Table FUR-7-B — High Altitude Pressure Switch 90%

Model Number	Description	Used With	Shipping Weight
BAYSWT01AHALTA	1 Switch	AUC1B040,AUC1D100,ADC1B040,AUX1B040,AUX1D100,ADX1B040,AUH1B040,ADH1B040,ADH1C085	2
BAYSWT02AHALTA	1 Switch	AUC1B060,AUX1B060	2
BAYSWT03AHALTA	1 Switch	AUC1B080,AUX1B080	2
BAYSWT04AHALTA	1 Switch	AUC1C100,AUC1D120,ADC1B080,ADC1C100,ADC1D120,AUX1C100,AUX1D120,ADX1B080,ADX1D120,AUH1B060	2
BAYSWT05AHALTA	1 Switch	ADX1C100,AUH1B080,AUH1C100,ADH1D110	2
BAYSWT06AHALTA	1 Switch	ADC1B060,ADX1B060	2
BAYSWT07AHALTA	1 Switch	AUH3/AUHMB060,ADH3/ADHMB060,AUX2B060,ADX2B060,AUY060R,ADY060R	2
BAYSWT08AHALTA	1 Switch	AUX2B080,AUX2C100,ADX2B080,ADX2C100,AUY120R,ADY120R,AUH2B080,ADH2B080,AUH2C100,ADH2C100,AUH2D120,ADH2D120,AUH3/AUHMD120,ADH3/ADHMD120	2
BAYSWT09AHALTA	1 Switch	AUX2D120,ADX2D120,AUY080R,ADY080R,AUY100R,ADY100R,AUH3/AUHMB080,ADH3/ADHMB080,AUH3/AUHMC100,ADH/ADHM3C100	2
BAYSWT10AHALTA	1 Switch	AUH2B060A,ADH2B060A	2
BAYSWT11AHALTA	1 Switch	AUH1C080	2
BAYSWT12AHALTA	1 Switch	ADH1B065	2
BAYSWT01AMALTB	1 Switch	AUX1	2

The following changes occurred beginning with serial number 6151:

1. All 2 stage furnace changed from two separate pressure switches to one piggy back switch.
2. The high altitude pressure switches are now piggy back.
3. The new piggy back switches are not interchangeable with the original two switch design.
4. The pressure switch mounting plate is different for the piggy back switches.

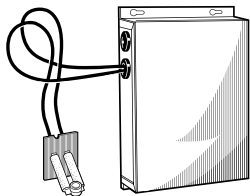

Bonnet Switch TAYPLUS103A

Table FUR-7-C — Dual Fuel Heat Pump Control Kit^{①②}

Model Number	Case Height	Used With
TAYPLUS103A.....	Heat Pump Control Kit.....	Gas, LP, Oil and Electric Furnaces
TAYSTAT250B.....	Outdoor Thermostat.....	TAYPLUS103A for Restricted Mode

① Factory wired for non-restricted mode, can be wired for restricted mode.

② Applicable for all furnaces with 35 VA or larger low voltage transformer (separate high voltage power not required).

Platinum SV, Gold SV, Gold SM, Silver XI, Silver SI+, and Silver SI Gas Furnaces Airflow Directions

Furnaces

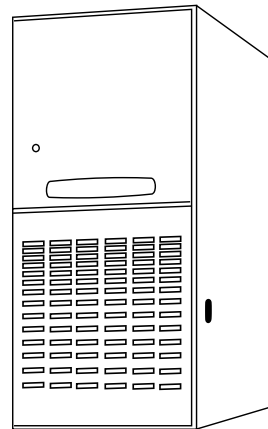
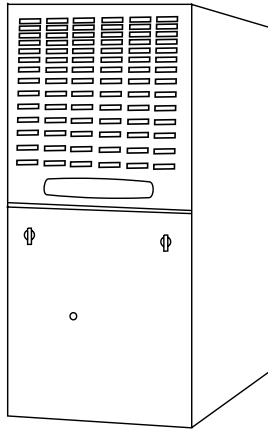

UPFLOW, DOWNFLOW, HORIZONTAL LEFT OR RIGHT

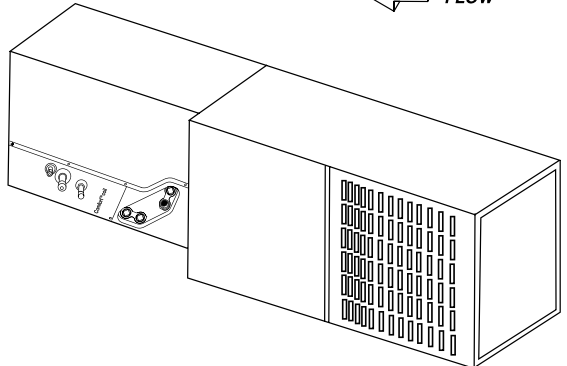
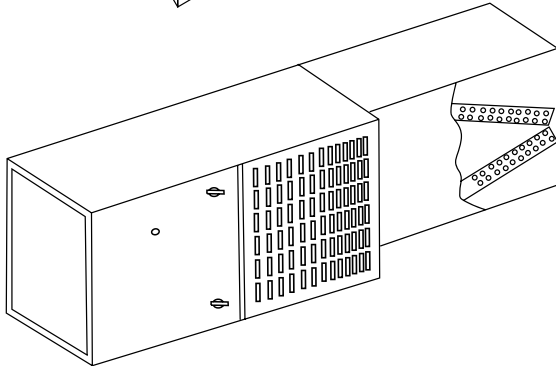
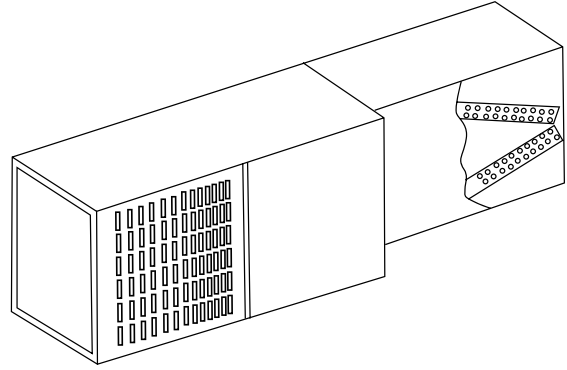
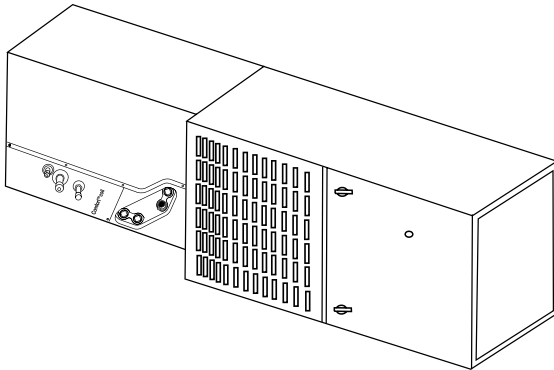

Note: The non-condensing, forty inch (40") height furnaces may be laid on either side for horizontal application. Connection brackets for coil/furnace alignment are included with the furnaces. The apex of the coil may point into or away from the airflow.

Platinum SV – Communicating Two Stage ECM Variable Speed

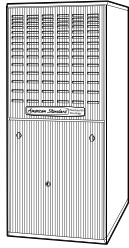

Platinum SV

Table FUR-9-A — Upflow/Horizontal Left or Right Induced Draft Gas Furnace (115/1/60) ①②

Unit Model No.	Airflow		Output (Btuh)		AFUE	Flue Size (in)	Ignition Device	Uncrated Dimensions (in.) H x W x D	Shipping Weight (lbs.)	Max Fuse*	Filter Sizes
	In Tons	Stage 2	Stage 1	AFUE							
AUD2B060ACV32A	3	48,000	31,200	80.0	4	Silicon Nitride	40 x 17 ¹ / ₂ x 28	136	15	17 x 25 x 1	
AUD2B080ACV32A	3	64,000	41,600	80.0	4	Silicon Nitride	40 x 17 ¹ / ₂ x 28	142	15	17 x 25 x 1	
AUD2C080ACV42A	4	64,000	41,600	80.0	4	Silicon Nitride	40 x 21 x 28	166	15	17 x 25 x 1	
AUD2B100ACV32A	3	80,000	52,000	80.0	4	Silicon Nitride	40 x 17 ¹ / ₂ x 28	142	15	17 x 25 x 1	
AUD2C100ACV52A	5	79,000	52,000	80.0	4	Silicon Nitride	40 x 21 x 28	166	15	20 x 25 x 1	
AUD2D120ACV52A	5	97,000	62,400	80.0	4	Silicon Nitride	40 x 24 ¹ / ₂ x 28	193	15	24 x 25 x 1	
AUD2D140ACV52A	5	111,000	72,800	80.0	4	Silicon Nitride	40 x 24 ¹ / ₂ x 28	197	15	24 x 25 x 1	

Note: Variable speed furnaces should not be twinned and are not approved for twinning applications.

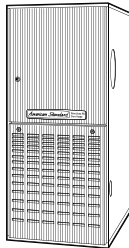

Platinum SV

Table FUR-9-B — Downflow/Horizontal Left or Right Induced Draft Gas Furnace (115/1/60) ①②

Unit Model No.	Airflow		Output (Btuh)		AFUE	Flue Size (in)	Ignition Device	Uncrated Dimensions (in.) H x W x D	Shipping Weight (lbs.)	Max Fuse*	Filter Sizes
	In Tons	Stage 2	Stage 1	AFUE							
ADD2B060ACV32A	3	48,000	31,200	80.0	4	Silicon Nitride	40 x 17 ¹ / ₂ x 28	140	15	(2) 14 x 20 x 1	
ADD2B080ACV32A	3	63,000	41,600	80.0	4	Silicon Nitride	40 x 17 ¹ / ₂ x 28	146	15	(2) 14 x 20 x 1	
ADD2C100ACV52A	5	81,000	52,000	80.0	4	Silicon Nitride	40 x 21 x 28	166	15	(2) 16 x 20 x 1	
ADD2D120ACV52A	5	95,000	62,400	80.0	4	Silicon Nitride	40 x 24 ¹ / ₂ x 28	197	15	(2) 16 x 20 x 1	

Note: Variable speed furnaces should not be twinned and are not approved for twinning applications.

① Must use ACONT900 or AZONE950 control in communicating mode.

② Field convertible to 24V non-communicating.

* Information subject to change. Please confirm with current Product Data/Service Facts for current factory production.

** Filters are not shipped with furnace.

Gold SV – Two Stage ECM Variable Speed

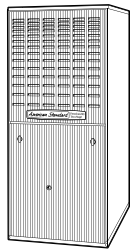

Gold SV

Table FUR-9-C — Upflow/Horizontal Left or Right Induced Draft Gas Furnace (115/1/60) ②

Unit Model No.	Airflow		Output (Btuh)		AFUE	Flue Size (in)	Ignition Device	Uncrated Dimensions (in.) H x W x D	Shipping Weight (lbs.)	Max Fuse*	Filter Sizes
	In Tons	Stage 2	Stage 1	AFUE							
AUD2B060A9V3VB	3	48,000	31,200	80.0	4	Silicon Nitride	40 x 17 ¹ / ₂ x 28	136	15	17 x 25 x 1	
AUD2B080A9V3VB	3	64,000	41,600	80.0	4	Silicon Nitride	40 x 17 ¹ / ₂ x 28	142	15	17 x 25 x 1	
AUD2C080A9V4VB	4	64,000	41,600	80.0	4	Silicon Nitride	40 x 21 x 28	166	15	17 x 25 x 1	
AUD2C080B9V4VB ①	4	64,000	41,600	80.0	4	Silicon Nitride	40 x 21 x 28	166	15	17 x 25 x 1	
AUD2B100A9V3VB	3	80,000	52,000	80.0	4	Silicon Nitride	40 x 17 ¹ / ₂ x 28	142	15	17 x 25 x 1	
AUD2C100A9V5VB	5	79,000	52,000	80.0	4	Silicon Nitride	40 x 21 x 28	166	20	20 x 25 x 1	
AUD2C100B9V5VB ①	5	79,000	52,000	80.0	4	Silicon Nitride	40 x 21 x 28	166	20	20 x 25 x 1	
AUD2D120A9V5VB	5	97,000	62,400	80.0	4	Silicon Nitride	40 x 24 ¹ / ₂ x 28	193	20	24 x 25 x 1	
AUD2D120B9V5VB ①	5	97,000	62,400	80.0	4	Silicon Nitride	40 x 24 ¹ / ₂ x 28	193	20	24 x 25 x 1	
AUD2D140A9V5VB	5	111,000	72,800	80.0	4	Silicon Nitride	40 x 24 ¹ / ₂ x 28	197	20	24 x 25 x 1	

① Model has high efficiency blower assembly.

② This furnace family uses a two speed draft inducer.

Note: Variable speed furnaces should not be twinned and are not approved for twinning applications.

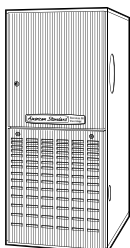

Gold SV

Table FUR-9-D — Downflow/Horizontal Left or Right Induced Draft Gas Furnace (115/1/60) ②

Unit Model No.	Airflow		Output (Btuh)		AFUE	Flue Size (in)	Ignition Device	Uncrated Dimensions (in.) H x W x D	Shipping Weight (lbs.)	Max Fuse*	Filter Sizes
	In Tons	Stage 2	Stage 1	AFUE							
ADD2B060A9V3VA	3	48,000	31,200	80.0	4	Silicon Nitride	40 x 17 ¹ / ₂ x 28	140	15	(2) 14 x 20 x 1	
ADD2B080A9V3VA	3	63,000	41,600	80.0	4	Silicon Nitride	40 x 17 ¹ / ₂ x 28	146	15	(2) 14 x 20 x 1	
ADD2C100A9V5VA	5	81,000	52,000	80.0	4	Silicon Nitride	40 x 21 x 28	166	20	(2) 16 x 20 x 1	
ADD2D120A9V5VA	5	95,000	62,400	80.0	4	Silicon Nitride	40 x 24 ¹ / ₂ x 28	197	20	(2) 16 x 20 x 1	

Note: Variable speed furnaces should not be twinned and are not approved for twinning applications.

* Information subject to change. Please confirm with current Product Data/Service Facts for current factory production.

② This furnace family uses a two speed draft inducer.

Gold SM – Two Stage

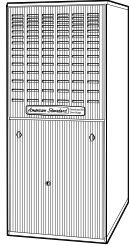

Gold SM

Table FUR-10-B — Upflow/Horizontal, Left or Right Induced Draft Gas Furnace (115/1/60)

Unit Model No.	Airflow In Tons	Output (Btuh)		AFUE	Flue Size (in.)	Ignition Device	Uncrated Dimensions (in.) H x W x D	Shipping Weight (lbs.)	Max Fuse*	Filter** Sizes
		Stage 2	Stage 1							
AUD2A040A9242A	2	32,000	20,800	80.0	4	Silicon Nitride	40 x 14½ x 28	119	15	17 x 25 x 1
AUD2A060A9362A	3	47,000	31,200	80.0	4	Silicon Nitride	40 x 14½ x 28	127	15	17 x 25 x 1
AUD2B060A9362A	3	47,000	31,200	80.0	4	Silicon Nitride	40 x 17½ x 28	132	15	17 x 25 x 1
AUD2B080A9362A	3	63,000	41,600	80.0	4	Silicon Nitride	40 x 17½ x 28	142	15	17 x 25 x 1
AUD2B080A9482A	4	63,000	41,600	80.0	4	Silicon Nitride	40 x 17½ x 28	142	15	17 x 25 x 1
AUD2B100A9362A	3	79,000	52,000	80.0	4	Silicon Nitride	40 x 17½ x 28	151	15	17 x 25 x 1
AUD2C100A9482A	4	79,000	52,000	80.0	4	Silicon Nitride	40 x 21 x 28	162	15	20 x 25 x 1
AUD2C100A9602A	5	80,000	52,000	80.0	4	Silicon Nitride	40 x 21 x 28	162	20	20 x 25 x 1
AUD2D100A9602A	5	80,000	52,000	80.0	4	Silicon Nitride	40 x 24½ x 28	175	20	24 x 25 x 1
AUD2C120A9542A	4.5	95,000	62,400	80.0	4	Silicon Nitride	40 x 21 x 28	176	20	20 x 25 x 1
AUD2D120A9602A	5	95,000	62,400	80.0	4	Silicon Nitride	40 x 24½ x 28	186	20	24 x 25 x 1
AUD2D140A9602A	5	112,000	72,800	80.0	4	Silicon Nitride	40 x 24½ x 28	192	20	24 x 25 x 1

Furnaces

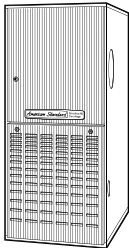

Gold SM

Table FUR-10-C — Downflow/Horizontal Left or Right Induced Draft (115/1/60)

Unit Model No.	Airflow In Tons	Output (Btuh)		AFUE	Flue Size (in.)	Ignition Device	Uncrated Dimensions (in.) H x W x D	Shipping Weight (lbs.)	Max Fuse*	Filter** Sizes
		Stage 2	Stage 1							
ADD2A040A9242A	2	32,000	20,800	80.0	4	Silicon Nitride	40 x 14½ x 28	125	15	(2) 14 x 20 x 1
ADD2A060A9362A	3	47,000	31,200	80.0	4	Silicon Nitride	40 x 14½ x 28	135	15	(2) 14 x 20 x 1
ADD2B060A9362A	3	48,000	31,200	80.0	4	Silicon Nitride	40 x 17½ x 28	140	15	(2) 14 x 20 x 1
ADD2B080A9362A	3	64,000	41,600	80.0	4	Silicon Nitride	40 x 17½ x 28	152	15	(2) 14 x 20 x 1
ADD2B100A9482A	4	79,000	52,000	80.0	4	Silicon Nitride	40 x 17½ x 28	157	15	(2) 14 x 20 x 1
ADD2C100A9482A	4	79,000	52,000	80.0	4	Silicon Nitride	40 x 21 x 28	166	15	(2) 16 x 20 x 1
ADD2C100A9602A	5	79,000	52,000	80.0	4	Silicon Nitride	40 x 21 x 28	168	20	(2) 16 x 20 x 1
ADD2D120A9602A	5	94,000	62,400	80.0	4	Silicon Nitride	40 x 24½ x 28	189	20	(2) 16 x 20 x 1
ADD2D140A9602A	5	112,000	72,800	80.0	4	Silicon Nitride	40 x 24½ x 28	196	20	(2) 16 x 20 x 1

* Information subject to change. Please confirm with current Product Data/Service Facts for current factory production.

** Filters are not shipped with furnace.

Silver XI – Single Stage with ECM Multi-Speed Motor

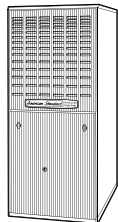

Silver XI

Table FUR-10-A — Upflow Horizontal, Left or Right Induced Draft Gas Furnace (115/1/60)

Unit Model No.	Airflow In Tons	Nominal Output (Btuh)	AFUE	Flue Size (in.)	Ignition Device	Uncrated Dimensions (in.) H x W x D	Shipping Weight (lbs.)	Max Fuse*	Filter Sizes
AUD1B060A9H31B	3	47,000	80.0	4	Silicon Nitride	40 x 17½ x 28	127	15	17 x 25 x 1
AUD1B080A9H31B	3	63,000	80.0	4	Silicon Nitride	40 x 17½ x 28	142	15	17 x 25 x 1
AUD1C080A9H41B	4	64,000	80.0	4	Silicon Nitride	40 x 21 x 28	142	15	20 x 25 x 1
AUD1B100A9H31B	3	79,000	80.0	4	Silicon Nitride	40 x 17½ x 28	151	15	17 x 25 x 1
AUD1C100A9H51B	5	79,000	80.0	4	Silicon Nitride	40 x 21 x 28	162	20	20 x 25 x 1
AUD1D120A9H51B	5	96,000	80.0	4	Silicon Nitride	40 x 24½ x 28	186	20	24 x 25 x 1
AUD1D140A9H51B	5	111,000	80.0	4	Silicon Nitride	40 x 24½ x 28	193	20	24 x 25 x 1

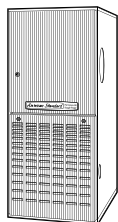

Silver XI

Table FUR-10-B — Downflow Horizontal, Left or Right Induced Draft Gas Furnace (115/1/60)

Unit Model No.	Airflow In Tons	Nominal Output (Btuh)	AFUE	Flue Size (in.)	Ignition Device	Uncrated Dimensions (in.) H x W x D	Shipping Weight (lbs.)	Max Fuse*	Filter Sizes
ADD1B080A9H31B	3	64,000	80.0	4	Silicon Nitride	40 x 17½ x 28	146	15	(2) 14 x 20 x 1
ADD1C100A9H51B	5	81,000	80.0	4	Silicon Nitride	40 x 21 x 28	167	20	(2) 16 x 20 x 1
ADD1D120A9H51B	5	96,000	80.0	4	Silicon Nitride	40 x 24½ x 28	189	20	(2) 16 x 20 x 1

Note: Silver XI furnaces have constant torque ECM motors

For complete equipment / combination selections, installation instructions and warranty information, please refer to Product Data/Ratings and/or Installers Guides and Limited Warranty Handbooks.

Silver SI+ – Single Stage

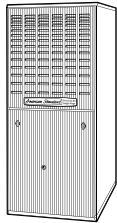

Silver SI+

Table FUR-11-C — Upflow/Horizontal Left or Right Induced Draft Gas Furnace (115/1/60)

Unit Model No.	Airflow In Tons	Nominal Output (Btuh)	AFUE	Flue Size (in.)	Ignition Device	Uncrated Dimensions (in.) H x W x D	Shipping Weight (lbs.)	Max Fuse*	Filter** Sizes
AUD1A040A9241A	2	32,000	80.0	4	Silicon Nitride	40 x 14 ¹ / ₂ x 28	119	15	17 x 25 x 1
AUD1A040A9301A	2 ¹ / ₂	32,000	80.0	4	Silicon Nitride	40 x 14 ¹ / ₂ x 28	122	15	17 x 25 x 1
AUD1A060A9241A	2	47,000	80.0	4	Silicon Nitride	40 x 14 ¹ / ₂ x 28	124	15	17 x 25 x 1
AUD1A060A9361A	3	47,000	80.0	4	Silicon Nitride	40 x 14 ¹ / ₂ x 28	127	15	17 x 25 x 1
AUD1B060A9361A	3	47,000	80.0	4	Silicon Nitride	40 x 17 ¹ / ₂ x 28	132	15	17 x 25 x 1
AUD1B080A9241A	2	64,000	80.0	4	Silicon Nitride	40 x 17 ¹ / ₂ x 28	139	15	17 x 25 x 1
AUD1B080A9361A	3	63,000	80.0	4	Silicon Nitride	40 x 17 ¹ / ₂ x 28	142	15	17 x 25 x 1
AUD1B080A9481A	4	64,000	80.0	4	Silicon Nitride	40 x 17 ¹ / ₂ x 28	142	15	17 x 25 x 1
AUD1C080A9601A	5	64,000	80.0	4	Silicon Nitride	40 x 21 x 28	154	20	20 x 25 x 1
AUD1B100A9361A	3	79,000	80.0	4	Silicon Nitride	40 x 17 ¹ / ₂ x 28	151	15	17 x 25 x 1
AUD1B100A9451A	4	80,000	80.0	4	Silicon Nitride	40 x 17 ¹ / ₂ x 28	153	15	17 x 25 x 1
AUD1C100A9481A	4	79,000	80.0	4	Silicon Nitride	40 x 21 x 28	162	15	20 x 25 x 1
AUD1C100A9601A	5	79,000	80.0	4	Silicon Nitride	40 x 21 x 28	162	20	20 x 25 x 1
AUD1D100A9721A	6	80,000	80.0	4	Silicon Nitride	40 x 24 ¹ / ₂ x 28	175	20	24 x 25 x 1
AUD1C120A9541A	5	96,000	80.0	4	Silicon Nitride	40 x 21 x 28	176	20	20 x 25 x 1
AUD1D120A9601A	5	96,000	80.0	4	Silicon Nitride	40 x 24 ¹ / ₂ x 28	186	20	24 x 25 x 1
AUD1D140A9601A	5	111,000	80.0	4	Silicon Nitride	40 x 24 ¹ / ₂ x 28	193	20	24 x 25 x 1

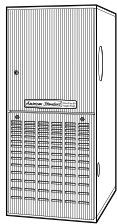

Silver SI+

Table FUR-11-D — Downflow/Horizontal Left or Right Induced Draft Gas Furnace (115/1/60)

Unit Model No.	Airflow In Tons	Nominal Output (Btuh)	AFUE	Flue Size (in.)	Ignition Device	Uncrated Dimensions (in.) H x W x D	Shipping Weight (lbs.)	Max Fuse*	Filter** Sizes
ADD1A060A9241A	2	48,000	80.0	4	Silicon Nitride	40 x 14 ¹ / ₂ x 28	129	15	(2) 14 x 20 x 1
ADD1A060A9361A	3	48,000	80.0	4	Silicon Nitride	40 x 14 ¹ / ₂ x 28	129	15	(2) 14 x 20 x 1
ADD1B060A9361A	3	48,000	80.0	4	Silicon Nitride	40 x 17 ¹ / ₂ x 28	134	15	(2) 14 x 20 x 1
ADD1B080A9361A	3	64,000	80.0	4	Silicon Nitride	40 x 17 ¹ / ₂ x 28	146	15	(2) 14 x 20 x 1
ADD1B080A9451A	4	64,000	80.0	4	Silicon Nitride	40 x 17 ¹ / ₂ x 28	146	15	(2) 14 x 20 x 1
ADD1B100A9451A	4	80,000	80.0	4	Silicon Nitride	40 x 17 ¹ / ₂ x 28	156	15	(2) 14 x 20 x 1
ADD1C100A9481A	4	80,000	80.0	4	Silicon Nitride	40 x 21 x 28	166	15	(2) 16 x 20 x 1
ADD1C100A9541A	5	81,000	80.0	4	Silicon Nitride	40 x 21 x 28	167	20	(2) 16 x 20 x 1
ADD1C120A9541A	5	96,000	80.0	4	Silicon Nitride	40 x 21 x 28	177	20	(2) 16 x 20 x 1
ADD1D120A9601A	5	96,000	80.0	4	Silicon Nitride	40 x 24 ¹ / ₂ x 28	189	20	(2) 16 x 20 x 1
ADD1D140A9601A	5	113,000	80.0	4	Silicon Nitride	40 x 24 ¹ / ₂ x 28	196	20	(2) 16 x 20 x 1

* Information subject to change. Please confirm with current Product Data/Service Facts for current factory production.

** Filters are not shipped with furnace.

Furnaces

Silver SI – Single Stage



Silver SI

Table FUR-12-A — Upflow/Horizontal Left or Right Induced Draft Gas Furnace (115/1/60)

Unit Model No.	Airflow In Tons	Nominal Output (Btuh)	AFUE	Flue Size (in.)	Ignition Device	Uncrated Dimensions (in.) H x W x D	Shipping Weight (lbs.)	Max Fuse*	Filter** Sizes
AUE1A040A9241A	2	31,000	80.0	4	Silicon Nitride	40 x 14 ¹ / ₂ x 28	119	15	16 x 25 x 1
AUE1A060A9241A	2	47,000	80.0	4	Silicon Nitride	40 x 14 ¹ / ₂ x 28	124	15	16 x 25 x 1
AUE1A060A9361A	3	47,000	80.0	4	Silicon Nitride	40 x 14 ¹ / ₂ x 28	127	15	16 x 25 x 1
AUE1B060A9361A	3	47,000	80.0	4	Silicon Nitride	40 x 17 ¹ / ₂ x 28	132	15	17 x 25 x 1
AUE1B080A9361A	3	63,000	80.0	4	Silicon Nitride	40 x 17 ¹ / ₂ x 28	142	15	17 x 25 x 1
AUE1B080A9481A	4	64,000	80.0	4	Silicon Nitride	40 x 17 ¹ / ₂ x 28	142	15	17 x 25 x 1
AUE1B100A9361A	3	79,000	80.0	4	Silicon Nitride	40 x 17 ¹ / ₂ x 28	151	15	17 x 25 x 1
AUE1C100A9481A	4	79,000	80.0	4	Silicon Nitride	40 x 21 x 28	162	15	20 x 25 x 1
AUE1C100A9601A	5	79,000	80.0	4	Silicon Nitride	40 x 21 x 28	162	20	20 x 25 x 1
AUE1D120A9601A	5	96,000	80.0	4	Silicon Nitride	40 x 24 ¹ / ₂ x 28	186	20	24 x 25 x 1
AUE1D140A9601A	5	111,000	80.0	4	Silicon Nitride	40 x 24 ¹ / ₂ x 28	193	20	24 x 25 x 1

Table FUR-12-B — Downflow/Horizontal Left or Right Induced Draft Gas Furnace (115/1/60)

Unit Model No.	Airflow In Tons	Nominal Output (Btuh)	AFUE	Flue Size (in.)	Ignition Device	Uncrated Dimensions (in.) H x W x D	Shipping Weight (lbs.)	Max Fuse*	Filter** Sizes
ADE1A060A9361A	3	48,000	80.0	4	Silicon Nitride	40 x 14 ¹ / ₂ x 28	129	15 (2)	14 x 20 x 1
ADE1B060A9361A	3	48,000	80.0	4	Silicon Nitride	40 x 17 ¹ / ₂ x 28	134	15 (2)	14 x 20 x 1
ADE1B080A9451A	4	64,000	80.0	4	Silicon Nitride	40 x 17 ¹ / ₂ x 28	146	15 (2)	14 x 20 x 1
ADE1B100A9451A	4	80,000	80.0	4	Silicon Nitride	40 x 17 ¹ / ₂ x 28	156	15 (2)	14 x 20 x 1
ADE1C100A9601A	5	81,000	80.0	4	Silicon Nitride	40 x 21 x 28	167	20 (2)	16 x 20 x 1
ADE1D120A9601A	5	96,000	80.0	4	Silicon Nitride	40 x 24 ¹ / ₂ x 28	189	20 (2)	16 x 20 x 1

* Information subject to change. Please confirm with current Product Data/Service Facts for current factory production.

** Filters are not shipped with furnace.

Platinum SV, Gold SV, Gold SM, Silver XI, Silver SI+, and Silver SI Convertible Gas Furnaces

	AUD2-ACV/ ADD2-ACV 2 Stage 1 or 2 Pipe ②	AUD2-9V ADD2-9V 2 Stage ②	AUD2/ ADD2 2 Stage	AUD1-H/ ADD1-H 1 Stage High Efficiency	AUD1/ ADD1 1 Stage	AUE1/ ADE1 1 Stage
Table FUR-13-A — Features						
• Comfort-R™ enhanced mode (cooling).....	✓	✓	—	—	—	—
• AccuLink™ system.....	✓	—	—	—	—	—
• Can be connected in communicating or 24V non-communicating modes.....	✓	—	—	—	—	—
• User interface for system configuration - Easy to use navigation buttons and plain text for clear description of features.....	✓	—	—	—	—	—
• Adjustable heating fan off timing.....	✓	✓	✓	✓	✓	✓
• Alternate bottom/left/right return air (upflow models only).....	✓	✓	✓	✓	✓	✓
• Attractive color accents.....	✓	✓	✓	✓	✓	✓
• Blower door safety switch.....	✓	✓	✓	✓	✓	✓
• Bottom Panel (upflow models only).....	✓	✓	✓	✓	✓	✓
• Cleanable/reusable high velocity filters.....	✓	✓	✓	✓	✓	✓
• Common vent capability.....	✓	✓	✓	✓	✓	✓
• Complete front service access.....	✓	✓	✓	✓	✓	✓
• Direct drive, multi-speed (PSC) blower motor.....	—	—	✓	—	✓	✓
• Direct drive, multi-speed ECM blower motor (high efficiency)*.....	—	—	—	✓	—	—
• Direct drive, variable speed ECM blower motor**.....	✓	✓	—	—	—	—
• Gasketed blower door.....	✓	✓	✓	✓	✓	✓
• Heavy gauge reinforced wrap-around steel cabinet.....	✓	✓	✓	✓	✓	✓
• Horizontal left/right without conversion required.....	✓	✓	✓	✓	✓	✓
• Humidifier/EAC hook-up capability.....	✓	✓	✓	✓	✓	✓
• Inner blower door panel (downflow models only).....	✓	✓	✓	✓	✓	✓
• Insulated blower compartment 4 sides (upflow models only).....	✓	✓	✓	✓	✓	✓
• Integrated solid state control w/self diagnostics.....	✓	✓	✓	✓	✓	✓
• Left/right gas connection.....	✓	✓	✓	✓	✓	✓
• Manual reset flame roll out switches.....	✓	✓	✓	✓	✓	✓
• Masonry Chimney Venting w/BAYVENT800B.....	✓	✓	✓	✓	✓	✓
• Multi-port in shot burners.....	✓	✓	✓	✓	✓	✓
• Painted cabinet single color.....	—	—	—	—	—	—
• Perfect fit door latches (upflow models only).....	✓	✓	✓	✓	✓	✓
• Right or left hand side knock out for venting (downflow models only).....	✓	✓	✓	✓	✓	✓
• Selectable cooling fan off delay eliminates need for time delay relay BAY24X045.....	③	✓	✓	✓	✓	✓
• Service diagnostic capabilities.....	✓	✓	✓	✓	✓	✓
• Service diagnostics with faults reported at the user interface.....	✓	—	—	—	—	—
• Side return starter tabs (upflow models only).....	✓	✓	✓	✓	✓	✓
• Silicon Nitride hot surface igniter with adaptive heat up.....	✓	✓	✓	✓	✓	✓
• Single door filter access.....	✓	✓	✓	✓	✓	✓
• Single wire twinning.....	—	—	—	—	—	—
• Slide out blower assembly.....	✓	✓	✓	✓	✓	✓
• 3-way vent option on downflow models (top, right or left) (downflow models only).....	—	✓	✓	✓	✓	✓
• 20 gauge aluminized steel heat exchanger.....	✓	✓	✓	✓	✓	✓
• 24 volt secondary fuse.....	—	✓	✓	✓	✓	✓
• Multiple heating blower speeds.....	✓	✓	✓	—	—	—
• Two speed venter motor.....	✓	✓	✓	—	—	—
• Two tone color.....	✓	✓	✓	✓	✓	✓
• Two-stage gas valve.....	✓	✓	✓	—	—	—
• Registered limited lifetime heat exchanger warranty and 10-year on all other functional parts (Residential Use)①	✓	✓	—	—	—	—
• Registered 20-year heat exchanger limited warranty and 10-year on all other functional parts (Residential Use)	—	—	✓	✓	✓	✓
• Optional extended warranties available	✓	✓	✓	✓	✓	✓

① Registered Limited Warranty terms are available when you register within 60 days of installation. You can register online at americanstandardair.com or by phone at 800-554-8005; otherwise American Standard Heating & Air Conditioning's Base Limited Warranty terms will apply. Base Limited Warranty information on specific products can be found on ASDealerNet.com.

② Variable Speed

③ Selectable through thermostat

Note: Variable speed furnaces should not be twinned and are not approved for twinning applications.

*Constant torque ECM (electronically commutated motor).

**Constant airflow ECM (electronically commutated motor).

Platinum SV, Gold SV, Gold SM, Silver XI, Silver SI+, and Silver SI Convertible Gas Furnaces

Table FUR-14-A — Optional Accessories

Model Number	Description	Shipping Weight	AUD2-ACV/ADD2-ACV 2 Stage Variable Speed	AUD2-9V/ ADD2-9V 2-Stg. Variable Speed
BAYBASE205	Downflow subbase for downflow models only	8	✓	✓
BAYFLTR200	Side Filter Rack (External)	5	✓	✓
BAYFLTR203	Filter kit horiz conversion for 17.5" cabinet	3	✓	✓
BAYFLTR204	Filter kit horiz conversion for 21" cabinet	3	✓	✓
BAYFLTR205	Filter kit horiz conversion or 24.5" cabinet	3	✓	✓
BAYFLTR206	Filter Access Door Kit	2	✓	✓
BAYFLTR321 ^①	Cleanable filter for 21" cabinet upflow only	2	✓	✓
BAYFLTR324 ^①	Cleanable filter for 24.5" cabinet upflow only	2	✓	✓
BAYLPKT210B	Propane conversion kit	1	✓	✓
BAYLPSS210B	LP Kit with Stainless Steel Burners	1	✓	✓
BAYRACK960A ^②	Filter Rack Kit for upflow models only (internal)	5	✓	✓
BAYVENT800B	Masonry chimney vent kit	2	✓	✓

^① Contains one (1) high velocity filter.

^② Internal filter rack for side or bottom return air. Includes 17 x 25" cleanable filter for use in side return applications. Bottom return applications require different sizes of filters which are not included. Airflow requirements over 1800 CFM require filters on both sides or a side and bottom or bottom only.

Table FUR-14-B — Optional Accessories

Model Number	Description	Shipping Weight	AUD2/ADD2 2 Stage	AUD1-H/ADD1-H 1 Stage High Efficiency	AUD1/ADD1 1 Stage	AUE1/ADE1 1 Stage
BAYBASE205	Downflow subbase for downflow models only	8	✓	✓	✓	✓
BAYFLTR200	Side Filter Rack (External)	5	✓	✓	✓	—
BAYFLTR203	Filter kit horiz conversion for 17.5" cabinet	3	✓	✓	✓	✓
BAYFLTR204	Filter kit horiz conversion for 21" cabinet	3	✓	✓	✓	✓
BAYFLTR205	Filter kit horiz conversion or 24.5" cabinet	3	✓	✓	✓	✓
BAYFLTR206	Filter Access Door Kit	2	✓	✓	✓	✓
BAYFLTR317 ^①	Cleanable filter for 14.5" and 17.5" cabinet upflow only	2	✓	✓	✓	✓
BAYFLTR321 ^①	Cleanable filter for 21" cabinet upflow only	2	✓	✓	✓	✓
BAYFLTR324 ^①	Cleanable filter for 24.5" cabinet upflow only	2	✓	✓	✓	✓
BAYLPKT210B	Propane conversion kit	1	✓	✓	✓	✓
BAYLPSS210B	LP Kit with Stainless Steel Burners	1	✓	✓	✓	✓
BAYRACK960A ^②	Filter Rack Kit for upflow models only (internal)	5	✓	✓	✓	✓
BAYVENT800B	Masonry chimney vent kit	2	✓	✓	✓	✓

^① Contains one (1) high velocity filter.

^② Internal filter rack for side or bottom return air. Includes 17 x 25" cleanable filter for use in side return applications. Bottom return applications require different sizes of filters which are not included. Airflow requirements over 1800 CFM require filters on both sides or a side and bottom or bottom only.

Note: Variable speed furnaces should not be twinned and are not approved for twinning applications.

Special Use Furnace Accessories

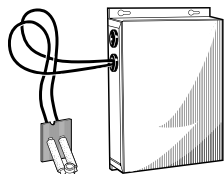

Bonnet Switch TAYPLUS103A

Table FUR-14-C — High Altitude Pressure Switch 80%

Model Number	Description	Used With	Shipping Weight
BAYHALT248	1 Switch	AUD1,ADD1,AUE1,ADE1	2
BAYHALT249	1 Switch	AUD-R-K,ADD-R-F,AUD2,ADD2	2

Table FUR-14-D — Dual Fuel Heat Pump Control Kit^{①②}

Model Number	Case Height	Used With
TAYPLUS103A	Heat Pump Control Kit	Gas, LP, Oil and Electric Furnaces
TAYSTAT250B	Outdoor Thermostat	TAYPLUS103A for Restricted Mode

^① Factory wired for non-restricted mode, can be wired for restricted mode.

^② Applicable for all furnaces with 35 VA or larger low voltage transformer (separate high voltage power not required).

Ordering Information

Variable and Non-Variable Speed High Efficiency Oil Furnaces

American Standard Oil Furnaces are available directly from Thermo Products.

For availability and all technical, sales, and warranty support, contact Thermo Products Customer Service at 800-348-5130



AccuClean™ Whole Home Air Cleaner

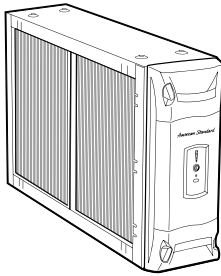

AccuClean™ Whole Home Air Cleaner:

- **AccuClean™** removes up to 99.98% of allergens from the filtered air
- Removes particles down to .1 micron in size
- Outperforms HEPA, and up to 100 times more effective than a standard 1" filter
- Constructed of heavy 18 gage metal to protect the filter and internal electronics
- Power door provides easy access to internal components and features a filter status display as well as safety interlocks that automatically shut down the power when the door is opened for maintenance or cleaning
- Designed for flush fit on both sides and rear of equipment cabinet
- No transitions required on **AccuClean™** applications
- Gaskets included with the air cleaner
- **AccuLink™** communicating or 24 volt capability
- **Base Limited Warranty 5-years**
- **Registered Limited Warranty 10-years**

Table IAQ-1-A – Air Handler – 24 Volt AccuClean™ Whole Home Air Cleaner

Model Number	Airflow Range	AccuClean™ Air Handler Width	Uncrated Dimensions(in.) H x W x D	Shipping Weight
AFD175CLAH000E	300-1200	17½ inch	7½ x 17½ x 21	37
AFD215CLAH000E	300-1200	21½ inch	7½ x 21½ x 21	42
AFD235CLAH000E	350-1600	23½ inch	7½ x 23½ x 21	44
AFD260CLAH000E	400-2000	26 inch	7½ x 26 x 21	46

Table IAQ-1-B – Upflow / Side Return Furnace – 24 Volt AccuClean™ Whole Home

Model Number	Airflow Range	AccuClean™ Furnace Width	Uncrated Dimensions(in.) H x W x D	Shipping Weight
AFD145CLFR000E	300-1200	14½ inch ^①	7½ x 14½ x 27	39
AFD175CLFR000E	300-1600	17½ inch ^①	7½ x 17½ x 27	43
AFD210CLFR000E	300-2000	21 inch ^②	7½ x 21 x 27	47
AFD245CLFR000E	400-2000	24½ inch ^②	7½ x 24½ x 27	49

Table IAQ-1-C – Downflow Furnace – 24 Volt AccuClean™ Whole Home

Model Number	Airflow Range	AccuClean™ Furnace Width	Uncrated Dimensions(in.) H x W x D	Shipping Weight
AFD14DCLFR000E	300-1200	14½ inch	7½ x 14½ x 21	33
AFD17DCLFR000E	300-1600	17½ inch	7½ x 17½ x 21	37
AFD21DCLFR000E	300-2000	21 inch	7½ x 21 x 21	41
AFD24DCLFR000E	400-2000	24½ inch	7½ x 24½ x 21	45

Table IAQ-1-D — Accessories – AccuClean™ Whole Home

Model Number	Description	Used With	Shipping Weight
BAYTRANS12024	120 to 24 Volt Transformer	All AFD Air Cleaners	6

① Side return no transition required.

② Side return transition required.

Perfect Fit™ Media Filters

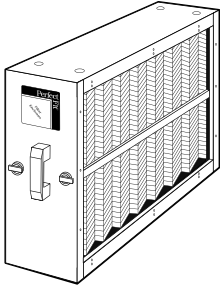

- Four sizes to flush fit bottom of American Standard furnaces
- TFM175 (17½") bottom return model can be used for a **Perfect Fit™** side return on all furnace models
- Air Cleaners designed for flush fit on both sides and rear of equipment cabinet
- All service and access is from the front of the air cleaner
- **Air-Tite™** Door construction eliminates air leaks, improves air quality and keeps operating costs low
- Gaskets included with the air cleaner

Table IAQ-2-A– Air Handler Perfect Fit™ High Efficiency Air Cleaner With Five (5) Inch Expandable Media Filter

Model Number	Airflow Range	Perfect Fit™ Air Handler Width	Uncrated Dimensions(in.) H x W x D	Shipping Weight	Return Air Opening ^③
TFM215B0AH0	300-1400	21½ inch	7½ x 21½ x 21	22	18⅞ x 18⅞
TFM235B0AH0	300-1700	23½ inch	7½ x 23½ x 21	24	20⅞ x 18⅞
TFM260B0AH0	400-2100	26 inch	7½ x 26 x 21	25	23⅞ x 18⅞

Table IAQ-2-B – Furnace Perfect Fit™ High Efficiency Air Cleaner With Five (5) Inch Expandable Media Filter

Model Number	Airflow Range	Perfect Fit™ Furnace Width	Uncrated Dimensions(in.) H x W x D	Shipping Weight	Return Air Opening ^③
TFM145B0FR0	300-1200	14½ inch ^①	7½ x 14½ x 27	18	11⅞ x 24 ¹³ / ₁₆
TFM175B0FR0	300-1500	17½ inch ^①	7½ x 17½ x 27	21	14⅞ x 24 ¹³ / ₁₆
TFM210B0FR0	300-2000	21 inch ^②	7½ x 21 x 27	24	18 ³ / ₈ x 24 ¹³ / ₁₆
TFM245B0FR0	400-2000	24½ inch ^②	7½ x 24½ x 27	27	21⅞ x 24 ¹³ / ₁₆

Table IAQ-2-C – Downflow Furnace Perfect Fit™ High Efficiency Air Cleaner With Five (5) Inch Cartridge Media Filter

Model Number	Airflow Range	Perfect Fit™ Furnace Width	Uncrated Dimensions(in.) H x W x D	Shipping Weight	Return Air Opening ^③
TFM14DA0FR0	300-1200	14½ inch	7½ x 14½ x 21	17	11⅞ x 18⅞
TFM17DA0FR0	300-1500	17½ inch	7½ x 17½ x 21	19	14⅞ x 18⅞
TFM21DA0FR0	300-2000	21 inch	7½ x 21 x 21	22	18 ³ / ₈ x 18⅞
TFM24DA0FR0	400-2000	24½ inch	7½ x 24½ x 21	24	21⅞ x 18⅞

- ① Side return no transition required.
 ② Side return transition required.
 ③ Actual opening does not include flange.

Table IAQ-3-A — Furnace Cartridge Media

Model			Enclosure	Shipping
Number	Description	Qty	Used with	Weight
BAYFTFR14M2	5" Media Filter	2 / Box	14 1/2	5
BAYFTFR17M2	5" Media Filter	2 / Box	17 1/2	5
BAYFTFR21M2	5" Media Filter	2 / Box	21	5
BAYFTFR24M2	5" Media Filter	2 / Box	24 1/2	6
BAYFTFREXM2	Expandable 5" Cartridge Media Filter	2 / Box	14 1/2 - 24 1/2 x 21	5

Table IAQ-3-B — Air Handler Cartridge Media

Model			Enclosure	Shipping
Number	Description	Qty	Used with	Weight
BAYFTA21M2	5" Media Filter	2 / Box	21 1/2	5
BAYFTA23M2	5" Media Filter	2 / Box	23 1/2	5
BAYFTA26M2	5" Media Filter	2 / Box	26	6
BAYFTAHEXM2	Expandable 5" Cartridge Media Filter	2 / Box	21 1/2-26 x 27	5

Table IAQ-3-C — Downflow Cartridge Media

Model			Enclosure	Shipping
Number	Description	Qty	Used with	Weight
BAYFTDN14M2	5" Downflow Media Filter	2 / Box	14 D	5
BAYFTDN17M2	5" Downflow Media Filter	2 / Box	17 D	5
BAYFTDN21M2	5" Downflow Media Filter	2 / Box	21 D	5
BAYFTDN24M2	5" Downflow Media Filter	2 / Box	24 D	5

Table IAQ-3-D — Furnace Frames

Model			Enclosure	Shipping
Number	Description	Qty	Used with	Weight
BAYFRAME145①	Expandable Media Filter	1 / Box	14 1/2	5
BAYFRAME175①	Expandable Media Filter	1 / Box	17 1/2	5
BAYFRAME210①	Expandable Media Filter	1 / Box	21	5
BAYFRAME245①	Expandable Media Filter	1 / Box	24 1/2	5

Table IAQ-3-E — Air Handler Frames

Model			Enclosure	Shipping
Number	Description	Qty	Used with	Weight
BAYFRAME215①	Expandable Media Frame	1 / Box	21	5
BAYFRAME235①	Expandable Media Frame	1 / Box	23 1/2	5
BAYFRAME260①	Expandable Media Frame	1 / Box	26	5

① Includes one filter.

Table IAQ-4-A — Air Handler Filters

AIR HANDLER MODEL NUMBER		
ifD Filter	A	B
AFD215CLAH000D	21½	19
AFD235CLAH000D	23½	21
AFD260CLAH000D	26	23½

OUTLINE DRAWING AIR HANDLER MODELS

21" CABINET DEPTH ONLY
ADD DOOR DEPTH FOR TOTAL

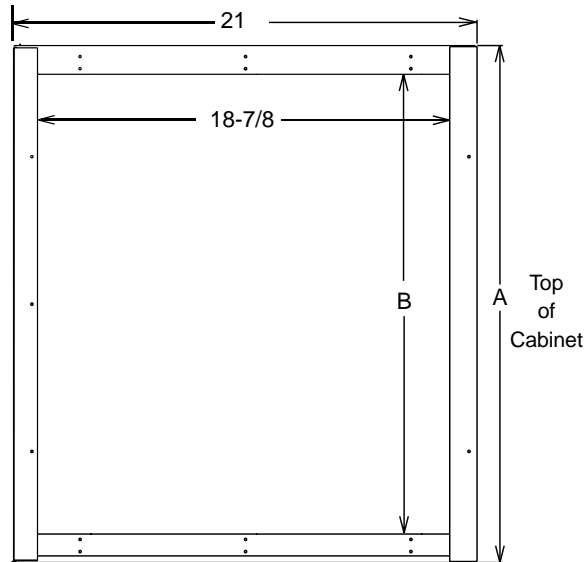
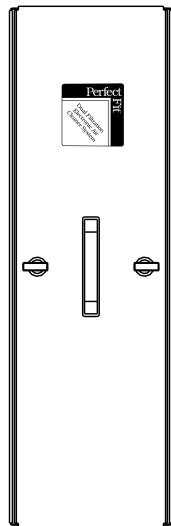
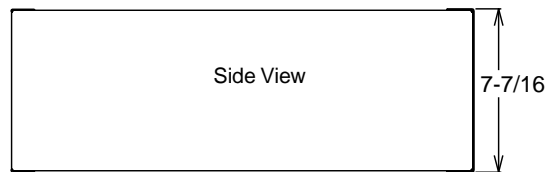
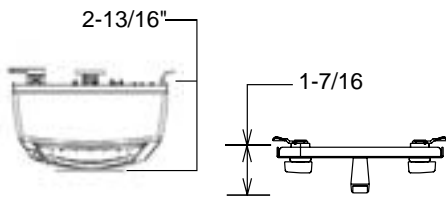

AccuClean™

1" PLEATED
5" MEDIA

Indoor Air Quality

AccuClean™ Filters

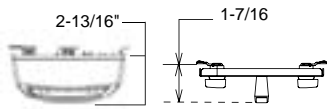

Table IAQ-5-A — Upflow Furnace Filters

FURNACE MODEL NUMBER		
ifD Filter	A	B
AFD145CLFR000D	14½	12
AFD175CLFR000D	17½	15
AFD210CLFR000D	21	18½
AFD245CLFR000D	24½	22

Table IAQ-5-B — Downflow Furnace Filters

FURNACE MODEL NUMBER		
ifD Filter	A	B
AFD14DCLFR000D	14½	11⅞
AFD17DCLFR000D	17½	14⅞
AFD21DCLFR000D	21	18⅞
AFD24DCLFR000D	24½	21⅞

**OUTLINE DRAWING
DOWNFLOW FURNACE MODELS**

21" CABINET DEPTH ONLY
ADD DOOR DEPTH FOR TOTAL

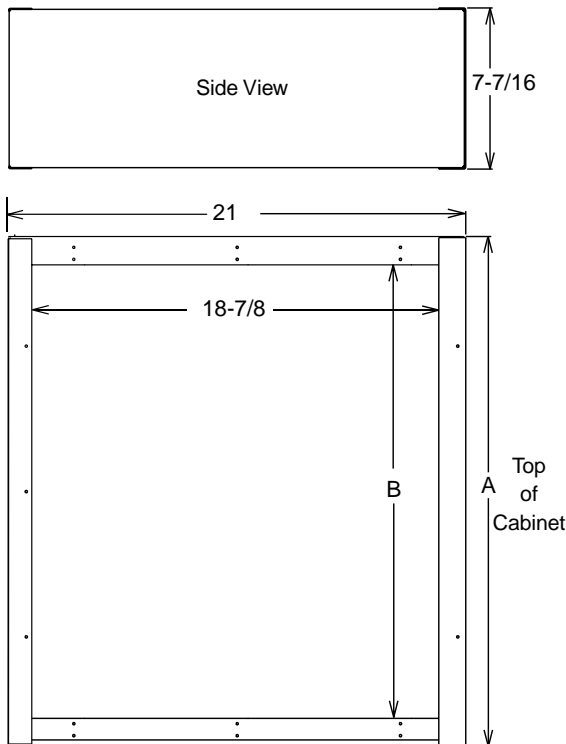

OUTLINE DRAWING UPFLOW FURNACE MODELS

27" CABINET DEPTH ONLY
ADD DOOR DEPTH FOR TOTAL

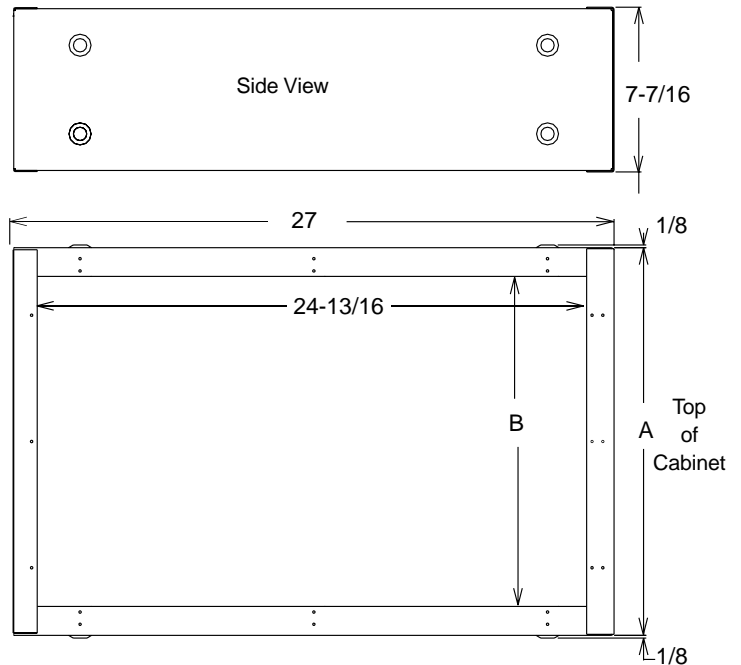

Indoor Air Quality

Humidifiers Fan Powered and Bypass

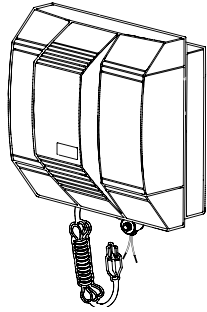

AHUMD500A

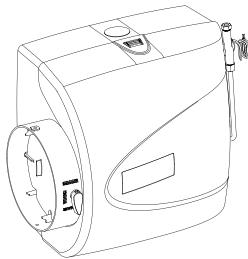

AHUMD200A, 300A

AHUMD500A

- Flow Through Fan Powered Humidifier
- High Performance Humidifier Delivers up to 18 Gallons per Day
- Automatic Humidifier Control with O.D. Sensor for up to 50% more Humidity
- Front Cover Access for easy replacement of humidifier pad
- Aluminum Humidifier Pad Treated with Ceramic Coating for Enhanced Pad Performance
- Reliable Brass Solenoid Valve w/Stainless Steel Valve Seat
- UV Resistant Cabinet and Scale Control Insert
- Saddle Valve
- Polyslate Gray Housing matches Furnace Cabinet Color
- Decorative nameplate
- 120V Power Line Cord
- 110V Primary/24A Transformer

AHUMD200, 300A

- AHUMD300A Bypass delivers up to 17 Gallons per day
- AHUMD200A delivers up to 12 Gallons per day
- AHUMD300A Automatic Humidifier Control and O.D. Sensor for up to 50% more Humidity
- AHUMD200A Manual Humidifier Control
- UV Resistant Cabinet and Scale Control Insert
- Front Cover Access for easy replacement of humidifier pad
- Aluminum Humidifier Pad Treated with Ceramic Coating for Enhanced Pad Performance
- Reliable Brass Solenoid Valve w/Stainless Steel Valve Seat
- Field Convertible Duct Connection, Left or Right Side
- Built in Summer / Winter Damper
- Saddle Valve
- Polyslate Gray Housing matches Furnace Cabinet Color
- Decorative nameplate
- 110V Primary/24V Secondary, 10VA Transformer

Table IAQ-6-A — Specifications: Humidifier with Humidistat

Model Number	Description	Used With	Mfg. Plant	Shipping Weight
AHUMD500APA00C ^{①④}	Fan Powered Humidifier	All Furnace Models	TY	20
AHUMD300ABA00B ^②	Large Bypass Humidifier	All Furnace Models	TY	15
AHUMD200ABM00B ^③	Small Bypass Humidifier	All Furnace Models	TY	14

- ① Includes Automatic Humidifier Control (Duct Mount Only).
 ② Includes Automatic Humidifier Control (Duct Mount Only) and 120/24V transformer.
 ③ Includes Manual Humidifier Control and 120/24V transformer.
 ④ Not applicable for horizontal installations.

Table IAQ-6-B — Accessories

Model Number	Description	Used With	Mfg. Plant	Shipping Weight
BAYPAD02A1310A	Large Humidifier Pad 13"x10"	AHUMD500,300A	TY	1
BAYPAD01A1010A	Small Humidifier Pad 9-7/8"x9-5/8"	AHUMD200A	TY	1
ACONTH01AAUTOA	Automatic Humidifier Control	AHUMD200A	TY	1
BAYRLY10ASENSA	Current Sensing Relay	All	TY	1
BAYPLT01AMHCOA	Adapter Plate (Duct Mount)	Manual Humidifier Control	TY	1

Humidifiers Fan Powered and Bypass

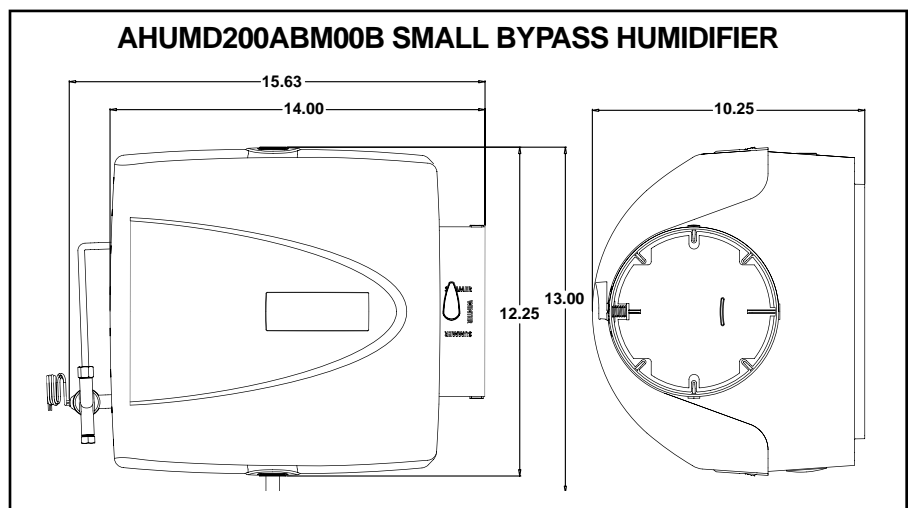
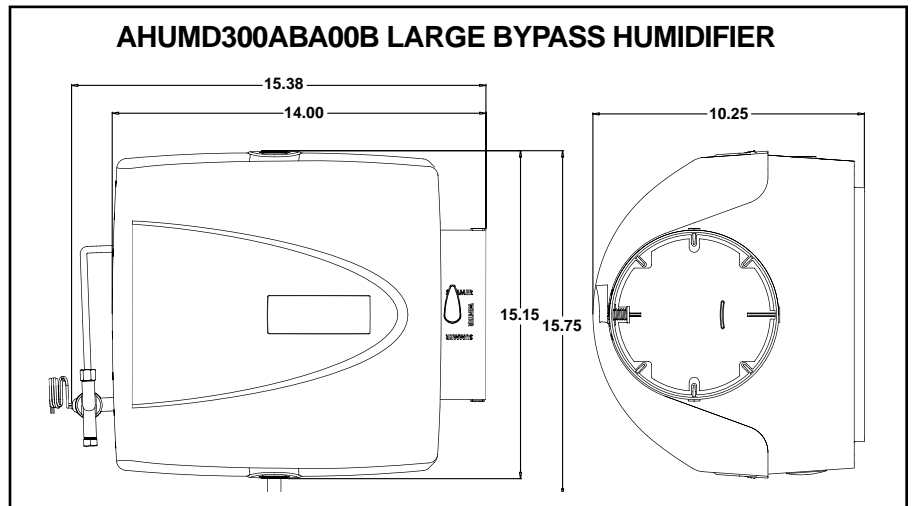
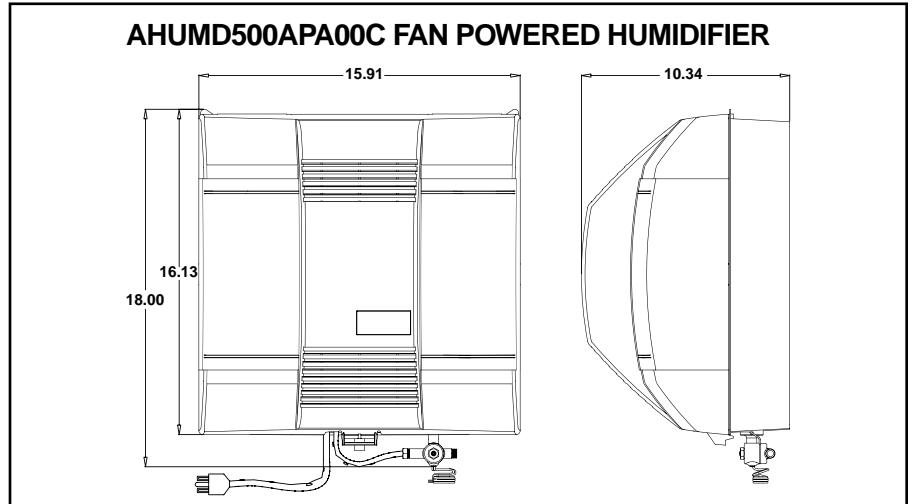

Indoor Air Quality

Humidifiers Fan Powered and Bypass

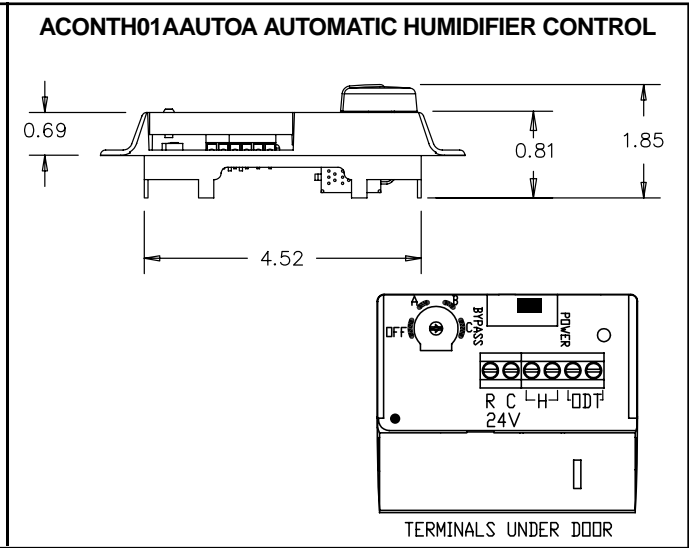
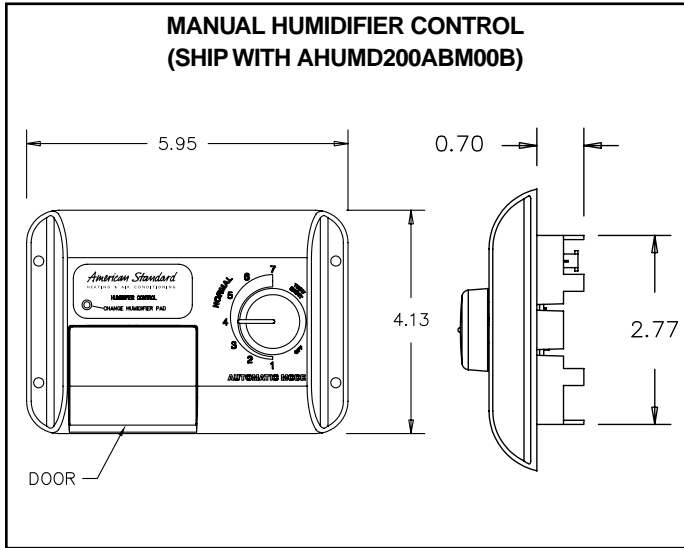

SUGGESTED BYPASS HUMIDIFIER LOCATIONS

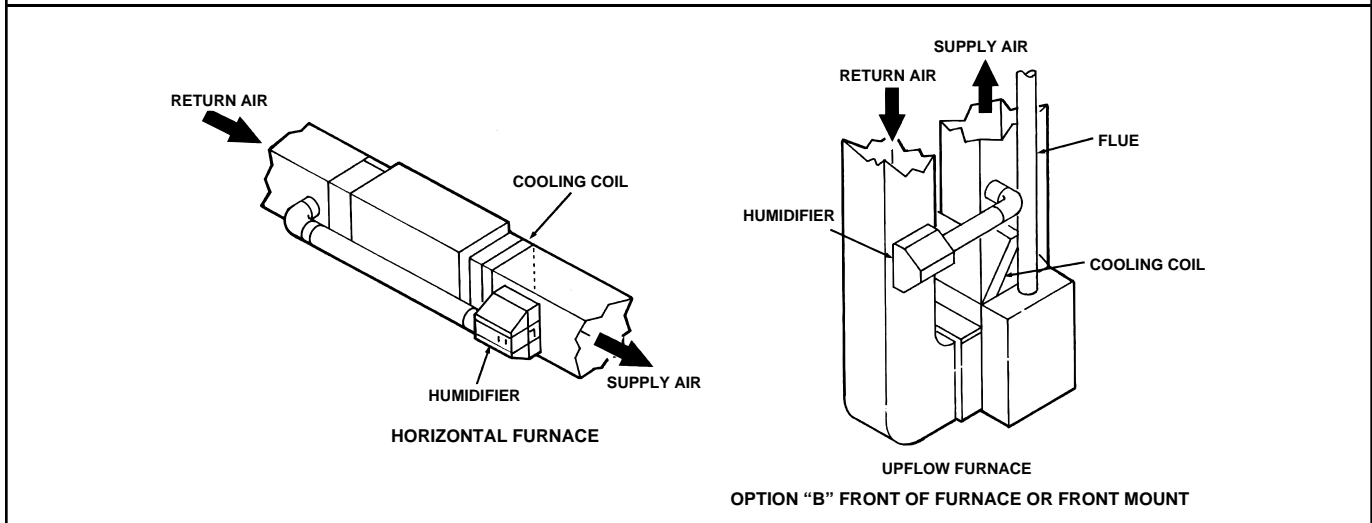
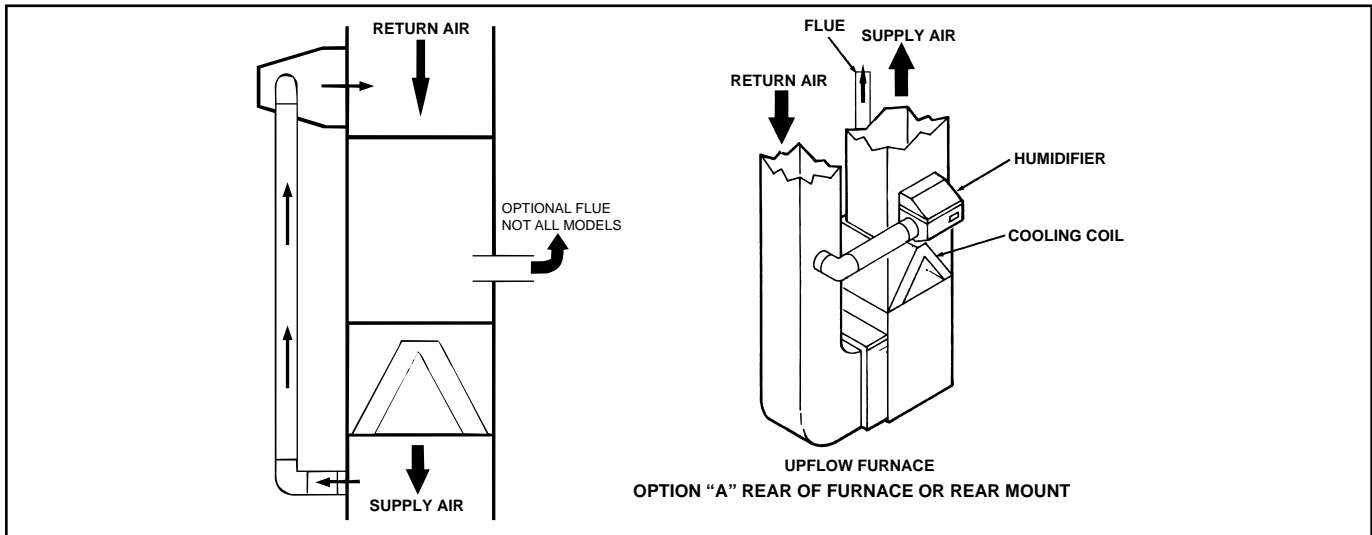

Indoor Air Quality

For complete equipment / combination selections, installation instructions and warranty information, please refer to Product Data/Ratings and/or Installers Guides and Limited Warranty Handbooks.

Energy Recovery Ventilator (ERV)

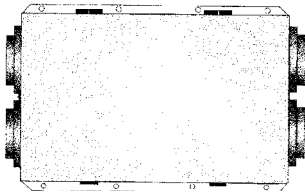

- American Standard ERV technology for all seasons and climates
- Static plate energy transfer core for efficient transfer of heat and moisture
- Passive defrost - condensate drain not required
- Balancing dampers not required
- Multi position mounting
- Percent Timer (PT) control included with ERV for simple, automatic operation
- Optional Push Button (PB) control connects to PT control
- Cam action door latches for quick service access
- Heavy gauge, powder painted steel cabinet
- Permanently lubricated motor bearings (ball bearings)
- 6" and 8" double collar duct connections for AERVR100 and 200
- 8" round compatible duct connection for AERVR300
- Closed cell foam gasketing for insulation integrity
- 1" duct board insulation with cleanable foil face
- May be installed in conditioned and unconditioned spaces
- Cabinet / Door color: American Standard Polyslate Gray / Tarpaulin Gray
- **Based Limited Warranty 5-years**
- **Registered Limited Warranty 10-years**
- **Optional extended warranty**

Table IAQ-9-A — Specifications: ERV

Model Number	Nominal Airflow (CFM)	Power Supply	Uncrated Dimensions (In.) H x W x D	Shipping Weight
AERVR100A9P00A ^①	130	120/1/60	20 ¹ / ₈ x 28 ³ / ₄ x 13	65
AERVR200A9P00A ^①	200	120/1/60	20 ¹ / ₈ x 28 ³ / ₄ x 23 ⁷ / ₈	85
AERVR300A9P00A ^①	300	120/1/60	20 ¹ / ₈ x 28 ³ / ₄ x 23 ⁷ / ₈	95

^① Percent Timer Control included with the ERV.

Table IAQ-9-B — Specifications: ERV

Model Number	Sensible Recovery Effectiveness(32°F)	Latent Recovery (32°F)	Total Recovery (95°F)
AERVR100A9P00A	72% @ 124 cfm	55% @ 124 cfm	46% @ 126 cfm
AERVR200A9P00A	78% @ 181 cfm	62% @ 181 cfm	52% @ 180 cfm
AERVR300A9P00A	70% @ 295 cfm	51% @ 295 cfm	43% @ 295 cfm

Table IAQ-9-C — Optional Accessories

Model Number	Description	Used With	Shipping Weight
ACONTV10APBC0A	Point of Use Push Button Control	ERV models 100, 200, 300	1
BAYFLT10A1010A	Filters - 2 per pack	ERV models 100	1
BAYFLT20A1020A	Filters - 2 per pack	ERV models 200, 300	1
BAYWHT10AVENTA ^②	6 inch White Vinyl Ventilation Hood	ERV models 100, 200	1
BAYBRN10AVENTA ^②	6 inch Brown Vinyl Ventilation Hood	ERV models 100, 200	1
BAYGLV10AVENTA ^②	8 inch Galvanized Ventilation Hood	ERV models 300	2

^② Qty 1.

Conventional 24 Volt Connected Controls

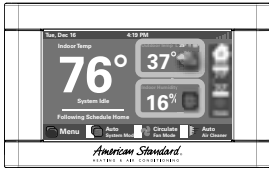

**GOLD XV
ACONT824AS52DA**



NEXIA
HOME INTELLIGENCE

**AVAILABLE
SOON**

ACONT824AS42DA

- NEXIA™ Home Intelligence "Z-Wave" Bridge Inside
 - Connect up to 230 Z-Wave devices
- WiFi (802.11 b/g/n) or Ethernet connection
- Control the Gold XV from a smartphone, tablet, or computer ^{1,2}
- 4.3" diagonal HD color touchscreen
- Compatible with non-communicating conventional 24 Volt systems
 - Cooling, heating, heat pump, and dual fuel
- 7 Day programmable with up to six schedules per day
- Five day weather forecast, weather radar, and weather alerts ¹
- Indoor relative humidity display
- Enhanced dehumidification
- 2 Auxiliary dry contacts
 - Control 2 of the following: Whole house humidifier, dehumidifier, or ventilation system
- Test modes and alert diagnostics
- Nexia Dealer Portal enabled
- Upgradeable software
- Silver color
- Limited Warranty: 5 yr. base/10 yr. registered

Application:

HVAC system compatibility:

- Conventional gas/electric, heat pump, and dual fuel systems
- Conventional boiler systems (forced air only)
- Conventional HVAC systems: 2 Heat / 2 cool
- Heat Pump systems: Up to 5 stages heat / 2 stages cool (2 compressor heat - 3 auxiliary heat / 2 cooling)
- Heat Pump switchover valve: Selectable "with cool or with heat"
- Remote Indoor Sensor (optional): ZZSENSAL0400AA
- Remote Outdoor Sensor (optional): BAYSEN01ATEMPA
- PWM Circuit (BK terminal): controls indoor unit variable speed blowers

Dimensions:

- Product: 5.43"w x 3.39"h x 1.30"d
- Display: 4.15"w x 2.65"h

ACONT624AS42DA

- NEXIA™ Home Intelligence compatible
- Z-wave comfort control
- Control the Silver XM from a smartphone, tablet, or computer^{1,2} (requires SK101 for remote connectivity)
- 4.3" diagonal black and white touchscreen
- Compatible with conventional 24 volt HVAC, heat pump, dual fuel, and conventional boiler systems (baseboard and radiator)
- 7 Day programmable with up to 4 schedules per day
- Humidity sensor and RH display
- Remote temperature sensor connections (1 indoor/1 outdoor)
- Auxiliary & compressor heat lockouts
- Auxiliary dry contact
- Enhanced dehumidification (cooling)
- Adjustable variable speed fan settings (pwm)
- Energy Savings Mode (ESM)
- Screen lock and guest lock
- Service test modes
- Upgradeable software
- Silver color
- Limited Warranty: 1 yr. base/5 yr. registered

Application:

HVAC system compatibility:

- Up to 4 Stages Heat/2 Stages Cool
- Conventional gas/electric, heat pump, and dual fuel systems
- Conventional boiler systems (baseboard & radiators)
- Remote Indoor Sensor (optional): ZZSENSAL0400AA
- Remote Outdoor Sensor (optional): BAYSEN01ATEMPA

Dimensions:

- Product: 5.9"w x 3.47"h x .95"d
- Display: 3.8"w x 2.3"h

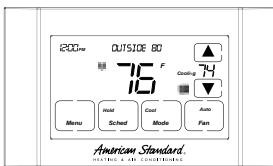

**SILVER XM
ACONT624AS42DA**



NEXIA
HOME INTELLIGENCE

For complete equipment / combination selections, installation instructions and warranty information, please refer to Product Data/Ratings and/or Installers Guides and Limited Warranty Handbooks.

¹ Requires high speed router, internet service, and connection to Nexia Home Intelligence.
² Nexia Home Intelligence monthly service fee is not required to connect up to 4 (total) of the following American Standard Heating & Air Conditioning brand connected controls: a) ACONT824; b) ACONT850; c) AZONE950; d) ACONT624. The monthly service is also included for up to 4 appliance modules, one per connected control.

AccuLink™ Communicating Connected Controls

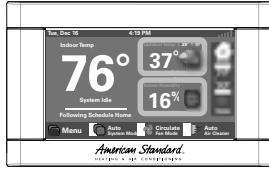

**PLATINUM XV
ACONT850AC52UA**



**AVAILABLE
SOON**

ACONT850AC52UA

- NEXIA™ Home Intelligence "Z-Wave" Bridge Inside
 - Connect up to 230 Z-Wave devices
- WiFi (802.11 b/g/n) or Ethernet connection
- Control the Platinum XV from a smartphone, tablet, or computer^{1,2}
- 4.3" diagonal HD color touchscreen
- Compatible with AccuLink™ communicating systems (variable speed and two stage)
- Compatible with conventional 24 Volt HVAC, heating, heat pump, and dual fuel systems used with accessory relay panel model BAY24VRPAC52DB
- 7 day programmable with up to six schedules per day
- Five day weather forecast, weather radar, and weather alerts¹
- Indoor relative humidity display
- Test modes and alert diagnostics
- Nexia Dealer Portal enabled
- Upgradeable software
- Silver color
- Limited Warranty: 5 yr. base/10 yr. registered

Application:

HVAC system compatibility:

- AccuLink™ communicating systems (variable speed and two stage)
- Conventional gas/electric, heat pump, dual fuel systems, or boiler systems (forced air only) with use of relay panel model BAY24VRPAC52DB. (Relay panel controls up to 5 stages heat, 2 stages cool, remote indoor and outdoor connections, humidifier, dehumidifier, and ventilation system auxiliary dry contacts)

Dimensions:

- Product: 5.43"w x 3.39"h x 1.30"d
- Display: 4.15"w x 2.65"h



**PLATINUM ZV
AZONE950AC52ZA**



TZONE950AC52ZA

- NEXIA™ Home Intelligence compatible
- WiFi (802.11 b/g/n)
- Control the Platinum ZV from a smartphone, tablet, or computer^{1,2}
- 7" diagonal HD color touchscreen
- Compatible with AccuLink™ communicating systems (variable speed and two stage)
- Compatible with conventional 24 Volt HVAC, heating, heat pump, and dual fuel systems used with accessory relay panel model BAY24VRPAC52DB
- 7 Day programmable with up to 6 schedules per day
- Five day weather forecast, weather radar, and weather alerts¹
- Indoor relative humidity display
- Control up to 3 accessory devices with relay panel model BAY24VRPAC52DB
 - Whole house humidifier, dehumidifier, or ventilation system
- Test modes and diagnostic screens
- Nexia Dealer Portal enabled
- Upgradeable software
- Silver color
- Limited Warranty: 5 yr. base/10 yr. registered

Application:

HVAC system compatibility:

- AccuLink™ communicating systems (variable speed and two stage)
- Conventional gas/electric, heat pump, dual fuel systems, or boiler systems (forced air only) with use of relay panel model BAY24VRPAC52DB. (Relay panel controls up to 5 stages heat, 2 stages cool, remote indoor and outdoor connections, humidifier, dehumidifier, and ventilation system auxiliary dry contacts)

Dimensions:

- Product: 7.3"w x 4.3"h x 1.2"d
- Display: 6.1"w x 3.6"h

¹ Requires high speed router, internet service, and connection to Nexia Home Intelligence.

² Nexia Home Intelligence monthly service fee is not required to connect up to 4 (total) of the following American Standard Heating & Air Conditioning brand connected controls: a) ACONT824; b) ACONT850; c) AZONE950; d) 624. The monthly service is also included for up to 4 appliance modules, one per connected control.

Zoning AccuLink™ Platinum ZV Control



AZONE950AC52ZA

Features:

- Controls Communicating or conventional 24V HVAC systems (5 heat/2 cool/Dual Fuel) with 24V Relay Panel Accessory
- 7" High Definition Color LCD Display
- Compatible with AccuLink™ Zoning Systems - software version 2.0 or later required
- Optional faceplate colors (black, white, graphite)
- System Modes - Heat/Cool/Auto
- Fan Modes - On/Auto/Circulate
- Easy to use Touch Screen Interface
- 7 Day Programmable - (manual or guided scheduling options)
- 1-Touch Pre-Sets for Home, Away, Sleep Settings
- Customizable Home Screen (Color, Information, Layout)
- 5 Day Weather Forecast, Local Radar Image & Weather Alerts (via Wireless Home Network)
- Weekly & Monthly System Run Time Monitor
- Allergy Clean & Quick Clean Indoor Air Cycles
- Built in Dual Fuel Economic Calculator.
- Digital Photo Album with Slide Show Screen Saver Option
- Embedded Diagnostics - (Alerts have time/date stamp with on screen probable causes)
- Heating Humidification Control
 - Relative Humidity Control
 - Dew Point Control
- Cooling Dehumidification Control
- Ventilation Control
- Whole-house Dehumidifier Control
- Smart Continuous Fan (disables Cont. Fan if RH is above setpoint)
- Adjustable Continuous Fan Airflow Settings (35 to 100%)
- Service Reminders - Filters, EAC, Humidifier, HVAC System, UV Lights
- Upgradeable Firmware
- Remote Access Option (for controlling the 950 Control only) is included with purchase. Remote access provided by Nexia Home Intelligence
- Keypad lock - Pin Code Option Security Options
- Dealer and System Information Screens
- Remote Indoor Sensor (optional): ZZSENSAL0400AA
- Remote Outdoor Sensor (optional): BAYSEN01ATEMPA
- Fahrenheit or Celsius Indoor Display Options
- 802.11 B/G - WLAN (wireless local area network) for weather feed

Dimensions:

- 7.3" width X 4.3" height X 1.2" depth

Storage Temperature:

- -40°F to 175°F, 5% to 95% RH non-condensing

Operating Temperature:

- 25°F to 126°F, 5% to 90% RH non-condensing

Optional front bezels for Platinum ZV Control:

Graphite - AZGRA950ABEZEL

White - AZWHT950ABEZEL

Black - AZBLK950ABEZEL



Zoning Communicating Sensor with Display

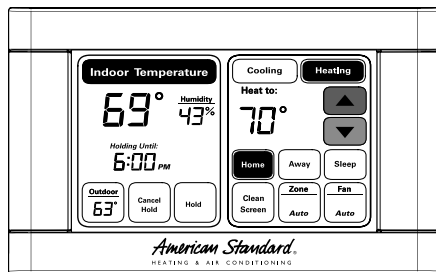

AZONE940AC52ZA

- Compatible with AccuLink™ Zoning Systems
- 3-Wire Communicating Zone Sensor
- 4.5" backlit touch screen black and white display
- Optional faceplate colors (silver/black, black, white, graphite)
- Zone Mode - Heat/Cool/Auto
- Fan Mode - Auto/On
- Synchronizes with AZONE950 Real Time Clock
- Weekly Comfort Settings scheduled from AZONE950
- Zone Schedule Override
 - Permanent Hold
 - Temporary Override
- 1-Touch Pre-Sets For Home, Away, Sleep Settings
- 24V power
- Displays Zone Temperature & Relative Humidity
- Displays Outdoor Temperature & Outdoor Relative Humidity (if available on AZONE950)
- Clean Screen Function
- Keypad lock- enabled from AZONE950
- Fahrenheit or Celsius - enabled from AZONE950 (system level setting)

Dimensions:

- 5.5" width x 3.4" height x 1.1" depth

Storage Temperature:

- -40°F to 170°F, 0% - 95% RH

Operating Temperature:

- 32°F - 120°F, 5% - 90% RH non-condensing

Optional front bezels for AZONE940 Control:

- AZSBK940ABEZEL - Silver/Black
- AZGRA940ABEZEL - Graphite
- AZWHT940ABEZEL - White
- AZBLK940ABEZEL - Black

Conventional 24 Volt HVAC System Interface Relay Panel for AccuLink™ Platinum ZV Control

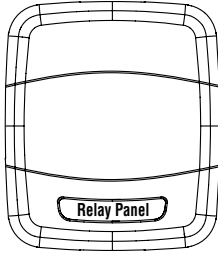

BAY24VRPAC52DA

BAY24VRPAC52DA — Without AUX Contact Control

- 5 Heat (Gas, Oil, Electric)/2 Cool/Heat Pump/Dual Fuel
- Optional remote indoor temperature connection point
- Optional outdoor temperature connection point
- LED stage indicators
- Removable low voltage terminal blocks for easy service and replacement
- Humidifier Control

Dimensions:

- 8.0" width x 9.3" height x 1.9" depth

Storage Temperature:

- -40° to 175°F, 5% - 95% RH non-condensing

Operating Temperature:

- -40° to 150°F, 5% - 95% RH non-condensing

NOTE: For applications requiring AUX Contact Control, use "B" model below.

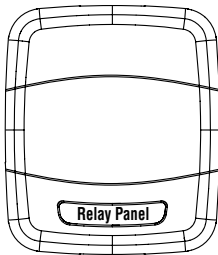

BAY24VRPAC52DB

BAY24VRPAC52DB — With AUX Contact Control

- 5 Heat (Gas, Oil, Electric)/2 Cool/Heat Pump/Dual Fuel
- Optional remote indoor temperature connection point
- Optional outdoor temperature connection point
- LED stage indicators
- Removable low voltage terminal blocks for easy service and replacement
- Humidifier Control
- **AUX Contacts**
 - Whole-home Dehumidifier Control
 - Ventilation Control

Dimensions:

- 8.0" width x 9.3" height x 1.9" depth

Storage Temperature:

- -40° to 175°F, 5% - 95% RH non-condensing

Operating Temperature:

- -40° to 150°F, 5% - 95% RH non-condensing

Communicating System

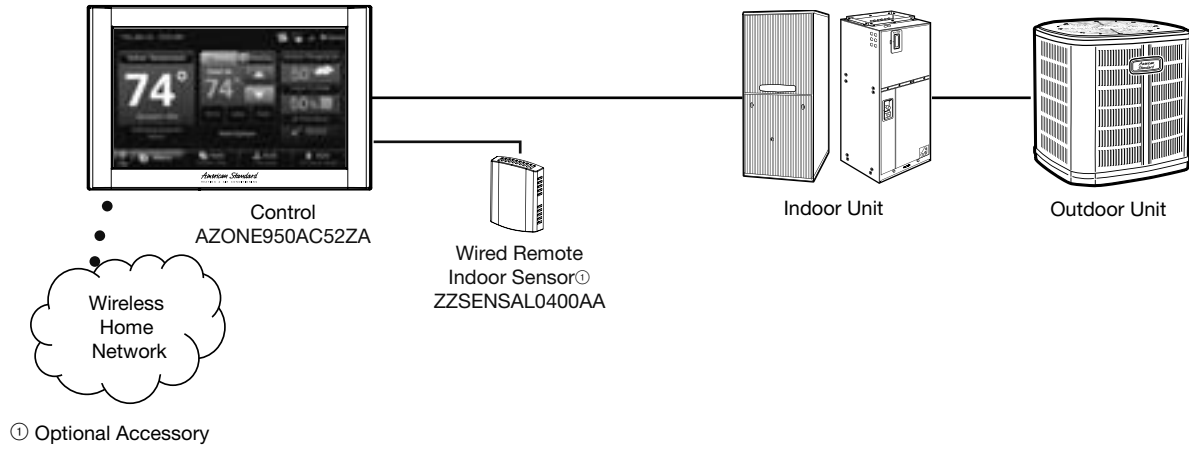

24V System

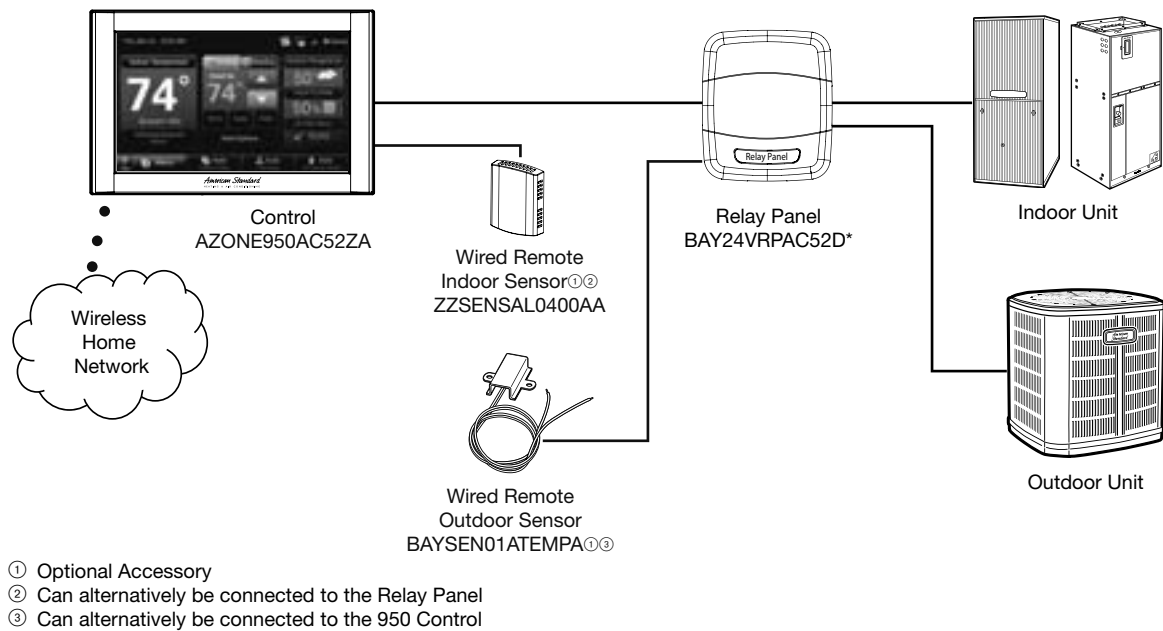

AccuLink™ Zoning Assembly

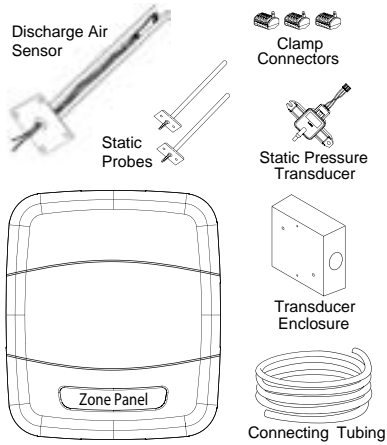

ZZONEPNLAC52ZB

ZZONEPNLAC52ZB

American Standard Variable Speed Indoor Unit (Air handler/Gas Furnace) required.

Includes:

- Four Zone Communicating Zone Panel with discharge air sensor, static pressure transducer and housing, supply, return air static probes and connecting tubing, and three wiring blocks
- Automatically sets maximum CFM per zone
- Compatible with 24 Volt systems with the addition of 24 Volt relay panel
- Controls 24 Volt power open, power

- close modulating dampers
- Auto detects installed dampers
- Supports 2-wire (ZZSENSAL0400AA) and 3-wire (AZONE940) zone sensors
- Adjustable damper motor travel times of 15 to 60 seconds
- Requires field supplied 24 volt power supply
- Up to four 1.5 VA dampers can be wired in parallel to each zone
- Backlit LCD display for easy setup and service
- Optional return and mixed air sensors are available
- Removable low voltage terminal blocks for easy service and replacement

AccuLink™ Zone Expander Panel (Required with more than 4 zones)

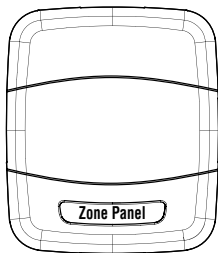

ZZONEEXPAC52ZA

ZZONEEXPAC52ZA*

- Expands the maximum number of zones per system to eight
- Controls 24 Volt power open, power close modulating dampers
- Auto detects installed dampers
- Supports 2-wire (ZZSENSAL0400AA) and 3-wire (AZONE940) zone sensors
- Adjustable damper motor travel times of 15 to 60 seconds
- Requires field supplied 24 Volt power supply

Dimensions:

- 8.0" width x 9.3" height x 1.9" depth

Storage Temperature:

- -40° to 175°F, 5% to 95% RH non-condensing

Operating Temperature:

- -40° to 150°F, 5% to 95% RH non-condensing

*This is the same Zone Panel that ships as part of the Zoning Assembly

AccuLink™ Zoning Component Overview

Zoned Communicating System

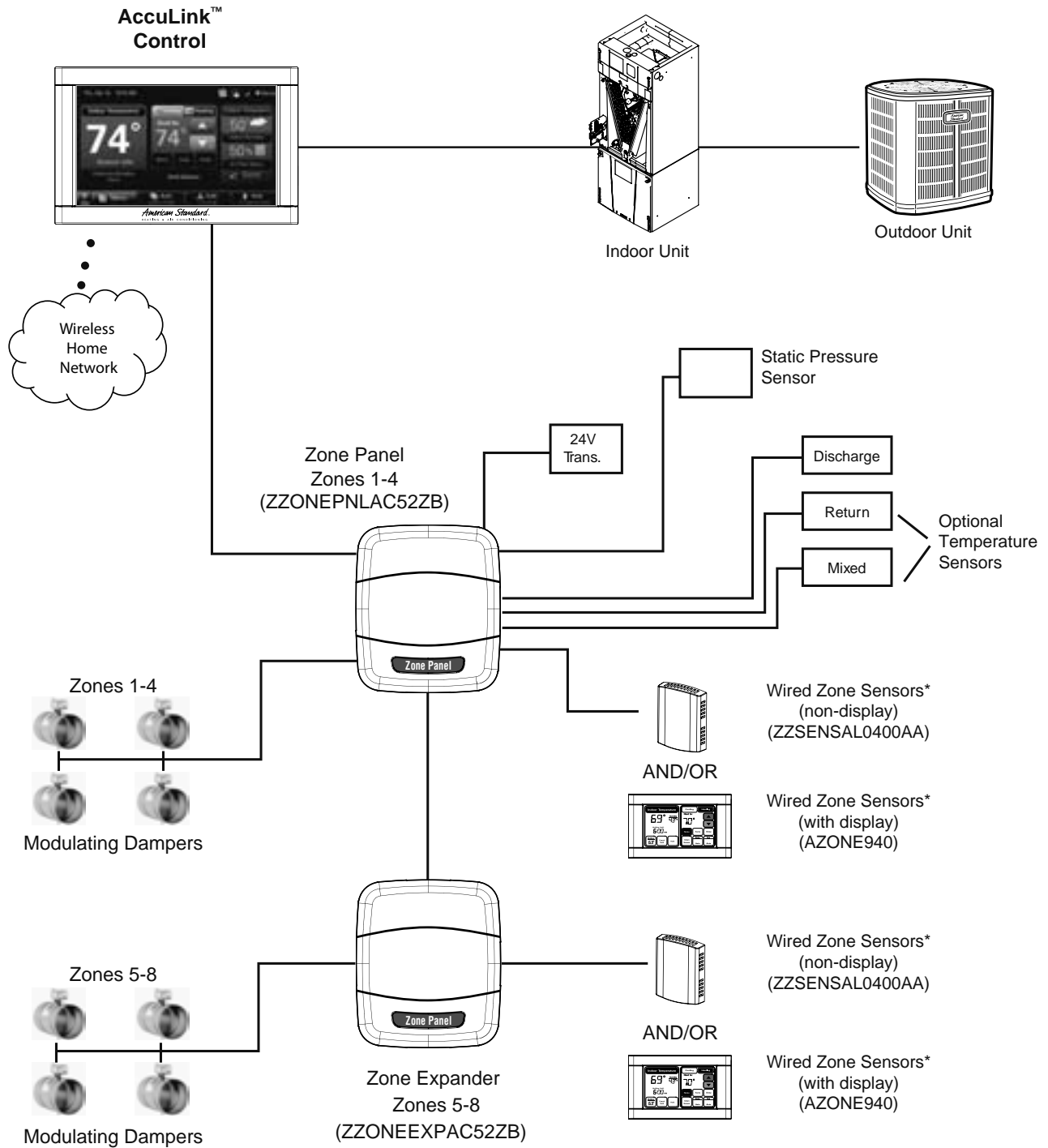

* Up to 4 AZONE940 Zone Sensors with display may be used with each ZZONEPNLAC52ZA Zone Panel. AZONE940 Zone Sensors may be used in all zones or in combination with zones using non-display ZZSENSAL0400AA sensors.

AccuLink™ Zoning Component Overview (Cont.)

Zoned 24V

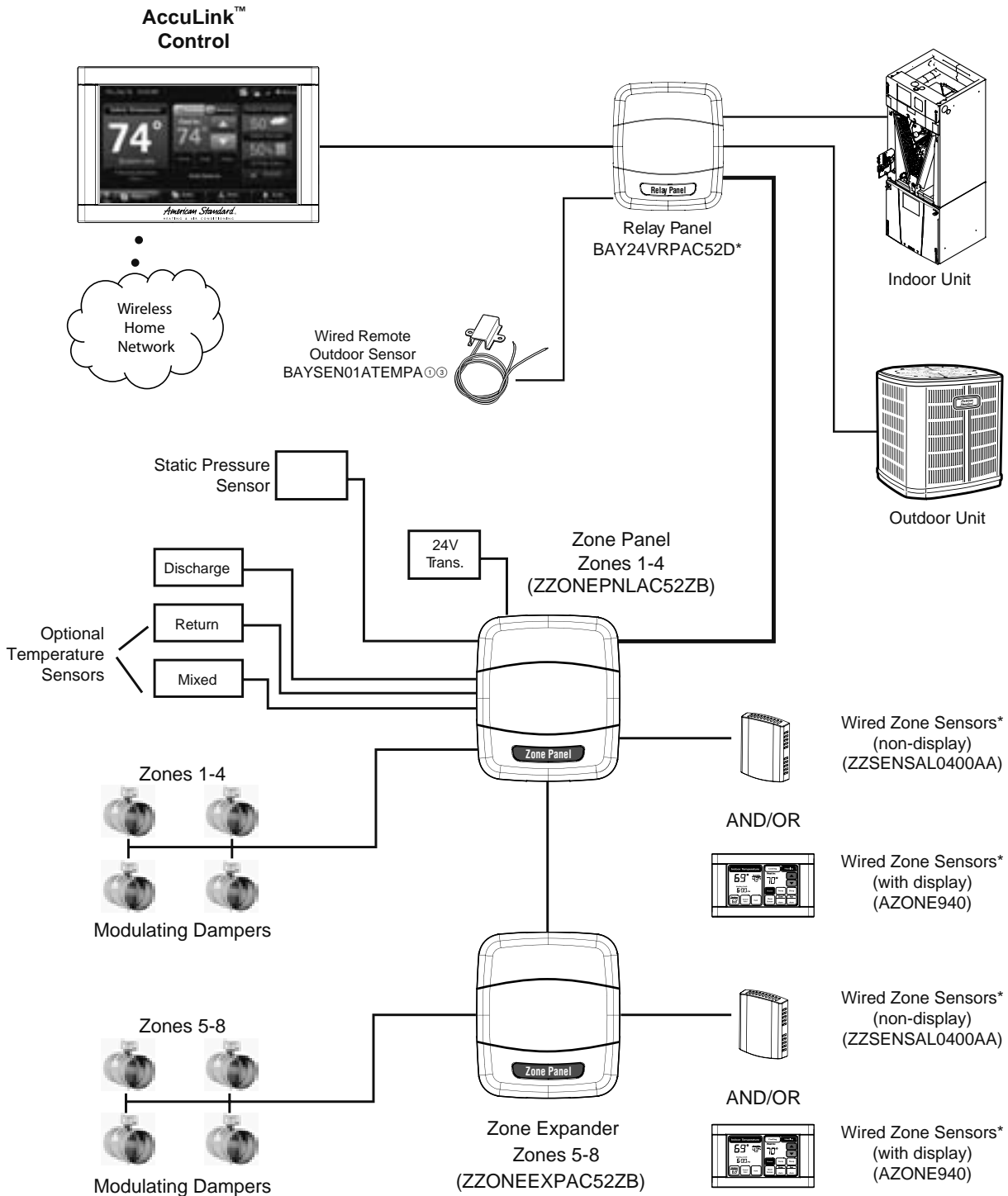

* Up to 4 AZONE940 Zone Sensors with display may be used with each ZZONEPNLAC52ZA Zone Panel. AZONE940 Zone Sensors may be used in all zones or in combination with zones using non-display ZZSENSAL0400AA sensors.

- ① Optional Accessory
- ② Can alternatively be connected to the Relay Panel
- ③ Can alternatively be connected to the 950 Control

For complete equipment / combination selections, installation instructions and warranty information, please refer to Product Data/Ratings and/or Installers Guides and Limited Warranty Handbooks.

24 Volt Modulating Dampers

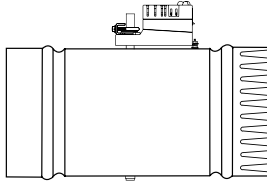

Round Dampers

Round Dampers

- 24 VAC Powered open/Powered closed
- Three wire connection - 18 gauge
- 1.5 VA damper actuator with 60 second travel time
- 18 in. lbs. of torque
- Manual gear release
- Screw terminal blocks
- Flexible shutoff seal provides 98% closure

Table CCZS-10-A — Specifications: Round Dampers

Model Number	Power Supply	Description	Fits Round Duct Size
ZDAMPRDMA0004A	24 VAC	Round	4"
ZDAMPRDMA0006A	24 VAC	Round	6"
ZDAMPRDMA0007A	24 VAC	Round	7"
ZDAMPRDMA0008A	24 VAC	Round	8"
ZDAMPRDMA0009A	24 VAC	Round	9"
ZDAMPRDMA0010A	24 VAC	Round	10"
ZDAMPRDMA0012A	24 VAC	Round	12"
ZDAMPRDMA0014A	24 VAC	Round	14"
ZDAMPRDMA0016A	24 VAC	Round	16"
ZDAMPRDMA0018A	24 VAC	Round	18"
ZDAMPRDMA0020A	24 VAC	Round	20"

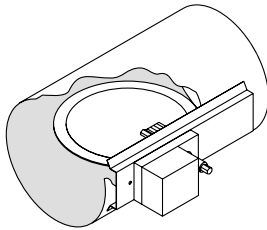

Retro-Fit Round Dampers

Retro-Fit Round Dampers

- 24 VAC Powered open/Powered closed
- Three wire connection - 18 gauge
- Slip-In-Design installs quickly
- 1.5 VA damper actuator with 60 second travel time
- 18 in. lbs. of torque
- Manual gear release
- Screw terminal blocks
- Flexible shutoff seal provides 98% closure

Table CCZS-10-B — Specifications: Retrofit Round Dampers

Model Number	Power Supply	Description	Fits Round Duct Size
ZDAMPRRMA0004A	24 VAC	Retrofit Round	4"
ZDAMPRRMA0005A	24 VAC	Retrofit Round	5"
ZDAMPRRMA0006A	24 VAC	Retrofit Round	6"
ZDAMPRRMA0007A	24 VAC	Retrofit Round	7"
ZDAMPRRMA0008A	24 VAC	Retrofit Round	8"
ZDAMPRRMA0009A	24 VAC	Retrofit Round	9"
ZDAMPRRMA0010A	24 VAC	Retrofit Round	10"

24 Volt Modulating Dampers - Side Mount

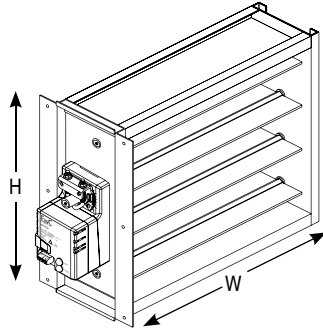

Rectangular Dampers with Side Mount Actuator

Rectangular Dampers with Side Mount Actuator

- 24 VAC Powered open/Powered closed
- Three wire connection - 18 gauge
- 1.5 VA damper actuator with 60 second travel time
- 18 in. lbs. of torque
- Manual gear release
- Screw terminal blocks
- 97% leak proof rating
- Sturdy aluminum blades and frame
- Motor is always located on the second dimension of the model number, i.e ZDAMP*MMA1012A will have the motor mounted on the 12" dimension

Table CCZS-11-A — Specifications: Rectangular Dampers with Side Mount Actuator

Model Number	Power Supply	Description	Uncrated Dimensions (in.)	
			W	H
ZDAMPSMMA0806A	24 VAC	Rectangular-Side Mount Actuator	8	6
ZDAMPSMMA0808A	24 VAC	Rectangular-Side Mount Actuator	8	8
ZDAMPSMMA1006A	24 VAC	Rectangular-Side Mount Actuator	10	6
ZDAMPSMMA1008A	24 VAC	Rectangular-Side Mount Actuator	10	8
ZDAMPSMMA1010A	24 VAC	Rectangular-Side Mount Actuator	10	10
ZDAMPSMMA1206A	24 VAC	Rectangular-Side Mount Actuator	12	6
ZDAMPSMMA1208A	24 VAC	Rectangular-Side Mount Actuator	12	8
ZDAMPSMMA1210A	24 VAC	Rectangular-Side Mount Actuator	12	10
ZDAMPSMMA1212A	24 VAC	Rectangular-Side Mount Actuator	12	12
ZDAMPSMMA1406A	24 VAC	Rectangular-Side Mount Actuator	14	6
ZDAMPSMMA1408A	24 VAC	Rectangular-Side Mount Actuator	14	8
ZDAMPSMMA1410A	24 VAC	Rectangular-Side Mount Actuator	14	10
ZDAMPSMMA1412A	24 VAC	Rectangular-Side Mount Actuator	14	12
ZDAMPSMMA1414A	24 VAC	Rectangular-Side Mount Actuator	14	14
ZDAMPSMMA1606A	24 VAC	Rectangular-Side Mount Actuator	16	6
ZDAMPSMMA1608A	24 VAC	Rectangular-Side Mount Actuator	16	8
ZDAMPSMMA1610A	24 VAC	Rectangular-Side Mount Actuator	16	10
ZDAMPSMMA1612A	24 VAC	Rectangular-Side Mount Actuator	16	12
ZDAMPSMMA1614A	24 VAC	Rectangular-Side Mount Actuator	16	14
ZDAMPSMMA1616A	24 VAC	Rectangular-Side Mount Actuator	16	16
ZDAMPSMMA1806A	24 VAC	Rectangular-Side Mount Actuator	18	6
ZDAMPSMMA1808A	24 VAC	Rectangular-Side Mount Actuator	18	8
ZDAMPSMMA1810A	24 VAC	Rectangular-Side Mount Actuator	18	10
ZDAMPSMMA1812A	24 VAC	Rectangular-Side Mount Actuator	18	12
ZDAMPSMMA1814A	24 VAC	Rectangular-Side Mount Actuator	18	14
ZDAMPSMMA1816A	24 VAC	Rectangular-Side Mount Actuator	18	16
ZDAMPSMMA1818A	24 VAC	Rectangular-Side Mount Actuator	18	18
ZDAMPSMMA2006A	24 VAC	Rectangular-Side Mount Actuator	20	6
ZDAMPSMMA2008A	24 VAC	Rectangular-Side Mount Actuator	20	8
ZDAMPSMMA2010A	24 VAC	Rectangular-Side Mount Actuator	20	10
ZDAMPSMMA2012A	24 VAC	Rectangular-Side Mount Actuator	20	12
ZDAMPSMMA2014A	24 VAC	Rectangular-Side Mount Actuator	20	14
ZDAMPSMMA2016A	24 VAC	Rectangular-Side Mount Actuator	20	16
ZDAMPSMMA2018A	24 VAC	Rectangular-Side Mount Actuator	20	18
ZDAMPSMMA2020A	24 VAC	Rectangular-Side Mount Actuator	20	20

24 Volt Modulating Dampers - Side Mount

Table CCZS-12-A — Specifications: Rectangular Dampers with Side Mount Actuator (continued)

Model Number	Power Supply	Description	Uncrated Dimensions (in.)	
			W	H
ZDAMPSMMA2206A	24 VAC	Rectangular-Side Mount Actuator	22	6
ZDAMPSMMA2208A	24 VAC	Rectangular-Side Mount Actuator	22	8
ZDAMPSMMA2210A	24 VAC	Rectangular-Side Mount Actuator	22	10
ZDAMPSMMA2212A	24 VAC	Rectangular-Side Mount Actuator	22	12
ZDAMPSMMA2214A	24 VAC	Rectangular-Side Mount Actuator	22	14
ZDAMPSMMA2216A	24 VAC	Rectangular-Side Mount Actuator	22	16
ZDAMPSMMA2218A	24 VAC	Rectangular-Side Mount Actuator	22	18
ZDAMPSMMA2220A	24 VAC	Rectangular-Side Mount Actuator	22	20
ZDAMPSMMA2222A	24 VAC	Rectangular-Side Mount Actuator	22	22
ZDAMPSMMA2406A	24 VAC	Rectangular-Side Mount Actuator	24	6
ZDAMPSMMA2408A	24 VAC	Rectangular-Side Mount Actuator	24	8
ZDAMPSMMA2410A	24 VAC	Rectangular-Side Mount Actuator	24	10
ZDAMPSMMA2412A	24 VAC	Rectangular-Side Mount Actuator	24	12
ZDAMPSMMA2414A	24 VAC	Rectangular-Side Mount Actuator	24	14
ZDAMPSMMA2416A	24 VAC	Rectangular-Side Mount Actuator	24	16
ZDAMPSMMA2418A	24 VAC	Rectangular-Side Mount Actuator	24	18
ZDAMPSMMA2420A	24 VAC	Rectangular-Side Mount Actuator	24	20
ZDAMPSMMA2422A	24 VAC	Rectangular-Side Mount Actuator	24	22
ZDAMPSMMA2424A	24 VAC	Rectangular-Side Mount Actuator	24	24
ZDAMPSMMA2606A	24 VAC	Rectangular-Side Mount Actuator	26	6
ZDAMPSMMA2608A	24 VAC	Rectangular-Side Mount Actuator	26	8
ZDAMPSMMA2610A	24 VAC	Rectangular-Side Mount Actuator	26	10
ZDAMPSMMA2612A	24 VAC	Rectangular-Side Mount Actuator	26	12
ZDAMPSMMA2614A	24 VAC	Rectangular-Side Mount Actuator	26	14
ZDAMPSMMA2616A	24 VAC	Rectangular-Side Mount Actuator	26	16
ZDAMPSMMA2618A	24 VAC	Rectangular-Side Mount Actuator	26	18
ZDAMPSMMA2620A	24 VAC	Rectangular-Side Mount Actuator	26	20
ZDAMPSMMA2622A	24 VAC	Rectangular-Side Mount Actuator	26	22
ZDAMPSMMA2624A	24 VAC	Rectangular-Side Mount Actuator	26	24
ZDAMPSMMA2626A	24 VAC	Rectangular-Side Mount Actuator	26	26
ZDAMPSMMA2806A	24 VAC	Rectangular-Side Mount Actuator	28	6
ZDAMPSMMA2808A	24 VAC	Rectangular-Side Mount Actuator	28	8
ZDAMPSMMA2810A	24 VAC	Rectangular-Side Mount Actuator	28	10
ZDAMPSMMA2812A	24 VAC	Rectangular-Side Mount Actuator	28	12
ZDAMPSMMA2814A	24 VAC	Rectangular-Side Mount Actuator	28	14
ZDAMPSMMA2816A	24 VAC	Rectangular-Side Mount Actuator	28	16
ZDAMPSMMA2818A	24 VAC	Rectangular-Side Mount Actuator	28	18
ZDAMPSMMA2820A	24 VAC	Rectangular-Side Mount Actuator	28	20
ZDAMPSMMA2822A	24 VAC	Rectangular-Side Mount Actuator	28	22
ZDAMPSMMA2824A	24 VAC	Rectangular-Side Mount Actuator	28	24
ZDAMPSMMA2826A	24 VAC	Rectangular-Side Mount Actuator	28	26
ZDAMPSMMA2828A	24 VAC	Rectangular-Side Mount Actuator	28	28
ZDAMPSMMA3006A	24 VAC	Rectangular-Side Mount Actuator	28	6
ZDAMPSMMA3008A	24 VAC	Rectangular-Side Mount Actuator	28	8
ZDAMPSMMA3010A	24 VAC	Rectangular-Side Mount Actuator	28	10
ZDAMPSMMA3012A	24 VAC	Rectangular-Side Mount Actuator	28	12
ZDAMPSMMA3014A	24 VAC	Rectangular-Side Mount Actuator	28	14
ZDAMPSMMA3016A	24 VAC	Rectangular-Side Mount Actuator	28	16
ZDAMPSMMA3018A	24 VAC	Rectangular-Side Mount Actuator	28	18
ZDAMPSMMA3020A	24 VAC	Rectangular-Side Mount Actuator	28	20
ZDAMPSMMA3022A	24 VAC	Rectangular-Side Mount Actuator	28	22
ZDAMPSMMA3024A	24 VAC	Rectangular-Side Mount Actuator	28	24
ZDAMPSMMA3026A	24 VAC	Rectangular-Side Mount Actuator	28	26
ZDAMPSMMA3028A	24 VAC	Rectangular-Side Mount Actuator	28	28
ZDAMPSMMA3030A	24 VAC	Rectangular-Side Mount Actuator	28	30

24 Volt Modulating Dampers - Bottom Mount

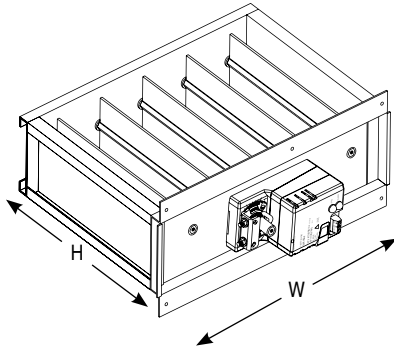

Rectangular Dampers with Bottom Mount Actuator

Rectangular Dampers with Bottom Mount Actuator

- 24 VAC Powered open/Powered closed
- Three wire connection - 18 gauge
- 1.5 VA damper actuator with 60 second travel time
- 18 in. lbs. of torque
- Manual gear release
- Screw terminal blocks
- 97% leak proof rating
- Sturdy aluminum blades and frame
- Motor is always located on the second dimension of the model number, i.e ZDAMP[®]MMA1012A will have the motor mounted on the 12" dimension

Table CCZS-13-A — Specifications: Rectangular Dampers with Bottom Mount Actuator

Model Number	Power Supply	Description	Uncrated Dimensions (in.)	
			H	W
ZDAMPBMMMA0810A	24 VAC	Rectangular-Bottom Mount Actuator	8	10
ZDAMPBMMMA0812A	24 VAC	Rectangular-Bottom Mount Actuator	8	12
ZDAMPBMMMA0814A	24 VAC	Rectangular-Bottom Mount Actuator	8	14
ZDAMPBMMMA0816A	24 VAC	Rectangular-Bottom Mount Actuator	8	16
ZDAMPBMMMA0818A	24 VAC	Rectangular-Bottom Mount Actuator	8	18
ZDAMPBMMMA0820A	24 VAC	Rectangular-Bottom Mount Actuator	8	20
ZDAMPBMMMA0822A	24 VAC	Rectangular-Bottom Mount Actuator	8	22
ZDAMPBMMMA0824A	24 VAC	Rectangular-Bottom Mount Actuator	8	24
ZDAMPBMMMA0826A	24 VAC	Rectangular-Bottom Mount Actuator	8	26
ZDAMPBMMMA0828A	24 VAC	Rectangular-Bottom Mount Actuator	8	28
ZDAMPBMMMA0830A	24 VAC	Rectangular-Bottom Mount Actuator	8	30
ZDAMPBMMMA1012A	24 VAC	Rectangular-Bottom Mount Actuator	10	12
ZDAMPBMMMA1014A	24 VAC	Rectangular-Bottom Mount Actuator	10	14
ZDAMPBMMMA1016A	24 VAC	Rectangular-Bottom Mount Actuator	10	16
ZDAMPBMMMA1018A	24 VAC	Rectangular-Bottom Mount Actuator	10	18
ZDAMPBMMMA1020A	24 VAC	Rectangular-Bottom Mount Actuator	10	20
ZDAMPBMMMA1022A	24 VAC	Rectangular-Bottom Mount Actuator	10	22
ZDAMPBMMMA1024A	24 VAC	Rectangular-Bottom Mount Actuator	10	24
ZDAMPBMMMA1026A	24 VAC	Rectangular-Bottom Mount Actuator	10	26
ZDAMPBMMMA1028A	24 VAC	Rectangular-Bottom Mount Actuator	10	28
ZDAMPBMMMA1030A	24 VAC	Rectangular-Bottom Mount Actuator	10	30
ZDAMPBMMMA1214A	24 VAC	Rectangular-Bottom Mount Actuator	12	14
ZDAMPBMMMA1216A	24 VAC	Rectangular-Bottom Mount Actuator	12	16
ZDAMPBMMMA1218A	24 VAC	Rectangular-Bottom Mount Actuator	12	18
ZDAMPBMMMA1220A	24 VAC	Rectangular-Bottom Mount Actuator	12	20
ZDAMPBMMMA1222A	24 VAC	Rectangular-Bottom Mount Actuator	12	22
ZDAMPBMMMA1224A	24 VAC	Rectangular-Bottom Mount Actuator	12	24
ZDAMPBMMMA1226A	24 VAC	Rectangular-Bottom Mount Actuator	12	26
ZDAMPBMMMA1228A	24 VAC	Rectangular-Bottom Mount Actuator	12	28
ZDAMPBMMMA1230A	24 VAC	Rectangular-Bottom Mount Actuator	12	30
ZDAMPBMMMA1416A	24 VAC	Rectangular-Bottom Mount Actuator	14	16
ZDAMPBMMMA1418A	24 VAC	Rectangular-Bottom Mount Actuator	14	18
ZDAMPBMMMA1420A	24 VAC	Rectangular-Bottom Mount Actuator	14	20
ZDAMPBMMMA1422A	24 VAC	Rectangular-Bottom Mount Actuator	14	22
ZDAMPBMMMA1424A	24 VAC	Rectangular-Bottom Mount Actuator	14	24
ZDAMPBMMMA1426A	24 VAC	Rectangular-Bottom Mount Actuator	14	26
ZDAMPBMMMA1428A	24 VAC	Rectangular-Bottom Mount Actuator	14	28
ZDAMPBMMMA1430A	24 VAC	Rectangular-Bottom Mount Actuator	14	30
ZDAMPBMMMA1618A	24 VAC	Rectangular-Bottom Mount Actuator	16	18
ZDAMPBMMMA1620A	24 VAC	Rectangular-Bottom Mount Actuator	16	20
ZDAMPBMMMA1622A	24 VAC	Rectangular-Bottom Mount Actuator	16	22
ZDAMPBMMMA1624A	24 VAC	Rectangular-Bottom Mount Actuator	16	24
ZDAMPBMMMA1626A	24 VAC	Rectangular-Bottom Mount Actuator	16	26
ZDAMPBMMMA1628A	24 VAC	Rectangular-Bottom Mount Actuator	16	28
ZDAMPBMMMA1630A	24 VAC	Rectangular-Bottom Mount Actuator	16	30
ZDAMPBMMMA1820A	24 VAC	Rectangular-Bottom Mount Actuator	18	20
ZDAMPBMMMA1822A	24 VAC	Rectangular-Bottom Mount Actuator	18	22
ZDAMPBMMMA1824A	24 VAC	Rectangular-Bottom Mount Actuator	18	24
ZDAMPBMMMA1826A	24 VAC	Rectangular-Bottom Mount Actuator	18	26
ZDAMPBMMMA2022A	24 VAC	Rectangular-Bottom Mount Actuator	20	22
ZDAMPBMMMA2024A	24 VAC	Rectangular-Bottom Mount Actuator	20	24

24 Volt Modulating Dampers

Table CCZS-14-A — Rectangular Damper Net Free Area

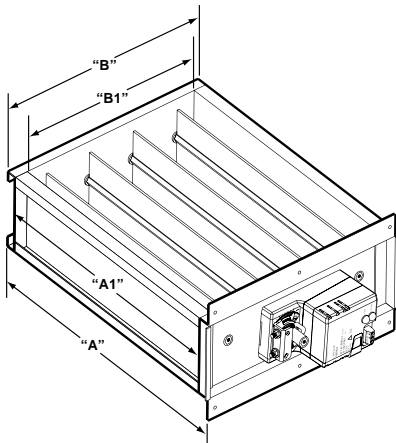

Listed Size	Actual Outside Size	Actual Inside Size	8	10	12	14	16	18	20	22	24	26	28	30	Listed Size	High	
			7.813	9.813	11.813	13.813	15.813	17.813	19.813	21.813	23.813	25.813	27.813	29.813	Act. Outside Size B		
			5.813	7.813	9.813	11.813	13.813	15.813	17.813	19.813	21.813	23.813	25.813	27.813	Act. Inside Size B1		
			3	3	4	5	6	7	7	8	9	10	11	11	No. of Blades		
Wide	A	A1															
6	5.812	4.313	19.5	28.1	34.9	41.6	48.6	55.1	63.8	70.5	77.3	84.0	90.8	99.4			
8	7.812	6.313	28.5	41.1	51.0	60.9	70.8	80.7	93.3	103.2	113.1	123.0	132.9	145.5			
10	9.812	8.313	37.5	54.2	67.2	80.2	93.2	106.3	122.9	135.9	148.9	162.0	175.0	191.6			
12	11.812	10.313	46.5	67.2	83.3	99.5	115.7	131.8	152.5	168.6	184.8	200.9	217.1	237.7			
14	13.812	12.313	55.6	80.2	99.5	118.8	138.1	157.4	182.0	201.3	220.6	239.9	259.2	283.8			
16	15.812	14.313	64.6	93.2	115.7	138.1	160.5	183.0	211.6	234.0	256.4	278.9	301.3	329.9			
18	17.812	16.313	73.6	106.3	131.8	157.4	183.0	208.5	241.1	266.7	292.3	317.8	343.4	376.0			
20	19.812	18.313	82.7	119.3	148.0	176.7	205.4	234.1	270.7	299.4	328.1	356.8	385.5	422.1			
22	21.812	20.313	91.7	132.3	164.2	196.0	227.8	259.6	300.3	332.1	363.9	395.8	427.6	468.2			
24	23.812	22.313	100.7	145.4	180.3	215.3	250.2	285.2	329.8	364.8	399.8	435.2	469.7	514.3			
26	25.812	24.313	109.8	158.4	196.5	234.6	272.7	310.8	359.4	397.5	435.6	473.7	511.8	560.4			
28	27.812	26.313	118.8	171.4	212.6	253.9	295.1	336.3	389.0	430.2	471.4	512.7	553.8	606.5			
30	29.812	28.313	127.8	184.4	228.8	273.2	317.5	361.9	418.5	462.9	507.3	551.6	596.0	652.6			

Programmable 7 Day Comfort Controls

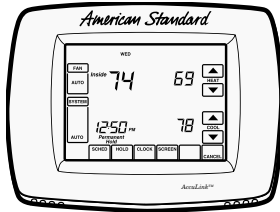

ACONT900A

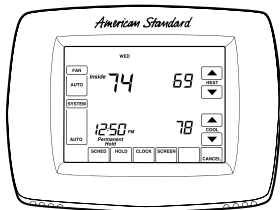

ACONT800A

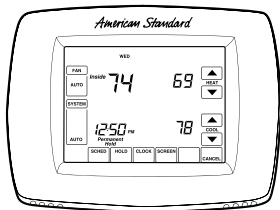

ACONT802A

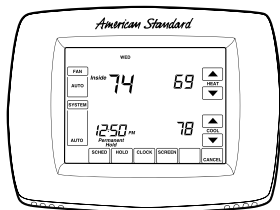

ACONT803A

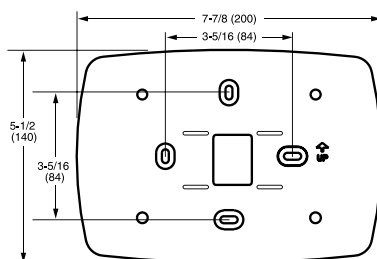

BAYCOVR600A

ACONT900AC43UA - AccuLink™

- Communicating Programmable
- Interactive Touchscreen
- Continuous Comfort-R™
- Smart Continuous Fan
- Adjustable Continuous Fan, 25-100%
- Multiple Filter Reminders
- Humidity Sensor
- Dehumidification Control
- Window Frost Control
- Dual Fuel Compatible
- BAYCOVR600A - Wall cover plate
- Energy Saver

ACONT800AS11AA

- Interactive Touchscreen
- Effortless Programming
- Large, Backlit Display
- Streamlined Design
- Armchair Programming
- Real Time Clock
- Visual Reminder Cues
- BAYCOVR600A - Wall cover plate
- Energy Saver

ACONT802AS32DA

- Interactive Touchscreen
- Effortless Programming
- Large, Backlit Display
- Streamlined Design
- Armchair Programming
- Real Time Clock
- Visual Reminder Cues
- BAYCOVR600A - Wall cover plate
- Energy Saver

ACONT803AS32DA

- Built-in Humidity Sensor
- Dehumidification Control
- Interactive Touchscreen
- Effortless Programming
- Large, Backlit Display
- Streamlined Design
- Armchair Programming
- Real Time Clock
- Visual Reminder Cues
- BAYCOVR600A - Wall cover plate
- Energy Saver

BAYCOVR600A

Application:

- Use with ACONT800/900A Series Comfort Controls

Application:

- 4 Heat/2 Cool (Gas, Oil or Electric)
- BAYTAM00AC00UA - Communicating Telephone Access module

Dimensions:

- 6.02" w x 4.62" h x 1.35" d
- Finish: Bright White

Application:

- 1 Heat/1 Cool (Gas, Oil or Electric)
- 1 Heat/0 Cool (Gas, Oil or Electric)
- 0 Heat/1 Cool
- ZZSENSAL0800AA - Remote Indoor Temperature Sensor

Dimensions:

- 6.02" w x 4.62" h x 1.35" d
- Finish: Bright White

Application:

- Up to 3 Heat/2 Cool (Gas, Oil or Electric)/HP
- ZZSENSAL0800AA - Remote Indoor Temperature Sensor

Dimensions:

- 6.02" w x 4.62" h x 1.35" d
- Finish: Bright White

Application:

- Up to 3 Heat/2 Cool (Gas, Oil or Electric)/HP
- ZZSENSAL0800AA - Remote Indoor Temperature Sensor

Dimensions:

- 6.02" w x 4.62" h x 1.35" d
- Finish: Bright White

Dimensions:

- 7.87" w x 5.50" h
- Finish: Bright White

Programmable 5/2 Day Comfort Controls

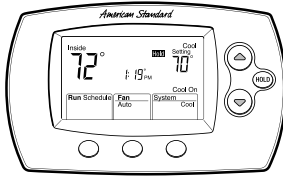

ACONT600A

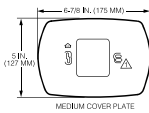

BAYCOVR700A

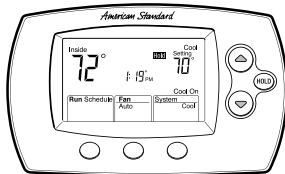

ACONT602A

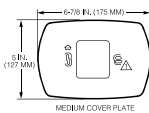

BAYCOVR700A

ACONT600AF11MA

- 1 Heat/1 Cool
- 5/2 or 5/1/1 Programming
- Simple to Install and Use
- Front Wired (Wires attach to wall plates)
- Standard Wiring Terminal Block
- Easy to follow Sequential Programming
- Inside and set temperatures displayed simultaneously
- No auxiliary heat capability
- Plain language (no symbols)
- Easy battery access
- Easy to understand soft key controls

- BAYCOVR700A - Wall cover plate
 - 6.87" w x 5.0" h
 - Finish: Bright White

Application:

- 1 stage heat pump, 0 stage Aux Heat
- 1 stage cool, 1 stage heat (Gas, electric, or oil)
- 1 stage cool, 0 stage heat
- 0 stage cool, 1 stage heat (Gas, electric, or oil)

Dimensions:

- 5.81" w x 3.56" h x 1.50" d
- Finish: Bright White

ACONT602AF22MA

- 2 Heat/2 Cool
- 5/2 or 5/1/1 Programming
- Simple to Install and Use
- Front Wired (Wires attach to wall plates)
- Standard Wiring Terminal Block
- Easy to follow Sequential Programming
- Inside and set temperatures displayed simultaneously
- Plain language (no symbols)
- Easy battery access
- Easy to understand soft key controls
- BAYCOVR700A - Wall cover plate
 - 6.87" w x 5.0" h
 - Finish: Bright White

Application:

- 1 stage cool, 1 stage heat
- 2 stage cool, 1 stage heat
- 1 stage cool, 2 stage heat
- 2 stage cool, 2 stage heat
- 1 stage cool, 0 stage heat
- 0 stage cool, 1 stage heat (Gas, electric, or oil)
- 1 stage heat pump, 0 stage Aux Heat
- 1 stage heat pump, 1 stage Aux Heat

Dimensions:

- 5.81" w x 3.56" h x 1.50" d
- Finish: Bright White

Non-Programmable Comfort Controls

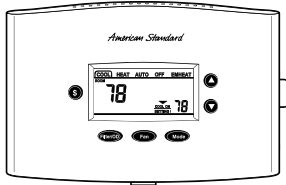

ACONT402A

ACONT402AN32DA

- Auto Changeover
- Backlit Display & Keys
- Comfort Information Compartment
- Energy Savings Mode
- Filter Reminder
- BAYSEN01ATEMPAA-Outdoor Temperature Sensor included*
- Keypad Lock

- Application** (3-9 Wire Hookup -2 for Outdoor Sensor) Heat Pump* or A/C
- 3 Heat/2 Cool
 - No external Dual Fuel Kit Required
 - Do not use with TAYPLUS103A
 - ZZSENSAL0400AA - Remote Indoor Temperature Sensor

Dimensions:

- 6.75" w x 4.52" h x 1.20" d
- Finish: Bright White
- * Requires external relay for oil furnace applications.
- * Installation is required for outdoor temperature sensing and display

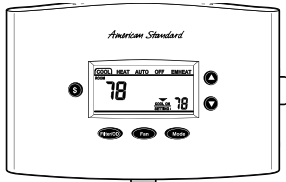

ACONT401A

ACONT401AN21MA

- Auto Changeover
- Backlit Display & Keys
- Comfort Information Compartment
- Energy Savings Mode
- Filter Reminder
- Outdoor Temperature Sensor
- Keypad Lock

- Application** (3-9 Wire Hookup -2 for Outdoor Sensor) Heat Pump* or A/C
- 1 Stage Heat Pump**, 1 Stage Aux Heat
 - 1 Stage Heat Pump**, 0 Stage Aux Heat
 - 1 Stage Cool, 2 Stage Heat (Gas, Electric or Oil*)

- 1 Stage Cool, 1 Stage Heat (Gas, Electric or Oil*)
- 1 Stage Cool, 0 Stage Heat
- 0 Stage Cool, 2 Stage Heat (Gas, Electric or Oil*)
- 0 Stage Cool, 1 Stage Heat (Gas, Electric or Oil*)

Dimensions:

- 6.75" w x 4.52" h x 1.20" d
- Finish: Bright White
- * Requires external relay for oil furnace applications.
- ** **External TAYPLUS103A required for dual fuel applications.** BAYSEN01ATEMPA required for outdoor temperature sensing and display

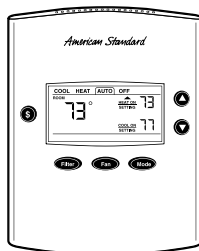

ACONT200A

ACONT200AN11AA^①

- Auto Changeover
- Backlit Display & Keys
- Comfort Information Compartment
- Energy Savings Mode
- Filter Reminder
- Key Pad Lock

Application

(4 wire hookup - power stealing)*

- 1 Heat/1 Cool (Gas, Oil or electric)
- 1 Heat/0 Cool (Gas, Oil or electric)
- 0 Heat/1 Cool
- Finish: Bright White

Dimensions:

- 4.25" w x 5.33" h x 1.20" d

^① Power Stealing 4 Wire - Resistor Terminal in Box. 4 - wire system to supply power with heating mode; both resistors must be installed for proper operation.

Remote Sensors



BAYSEN02ATEMPA

- Outdoor Temperature Sensor for use with ACONT800, 802, 803
- Accuracy +/- 1°F from -40 to 120°F

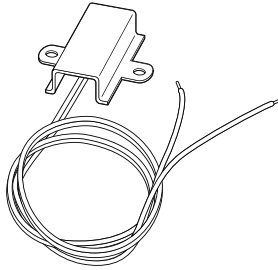

BAYSEN01ATEMPA

- Outdoor Temperature Sensor for use with AccuLink™ Platinum ZV Control, AccuLink™ Zoning and ACONT401A
- Accuracy +/- 1.5°F over 32°F to 100°F
- Display Range -40°F to 140°F

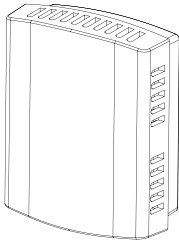

ZZSENSAL0400AA

- Indoor Sensor for use with AccuLink™ Platinum ZV Control, AccuLink™ Zoning and ACONT402A Comfort Controls
- Operating Ambient Temperature Range: 20° to 120°F (-6.7° to 48.9°C)
- Display Range: 20° to 120°F (-6.7° to 48.9°C)
- Sensor Accuracy: +/- .5°F at 75°F
- Operating Relative Humidity: 5% to 90% non-condensing

Dimensions in in. (mm):

- 1.54 (39)w x 1.93 (49)h x .625 (1.6)d
- Storage Temperature: -40° to 140°F (-40° to 60°C)
- Finish: White

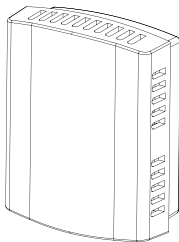

ZZSENSAL0800AA

- Indoor Temperature Sensor for use with ACONT800, 802, 803
- Operating Ambient Temperature Range: 20° to 120°F (-6.7° to 48.9°C)
- Display Range: 0 to 99°F (-18 to 37°C)
- Sensor Accuracy: +/-1.5°F at 70°F (+/- .84 at 21°C)
- Operating Relative Humidity: 5% to 95% non-condensing

Dimensions in in. (mm):

- 1.54 (39)w x 1.93 (49)h x .625 (1.6)d
- Storage Temperature: -40° to 140°F (-40° to 60°C)
- Finish: White

Indoor Fan Delay Relay Kit

BAY24X045

- For application to furnaces and air handlers with cooling coils equipped with capillary tube or 15% bleed expansion valve components.
- This kit allows the indoor fan to continue to run a short time after the outdoor unit shuts off for increased cooling efficiency.
- The kit contains: 1 solid state time delay relay with four (4) color coded wires, 1 wiring diagram, 1 notice label, 1 mounting screw.

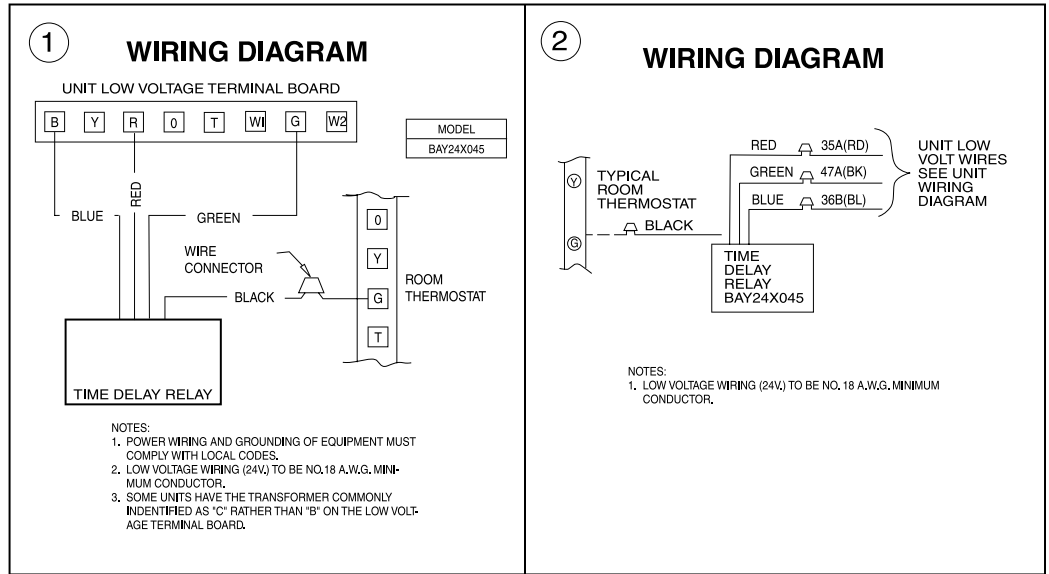

Outdoor Thermostat Kit

TAYSTAT250B

- The outdoor thermostat (ODT) is designed to turn "ON" the supplementary heater at a pre-selected outdoor temperature.
- The number and setting of the ODT is dependent on the heat loss of the structure and capacity of the heating system installed.
- This model ODT gives a temperature range for 44°F. to -10°F. (See figure 1 for settings). The switching action is single pole/double throw, opening on temperature rise and closing on temperature fall, completing the circuit through the thermostat.

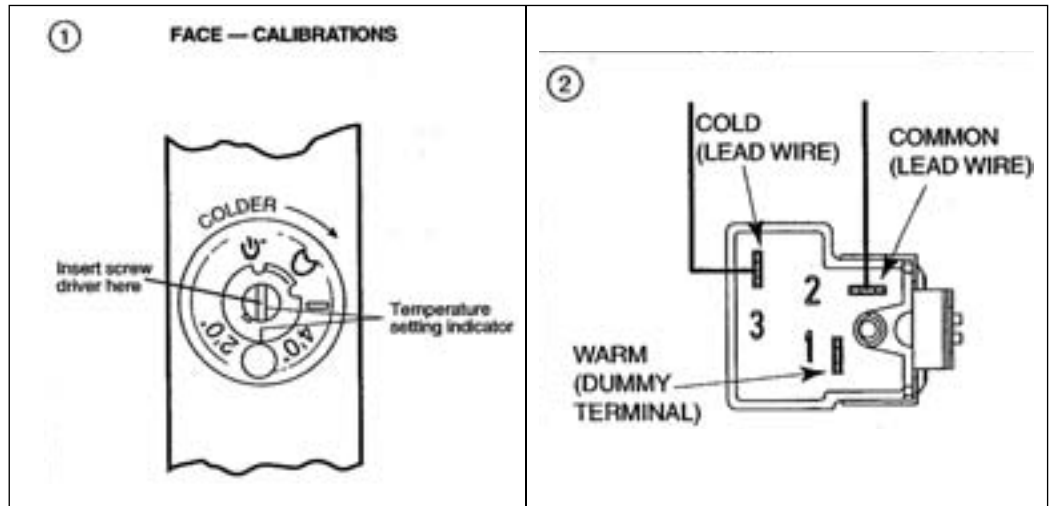

Packaged Cooling Convertible 1½-5 Tons



**4TCY4
Platinum ZM**

Table PK-1-A — 4TCY4 - Platinum ZM (Previously Allegiance® 14) Convertible Packaged Cooling - R-410A

Model Number	Cooling Capacity (Btuh)	SEER/EER	Shipping Weight	MCA	Max Fuse	Sound Rating	Cabinet Dimensions (in.) H x D x W
4TCY4 – 208-230/1/60							
4TCY4024A1000B	23,400	14.00/12.00	444	16.5	25	68	36 x 43 x 51
4TCY4030A1000B	30,000	14.00/12.00	444	19.1	30	71	36 x 43 x 51
4TCY4036B1000B	38,000	14.20/12.00	450	24.6	40	69	36 x 43 x 51
4TCY4042B1000B	42,000	14.25/12.00	607	31.6	50	74	38 x 46 x 61
4TCY4048B1000B	48,000	14.20/12.00	607	35.4	50	72	38 x 46 x 61
4TCY4060A1000B	60,000	14.00/12.00	612	42.3	60	76	42 x 46 x 61
4TCY4 – 208-230/3/60							
4TCY4036B3000A	36,000	14.20/11.60	450	19.8	30	69	36 x 43 x 51
4TCY4048B3000A	48,500	14.20/11.90	607	26.4	40	72	38 x 46 x 61
4TCY4060A3000B	60,000	14.00/12.00	612	30.6	45	76	42 x 46 x 61



**4TCX3
Gold XM**

Table PK-1-B — 4TCX3 - Gold XM (Previously Allegiance® 13) Convertible Packaged Cooling - R-410A

Model Number	Cooling Capacity (Btuh)	SEER/EER	Shipping Weight	MCA	Max Fuse	Sound Rating	Cabinet Dimensions (in.) H x D x W
4TCX3 – 208-230/1/60							
4TCX3018A1000A	18,000	13.00/11.00	444	10.1	15	69	36 x 43 x 51
4TCX3024A1000B	24,000	13.00/11.20	444	13.6	20	70	36 x 43 x 51
4TCX3030A1000B	29,600	13.00/11.00	445	21.7	35	72	36 x 43 x 51
4TCX3036A1000B	36,000	13.00/11.00	450	23.2	35	72	36 x 43 x 51
4TCX3042B1000A	42,000	13.00/11.00	523	27.9	45	72	38 x 46 x 61
4TCX3048A1000B	46,500	13.00/11.00	607	31.1	50	72	38 x 46 x 61
4TCX3060A1000B	60,000	13.00/11.00	610	43.5	60	72	40 x 46 x 61
4TCX3 – 208-230/3/60							
4TCX3036A3000B	36,000	13.00/11.00	450	18.2	30	72	36 x 43 x 51
4TCX3048A3000B	46,500	13.00/11.00	607	23.6	35	72	38 x 46 x 61
4TCX3060A3000B	60,000	13.00/11.00	610	31.7	50	72	40 x 46 x 61
4TCX3 – 460/3/60							
4TCX3036A4000B	36,000	13.00/11.00	450	8.7	15	72	36 x 43 x 51
4TCX3048A4000A	46,500	13.00/11.00	607	11.7	15	72	38 x 46 x 61
4TCX3060A4000B	60,000	13.00/11.00	610	19.5	25	72	40 x 46 x 61



**4TCC3
Silver SI+**

Table PK-1-C — 4TCC3 - Silver SI+ (Previously American Standard 13) Convertible Packaged Cooling - R-410A

Model Number	Cooling Capacity (Btuh)	SEER/EER	Shipping Weight	MCA	Max Fuse	Sound Rating	Cabinet Dimensions (in.) H x D x W
4TCC3 – 208-230/1/60							
4TCC3018A1000A	18,000	13.00/11.00	444	10.1	15	74	36 x 42 x 49
4TCC3024A1000B	23,000	13.00/11.00	444	13.6	20	76	36 x 42 x 49
4TCC3030A1000A	28,000	13.00/10.40	445	21.7	35	75	36 x 42 x 49
4TCC3036A1000B	35,000	13.00/11.00	450	23.2	35	76	36 x 42 x 49
4TCC3042B1000A	40,000	13.00/11.00	523	27.9	45	78	38 x 45 x 59
4TCC3048A1000B	46,500	13.00/11.00	607	31.1	50	80	38 x 45 x 59
4TCC3060A1000B	58,000	13.00/11.00	610	43.5	60	79	40 x 45 x 59
4TCC3 – 208-230/3/60							
4TCC3036A3000B	35,000	13.00/11.00	450	18.2	30	76	36 x 42 x 49
4TCC3048A3000B	46,500	13.00/11.00	607	23.6	35	80	38 x 45 x 59
4TCC3060A3000B	58,000	13.00/11.00	610	31.7	50	79	40 x 45 x 59
4TCC3 – 460/3/60							
4TCC3036A4000B	35,000	13.00/11.00	450	8.7	15	76	36 x 42 x 49
4TCC3048A4000B	46,500	13.00/11.00	607	11.7	15	80	38 x 45 x 59
4TCC3060A4000B	58,000	13.00/11.00	610	19.5	25	79	40 x 45 x 59

For dimensional/outline drawings, please refer to Product Data.

For information on Roof Curbs, please refer to the Accessories/Information Tab.

Packaged Cooling Convertible 1½-5 Tons

Table PK-2-A — Features

	4TCY4 2-5	4TCX3 1½-5	4TCC3 1½-5
• SEER up to	14.25	13.20	13.00
• Exclusive Duration™ high efficiency compressor with internal overload protection.....	✓	✓	—
• Factory supplied charge	R-410A	R-410A	R-410A
• Composite Vortica® indoor blower.....	✓	✓	✓
• High efficiency ECM indoor blower motor with Comfort-R™ airflow system.....	✓	—	—
• Direct drive multi-speed indoor blower motors.....	—	✓	✓
• All aluminum Spine Fin™ outdoor coil.....	✓	✓	✓
• Swept-blade outdoor fan for quiet operation	✓	✓	—
• Architecturally integrated louvers and corner guards.....	✓	✓	—
• All steel louvers	—	—	✓
• Cabinet constructed of heavy gauge, galvanized steel and painted with a weather-resistant powder paint.....	✓	✓	✓
• Single stage cool.....	✓	✓	✓
• Start kit - factory installed (single phase only)	3	1½ & 2	1½ & 2
• High pressure cutout.....	✓	✓	✓
• Low pressure cutout.....	3-Phase Only	3-Phase Only	3-Phase Only
• Liquid line drier - factory installed	✓	✓	✓
• Non-bleed expansion valves on indoor coil.....	✓	✓	✓
• Pressure taps, including liquid line taps, easily accessed and protected inside compressor compartment.....	✓	✓	✓
• Right side electrical service access for high and low voltage connections.....	✓	✓	✓
• Rugged steel basepan features deep drawn duct connections.....	✓	✓	✓
• Steeply sloped composite drainpan.....	✓	✓	✓
• Ships in horizontal configuration and converts quickly for downflow	✓	✓	✓
• Copper tube, aluminum fin indoor coil	✓	✓	✓
• All models are certified to UL 1995.....	✓	✓	✓
• 10-year compressor, 10-year outdoor coil and all other functional parts registered limited warranty (Residential Use)Ⓢ	✓	✓	✓
• Extended warranties available	✓	✓	✓

Ⓢ Registered Limited Warranty terms are available when you register within 60 days of installation. You can register online at americanstandardair.com or by phone at 800-554-8005; otherwise American Standard Heating & Air Conditioning's Base Limited Warranty terms will apply. Base Limited Warranty information on specific products can be found on ASDealerNet.com.

**For dimensional/outline drawings, please refer to Product Data.
For information on Roof Curbs, please refer to the Accessories/Information Tab.**

Table PK-3-A — Accessories

			4TCY4 2-5	4TCX3 1½-5	4TCC3 1½-5
Model Number	Description	Shipping Weight			
BAYACCDOR1A	Hinged Filter Access Door ^⑩		2-3	1½-3	1½-3
BAYACCDOR2A	Hinged Filter Access Door ^⑩		3½-5	3½-5	3½-5
BAYADAP050A	Adapter Curb (Cabinet A/B)		2-3	1½-3	1½-3
BAYADAP051A	Adapter Curb (Cabinet C)		2-3	1½-3	1½-3
BAYADAP052A	Adapter Curb (Cabinet A/B)		3½-5	3½-5	3½-5
BAYADAP053A	Adapter Curb (Cabinet C)		3½-5	3½-5	3½-5
BAYADAP054A	Adapter Curb (Cabinet D)		3½-5	3½-5	3½-5
BAYASCT001	Anti-Short Cycle Timer ^④		✓	✓	✓
BAYCCHT101A	Crankcase Heater (230V) (Reciprocating)		2	1½-2	1½-2
BAYCCHT102A	Crankcase Heater (230V) (Scroll)		2½-5	2½-5	2½-5
BAYCCHT404B	Crankcase Heater (460V) (Scroll)		3,4,5	3,4,5	3,4,5
BAYCOVR112A	12" Duct Shroud (Covers Horizontal Ducts) ^⑤		2-5	1½-5	1½-5
BAYCOVR118A	18" Duct Shroud (Covers Horizontal Ducts) ^⑤		2-5	1½-5	1½-5
BAYCURB050A	Flat Roof Full Perimeter Curb (Insulated)	74	2-3	1½-3	1½-3
BAYCURB051A	Flat Roof Full Perimeter Curb (Insulated)	74	3½-5	3½-5	3½-5
BAYDMPR101A	2-Position Motorized Fresh Air Damper ^{①⑥⑦⑧⑨}		2-3	1½-3	1½-3
BAYDMPR102A	2-Position Motorized Fresh Air Damper ^{①⑥⑦⑧⑨}		3½-5	3½-5	3½-5
BAYECON101A	Economizer with Barometric Relief (Downflow) ^{①②③⑨⑩}	50	2-3	1½-3	1½-3
BAYECON102A	Economizer with Barometric Relief (Downflow) ^{①②③⑨⑩}	65	3½-5	3½-5	3½-5
BAYECON200A	Economizer (Horizontal) ^{①②③⑥}	85	2-3	1½-3	1½-3
BAYECON201A	Economizer (Horizontal) ^{①②③⑥}	85	3½-5	3½-5	3½-5
BAYECON204A	Economizer (Horizontal) ^{①②③⑥}	85	2-5	1½-5	1½-5
BAYENTH001A	Enthalpy Control Kit ^②	2	✓	✓	✓
BAYEXMK001A	Extreme Conditions Mounting Kit (Used on BAYCURB & BAYADAP)		✓	✓	✓
BAYEXMK002B	Extreme Conditions Mounting Kit (Used on BAYUTIL)		✓	✓	✓
BAYEXMK003A	Extreme Conditions Mounting Kit (Used on Slab Mounts)		✓	✓	✓
BAYFLTR101C	1-2" Filter Frame (requires one 20x25 filter which is not included) ^①	6	2-3	1½-3	1½-3
BAYFLTR201C	1-2" Filter Frame (requires one 20x20 and one 20x18 filter which are not included) ^①	6	3½-5	3½-5	3½-5
BAYLIFT002B	Lifting Lug Kit	5	✓	✓	✓
BAYLOAM011A	Evaporator Defrost Control Kit		✓	✓	✓
BAYLOAM105A	Low Ambient Control Kit	5	✓	✓	✓
BAYOSAH001A	Manual Fresh Air Damper ^①	6	2-3	1½-3	1½-3
BAYOSAH002A	Manual Fresh Air Damper ^①	8	3½-5	3½-5	3½-5
BAYQSTK300A	Start Kit		1 Phase Only	1 Phase Only	1 Phase Only
BAYSQRD001A	16" Round Duct Adapter ^⑩	5	2-3	1½-3	1½-3
BAYSQRD002A	18" Round Duct Adapter ^⑩	3	2-5	1½-5	1½-5
BAYUTIL101B	Roof Curb Utility Extension Kit		2-3	1½-3	1½-3
BAYUTIL102B	Roof Curb Utility Extension Kit		3½-5	3½-5	3½-5
BAYUV101A	21" Retrofit UVC Lamp Kit	5	1½-3	1½-3	1½-3
BAYUV102A	33" Retrofit UVC Lamp Kit	5	3½-5	3½-5	3½-5

- ① Must use filter frame when economizer/fresh air kit is used.
- ② Dry bulb control standard with economizer.
- ③ 2-Stage cooling control required when using economizer.
- ④ Do not use with electronic thermostats.
- ⑤ BAYCOVR112,118A will not cover BAYSQRD002A applications.
- ⑥ Does not contain barometric relief.
- ⑦ Max fresh air - 25%.
- ⑧ For non-continuous fan gas-heating applications, the damper opens only when the OD ambient is above 50° F.
- ⑨ It is the designer/engineer's responsibility to review product specifications prior to equipment selection to insure optimal performance and compliance to codes.
- ⑩ Temperature of mixed air entering the heat exchanger is monitored and fresh air intake may be reduced under certain conditions.
- ⑪ BAYACCDOR1A requires BAYFLTR101B & BAYACCDOR2A requires BAYFLTR201B. They are not backward compatible to BAYFLTR101/201A.

EXISTING CURB	NEW UNIT 4TC/MC/YC****A	USE BAYADAP0**A
BAYCURB030,38A	018-036	50
BAYCURB030,38A	042-060	52
BAYCURB033A	018-036	51
BAYCURB033A	018-060	53
BAYCURB034A	042-060	54

**For dimensional/outline drawings, please refer to Product Data.
For information on Roof Curbs, please refer to the Accessories/Information Tab.**

Packaged Cooling Convertible 1½-5 Tons

Table PK-4-A — Supplementary Heaters – Separate power source /power entry required

Model Number	Description	Used With	Shipping Weight
BAYHTRV105E	3.76/5.0 kW Heater (208/240V 1PH)	4TC*3018-060A1,4024-060^1	9
BAYHTRV108E	6.0/8.0 kW Heater (208/240V 1PH)	4TC*3018-060A1,4024-060^1	10
BAYHTRV110E	7.50/10.0 kW Heater (208/240V 1PH)	4TC*3024-060A1,4024-060^1	10
BAYHTRV115E	11.27/15.00 kW Heater (208/240V 1PH)	4TC*3030-060A1,4036-060^1	14
BAYHTRV120E	15.00/20.0 kW Heater (208/240V 1PH)	4TC*3048-060A1,4048-060^1	14
BAYHTRV125E	18.78/25.0 kW Heater (208/240V 1PH)	4TC*3060A1,4048-060^1	21
BAYHTRV305E	3.76/5.0 kW Heater (208/240V 3PH)	4TC*3018-060A3,4036-060A3	9
BAYHTRV308E	6.0/8.0 kW Heater (208/240V 3PH)	4TC*3018-060A3,4036-060A3	10
BAYHTRV310E	7.50/10.0 kW Heater (208/240V 3PH)	4TC*3024-060A3,4036-060A3	10
BAYHTRV315E	11.27/15.00 kW Heater (208/240V 3PH)	4TC*3030-060A3,4036-060A3	14
BAYHTRV320E	15.0/20.0 kW Heater (208/240V 3PH)	4TC*3048-060A3,4048-060A3	14
BAYHTRV325E	18.78/25.0 kW Heater (208/240V 3PH)	4TC*3060A3,4048-060A3	20
BAYHTRV405E	5.0 kW Heater (480V 3PH)	4TC*3018-060A4	9
BAYHTRV408E	8.0 kW Heater (480V 3PH)	4TC*3018-060A4	10
BAYHTRV410E	10.0 kW Heater (480V 3PH)	4TC*3024-060A4	10
BAYHTRV415E	15.00 kW Heater (480V 3PH)	4TC*3030-060A4	14
BAYHTRV420E	20.0 kW Heater (480V 3PH)	4TC*3048-060A4	14
BAYHTRV425E	25.0 kW Heater (480V 3PH)	4TC*3060A4	16

Table PK-4-B — Single Power Entry Kit/Heater Matrix:

Single Power Entry Kit [Ⓞ]	Heater Model	Unit Model	Shipping Weight
BAYSPEK060F	BAYHTRV105E	4TC*3018-048A1,4TCY4024-048^1	3
	BAYHTRV108E	4TC*3018-048A1,4TCY4024-060^1	
	BAYHTRV110E	4TC*3024-036A1,4TCY4024-036^1	
BAYSPEK061E	BAYHTRV305E	4TC*3036-060A3,4TCY4036-060A3	7
	BAYHTRV308E	4TC*3036-060A3,4TCY4036-060A3	
	BAYHTRV310E	4TC*3036-048A3,4TCY4036-048A3	
	BAYHTRV315E	4TC*3036-060A3,4TCY4036-048A3	
	BAYHTRV405E	4TC*3036-060A4	
	BAYHTRV408E	4TC*3036-060A4	
	BAYHTRV410E	4TC*3036-060A4	
	BAYHTRV415E	4TC*3036-060A4	
	BAYHTRV420E	4TC*3048-060A4	
	BAYSPEK062F	BAYHTRV105E	
BAYHTRV108E		4TC*3060^1	
BAYHTRV110E		4TC*3060^1,4TCY4036-060^1	
BAYSPEK063F	BAYHTRV115E	4TC*3030-060A1,4TCY4036-060^1	7
	BAYHTRV120E	4TC*3048-060A1,4TCY4048-060^1	
BAYSPEK064E	BAYHTRV320E	4TC*3048-060A3,4TCY4048-060A3	6

[Ⓞ] All necessary fuses are included in kit; however, not all kits require fuses. Please refer to BAYSPEK Installers Guide.

Note: Replace "" with "C" or "X" as appropriate.

**For dimensional/outline drawings, please refer to Product Data.
For information on Roof Curbs, please refer to the Accessories/Information Tab.**

For complete equipment / combination selections, installation instructions and warranty information, please refer to Product Data/Ratings and/or Installers Guides and Limited Warranty Handbooks.

Packaged Heat Pump Convertible 2-5 Tons



**4WCZ6
Platinum ZM**

**Table PK-5-A — 4WCZ6 - Platinum ZM (Previously Heritage® 16)
Convertible Packaged Heat Pump - R-410A**

Model Number	Capacity	SEER	EER High/Low	HSPF	Shipping Weight	MCA	Max Fuse	Sound Rating	Cabinet Dimensions (in.) H x D x W
4WCZ6 – 208-230/1/60									
4WCZ6036A1000B	36,000	16.40	12.20/13.30	9.00	468	26.2	40	70	38 x 43 x 51
4WCZ6048A1000B	47,500	16.00	12.00/13.60	9.00	607	34.1	50	71	42 x 46 x 61
4WCZ6060A1000B	56,500	15.20	11.50/12.50	8.60	623	37.1	60	73	42 x 46 x 61
4WCZ6 – 208-230/3/60									
4WCZ6036A3000B	36,000	16.40	12.20/13.30	9.00	468	19.1	30	70	38 x 43 x 51
4WCZ6048A3000B	47,500	16.00	12.00/13.60	9.00	607	24.5	35	71	42 x 46 x 61
4WCZ6060A3000B	56,500	15.20	11.50/12.50	8.60	623	30.3	45	73	42 x 46 x 61
4WCZ6 – 460/3/60									
4WCZ6036A4000B	36,000	16.40	12.20/13.30	9.00	468	10.4	15	70	38 x 43 x 51
4WCZ6048A4000B	47,500	16.00	12.00/13.60	9.00	607	15.3	20	71	42 x 46 x 61
4WCZ6060A4000B	56,500	15.20	11.50/12.50	8.60	623	19.2	25	73	42 x 46 x 61



**4DCZ6
Platinum ZM**

**Table PK-5-B — 4DCZ6 - Platinum ZM (Previously Heritage Hybrid™ Comfort 16)
Convertible Packaged Heat Pump - R-410A**

Model Number	Cooling Capacity (BTUH)	Gas Capacity Heating Output (1 Stg./2 Stg.)	SEER/EER	HSPF	AFUE(%)	Shipping Weight	MCA	Max Fuse	Sound Rating	Cabinet Dimensions (in.) H x D x W
4DCZ6 – 208-230/1/60										
4DCZ6036A1075B	35,000	48,400/60,000	16.00 /12.00	9.00	79.5	488	26.2	40	70	38 x 43 x 51
4DCZ6048A1096B	47,500	62,000/77,000	16.00 /12.00	9.00	80.0	665	34.1	50	71	42 x 46 x 61
4DCZ6060A1120B	57,000	77,500/96,000	15.20 /11.50	8.60	80.0	676	37.1	60	73	42 x 46 x 61
4DCZ6 – 208-230/3/60										
4DCZ6036A3075B	35,000	48,400/60,000	16.00 /12.00	9.00	79.5	488	19.1	30	70	38 x 43 x 51
4DCZ6048A3096B	47,500	62,000/77,000	16.00 /12.00	9.00	80.0	665	24.5	35	71	42 x 46 x 61
4DCZ6060A3120B	57,000	77,500/96,000	15.20 /11.50	8.60	80.0	676	30.3	45	73	42 x 46 x 61

**For dimensional/outline drawings, please refer to Product Data.
For information on Roof Curbs, please refer to the Accessories/Information Tab.**

Packaged Heat Pump Convertible 2-5 Tons

**4WCY4
Gold XM**
Table PK-6-A — 4WCY4 - Gold XM (Previously Heritage® 14) Convertible Packaged Heat Pump - R-410A

Model Number	Capacity	SEER/EER	HSPF	Shipping Weight	MCA	Max Fuse	Sound Rating	Cabinet Dimensions (in.) H x D x W	
4WCY4 – 208-230/1/60									
4WCY4024A1000B	23,600	14.00/12.00	8.00	453	16.1	25	68	36 x 43 x 51	
4WCY4030A1000B	30,000	14.25/12.00	8.00	453	19.2	30	71	36 x 43 x 51	
4WCY4036C1000A	37,400	14.25/12.00	8.00	468	24.6	40	69	38 x 43 x 51	
4WCY4042B1000A	42,000	14.00/12.00	8.00	607	30.6	45	74	38 x 46 x 61	
4WCY4048B1000B	47,500	14.00/12.00	8.00	607	33.9	50	73	38 x 46 x 61	
4WCY4060B1000C	58,000	14.00/12.00	8.00	623	39.9	60	76	42 x 46 x 61	
4WCY4 – 208-230/3/60									
4WCY4036B3000A	36,000	14.00/11.75	8.20	468	19.8	30	69	38 x 43 x 51	
4WCY4048A3000C	47,000	14.00/11.75	8.00	607	26.4	40	73	38 x 46 x 61	
4WCY4060A3100C	58,000	14.00/11.50	8.00	623	30.6	45	76	42 x 46 x 61	

**4DCY4
Gold XM**
**Table PK-6-B — 4DCY4 - Gold XM (Previously Heritage Hybrid™ Comfort 14)
Convertible Packaged Heat Pump - R-410A**

Model Number	Cooling Capacity (BTUH)	Gas Capacity Heating Output (1 Stg./2 Stg.)	SEER/EER	HSPF	AFUE(%)	Shipping Weight	MCA	Max Fuse	Sound Rating	Cabinet Dimensions (in.) H x D x W	
4DCY4 – 208-230/1/60											
4DCY4024A1064B	23,600	38,400/51,000	14.00/12.00	8.00	79.0	481	16.1	25	68	36 x 43 x 51	
4DCY4030A1075B	30,000	48,400/60,000	14.25/12.00	8.00	79.5	481	19.1	30	76	36 x 43 x 51	
4DCY4036C1075A	37,400	48,400/60,000	14.25/12.00	8.00	79.5	488	24.6	40	69	38 x 43 x 51	
4DCY4042B1096A	42,000	62,000/77,000	14.00/12.00	8.00	80.0	653	30.8	45	74	38 x 46 x 61	
4DCY4048B1096B	47,500	62,000/77,000	14.00/12.00	8.00	80.0	653	33.9	50	73	38 x 46 x 61	
4DCY4060B1120C	58,000	77,500/96,000	14.00/12.00	8.00	80.0	676	39.9	60	76	42 x 46 x 61	
4DCY4 – 208-230/3/60											
4DCY4036B3075A	36,000	48,400/60,000	14.00/11.40	8.00	79.5	488	19.8	30	69	36 x 43 x 51	
4DCY4048A3096C	47,000	62,000/77,000	14.00/11.75	8.00	80.0	653	26.4	40	73	38 x 46 x 61	
4DCY4060A3120C	58,000	77,500/96,000	14.00/11.50	8.00	80.0	676	30.6	60	76	42 x 46 x 61	

**For dimensional/outline drawings, please refer to Product Data.
For information on Roof Curbs, please refer to the Accessories/Information Tab.**

For complete equipment / combination selections, installation instructions and warranty information, please refer to Product Data/Ratings and/or Installers Guides and Limited Warranty Handbooks.

Packaged Heat Pump Convertible 2-5 Tons

Table PK-7-A — Features

	4WCZ6 3-5	4DCZ6 3-5	4WCY4 2-5	4DCY4 2-5
• SEER up to	16.40	16.00	14.25	14.25
• HSPF up to	9.00	9.00	8.20	8.00
• Exclusive Duration™ high efficiency compressor with internal overload protection.....	✓	✓	✓	✓
• Factory supplied charge.....	R-410A	R-410A	R-410A	R-410A
• Composite Vortica® indoor blower.....	✓	✓	✓	✓
• High efficiency ECM indoor blower motor with Comfort-R™ airflow system.....	✓	✓	✓	✓
• All aluminum Spine Fin™ outdoor coil.....	✓	✓	✓	✓
• Swept-blade outdoor fan for quiet operation.....	✓	✓	✓	✓
• Architecturally integrated louvers and corner guards.....	✓	✓	✓	✓
• Cabinet constructed of heavy gauge, galvanized steel and painted with a weather-resistant powder paint.....	✓	✓	✓	✓
• Stainless steel heat exchanger and burners.....	—	✓	—	✓
• Single stage cool.....	—	—	✓	✓
• Single stage heat.....	—	—	✓	—
• 2-stage gas.....	—	✓	—	✓
• 2-stage heating and cooling.....	✓	✓	—	—
• Start kit - factory installed (single phase only).....	—	—	2 & 2½	2 & 2½
• High pressure cutout.....	✓	✓	✓	✓
• Low pressure cutout.....	✓	✓	✓	✓
• Liquid line drier - factory installed.....	✓	✓	✓	✓
• Non-bleed expansion valves on indoor and outdoor coils.....	✓	✓	✓	✓
• Pressure taps, including liquid line taps, easily accessed and protected inside compressor compartment.....	✓	✓	✓	✓
• Right side electrical service access for high and low voltage connections.....	✓	✓	✓	✓
• Rugged steel basepan features deep drawn duct connections.....	✓	✓	✓	✓
• Steeply sloped composite drainpan.....	✓	✓	✓	✓
• Ships in horizontal configuration and converts quickly for downflow.....	✓	✓	✓	✓
• Copper tube, aluminum fin indoor coil.....	✓	✓	✓	✓
• All models are certified to UL 1995.....	✓	✓	✓	✓
• 20-year heat exchanger, 12-year compressor, 10-year outdoor coil, and 10-year all other functional parts registered limited warranty (Residential Use)①	—	✓	—	—
• 20-year heat exchanger, 10-year compressor, 10-year outdoor coil, and 10-year all other functional parts registered limited warranty (Residential Use)①	—	—	—	✓
• 12-year compressor, 10-year outdoor coil, and 10-year all other functional parts registered limited warranty (Residential Use)①	✓	—	—	—
• 10-year compressor, 10-year outdoor coil, and 10-year all other functional parts registered limited warranty (Residential Use)①	—	—	✓	—
• Extended Warranties Available	✓	✓	✓	✓

① Registered Limited Warranty terms are available when you register within 60 days of installation. You can register online at americanstandardair.com or by phone at 800-554-8005; otherwise American Standard Heating & Air Conditioning's Base Limited Warranty terms will apply. Base Limited Warranty information on specific products can be found on ASDealerNet.com.

**For dimensional/outline drawings, please refer to Product Data.
For information on Roof Curbs, please refer to the Accessories/Information Tab.**

Packaged Heat Pump Convertible 2-5 Tons

Table PK-8-A — Accessories

Model Number	Description	Shipping Weight	4WCZ6 3-5	4DCZ6 3-5	4WCY4 2-5	4DCY4 2-5
BAYACCDOR1A	Hinged Filter Access Door®		3	3	2-3	2-3
BAYACCDOR2A	Hinged Filter Access Door®		4-5	4-5	3½-5	3½-5
BAYADAP050A	Adapter Curb (Cabinet A/B)		3	3	2-3	2-3
BAYADAP051A	Adapter Curb (Cabinet C)		3	3	2-3	2-3
BAYADAP052A	Adapter Curb (Cabinet A/B)		4-5	4-5	3½-5	3½-5
BAYADAP053A	Adapter Curb (Cabinet C)		4-5	4-5	3½-5	3½-5
BAYADAP054A	Adapter Curb (Cabinet D)		4-5	4-5	3½-5	3½-5
BAYASCT001	Anti-Short Cycle Timer①		✓	✓	✓	✓
BAYCCHT101A	Crankcase Heater (230V) (Recip.)		—	—	2	2
BAYCCHT102A	Crankcase Heater (230V) (Scroll)		3, 4, 5	3, 4, 5	3, 5	3, 5
BAYCCHT404B	Crankcase Heater (460V) (Scroll)		3, 4, 5	3, 4, 5	3, 5	3, 5
BAYCOVR112A	12" Duct Shroud (Covers Horizontal Ducts)②		3-5	3-5	2-5	2-5
BAYCOVR118A	18" Duct Shroud (Covers Horizontal Ducts)②		3-5	3-5	2-5	2-5
BAYCURB050A	Flat Roof Full Perimeter Curb (Insulated)	74	1½-3	3	2-3	2-3
BAYCURB051A	Flat Roof Full Perimeter Curb (Insulated)	74	3½-5	4-5	3½-5	3½-5
BAYDMPR101A	2-Position Motorized Damper②⑦⑧⑨⑩		1½-3	3	2-3	2-3
BAYDMPR102A	2-Position Motorized Damper②⑦⑧⑨⑩		4-5	4-5	3½-5	3½-5
BAYECON101A	Economizer with Barometric Relief (Downflow)①②③④⑤⑥		—	—	2-3	2-3
BAYECON102A	Economizer with Barometric Relief (Downflow)①②③④⑤⑥		—	—	3½-5	3½-5
BAYECON103A	Economizer with Barometric Relief (Downflow)①②③④⑤⑥	50	3	3	—	—
BAYECON104A	Economizer with Barometric Relief (Downflow)①②③④⑤⑥	65	4-5	4-5	—	—
BAYECON200A	Economizer (Horizontal)①②③④⑦		—	—	2-3	2-3
BAYECON201A	Economizer (Horizontal)①②③④⑦		—	—	3½-5	3½-5
BAYECON203A	Economizer (Horizontal)①②③④⑦	85	3	3	—	—
BAYECON204A	Economizer (Horizontal)①②③④⑦	85	4-5	4-5	—	—
BAYENTH001A	Enthalpy Control Kit③	2	✓	✓	✓	✓
BAYEXMK001A	Extreme Conditions Mounting Kit		✓	✓	✓	✓
BAYEXMK002B	Extreme Conditions Mounting Kit		✓	✓	✓	✓
BAYEXMK003A	Extreme Conditions Mounting Kit (Used on Slab Mounts)		✓	✓	✓	✓
BAYFLTR101C	1-2" Filter Frame②-Requires one 20x25 filter (not included)	6	3	3	2-3	2-3
BAYFLTR201C	1-2" Filter Frame②-Requires one 20x20, and one 20x18 filters (not included)	6	4-5	4-5	3½-5	3½-5
BAYLIFT002B	Lifting Lug Kit	5	✓	✓	✓	✓
BAYLOAM105A	Low Ambient Control Kit	5	✓	✓	✓	✓
BAYRLAY004A	Economizer Relay①		—	—	✓	✓
BAYRLAY006A	Economizer Relay①	1	✓	✓	—	—
BAYOSAC001B	Outside Air Control for V.S. Economizer®		3,4,5	3,4,5	—	—
BAYOSAH001A	Manual Fresh Air Damper②	6	3	3	2-3	2-3
BAYOSAH002A	Manual Fresh Air Damper②	8	4-5	4-5	3½-5	3½-5
BAYQSTK300A	Start Kit		—	—	1 Phase Only	1 Phase Only
BAYSQRD001A	16" Round Duct Adapter®	5	3	3	2-3	2-3
BAYSQRD002A	18" Round Duct Adapter®	3	4-5	4-5	2-5	2-5
BAYUTIL101B	Roof Curb Extension Kit		3	3	2-3	2-3
BAYUTIL102B	Roof Curb Extension Kit		4-5	4-5	3½-5	3½-5
BAYUV101A	21" Retrofit UVC Lamp Kit	5	3	3	2-3	1½-3
BAYUV102A	33" Retrofit UVC Lamp Kit	5	4-5	4-5	3½-5	3½-5

- ① Relay required with economizer on all heat pump applications.
- ② Must use filter frame when economizer/fresh air kit is used.
- ③ Dry bulb control standard with economizer.
- ④ 2-Stage cooling control required when using economizer.
- ⑤ It is the responsibility of the installing dealer to properly size the ductwork for each specific application.
- ⑥ BAYCOVR112,118A will not cover BAYSQRD002A applications.
- ⑦ Does not contain barometric relief.
- ⑧ Max fresh air - 25%.
- ⑨ For non-continuous fan gas-heating applications, the damper opens only when the OD ambient is above 50° F.
- ⑩ It is the designer/engineer's responsibility to review product specifications prior to equipment selection to insure optimal performance and compliance to codes.
- ⑪ Temperature of mixed air entering the heat exchanger is monitored and fresh air intake may be reduced under certain conditions.
- ⑫ BAYACCDOR1A requires BAYFLTR101B & BAYACCDOR2A requires BAYFLTR201B. They are not backward compatible to BAYFLTR101/201A.
- ⑬ BAYOSAC001B is not compatible with BAYACCDOR1A or BAYACCDOR2A.

EXISTING CURB	NEW UNIT 4TC/WC/YC/DC****A	USE BAYADAP0**A
BAYCURB030,38A	018-036	50
BAYCURB030,38A	018-036	52
BAYCURB030,38A	018-036	51
BAYCURB030,38A	018-036	53
BAYCURB030,38A	018-036	54

**For dimensional/outline drawings, please refer to Product Data.
For information on Roof Curbs, please refer to the Accessories/Information Tab.**

For complete equipment / combination selections, installation instructions and warranty information, please refer to Product Data/Ratings and/or Installers Guides and Limited Warranty Handbooks.

Packaged Heat Pump Convertible 1½-5 Tons



**4WCX3
Gold SI**

Table PK-9-A — 4WCX3 - Gold SI (Previously Heritage® 13) Convertible Packaged Heat Pump - R-410A

Model Number	Capacity	SEER/EER	HSPF	Shipping Weight	MCA	Max Fuse	Sound Rating	Cabinet Dimensions (in.) H x D x W
4WCX3 – 208-230/1/60								
4WCX3018A1000A	18,000	13.00/11.00	7.70	444	10.6	15	69	36 x 43 x 51
4WCX3024B1000A	23,400	13.00/11.50	8.00	453	13.6	20	71	36 x 43 x 51
4WCX3030B1000A	29,200	13.00/11.20	8.00	453	17.0	25	74	36 x 43 x 51
4WCX3036A1000B	35,000	13.00/11.00	7.70	468	25.5	40	71	36 x 43 x 51
4WCX3042B1000A	40,000	13.00/11.00	8.00	560	26.5	40	74	38 x 46 x 61
4WCX3048A1000B	46,000	13.00/10.75	7.70	553	31.1	50	73	38 x 46 x 61
4WCX3060A1000B	58,000	13.00/10.85	7.70	618	43.5	60	72	40 x 46 x 61
4WCX3 – 208-230/3/60								
4WCX3036A3000B	35,000	13.00/11.00	7.70	468	18.2	30	71	36 x 43 x 51
4WCX3048A3000A	46,000	13.00/10.75	7.70	553	23.6	35	73	38 x 46 x 61
4WCX3060A3000B	58,000	13.00/10.85	7.70	618	31.7	50	72	40 x 46 x 61
4WCX3 – 460/3/60								
4WCX3036A4000B	35,000	13.00/11.00	7.70	468	8.7	15	71	36 x 43 x 51
4WCX3048A4000A	46,000	13.00/10.75	7.70	553	11.7	15	73	38 x 46 x 61
4WCX3060A4000B	58,000	13.00/10.85	7.70	618	19.5	25	72	40 x 46 x 61



**4WCC3
Silver SI+**

Table PK-9-B — 4WCC3 - Silver SI+ (Previously American Standard 13) Convertible Packaged Heat Pump - R-410A

Model Number	Capacity	SEER/EER	HSPF	Shipping Weight	MCA	Max Fuse	Sound Rating	Cabinet Dimensions (in.) H x D x W
4WCC3 – 208-230/1/60								
4WCC3018A1000A	18,000	13.00/11.00	7.70	444	10.6	15	74	36 x 42 x 49
4WCC3024B1000A	23,400	13.00/11.00	7.70	453	13.6	20	71	36 x 42 x 49
4WCC3030B1000A	28,000	13.00/11.00	7.70	453	17.0	25	74	36 x 42 x 49
4WCC3036A1000B	35,000	13.00/11.00	7.70	468	25.5	40	75	36 x 42 x 49
4WCC3042B1000A	40,000	13.00/11.00	7.70	560	26.5	40	74	38 x 45 x 59
4WCC3048A1000B	46,000	13.00/10.75	7.70	553	31.1	50	80	38 x 45 x 59
4WCC3060A1000B	58,000	13.00/10.85	7.70	618	43.5	60	79	40 x 45 x 59
4WCC3 – 208-230/3/60								
4WCC3036A3000B	35,000	13.00/11.00	7.70	468	18.2	30	75	36 x 42 x 49
4WCC3048A3000B	46,000	13.00/10.75	7.70	553	23.6	35	80	38 x 45 x 59
4WCC3060A3000B	58,000	13.00/10.85	7.70	618	31.7	50	79	40 x 45 x 59
4WCC3 – 460/3/60								
4WCC3036A4000B	35,000	13.00/11.00	7.70	468	8.7	15	75	36 x 42 x 49
4WCC3048A4000B	46,000	13.00/10.75	7.70	553	11.7	15	80	38 x 45 x 59
4WCC3060A4000B	58,000	13.00/10.85	7.70	618	19.5	25	79	40 x 45 x 59

For dimensional/outline drawings, please refer to Product Data.

For information on Roof Curbs, please refer to the Accessories/Information Tab.

Packaged Heat Pump Convertible 1½-5 Tons

Table PK-10-A — Features

	4WCX3 1½-5	4WCC3 1½-5
• SEER up to	13.00	13.00
• HSPF up to	8.25	7.70
• Exclusive Duration™ high efficiency compressor with internal overload protection.....	✓	—
• Factory supplied charge	R-410A	R-410A
• Composite Vortica® indoor blower	✓	✓
• Direct drive multi-speed indoor blower motors.....	✓	✓
• All aluminum Spine Fin™ outdoor coil	✓	✓
• Swept-blade outdoor fan for quiet operation	✓	—
• Architecturally integrated louvers and corner guards.....	✓	—
• All steel louvers	—	✓
• Cabinet constructed of heavy gauge, galvanized steel and painted with a weather-resistant powder paint.....	✓	✓
• Single stage cool.....	✓	✓
• Start kit - factory installed (single phase only)	1½ - 2½	1½ - 2½
• High pressure cutout.....	✓	✓
• Low pressure cutout.....	✓	✓
• Liquid line drier - factory installed	✓	✓
• Non-bleed expansion valves on indoor and outdoor coils	✓	✓
• Pressure taps, including liquid line taps, easily accessed and protected inside compressor compartment	✓	✓
• Right side electrical service access for high and low voltage connections.....	✓	✓
• Rugged steel basepan features deep drawn duct connections	✓	✓
• Steeply sloped composite drainpan.....	✓	✓
• Ships in horizontal configuration and converts quickly for downflow	✓	✓
• Copper tube, aluminum fin indoor coil	✓	✓
• All models are certified to UL 1995.....	✓	✓
• 10-year compressor, 10-year outdoor coil, and 10-year all other functional parts registered limited warranty (Residential Use)①	✓	✓
• Extended warranties available	✓	✓

① Registered Limited Warranty terms are available when you register within 60 days of installation. You can register online at americanstandardair.com or by phone at 800-554-8005; otherwise American Standard Heating & Air Conditioning's Base Limited Warranty terms will apply. Base Limited Warranty information on specific products can be found on ASDealerNet.com.

**For dimensional/outline drawings, please refer to Product Data.
For information on Roof Curbs, please refer to the Accessories/Information Tab.**

Packaged Heat Pump Convertible 1½-5 Tons

Table PK-11-A — Accessories			4WCX3 1½-5	4WCC3 1½-5
Model Number	Description	Shipping Weight		
BAYACCDOR1A	Hinged Filter Access Door ⁽¹⁴⁾		1½-3	1½-3
BAYACCDOR2A	Hinged Filter Access Door ⁽¹⁴⁾		3½-5	3½-5
BAYADAP050A	Adapter Curb (Cabinet A/B)		1½-3	1½-3
BAYADAP051A	Adapter Curb (Cabinet C)		1½-3	1½-3
BAYADAP052A	Adapter Curb (Cabinet A/B)		3½-5	3½-5
BAYADAP053A	Adapter Curb (Cabinet C)		3½-5	3½-5
BAYADAP054A	Adapter Curb (Cabinet D)		3½-5	3½-5
BAYASCT001	Anti-Short Cycle Timer ⁽⁵⁾		✓	✓
BAYCCHT101A	Crankcase Heater (230V) (Recip.)		1½	1½
BAYCCHT102A	Crankcase Heater (230V) (Scroll)		2-5	2-5
BAYCCHT404B	Crankcase Heater (460V) (Scroll)		3-5	3-5
BAYCOVR112A	12" Duct Shroud (Covers Horizontal Ducts) ⁽⁸⁾		1½-5	1½-5
BAYCOVR118A	18" Duct Shroud (Covers Horizontal Ducts) ⁽⁸⁾		1½-5	1½-5
BAYCURB050A	Flat Roof Full Perimeter Curb (Insulated)	74	2-3	1½-3
BAYCURB051A	Flat Roof Full Perimeter Curb (Insulated)	74	3½-5	3½-5
BAYDMPR101A	2-Position Motorized Damper ⁽²⁾⁽⁹⁾⁽¹⁰⁾⁽¹¹⁾⁽¹²⁾		2-3	1½-3
BAYDMPR102A	2-Position Motorized Damper ⁽²⁾⁽⁹⁾⁽¹⁰⁾⁽¹¹⁾⁽¹²⁾		3½-5	3½-5
BAYECON101A	Economizer with Barometric Relief (Downflow) ⁽¹⁾⁽²⁾⁽⁴⁾⁽⁵⁾⁽¹²⁾⁽¹⁵⁾		1½-3	1½-3
BAYECON102A	Economizer with Barometric Relief (Downflow) ⁽¹⁾⁽²⁾⁽⁴⁾⁽⁵⁾⁽¹²⁾⁽¹⁵⁾		3½-5	3½-5
BAYECON200A	Economizer (Horizontal) ⁽¹⁾⁽²⁾⁽⁴⁾⁽⁵⁾⁽⁹⁾		1½-3	1½-3
BAYECON201A	Economizer (Horizontal) ⁽¹⁾⁽²⁾⁽⁴⁾⁽⁵⁾⁽⁹⁾		3½-5	3½-5
BAYENTH001A	Enthalpy Control Kit ⁽⁴⁾	2	✓	✓
BAYEXMK001A	Extreme Conditions Mounting Kit		✓	✓
BAYEXMK002B	Extreme Conditions Mounting Kit		✓	✓
BAYEXMK003A	Extreme Conditions Mounting Kit (Used on Slab Mounts)		✓	✓
BAYFLTR101C	1-2" Filter Frame-Requires one 20x25 filter. (not included) ⁽²⁾	6	1½-3	1½-3
BAYFLTR201C	1-2" Filter Frame-Requires one 20x20, and one 20x18 filters. (not included) ⁽²⁾	6	3½-5	3½-5
BAYLIFT002B	Lifting Lug Kit	5	✓	✓
BAYLOAM105A	Low Ambient Control Kit	5	✓	✓
BAYRLAY004A	Economizer Relay ⁽¹⁾		✓	✓
BAYOSAC001B	Outside Air Control for V.S. Economizer ⁽¹⁵⁾		3,4,5	3,4,5
BAYOSAH001A	Manual Fresh Air Damper ⁽²⁾	6	1½-3	1½-3
BAYOSAH002A	Manual Fresh Air Damper ⁽²⁾	8	3½-5	3½-5
BAYQSTK300A	Start Kit		1 Phase Only	1 Phase Only
BAYSQRD001A	16" Round Duct Adapter ⁽⁷⁾	5	1½-3	1½-3
BAYSQRD002A	18" Round Duct Adapter ⁽⁷⁾	3	1½-5	1½-5
BAYUTIL101B	Roof Curb Extension Kit		1½-3	1½-3
BAYUTIL102B	Roof Curb Extension Kit		3½-5	3½-5
BAYUV101A	21" Retrofit UVC Lamp Kit	5	1½-3	1½-3
BAYUV102A	33" Retrofit UVC Lamp Kit	5	3½-5	3½-5

- ① Relay required with economizer on all heat pump applications.
- ② Must use filter frame when economizer/fresh air kit is used.
- ③ Ships knocked down.
- ④ Dry bulb control standard with economizer.
- ⑤ 2-Stage cooling control required when using economizer.
- ⑥ Do not use with electronic thermostats.
- ⑦ It is the responsibility of the installing dealer to properly size the ductwork for each specific application.
- ⑧ BAYCOVR112,118A will not cover BAYSQRD002A applications.
- ⑨ Does not contain barometric relief.
- ⑩ Max fresh air - 25%.
- ⑪ For non-continuous fan gas-heating applications, the damper opens only when the OD ambient is above 50° F.
- ⑫ It is the designer/engineer's responsibility to review product specifications prior to equipment selection to insure optimal performance and compliance to codes.
- ⑬ Temperature of mixed air entering the heat exchanger is monitored and fresh air intake may be reduced under certain conditions.
- ⑭ BAYACCDOR1A requires BAYFLTR101B & BAYACCDOR2A requires BAYFLTR201B. They are not backward compatible to BAYFLTR101/201A.
- ⑮ BAYOSAC001B is not compatible with BAYACCDOR1A or BAYACCDOR2A.

EXISTING CURB	NEW UNIT 4TC/WC/YC****A	USE BAYADAP0**A
BAYCURB030,38A	018-036	50
BAYCURB030,38A	042-060	52
BAYCURB033A	018-036	51
BAYCURB033A	018-060	53
BAYCURB034A	042-060	54

**For dimensional/outline drawings, please refer to Product Data.
For information on Roof Curbs, please refer to the Accessories/Information Tab.**

For complete equipment / combination selections, installation instructions and warranty information, please refer to Product Data/Ratings and/or Installers Guides and Limited Warranty Handbooks.

Packaged Heat Pump Convertible 1½-5 Tons

Table PK-12-A — Supplementary Heaters – Separate power source /power entry required

Model Number	Description	Used With	Shipping Weight
BAYHTRV105E	3.76/5.0 kW Heater (208/240V 1PH)	4WC*3018-060^1,4024-060^1,6036-060^1	9
BAYHTRV108E	6.0/8.0 kW Heater (208/240V 1PH)	4WC*3018-060^1,4024-060^1,6036-060^1	10
BAYHTRV110E	7.50/10.0 kW Heater (208/240V 1PH)	4WC*3024-060^1,4024-060^1,6036-060^1	10
BAYHTRV115E	11.27/15.00 kW Heater (208/240V 1PH)	4WC*3030-060^1,4030-060^1,6036-060^1	14
BAYHTRV120E	15.0/20.0 kW Heater (208/240V 1PH)	4WC*3042-060^1,4048-060^1,6048-060^1	14
BAYHTRV125E	18.78/25.0 kW Heater (208/240V 1PH)	4WC*3060A1,4060^1,6048-060^1	21
BAYHTRV305E	3.76/5.0 kW Heater (208/240V 3PH)	4WC*3018-060A3,4036-060A3,6036-060A3	9
BAYHTRV308E	6.0/8.0 kW Heater (208/240V 3PH)	4WC*3018-060A3,4036-060A3,6036-060A3	10
BAYHTRV310E	7.50/10.0 kW Heater (208/240V 3PH)	4WC*3024-060A3,4036-060A3,6036-060A3	10
BAYHTRV315E	11.27/15.00 kW Heater (208/240V 3PH)	4WC*3030-060A3,4036-060A3,6036-060A3	14
BAYHTRV320E	15.00/20.0 kW Heater (208/240V 3PH)	4WC*3048-060A3,4048-060A3,6048-060A3	14
BAYHTRV325E	18.78/25.0 kW Heater (208/240V 3PH)	4WC*3060A3,4060A3,6048-060A3	20
BAYHTRV405E	5.0 kW Heater (480V 3PH)	4WC*3018-060A4,6036-060A4	9
BAYHTRV408E	8.0 kW Heater (480V 3PH)	4WC*3018-060A4,6036-060A4	10
BAYHTRV410E	10.0 kW Heater (480V 3PH)	4WC*3024-060A4,6036-060A4	10
BAYHTRV415E	15.00 kW Heater (480V 3PH)	4WC*3030-060A4,6036-060A4	14
BAYHTRV420E	20.0 kW Heater (480V 3PH)	4WC*3048-060A4,6048-060A4	14
BAYHTRV425E	25.0 kW Heater (480V 3PH)	4WC*3060A4,6048-060A4	16

Table PK-12-B — Single Power Entry Kit/Heater Matrix:

Single Power Entry Kit [Ⓞ]	Heater Model	Unit Model	Shipping Weight
BAYSPEK060F	BAYHTRV105E	4WC*3018-036^1, 4WCY4024-036^1, 4WCZ6036^1	3
	BAYHTRV108E	4WC*3018^1, 4WCY4024^1	
BAYSPEK061E	BAYHTRV305E	4WC*3036-060A3, 4WCY4036-060A3, 4WCZ6036-060A3	7
	BAYHTRV308E	4WC*3036-060A3, 4WCY4036-060A3, 4WCZ6036-060A3	
	BAYHTRV310E	4WC*3036-048A3, 4WCY4036-060A3, 4WCZ6036-048A3	
	BAYHTRV405E	4WC*3036-060A4, 4WCZ6048-060A4	
	BAYHTRV408E	4WCZ6048-060A4	
	BAYHTRV410E	4WC*3036-060A4, 4WCZ6036-060A4	
	BAYHTRV415E	4WC*3036-060A4, 4WCZ6036-060A4	
	BAYHTRV420E	4WC*3036-048A4, 4WCZ6048-060A4	
BAYSPEK062F	BAYHTRV105E	4WC*3048-060^1, 4WCY4048-060^1, 4WCZ6048-060^1	7
	BAYHTRV108E	4WC*3036-060^1, 4WCY4036-060^1, 4WCZ6036-060^1	
	BAYHTRV110E	4WC*3048-060^1, 4WCY4024-060^1, 4WCZ6036-060^1	
BAYSPEK063F	BAYHTRV115E	4WC*3036-060^1, 4WCY4036-060^1, 4WCZ6036-060^1	7
	BAYHTRV120E	4WC*3048-060^1, 4WCY4048-060^1, 4WCZ6048-060^1	
BAYSPEK064E	BAYHTRV315E	4WC*3036-060A3, 4WCY4036-060A3, 4WCZ6036-060A3	6
	BAYHTRV320E	4WC*3048-060A3, 4WCY4048-060A3, 4WCZ6048-060A3	
BAYSPEK065E	BAYHTRV310E	4WC*3060A3, 4WCY4060A3, 4WCZ6060A3	7

Ⓞ All necessary fuses are included in kit; however, not all kits require fuses. Please refer to BAYSPEK Installers Guide.

Note: Replace "" with "C" or "X" as appropriate.

Note: Replace "^" with "A" or "B" as appropriate.

**For dimensional/outline drawings, please refer to Product Data.
For information on Roof Curbs, please refer to the Accessories/Information Tab.**

For complete equipment / combination selections, installation instructions and warranty information, please refer to Product Data/Ratings and/or Installers Guides and Limited Warranty Handbooks.

Packaged Heat Pump Over/Under 2-5 Tons

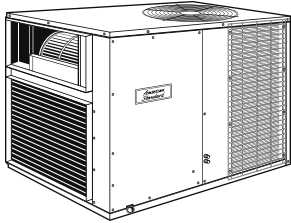

**4WHC3
Silver SI**

- **Duration™** compressor
- Over (supply) under (return) air
- Compressor sump heat
- Compressor internal overload protection
- Solenoid operated switchover valve
- Demand defrost control system
- Multi-speed direct drive blower motor
- High efficiency ECM indoor blower motor on 4WHC3042, 048 and 060 models
- Weather resistant Powder Paint
- Copper tube, aluminum plate fin coils
- Top discharge condensing fan
- Indoor fan relay
- Factory installed wrap-around coil guard
- Top access to supplementary heater
- Expansion valves
- Pressure taps for refrigerant checks
- Polarized plug for easy field connection of low voltage to supplementary heaters
- 4WHC3030-060 contain high efficiency indoor blower motors
- Low ambient cooling to 45°F as manufactured
- Low ambient cooling to 0°F with accessory BAYLOAM011A
- All models are certified to UL 1995
- **10-year registered limited warranty on compressor, outdoor coil and all other functional parts (Residential Use)**
- **Optional extended warranties**

Table PK-13-A — 4WHC3 – Silver SI– Over/Under Horizontal Unit – R-410A

Unit Model No.	Capacity	SEER/EER	HSPF	Dimensions (in.)		Shipping Weight (lbs.)	MCA*	Max Fuse*	Sound Rating
				H x D x W	H x D x W				
4WHC3024A1000A	25,400	13.5/12	7.7	31 x 44 x 32	345	14	20	76	
4WHC3030A1000A	29,400	14/12	8	31 x 44 x 32	345	19	30	75	
4WHC3036A1000A	35,600	13/11	8	31 x 44 x 32	345	22	35	75	
4WHC3042A1000A	41,500	13/11	7.7	31 x 44 x 32	353	31	50	77	
4WHC3048A1000B	47,000	13.5/11	7.7	33 x 58 x 45	520	37	50	80	
4WHC3060A1000B	60,000	13/10.8	7.7	33 x 58 x 45	537	43	60	80	

Tons Supply H x W Return H x W

2 – 3 ^{1/2}	8 ^{3/8} x 27 ^{3/8}	16 ^{3/4} x 27 ^{3/8}
4 – 5	8 ^{1/2} x 32 ^{1/32}	19 ^{15/16} x 32 ^{1/32}

Dimensions are in inches. See Outline Dimensions.

* Information subject to change. Please confirm with current Product Data/Service Facts for current factory production.

Compressor Types are: R1 = Reciprocating One Cylinder, R2 = Reciprocating Two Cylinder, S = Scroll

For dimensional/outline drawings, please refer to Product Data.

For information on Roof Curbs, please refer to the Accessories/Information Tab.

Packaged Gas/Electric Convertible 2-5 Tons

**4YCZ6
Platinum ZM**
Table PK-14-A — 4YCZ6 - Platinum ZM (Previously Triumph® 16)
Convertible Packaged Gas/Electric - R-410A

Model Number	Cooling Capacity (BTUH)	Heating Capacity Output (1 Stg./2 Stg.)	SEER	EER High/Low	AFUE(%)	Shipping Weight	MCA	Max Fuse	Sound Rating	Cabinet Dim. (in.) H x D x W
4YCZ6 – 208-230/1/60										
4YCZ6036A1075B	35,600	45,000/60,000	16.60	12.00/13.60	79.5	488	26.0	40	70	38 x 43 x 51
4YCZ6036A1096B	35,600	57,600/77,000	16.60	12.00/13.60	80.0	488	26.0	40	70	38 x 43 x 51
4YCZ6048A1096B	48,000	57,600/77,000	16.00	12.00/13.48	80.0	659	34.1	50	71	42 x 46 x 61
4YCZ6048A1120B	48,000	72,000/96,000	16.00	12.00/13.48	80.0	665	34.1	50	71	42 x 46 x 61
4YCZ6060A1120B	57,500	72,000/96,000	15.10	11.40/12.64	80.0	676	44.4	60	73	42 x 46 x 61
4YCZ6 – 208-230/3/60										
4YCZ6036A3075B	35,600	45,000/60,000	16.60	12.00/13.60	80.0	488	19.1	30	70	36 x 43 x 51
4YCZ6036A3096B	35,600	57,600/77,000	16.60	12.00/13.60	80.0	493	19.1	30	70	36 x 43 x 51
4YCZ6048A3096B	48,000	57,600/77,000	16.00	12.00/13.48	80.0	659	25.2	35	71	42 x 46 x 61
4YCZ6048A3120B	48,000	72,000/96,000	16.00	12.00/13.48	80.0	665	25.2	35	71	42 x 46 x 61
4YCZ6060A3120B	57,500	72,000/96,000	15.10	11.40/12.65	80.0	676	28.6	40	73	42 x 46 x 61
4YCZ6 – 460/3/60										
4YCZ6036A4075C	35,600	45,000/60,000	16.60	12.00/13.60	79.0	488	10.4	15	70	36 x 43 x 51
4YCZ6036A4096C	35,600	57,600/77,000	16.60	12.00/13.60	80.0	493	10.4	15	70	36 x 43 x 51
4YCZ6048A4096C	48,000	57,600/77,000	16.00	12.00/13.48	80.0	659	15.3	20	71	42 x 46 x 61
4YCZ6048A4120C	48,000	72,000/96,000	16.00	12.00/13.48	80.0	665	15.3	20	71	42 x 46 x 61
4YCZ6060A4120C	57,500	72,000/96,000	15.10	11.40/12.65	80.0	676	17.2	20	73	42 x 46 x 61

**4YCY4
Gold XM**
Table PK-14-B — 4YCY4 - Gold XM (Previously Triumph® 14) Convertible Packaged Gas/Electric - R-410A

Model Number	Cooling Capacity (BTUH)	Heating Capacity Output (1 Stg./2 Stg.)	SEER/EER	AFUE(%)	Shipping Weight	MCA	Max Fuse	Sound Rating	Cabinet Dimensions (in.) H x D x W
4YCY4 – 208-230/1/60									
4YCY4024A1064B	23,400	38,400/51,000	14.00/12.00	79.0	481	16.5	25	68	36 x 43 x 51
4YCY4030A1075B	30,000	45,000/60,000	14.00/12.00	79.5	481	19.2	30	71	36 x 43 x 51
4YCY4036B1075B	38,000	45,000/60,000	14.20/12.00	79.5	488	24.6	40	69	36 x 43 x 51
4YCY4036B1096B	38,000	57,600/77,000	14.20/12.00	80.0	488	24.6	40	69	36 x 43 x 51
4YCY4042B1096B	42,000	57,600/77,000	14.25/12.00	80.0	653	31.5	50	74	38 x 46 x 61
4YCY4048B1096A	48,500	57,600/77,000	14.20/12.00	80.0	669	35.4	50	73	38 x 46 x 61
4YCY4048B1120B	48,500	72,000/96,000	14.20/12.00	80.0	675	35.4	50	73	38 x 46 x 61
4YCY4060A1120B	58,500	72,000/96,000	14.00/12.00	80.0	676	43.3	60	76	42 x 46 x 61
4YCY4 – 208-230/3/60									
4YCY4036B3075A	36,000	45,000/60,000	14.20/11.60	80.0	488	19.8	30	69	36 x 43 x 51
4YCY4036B3096A	36,000	57,600/77,000	14.20/11.60	80.0	493	19.8	30	69	36 x 43 x 51
4YCY4048B3096A	48,000	57,600/77,000	14.20/11.90	80.0	653	26.4	40	73	38 x 46 x 61
4YCY4048B3120A	48,000	72,000/96,000	14.20/11.90	80.0	659	26.4	40	73	38 x 46 x 61
4YCY4060A3120B	58,500	72,000/96,000	14.00/12.00	80.0	676	30.6	45	76	42 x 46 x 61

For dimensional/outline drawings, please refer to Product Data.

For information on Roof Curbs, please refer to the Accessories/Information Tab.

For complete equipment / combination selections, installation instructions and warranty information, please refer to Product Data/Ratings and/or Installers Guides and Limited Warranty Handbooks.

Packaged Gas/Electric Convertible 2-5 Tons

Table PK-15-A — Features

	4YCZ6 3-5	4YCY4 2-5
• SEER up to	16.60	14.25
• Exclusive Duration™ high efficiency compressor with internal overload protection.....	✓	✓
• Factory supplied charge.....	R-410A	R-410A
• Composite Vortica® indoor blower.....	✓	✓
• High efficiency ECM indoor blower motor with Comfort-R™ airflow system.....	✓	✓
• All aluminum Spine Fin™ outdoor coil.....	✓	✓
• Swept-blade outdoor fan for quiet operation.....	✓	✓
• Architecturally integrated louvers and corner guards.....	✓	✓
• Cabinet constructed of heavy gauge, galvanized steel and painted with a weather-resistant powder paint.....	✓	✓
• Stainless steel heat exchanger and burners.....	✓	✓
• Single stage cool.....	—	✓
• 2-stage cooling.....	✓	—
• 2-stage gas.....	✓	✓
• Start kit - factory installed (single phase only).....	—	2 & 2½
• High pressure cutout.....	✓	✓
• Low pressure cutout.....	3-Phase Only	3-Phase Only
• Liquid line drier - factory installed.....	✓	✓
• Non-bleed expansion valves on indoor coil.....	✓	✓
• Pressure taps, including liquid line taps, easily accessed and protected inside compressor compartment.....	✓	✓
• Right side electrical service access for high and low voltage connections.....	✓	✓
• Rugged steel basepan features deep drawn duct connections.....	✓	✓
• Steeply sloped composite drainpan.....	✓	✓
• Ships in horizontal configuration and converts quickly for downflow.....	✓	✓
• Copper tube, aluminum fin indoor coil.....	✓	✓
• All models are certified to ANSI 221.47/CSA 2.3.....	✓	✓
• 20-year heat exchanger, 12-year compressor, 10-year outdoor coil, and 10-year all other functional parts registered limited warranty (Residential Use)①	✓	—
• 20-year heat exchanger, 10-year compressor, 10-year outdoor coil, and 10-year all other functional parts registered limited warranty (Residential Use)①	—	✓
• Extended warranties available	✓	✓

① Registered Limited Warranty terms are available when you register within 60 days of installation. You can register online at americanstandardair.com or by phone at 800-554-8005; otherwise American Standard Heating & Air Conditioning's Base Limited Warranty terms will apply. Base Limited Warranty information on specific products can be found on ASDealerNet.com.

**For dimensional/outline drawings, please refer to Product Data.
For information on Roof Curbs, please refer to the Accessories/Information Tab.**

Packaged Gas/Electric Convertible 2-5 Tons

Table PK-16-A — Accessories

Model Number	Description	Shipping Weight	4YCZ6 3-5	4CY4 2-5
BAYACCDOR1A	Hinged Filter Access Door [Ⓜ]		3	2-3
BAYACCDOR2A	Hinged Filter Access Door [Ⓜ]		3½-5	3½-5
BAYADAP050A	Adapter Curb (Cabinet A/B)		3	2-3
BAYADAP051A	Adapter Curb (Cabinet C)		3	2-3
BAYADAP052A	Adapter Curb (Cabinet A/B)		4-5	3½-5
BAYADAP053A	Adapter Curb (Cabinet C)		4-5	3½-5
BAYADAP054A	Adapter Curb (Cabinet D)		4-5	3½-55
BAYASCT001	Anti-Short Cycle Timer [ⓐ]		✓	✓
BAYCCHT101A	Crankcase Heater (230v) (Reciprocation)		—	2
BAYCCHT102A	Crankcase Heater (230v) (Scroll)		3,4,5	3,4,5
BAYCCHT404B	Crankcase Heater (460v) (Scroll)		3,4,5	3,4,5
BAYCOVR112A	12" Duct Shroud (Covers Horizontal Ducts) [ⓔ]		3-5	2-5
BAYCOVR118A	18" Duct Shroud (Covers Horizontal Ducts) [ⓔ]		3-5	2-5
BAYCURB050A	Flat Roof Full Perimeter Curb (Insulated)	74	3	2-3
BAYCURB051A	Flat Roof Full Perimeter Curb (Insulated)	74	4-5	3½-5
BAYDMPR101A	Motorized Fresh Air Damper ^{Ⓛ⑦⑧⑨⑩}		3	2-3
BAYDMPR102A	Motorized Fresh Air Damper ^{Ⓛ⑦⑧⑨⑩}		4-5	3½-5
BAYECON101A	Economizer with Barometric Relief (Downflow) ^{Ⓛ①②③⑩⑪}	50	—	2-3
BAYECON102A	Economizer with Barometric Relief (Downflow) ^{Ⓛ①②③⑩⑪}	65	—	3½-5
BAYECON103A	Economizer with Barometric Relief (Downflow) ^{Ⓛ①②③⑩⑪}		3	—
BAYECON104A	Economizer with Barometric Relief (Downflow) ^{Ⓛ①②③⑩⑪}		4-5	—
BAYECON200A	Economizer (Horizontal) ^{Ⓛ①②③⑦}	85	—	2-3
BAYECON201A	Economizer (Horizontal) ^{Ⓛ①②③⑦}	85	—	3½-5
BAYECON203A	Economizer (Horizontal) ^{Ⓛ①②③⑦}		3	—
BAYECON204A	Economizer (Horizontal) ^{Ⓛ①②③⑦}		4-5	—
BAYENTH001A	Enthalpy Control Kit [Ⓜ]	2	✓	✓
BAYEXMK001A	Extreme Conditions Mounting Kit (Used on BAYCURB & BAYADAP)		✓	✓
BAYEXMK002B	Extreme Conditions Mounting Kit (Used on BAYUTIL)		✓	✓
BAYEXMK003A	Extreme Conditions Mounting Kit (Used on Slab Mounts)		✓	✓
BAYFLTR101C	1-2" Filter Frame [Ⓛ] -Requires one 20x25 filter (not included)	6	3	2-3
BAYFLTR201C	1-2" Filter Frame [Ⓛ] -Requires one 20x20, and one 20x18 filters (not included)	6	4-5	3½-5
BAYLIFT002B	Lifting Lug Kit	5	✓	✓
BAYLOAM105A	Low Ambient Control Kit	5	✓	✓
BAYLPKT100A	LP Conversion Kit		40K,120K	40K,120K
BAYLPKT101A	LP Conversion Kit		64K,96K	64K, 96K
BAYLPKT102A	LP Conversion Kit		75K	75K
BAYOSAC001B	Outside Air Control for V.S. Economizer [ⓑ]		3,4,5	—
BAYOSAH001A	Manual Fresh Air Damper [Ⓛ]	6	3	2-3
BAYOSAH002A	Manual Fresh Air Damper [Ⓛ]	8	4-5	3½-5
BAYQSTK301A	Start Kit		—	✓
BAYSQRD001A	16" Round Duct Adapter [ⓔ]	5	3	2-3
BAYSQRD002A	18" Round Duct Adapter [ⓔ]	3	4-5	2-5
BAYUTIL101B	Roof Curb Utility Extension Kit		3	2-3
BAYUTIL102B	Roof Curb Utility Extension Kit		4-5	3½-5
BAYUV101A	21" Retrofit UVC Lamp Kit	5	1½-3	1½-3
BAYUV102A	33" Retrofit UVC Lamp Kit	5	3½-5	3½-5

- ① Must use filter frame when economizer/fresh air kit is used.
- ② Dry bulb control standard with economizer.
- ③ 2-Stage cooling control required when using economizer.
- ④ Do not use with electronic thermostats.
- ⑤ It is the responsibility of the installing dealer to properly size the ductwork for each specific application.
- ⑥ BAYCOVR112,118A will not cover BAYSQRD002A applications.
- ⑦ Does not contain barometric relief.
- ⑧ Max fresh air - 25%.
- ⑨ For non-continuous fan gas-heating applications, the damper opens only when the OD ambient is above 50° F.
- ⑩ It is the designer/engineer's responsibility to review product specifications prior to equipment selection to insure optimal performance and compliance to codes.
- ⑪ Temperature of mixed air entering the heat exchanger is monitored and fresh air intake may be reduced under certain conditions.
- Ⓜ BAYACCDOR1A requires BAYFLTR101B & BAYACCDOR2A requires BAYFLTR201B. They are not backward compatible to BAYFLTR101/201A.
- ⓑ BAYOSAC001B is not compatible with BAYACCDOR1A or BAYACCDOR2A

EXISTING CURB	NEW UNIT 2/4TC/WC/YC****A	USE BAYADAP0**A
BAYCURB030,38A	018-036	50
BAYCURB030,38A	042-060	52
BAYCURB033A	018-036	51
BAYCURB033A	042-060	53
BAYCURB034A	042-060	54

**For dimensional/outline drawings, please refer to Product Data.
For information on Roof Curbs, please refer to the Accessories/Information Tab.**

For complete equipment / combination selections, installation instructions and warranty information, please refer to Product Data/Ratings and/or Installers Guides and Limited Warranty Handbooks.

Packaged Gas/Electric Convertible 1½-5 Tons



**4YCX3
Silver SI+**

Table PK-17-A — 4YCX3 - Silver SI+ (Previously Triumph® 13) Convertible Packaged Gas/Electric - R-410A

Model Number	Cooling Capacity (BTUH)	Heating Capacity Input/Output	SEER/EER	AFUE(%)	Shipping Weight	MCA	Max Fuse	Sound Rating	Cabinet Dimensions (in.) H x D x W
4YCX3 – 208-230/1/60									
4YCX3018A1040A	18,000	40,000/31,000	13.00/11.00	79.8	471	10.1	15	69	36 x 43 x 51
4YCX3024B1064B	24,000	64,000/51,000	13.00/11.00	79.0	499	13.6	20	70	36 x 43 x 51
4YCX3030B1075A	28,600	75,000/60,000	13.00/11.00	79.5	481	17.1	25	74	36 x 43 x 51
4YCX3036A1064B	36,000	64,000/51,000	13.00/11.00	80.0	488	25.2	40	71	36 x 43 x 51
4YCX3036A1075B	36,000	75,000/60,000	13.00/11.00	80.0	488	25.2	40	71	36 x 43 x 51
4YCX3036A1096B	36,000	96,000/76,000	13.00/11.00	80.0	493	25.2	40	71	36 x 43 x 51
4YCX3042B1096A	41,500	96,000/77,000	13.00/11.00	80.0	653	26.3	40	74	38 x 46 x 61
4YCX3048A1075B	46,500	75,000/61,000	13.00/11.00	80.0	645	31.5	50	73	38 x 46 x 61
4YCX3048A1096B	46,500	96,000/77,000	13.00/11.00	80.0	653	31.5	50	73	38 x 46 x 61
4YCX3048A1120B	46,500	120,000/95,000	13.00/11.00	80.0	659	31.5	50	73	38 x 46 x 61
4YCX3060A1096B	60,000	96,000/77,000	13.00/10.95	80.0	678	43.3	60	75	40 x 46 x 61
4YCX3060A1120B	60,000	120,000/95,000	13.00/10.95	80.0	684	41.9	60	75	40 x 46 x 61
4YCX3 – 208-230/3/60									
4YCX3036A3064B	36,000	64,000/51,000	13.00/11.00	80.0	493	17.2	25	71	36 x 43 x 51
4YCX3036A3075B	36,000	75,000/60,000	13.00/11.00	80.0	488	17.2	25	71	36 x 43 x 51
4YCX3036A3096B	36,000	96,000/76,000	13.00/11.00	80.0	493	17.2	25	71	36 x 43 x 51
4YCX3048A3075B	46,500	75,000/61,000	13.00/11.00	80.0	645	24.0	35	73	38 x 46 x 61
4YCX3048A3096B	46,500	96,000/77,000	13.00/11.00	80.0	653	24.0	35	73	38 x 46 x 61
4YCX3048A3120B	46,500	120,000/95,000	13.00/11.00	80.0	659	24.0	35	73	38 x 46 x 61
4YCX3060A3096B	60,000	96,000/77,000	13.00/10.95	80.0	678	31.7	50	75	40 x 46 x 61
4YCX3060A3120B	60,000	120,000/95,000	13.00/10.95	80.0	684	28.6	40	75	40 x 46 x 61
4YCX3 – 460/3/60									
4YCX3036A4064B	36,000	64,000/51,000	13.00/11.00	80.0	448	9.5	15	71	36 x 43 x 51
4YCX3036A4075B	36,000	75,000/60,000	13.00/11.00	80.0	448	9.5	15	71	36 x 43 x 51
4YCX3036A4096B	36,000	96,000/76,000	13.00/11.00	80.0	493	9.5	15	71	36 x 43 x 51
4YCX3048A4075B	46,500	75,000/61,000	13.00/11.00	80.0	645	11.7	15	73	38 x 46 x 61
4YCX3048A4096B	46,500	96,000/77,000	13.00/11.00	80.0	653	11.7	15	73	38 x 46 x 61
4YCX3048A4120B	46,500	120,000/95,000	13.00/11.00	80.0	659	11.7	15	73	38 x 46 x 61
4YCX3060A4096A	60,000	96,000/77,000	13.00/10.95	80.0	678	19.5	25	75	40 x 46 x 61
4YCX3060A4120B	60,000	120,000/95,000	13.00/10.95	80.0	684	19.5	25	75	40 x 46 x 61

For dimensional/outline drawings, please refer to Product Data.

For information on Roof Curbs, please refer to the Accessories/Information Tab.

For complete equipment / combination selections, installation instructions and warranty information, please refer to Product Data/Ratings and/or Installers Guides and Limited Warranty Handbooks.

Packaged Gas/Electric Convertible 1½-5 Tons



**4YCC3
Silver SI**

**Table PK-18-A — 4YCC3 Silver SI (Previously American Standard 13)
Convertible Packaged Gas/Electric - R-410A**

Model Number	Cooling Capacity (BTUH)	Heating Capacity Input/Output	SEER/EER	AFUE(%)	Shipping Weight	MCA	Max Fuse	Sound Rating	Cabinet Dimensions (in.) H x D x W
4YCC3 – 208-230/1/60									
4YCC3018A1040A	18,000	40,000/31,000	13.00/11.00	79.8	471	10.1	15	74	36 x 43 x 51
4YCC3024B1064B	23,000	64,000/51,000	13.00/11.00	79.0	481	13.6	20	76	36 x 43 x 51
4YCC3030B1075A	28,000	75,000/60,000	13.00/11.00	79.5	481	17.1	25	74	36 x 43 x 51
4YCC3036A1064B	35,000	64,000/51,000	13.00/11.00	80.0	488	25.2	40	75	36 x 43 x 51
4YCC3036A1075B	35,000	75,000/60,000	13.00/11.00	80.0	488	25.2	40	75	36 x 43 x 51
4YCC3036A1096B	35,000	96,000/76,000	13.00/11.00	80.0	493	25.2	40	75	36 x 43 x 51
4YCC3042B1096A	40,000	96,000/77,000	13.00/11.00	80.0	653	26.3	40	74	38 x 46 x 61
4YCC3048A1075B	46,500	75,000/61,000	13.00/11.00	80.0	645	31.5	50	80	38 x 46 x 61
4YCC3048A1096B	46,500	96,000/77,000	13.00/11.00	80.0	653	31.5	50	80	38 x 46 x 61
4YCC3048A1120B	46,500	120,000/95,000	13.00/11.00	80.0	659	31.5	50	80	38 x 46 x 61
4YCC3060A1096B	58,000	96,000/77,000	13.00/10.95	80.0	678	43.5	60	79	40 x 46 x 61
4YCC3060A1120B	58,000	120,000/95,000	13.00/10.95	80.0	684	41.9	60	79	40 x 46 x 61
4YCC3 – 208-230/3/60									
4YCC3036A3064B	35,000	64,000/51,000	13.00/11.00	80.0	488	17.2	25	75	36 x 43 x 51
4YCC3036A3075B	35,000	75,000/60,000	13.00/11.00	80.0	488	17.2	25	75	36 x 43 x 51
4YCC3036A3096B	35,000	96,000/76,000	13.00/11.00	80.0	493	17.2	25	75	36 x 43 x 51
4YCC3048A3075B	46,500	75,000/61,000	13.00/11.00	80.0	645	24.0	35	80	38 x 46 x 61
4YCC3048A3096B	46,500	96,000/77,000	13.00/11.00	80.0	653	24.0	35	80	38 x 46 x 61
4YCC3048A3120B	46,500	120,000/95,000	13.00/11.00	80.0	659	24.0	35	80	38 x 46 x 61
4YCC3060A3096B	58,000	96,000/77,000	13.00/10.95	80.0	678	31.5	50	79	40 x 46 x 61
4YCC3060A3120B	58,000	120,000/95,000	13.00/10.95	80.0	684	28.6	40	79	40 x 46 x 61
4YCC3 – 460/3/60									
4YCC3036A4064B	35,000	64,000/51,000	13.00/11.00	80.0	488	9.5	15	75	36 x 43 x 51
4YCC3036A4075B	35,000	75,000/60,000	13.00/11.00	80.0	488	9.5	15	75	36 x 43 x 51
4YCC3036A4096B	35,000	96,000/76,000	13.00/11.00	80.0	493	9.5	15	75	36 x 43 x 51
4YCC3048A4075B	46,500	75,000/61,000	13.00/11.00	80.0	645	11.7	15	80	38 x 46 x 61
4YCC3048A4096B	46,500	96,000/77,000	13.00/11.00	80.0	653	11.7	15	80	38 x 46 x 61
4YCC3048A4120B	46,500	120,000/95,000	13.00/11.00	80.0	659	11.7	15	80	38 x 46 x 61
4YCC3060A4096B	58,000	96,000/77,000	13.00/10.95	80.0	678	19.3	25	79	40 x 46 x 61
4YCC3060A4120B	58,000	120,000/95,000	13.00/10.95	80.0	684	19.3	25	79	40 x 46 x 61

For dimensional/outline drawings, please refer to Product Data.

For information on Roof Curbs, please refer to the Accessories/Information Tab.

For complete equipment / combination selections, installation instructions and warranty information, please refer to Product Data/Ratings and/or Installers Guides and Limited Warranty Handbooks.

Packaged Gas/Electric Convertible 1½-5 Tons

Table PK-19-A — Features

	4YCX3 1½-5	4YCC3 1½-5
• SEER up to	13.00	13.00
• Exclusive Duration™ high efficiency compressor with internal overload protection.....	✓	—
• Factory supplied charge.....	R-410A	R-410A
• Composite Vortica® indoor blower.....	✓	✓
• Direct drive multi-speed indoor blower motors.....	✓	✓
• All aluminum Spine Fin™ outdoor coil.....	✓	✓
• Swept-blade outdoor fan for quiet operation	✓	—
• Architecturally integrated louvers and corner guards.....	✓	—
• All steel louvers	—	✓
• Cabinet constructed of heavy gauge, galvanized steel and painted with a weather-resistant powder paint.....	✓	✓
• Stainless steel heat exchanger and burners.....	✓	✓
• Single stage cool.....	✓	✓
• Single stage gas.....	✓	✓
• Start kit - factory installed (single phase only)	1½ - 2½	1½ - 2½
• High pressure cutout.....	✓	✓
• Low pressure cutout.....	3 Phase Only	3 Phase Only
• Liquid line drier - factory installed	✓	✓
• Non-bleed expansion valves on indoor coil.....	✓	✓
• Pressure taps, including liquid line taps, easily accessed and protected inside compressor compartment.....	✓	✓
• Right side electrical service access for high and low voltage connections.....	✓	✓
• Rugged steel basepan features deep drawn duct connections	✓	✓
• Steeply sloped composite drainpan	✓	✓
• Ships in horizontal configuration and converts quickly for downflow	✓	✓
• Copper tube, aluminum fin indoor coil	✓	✓
• All models are certified to ANSI 221.47/CSA 2.3	✓	✓
• 20-year heat exchanger, 10-year compressor, 10-year outdoor coil, and 10-year all other functional parts registered limited warranty (Residential Use)①	✓	—
• 10-year heat exchanger, 10-year compressor, 10-year outdoor coil, and 10-year all other functional parts registered limited warranty (Residential Use)①	—	✓
• Extended warranties available	✓	✓

① Registered Limited Warranty terms are available when you register within 60 days of installation. You can register online at americanstandardair.com or by phone at 800-554-8005; otherwise American Standard Heating & Air Conditioning's Base Limited Warranty terms will apply. Base Limited Warranty information on specific products can be found on ASDealerNet.com.

**For dimensional/outline drawings, please refer to Product Data.
For information on Roof Curbs, please refer to the Accessories/Information Tab.**

Packaged Gas/Electric Convertible 1½-5 Tons

Table PK-20-A — Accessories

			4YCX3 1½-5	4YCC3 1½-5
Model Number	Description	Shipping Weight		
BAYACCDOR1A	Hinged Filter Access Door [Ⓜ]		1½-3	1½-3
BAYACCDOR2A	Hinged Filter Access Door [Ⓜ]		3½-5	3½-5
BAYADAP050A	Adapter Curb (Cabinet A/B)		1½-3	1½-3
BAYADAP051A	Adapter Curb (Cabinet C)		1½-3	1½-3
BAYADAP052A	Adapter Curb (Cabinet A/B)		3½-5	3½-5
BAYADAP053A	Adapter Curb (Cabinet C)		3½-5	3½-5
BAYADAP054A	Adapter Curb (Cabinet D)		3½-5	3½-5
BAYASCT001	Anti-Short Cycle Timer [ⓐ]		✓	✓
BAYCCHT101A	Crankcase Heater (230v) (Reciprocation)		1½-2	1½-2
BAYCCHT102A	Crankcase Heater (230v) (Scroll)		3,4,5	3,4,5
BAYCCHT404B	Crankcase Heater (460v) (Scroll)		3,4,5	3,4,5
BAYCOVR112A	12" Duct Shroud (Covers Horizontal Ducts) [ⓑ]		1½-5	1½-5
BAYCOVR118A	18" Duct Shroud (Covers Horizontal Ducts) [ⓑ]		1½-5	1½-5
BAYCURB050A	Flat Roof Full Perimeter Curb (Insulated)	74	1½-3	1½-3
BAYCURB051A	Flat Roof Full Perimeter Curb (Insulated)	74	3½-5	3½-5
BAYDMPR101A	Motorized Fresh Air Damper [ⓑ] [ⓓ] [ⓔ] [ⓕ] [ⓖ] [ⓗ]		1½-3	1½-3
BAYDMPR102A	Motorized Fresh Air Damper [ⓑ] [ⓓ] [ⓔ] [ⓕ] [ⓖ] [ⓗ]		3½-5	3½-5
BAYECON101A	Economizer with Barometric Relief (Downflow) [ⓑ] [ⓓ] [ⓔ] [ⓕ] [ⓖ] [ⓗ]	50	1½-3	1½-3
BAYECON102A	Economizer with Barometric Relief (Downflow) [ⓑ] [ⓓ] [ⓔ] [ⓕ] [ⓖ] [ⓗ]	65	3½-5	3½-5
BAYECON200A	Economizer (Horizontal) [ⓑ] [ⓓ] [ⓔ] [ⓕ] [ⓖ] [ⓗ]	85	1½-3	1½-3
BAYECON201A	Economizer (Horizontal) [ⓑ] [ⓓ] [ⓔ] [ⓕ] [ⓖ] [ⓗ]	85	3½-5	3½-5
BAYENTH001A	Enthalpy Control Kit [ⓑ]	2	✓	✓
BAYEXMK001A	Extreme Conditions Mounting Kit (Used on BAYCURB & BAYADAP)		✓	✓
BAYEXMK002B	Extreme Conditions Mounting Kit (Used on BAYUTIL)		✓	✓
BAYEXMK003A	Extreme Conditions Mounting Kit (Used on Slab Mounts)		✓	✓
BAYFLTR101C	1-2" Filter Frame [ⓑ] -Requires one 20x25 filter (not included)	6	1½-3	1½-3
BAYFLTR201C	1-2" Filter Frame [ⓑ] -Requires one 20x20, and one 20x18 filters (not included)	6	3½-5	3½-5
BAYLIFT002B	Lifting Lug Kit	5	✓	✓
BAYLOAM105A	Low Ambient Control Kit	5	✓	✓
BAYLPKT100A	LP Conversion Kit		40K, 120K	40K, 120K
BAYLPKT101A	LP Conversion Kit		64K, 96K	64K, 96K
BAYLPKT102A	LP Conversion Kit		75K	75K
BAYOSAH001A	Manual Fresh Air Damper [ⓑ]	6	1½-3	1½-3
BAYOSAH002A	Manual Fresh Air Damper [ⓑ]	8	3½-5	3½-5
BAYQSTK301A	Start Kit		✓	✓
BAYSQRD001A	16" Round Duct Adapter [ⓑ]	5	1½-3	1½-3
BAYSQRD002A	18" Round Duct Adapter [ⓑ]	3	1½-5	1½-5
BAYUTIL101B	Roof Curb Utility Extension Kit		1½-3	1½-3
BAYUTIL102B	Roof Curb Utility Extension Kit		3½-5	3½-5
BAYUV101A	21" Retrofit UVC Lamp Kit	5	1½-3	1½-3
BAYUV102A	33" Retrofit UVC Lamp Kit	5	3½-5	3½-5

ⓑ Must use filter frame when economizer/fresh air kit is used.

ⓓ Dry bulb control standard with economizer.

ⓔ 2-Stage cooling control required when using economizer.

ⓕ Do not use with electronic thermostats.

ⓖ It is the responsibility of the installing dealer to properly size the ductwork for each specific application.

ⓗ BAYCOVR112,118A will not cover BAYSQRD002A applications.

ⓓ Does not contain barometric relief.

ⓔ Max fresh air - 25%.

ⓕ For non-continuous fan gas-heating applications, the damper opens only when the OD ambient is above 50° F.

ⓖ It is the designer/engineer's responsibility to review product specifications prior to equipment selection to insure optimal performance and compliance to codes.

ⓗ Temperature of mixed air entering the heat exchanger is monitored and fresh air intake may be reduced under certain conditions.

ⓓ BAYACCDOR1A requires BAYFLTR101B & BAYACCDOR2A requires BAYFLTR201B. They are not backward compatible to BAYFLTR101/201A.

EXISTING CURB	NEW UNIT 4TC/WC/YC****A	USE BAYADAP**A
BAYCURB030,38A	018-036	50
BAYCURB030,38A	042-060	52
BAYCURB033A	018-036	51
BAYCURB033A	042-060	53
BAYCURB034A	042-060	54

**For dimensional/outline drawings, please refer to Product Data.
For information on Roof Curbs, please refer to the Accessories/Information Tab.**

For complete equipment / combination selections, installation instructions and warranty information, please refer to Product Data/Ratings and/or Installers Guides and Limited Warranty Handbooks.

Variable Speed Packaged Units

AVGX Variable Speed Packaged Heat Pumps

1 2 3 4 5 6 7 8 9 10 11 12 13 14 15
A V G X 0 3 6 T L 1 1 C 1 K A

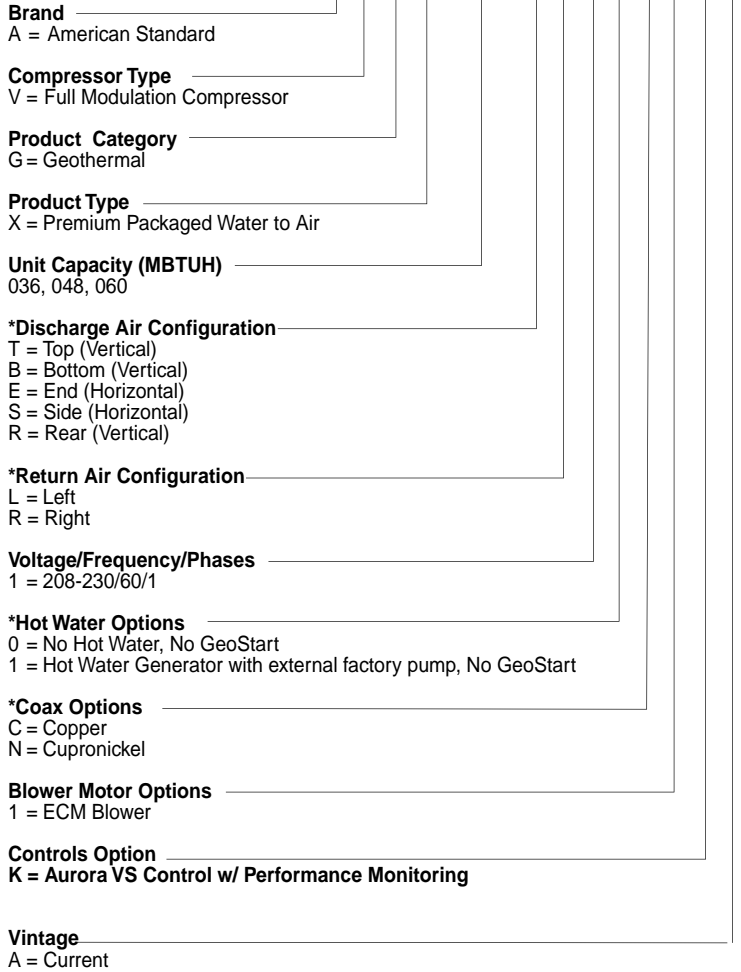

Capacities
Variable Capacities = 036, 048, 060

*Select desired options to create specific model number.

Geothermal

Variable Speed Packaged Units

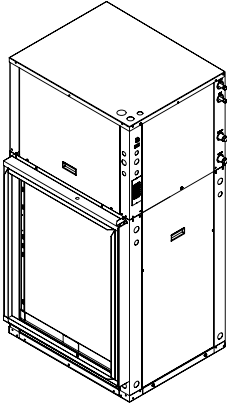

- Extended range operation (20-120°F EWT)
- Earth friendly R-410A refrigerant
- Aurora advanced variable speed control
- "Superboost" cooling mode
- DanFoss Variable Speed Compressor
- Variable Speed ECM fan motor
- FormiShield Plus™ coated air coil
- Electronic expansion valve
- Internal electric heat (optional on vertical units only)
- 1" Swivel fittings
- Gray powder coated heavy guage galvanized cabinet
- Factory computer run test
- ARI/ASHRAE/ISO 13256-1 performance certified and UL/ETL safety listed
- 2" Filter Rack with MERV 11 filter Included
- Horizontal Hanger Kit included for horizontal configurations
- **10-year parts and 10-year labor allowance**

*** Unit includes:**
Refrigerant Monitoring Module
Performance Monitoring Module
Energy Monitoring Module

*** Requires AID Tool**

Table GEO-2-A — VGX - Variable Speed Water Source Heat Pumps

Unit Model No.	Power Supply Volts/Hz/Phase	Nominal Cooling Capacity (Btuh)		Dimensions (in.) [Ⓛ] H x W x L	Shipping Weight (lbs.)	Nominal Supply Opening (WxD) [Ⓛ]	Nominal Return Opening (DxH) [Ⓛ]	Filter Size [Ⓛ]	Water Inlet/Outlet Size	Min Circ Amp ECM 2 Motor	Max Fuse
		ECM 2 Motor	ECM 2 Motor								
AVGX036	208-230/60/1	38,000	38,000	26x32x55	372	18x18	28x30	32x30	1" Swivel	37.3	40
AVGX048	208-230/60/1	49,000	49,000	26x32x55	381	18x18	28x30	32x30	1" Swivel	47.8	50
AVGX060	208-230/60/1	60,000	60,000	26x32x59	405	18x18	28x34	36x30	1" Swivel	54.1	60

[Ⓛ] Vertical Applications.

* For models not listed and unit details, please refer to the Geothermal/Water Source Heat Pump Product Data publication.

Models listed are representative ONLY. Please refer to model nomenclature for product line configuration.

For complete equipment / combination selections, installation instructions and warranty information, please refer to Product Data/Ratings and/or Installers Guides and Limited Warranty Handbooks.

Variable Speed Packaged Units

Table GEO-3-A — Optional Accessories for VGX Units *

Model Number	Description
Thermostats	
TPCC32U01(TRN/AST)	Communicating Color Touchscreen Thermostat w/Energy Monitoring and Humidity Control
TPCM32U04(TRN/AST)	Communicating Thermostat with Energy Monitoring capabilities and Humidity Control (TRN/AST Denotes branding for Thermostat label)
Notes: Must use TPCC32U01, TPCM32U04 or IntelliZone2 - No other thermostats will operate the heat pump.	
Diagnostic Tool	
AIDK01	Aurora Interface Display Service Tool
Variable Speed Flow Center	
FCV1-GL	High impact polystyrene plastic cabinet, one Grundfos Magna Geo 32-140 variable speed pump (1 pump flow center) and one UP26-99 fixed speed pump (2nd pump on 2 pump flow center)
FCV2-GL	
IntelliZone2 with MasterStat and AXB Communication Harness	
IntelliZone 2TA	Communicating Zone System (Only works with XV Series Units)
	Multiple level zone calls communicate exact zone load requirements
	Controls up to 6 zones with Variable Speed units, 4 zones with dual capacity compressor (2 w/ single-speed compressor)
	Direct control of Variable speed ECM fan motor to match needs of the space. 6-8 fan speeds on line, up to 12 speeds available
	Zone sizes as small as 25% of whole house (15% Variable Speed and 25% Dual Capacity)
	Individual zone selectable economy or comfort mode
	Four upstaging options: normal, quicker, faster or faster w/ timer for various application scenarios
	Dehumidification mode lowers airflow in cooling for better dehumidification
	Power consumption displayed on MasterStat for all XV Series with advanced controls
Zone Thermostat	
ZoneStat	Option for any of Zones 2 through 6. Full setback capability with communication to the IntelliZone2 System
Zone Sensor Thermostat	
SensorStat	Option for any of Zones 2 through 6. Full setback capability (through the MasterStat only) with communication to the IntelliZone2 System
Trouble Shooting Kit	
Z2TK	Back plate of the MasterStat w/ harness to plug into IntelliZone2 relay board for set up and service at the zone panel
ZTK240	Zone Transformer Kit - 208/240V - 24V

*Note: These accessories are dedicated for Variable Speed *VGX units ONLY

Table GEO-3-B — Optional Accessories for VGX Units (Non-Dedicated)

Model Number	Description
Vertical Auxilliary Heaters	
EAL10	Internal mount, electronic control board, sequenced operation, - 15-20kW Include internal fuses
EAL15	Internal mount, electronic control board, sequenced operation, - 15-20kW Include internal fuses
EAL20	Internal mount, electronic control board, sequenced operation, - 15-20kW Include internal fuses
Horizontal Auxilliary Heaters	
EALH10	Internal mount control box, coil assembly external mount, electronic control board, sequenced operation, 15-20KW include internal fuses
EALH15	Internal mount control box, coil assembly external mount, electronic control board, sequenced operation, 15-20KW include internal fuses
EALH20	Internal mount control box, coil assembly external mount, electronic control board, sequenced operation, 15-20KW include internal fuses
Air Pads for Vertical Topflow Units	
AP32	AP = High Density Plastic
APF2634	APF = 2" PEX foam, cutable
Electronic Air Cleaner	
EAC3032	Vertical Units (30x32)
EAC3036	Vertical Units (30x36)
EAC3036	Bottom Flow Units (30x36)
EAC2042	Horizontal Units (20x42)
EAC2047	Horizontal Units (20x47)

Water to Air Packaged Units

Geothermal

1GX - 2GX Water Source Heat Pumps

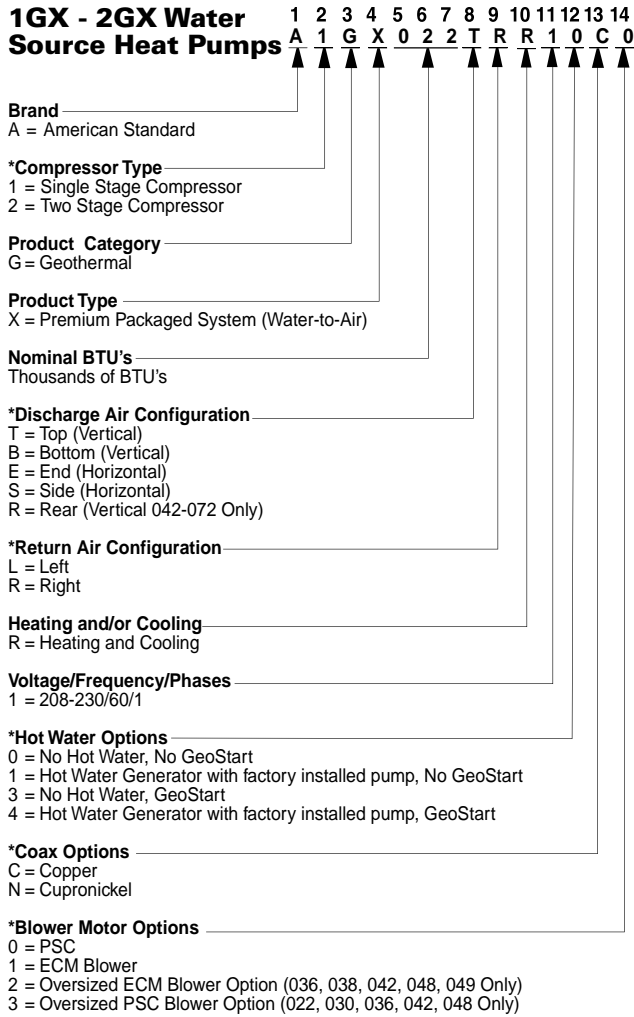

Capacities
 Single = 022, 030, 036, 042, 048, 060, 070
 Dual = 26, 038, 049, 064, 072

*Select desired options to create specific model number.
 Note: All models have sound kits.

Water to Air Packaged Units

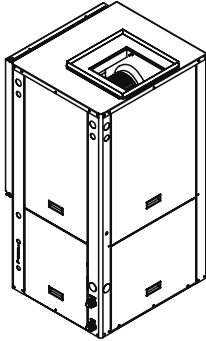

- Extended range operation (20-120°F EWT)
- Earth friendly R-410A refrigerant
- Premier 2 microprocessor based controls with fault indicator lights
- Comfort Alert™ compressor monitor
- Copeland single speed or dual capacity scroll compressor
- PSC Motor or ECM variable speed fan motor
- FormiShield™ coated air coil
- Internal expansion valve
- Optional internal electric heat
- 1" Swivel fittings
- Special gray color powder coated heavy gauge galvanized cabinet
- Factory computer run test
- ARI/ASHRAE/ISO 13256-1 performance certified and UL/ETL safety listed
- 2" Filter Rack with MERV 11 filter Included
- Horizontal Hanger Kit Included
- **10-year parts and 10-year labor allowance**

Table GEO-5-A — 1GX - 2GX Water Source Heat Pumps

Unit Model No.	Power Supply Volts/Hz/Phase	Normal Cooling Capacity (Btuh) ECM 2 Motor	Dimensions (in.) ^① H x W x L	Shipping Weight (lbs.)	Nominal Supply Opening (WxD) ^①	Nominal Return Opening (DxH) ^①	Filter Size ^①	Water Inlet/Outlet Size	Min Circ Amp ECM 2 Motor	Max Fuse
A1GX022	208-230/60/1	21,700	48.4x22.3x26.3	313	14x14	22x26	28x24	1" Swivel	15.2	20
A2GX026	208-230/60/1	27,200	48.4x22.3x26.3	313	14x14	22x26	28x24	1" Swivel	16.8	25
A1GX030	208-230/60/1	29,400	48.4x22.3x26.3	328	14x14	22x26	28x24	1" Swivel	20.0	30
A1GX036	208-230/60/1	35,000	50.4x25.4x31.4	373	18x18	28x26	28x30	1" Swivel	21.6	35
A2GX038	208-230/60/1	40,200	50.4x25.4x31.4	378	18x18	28x26	28x30	1" Swivel	24.8	40
A1GX042	208-230/60/1	42,000	54.4x25.4x31.4	388	18x18	28x30	32x30	1" Swivel	24.8	40
A1GX048	208-230/60/1	49,300	54.4x25.4x31.4	428	18x18	28x30	32x30	1" Swivel	28.8	45
A2GX049	208-230/60/1	50,000	54.4x25.4x31.4	428	18x18	28x30	32x30	1" Swivel	30.4	50
A1GX060	208-230/60/1	66,800	58.4x25.4x31.4	463	18x18	28x34	36x30	1" Swivel	40.0	60
A2GX064	208-230/60/1	67,600	58.4x25.4x31.4	473	18x18	28x34	36x30	1" Swivel	39.0	60
A1GX070	208-230/60/1	73,200	58.4x25.4x31.4	488	18x18	28x34	36x30	1" Swivel	44.6	70
A2GX072	208-230/60/1	73,600	58.4x25.4x31.4	488	18x18	28x34	36x30	1" Swivel	41.0	60

^① Vertical Applications.

* For models not listed and unit details, please refer to the Geothermal/Water Source Heat Pump Product Data publication.

Models listed are representative ONLY. Please refer to model nomenclature for product line configuration.

Water to Air Packaged Units

Table GEO-6-A — Optional Accessories 1GX - 2GX

Model Number	Description	Used With	
		Single Speed Models	Dual Capacity Models
Vertical Auxiliary Heaters			
EAM5	①	022, 030	026
EAM8	①	030	026
EAM10	①	030	026
EAL10	①	036, 042, 048, 060, 070	038, 049, 064, 072
EAL15	①	036, 042, 048, 060, 070	038, 049, 064, 072
EAL20	①	048, 060, 070	049, 064, 072
Horizontal Auxiliary Heaters			
EAMH5	②	022,030	026
EAMH8	②	022,030	026
EAMH10	②	030	026
EALH10	②	036, 042, 048, 060, 070	038, 049, 064, 072
EALH15	②	036, 042, 048, 060, 070	038, 049, 064, 072
EALH20	②	048, 060, 070	049, 064, 072
Air Pads for Vertical Topflow Units			
AP2430	AP= High density plastic	022, 030	026
AP32	AP= High density plastic	036, 042, 048, 060, 070	038, 049, 064, 072
APF2634	APF= 2" PEX foam, cutable	022, 030, 036, 042, 048, 060, 070	026, 038, 049, 064, 072
Thermostats (All Controls- 3H, 2C, Dual Fuel Compatible)			
AZONE950AC52ZA	950 Premium Control (Requires Relay Panel)		
BAY24VRPAC52DA	24 Volt Interface Relay Panel for 950 Control		
ACONT802AS32DA	Programmable Touch Screen Digital Control		
ACONT803AS32DA	Programmable Touch Screen Digital Control with Dehumidification Control		
ACONT402AN32DA	Non-Programmable Comfort Control		
Disposable Pleated Filters, 2" MERV11③			
59P509-04	Vertical Units (24x28)④	022, 030	026
59P509-08	Vertical Units (28x30)	036	038
59P509-07	Vertical Units (30x32)	042, 048	049
59P509-06	Vertical Units (30x36)⑤	060, 070	064, 072
59P509-09	Horizontal Units (18x32)	022, 030	026
59P509-10	Horizontal Units (20x37)	036	049
59P509-02	Horizontal Units (20x20)	042, 048	049
59P509-11	Horizontal Units (20x22)	042, 048, 060, 070	049, 064, 072
59P509-03	Horizontal Units (20x25)	060, 070	064, 072

① Internal Mount, Electronic Control Board, Sequenced Operation, 15-20kW include internal fuses.

② Internal mount control box, coil assembly external mount, Electronic Control Board, Sequenced Operation, 15-20kW include internal fuses (Use on Horizontal & Rear Discharge Units).

③ 6 month life (Minimum order qty. 2).

④ Bottom flow 22-30

⑤ Bottom flow 36-72

Water to Water Packaged Units

1GW Water Packaged Units

1 2 3 4 5 6 7 8 9 10 11 12 13 14
A 1 G W 0 4 0 N N H 1 0 C N

- Brand _____
A = American Standard
- Compressor Type _____
1 = Single Stage Compressor
- Product Category _____
G = Geothermal
- Product Type _____
W = Hydronic Packaged System (Water-to-Water)
- Nominal BTU's _____
Thousands of BTU's
- Discharge Air Configuration _____
N = None
- Return Air Configuration _____
N = None
- *Heating and/or Cooling^① _____
H = Heating Only
R = Heating and Cooling (Reversible)
- Voltage/Frequency/Phases _____
1 = 208-230/60/1
- *Hot Water Options^② _____
0 = No Hot Water, No GeoStart
2 = Hot Water Generator without factory installed pump, No GeoStart
3 = No Hot Water, GeoStart
5 = Hot Water Generator without factory installed pump, GeoStart
- *Coax Options^② _____
C = Copper
N = Cupronickel
L = Source Cupronickel / Load Copper
S = Source Copper / Load Cupronickel
- Blower Motor Options _____
N = None

① Available on 040-075 only. Hot Water Generator requires field installed external pump kit.
② 018-025 heating only models are available only with copper double wall vented load coax for potable water.

2GW Water Packaged Units

1 2 3 4 5 6 7 8 9 10 11 12 13 14
A 2 G W 1 0 0 T N R 1 0 B N

- Brand _____
A = American Standard
- Compressor Type _____
2 = Two Stage Compressor
- Product Category _____
G = Geothermal
- Product Type _____
W = Hydronic Packaged System (Water-to-Water)
- Nominal BTU's _____
Thousands of BTU's
- Discharge Configuration _____
T = Top Mounted Connections
R = Rear Mounted Connections
- Return Air Configuration _____
N = None
- Heating and/or Cooling _____
R = Heating and Cooling (Reversible)
- Voltage/Frequency/Phases _____
1 = 208-230/60/1
- Hot Water Options _____
0 = No Hot Water, No GeoStart
3 = No Hot Water, GeoStart
- Coax Options _____
B = Brazed plate
- Blower Motor Options _____
N = None

Geothermal

Water to Water Packaged Units

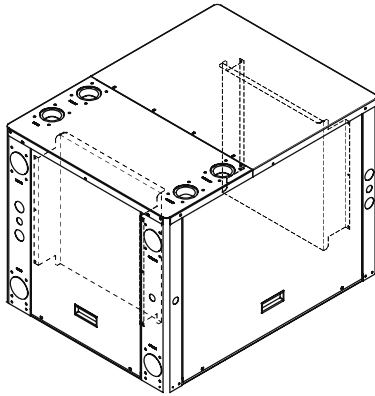

1GW Series

- Extended range operation (20-120° F EWT)
- Earth friendly R-410A refrigerant
- GW series microprocessor based controls
- Scroll (single speed) compressors
- Expansion valve
- Special gray powder coated cabinet
- Factory computer run test
- ARI/ASHRAE/ISO 13256-1 performance certified and UL/ETL safety listed
- Fully insulated cabinet, coax HE, water piping and ref. lines
- Adjust temperature and configuration from control panel on front of units
- **10-year parts and 10-year labor allowance**

2GW Series

- Ultra-compact 25"W x 33"D x 24"H
- Standard waterlines out the back or front (field convertible via control box)
- Factory optional top waterlines
- High efficiency brazed plate heat exchanger
- High efficiency scroll compressors (2)
- Optional GeoStart
- FX10 control package with MUI interface
- Performance monitoring and communication through standard DDC protocols
- **10-year parts and 10-year labor allowance**

Geothermal

Table GEO-8-A — 1GW - 2GW Hydronic Heat Pumps

Unit Model No.	Power Supply Refrigerant Volts/Hz/Phase	Normal Cooling Capacity (Btuh)	Normal Heating Capacity (Btuh)	Dimensions (in.) H x W x D	Shipping Weight (lbs.)	Water Supply and Return Size	Min Circ Amp	Max Fuse
A1GW018	208-230/60/1	17,300	15,000	26.1x19.5x23.5	213	1	20.1	30
A1GW025	208-230/60/1	24,700	22,000	26.1x19.5x23.5	247	1	24.1	35
A1GW040	208-230/60/1	37,700	31,000	26.2x22.0x31.0	305	1	32.2	50
A1GW050	208-230/60/1	51,500	44,000	26.2x22.0x31.0	340	1 ^{1/4}	40.2	60
A1GW060	208-230/60/1	58,000	50,000	26.2x22.0x31.0	360	1 ^{1/4}	44.8	70
A1GW075	208-230/60/1	68,400	62,000	26.2x22.0x31.1	360	1 ^{1/4}	40.8	60
A2GW100	208-230/60/1	100,000	82,000	24.1x25.58x33.6	385	2	33.0/41.4	50/60
A2GW120	208-230/60/1	114,000	93,000	24.1x25.58x33.6	395	2	37.6/46.0	60/70
A2GW150	208-230/60/1	147,000	123,000	24.1x25.58x33.6	395	2	33.6/42.0	60/60
A2GW180	208-230/60/1	165,000	139,000	24.1x25.58x33.6	415	2	40.1/48.5	70/80

*For models not listed and unit details, please refer to the Geothermal Hydronic Heat Pump Product Data publication.

Models listed are representative ONLY. Please refer to model nomenclature for product line configuration.

For complete equipment / combination selections, installation instructions and warranty information, please refer to Product Data/Ratings and/or Installers Guides and Limited Warranty Handbooks.

Water to Water Packaged Units

Table GEO-9-A — Optional Accessories 1GW

Model Number	Description	Used With
Circulating Pump Kits		
24S516-10	Load-side low flow pump (Potable Water)	018, 025
EWPK1①	Load-side pump kit, 1" cast iron volute	018, 025, 040
EWPK2	Load-side pump kit, 1" bronze volute	018, 025
EWPK3①	Load-side pump kit, 1 1/4" cast iron volute	050, 060, 075
13P003B	Low voltage pump signal relay (combined source pumps)	018, 025, 040, 050, 060, 075
Water Connection Kits		
MA4FPT	1" MPT x 1" FPT w/1/4 tap, Load Side W-W	018, 025, 040
MA5FPT	1 1/4" MPT x 1" FPT w/1/4 tap, Load Side W-W	050, 060, 075
2-HVAC-1.00X24	Stainless steel hose kit 1"	018, 025, 040
2-HVAC-1.25X24	Stainless steel hose kit 1 1/4"	050, 060, 075
Hot Water Generator Pump Kit		
DPK5	Includes 230v 1/25 hp pump and fittings	040, 050, 060, 075
Air Pads		
AP2430	AP= High density plastic	018, 025, 040
AP32	AP= High density plastic	050, 060, 075
APF2428	2" PEX foam, cutable	018, 025
APF2634	2" PEX foam, cutable	040, 050, 060, 075

① Not for use in 018 and 025 potable water applications.

Table GEO-9-B — Optional Accessories 2GW

Model Number	Description
Hose Kits ②	
CR6UBY-200-24	2" Stainless Steel hose kit, Y-Strainer, ball valves, and end fittings
Water Connection Kit ①	
CKNDW1	Source side OR Load side unit fittings, P/T plugs
Large Flow Centers ②	
FCL1-5028	1 Grundfos 3 speed pump (28 feet of head at 50 GPM)
FCL2-5028	2 Grundfos 3 speed pump (56 feet of head at 50 GPM)
FCL1-5038	1 Grundfos 3 speed pump (38 feet of head at 50 GPM)
FCL2-5038	2 Grundfos 3 speed pump (76 feet of head at 50 GPM)
FCL1-5055	1 Grundfos 3 speed pump (55 feet of head at 50 GPM)
FCL2-5055	2 Grundfos 3 speed pump (110 feet of head at 50 GPM)
Load-Side Pump (pump and 2 "GL" fittings) ②	
PML32-160	1 Grundfos 3 speed pump (28 feet of head at 50 GPM)
PML40-160	1 Grundfos 3 speed pump (38 feet of head at 50 GPM)
PML40-240	1 Grundfos 3 speed pump (55 feet of head at 50 GPM)
Large Flow Centers Fittings (sets of 2) ②	
GL6FPT	1.5" FPT X 2" GeoLink
GL8FPT	2" FPT X 2" GeoLink
GL-FPL	Flushing Adapter
Flow Switch Kit	
FPS300	Flow Switch Kit
Connection Kit	
CK5L	1 1/4" MPT X 1 1/4" hose barb, brass elbow w/ 1/4" P/T plugs
Rubber Hose Kit w/ Strainer	
CK5L-XLS	CK5L, 2 - 8' 1 1/4" rubber hose, pair 1 1/4" hose barb x 1 1/4 XL style fittings, steel hose clamps, with mesh bronze strainer

① This part can be used for both load and source side. 2 kits will need to be purchased for fittings for both sides.

② Drop shipped from vendor. Does not include freight.

HydroZone™ Control

- Water to Water Load Side Zone Control
- Menu Driven Software
- Adjustable setpoints and deadbands
- Three control strategies
- Lead/Lag logic
- Utilizes Geo Storage tank sensor
- **5-year parts & labor allowance warranty included in list price**



Table GEO-10-A — HydroZone™ Control

Model Number	Specification
HZC	HydroZone™ Control Panel
HZ0	HydroZone™ Control with signal isolation board- 0 Zone (24V only)
HZ04A9NN	HydroZone™ Control with signal isolation board- 4 Zone 115V output (pump)
HZ04AANN	HydroZone™ Control with signal isolation board- 4 Zone 24V output (valve)
HZ08A9NN	HydroZone™ Control with signal isolation board- 8 Zone 115V output (pump)
HZ08AANN	HydroZone™ Control with signal isolation board- 8 Zone 24V output (valve)
HZ12A9NN	HydroZone™ Control with signal isolation board- 12 Zone 115V output (pump)
HZ12AANN	HydroZone™ Control with signal isolation board- 12 Zone 24V output (valve)
HZ12A9EN	HydroZone™ Control with signal isolation board- 12 Zone 115V output (pump)
HZ12AAEN	HydroZone™ Control with signal isolation board- 12 Zone 24V output (valve)
HZAB	HydroZone™ Accessory Box (water heater or pump control)
L37-346	3/4" SWT Zone Valve Motorized Sweat (Qty 1)
L37-347	1" SWT Zone Valve Motorized Sweat (Qty 1)
TSU02	Outdoor Air Sensor (required with "outdoor reset control")

Note: HZ0 is for tank control only with no zones.

Triple Function Hybrid Water to Air Systems

GY Series Hybrid Systems

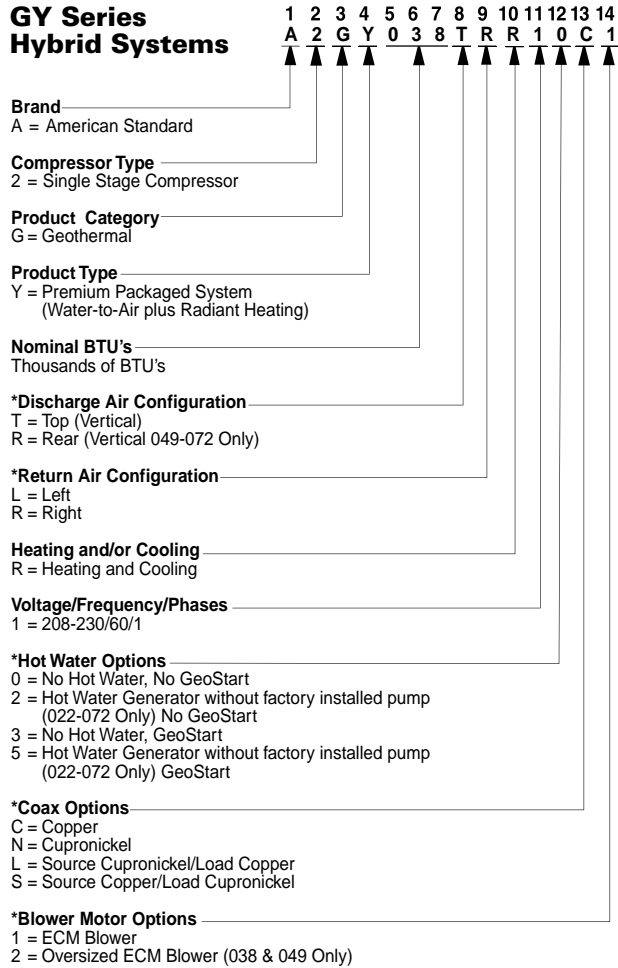

Capacities
Two Stage = 038, 049, 064, 072

*Select desired options to create specific model number.
Note: The factory installed water option (hot water generator) does not include factory mounted circulating pump or temperature control.
DPK5 (ordered separately) includes field installed circulator, hot water tank adaptor, temperature limit and installation instructions.

Geothermal

Triple Function Hybrid Water to Air Systems

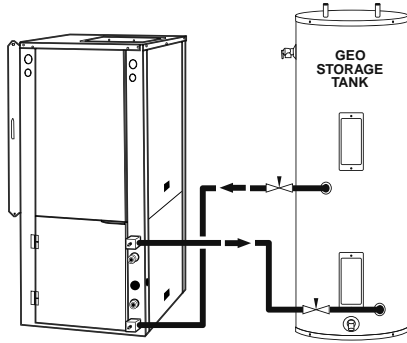

- Extended range operation (20-120°F EWT)
- Hybrid "3 in 1" system-space heat, space cool, hot water to radiant floor zones
- Optional hot water generator
- Earth friendly R-410A refrigerant
- Premier 2 microprocessor based controls
- Copeland dual capacity scroll Compressor
- ECM variable speed fan motor
- FormiShield™ coated air coil
- Expansion valve
- Optional internal electric heat
- 1" Swivel fittings
- Special gray powder coated heavy gauge galvanized cabinet
- Factory computer run test
- ARI/ASHRAE/ISO 13256-1 performance certified and UL/ETL safety listed
- 2" filter rack with MERV 11 filter Included
- **10-year parts and 10-year labor allowance**

Table GEO-12-A — GY Series Hybrid Systems

Unit Model No.	Power Supply Volts/Hz/Phase	Nominal Cooling Capacity (Btuh)	Dimensions (in.) H x W x L	Shipping Weight (lbs.)	Supply Opening (WxD)	Return Opening (DxH)	Filter Size	Water Inlet/Outlet Size	Min Circ Amp	Max Fuse
A2GY038	208-230/60/1	35,200	50.4x25.6x31.6	445	18x18	28x26	28x30	1" Swivel	31.2	45
A2GY049	208-230/60/1	43,800	54.4x25.6x31.6	550	18x18	28x30	32x30	1" Swivel	36.8	50
A2GY064	208-230/60/1	59,400	58.4x25.6x31.6	560	18x18	28x34	36x30	1" Swivel	45.5	70
A2GY072	208-230/60/1	69,100	58.4x25.6x31.6	560	18x18	28x34	36x30	1" Swivel	47.5	70

* For models not listed and unit details, please refer to the Geothermal Heat Pump with Water Heating for Radiant Floor Applications Product Data publication.

Table GEO-12-B — Optional Accessories

Model Number	Description	Used With
Disposable Pleated Filters, 2" MERV11^①		
59P509-08	Vertical Units (28x30)	038
59P509-07	Vertical Units (30x32)	049
59P509-06	Vertical Units (30x36)	064, 072
Air Pads for Vertical Units		
AP32	AP - High density plastic	038, 049, 064, 072
APF2634	APF - 2" PEX foam, cutable	038, 049, 064, 072
Vertical Auxiliary Heaters		
EAL10 ^②	Vertical Auxiliary Heaters	038, 049, 064, 072
EAL15 ^②	Vertical Auxiliary Heaters	038, 049, 064, 072
EAL20 ^②	Vertical Auxiliary Heaters	049, 064, 072
Horizontal Auxiliary Heaters		
EALH10 ^②	Horizontal Units (Rear Discharge Units Only)	038, 049, 064, 072
EALH15 ^②	Horizontal Units (Rear Discharge Units Only)	038, 049, 064, 072
EALH20 ^②	Horizontal Units (Rear Discharge Units Only)	049, 064, 072
Hot Water Generator Pump Kit		
DPK5 ^⑤		038, 049, 064, 072
Thermostats (All Controls- 3H, 2C, Dual Fuel Compatible)		
AZONE950AC52ZA	950 Premium Control (Requires Relay Panel)	
BAY24VRPAC52DA	24 Volt Interface Relay Panel for 950 Control	
ACONT802AS32DA	Programmable Touch Screen Digital Control	
ACONT803AS32DA	Programmable Touch Screen Digital Control with Dehumidification Control	
ACONT402AN32DA	Non-Programmable Comfort Control	

① Minimum order qty. 2.
 ② Bottom Flow 36-72.
 ③ Sequenced Operation, 15-20kW include internal fuses.
 ④ Sequenced Operation, 15-20kW include internal fuses. Rear discharge units only.
 ⑤ Must be purchased with any Y with hot water generator option.
 Note: For hydronic accessories, please see hydronic price book.

Models listed are representative ONLY. Please refer to model nomenclature for product line configuration.

Split Heat Pump Units

2GN Indoor Split Heat Pumps

1 2 3 4 5 6 7 8 9 10 11 12 13 14
A 2 G N 0 2 2 N N R 1 0 C N

- Brand _____
A = American Standard
- *Compressor Type _____
2 = Two Stage Compressor
- Product Category _____
G = Geothermal
- Product Type _____
N = Premium Split System Interior Grade
- Nominal BTU's _____
Thousands of BTU's
- Discharge Air Configuration _____
N = None
- Return Air Configuration _____
N = None
- Heating and/or Cooling _____
R = Heating and Cooling
- Voltage/Frequency/Phases _____
1 = 208-230/60/1
- *Hot Water Options _____
0 = No Hot Water, No GeoStart
1 = Hot Water Generator with external factory pump, No GeoStart
3 = No Hot Water, GeoStart
4 = Hot Water Generator with external factory pump, GeoStart
- *Coax Options _____
C = Copper
N = Cupronickel
- Blower Motor Options _____
N = None
- Capacities _____
Dual = 026, 038, 049, 064

*Select desired options to create specific model number.

GE Outdoor Split Heat Pumps

1 2 3 4 5 6 7 8 9 10 11 12 13 14
A 2 G E 0 2 6 N N R 1 0 C N

- Brand _____
A = American Standard
- Compressor Type _____
2 = Two Stage Compressor
- Product Category _____
G = Geothermal
- Product Type _____
E = Premium Split System Exterior Grade
- Nominal BTU's _____
Thousands of BTU's
- Discharge Air Configuration _____
N = None
- Return Air Configuration _____
N = None
- Heating and/or Cooling _____
R = Heating and Cooling
- Voltage/Frequency/Phases _____
1 = 208-230/60/1
- *Hot Water Options _____
0 = No Hot Water, No GeoStart
3 = No Hot Water, GeoStart
- *Coax Options _____
C = Copper
N = Cupronickel
- Blower Motor Options _____
N = None
- Capacities _____
Dual = 026, 038, 049, 064

*Select desired options to create specific model number.

Geothermal

Split Heat Pump Units

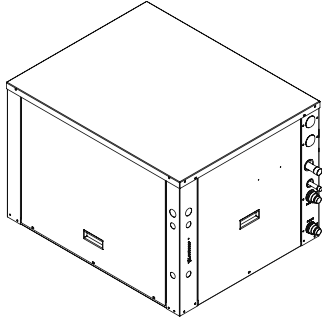

- Extended range operation (20-120°F EWT)
- Earth friendly R-410A refrigerant
- Dual capacity scroll compressor
- Premier 2 microprocessor based controls with fault Indicator Lights
- Expansion valve
- 1" Swivel fittings
- Special gray powder coated heavy gauge galvanized cabinet
- Accumulator on all models
- Factory computer run test
- ARI/ASHRAE/ISO 13256-1 performance certified and UL/ETL safety listed
- **10-year parts and 10-year labor allowance**

Table GEO-14-A — 2GN Indoor Split Heat Pumps

Unit Model No.	Power Supply Volts/Hz/Phase	Normal Cooling Capacity (Btuh)	Dimensions (in.) H x W x L	Shipping Weight (lbs.)	Refrigerant Suction Line ①	Refrigerant Liquid Line ①	Min Circ Amp	Max Fuse
A2GN026	208-230/60/1	26,200	19.5x22.5x26.5	209	5/8	3/8	18.6	25
A2GN038	208-230/60/1	35,000	21.25x25.5x31.5	256	3/4	3/8	26.6	40
A2GN049	208-230/60/1	47,700	21.25x25.5x31.5	270	3/4	3/8	32.2	50
A2GN064	208-230/60/1	59,100	21.25x25.5x31.5	291	7/8	1/2	37.8	60
A2GN072	208-230/60/1	62,700	21.25x25.5x31.5	310	7/8	1/2	39.8	60

① 20' Line Set Length. Consult Guide for other lengths.

* For models not listed and unit details, please refer to the Geothermal Indoor Split Heat Pump Product Data publication.

Table GEO-14-B — Optional Accessories

Model Number	Description	Used With
Air Pads		
AP32	AP= High density plastic	026, 038, 049, 064, 072
APF2634	APF= 2" PEX foam, cutable	026, 038, 049, 064, 072
Thermostats (All Controls- 3H, 2C, Dual Fuel Compatible)		
AZONE950AC52ZA	950 Premium Control (Requires Relay Panel)	
BAY24VRPAC52DA	24 Volt Interface Relay Panel for 950 Control	
ACONT802AS32DA	Programmable Touch Screen Digital Control	
ACONT803AS32DA	Programmable Touch Screen Digital Control with Dehumidification Control	
ACONT402AN32DA	Non-Programmable Comfort Control	

Models listed are representative ONLY. Please refer to model nomenclature for product line configuration.

Split Heat Pump Units

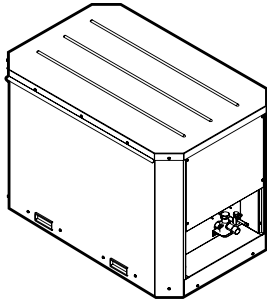

- Extended range operation (20-120°F EWT)
- Earth Friendly R-410A Refrigerant
- Rated for outdoor installation
- Premier 2 microprocessor based controls with fault indicator lights
- Copeland 2 stage scroll compressor
- Expansion valve
- Gray powder coated heavy gauge galvanized cabinet
- Accumulator on all models
- Factory computer run test
- ARI/ASHRAE/ISO 13256-1 performance certified and UL/ETL safety listed
- Internally mounted flow center in cabinet (factory installed)
- **10-year parts and 10-year labor allowance**

Table GEO-15-A — 2GE Outdoor Split Heat Pumps

Unit Model No.	Power Supply Volts/Hz/Phase	Nominal Cooling Capacity (Btuh)	Dimensions (in.) H x W x L	Shipping Weight (lbs.)	Refrigerant Suction Line ①	Refrigerant Liquid Line ①	Min Circ Amp	Max Fuse
A2GE026	208-230/60/1	26,200	26.7x36.0x23.9	209	5/8	3/8	17	25
A2GE038	208-230/60/1	35,000	26.7x36.0x23.9	256	3/4	3/8	23.4	40
A2GE049	208-230/60/1	47,700	26.7x36.0x23.9	270	3/4	3/8	27.9	50
A2GE064	208-230/60/1	59,100	26.7x36.0x23.9	291	7/8	1/2	32.4	60
A2GE072	208-230/60/1	62,700	26.7x36.0x23.9	310	7/8	1/2	34	60

① 20' Line Set Length. Consult Guide for other lengths.

* For models not listed and unit details, please refer to the Geothermal/Water Source Outdoor Split Heat Pump Product Data publication.

Table GEO-15-B — Optional Accessories

Model Number	Description	All GE Unit Sizes
Mounting Pad		
AP3042	Bramec III, 6"x 6" modular construction	
Thermostats (All Controls- 3H, 2C, Dual Fuel Compatible)		
AZONE950AC52ZA	950 Premium Control (Requires Relay Panel)	
BAY24VRPAC52DA	24 Volt Interface Relay Panel for 950 Control	
ACONT802AS32DA	Programmable Touch Screen Digital Control	
ACONT803AS32DA	Programmable Touch Screen Digital Control with Dehumidification Control	
ACONT402AN32DA	Non-Programmable Comfort Control	

Models listed are representative ONLY. Please refer to model nomenclature for product line configuration.

Air Handlers and Coils

Geothermal

TAMG Air Handler 1 2 3 4 5 6 7 8 9 10 11 12 13 14 15
 T A M G A 0 C 3 6 H 3 1 S A A

Brand _____
 T = Best
 G = Good

Product Type _____
 A = Air Handler

Convertability _____
 M = Multi-poise 4-way
 F = Upflow Front Return, 3-way
 T = 3-way

Product Tier _____
 2 = Good, Entry Level Feature Set
 4 = Better, Retail Replacement Mid Effy.
 5 = Better, Entry Level High Effy., Multi-Speed
 7 = Best, Retail Replacement High Effy., Variable-Speed
 8 = Best, Retail Ultimate High Effy., Variable-Speed
 G = Best, Geothermal

Major Design Change _____

No Descriptor _____
 0 = Air Handler / Coil

Size (Footprint) _____
 A = 17.5 x 21.5
 B = 21.0 x 21.5
 C = 23.5 x 21.5

Cooling Size: Air Handler or Coil _____
 0-9 = AH Coil - 1000 BTU's (24, 36, 48, 60)

Airflow Type & Capability _____
 S = Low Effy PSC, 1-5 - nom. Tonnage (cfm/ton)
 M = Mid Effy Multi-Speed, 1-5 - nom. Tonnage (cfm/ton)
 H = High Effy Variable, 1-5 - nom. Tonnage (cfm/ton)
 V = High Effy Variable, 1-5 - nom. Tonnage (cfm/ton)

Power Supply _____
 1 = 208-230/1/60

System Control Type _____
 S = Standard - 24 VAC
 C = CLII 13.8 VDC

Minor Design Change _____

Unit Parts Identifier _____

GCX Coils 1 2 3 4 5 6 7 8 9 10 11 12 13 14
 A G C X C R 0 2 6 A M A A X

Brand _____
 A = American Standard

Product Category _____
 G = Geothermal

Product Type _____
 C = Split System Dual Fuel Coil

Coil Design _____
 X = Direct Expansion
 Evaporator Coil TXV Included

Coil Cabinet _____
 C = Cabinet Encased
 U = Uncased

Model Type _____
 R = Refrigerant Coil
 H = Hydronic Coil

Nominal Coil Capacity _____

Refrigerant Models	Recommended Airflow CFM
026 M bth	800-980
036 M bth	1225
048 M bth	1425-1625
060 M bth	1760

Hydronic Models
 060 M bth 1760

Coil Width _____
 A = 20.8" / 20.0"

Airflow Configuration _____
 Cased = Multi-poise
 Uncased = Multi-poise

Series _____
 A = Current

Vintage _____
 A = Current

Minor Design Change - not orderable _____

Hydronic Air Handler 1 2 3 4 5 6 7 8 9 10 11 12 13 14
 A G A 2 6 H 0 0 0 1 1 M S A

Brand _____
 A = American Standard

Product Category _____
 G = Geothermal

Product Type _____
 A = Split System Air Handler

Unit Capacity _____

Hydronic Models	
26 = 026 M bth	925
36 = 036 M bth	1225
48 = 048 M bth	1625
60 = 060 M bth	1625

Air Coil Type _____
 H = Hydronic

Electric Heat _____
 00 = No Electric Heat

Disconnect _____
 0 = No Breaker Installed

Motor/Blower _____
 1 = ECM Available Only

Power Supply _____
 1 = 208-230/1/60

Applications _____
 M = Multi-Poise
 042-060 Downflow Application Only Requires Kit NAHBC

System Control Type _____
 S = Standard - 24 VAC

Series _____
 A = Current

For complete equipment / combination selections, installation instructions and warranty information, please refer to Product Data/Ratings and/or Installers Guides and Limited Warranty Handbooks.

Split Air Handlers

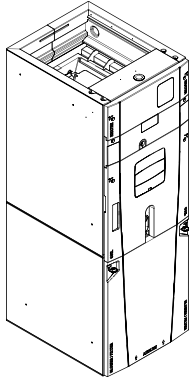

- Unique cabinet design
 - 2% or less air leakage
 - Double wall foamed cabinet system
 - \geq R-4.2 insulating value (Avg. Insulating Value R-8.2)
 - No loose fiber design
 - Smooth cleanable interior design
 - Sweat eliminating design
 - Composite foamed cabinet doors
 - Water proof cabinet design
 - Integrated horizontal drain pans
 - Modular cabinet
- Control board protection pocket built into cabinet wall
- Multi-position up/down flow horizontal left/right
- Variable speed ECM motor
- Electronic Expansion Valve (EEV)
- Aluminum coil with integrated slide deck for easy removal and polarized plug connections on coil EEV
- Molded in 1" standard filter rail
- Alert port to view control board codes without door removal
- **Vortica**[®] blower with polarized plug connections and integrated slide deck for easy removal.
- **10-year parts warranty registered**
- **No labor warranty. Extended Labor Warranty packages available**

Table GEO-17-A — TAMG Variable Speed R-410A with Comfort-R™ Enhanced Mode Option 200-230/1/60

Unit Model No.	Cooling Capacity (Btuh)	Dimensions (in.) H x W x D	Shipping Weight (lbs.)	Supply Opening	Return Opening	Filter Sizes	Line Size	
							Gas	Liquid
TAMGA0A24H21SB	24000	49.9x 17.5x 21.8	126	14.5x 14.35	14.5x 17.15	16x20x1	3/4	3/8
TAMGA0C36H31SB	36000	56.9x 23.5x 21.8	157	20.5x 14.35	20.5x 17.15	22x20x1	7/8	3/8
TAMGA0C48H41SB	48000	61.7x 23.5x 21.8	174	20.5x 14.35	20.5x 17.15	22x20x1	7/8	3/8
TAMGA0C60H51SB	60000	61.7x 23.5x 21.8	175	20.5x 14.35	20.5x 17.15	22x20x1	7/8	3/8

Table GEO-17-B — Optional Accessories

Model Number	Description	Used With
BAYEVAC05BK1AA	5 kW (16400 BTU) electric heater, breakers	TAMGA0A24-C60
BAYEVAC05LG1AA	5 kW (16400 BTU) electric heater, lugs	TAMGA0A24-C60
BAYEVAC08BK1AA	8 kW (26200 BTU) electric heater, breakers	TAMGA0A24-C60
BAYEVAC08LG1AA	8 kW (26200 BTU) electric heater, lugs	TAMGA0A24-C60
BAYEVAC10BK1AA	10 kW (32800 BTU) electric heater, breakers	TAMGA0A24-C60
BAYEVAC10LG1AA	10 kW (32800 BTU) electric heater, lugs	TAMGA0A24-C60
BAYEVBC15BK1AA	15 kW (49200 BTU) electric heater, breakers	TAMGA0C36-C60
BAYEVBC20BK1AA	20 kW (65600 BTU) electric heater, breakers	TAMGA0C36-C60
BAYEVCC25BK1AA	25 kW (82000 BTU) electric heater, breakers	TAMGA0C48-C60
BAYEVAC10LG3AA	10 kW (32800 BTU) electric heater, lugs, 3-Phase	TAMGA0A24-C60
BAYEVBC15LG3AA	15 kW (49200 BTU) electric heater, lugs, 3-Phase	TAMGA0C36-C60
BAYWVAA05SC1AA	40,000 BTUH, RS-485 control, hydronic heater, for A [ⓐ] cabinet	TAMGA0A24
BAYWVCC08SC1AA	65,000 BTUH, RS-485 control, hydronic heater, for C [ⓐ] cabinet	TAMGA0C36-C60
BAYWVCC11SC1AA	100,000 BTUH, No control, hydronic heater, for C cabinet	TAMGA0C60
BAYWVBRD485	RS-485 control for BAYWVCC11SC1AA	TAMGA0C60
BAYSUPFLGAA	Supply Duct Flange A cabinet	TAMGA0A24
BAYSUPFLGCA	Supply Duct Flange C cabinet	TAMGA0C36-C60
BAYRETFLGAA	Return Duct Flange A cabinet	TAMGA0A24
BAYRETFLGCA	Return Duct Flange C cabinet	TAMGA0C36-C60
TASB175SB [ⓐ] ⓐ	Plenum Stand with Integrated Sound Baffle A cabinet	TAMGA0A24
TASB235SB [ⓐ] ⓐ	Plenum Stand with Integrated Sound Baffle C cabinet	TAMGA0C36-C60
MTISRKIT1620 [ⓐ]	Side Return Kit with 16"x20" Filter	TAMGA0A24-C60
TASSBK175 [ⓐ] ⓐ	Sound Baffle Kit 17.5" Cabinet	TAMGA0A24
TASSBK235 [ⓐ] ⓐ	Sound Baffle Kit 23.5" Cabinet	TAMGA0C36-C60
BAYSPEKT200	Single Power Entry Kit	TAMGA0A24-C60
BAYSRKIT100	Side Return Kit	TAMGA0A24-C60
BAYICKSKIT01	Internal Condensate Switch Kit	TAMGA0A24-C60
BAYHHKIT001	Horizontal Hanger Kit	TAMGA0A24-C60
BAYUVCLK001	UV Lights	TAMGA0A24-C60
BAYLVKIT100	Low Voltage Conduit Entry Kit	TAMGA0A24-C60

[ⓐ] A Cabinet is 17.5" wide and C Cabinet is 23.5" wide.

[ⓐ] Contact your distributor for information.

[ⓐ] In return plenum applications, use TASSBK kits for sound reduction.

[ⓐ] In open air applications, Plenum Stand with Sound Baffle provides sound reduction.

Models listed are representative ONLY. Please refer to model nomenclature for product line configuration.

Heaters - Split Air Handlers

Table GEO-18-A — Heaters

AIR HANDLER	HEATER MODEL NUMBER BAYEV-								
MODEL NUMBER	AC05BK1AA 4.80 Kw BK	AC05LG1AA 4.80 Kw LG	AC08BK1AA 7.68 Kw BK	AC08LG1AA 7.68 Kw LG	AC10BK1AA 9.60 Kw BK	AC10LG1AA 9.60 Kw LG	BC15BK1AA 14.40 Kw BK	BC20BK1AA 19.20 Kw BK	CC25BK1AA 24.00 Kw BK
TAMGA0A24H21SB	Y	Y	Y	Y	Y	Y	—	—	—
TAMGA0C36H31SB	Y	Y	Y	Y	Y	Y	Y	Y	—
TAMGA0C48H41SB	Y	Y	Y	Y	Y	Y	Y	Y	Y
TAMGA0C60H51SB	Y	Y	Y	Y	Y	Y	Y	Y	Y

AIR HANDLER	HEATER MODEL NUMBER BAYEV-	
MODEL NUMBER	AC10LG3AA 9.60 Kw LG	BC15LG3AA 14.40 Kw LG
TAMGA0A24H21SB	Y	—
TAMGA0C36H31SB	Y	Y
TAMGA0C48H41SB	Y	Y
TAMGA0C60H51SB	Y	Y

Geothermal

Hydronic Air Handlers

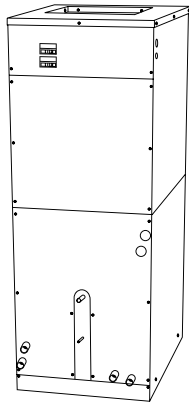

- Heavy gauge galvanized steel with metallic silver powder coat finish
- Full interior cabinet insulated with 1/2" foil lined acoustic fiber insulation
- Multi-Poise configuration
- 2-Piece separatable cabinet for ease of installation
- Slide out blower assembly
- Full ECM motor
- 1" Filter rack with MERV 4 filter included
- Two stainless steel drain pans
- Hydronic "A" coil option
- ARI/ASHRAE/ISO 13256-1 performance certified and UL/ETL safety listed
- **10-year parts and 10-year labor allowance**

Table GEO-18-B — GA Hydronic Air Handlers

Unit Model No.	Power Supply Volts/Hz/Phase	Rated Airflow (CFM)	Dimensions (in.) H x W x L	Shipping Weight (lbs.)	Supply Opening (DxH)	Return Opening (DxH)	Filter Size	Water Inlet/ Outlet Size	Min Circ Amp	Max Fuse
AGA26H	208-230/60/1	925	57.3x21.0x26.1	220	18x18	17x22	20x24	7/8	5	10
AGA36H	208-230/60/1	1225	57.3x21.0x26.1	220	18x18	17x22	20x24	7/8	5	10
AGA48H	208-230/60/1	1625	57.3x21.0x26.1	220	18x18	17x22	20x24	7/8	8.8	15
AGA60H	208-230/60/1	1760	57.3x21.0x26.1	220	18x18	17x22	20x24	7/8	8.8	15

For complete equipment / combination selections, installation instructions and warranty information, please refer to Product Data/Ratings and/or Installers Guides and Limited Warranty Handbooks.

GCX - Coils

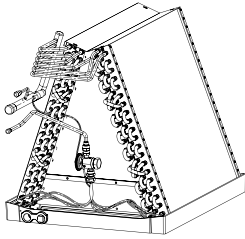

- "A" Coil Design
- Electro-Coated Coil
- Copper Tube/ Aluminum Fin Design
- Factory Configured for Upflow and Horizontal Left
- Field Configurable for Downflow or Horizontal Right
- Factory Installed TXV
- Sweat Connections
- Condensate Drain Pan Included

Table GEO-19-A — Common Model Configurations

Unit Model No. Cased Coil	Unit Model No. Matched Heat Pump	Recommended Airflow (CFM)	Cased Cabinet Dimensions (in.) H x W x D	Supply Connection Width/ Depth	Uncased Dimensions (in.) H x W x D	Shipping Weight (lbs.)	Hydronic Connection In/Out	Condensate Drain Connection, FTP
GCXCR026	T2GN/GE026	925	29.1x20.8x26.0	19.0/24.1	20.7x20.0x24.9	100	N/A	3/4
GCXCR036	T2GN/GE038	1225	29.1x20.8x26.0	19.0/24.1	20.7x20.0x24.9	100	N/A	3/4
GCXCR048	T2GN/GE049	1625	29.1x20.8x26.0	19.0/24.1	20.7x20.0x24.9	100	N/A	3/4
GCXCR060	T2GN/GE064	1760	29.1x20.8x26.0	19.0/24.1	20.7x20.0x24.9	100	N/A	3/4
GCXCR060	T2GN/GE072	1760	29.1x20.8x26.0	19.0/24.1	20.7x20.0x24.9	100	N/A	3/4
GCXCH060	T2GN/GE064	1760	N/A	19.0/24.1	25.2x20.0x24.9	100	7/8	3/4
GCXCH060	T2GN/GE072	1760	N/A	19.0/24.1	25.2x20.0x24.9	100	7/8	3/4

Models listed are representative ONLY. Please refer to model nomenclature for product line configuration.

For complete equipment / combination selections, installation instructions and warranty information, please refer to Product Data/Ratings and/or Installers Guides and Limited Warranty Handbooks.

Standard Accessories

Table GEO-20-A — Accessories

Model Number	Description
GL Flow Centers and Accessories	
Pre-assembled with pump(s), 3-way valves with flush ports, internal components injected with foam. Horizontal or vertical mounting capability. GL features a Die Cast Brass valve and pump volute, high-impact polystyrene cabinet, GL5PES, and uses GeoLink Connection Kits.	
FC1-GL	1 Grundfos Pump
FC2-GL	2 Grundfos Pumps
2 Brass adapters with P/T plugs for unit connection, 10' reinforced 1" rubber hose for unit to flow center and two 1" GL x 1" hose barb for flow center connection.	
CK4L-GLI	Unit Connection Kit 1" GL x 1" Insert
Rubber Hose	
1" rubber hose for connection from unit to flow center.	
RH550	50' of 1" Rubber Hose
Geo Storage Tank	
Use with Hot Water Generator Option or Hydronic Storage.	
GEO-STORAGE- 80	63 ¹ / ₄ x 24
GEO-STORAGE-120	63 ¹ / ₄ x 28
Loop Expansion Tank	
LET	1 ¹ / ₄ Socket Fusion, ³ / ₄ Gallon Capacity
Anti-Freeze	
EN2-D	55 Gallon Drum - Environol 2000 Pure
EN2-P	5 Gallon Pail - Environol 2000 Pure (minimum order quantity for EN2-P is 5 pails.)
Premier IntelliZone 4 Zone Control - with Cabinet and 10' Blower Wiring Harness	
Multiple level zone calls communicate exact zone load requirements. Controls up to 4 zones with dual capacity compressor (2 with single-speed compressor). Direct control of ECM2 fan motor to match needs of the space. Five fan speeds on line, up to 12 speeds available. Zone sizes as small as 25% of whole house (dual capacity compressor). Individual zone selectable savings or comfort mode. Four upstaging options: normal, quicker, faster or faster with timer for various application scenarios.	
ZCK4	See Parts and Accessories Catalog for Rectangular and Round Dampers
ZTK240	Zone Transformer Kit - 208/240V - 24V
ZBHE	Zone Blower Harness Extension - 10', Extends ECM2 Harness
Earth Loop Flushing System ^①	
High volume, high head, self-priming pump. Quick connect hoses. Heavy duty design. Mounted on a cart. All pipe is schedule 80 polypropylene.	
LFC-F	
GL-FP	1" Cam Lever Male Elbow for Flush Port.
Adapter Sets	
2 pcs. included in each set.	
92B025-99	Unit Connector Insulation Kit.
GLGH	Garden Hose Adapter for Loop Pump Replacement.
Service Tool Kit	
Includes 0-100 PSI Pressure Gauge, Pressure Gauge to PT Port Adapter, Digital Thermometer, Loop Pressurizer, Alcohol Specific Gravity Hygrometer.	
GEOHERMAL-STK	99P247A01, LP1, CAMT, 11P538A01, 11P538A02 (Includes DPT160, PG100, GA125)

Note: See Parts and Accessories Catalog for Complete Listing of Geothermal Accessory Items.

Ductless Mini-Split System Single Phase – 1/2-3 Tons

Table DU-1-A — 18 SEER R-410A Mini-Split System HP — Single Phase, 1/2 to 3 Ton^①

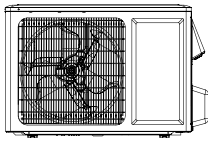

4TXK85



4MXW85

Outdoor Model Number Indoor Model Number ^③	Power Supply	Nom. Cap. Cooling (BTUH)	Uncrated Dimensions(in.)			Shipping Weight (lbs.)	Sound Power Level	Sound PRESSURE Level**	MCA*	Max. Fuse*	Line Size (in)	
			W	D	H						OD Gas	OD Liq.
4TXK8509A10N0B 4MXW8509A10N0C	208/230/1/60	9,000	33.4	12.6	21.3	90.3	60	50	10	15	3/8	1/4
4TXK8512A10N0B 4MXW8512A10N0C	208/230/1/60	12,000	33.3	7.1	10.8	28.6	42-52	32-42			3/8	1/4
4TXK8518A10N0B 4MXW8518A10N0C	208/230/1/60	18,000	37.6	15.6	27.6	110.1	65	55	16	20	1/2	1/4
4TXK8524A10N0C 4MXW8524A10N0C	208/230/1/60	21,400	38.6	16.8	31.1	145.3	68	58	16	20	5/8	1/4
4TXK8536A10N0B ^② 4MXW8536A10N0C ^②	208/230/1/60	33,600	53.1	10	12.8	59.5	63-69	53-59			5/8	1/4

Table DU-1-B — 16 SEER R-410A Mini-Split System HP — Single Phase, 1/2 to 2 Ton^①

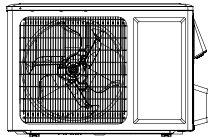

4TXK65

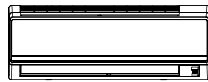

4MXW65

Outdoor Model Number Indoor Model Number	Power Supply	Nom. Cap. Cooling (BTUH)	Uncrated Dimensions(in.)			Shipping Weight (lbs.)	Sound Power Level	Sound PRESSURE Level**	MCA*	Max. Fuse*	Line Size (in)	
			W	D	H						OD Gas	OD Liq.
4TXK6509A10N0B 4MXW6509A10N0B	208/230/1/60	9,000	27.9	12.5	21.7	72.7	59	49	10	15	3/8	1/4
4TXK6512A10N0B 4MXW6512A10N0B	208/230/1/60	12,000	27.9	7.9	11.1	25.3	36-53	26-43			3/8	1/4
4TXK6518A10N0B 4MXW6518A10N0B	208/230/1/60	18,000	37.6	15.6	27.6	114.5	66	56	15	25	1/2	1/4
4TXK6524A10N0B 4MXW6524A10N0B	208/230/1/60	22,000	37.6	15.6	27.6	125.5	56	46	16	25	1/2	1/4

Table DU-1-C — 16 SEER R-410A Mini-Split System AC — Single Phase, 1/2 to 2 Ton^①

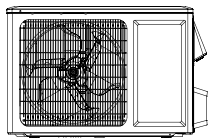

4TYK65

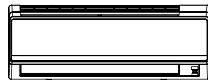

4MYW65

Outdoor Model Number Indoor Model Number	Power Supply	Nom. Cap. Cooling (BTUH)	Uncrated Dimensions(in.)			Shipping Weight (lbs.)	Sound Power Level	Sound PRESSURE Level**	MCA*	Max. Fuse*	Line Size (in)	
			W	D	H						OD Gas	OD Liq.
4TYK6509A10N0B 4MYW6509A10N0B	208/230/1/60	9,000	28	12.5	21.7	72.7	59	49	10	15	3/8	1/4
4TYK6512A10N0B 4MYW6512A10N0B	208/230/1/60	12,000	28	7.9	11.1	25.3	36-53	26-43			3/8	1/4
4TYK6518A10N0B 4MYW6518A10N0B	208/230/1/60	18,000	37.6	15.6	27.6	114.5	66	56	15	25	1/2	1/4
4TYK6524A10N0B 4MYW6524A10N0B	208/230/1/60	22,000	37.6	15.6	27.6	123.3	66	56	16	25	1/2	1/4

① See AHRI for approved combinations and ratings.

② Rated at 16 SEER

③ 4MXW85 High Wall Models with 14th digit B are phasing out and will be replaced with 14th digit C models

* Information subject to change. Please confirm with current Product Data/Service Facts for current factory production.

** Sound PRESSURE Level @3.3 ft. dB (A)

Ductless Multi-Split System Single Phase – 1/2 - 3-1/2 Tons

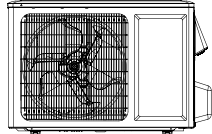

4TXM65

Table DU-2-A — R-410A Multi-Split System HP — Single Phase^{①②③}

Outdoor Model Number Indoor Model Number	Power Supply	Nom. Cap. Cooling (BTUH)	Uncrated Dimensions(in.)			Shipping Weight (lbs.)	Sound Power Level	Sound PRESSURE Level**	MCA* Fuse*	Max. OD Gas	Line Size (in)		No of Circuits
			W	D	H						OD Gas	OD Liq.	
4TXM6518A1020B	208/230/1/60	18,000	35.4	14.9	23.5	105.6	66	56	15	20	3/8	1/4	2
4TXM6524A1030B	208/230/1/60	24,000	37.2	15.6	27.6	145.2	69	59	20	30	3/8	1/4	3
4TXM6530A1040B	208/230/1/60	30,000	37.2	15.6	27.6	147.4	69	59	26	45	3/8	1/4	4
4TXM6536A1040B	208/230/1/60	34,000	36.2	16.8	31.1	164.9	69	59	28	45	3/8	1/4	4 ④
4TXM6542A1050B	208/230/1/60	42,000	40.0	17.3	43.4	246.4	68	58	26	40	3/8	1/4	5 ⑤



4MXW85

Table DU-2-B — R-410A Multi-Split High Wall System HP — Single Phase^②

Outdoor Model Number Indoor Model Number ⑦	Power Supply	Nom. Cap. Cooling (BTUH)	Uncrated Dimensions(in.)			Shipping Weight (lbs.)	Sound Power Level	Sound PRESSURE Level**	MCA* Fuse*	Max. OD Gas	Line Size (in)	
			W	D	H						OD Gas	OD Liq.
4MXW8509A10N0C	208/230/1/60	9,000	33.3	7.1	10.8	28.6	42-52	32-42		3/8	1/4	
4MXW8512A10N0C	208/230/1/60	12,000	33.3	7.1	10.8	28.6	43-54	33-44		3/8	1/4	
4MXW8518A10N0C	208/230/1/60	18,000	37	7.9	11.7	37.4	45-59	35-49		1/2	1/4	
4MXW8524A10N0C ⑧	208/230/1/60	24,000	39.6	8.6	12.4	46.2		37-53		5/8	1/4	

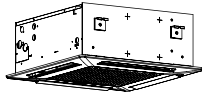

4MXC85

Table DU-2-C — R-410A Multi-Split System Cassette HP — Single Phase^②

Outdoor Model Number Indoor Model Number	Power Supply	Nom. Cap. Cooling (BTUH)	Uncrated Dimensions(in.)			Shipping Weight (lbs.)	Sound Power Level	Sound PRESSURE Level**	MCA* Fuse*	Max. OD Gas	Line Size (in)	
			W	D	H						OD Gas	OD Liq.
4MXC8512A10N0A	208/230/1/60	12,000	22.4	22.4	9.1	50.7	47-56	37-46		3/8	1/4	
4MXC8518A10N0A	208/230/1/60	14,400	22.4	22.4	9.1	50.7	47-56	37-46		1/2	1/4	
4MXC8524A10N0A	208/230/1/60	22,800	33.1	33.1	9.5	83.8	45-49	35-39		5/8	3/8	

Cassette Cover Panels - (must be ordered separately)

Model Number	Description	Matches Cassette HP Model(s)
4MXL8518A10N0A Cover Panel 25.59 x 25.59 x 1.97	4MXC8512 & 4MXC8518
4MXL8524A10N0A Cover Panel 37.40 x 37.40 x 2.36	4MXC8524

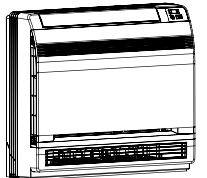

4MXF85

Table DU-2-D — R-410A Multi-Split System Console HP — Single Phase^②

Outdoor Model Number Indoor Model Number	Power Supply	Nom. Cap. Cooling (BTUH)	Uncrated Dimensions(in.)			Shipping Weight (lbs.)	Sound Power Level	Sound PRESSURE Level**	MCA* Fuse*	Max. OD Gas	Line Size (in)	
			W	D	H						OD Gas	OD Liq.
4MXF8509A10N0A	208/230/1/60	9,000	27.6	23.6	8.5	39.7	35-46	25-36		3/8	1/4	
4MXF8512A10N0A	208/230/1/60	12,000	27.6	23.6	8.5	39.7	37-48	27-38		3/8	1/4	
4MXF8518A10N0A	208/230/1/60	18,000	27.6	23.6	8.5	39.7	43-54	33-44		1/2	1/4	

Table DU-2-E — R-410A Multi-Split System Duct HP — Single Phase^②

Outdoor Model Number Indoor Model Number	Power Supply	Nom. Cap. Cooling (BTUH)	Uncrated Dimensions(in.)			Shipping Weight (lbs.)	Sound Power Level	Sound PRESSURE Level**	MCA* Fuse*	Max. OD Gas	Line Size (in)	
			W	D	H						OD Gas	OD Liq.
4MXD8509A10N0A	208/230/1/60	8,500	27.6	24.2	7.9	59.5	29-37	19-27		3/8	1/4	
4MXD8512A10N0A	208/230/1/60	11,900	27.6	24.2	7.9	63.9	40-49	30-39		3/8	1/4	
4MXD8518A10N0A	208/230/1/60	15,300	35.4	24.2	7.9	79.4	40-51	30-41		1/2	1/4	
4MXD8521A10N0A	208/230/1/60	20,400	43.3	24.2	7.9	90.4	42-52	32-42		5/8	3/8	
4MXD8524A10N0A	208/230/1/60	23,800	43.3	24.2	7.9	90.4	42-52	32-42		5/8	3/8	

Table DU-2-F — R-410A Multi-Split Floor/Ceiling System HP — Single Phase^②

Outdoor Model Number Indoor Model Number	Power Supply	Nom. Cap. Cooling (BTUH)	Uncrated Dimensions(in.)			Shipping Weight (lbs.)	Sound Power Level	Sound PRESSURE Level**	MCA* Fuse*	Max. OD Gas	Line Size (in)	
			W	D	H						OD Gas	OD Liq.
4MXX8509A10N0A	208/230/1/60	8,500	48.0	27.6	8.9	110.2	43-50	33-40		3/8	1/4	
4MXX8512A10N0A	208/230/1/60	11,900	48.0	27.6	8.9	110.2	43-50	33-40		3/8	1/4	
4MXX8518A10N0A	208/230/1/60	17,000	48.0	27.6	8.9	110.2	48-55	38-45		1/2	1/4	
4MXX8524A10N0A	208/230/1/60	22,800	48.0	27.6	8.9	119	39-58	29-48		5/8	3/8	

① Units are matched with 4MXW85 indoor units.
 ② See AHRI for allowable combinations and ratings.
 ③ Because of limited capabilities, please refer to the product ratings for approved combinations.
 ④ Capacity varies depending on the indoor unit matches.
 ⑤ Includes two 3/8 x 1/4 circuits, two 1/2 x 1/4 circuits, and one 5/8 x 3/8 circuit.
 ⑥ Includes two 3/8 x 1/4 circuits, one 1/2 x 1/4 circuits, and one 5/8 x 3/8 circuit.
 ⑦ 4MXW85 High Wall Models with 14th digit B are phasing out and will be replaced with 14th digit C models (Now compatible with wired remote)
 ⑧ The 4MXW8524A10N0C model is now compatible with multi-split systems. The 4MXW8524A10N0B model is **not** compatible with multi-split systems.
 * Information subject to change. Please confirm with current Product Data/Service Facts for current factory production.
 ** Sound PRESSURE Level @3.3 ft. dB (A)

For complete equipment / combination selections, installation instructions and warranty information, please refer to Product Data/Ratings and/or Installers Guides and Limited Warranty Handbooks.

Ductless Mini-split and Multi Split

Table DU-3-A — Features

	4TXK85 Mini-split HP 18 SEER	4TXK65 Mini-split HP 16 SEER	4TYK65 Mini-split AC 16 SEER	4TXM65 Multi-split 16-22 SEER
• R410-A refrigerant.....	✓	✓	✓	✓
• Flexibility to accommodate to different applications.....	—	—	—	✓
• Connect up to 5 indoor units to a single condensing unit.....	—	—	—	✓
• Nominal capacity 9-24 MBH.....	—	✓	✓	—
• Nominal capacity 9-36 MBH.....	✓	—	—	✓
• Nominal capacity 10-42 MBH.....	—	—	—	✓
• Cooling efficiency 16 SEER.....	—	✓	✓	✓
• Cooling efficiency range 16-22 SEER.....	✓	—	—	—
• Heating efficiency range 8-8.5 HSPF.....	—	✓	✓	✓
• Heating efficiency range 8.2-10 HSPF.....	✓	—	—	—
• Cooling or Heat Pump.....	✓	✓	—	✓
• Cooling only.....	—	✓	✓	—
• Low sound level.....	✓	✓	✓	✓
• Blue fin anti-corrosion treatment.....	✓	✓	—	✓
• Energy Star qualified.....	✓	—	—	—
• ETL and AHRI listed.....	✓	✓	✓	✓
• Sleep mode function.....	✓	✓	✓	✓
• Memory reset function.....	✓	✓	✓	✓
• Low ambient cooling to 0 degrees F.....	✓	✓	✓	✓
• Improved air quality with active carbon and catechin filters.....	✓	✓	✓	✓
• Registered limited warranty 5-year on all other functional parts (Residential Use) ①	✓	✓	✓	✓
• Optional extended warranties available	✓	✓	✓	✓

① Registered Limited Warranty terms are available when you register within 60 days of installation. You can register online at americanstandardair.com or by phone at 800-554-8005; otherwise American Standard Heating & Air Conditioning's Base Limited Warranty terms will apply. Base Limited Warranty information on specific products can be found on ASDealerNet.com.

See the Service First Mini-Split Accessory Catalog for the complete accessory list.

Table DU-3-B — Optional outdoor unit accessories

Model Number	Description	4TXK85 Mini-split HP 18 SEER	4TXK65 Mini-split HP 16 SEER	4TYK65 Mini-split AC 16 SEER	4TXM65 Multi-split 16-22 SEER
TAYREFLN050.....	Lineset Kit 1/4 x 3/8 - 25'	✓	✓	✓	✓
TAYREFLN055.....	Lineset Kit 1/4 x 3/8 - 35'	✓	✓	✓	✓
TAYREFLN060.....	Lineset Kit 1/4 x 3/8 - 50'	✓	✓	✓	✓
TAYREFLN560.....	Lineset Kit 1/4 x 1/2 - 25'	✓	✓	✓	✓
TAYREFLN565.....	Lineset Kit 1/4 x 1/2 - 35'	✓	✓	✓	✓
TAYREFLN570.....	Lineset Kit 1/4 x 1/2 - 50'	✓	✓	✓	✓
TAYREFLN155.....	Lineset Kit 1/4 x 5/8 - 25'	✓	—	—	✓
TAYREFLN160.....	Lineset Kit 1/4 x 5/8 - 35'	✓	—	—	✓
TAYREFLN165.....	Lineset Kit 1/4 x 5/8 - 50'	✓	—	—	✓

Table DU-3-C — Optional indoor unit accessories

Model Number	Description	4MXW85 Mini-split Indoor 18 SEER	4MXW65 Mini-split Indoor 16 SEER	4MYW65 Mini-split Indoor 16 SEER
BAYFTHW01P2A.....	Active Carbon & Catechin filters for 9 & 12 MBH 16 SEER units.....	✓	✓	✓
BAYFTHW02P2A.....	Active Carbon & Catechin filters for 18 & 24 MBH 16 SEER units and9, 12, 18 & 24 MBH 18 SEER units.....	✓	✓	✓
BAYFTHW03P2A.....	Active Carbon & Catechin filters for 36 MBH 18 SEER units.....	✓	✓	✓
AREMOTE1AHAND1.....	Wireless controller.....	✓	✓	✓
TREWIRE1AHANDAA.....	Wired Controller (Only Compatible with 4MXW85 14th digit C models)..	✓	—	—

Ductless

Roof Curbs

BAYCURB050A FULL PERIMETER ROOF MOUNTING CURB OUTLINE

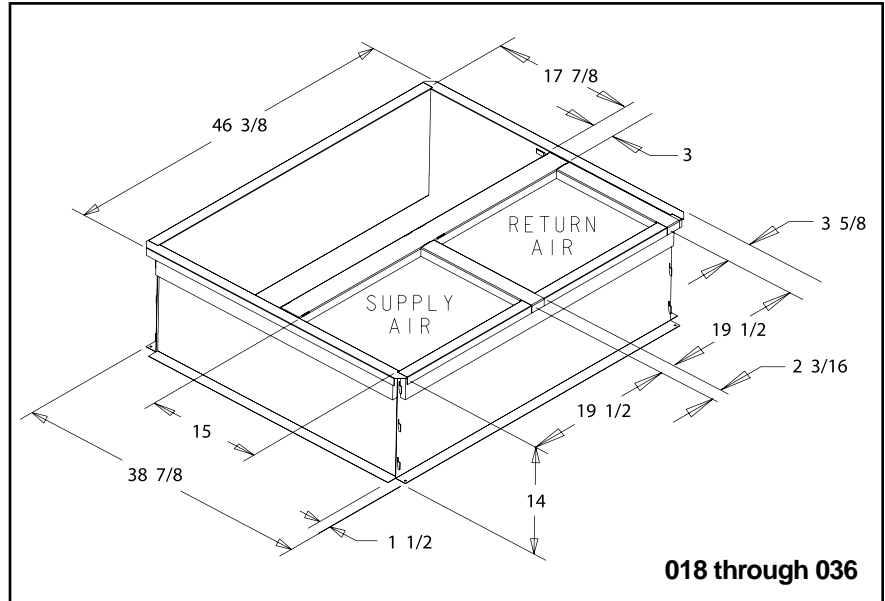

Full Perimeter BAYCURB050A	Full Perimeter BAYCURB051A
4TCY4024-036	4TCY4042-060
4TCX3018-036/4TCC3018-036	4TCX3042-060/4TCC3042-060
4WCZ6036/4DCZ6036	4WCZ6048-060/4DCZ6048-060
4WCY4024-036/4DCY4024-036	4WCY4042-060/4DCY4042-060
2/4WCX3018-036/2/4WCC3018-036	2/4WCX3042-060/2/4WCC3042-060
4YCZ6036	4YCZ6048-060
4YCY4024-036	4YCY4042-060
2/4YCX3018-036/2/4YCC3018-036	2/4YCX3042-060/2/4YCC3042-060

BAYCURB051A FULL PERIMETER ROOF MOUNTING CURB OUTLINE

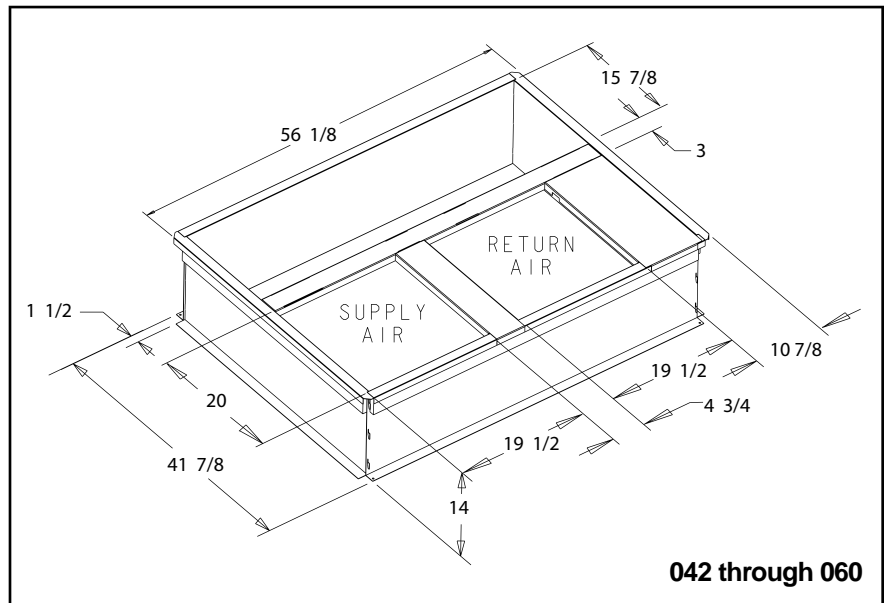

Thermal Expansion Valves

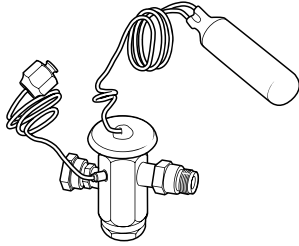

**Expansion Valve TXV
Cooling/Heat Pump Kit**

General Information

This Thermostatic Expansion Valve Kit may be used on any indoor air handler or coil that is equipped with a current thermostatic expansion valve with an internal check valve and mechanical fittings. This kit can be used on split system heat pumps and air conditioning systems.

Thermostatic Expansion Valve Kits can be field installed to fit a variety of sizes and combinations of air handlers or coils and outdoor units to optimize performance.

This TXV kit will normally be used when a different refrigerant is going to be used in the air handler or coil than what is indicated on the unit name plate. The TXV type must always match the refrigerant type used in the outdoor unit.

Kit Identification

The first character in the kit model number indicates the type of refrigerant that the valve can be used with. Example a 2AYTXVH3D1830A is an R-22 valve.

The "3" in the eighth digit in the model number identifies the valve as a non-bleed TXV. When this TXV kit is installed with an outdoor unit that contains a reciprocating compressor, the outdoor unit must be equipped with a hard start kit if not factory installed. If the outdoor unit contains a scroll compressor, the installation of a hard start kit may be required.

Inspection

Check carefully for any shipping damage. Any such damage must be reported and claims made against the transportation company immediately. Any missing parts should be reported to your supplier at once and replaced with authorized parts only.

Table AC/IN-2-A Cooling/Heat Pump Non-Bleed TXV Kits- Dual Direction Flow-TXA/C-BC Coils

R-410 Model Number	R-22 Model Numbers	Used With 13 SEER Coils
4AYTXVH3D1831A	2AYTXVH3C1818A	2/4TXC, TXA018
4AYTXVH3D1831A	2AYTXVH3C2425A	2/4TXC, TXA024,025
4AYTXVH3D1831A	2AYTXVH3C3031A	2/4TXC, TXA031
4AYTXVH3D3343A	—4TXC, 4TXA-032	
4AYTXVH3D3343A	2AYTXVH3C3337A	2/4TXC, TXA036,037
4AYTXVH3D3343A	2AYTXVH3C4243A	2/4TXC, TXA042,043
4AYTXVH3D4863A	—4TXC, 4TXA-044	
4AYTXVH3D4863A	2AYTXVH3C4850A	2/4TXC, TXA048,049,050
4AYTXVH3D4863A	2AYTXVH3C5463A	2/4TXC, TXA060,061,064

Table AC/IN-2-B Cooling/Heat Pump Non-Bleed TXV Kits- Dual Direction Flow

R-410 Model Number	R-22 Model Number	Used With Horizontal Flat Coils
4AYTXVH3D1831A	2AYTXVH3C1818A	2/4TXF-018
4AYTXVH3D3343A	2AYTXVH3C3337A	2/4TXF-033
4AYTXVH3D3343A	2AYTXVH3C4243A	2/4TXF-041
4AYTXVH3D4863A	2AYTXVH3C5463A	2/4TXF-054
4AYTXVH3D4863A	2AYTXVH3C5463A	2/4TXF-063

Table AC/IN-2-C Cooling/Heat Pump Non-Bleed TXV Kits- Dual Direction Flow-TXA/C-AS Coils

R-410 Model Number	R-22 Model Number	Used With AS Aluminum Coils
4AYTXVH3B2531A	2AYTXVH3B2531A	2/4TXA, TXC-025
4AYTXVH3B2531A	2AYTXVH3B2531A	2/4TXA, TXC-031
4AYTXVH3B3654A	2AYTXVH3B3637A	2/4TXA, TXC-036
4AYTXVH3B3654A	2AYTXVH3B3637A	2/4TXA, TXC-037
4AYTXVH3B3654A	2AYTXVH3B5454A	2/4TXA, TXC-054
4AYTXVH3B6165A	2AYTXVH3B6565A	2/4TXA, TXC-065

Table AC/IN-2-D Cooling/Heat Pump Non-Bleed TXV Kits – Dual Direction Flow 4NXA/4NXC

R-22 Number	Used With 4NXA & 4NXC Coils
2AYTXVH3E1824AA	4NXA, NXC – 018 - 024
2AYTXVH3E2536AA	4NXA, NXC – 025 - 036
2AYTXVH3E6363AA	4NXC - 063

Table AC/IN-2-E Cooling/Heat Pump Non-Bleed TXV Kits- Dual Direction Flow

R-410 Number	R-22 Numbers	Used With Air Handlers
4AYTXVH3D1830A	2AYTXVH3D1830A	2TFB-018-030
4AYTXVH3D1831A	2AYTXVH3D1830A	2TFB-036
4AYTXVH3D1831A	2AYTXVH3D1830A	2/4TFE-025
4AYTXVH3D1831A	2AYTXVH3D1830A	2/4TEC-018-030
—	2AYTXVH3D3636A	2/4TEC-036
4AYTXVH3D3642A	—	2/4TEC-036-042
—	2AYTXVH3D4260A	2/4TEC-042-060
4AYTXVH3D4863A	—	2/4TEC-048-060
4AYTXVH3D1831A	2AYTXVH3D1830A	2/4TEH-018-030
—	2AYTXVH3D3636A	4TEH-036
4AYTXVH3D3642A	—	2TEH-036-042
—	2AYTXVH3D4260A	4TEH-042-060
4AYTXVH3D4863A	—	2TEH-048-060
4AYTXVH3D1800A	2AYTXVH3D1830A	2/4TGB-018
4AYTXVH3D1830A	2AYTXVH3D1830A	2/4TGB-025
4AYTXVH3D1831A	2AYTXVH3D1830A	2/4TGB-030
4AYTXVH3D3600A	2AYTXVH3D1830A	2/4TGB-036
4AYTXVH3D3343A	2AYTXVH3D4260A	2/4TGB-042
4AYTXVH3D4863A	2AYTXVH3D4260A	2/4TGB-048
4AYTXVH3D3642A	2AYTXVH3D4260A	2/4TEE-039
4AYTXVH3D4863A	2AYTXVH3D4260A	2/4TEE-048-064

For complete equipment / combination selections, installation instructions and warranty information, please refer to Product Data/Ratings and/or Installers Guides and Limited Warranty Handbooks.

Thermal Expansion Valves

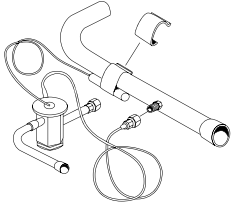

Table AC/IN-3-A — Cooling Bleed TXV Kits – Single Direction Flow

Model Number	Used With AC Units	Liquid Line Connection Dia. I.D. (In.)	Gas Line Connection Dia. I.D. (In.)	Shipping Weight (lbs.)	Refrigerant
TAYTXVA0B5C	1-1½ Ton	¼	⅝	2	R-22
TAYTXVA0C5C	2-2½ Ton	⅝ ₁₆	¾	2	R-22
TAYTXVA0E5C	3-3½ Ton	⅜	⅞	2	R-22
TAYTXVA0G5C	4 Ton	⅜	1⅛	2	R-22
TAYTXVA0H5C	5-6 Ton	⅜	1⅛	2	R-22

Expansion Valve TXV Cooling Kit

Table AC/IN-3-B — Cooling Non-Bleed TXV Kits – Single Direction Flow

Model Number	Used With AC Units	Liquid Line Connection Dia. I.D. (In.)	Gas Line Connection Dia. I.D. (In.)	Shipping Weight (lbs.)	Refrigerant
TAYTXVA0B3C	1-1½ Ton	¼	⅝	2	R-22
TAYTXVA0C3C	2-2½ Ton	⅝ ₁₆	¾	2	R-22
TAYTXVA0E3C	3-3½ Ton	⅜	⅞	2	R-22
TAYTXVA0G3C	4 Ton	⅜	1⅛	2	R-22
TAYTXVA0H3C	5-6 Ton	⅜	1⅛	2	R-22

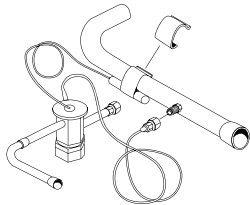

Expansion Valve TXV Heat Pump Kit*

Table AC/IN-3-C — Heat Pump Non-Bleed TXV Kits (also for cooling) – Dual Direction Flow

Model Number	Used With AC Units	Liquid Line Connection Dia. I.D. (In.)	Gas Line Connection Dia. I.D. (In.)	Shipping Weight (lbs.)	Refrigerant
TAYTXVH0B3C	1-1½ Ton	¼	⅝	3	R-22
TAYTXVH0C3C	2-2½ Ton	⅝ ₁₆	¾	3	R-22
TAYTXVH0E3C	3-3½ Ton	⅜	⅞	3	R-22
TAYTXVH0G3C	4 Ton	⅜	1⅛	3	R-22
TAYTXVH0H3C	5-6 Ton	⅜	1⅛	3	R-22

Table AC/IN-3-D — Cooling/Heat Pump Non-Bleed TXV Kits - Dual Direction Flow*

Model Number	Used With AC Units	Liquid Line Connection Dia. I.D. (In.)	Gas Line Connection Dia. I.D. (In.)	Shipping Weight (lbs.)	Refrigerant
TAYTXVH0D3C	2½ -3 Ton	⅜	1⅛	2	R-22
TAYTXVH0G3C	4-5 Ton	⅜	1⅛	2	R-22

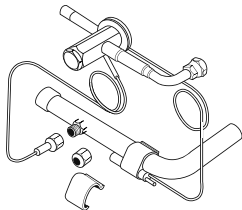

Table AC/IN-3-E — R-410A Heat Pump Non-Bleed TXV Kits (also for cooling) - Dual direction flow

Model Number	Used With HP/AC Units	Liquid Line Connection Dia. I.D. (In.)	Gas Line Connection Dia. I.D. (In.)	Shipping Weight (lbs.)	Refrigerant
4AYTXVH3A1830A	1½-2½ Ton	⅝ ₁₆ ①	¾②	2	R-410A
4AYTXVH3A3654A	3-4 Ton	⅜	⅞③	2	R-410A
4AYTXVH3A6060A	5 Ton	⅜	⅞	2	R-410A

- ① 1 1/2 ton requires 1/4" liquid line; reducer fittings provided.
- ② 1 1/2 ton requires 1/2" suction line, 2 ton requires 5/8; reducer fittings provided.
- ③ 3 & 3 1/2 ton requires 3/4" suction line; reducer fitting provided.

* Used with TXH coils only where approved for use with 2 compressor systems.

Notes:

- Use in place of FCCV (Above) on air handlers and coils
- Match TXV kit size to outdoor nominal cooling capacity
- Braze field connections

Equipment Date Identification

1980 – 2009

The nine digit serial numbers on all American Standard central air conditioning and heating products are employed to identify the year and fiscal week of product manufacture.

Year of manufacture First digit..... **M124X04CF**
 Fiscal week of manufacture..... Second and third digit **M124X04CF**
 Day of week of manufacture..... Fourth digit **M124X04CF**
 Consecutive order of production Last Five digits **M124X04CF**

Exception – Accessories are an exception to the nine digit serial number assignment and may have only three digits to indicate date code. Coils which have only three digits to indicate date code are an exception to the nine digit serial number assignment.

Year	Residential, ID & OD ^① Light Commercial Products & Compressors	Ducane Oil ^① Horizontal Gas Furnaces ^②	Year	Residential, ID & OD ^① Light Commercial Products & Compressors	Ducane Oil ^① Horizontal Gas Furnaces ^②	Year	Residential, ID & OD ^① Light Commercial Products & Compressors	Ducane Oil ^① Horizontal Gas Furnaces ^②
1980	O, A	L	1997	M	97	2014	14	—
1981	T	M	1998	N	98	2015	15	—
1982	U	N	1999	P	99	2016	16	—
1983	W	9	2000	R	—	2017	17	—
1984	X	Q	2001	Z	—	2018	18	—
1985	Y	85	2002	2	—	2019	19	—
1986	S	86	2003	3	—			
1987	B	87	2004	4	—			
1988	C	88	2005	5	—			
1989	D	89	2006	6	—			
1990	E	90	2007	7	—			
1991	F	91	2008	8	—			
1992	G	92	2009	9 or 09	—			
1993	H	93	2010	10	—			
1994	J	94	2011	11	—			
1995	K	95	2012	12	—			
1996	K	96	2013	13	—			

① **Beginning with 1/1/96 (L01) Ducane oil furnace production uses same date code method as gas furnace. Prior to 1/1/96 Ducane serial number used last four digits = date code, example HA1234569540 1995, 40th week.**

Example: 123456-**8 5 4 0**

Year of manufacture _____ Fiscal week of manufacture _____

② **Dedicated horizontal gas furnaces, production ceased after introduction of convertible furnaces. 2010**

Digit	Description	Current Digit Value Options
1 ST	Second to Last integer of the current calendar year	1 through 9 and blank space, Blank Space used when 0 (zero)
2 ND	Last integer of the current calendar year	0 through 9
3 RD	Fiscal Week (Tens numeral)	0 through 5
4 TH	Fiscal Week (Units numeral)	0 through 9
5 TH	Day of the Week	1 through 7
6 TH	Time Stamp	A through Z and 0 through 9, excluding I, O, Q, V, Y, and Z
7 TH	Time Stamp	A through Z and 0 through 9, excluding I, O, Q, V, Y, and Z
8 TH	Time Stamp	A through Z and 0 through 9, excluding I, O, Q, V, Y, and Z
9 TH	Assembly Line Designator	A through Z and 0 through 9, excluding I, O, Q, V, Y, and Z
10 TH	Plant Code	A, D, F, G, H, V, Y, X

Plant Codes: (starting around 1995)
A = Monterrey
D = Springhill, LA (used to be the last character of a 10 digit serial on Ft. Smith products when they were sold commercially back in the late 1980's)
F = Tyler, TX
G = Trenton, NJ
H = Ft. Smith, AR
L = Lynn Haven, FL
V = Vidalia, GA
X = Sourced products

Accessories/Information

For complete equipment / combination selections, installation instructions and warranty information, please refer to Product Data/Ratings and/or Installers Guides and Limited Warranty Handbooks.

Refrigerant Line Sets

Table AC/IN-5-A — Refrigerant Line Sets

Model Number	Gas Line ^{①②} Dia. O.D.	Liquid Line Dia. O.D.	Length	Shipping Weight
TAYREFLN325	7/8	3/8	25	20
TAYREFLN330	7/8	3/8	30	24
TAYREFLN340	7/8	3/8	40	30
TAYREFLN350	7/8	3/8	50	39
TAYREFLN725	3/4	3/8	25	19
TAYREFLN730	3/4	3/8	30	22
TAYREFLN740	3/4	3/8	40	28
TAYREFLN750	3/4	3/8	50	35
TAYREFLN950	5/8	3/8	50	30

① Gas line 90° bend one end.

② Gas line insulation 1/2" thickness.

Note: Contains a holding charge of Nitrogen.

Refrigerant HFC 410A (R-410A)

Tables contain **no allowances** for vertical lift!

Table AC/IN-6-A — Liquid Line Selection Table for R-410A Single Speed Systems

Maximum Allowable Liquid Line Pressure Drop =

Subtract .43 PSI for each foot of Liquid Lift (if any).....

Do Not Exceed this value when selecting Liquid Line.

Tube O.D.	Rated BTUH	Pressure Drop (PSI) For Total Equivalent Length											
		20'	40'	60'	80'	100'	120'	140'	160'	180'	200'	220'	240'
1/4"	15000	4.5	9.0	13.6	18.1	22.6	27.1	31.6	36.2	40.7	45.2	49.7	—
	18000	6.3	12.6	18.8	25.1	31.4	37.7	44.0	—	—	—	—	—
	24000	15.4	30.8	46.2	—	—	—	—	—	—	—	—	—
5/16"	15000	1.2	2.4	3.5	4.7	5.9	7.1	8.3	9.4	10.6	11.8	13.0	14.2
	18000	1.6	3.3	4.9	6.6	8.2	9.8	11.5	13.1	14.8	16.4	18.0	19.7
	24000	2.8	5.5	8.3	11.0	13.8	16.6	19.3	22.1	24.8	27.6	30.4	33.1
	30000	4.1	8.3	12.4	16.6	20.7	24.8	29.0	33.1	37.3	41.4	45.5	49.7
	36000	5.8	11.6	17.3	23.1	28.9	34.7	40.5	46.2	—	—	—	—
42000	7.7	15.4	23.0	30.7	38.4	46.1	—	—	—	—	—	—	
3/8"	24000	1.0	1.9	2.9	3.8	4.8	5.8	6.7	7.7	8.6	9.6	10.6	11.5
	30000	1.4	2.9	4.3	5.8	7.2	8.6	10.1	11.5	13.0	14.4	15.8	17.3
	36000	2.0	4.0	6.1	8.1	10.1	12.1	14.1	16.2	18.2	20.2	22.2	24.2
	42000	2.7	5.3	8.0	10.6	13.3	16.0	18.6	21.3	23.9	26.6	29.3	31.9
	48000	3.4	6.8	10.2	13.6	17.0	20.4	23.8	27.2	30.6	34.0	37.4	40.8
60000	5.1	10.3	15.4	20.6	25.7	30.8	36.0	41.1	46.3	—	—	—	
1/2"	42000	.5	1.1	1.6	2.2	2.7	3.2	3.8	4.3	4.9	5.4	5.9	6.5
	48000	.7	1.4	2.0	2.7	3.4	4.1	4.8	5.4	6.1	6.8	7.5	8.2
	60000	1.0	2.1	3.1	4.2	5.2	6.2	7.3	8.3	9.4	10.4	11.4	12.5

- Note 1: A blank space indicates a pressure drop of over 50 PSI.
- Note 2: Other existing sources of pressure drop, (solenoid valves, etc.) must be considered.
- Note 3: A vertical run with a heat pump system always results in a liquid lift (heating or cooling).
- Note 4: The smallest liquid line diameter that results in a total liquid line pressure drop of 50 PSI or less results in the most reliable system (fewer pounds of R-410A).
- Note 5: It is recommended to place units where 1/2" liquid line is not required due to the increased refrigerant volume imposed by the larger liquid line.
- Note 6: At the time this manual was printed all outdoor units were rated with 3/8" liquid line.

Table AC/IN-6-B — Allowable Vapor Line Diameters and BTUH Loss (R-410A Single Speed Systems)

Nominal Tons	Tube O.D. (Inches)	Press. Drop PSI/100 Ft.	BTUH Loss For Equivalent Length										
			40'	60'	80'	100'	120'	140'	160'	180'	200'	220'	240'
1.0	1/2	5.0	70	160	250	340	430	520	610	700	790	880	970
	5/8	1.5	20	50	73	100	130	155	180	210	235	265	290
1.5	1/2	10.8	173	410	640	875	1110	1340	1575	1810	2040	2275	2510
	5/8	3.1	50	120	185	250	320	385	450	520	585	655	720
	3/4	1.2	20	45	70	95	125	150	175	200	225	255	280
2.0	5/8	5.4	115	270	430	585	740	895	1050	1205	1360	1515	1670
	3/4	2.0	45	100	160	215	275	330	390	445	505	560	620
2.5	5/8	8.2	220	515	810	1110	1400	1695	1990	2290	2585	2880	3175
	3/4	3.0	80	190	295	405	515	620	730	840	945	1055	1160
	7/8	1.3	35	80	130	175	220	270	315	365	410	455	505
3.0	5/8	11.7	380	885	1390	1895	2400	2905	3410	3915	4425	4930	—
	3/4	4.3	140	325	510	700	880	1070	1255	1440	1625	1810	2000
	7/8	1.9	60	145	225	310	390	470	555	635	720	800	880
3.5	3/4	5.8	220	510	805	1095	1390	1680	1975	2265	2560	2850	3140
	7/8	2.5	95	220	345	475	600	725	850	975	1105	1230	1355
4.0	3/4	7.4	320	745	1170	1600	2025	2450	2875	3305	3730	4155	4580
	7/8	3.2	140	325	510	690	875	1060	1245	1430	1615	1795	1980
	1-1/8 ^③	.9	40	90	145	195	245	300	350	400	455	505	555
5.0	3/4	11.5	620	1450	2280	3105	3935	4760	5590	6415	7245	8073	8900
	7/8	4.9	265	615	970	1325	1675	2030	2380	2735	3080	3440	3795
	1-1/8	1.3	70	165	255	350	445	540	630	725	820	915	1005

- Note 1: Shaded value indicates more than 10% capacity loss.
- Note 2: Blank space indicates more than 15% capacity loss.
- Note 3: Only approved for cooling units, do not use 1 1/8" vapor lines on heat pumps less than 5 ton.
- Note 4: If linear length exceeds 150 feet, add 2 ounces of approved compressor oil per every 10 feet in excess of 150 feet. (Example: if the actual line length is 170 feet, add 4 ounces of oil to the system)

Accessories/Information

This page contains limited data to fully determine if the application will work or to select required accessories. Please refer to publication 14-4050-01 for complete details and examples.

For complete equipment / combination selections, installation instructions and warranty information, please refer to Product Data/Ratings and/or Installers Guides and Limited Warranty Handbooks.

Refrigerant Piping Information for Two Stage Split Systems

Table AC/IN-7-A — Allowable Vapor and Liquid Line Diameters for Multistage Split Systems

OD Unit nominal capacity	Rated Vapor Line OD	Vapor Service Valve OD	Minimum Alternative Vapor Line OD	Maximum Alternative Vapor Line OD	Rated Liquid Line OD	Liquid Service Valve OD	Minimum Alternative Liquid Line OD	Maximum Alternative Liquid Line OD
Platinum XM								
2 ton CLG	5/8"	5/8"	5/8"	3/4"	5/16"	5/16"	5/16"	3/8"
3 ton CLG	3/4"	3/4"	5/8"	7/8"	3/8"	3/8"	5/16"	3/8"
4 ton CLG	7/8"	7/8"	3/4"	7/8"	3/8"	3/8"	3/8"	3/8"
5 ton CLG	7/8" or 1 1/8"	7/8"	3/4"	1 1/8"	3/8"	3/8"	3/8"	3/8"
2 ton HP	5/8"	5/8"	5/8"	3/4"	5/16"	5/16"	5/16"	3/8"
3 ton HP	3/4"	3/4"	5/8"	7/8"	3/8"	3/8"	5/16"	3/8"
4 ton HP	7/8"	7/8"	3/4"	7/8"	3/8"	3/8"	3/8"	3/8"
5 ton HP	7/8" or 1 1/8"	7/8"	3/4"	1 1/8"	3/8"	3/8"	3/8"	3/8"
Platinum ZM								
2 ton CLG	3/4"	5/8"	5/8"	3/4"	3/8"	3/8"	5/16"	3/8"
3 ton CLG	3/4"	3/4"	5/8"	7/8"	3/8"	3/8"	5/16"	3/8"
4 ton CLG	7/8"	3/4"	3/4"	7/8"	3/8"	3/8"	3/8"	3/8"
5 ton CLG	7/8"	3/4"	3/4"	7/8"	3/8"	3/8"	3/8"	3/8"
2 ton HP	5/8"	5/8"	5/8"	3/4" - 50 feet max length	3/8"	3/8"	5/16"	3/8"
3 ton HP	3/4"	3/4"	5/8"	3/4"	3/8"	3/8"	5/16"	3/8"
4 ton HP	3/4"	3/4"	3/4"	3/4"	3/8"	3/8"	3/8"	3/8"
5 ton HP	3/4"	3/4"	3/4"	7/8" - 50 feet max length	3/8"	3/8"	3/8"	3/8"

Two compressor models share the same refrigeration circuit, however, do not operate simultaneously. Therefore, it is crucial that refrigerant lines be properly sized and do not exceed the length set forth in this guide. Please note it is recommended to use the service valve connection size tubing.

A. Limitations:

1. Line length limits as shipped:
 - A. Vapor line = 80 feet linear length / of the linear length, 25 feet may be installed vertical.
 - B. Liquid line = 80 feet linear length / of the linear length, 25 feet may be installed vertical.

B. Explanation:

1. Refrigerant lines shall not exceed 80 feet total line length. / 25 feet of the 80 feet may be vertical.
 - A. Liquid sub-cooling may not be achieved on second stage if the liquid line exceeds 80 feet.
 - B. Oil return may be sacrificed during first stage operation if the vapor line exceeds 80 feet.

Table AC/IN-7-B — Equivalent Length (Ft.) of Non-Ferrous Valves and Fittings (Brazed)

O.D. Tube Size (Inches)	Globe Valve	Angle Valve	Short Radius Ell	Long Radius Ell	Tee Line Flow	Tee Branch Flow
1/2"	70	24	4.7	3.2	1.7	6.6
5/8	72	25	5.7	3.9	2.3	8.2
3/4	75	25	6.5	4.5	2.9	9.7
7/8	78	28	7.8	5.3	3.7	12.0
1-1/8	87	29	2.7	1.9	2.5	8.0
1-3/8	102	33	3.2	2.2	2.7	10.0
1-5/8	115	34	3.8	2.6	3.0	12.0

Information for this chart extracted by permission from A.R.I. Refrigerant Piping Data, page 28.
* For smaller sizes, use 1/2" values.

This page contains limited data to fully determine if the application will work or to select required accessories. Please refer to publication SS-APG006-EN for complete details and examples.

For complete equipment / combination selections, installation instructions and warranty information, please refer to Product Data/Ratings and/or Installers Guides and Limited Warranty Handbooks.

Subcooling Charging

Subcooling Charging in Cooling Above 55°F Outdoor Ambient Temperature

The manufacturer has always recommended installing American Standard approved matched indoor and outdoor systems.

All split systems are AHRI rated with TXV or EEV indoor systems.

The benefits of installing approved indoor and outdoor split systems are maximum efficiency, optimum performance and the best overall reliability.

The following charging methods are therefore prescribed for systems with indoor TXVs or EEVs.

1. Subcooling (in the cooling mode) is the only recommended method of charging between 55° and 120° ambient temperatures.
2. When charging for ambient temperatures above 120°, charge to 10° subcooling. It is important to return when outdoor ambient temperature is between 55° and 120° to verify system charge per these instructions.
3. For best results—the indoor temperature should be kept between 70 ° to 80°. Add system heat if needed.
4. Locate the designated subcooling target from the unit nameplate.
5. Run the system using the Charging Mode-Cooling test mode found in the 950 control. This is the only approved method for setting the system charge level. To access Charge Mode-Cooling from the 950 control home screen go to:
 - ▶ Menu
 - ▶ Service
 - ▶ Technician Access (hold for 5 seconds)
 - ▶ Proceed
 - ▶ Test Mode
 - ▶ Variable Speed
 - ▶ Charging Mode-Cooling and follow the on-screen prompts. Charging Mode-Cooling and follow the on-screen prompts.
6. At startup, or any time charge is removed or added, the system must be operated for a minimum of (20) minutes to stabilize before accurate measurements can be made.
7. Measure Liquid Line Temperature and Refrigerant Pressure at service valves.
8. Determine total refrigerant line length, and height (lift) if indoor section is above the condenser. Follow the Subcool Charging Corrections Table to calculate additional subcooling target value.
9. Locate your liquid line temperature in the left column of the table, and the intersecting liquid line gage pressure under the subcool selection column. Add refrigerant to raise the pressure to match the table, or remove refrigerant to lower the pressure. Always wait (20) minutes for the system conditions to stabilize before adjusting charge again.
10. When system is correctly charged, you can refer to System Pressure Curves to verify typical performance.

Table AC/IN-8-A — 024 Units

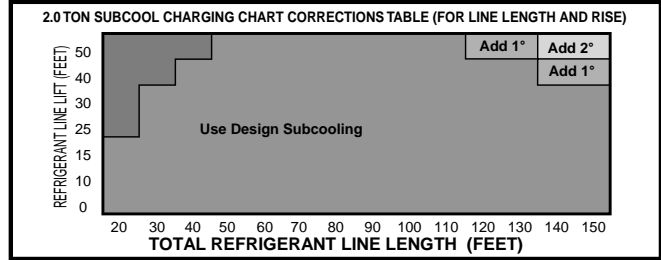

Table AC/IN-8-B — 036 Units

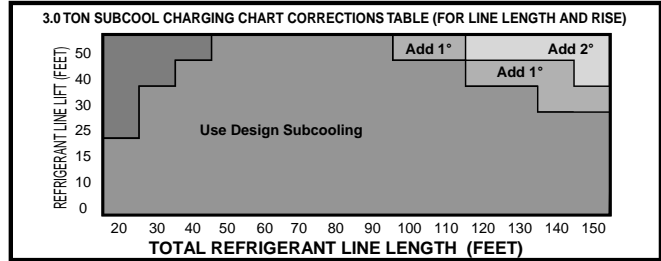

Table AC/IN-8-C — 048 Units

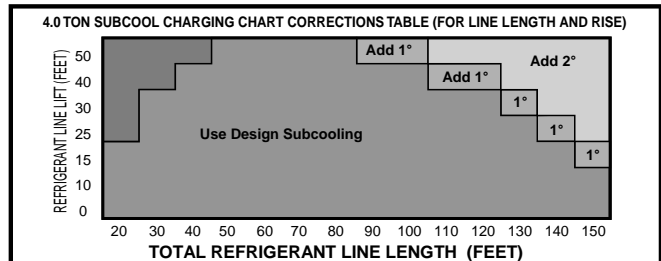
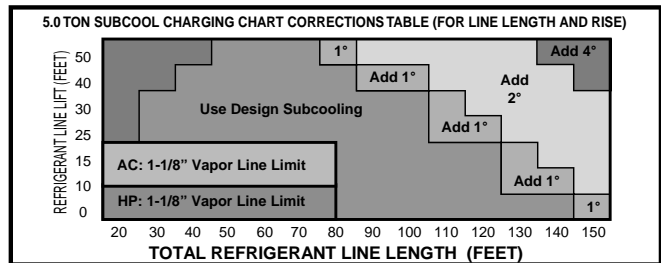

Table AC/IN-8-D — 060 Units



NOTE: 150 ft. length is approved ONLY with 7/8" vapor lines.

B. Weigh-in Method

Weigh-in Method can be used for the initial installation or anytime a system charge is being replaced. Weigh-In Method can also be used when power to the equipment is not available or operation conditions (indoor/outdoor temperatures) are not in range to verify with the subcooling charging method. (Tables 15-17 assume 3/8" Liquid Line.)

Table AC/IN-9-A

18 SEER HEAT PUMPS			
A	B	C	D
Model	Factory Charge	Charge Adder for Indoor Coil	Charge Multiplier for Interconnecting Refrigerant Tube Length
024	7lb, 6oz	6oz	0.6oz per foot
036	8lb, 3oz	8oz	0.6oz per foot
037	9lb, 8oz	12oz	0.6oz per foot
048	9lb, 13oz	13oz	0.6oz per foot
049	10lb, 12oz	15oz	0.6oz per foot
060	11lb, 14oz	1lb, 2oz	0.6oz per foot

Table AC/IN-9-B

20 SEER HEAT PUMPS			
A	B	C	D
Model	Factory Charge	Charge Adder for Indoor Coil	Charge Multiplier for Interconnecting Refrigerant Tube Length
024	7lb, 6oz	6oz	0.6oz per foot
036	9lb, 8oz	12oz	0.6oz per foot
048	10lb, 12oz	15oz	0.6oz per foot
060	11lb, 14oz	1lb, 2oz	0.6oz per foot

Note: The only mode approved for setting or validating system charge is using Charging Mode-Cooling. Charging Mode-Cooling is a variable speed test mode found in the 950/850 comfort control Technician Menu. Outdoor Temperature must be between 55°F and 120°F with Indoor Temperature kept between 70°F and 80°F.

Table AC/IN-9-C

18 & 20 SEER AIR CONDITIONERS			
A	B	C	D
Model	Factory Charge	Charge Adder for Indoor Coil	Charge Multiplier for Interconnecting Refrigerant Tube Length
024	7lb, 6oz	6oz	0.6oz per foot
036	7lb, 14oz	7oz	0.6oz per foot
048	11lb, 1oz	1lb, 0oz	0.6oz per foot
060	11lb, 14oz	1lb, 2oz	0.6oz per foot

STEP 1 - Measure in feet and record the distance between the outdoor unit and the indoor unit. Include the entire length of the tubing from the service valve to the IDU.
 STEP 2 - Record the Charge Multiplier from Column D.
 STEP 3 - Multiply the total length of refrigerant tubing from Step 1 times the value from Step 2. Record the result.
 STEP 4 - Locate the outdoor equipment size from Column A of the appropriate table above and record the value found in Column C.
 STEP 5 - Add the values from Step 3 and Step 4 and record the resulting value. This is the amount of refrigerant to weigh-in prior to opening the service valves.

New Installation Weigh-In Method Worksheet

(Step 1) Line Length (ft) _____
 (Step 2) Value from Column D x _____
 (Step 3) Step 1 times Step 2 = _____
 (Step 4) Charge Adder (column C) + _____
 (Step 5) Refrigerant (Steps 3+4) = _____

STEP 1 - Measure in feet and record the distance between the outdoor unit and the indoor unit. Include the entire length of the tubing from the service valve to the IDU.
 STEP 2 - Record the Charge Multiplier from Column D.
 STEP 3 - Multiply the total length of refrigerant tubing from Step 1 times the value from Step 2. Record the result.
 STEP 4 - Locate the outdoor equipment size from Column A of the appropriate table above and record the value found in Column C.
 STEP 5 - Record the value in Column B.
 STEP 6 - Add the values from Step 3, Step 4 and Step 5 and record the resulting value. This is the amount of refrigerant to weigh-in.

Sealed-System Weigh-In Method Worksheet

(Step 1) Line Length (ft) _____
 (Step 2) Value from Column D x _____
 (Step 3) Step 1 times Step 2 = _____
 (Step 4) Charge Adder (column C) + _____
 (Step 5) Factory Charge (column B) + _____
 (Step 6) Refrigerant (Steps 3+4+5) = _____

Split Systems with Variable Speed Compressor

Table AC/IN-10-A — Charge Chart

R-410A REFRIGERANT CHARGING CHART							
LIQUID TEMP (°F)	DESIGN SUBCOOLING (°F)						
	8	9	10	11	12	13	14
	LIQUID GAGE PRESSURE (PSI)						
55	179	182	185	188	191	195	198
60	195	198	201	204	208	211	215
65	211	215	218	222	225	229	232
70	229	232	236	240	243	247	251
75	247	251	255	259	263	267	271
80	267	271	275	279	283	287	291
85	287	291	296	300	304	309	313
90	309	313	318	322	327	331	336
95	331	336	341	346	351	355	360
100	355	360	365	370	376	381	386
105	381	386	391	396	402	407	413
110	407	413	418	424	429	435	441
115	435	441	446	452	458	464	470
120	464	470	476	482	488	495	501
125	495	501	507	514	520	527	533

Refer to Service Facts or Installer's Guide for charging method.

From Dwg. D154557P01 Rev. 3

Table AC/IN-10-B — Line Sizes Rated Line Sizes

MODEL	RATED LINE SIZE		SERVICE VALVE CONNECTION SIZE	
	Vapor Line	Liquid Line	Vapor Line	Liquid Line
HP 4A6V				
HP 024	5/8" (a)	3/8"	5/8"	3/8"
HP 036	3/4" (a)	3/8"	3/4"	3/8"
HP 037	3/4" (a)	3/8"	3/4"	3/8"
HP 048	7/8" (a)	3/8"	7/8"	3/8"
HP 049	7/8" (a)	3/8"	7/8"	3/8"
HP 060	1-1/8"(b)	3/8"	7/8"	3/8"
AC 4A7V				
AC 024	5/8" (a)	3/8"	5/8"	3/8"
AC 036	3/4" (a)	3/8"	3/4"	3/8"
AC 048	7/8"(a)	3/8"	7/8"	3/8"
AC 060	1-1/8"(c)	3/8"	7/8"	3/8"

- (a) The maximum length of refrigerant lines from outdoor to indoor unit must NOT exceed 150 feet. The maximum vertical change must NOT exceed 50 feet.
- (b) The maximum length of refrigerant lines from outdoor to indoor unit must NOT exceed 80 feet. The maximum vertical change must NOT exceed 10 feet.
- (c) The maximum length of refrigerant lines from outdoor to indoor unit must NOT exceed 80 feet. The maximum vertical change must NOT exceed 25 feet.

Table AC/IN-10-C — Alternate Line Sizes

MODEL	LINE SIZE		SERVICE VALVE CONNECTION SIZE	
	Vapor Line	Liquid Line	Vapor Line	Liquid Line
HP 4A6V				
HP 024	3/4" (a)	5/16" (d)	5/8"	3/8"
HP 036	5/8" (a)	5/16" (d)	3/4"	3/8"
	7/8" (c)	5/16" (d)	3/4"	3/8"
HP 037	5/8" (a)	5/16" (d)	3/4"	3/8"
	7/8" (c)	5/16" (d)	3/4"	3/8"
HP 048	3/4" (a)	3/8"	7/8"	3/8"
HP 049	3/4" (a)	3/8"	7/8"	3/8"
HP 060	3/4" (a)	3/8"	7/8"	3/8"
	7/8" (a)	3/8"	7/8"	3/8"
AC 4A7V				
AC 024	3/4" (a)	5/16"	5/8"	3/8"
AC 036	5/8" (a)	5/16"	3/4"	3/8"
	7/8" (c)	5/16"	3/4"	3/8"
AC 048	3/4" (a)	3/8"	7/8"	3/8"
AC 060	3/4" (a)	3/8"	7/8"	3/8"
	7/8" (a)	3/8"	7/8"	3/8"

- (a) The maximum length of refrigerant lines from outdoor to indoor unit must NOT exceed 150 feet. The maximum vertical change must NOT exceed 50 feet.
- (b) The maximum length of refrigerant lines from outdoor to indoor unit must NOT exceed 80 feet. The maximum vertical change must NOT exceed 10 feet.
- (c) The maximum length of refrigerant lines from outdoor to indoor unit must NOT exceed 80 feet. The maximum vertical change must NOT exceed 25 feet.
- (d) If using 5/16", the change adder is 0.0270 lbs/ft (0.43 oz/ft).

Branch Circuit Wire Sizing Table/ Heater De-Rating Chart

BRANCH CIRCUIT WIRE SIZING TABLE

(Based on 2% Voltage Drop)

Chart is based on 75° C. wire. (Types FEPW, RH, RHW, THHW, THW, THWN, XHHW, USE, AND ZW.)
Use Chart For Wire Sizing Only. Refer To Electrical Code, (Or Product Specs.) For Fuse Sizing

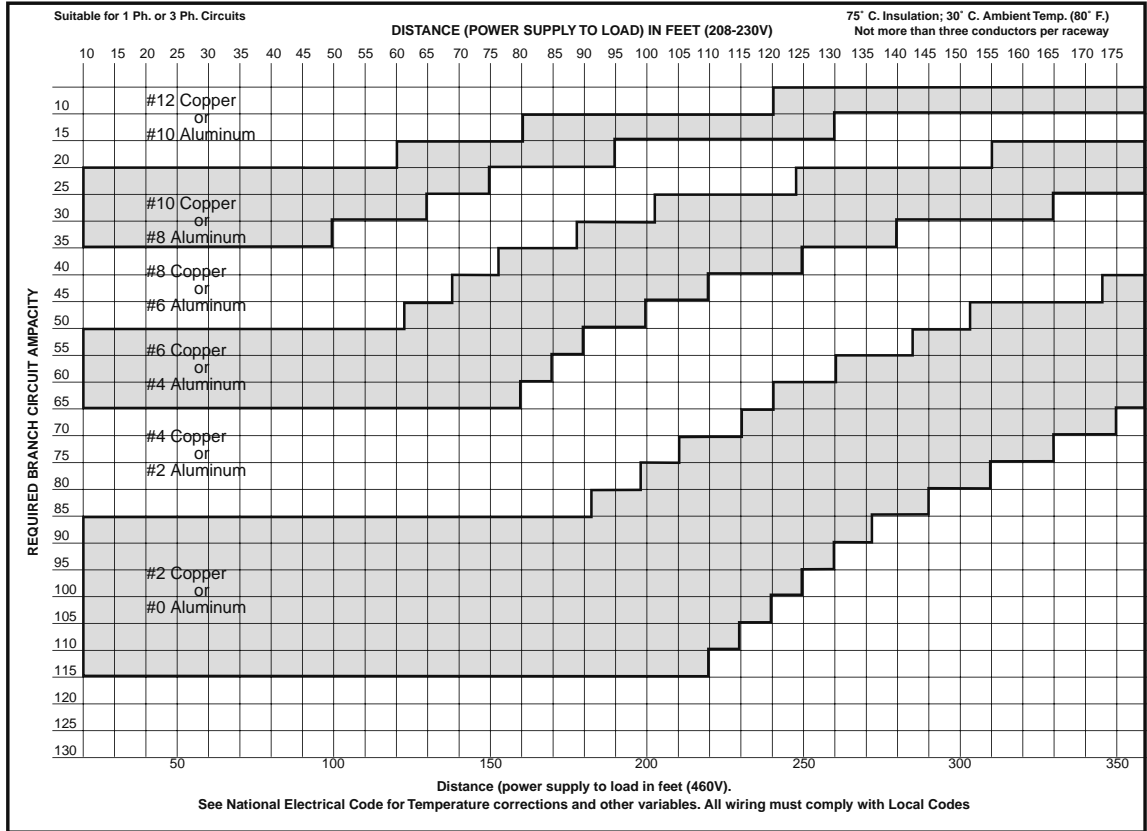

Heater De-Rating Chart

The output of electric heaters, applied at voltages other than the rated 240 or 480 volts, can be easily determined with the use of this chart.

ELECTRIC HEATER DE-RATING CHART

(For 240V or 480V Rated Heaters installed on Lower Voltage Systems)

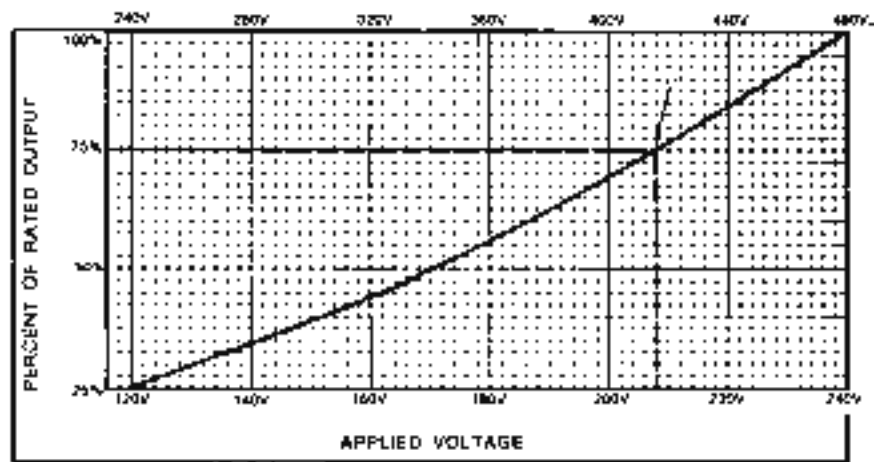

EXAMPLE. Calculated Heat Loss - 29,200 BTUH Power Supply - 208V.
The chart indicates that any 240V heater will deliver 75% of its rated capacity at 208V.
29,200 BTUH / 75 = 38,933 BTUH | Select a heater having AT LEAST 39,000 BTUH capacity at 240V

For complete equipment / combination selections, installation instructions and warranty information, please refer to Product Data/Ratings and/or Installers Guides and Limited Warranty Handbooks.

Basic Air Conditioning Formulas

Basic Air Conditioning Formulas

TO DETERMINE	EXPRESSED AS	COOLING	HEATING and/or HUMIDIFYING
Total Airflow	CFM _T	1. $CFM_T = \frac{N_T V}{60 \text{ min./hr.}}$	1. $CFM_T = \frac{N_T V}{60 \text{ min./hr.}}$
Infiltration or Ventilation	CFM _O	2. $CFM_O = \frac{N_O V}{60 \text{ min./hr.}}$	2. $CFM_O = \frac{N_O V}{60 \text{ min./hr.}}$
Number of Air Changes Per Hour – Total	N _T	3. $N_T = \frac{CFM_T (60 \text{ min./hr.})}{V}$	3. $N_T = \frac{CFM_T (60 \text{ min./hr.})}{V}$
Number of Air Changes Per Hour – Outdoor Air	N _O	4. $N_O = \frac{CFM_O (60 \text{ min./hr.})}{V}$	4. $N_O = \frac{CFM_O (60 \text{ min./hr.})}{V}$
Total Heat (H _T)	Btuh	5. $H_T = CFM_T \times 4.5 \times (h_1 - h_2) = \text{Btuh}$	6. $H_T = CFM_T \times 4.5 \times (h_2 - h_1) = \text{Btuh}$
Sensible Heat (H _S)	Btuh	7. $H_S = CFM_T \times 1.08 \times (T_1 - T_2) = \text{Btuh}$	8. $H_S = CFM_T \times 1.08 \times (T_2 - T_1) = \text{Btuh}$
Latent Heat (H _L)	Btuh	9. $H_L = CFM_T \times .68 \times (W_1 - W_2) = \text{Btuh}$	10. $H_L = CFM_T \times .68 \times (W_2 - W_1) = \text{Btuh}$
Entering Air Temperature (T ₁) (Mixed Air)	°F. D.B.	11. $T_1 = t_1 + \frac{CFM_O}{CFM_T} \times (t_2 - t_1) = \text{°F.D.B.} \text{ ①}$ ① If duct heat gain is a factor, add to T ₁ : $\frac{\text{Duct Heat Gain (Btuh)}}{CFM_T \times 1.08}$	12. $T_1 = t_1 - \frac{CFM_O}{CFM_T} \times (t_1 - t_2) = \text{°F.D.B.} \text{ ②}$ ② If duct heat loss is a factor, subtract from T ₁ : $\frac{\text{Duct Heat Loss (Btuh)}}{CFM_T \times 1.08}$
Leaving Air D.B. Temperature (T ₂)	°F. D.B.	13. $T_2 = T_1 - \frac{H_S}{CFM_T \times 1.08} = \text{°F.D.B.}$	14. $T_2 = T_1 + \frac{H_S}{CFM_T \times 1.08} = \text{°F.D.B.}$
Required Airflow	CFM _T	15. $CFM_T = \frac{H_S (\text{total})}{1.08 \times (T_1 - T_2)} = \text{CFM}$ OR $CFM_T = \frac{H_S (\text{internal}) \text{ ③}}{1.08 \times (t_1 - T_2)} = \text{CFM}$ ③ Sensible load of outside air not included	16. $CFM_T = \frac{H_S}{1.08 \times (T_2 - T_1)} = \text{CFM}$
Enthalpy – Leaving Air (h ₂)	Btu/lb. dry air	17. $h_2 = h_1 - \frac{H_T}{CFM_T \times 4.5} = \text{Btu/lb. dry air}$	18. $h_2 = h_1 + \frac{H_T}{CFM_T \times 4.5} = \text{Btu/lb. dry air}$
Leaving Air W.B. Temperature	°F.W.B.	19. Refer to Enthalpy Table and read W.B. temperature corresponding to enthalpy of leaving air (h ₂) (see #17).	20. Refer to Enthalpy Table and read W.B. temperature corresponding to enthalpy of leaving air (h ₂) (see #18).
Heat Required to Evaporate Water Vapor Added to Ventilation Air	Btuh	21. $H_L = CFM_O \times .68 (W_3 - W_O) = \text{Btuh}$	22. $H_L = CFM_O \times .68 (W_3 - W_O) = \text{Btuh}$
Humidification Requirements	Lbs. water/hr.	23. $\left(\begin{matrix} \text{Make up} \\ \text{Moisture} \end{matrix} \right) = \frac{\text{Excess Latent Capacity of System} \times \% \text{ Run Time}}{1060 \text{ Btu/lb.}} = \text{lbs./hr.}$ (Industrial Process Work)	24. $\left(\begin{matrix} \text{Make up} \\ \text{Moisture} \end{matrix} \right) = \frac{H_L \text{ loss Btuh (see #22)}}{1060 \text{ Btu/lb.}} = \text{lbs./hr.}$

LEGEND	DERIVATION OF AIR CONSTANTS
<p>CFM_T = Total airflow cubic feet/min. CFM_O = Outdoor air cubic feet/min. N_T = Total air changes per hour N_O = Outdoor air, air changes per hour V = Volume of space cubic feet H_T = Total heat Btuh H_S = Sensible heat Btuh H_L = Latent heat Btuh * h₁ = Enthalpy or total heat of entering air * h₂ = Enthalpy or total heat of leaving air T₁ = Temperature of entering air T₂ = Temperature of leaving air T_{adp} = Apparatus dewpoint t₁ = Indoor design temperature t₂ = Outdoor design temperature W₁ = Grains of water/lb. of dry air at entering condition W₂ = Grains of water/lb. of dry air at leaving condition W₃ = Grains of water/lb. of dry air at indoor design conditions W_O = Grains of water/lb. of dry air at outdoor design conditions</p>	<p>The air constants below apply specifically to standard air which is defined as dry air at 70°F and 14.7 P.S.I.A. (29.92 in. mercury column). They can, however, be used in most cooling calculations unless extremely precise results are desired.</p> <p>4.5 (To convert CFM to lbs./hr.)</p> <p>$4.5 = \frac{60 \text{ min./hr.}}{13.33}$ or $60 \times .075$</p> <p>Where 13.33 is the specific volume of standard air (cu.ft./lb.) and .075 is the density (lbs./cu.ft.)</p> <p>$1.08 = \frac{.24 \times 60}{13.33}$ or $.24 \times 4.5$</p> <p>.24 BTU = specific heat of standard air (BTU/LB./°F)</p> <p>$.68 = \frac{60}{13.33} \times \frac{1060}{7000}$ or $4.5 \times \frac{1060}{7000}$</p> <p>Where: 1060 = Average Latent Heat of water vapor (BTU/LB.). 7000 = Grains per lb.</p>

* See Enthalpy of air (Total Heat Content of Air) Table for exact values.

Low Ambient Accessories Cooling and Heating Models

Table AC/IN-13-A — Low Ambient Accessories Cooling Models

Low Ambient Accessory For American Standard Residential Cooling Units												
Cooling Unit	55°F	30°F to 55°F				0°F to 30° or 20°F to 30°F - Please Reference Lowest Approved Outdoor Operating Temperature per Model Family Table						
	As Manufactured	AY28X079	TXV-NB	CCHT	BAYACHP024	BAYLOAM103	AY28X079	TXV-NB	Start Kit	Compressor Crankcase Heater	Windshield	Liquid Line Solenoid Valve
4TTA3 ^①	X	X	X	—	—	X	X	X	N/A	—	X	X
4TTB3/4TTB4 ^① 4TTB6	X	X	X	X	—	X	X	X	X	X	X	X
4A7A3/4A7A5 ^①	X	X	X	X	—	X	X	X	X	X	X	X
4A7A6-H ^②	X	X	X	X	—	X	X	X	X	X	X	X
4A7A6 ^④ 4A7A7	X	X	X	X	—	X	X	X	X	X	X	X
4A7Z0 ^③	X	Not Approved				Not Approved						
4A7V	X	Not Approved				Not Approved						

Table AC/IN-13-B — Low Ambient Accessories Heating Models

Low Ambient Accessory For American Standard Residential Heat Pump Units												
Heat Pump Unit	55°F	30°F to 55°F				0°F to 30° or 20°F to 30°F - Please Reference Lowest Approved Outdoor Operating Temperature per Model Family Table						
	As Manufactured	AY28X079	TXV-NB	CCHT	BAYACHP024	BAYLOAM103	AY28X084	TXV-NB	Start Kit	Compressor Crankcase Heater	Windshield	Liquid Line Solenoid Valve
4TWA3 ^①	X	X	X	X	—	X	X	X	N/A	—	X	—
4TWB3/4TWB6 ^①	X	X	X	X	—	X	X	X	X	X	X	—
4A6H3 ^① 4A6H5	X	X	X	X	—	X	X	X	X	X	X	—
4A6H6 ^④ 4A6H7	X	X	X	X	—	X	X	X	X	X	X	—
4A6Z0 ^③	X	Not Approved				Not Approved						
4A6V	X	Not Approved				Not Approved						

Charts are for quick reference only. For complete application guidelines, consult the specific SSC-APG***.

- ① Reference AMSSP-APG001-EN for complete Low Ambient Guidelines.
- ② Reference AMSSP-APG002-EN for complete Low Ambient Guidelines.
- ③ Reference SSC-APG008-EN for complete Low Ambient Guidelines.
- ④ Reference APP-APG014-EN.

Table AC/IN-13-C — Lowest Approved Outdoor Operating Temperature for Cooling Operation per Model Family Table

Model Family	Lowest Approved OD Ambient
4A7Z0/4A6Z0	55°F
4A7A6/4A6H6/4A7A7/4A6H7	20°F
4A7A5018-060/4A6H5/4A7A6-H	20°F
4A7A3/4A6H3	0°F
4A7B4018-060/4A6B4/4A7A6-H	20°F
4TTB3/4A7B3/4TWB3/4A6B3	0°F
4A7C3/4A6C3	0°F
4A7V/4A6V	55°F

For a detailed Application Bulletin on required accessories and wind shields for low outdoor ambient operation, please contact your Territory Manager or Local FSR.

For complete equipment / combination selections, installation instructions and warranty information, please refer to Product Data/Ratings and/or Installers Guides and Limited Warranty Handbooks.

Wind Shields

Wind Shields are required to block prevailing winds across condenser coil. In applications where cooling

operation is required to 0°F, wind shields are a Must. Use the following guidelines for your application.

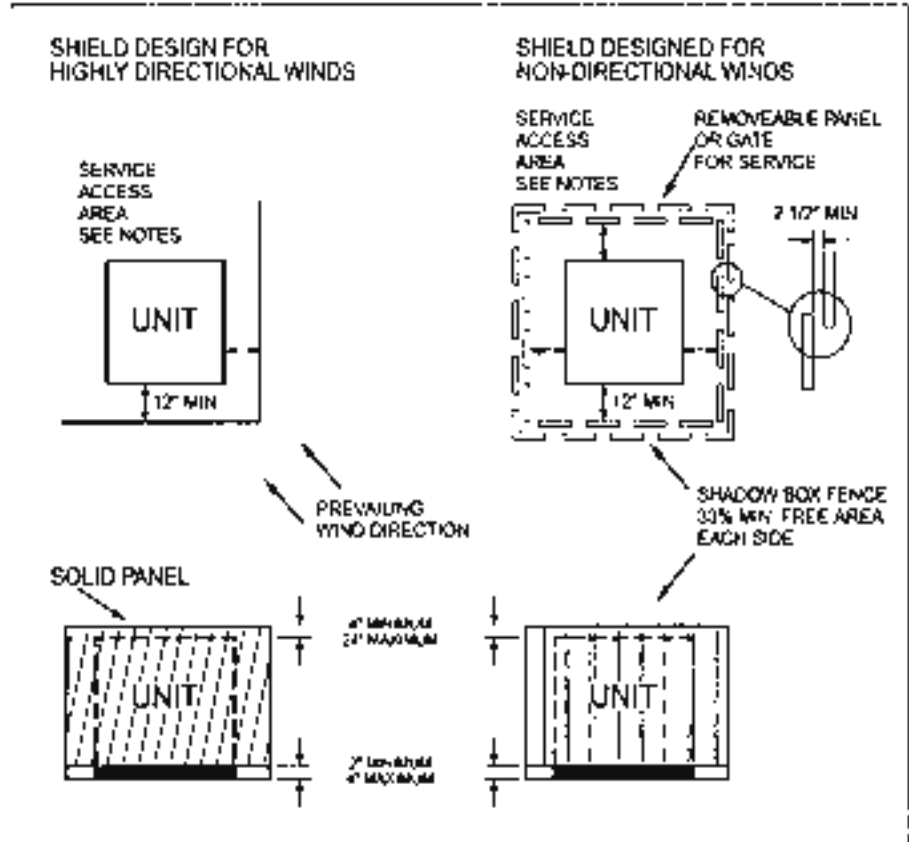

Notes:

Minimum working clearance must be in compliance with the National Electric Code. Currently, the minimum clearance between a wood or suitable grounding material type fence requires minimum 3 feet. If other material is used to form the windshield, the minimum space may be increased to 3.5 feet. Please consult the 2006 Edition of the National Electric Code, Article 110 for the most up to date information, please refer to the most current National Electric Code.

For a detailed Application Bulletin on required accessories and wind shields for low outdoor ambient operation, please contact your Territory Manager or Local FSR.

Split System Cooling Three Phase - 6-25 Tons, R-410A

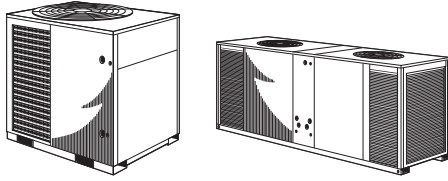

TTA - 6-25 Tons

- ReliaTel™ controls option
- (1) Scroll compressor (TTA073-120D)
- (2) Scroll compressors (TTA120E-240E) with independent refrigerant circuits
- (2) Manifolded scroll compressors (TTA120F, 180F-300F)
- Single point power
- Compressor motor overload protection
- Compressor discharge temperature limit switch
- Control transformer
- High and low pressure cut-out switches
- Liquid line filter drier, factory installed
- Service valves with pressure taps
- Electrical phase reversal protection
- Internal pressure relief valves
- Holding charge (Dry Nitrogen)
- Copper tube, aluminum plate fin coils
- Low ambient cooling to 50°F as shipped
- Low ambient cooling to 0°F with accessory head pressure control
- Mounting/lifting rails under base
- UL listed
- **5-year compressor warranty (TTA073-120D/TTA120-180E/TTA120-180F)**
- **1-year compressor warranty (TTA240E,F,TTA300F)**
- **1-year limited parts warranty**
- **Optional Extended Warranties**

1 2 3 4 5 6 7 8 9 10 11 12
T T A 0 9 0 D 3 0 0 A 0

Compressor Type

- D = Single Compressor/Single Refrigerant Circuit, R-410A
- E = Dual Compressor/Dual Refrigerant Circuit, R-410A
- F = Dual Compressor/Single Manifolded Refrigerant Circuit, R-410A

Factory-Installed Options

- 00 = Packed Stock
- 0S = Black Epoxy Coated Coil
- 0R = ReliaTel™ Controls
- 0T = ReliaTel™ Controls and Black Epoxy Coated Coil

1 2 3 4 5 6 7 8 9 10 11 12
T T A 0 9 0 D 3 0 0 A 0

Compressor Type

- D = Single Compressor/Single Refrigerant Circuit, R-410A
- E = Dual Compressor/Dual Refrigerant Circuit, R-410A
- F = Dual Compressor/Single Manifolded Refrigerant Circuit, R-410A

Factory-Installed Options

- H0 = Hail Guard
- HS = Hail Guard and Black Epoxy Coated Coil
- HR = Hail Guard and ReliaTel™ Controls
- HT = Hail Guard and ReliaTel™ Controls with Black Epoxy Coated Coil

Table LSC-1-A — TTA Split System Heat Pumps - Single Compressors with Single Refrigerant Circuits - R-22 Refrigerant

Model Number	Power Supply	Nom. Cap. Cooling (BTUH)	Uncrated Dimensions(in.)			Shipping Weight (lbs.)	Sound ^① Rating	MCA*	Max. Fuse*	Line Size	
			H	W	L					OD Gas	OD Liq.
TTA090A30R0G	208-230/3/60	90,000	39	36	42	363	83	31.1	45	1 ³ / ₈	5/8
TTA120A30R0G	208-230/3/60	120,000	45	40	52	467	90	42.6	60	1 ³ / ₈	1/2
TTA090A40R0G	460/3/60	90,000	39	36	42	363	83	15.2	25	1 ³ / ₈	1/2
TTA120A40R0G	460/3/60	120,000	45	40	52	467	90	21.9	30	1 ³ / ₈	1/2

Table LSC-1-B — TTA Split System Heat Pumps - Dual Compressors with Dual Refrigerant Circuits - R-22 Refrigerant

Model Number	Power Supply	Nom. Cap. Cooling (BTUH)	Uncrated Dimensions(in.)			Shipping Weight (lbs.)	Sound ^① Rating	MCA*	Max. Fuse*	Line Size	
			H	W	L					OD Gas	OD Liq.
TTA180B30R0G	208-230/3/60	180,000	46	45	95	850	93	60.4	80	1 ³ / ₈	1/2
TTA240B30R0G	208-230/3/60	240,000	46	45	95	970	94	77.7	100	1 ³ / ₈	1/2
TTA180B40R0G	460/3/60	180,000	46	45	95	850	93	29.5	40	1 ³ / ₈	1/2
TTA240B40R0G	460/3/60	240,000	46	45	95	970	94	39.9	50	1 ³ / ₈	1/2

^① Sound rating show is tested in accordance with AHRI Standard 270 or 370.

* Information subject to change. Please confirm with current Product Data/Service Facts for current factory production.

Split System Cooling Three Phase – 6-25 Tons, R-410A

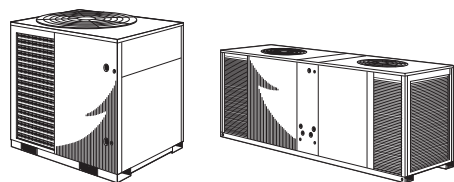

TTA – 6-25 Tons

- ReliaTel™ controls option
- (1) Scroll compressor (TTA073D-120D)
- (2) Scroll compressors (TTA120D-240E) with independent refrigerant circuits
- (2) Manifoldd scroll compressors (TTA120F, 180-240F)
- Single point power
- Compressor motor overload protection
- Compressor discharge temperature limit switch
- Control transformer
- High and low pressure cut-out switches
- Liquid line filter drier, factory installed
- Service valves with pressure taps
- Electrical phase reversal protection
- Internal pressure relief valves
- Holding charge (Dry Nitrogen)
- Copper tube, aluminum plate fin coils
- Low ambient cooling to 50°F as shipped
- Low ambient cooling to 0°F with accessory head pressure control
- Mounting/lifting rails under base
- UL listed
- **5-year compressor warranty (TTA073-120D/TTA120-180E/TTA120-180F)**
- **1-year compressor warranty (TTA240E,F)**
- **1-year limited parts warranty**
- **Optional Extended Warranties**

1 2 3 4 5 6 7 8 9 10 11 12
T T A 0 9 0 D 3 0 0 A 0

Compressor Type

- D = Single Compressor/Single Refrigerant Circuit, R-410A
- E = Dual Compressor/Dual Refrigerant Circuit, R-410A
- F = Dual Compressor/Single Manifoldd Refrigerant Circuit, R-410A

Factory-Installed Options

- 00 = Packed Stock
- 0S = Black Epoxy Coated Coil
- 0R = ReliaTel™ Controls
- 0T = ReliaTel™ Controls and Black Epoxy Coated Coil

1 2 3 4 5 6 7 8 9 10 11 12
T T A 0 9 0 D 3 0 0 A 0

Compressor Type

- D = Single Compressor/Single Refrigerant Circuit, R-410A
- E = Dual Compressor/Dual Refrigerant Circuit, R-410A
- F = Dual Compressor/Single Manifoldd Refrigerant Circuit, R-410A

Factory-Installed Options

- H0 = Hail Guard
- HS = Hail Guard and Black Epoxy Coated Coil
- HR = Hail Guard and ReliaTel™ Controls
- HT = Hail Guard and ReliaTel™ Controls with Black Epoxy Coated Coil

Table LSC-2-A — TTA Split System Cooling — Dual Manifoldd Compressors with Single Refrigerant Circuits — R-410 Refrigerant

Model Number	Power Supply	Nom. Cap. Cooling (BTUH)	Uncrated Dimensions(in.)			Shipping Weight (lbs.)	Sound ^① Rating	MCA*	Max. Fuse*	Line Size	
			H	W	L					OD Gas	OD Liq.
TTA120F300A	208-230/3/60	120,000	39	40	52	509	91	44.6	50	1 ³ / ₈	1/2
TTA180F300A	208-230/3/60	180,000	45	45	95	852	93	66.3	80	1 ⁵ / ₈	5/8
TTA240F300A	208-230/3/60	246,000	45	45	95	966	94	98	110	1 ⁵ / ₈	5/8
TTA300F300A	208-230/3/60	292,000	51	45	95	1112	94	130.6	150	2 ¹ / ₈	5/8
TTA120F400A	460/3/60	120,000	39	40	52	509	91	24.1	30	1 ³ / ₈	1/2
TTA180F400A	460/3/60	180,000	45	45	95	852	93	32.5	40	1 ⁵ / ₈	5/8
TTA240F400A	460/3/60	246,000	45	45	95	966	94	49.6	60	1 ⁵ / ₈	5/8
TTA300F400A	460/3/60	292,000	51	45	95	1112	94	51.6	60	2 ¹ / ₈	5/8
TTA120FW00A	575/3/60	120,000	39	40	52	509	91	15.7	20	1 ³ / ₈	1/2
TTA180FW00A	575/3/60	180,000	45	45	95	852	93	26.3	30	1 ⁵ / ₈	5/8
TTA240FW00A	575/3/60	246,000	45	45	95	966	94	39.6	45	1 ⁵ / ₈	5/8
TTA300FW00A	575/3/60	292,000	51	45	95	1112	94	40.9	45	2 ¹ / ₈	5/8

① Sound rating show is tested in accordance with AHRI Standard 270 or 370.

* Information subject to change. Please confirm with current Product Data/Service Facts for current factory production.

Split System Cooling – R-410A Accessories Three Phase – 6-25 Tons

Table LSC-3-A — R-410A Optional Accessories

Model Number	Description	Used With
Coil Guard		
BAYGARD058A	Hail/Vandal Guard	TTA073D, TTA090D
BAYGARD059A	Hail/Vandal Guard	TTA120D/E/F
BAYGARD060A	Hail/Vandal Guard	TTA150E
BAYGARD061A	Hail/Vandal Guard	TTA180E/F, TTA240E/F
BAYGARD062A	Hail/Vandal Guard	TTA300F
Hot Gas By-Pass		
BAYHGBP010A	Universal Hot Gas Bypass Kit	TTA073D-TTA300F
Isolators		
BAYISLT004A	Rubber Isolator Floor (blue)	TTA073D-TTA090D
BAYISLT005A	Rubber Isolator Floor (black)	TTA120D/E/F
BAYISLT009A	Rubber Isolator Floor (red)	TTA150E, TTA180E/F
BAYISLT010A	Rubber Isolator Floor (green)	TTA240E/F, TTA300F
BAYISLT023A	Steel Spring Isolator Floor (red)	TTA073D, TTA090D, TTA120D
BAYISLT024A	Steel Spring Isolator Floor (black)	TTA120E/F, TTA150E, TTA180E/F
BAYISLT025A	Steel Spring Isolator Floor (yellow)	TTA240E/F, TTA300F
Low Ambient		
BAYLOAMU01A ^{①②③④}	On/Off Fan Control Mounted in External Enclosure (small cabinets)	TTA073-090 (all voltages)
BAYLOAMU02A ^{②③④}	On/Off Fan Control Mounted in Unit Control Box (large cabinets)	TTA120-300 (all voltages)
BAYLOAM335A ^③	Modulating ICM Head Pressure Control w/ 208-230V 0.5 HP Hi-Eff Motor (internal mount)	TTA073D3, TTA090D3
BAYLOAM336A ^③	Modulating ICM Head Pressure Control w/ 208-230V 1 HP Hi-Eff Motor (internal mount)	TTA120D3/E3/F3, TTA150E3, TTA180E3/F3, TTA240E3/F3, TTA300F3
BAYLOAM435A ^③	Modulating ICM Head Pressure Control w/ 460V 0.5 HP Hi-Eff Motor (internal mount)	TTA073D4, TTA090D4
BAYLOAM436A ^③	Modulating ICM Head Pressure Control w/ 460V 1.0 HP Hi-Eff Motor (internal mount)	TTA120D4/E4/F4, TTA150E4, TTA180E4/F4, TTA240E4/F4, TTA300F4
BAYLOAMW36A ^③	Modulating ICM Head Pressure Control w/ 575V 1.0 HP Hi-Eff Motor (internal mount)	TTA120DW/EW/FW, TTA150EW, TTA180EW/FW, TTA240EW/FW, TTA300FW
BAYLOTR001A ^⑤	Additional Pressure Transducer for ICM Head Pressure Control	TTA120E/F, TTA150E
Time Delay Relay		
BAYRLAY002	Time Delay Relay	TTA090D-TTA300F
BACnet™ Communications Interface		
BAYBCIR001A	BACnet (BCI-R) Communications Interface	All

① Kit mounts external to the outdoor unit and operates by sensing ambient and liquid line temperatures.

② Cycles fan on/off, (no modulating).

③ Quantity of 1 required for each fan (2 total for TTA/TWA180-300).

④ ReliaTel™ requires onboard EDC function to be disabled when Bayloam is used, remove OA sensor from terminal J8-1&2.

⑤ BAYLOTR001A required when modulating BAYLOAM kits used with units that have 2 compressors and 1 condenser fan.

Split System Cooling Three Phase – 6-25 Tons

Table LSC-4-A — ReliaTel™ Control Options

Model Number	Description	Used With
ASYSTAT106A	Zone Sensor, Set Point, Fan System	TTA073-TTA300 with ReliaTel™ Controls
ASYSTAT107A	Zone Sensor, Set Point Adj, Fan, System, EH, LED	TTA073-TTA300
ASYSTAT108A	Zone Sensor, 2 Set Point, Fan System	TTA073-TTA300 with ReliaTel™ Controls
ASYSTAT109A	Zone Sensor, 2 Set Point Adj, Fan, System, EH, LED	TTA073-TTA300
ASYSTAT777A	Digital Programmable Zone Sensor with Night Setback	TTA073-TTA300 with ReliaTel™ Controls
BAYSENS050 ^①	Wireless Zone Sensor	TTA073-TTA300 with ReliaTel™ Controls
BAYSENS073A	Room Sensor w/ Override and Cancel Button	TTA073-TTA300 with ReliaTel™ Controls
BAYSENS074A	Room Sensor w/ Temperature Adjustment and Override Button	TTA073-TTA300 with ReliaTel™ Controls
BAYSENS077A	Remote Sensor	ASYSTAT106A-ASYSTAT109A, ASYSTAT777A
BAYSENS110A	Dual Set Point w/ Manual/Auto Change Over	TTA073-TTA300 with ReliaTel™ Controls

Table SC-4-B — Electromechanical Control Options

Model Number	Description	Used With
ASYSTAT092A	2H/2C Touch Screen Digital Display Programmable Thermostat "Touch Screen"	All
ASYSTAT093A	3H/2C Digital Display Programmable Thermostat W/Humidity Sensor	All

^① Kit comes with everything required for installation and operation.

6 - 25 Tons with ReliaTel™ Controls TTA073-120D, TTA120-240E, TTA120-300F

Protection/Operation Timings and Features

Anti Short Cycle Timer (ASCT) Function — Provides a three (3) minute minimum “ON” time and a three (3) minute minimum “OFF” time for compressors, enhances compressor reliability by ensuring proper oil return. **Standard**

Built In Fan Delay Relay (FDR) Function — Provides custom indoor fan timing sequences for the different types of equipment, enhancing efficiency and reliability. **Standard**

Built In Night Set Back and Unoccupied Functions① — When using a standard dual setpoint/auto change over Zone Sensor Module (ZSM), this function is enabled by applying a short across terminal J6-11 and J6-12. Sets cooling setpoint up a minimum of 7°F, sets heating setpoint back a minimum of 7°F, and forces fan operation to automatic. **(requires time clock accessory or field supplied/installed switch or contacts).**

Built In “TEST” Mode — Aids in quick verification of system and control operation, exercises both hardware and software (no special tools required). **Standard**

Built In Unoccupied Mode① — When using a standard single setpoint/manual change over Zone Sensor Module (ZSM), this function is enabled by applying a short across terminal J6-11 and J6-12. Forces fan operation to automatic. **(requires time clock accessory or field supplied/installed switch or contacts.)**

Direct Digital Control (DDC)① — Proportional Integral (PI) control. Proportional – sets corrective action proportional to deviation from setpoint. Integral – fine tunes the rate of corrective action proportional to the error (results in superior space temperature control). **Standard**

Increased Reliability — Fewer components (moving electro-mechanical parts), less likelihood of equipment down time or failure. **Standard**

Integral Electric Heat Staging① — Stages electric heaters “OFF” and “ON”, eliminating the use of outdated sequencers. **Standard**

Intelligent Fallback① — A built in Default Control provides adaptive operation, which allows the equipment to continue to operate, providing comfort in the event of certain component failures. Also, allows emergency operation without a Zone Sensor Module (ZSM). **Standard**

Low Ambient Start Timer (LAST) Function — Bypasses low pressure control when a compressor starts, eliminating nuisance compressor lock outs. **Standard**

Lower Installation Cost — Using a standard Zone Sensor Module (ZSM), control voltage wiring may be run up to five (5) times further than any electromechanical system, with no increase in wire gauge. Example: Electromechanical System – 30 feet maximum using 22 gauge wire. Micro Control System – 150 feet using 22 gauge wire. **Standard**

On Board Diagnostics① — Assist with equipment troubleshooting, if a problem occurrence should take place. **Standard**

Remote Sensing① — All standard Zone Sensor Modules (ZSMs) have remote sensing capabilities, typically achieved by using an expensive program-mable thermostat and remote sensor with electromechanical equipment. **Accessory (requires use of remote sensor).**

Space Temperature Averaging① — All standard Zone Sensor Modules (ZSMs) have space temperature averaging capabilities, typically achieved by using an expensive programmable thermostat and minimum of four (4) remote sensors with electromechanical equipment. **Averaging with ReliaTel™ can be achieved with two (2) sensors.**

Time Delay Relay (TDR) Function — Provides an incremental staging delay between compressors, minimizes equipment current inrush and consumption by keeping compressors from starting simultaneously. **Standard**

Low Pressure and High Pressure Compressor Lockout — 3 trips will lockout control.

When the ReliaTel™ RTRM Thermostat Interface is used, equipment operation differs significantly. The basic equipment protection features remain intact, and the following features and benefits are lost:

- Direct Digital Control (DDC) – Proportional Integral (PI) control is lost, equipment is controlled by a thermostat or generic building automation system device.
- Intelligent Fall back is lost, if a failure occurs in the device controlling the equipment, operation will cease.
- Installation is more costly, with the addition of a thermostat or generic control, the control wiring size must be increased.
- Remote Sensing capabilities are lost, unless generic control being applied can accomplish this.
- Space Temperature Averaging capabilities are lost, unless generic control being applied can accomplish this.
- Built In Night Set Back and Unoccupied functions are lost, unless generic control being applied can accomplish this.
- Built In Unoccupied Mode is lost, unless generic control being applied can accomplish this.

① Denotes features lost from utilizing standard conventional stat.

Split System Heat Pumps Three Phase – 6-20 Tons, R-410A

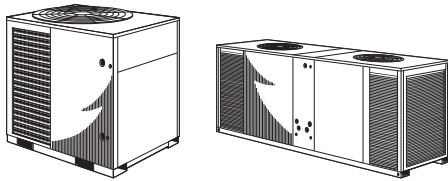

TWA – 6-20 Tons

- ReliaTel™ controls (standard)
- (1) Scroll compressor (TWA073-120D)
- (2) Scroll compressors (TWA180-240E) with independent refrigerant circuits
- Single point power
- Compressor motor overload protection
- Compressor discharge temperature limit switch
- Control transformer
- High and low pressure cut-out switches
- Liquid line filter drier, factory installed
- Service valves with pressure taps
- Demand Defrost Control
- Internal pressure relief valves
- Electrical phase reversal protection
- Holding charge (Dry Nitrogen)
- Copper tube, aluminum plate fin coils
- Low ambient cooling to 50°F as shipped
- Low ambient cooling to 0°F with accessory head pressure control
- Mounting/lifting rails under base
- UL listed
- **5-year compressor warranty (TWA073D, TWA090D, TWA120D, TWA180E)**
- **1-year compressor warranty (TWA240E)**
- **1-year limited parts warranty**
- **Optional Extended Warranties**

1 2 3 4 5 6 7 8 9 10 11 12
T W A 0 9 0 D 3 0 0 A 0

Compressor Type

D = Single Compressor/Single Refrigerant Circuit, R-410A
E = Dual Compressor/Dual Refrigerant Circuit, R-410A

Factory-Installed Options

OR = ReliaTel™ Controls
OT = ReliaTel™ Controls and Black Epoxy Coated Coil

1 2 3 4 5 6 7 8 9 10 11 12
T W A 0 9 0 D 3 0 0 A 0

Compressor Type

D = Single Compressor/Single Refrigerant Circuit, R-410A
E = Dual Compressor/Dual Refrigerant Circuit, R-410A

Factory-Installed Options

HR = Hail Guard and ReliaTel™ Controls
HT = Hail Guard and ReliaTel™ Controls with Black Epoxy Coated Coil

Table LSH-1-A — TWA Split System Heat Pumps — Single Compressors with Single Refrigerant Circuits — R-410 Refrigerant

Model Number	Power Supply	Nom. Cap. Cooling (BTUH)	Uncrated Dimensions(in.)			Shipping Weight (lbs.)	Sound ^① Rating	MCA*	Max. Fuse*	Line Size (in)	
			H	W	L					OD Gas	OD Liq.
TWA073D30RA	208-230/3/60	78,000	39	36	42	382	84	31.1	40	1 1/8	1 1/2
TWA090D30RA	208-230/3/60	90,000	39	36	42	394	83	34.4	45	1 3/8	5/8
TWA120D30RA	208-230/3/60	120,000	45	40	52	509	90	42.6	60	1 3/8	1 1/2
TWA073D40RA	460/3/60	78,000	39	36	42	382	84	14.9	20	1 1/8	1 1/2
TWA090D40RA	460/3/60	90,000	39	36	42	394	83	17.9	25	1 3/8	5/8
TWA120D40RA	460/3/60	120,000	45	40	52	509	90	23.4	30	1 3/8	1 1/2
TWA073DW0RA	575/3/60	78,000	39	36	42	382	84	11.6	15	1 1/8	1 1/2
TWA090DW0RA	575/3/60	90,000	39	36	42	394	83	14.7	20	1 3/8	5/8
TWA120DW0RA	575/3/60	120,000	45	40	52	509	90	17.4	25	1 3/8	1 1/2

Table LSH-1-B — TWA Split System Heat Pumps — Dual Compressors with Two Sets of Refrigerant Circuits — R-410 Refrigerant

Model Number	Power Supply	Nom. Cap. Cooling (BTUH)	Uncrated Dimensions(in.)			Shipping Weight (lbs.)	Sound ^① Rating	MCA*	Max. Fuse*	Line Size (in)	
			H	W	L					OD Gas	OD Liq.
TWA180E30RA	208-230/3/60	180,000	46	45	95	898	93	66.3	80	1 3/8	1 1/2
TWA240E30RA	208-230/3/60	246,000	46	45	95	981	94	86.1	100	1 3/8	5/8
TWA180E40RA	460/3/60	180,000	46	45	95	898	93	33.4	40	1 3/8	1 1/2
TWA240E40RA	460/3/60	246,000	46	45	95	981	94	45.5	50	1 3/8	5/8
TWA180EW0RA	575/3/60	180,000	46	45	95	898	93	27.4	30	1 3/8	1 1/2
TWA240EW0RA	575/3/60	246,000	46	45	95	981	94	34.8	40	1 3/8	5/8

① Sound rating show is tested in accordance with AHRI Standard 270 or 370.

* Information subject to change. Please confirm with current Product Data/Service Facts for current factory production.

Split System Heat Pumps Three Phase – 6-20 Tons, R-410A

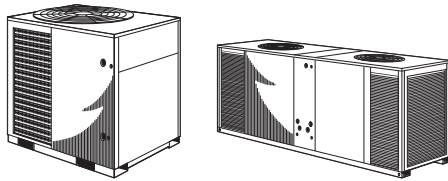

TWA – 6-20 Tons

- ReliaTel™ controls (standard)
- (1) Scroll compressor (TWA073-120D)
- (2) Scroll compressors (TWA180-240E) with independent refrigerant circuits
- Single point power
- Compressor motor overload protection
- Compressor discharge temperature limit switch
- Control transformer
- High and low pressure cut-out switches
- Liquid line filter drier, factory installed
- Service valves with pressure taps
- Demand Defrost Control
- Internal pressure relief valves
- Electrical phase reversal protection
- Holding charge (Dry Nitrogen)
- Copper tube, aluminum plate fin coils
- Low ambient cooling to 50°F as shipped
- Low ambient cooling to 0°F with accessory head pressure control
- Mounting/lifting rails under base
- UL listed
- **5-year compressor warranty (TWA073D, TWA090D, TWA120D, TWA180E)**
- **1-year compressor warranty (TWA240E)**
- **1-year limited parts warranty**
- **Optional Extended Warranties**

1 2 3 4 5 6 7 8 9 10 11 12
T W A 0 9 0 D 3 0 0 A 0

Compressor Type

D = Single Compressor/Single Refrigerant Circuit, R-410A
E = Dual Compressor/Dual Refrigerant Circuit, R-410A

Factory-Installed Options

OR = ReliaTel™ Controls
OT = ReliaTel™ Controls and Black Epoxy Coated Coil

1 2 3 4 5 6 7 8 9 10 11 12
T W A 0 9 0 D 3 0 0 A 0

Compressor Type

D = Single Compressor/Single Refrigerant Circuit, R-410A
E = Dual Compressor/Dual Refrigerant Circuit, R-410A

Factory-Installed Options

HR = Hail Guard and ReliaTel™ Controls
HT = Hail Guard and ReliaTel™ Controls with Black Epoxy Coated Coil

Table LSH-2-A — TWA Split System Heat Pumps - Single Compressors with Single Refrigerant Circuits - R-22 Refrigerant

Model Number	Power Supply	Nom. Cap. Cooling (BTUH)	Uncrated Dimensions(in.)			Shipping Weight (lbs.)	Sound [Ⓢ] Rating	MCA*	Max. Fuse*	Line Size (in)	
			H	W	L					OD Gas	OD Liq.
TWA090A30RG	208-230/3/60	90,000	39	36	42	394	83	31.1	45	1 ³ / ₈	5 ⁵ / ₈
TWA120A30RG	208-230/3/60	120,000	45	40	52	509	90	42.6	60	1 ³ / ₈	1 ¹ / ₂
TWA090A40RG	460/3/60	90,000	39	36	42	394	83	15.2	25	1 ³ / ₈	5 ⁵ / ₈
TWA120A40RG	460/3/60	120,000	45	40	52	509	90	21.9	30	1 ³ / ₈	1 ¹ / ₂

Table LSH-2-B — TWA Split System Heat Pumps - Dual Compressors with Dual Refrigerant Circuits - R-22 Refrigerant

Model Number	Power Supply	Nom. Cap. Cooling (BTUH)	Uncrated Dimensions(in.)			Shipping Weight (lbs.)	Sound [Ⓢ] Rating	MCA*	Max. Fuse*	Line Size (in)	
			H	W	L					OD Gas	OD Liq.
TWA180B30RG	208-230/3/60	180,000	46	45	95	898	93	60.4	80	1 ³ / ₈	5 ⁵ / ₈
TWA240B30RG	208-230/3/60	240,000	46	45	95	981	94	77.7	100	1 ³ / ₈	1 ¹ / ₂
TWA180B40RG	460/3/60	180,000	46	45	95	898	93	29.5	40	1 ³ / ₈	5 ⁵ / ₈
TWA240B40RG	460/3/60	240,000	46	45	95	981	94	39.9	50	1 ³ / ₈	1 ¹ / ₂

Ⓢ Sound rating show is tested in accordance with AHRI Standard 270 or 370.

* Information subject to change. Please confirm with current Product Data/Service Facts for current factory production.

Light Commercial Split System Heat Pumps

Table LSH-3-A — R-410A Optional Accessories

Model Number	Description	Used With
Coil Guard		
BAYGARD058A	Hail/Vandal Guard	TWA 073D,090D
BAYGARD060A	Hail/Vandal Guard	TWA120D
BAYGARD061A	Hail/Vandal Guard	TWA180E,240E
Isolators		
BAYISLT005A	Rubber Isolator Floor (black)	TWA073D-TWA120D
BAYISLT009A	Rubber Isolator Floor (red)	TWA180E
BAYISLT010A	Rubber Isolator Floor (green)	TWA240E
BAYISLT023A	Steel Spring Isolator Floor (red)	TWA073D, TWA090D, TWA120D
BAYISLT024A	Steel Spring Isolator Floor (black)	TWA180E
BAYISLT025A	Steel Spring Isolator Floor (yellow)	TWA240E
Low Ambient		
BAYLOAMU01A ^{①②③}	On/Off Fan Control Mounted in External Enclosure (small cabinets)	TWA073D-090D (all voltages)
BAYLOAMU02A ^{②③}	On/Off Fan Control Mounted in Unit Control Box (large cabinets)	TWA120D-240E (all voltages)
BAYLOAM335A ^{③④}	Modulating ICM Head Pressure Control w/ 208-230V 0.5 HP Hi-Eff Motor (internal mount)	TWA073D, TWA090D3
BAYLOAM336A ^{③④}	Modulating ICM Head Pressure Control w/ 208-230V 1 HP Hi-Eff Motor (internal mount)	TWA120D3
BAYLOAM435A ^{③④}	Modulating ICM Head Pressure Control w/ 460V 0.5 HP Hi-Eff Motor (internal mount)	TWA073D4, TWA090D4
BAYLOAM436A ^{③④}	Modulating ICM Head Pressure Control w/ 460V 1.0 HP Hi-Eff Motor (internal mount)	TWA120D4
BAYLOAMW36A ^{③④}	Modulating ICM Head Pressure Control w/ 575V 1.0 HP Hi-Eff Motor (internal mount)	TWA120DW
BACnet™ Communications Interface		
BAYBCIR001A	BACnet (BCI-R) Communications Interface	All
Time Delay Relay		
BAYRLAY002	Time Delay Relay	TWA090D-TWA240E
BAYRLAY005	Heat Pump interlock relay	All TWA Units with BAYLOAM Application Requirements
Wire Kit		
BAYWRKT003A ^⑤	Heat Pump configuration wiring harness	TWA180E, TWA240E

① Kit mounts external to the outdoor unit and operates by sensing ambient and liquid line temperatures.

② Cycles fan on/off, (no modulating).

③ Quantity of 1 required for each fan (2 total for TTA/TWA180-240).

④ Heat pumps require BAYRLAY005 when modulating BAYLOAM kits are selected.

⑤ Used on Dual circuit HP condensers with a field installed LCI card for independent mechanical heating operation configuration.

Split System Heat Pumps Three Phase – 6-20 Tons

Table LSC-4-A — ReliaTel™ Control Options

Model Number	Description	Used With
ASYSTAT107A	Zone Sensor, Set Point Adj, Fan, System, EH, LED	TWA073-TWA240 with ReliaTel™ Controls
ASYSTAT109A	Zone Sensor, 2 Set Point Adj, Fan, System, EH, LED	TWA073-TWA240 with ReliaTel™ Controls
ASYSTAT777A	Digital Programmable Zone Sensor with Night Setback	TWA073-TWA240, TTA073-TTA240 with ReliaTel™ Controls
BAYSENS050 ^①	Wireless Zone Sensor	TWA073-TWA240 with ReliaTel™ Controls
BAYSENS073A	Room Sensor w/ Override and Cancel Button	TWA073-TWA240 with ReliaTel™ Controls
BAYSENS074A	Room Sensor w/ Temperature Adjustment and Override Button	TWA073-TWA240 with ReliaTel™ Controls
BAYSENS077A	Remote Sensor	ASYSTAT107A, ASYSTAT109A, ASYSTAT777A
BAYSENS110A	Dual Set Point w/ Manual/Auto Change Over	TWA073-TWA240 with ReliaTel™ Controls

Table LSC-4-B — Electromechanical Control Options

Model Number	Description	Used With
ASYSTAT092A	2H/2C Touch Screen Digital Display Programmable Thermostat "Touch Screen"	All
ASYSTAT093A	3H/2C Digital Display Programmable Thermostat W/Humidity Sensor	All

^① Kit comes with everything required for installation and operation.

6 - 20 Tons with ReliaTel™ Controls TWA073, TWA090, TWA120, TWA180, TWA240

Protection/Operation Timings and Features

Anti Short Cycle Timer (ASCT) Function — Provides a three (3) minute minimum “ON” time and a three (3) minute minimum “OFF” time for compressors, enhances compressor reliability by ensuring proper oil return. **Standard**

Built In Fan Delay Relay (FDR) Function — Provides custom indoor fan timing sequences for the different types of equipment, enhancing efficiency and reliability. **Standard**

Built In Night Set Back and Unoccupied Functions① — When using a standard dual setpoint/auto change over Zone Sensor Module (ZSM), this function is enabled by applying a short across terminal J6-11 and J6-12. Sets cooling setpoint up a minimum of 7°F, sets heating setpoint back a minimum of 7°F, and forces fan operation to automatic. **(requires time clock accessory or field supplied/installed switch or contacts).**

Built In “TEST” Mode — Aids in quick verification of system and control operation, exercises both hardware and software (no special tools required). **Standard**

Built In Unoccupied Mode① — When using a standard single setpoint/manual change over Zone Sensor Module (ZSM), this function is enabled by applying a short across terminal J6-11 and J6-12. Forces fan operation to automatic. **(requires time clock accessory or field supplied/installed switch or contacts.)**

Direct Digital Control (DDC)① — Proportional Integral (PI) control. Proportional – sets corrective action proportional to deviation from setpoint. Integral – fine tunes the rate of corrective action proportional to the error (results in superior space temperature control). **Standard**

Increased Reliability — Fewer components (moving electro-mechanical parts), less likelihood of equipment down time or failure. **Standard**

Integral Electric Heat Staging① — Stages electric heaters “OFF” and “ON”, eliminating the use of outdated sequencers. **Standard**

Intelligent Fallback① — A built in Default Control provides adaptive operation, which allows the equipment to continue to operate, providing comfort in the event of certain component failures. Also, allows emergency operation without a Zone Sensor Module (ZSM). **Standard**

Low Ambient Start Timer (LAST) Function — Bypasses low pressure control when a compressor starts, eliminating nuisance compressor lock outs. **Standard**

Lower Installation Cost — Using a standard Zone Sensor Module (ZSM), control voltage wiring may be run up to five (5) times further than any electromechanical system, with no increase in wire gauge. Example: Electromechanical System – 30 feet maximum using 22 gauge wire. Micro Control System – 150 feet using 22 gauge wire. **Standard**

On Board Diagnostics① — Assist with equipment troubleshooting, if a problem occurrence should take place. **Standard**

Remote Sensing① — All standard Zone Sensor Modules (ZSMs) have remote sensing capabilities, typically achieved by using an expensive program-mable thermostat and remote sensor with electromechanical equipment. **Accessory (requires use of remote sensor).**

Space Temperature Averaging① — All standard Zone Sensor Modules (ZSMs) have space temperature averaging capabilities, typically achieved by using an expensive programmable thermostat and minimum of four (4) remote sensors with electromechanical equipment. **Averaging with ReliaTel™ can be achieved with two (2) sensors.**

Time Delay Relay (TDR) Function — Provides an incremental staging delay between compressors, minimizes equipment current inrush and consumption by keeping compressors from starting simultaneously. **Standard**

Low Pressure and High Pressure Compressor Lockout — 3 trips will lockout control.

When the ReliaTel™ RTRM Thermostat Interface is used, equipment operation differs significantly. The basic equipment protection features remain intact, and the following features and benefits are lost:

- Direct Digital Control (DDC) – Proportional Integral (PI) control is lost, equipment is controlled by a thermostat or generic building automation system device.
- Intelligent Fall back is lost, if a failure occurs in the device controlling the equipment, operation will cease.
- Installation is more costly, with the addition of a thermostat or generic control, the control wiring size must be increased.
- Remote Sensing capabilities are lost, unless generic control being applied can accomplish this.
- Space Temperature Averaging capabilities are lost, unless generic control being applied can accomplish this.
- Built In Night Set Back and Unoccupied functions are lost, unless generic control being applied can accomplish this.
- Built In Unoccupied Mode is lost, unless generic control being applied can accomplish this.

Demand Defrost — Defrosts only if needed, not based on time like most other systems, optimizing and lowering operating costs.

① Denotes features lost from utilizing standard conventional stat.

Split System Air Handlers, R-410A

Single Phase – 5-10 Tons

Three Phase – 5-25 Tons

- Ships in horizontal configuration, but quickly and easily converts to upflow
- Expansion valve factory installed
- Check valves for heat pump applications
- Belt drive blower
- Factory installed motor, belt, sheaves, contactor, low voltage terminal board
- One inch filters on 5 to 10 ton units (rack convertible for field supplied two inch)
- Captive screws remain on the panels for service ease
- Low voltage terminal board
- Drain Pan

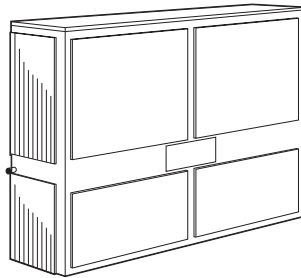

5, 7¹/₂, 10, 12¹/₂, 15, 20, 25 Ton TWE Convertible Air Handlers (Upflow or Horizontal Only)

- Factory Installed (EDC) Evaporator Defrost Control
- IAQ (Indoor Air Quality) sloped/free draining pan, no standing water
- Two inch filters factory installed on 12¹/₂, 15, 20, 25 ton units
- Supplemental heaters (electric, water, steam) fits directly on unit discharge for low installation cost
- Single point power entry for reduced electrical power installation cost
- Unit fully assembled to reduce field installation costs

- Compact design with low service clearance to reduce building requirements
- Brazed refrigerant piping connections
- Fan relay UL listed and CSA Certified
- Factory installed 2 speed variable frequency drive (VFD) option available for enhanced part load performance and minimum REQUIRED for CA Title 24 Compliance
- Factory installed Single Zone VAV (SZVAV) option available for enhanced part load performance and space temperature control via varying airflow
- **Optional extended warranties**

1 2 3 4 5 6 7 8 9 10 11 12
T W E 180 D 3 R 3 A A

Capacity
061 = 5 Tons 180 = 15 Tons
090 = 7.5 Tons 240 = 20 Tons
120 = 10 Tons 300 = 25 Tons
150 = 12.5 Tons

Factory-Installed Options
00 = Standard Motor - Electromechanical Controls
03 = 2 speed VFD Standard Motor - Electromechanical Controls
04 = 2 speed VFD Oversized Motor - Electromechanical Controls
R3 = SZVAV VFD Standard Motor - ReliaTel™ Controls
R4 = SZVAV VFD Oversized Motor - ReliaTel™ Controls

Table LAH-1-A — Single Circuit Coil - R-410A[Ⓢ]

Tons	Unit Model No.	Power Supply Volts/Phase/Hz	Capacity (Btuh)	FCCV	Drive Type	Dimensions (in.) ^④ H x W x D	Shipping Weight (lbs.)	MCA*	Max Fuse Size or Max Circuit Breaker ^{③*}
Single Phase									
5	TWE061D100AA	208-230/1/60	60,000	TXV	Belt	48 x 39 x 23	263	7.5	15
7 ¹ / ₂	TWE090D100AA ^①	208-230/1/60	90,000	TXV	Belt	54 x 49 x 26	360	8.5	15
10	TWE120D100AA ^①	208-230/1/60	120,000	TXV	Belt	54 x 65 x 26	429	10.6	15
Three Phase									
5	TWE061D300AA	208-230/3/60	60,000	TXV	Belt	48 x 39 x 23	263	3.1	15
5	TWE061D400AA	460/3/60	60,000	TXV	Belt	48 x 39 x 23	263	1.6	15
5	TWE061DW00AA	575/3/60	60,000	TXV	Belt	48 x 39 x 23	263	1.6	15
7 ¹ / ₂	TWE090D300AA ^{①②}	208-230/3/60	90,000	TXV	Belt	54 x 49 x 26	360	6.6	15
7 ¹ / ₂	TWE090DW00AA ^①	575/3/60	90,000	TXV	Belt	54 x 49 x 26	360	2.3	15
10	TWE120D300AA ^{①②}	208-230/3/60	120,000	TXV	Belt	54 x 65 x 26	429	7.8	15
10	TWE120DW00AA ^①	575/3/60	120,000	TXV	Belt	54 x 65 x 26	429	2.9	15

^① Control transformer not included. Order control transformer accessory when matching these air handlers with 3-5 ton condensing units.

^② Ships wired for 208-230/3/60. Field convertible to 460/3/60.

^③ HACR type circuit breaker per NEC.

^④ Dimensions based on Upflow position.

[Ⓢ] All air handlers are shipped with the drain pan installed in the horizontal position. For vertical configuration, the drain pan should be repositioned before setting the air handler.

* Information subject to change. Please confirm with current Product Data/Service Facts for current factory production.

Split System Air Handlers, R-410A

Single Phase – 5-10 Tons

Three Phase – 5-25 Tons

- Ships in horizontal configuration, but quickly and easily converts to upflow
- Expansion valve factory installed
- Check valves for heat pump applications
- Belt drive blower
- Factory installed motor, belt, sheaves, contactor, low voltage terminal board
- One inch filters on 5 to 10 ton units (rack convertible for field supplied two inch)
- Captive screws remain on the panels for service ease
- Low voltage terminal board
- Drain Pan

- Factory Installed (EDC) Evaporator Defrost Control
- IAQ (Indoor Air Quality) sloped/free draining pan, no standing water
- Two inch filters factory installed on 12½, 15, 20, 25 ton units
- Supplemental heaters (electric, water, steam) fits directly on unit discharge for low installation cost
- Single point power entry for reduced electrical power installation cost
- Unit fully assembled to reduce field installation costs

- Compact design with low service clearance to reduce building requirements
- Brazed refrigerant piping connections
- Fan relay UL listed and CSA Certified
- Factory installed 2 speed variable frequency drive (VFD) option available for enhanced part load performance and minimum REQUIRED for CA Title 24 Compliance®
- Factory installed Single Zone VAV (SZVAV) option available for enhanced part load performance and space temperature control via varying airflow®
- **Optional extended warranties**

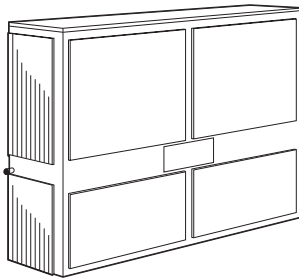

5, 7½, 10, 12½, 15, 20, 25 Ton TWE Convertible Air Handlers (Upflow or Horizontal Only)

1 2 3 456 7 8 9 10 11 12
T W E 180 D 3 R 3 A A

Capacity

061 = 5 Tons 180 = 15 Tons
090 = 7.5 Tons 240 = 20 Tons
120 = 10 Tons 300 = 25 Tons
150 = 12.5 Tons

Factory-Installed Options

00 = Standard Motor - Electromechanical Controls
03 = 2 speed VFD Standard Motor - Electromechanical Controls
04 = 2 speed VFD Oversized Motor - Electromechanical Controls
R3 = SZVAV VFD Standard Motor - ReliaTel™ Controls
R4 = SZVAV VFD Oversized Motor - ReliaTel™ Controls

Table LAH-2-A — Dual Circuit Coil — R-410A

Tons	Unit Model No.	Power Supply Volts/Phase/Hz	Capacity (Btuh)	FCCV	Drive Type	Dimensions (in.) ^④ H x W x D	Shipping Weight (lbs.)	MCA*	Max Fuse Size or Max Circuit Breaker ^③ *
Single Phase									
5	TWE061E100AA	208-230/1/60	60,000	TXV	Belt	48 x 39 x 23	263	7.5	15
7½	TWE090E100AA ^①	208-230/1/60	90,000	TXV	Belt	54 x 49 x 26	360	8.5	15
10	TWE120E100AA ^①	208-230/1/60	120,000	TXV	Belt	54 x 65 x 26	429	10.6	15
Three Phase									
5	TWE061E300AA	208-230/3/60	60,000	TXV	Belt	48 x 39 x 23	263	3.1	15
5	TWE061E400AA	460/3/60	60,000	TXV	Belt	48 x 39 x 23	263	1.6	15
7½	TWE090E300AA ^{①②}	208-230/3/60	90,000	TXV	Belt	54 x 49 x 26	360	6.6	15
10	TWE120E300AA ^{①②}	208-230/3/60	120,000	TXV	Belt	54 x 65 x 26	429	7.8	15
10	TWE120EW00AA ^①	575/3/60	120,000	TXV	Belt	54 x 65 x 26	429	2.9	15
12½	TWE150E300AA ^②	208-230/3/60	150,000	TXV	Belt	69 x 81 x 30	730	7.4	15
12½	TWE150EW00AA	575/3/60	150,000	TXV	Belt	69 x 81 x 30	730	2.8	15
15	TWE180E300AA ^②	208-230/3/60	180,000	TXV	Belt	69 x 81 x 30	729	11.8	20
15	TWE180EW00AA	575/3/60	180,000	TXV	Belt	69 x 81 x 30	729	4.3	15
20	TWE240E300BA	208-230/3/60	246,000	TXV	Belt	72 x 94 x 32	891	18.1	25
20	TWE240E400BA	460/3/60	246,000	TXV	Belt	72 x 94 x 32	891	8.4	15
20	TWE240EW00BA	575/3/60	246,000	TXV	Belt	72 x 94 x 32	891	6.5	15
25	TWE300E300A	208-230/3/60	292,000	TXV	Belt	72 x 94 x 32	972	24.5	30
25	TWE300E400A	460/3/60	292,000	TXV	Belt	72 x 94 x 32	972	11.2	20
25	TWE300EW00A	575/3/60	292,000	TXV	Belt	72 x 94 x 32	972	8.9	15

① Control transformer not included. Order control transformer accessory when matching these air handlers with 3-5 ton condensing units.

② Ships wired for 208-230/3/60. Field convertible to 460/3/60.

③ HACR type circuit breaker per NEC.

④ Dimensions based on Upflow position.

⑤ All air handlers are shipped with the drain pan installed in the horizontal position. For vertical configuration, the drain pan should be repositioned before setting the air handler.

⑥ 460V motors (digit 8=4) are only available on TWE150E and TWE180 when Title 24 or SZVAV is selected in digits 9 and 10.

* Information subject to change. Please confirm with current Product Data/Service Facts for current factory production.

Split System Air Handlers, R-410A

Single Phase – 5-10 Tons

Three Phase – 5-25 Tons

Table LAH-3-A — 6 - 10 Ton Electric Heater Selection

Model Number	Description	Used With
BAYHTRL106A	4.33/5.76 kW Heater 208/240/1 Phase	TWE061D1-TWE120E1
BAYHTRL112A	8.65/11.52 kW Heater 208/240/1 Phase	TWE061D1-TWE120E1
BAYHTRL117A	12.98/17.28 kW Heater 208/240/1 Phase	TWE061D1-TWE120E1
BAYHTRL123A	17.30/23.04 kW Heater 208/240/1 Phase	TWE061D1-TWE120E1
BAYHTRL129A	21.65/28.80 kW Heater 208/240/1 Phase	TWE061D1-TWE120E1
BAYHTRL305A	3.75/5.00 kW Heater 208/240/3 Phase	TWE061D3-TWE120E3
BAYHTRL310A	7.45/9.96 kW Heater 208/240/3 Phase	TWE061D3-TWE120E3
BAYHTRL315A	11.25/14.96 kW Heater 208/240/3 Phase	TWE061D3-TWE120E3
BAYHTRL325A	18.71/24.92 kW Heater 208/240/3 Phase	TWE061D3-TWE120E3
BAYHTRL335A	26.20/34.88 kW Heater 208/240/3 Phase	TWE061D3-TWE120E3
BAYHTRL405A	5.00 kW Heater 460/3 Phase	TWE061D4-TWE120E3①
BAYHTRL410A	9.96 kW Heater 460/3 Phase	TWE061D4-TWE120E3①
BAYHTRL415A	14.96 kW Heater 460/3 Phase	TWE061D4-TWE120E3①
BAYHTRL425A	24.92 kW Heater 460/3 Phase	TWE061D4-TWE120E3①
BAYHTRL435A	34.88 kW Heater 460/3 Phase	TWE061D4-TWE120E3①
BAYHTRLW05A	5 kW Heater 575/3 Phase	TWE061DW-TWE120EW
BAYHTRLW10A	9.96 kW Heater 575/3 Phase	TWE061DW-TWE120EW
BAYHTRLW15A	14.96 kW Heater 575/3 Phase	TWE061DW-TWE120EW
BAYHTRLW25A	24.92 kW Heater 575/3 Phase	TWE061DW-TWE120EW
BAYHTRLW35A	34.88 kW Heater 575/3 Phase	TWE061DW-TWE120EW

Table LAH-3-B — 12½ - 20 Ton Electric Heater Selection

Model Number	Description	Used With
BAYHTRM310A	7.50/10.0 kW Heater 208/230 3 Phase	TWE150E3-TWE300E3
BAYHTRM320A	14.96/19.92 kW Heater 208/230 3 Phase	TWE150E3-TWE300E3
BAYHTRM330A	22.50/29.92 kW Heater 208/230 3 Phase	TWE150E3-TWE300E3
BAYHTRM350A	37.42/49.84 kW Heater 208/230 3 Phase	TWE150E3-TWE300E3
BAYHTRM410A	10.0 kW Heater 460/3 Phase	TWE150E3①-TWE300E4
BAYHTRM420A	19.92 kW Heater 460/3 Phase	TWE150E3①-TWE300E4
BAYHTRM430A	29.92 kW Heater 460/3 Phase	TWE150E3①-TWE300E4
BAYHTRM450A	49.84 kW Heater 460/3 Phase	TWE150EW-TWE300EW
BAYHTRMW10A	10.0 kW Heater 575/3 Phase	TWE150EW-TWE300EW
BAYHTRMW20A	19.92 kW Heater 575/3 Phase	TWE150EW-TWE300EW
BAYHTRMW30A	29.92 kW Heater 575/3 Phase	TWE150EW-TWE300EW
BAYHTRMW50A	49.84 kW Heater 575/3 Phase	TWE150EW-TWE300EW

① Field convertible to 460/3/60.

Split System Air Handlers, R-410A

Single Phase – 5-10 Tons

Three Phase – 5-25 Tons

Table LAH-4-A — 5 – 20 Ton Accessory Selection

Model Number	Description	Used With
Subbase		
BAYBASE009A	Vertical Air Handler Subbase	TWE061D, TWE061E
BAYBASE010A	Vertical Air Handler Subbase	TWE090D, TWE090E
BAYBASE011A	Vertical Air Handler Subbase	TWE120D, TWE120E
BAYBASE012A	Vertical Air Handler Subbase	TWE150E, TWE180E
BAYBASE013A	Vertical Air Handler Subbase	TWE240E, TWE300E
Grille		
BAYGRLE001A	Return Air Grille	TWE061D/E
BAYGRLE002A	Return Air Grille	TWE090D/E
BAYGRLE003A	Return Air Grille	TWE120D/E
BAYGRLE004A	Return Air Grille	TWE150E, TWE180E
BAYGRLE005A	Return Air Grille	TWE240E, TWE300E
High Static Motor		
BAYHSMT104A	1.5HP (230/1) w/ 1VL44 motor sheave w/ AK54 fan sheave w/ A44 belt	TWE061D1/E1
BAYHSMT105A	1.5HP (230-460/3) w/ 1VL44 motor sheave w/ AK54 fan sheave w/ A44 belt	TWE061D3-4/E3-4
BAYHSMT106A	1.5HP (575/3) w/ 1VL44 motor sheave w/ AK54 fan sheave w/ A44 belt	TWE061DW/EW
BAYHSMT107A	2 HP (230/1) w/ 1VL44 motor sheave w/ AK66 fan sheave w/ A50 belt	TWE090D1/E1
BAYHSMT108A	2 HP (230/460/3) w/ 1VL44 motor sheave w/ AK66 fan sheave w/ A50 belt	TWE090D3/E3
BAYHSMT109A	2 HP (575/3) w/ 1VL44 motor sheave w/ AK66 fan sheave w/ A50 belt	TWE090DW/EW
BAYHSMT110A	3 HP (230/460/3) w/ 1VP44 motor sheave w/ AK54 fan sheave w/ AX48 belt	TWE090D3/E3
BAYHSMT111A	3 HP (575/3) w/ 1VP44 motor sheave w/ AK54 fan sheave w/ AX48 belt	TWE090DW/EW
BAYHSMT112A	3 HP (230/460/3) w/ 1VP44L motor sheave w/ AK74 fan sheave w/ A51 belt	TWE120D3/E3
BAYHSMT113A	3 HP (575/3) w/ 1VP44L motor sheave w/ AK74 fan sheave w/ A51 belt	TWE120DW/EW
BAYHSMT114A	3 HP (230/460/3) w/ 1VP44L motor sheave w/ BK72 fan sheave w/ A51 belt	TWE150E3
BAYHSMT115A	3 HP (575/3) w/ 1VP44L motor sheave w/ BK72 fan sheave w/ A51 belt	TWE150EW
BAYHSMT116A	5 HP (230/3) w/ 1VP50L motor sheave w/ BK72 fan sheave w/ BX55 belt	TWE150E3
BAYHSMT117A	5 HP (460/3) w/ 1VP50L motor sheave w/ BK72 fan sheave w/ BX55 belt	TWE150E4
BAYHSMT118A	5 HP (575/3) w/ 1VP50L motor sheave w/ BK72 fan sheave w/ BX55 belt	TWE150EW
BAYHSMT119A	5 HP (230/3) w/ 1VP50L motor sheave w/ BK85 fan sheave w/ BX58 belt	TWE180E3
BAYHSMT120A	5 HP (460/3) w/ 1VP50L motor sheave w/ BK85 fan sheave w/ BX58 belt	TWE180E4
BAYHSMT121A	5 HP (575/3) w/ 1VP50L motor sheave w/ BK85 fan sheave w/ BX58 belt	TWE180EW
BAYHSMT122A	7.5 HP (230/460/3) w/ 1VP60 motor sheave w/ BK90 fan sheave w/ BX60 belt	TWE240E3/4
BAYHSMT123A	7.5 HP (575/3) w/ 1VP60 motor sheave w/ BK90 fan sheave w/ BX60 belt	TWE240EW
Isolators		
BAYISLT004A①②③④	Rubber Isolator Floor (blue)	TWE061D-TWE120E
BAYISLT009A①②③	Rubber Isolator Floor (red)	TWE150E, TWE180E
BAYISLT010A①②③	Rubber Isolator Floor (green)	TWE240E, TWE300E
BAYISLT012B③	Rubber Isolator Suspended (red/green)	TWE150E, TWE180E
BAYISLT013B③④	Rubber Suspended (red/green)	TWE061D/E
BAYISLT014A③④	Rubber Suspended (green)	TWE090D/E
BAYISLT015B③④	Rubber Suspended (green/black)	TWE120D/E
BAYISLT016B③	Rubber Suspended (red/green)	TWE240E, TWE300E
BAYISLT019A①②③	Steel Spring Isolator Floor (red)	TWE061D/E, TWE090D/E, TWE120D/E
BAYISLT021A①②③	Steel Spring Isolator Floor (black)	TWE150E, TWE180E
BAYISLT032A①②③	Steel Spring Isolator Floor (black/yellow)	TWE240E
BAYISLT028A③	Steel Spring Isolator Suspended (tan)	TWE061D/E
BAYISLT029A③	Steel Spring Isolator Suspended (red)	TWE090D/E, TWE120D/E
BAYISLT030A③	Steel Spring Isolator Suspended (black)	TWE150E, TWE180E
BAYISLT031B③	Steel Spring Isolator Suspended (black/yellow)	TWE240E, TWE300E
Low Static Drive Kit		
BAYLSMT001A	Low Static Drive Kit	TWE240E

① When the Air handler is in the vertical position and close proximity trapping of condensate is required, use of subbase is required.

② Requires use of subbase accessory.

③ Units having steam of hot water coils applied vertically or horizontally check IOM for proper Isolator kit selection.

④ Do not use if blower will operate less than 600 RPM.

Split System Air Handlers, R-410A

Single Phase – 5-10 Tons

Three Phase – 5-25 Tons

Table LAH-5-A — 5 – 20 Ton Accessory Selection

Model Number	Description	Used With
Plenum		
BAYPLNM015B ^②	Discharge Plenum & Grille	TWE061D/E
BAYPLNM016B ^②	Discharge Plenum & Grille	TWE090D/E
BAYPLNM017B ^②	Discharge Plenum & Grille	TWE120D/E
BAYPLNM018B ^②	Discharge Plenum/Hydronic Coil Plenum & Grille	TWE150E, TWE180E
BAYPLNM019B ^②	Discharge Plenum/Hydronic Coil Plenum & Grille	TWE240E, TWE300E
BAYPLNM020B ^②	Hydronic Coil Discharge Plenum & Grille	TWE061D/E
BAYPLNM021B ^②	Hydronic Coil Discharge Plenum & Grille	TWE090D/E
BAYPLNM022B ^②	Hydronic Coil Discharge Plenum & Grille	TWE120D/E
BAYPLNM030A ^②	Electric Heat Discharge Plenum & Grille	TWE061D/E
BAYPLNM031A ^②	Electric Heat Discharge Plenum & Grille	TWE090D/E
BAYPLNM032A ^②	Electric Heat Discharge Plenum & Grille	TWE120D/E
BAYPLNM033A ^②	Electric Heat Discharge Plenum & Grille	TWE150E, TWE180E
BAYPLNM034A ^②	Electric Heat Discharge Plenum & Grille	TWE240E, TWE300E
Transformer		
BAYTFMR011A ^①	75va transformer (230V)	TWE090D3, TWE090E3, TWE120D3, TWE120E3
BAYTFMR012A ^①	75va transformer	TWE090D4/W, TWE090E4/W, TWE120D4/W, TWE120E4/W
BAYTFMR013A ^①		TWE090DK, TWE090EK, TWE120DK, TWE120EK
Water Kits		
BAYWATR022A ^②	Steam Coil Enclosure	TWE061D/E
BAYWATR023A ^②		TWE090D/E
BAYWATR024A ^②		TWE120D/E
BAYWATR025A ^②		TWE150E, TWE180E
BAYWATR026A ^②		TWE240E, TWE300E
BAYWATR027A ^②	Hot Water Coil Enclosure	TWE061D/E
BAYWATR028A ^②		TWE090D/E
BAYWATR029A ^②		TWE120D/E
BAYWATR030A ^②		TWE150E, TWE180E
BAYWATR031A ^②		TWE240E, TWE300E
Wire Kit		
BAYWRKT002A ^③	180 Blower Discharge Reversal Kit	TWE061D-TWE120E

① Required when 6 -10 Ton Air Handlers are matched with 3-5 Ton condensing units.

② When installed horizontally, plenum/water coil must be self supported.

③ Cannot be used on TWE150-240, due to motor mount location.

Split System Air Handlers 5-25 Tons

Factory Supplied Accessories

- (A) Air Handler (TWE 5 – 20 Tons)
- (B) Outdoor Condensing Unit (TTA – Cooling 6 – 25 Tons)
(TWA – Heat Pump 6 – 20 Tons)
- (P) Discharge Plenum and Grille (BAYPLNM)
- (EH) Electric Heater and Casing (BAYHTRL)
Fits on Top of Unit (13 H x 30 W x 17 D)
- (SB) Subbase (BAYBASE)
- (I) Isolators (BAYISLT)
- (RG) Return Grille (BAYGRLE)
- (CG) Coil Guards (BAYLOAM)
- (WC) Steam/Hot Water Coil (BAYWATR)

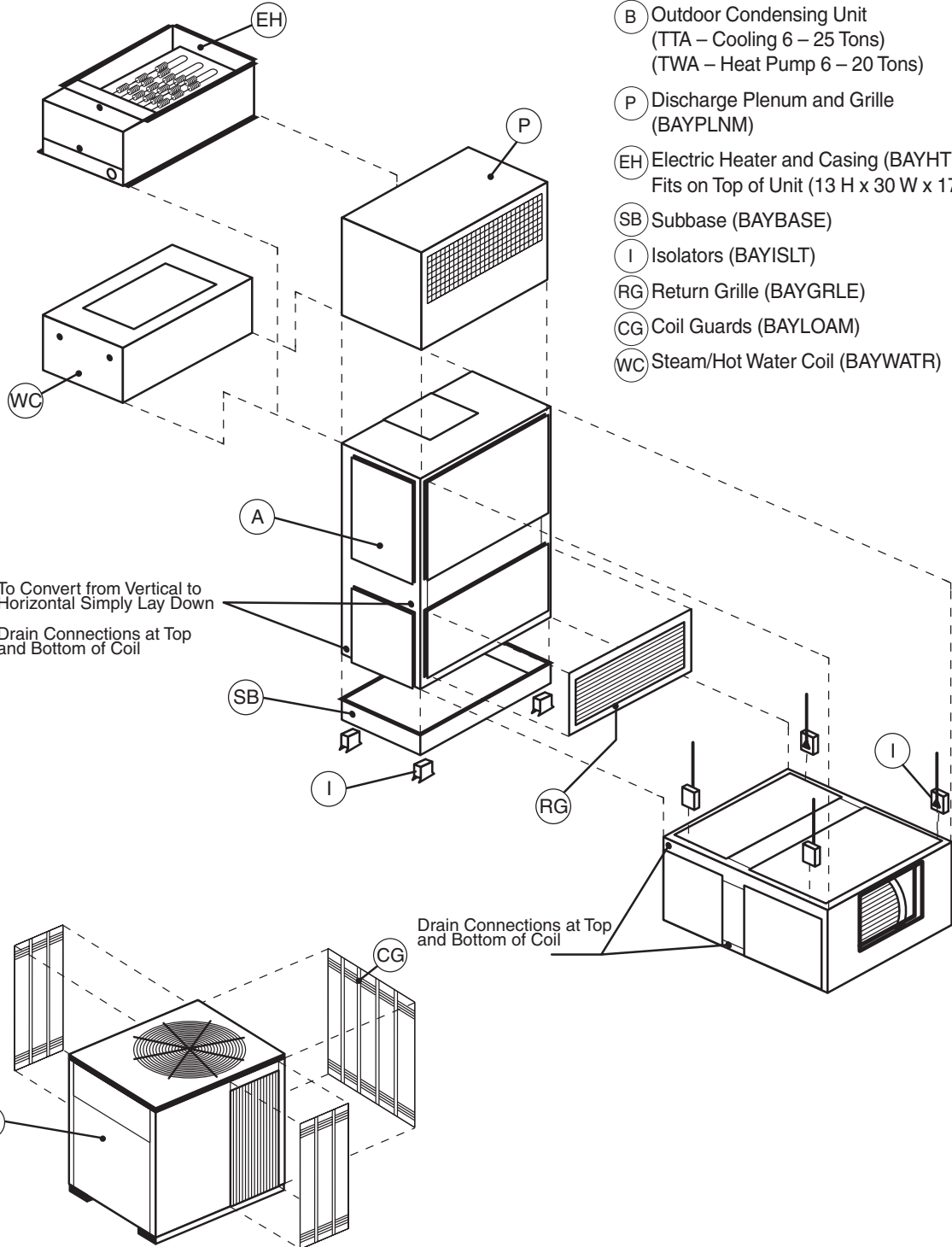

Light Commercial
Air Handlers/Heaters

Non-Programmable Comfort Controls for ReliaTel™ Units



ASYSSTAT095A

ASYSSTAT095A

- One-touch temperature control.
- Large, clear, backlit display is easy to read, even in the dark.
- Displays both room temperature and temperature setting.
- Removable battery holder for fast, easy replacement.
- Built-in compressor protection.
- **Focus Pro 3 Heat/ 2 Cool**

SELECTED OUT

Programmable Comfort Controls for ReliaTel™ Units



ASYSSTAT090A

ASYSSTAT090A

- Large, Clear Display with Backlighting — Current temperature, set temperature and time are easy-to-read and all are displayed on the main screen.
- Menu Driven Programming — Provides guidance through the scheduling process, showing only necessary information and choices on each screen.
- Ability to Select Multiple Days — Allows easy customizing for unique schedules.
- Real-Time Clock—Keeps time during power failure; automatically updates for daylight saving time.
- Armchair Programming — Can remove thermostat from wall to set the schedule.
- Precise Temperature Control (± 1 °F) — reliable, consistent comfort.
- Multiple OVERRIDE options — Can modify schedule for a specific period of time (up to 365 days).
- Outdoor Temperature Indication — Displays current outdoor temperature to help plan outdoor activities.
- **2 Heat/2 Cool**

SELECTED OUT

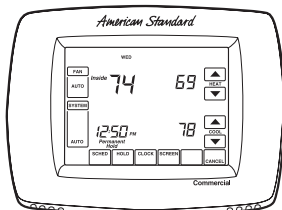

ASYSSTAT092A

ASYSSTAT092A

- Large, Clear Display with Backlighting — Current temperature, set temperature and time are easy-to-read and all are displayed on the main screen.
- Menu Driven Programming — Provides guidance through the scheduling process, showing only necessary information and choices on each screen.
- Ability to Select Multiple Days — Allows easy customizing for unique schedules.
- Real-Time Clock — Keeps time during power failure; automatically updates for daylight savings.
- Armchair Programming — Can remove thermostat from wall to set the schedule. Precise Temperature Control (± 1 °F) — reliable, consistent comfort.
- Multiple OVERRIDE options — Can modify schedule indefinitely or for a specific period of time.
- Programmable Fan — Increases indoor air quality when combined with air cleaning equipment.
- Outdoor Temperature Indication — Displays current outdoor temperature to help plan outdoor activities.
- **2 Heat/2 Cool Commercial Vision Pro**

SELECTED OUT

Programmable Comfort Controls for ReliaTel™ Units



ASYSTAT800A

ASYSTAT800A

- Wall mounted remote space sensor
- For use with ASYSTAT090A, ASYSTAT092A, and ASYSTAT093A programmable thermostats

Zone Sensor Unit Installation

The zone sensor provides the operator control and zone temperature sensing functions for use with electronic unit controls. Refer to the appropriate unit installation manual for interconnecting wiring instructions.

ZONE SENSOR LOCATION

To ensure proper operation, select a location on an interior wall, at a height approximately 5 feet above the floor, with freely circulating air of average temperature.

Avoid Locations:

- Behind doors or in corners where air does not freely circulate.
- On an outside wall or any wall with unheated (uncooled) areas behind the zone sensor.
- Where direct sunlight or any Source: of radiant heat could affect the temperature measurements.
- In line with the discharge air from the unit being controlled.

Mount the zone sensor base on the wall or optional mounting plate with the wires routed through the wire access hole in the base of the zone sensor.

ZONE SENSOR CONTROLS

Emergency Heat/Heat/Auto/Off/Cool

This switch determines whether the unit operates in emergency heat (EM. HEAT - for heat pumps only), heating (HEAT), automatically changing from heating to cooling as required (AUTO), heating and cooling functions disabled (OFF), or cooling (COOL).

Fan Auto/Fan On

This switch determines whether the indoor fan operates during cooling and heating cycles only (FAN AUTO) or runs continuously (FAN ON).

Temperature Adjustments

One or two temperature adjustment controls are provided to set the desired temperature or temperature range (for unit mode AUTO). If two controls are present, the blue control sets the desired temperature for cooling and the red control sets the desired temperature for heating.

Temperature Indicator

This indicates the temperature in the zone. The indicator has been factory calibrated and should not normally require adjustment. If adjustment is needed, it can be accomplished by slowly rotating a small screwdriver in the slot on the back of the indicator until the correct temperature is obtained.

Optional Remote Sensor

When using the optional remote sensor (BAYSENS077A), it should be located in the space that is to be controlled. Wire according to the interconnecting wiring diagrams in the unit IOM.

Installation: 18-HD60D41

Source: Clarksville

Micro Control Zone Sensors



ASYSSTAT106A
Manual Changeover

- 4 wires required.
- Single Setpoint for 3-25 Tons Electric/Electric and Gas/Electric Systems
- Can be used with Remote Sensor (ASYSSTAT669)



ASYSSTAT107A
Manual Changeover

- 4-6 wires required.
- Single Setpoint for W- Heat Pump Systems (3-20 Tons)
- Can be used with Remote Sensor (ASYSSTAT669)



ASYSSTAT108A
Automatic Changeover

- 5 wires required.
- Dual Setpoint for Electric/Electric and Gas Electric Systems (3-25 Tons)
- Can be used with Remote Sensor (ASYSSTAT669)



ASYSSTAT109A
Automatic Changeover

- 5-7 wires required.
- Dual Setpoint for W- Heat Pump Systems (3-20 Tons)
- Can be used with Remote Sensor (ASYSSTAT669)



ASYSSTAT709A/707A
LCD Digital Display Zone Sensor

- 3-7 wires required.
- Non-Programmable Zone Sensor with a digital display
- ASYSSTAT709A - Cool/Gas
- ASYSSTAT707A - Heat Pumps

Zone Sensors must be used with Micro Control units. Vendor Thermostats which use Triac outputs are not recommended with Micro Control units. Major features lost by using a Conventional Thermostat include the following:

- No diagnostics
- Proportional Integral control
- No smart recovery in the heating mode (heat pumps)
- 2-stage electric heat (heat pumps)
- Stand alone set up and set back for unoccupied features
- Intelligent fall back (unit can run on default value with outdoor air sensor)
- Control wiring size may be increased
- Remote sensing capability
- Space temperature averaging
- Supply air tempering
- Economizer preferred cooling is lost (compressor operation is locked out below 50°F)

For complete equipment / combination selections, installation instructions and warranty information, please refer to Product Data/Ratings and/or Installers Guides and Limited Warranty Handbooks.

Electronic Programmable Zone Sensors For ReliaTel™ Units



ASYSSTAT777A

- **Automatic or Manual Changeover with System Lights**
- Use With:
 - 3 – 10 Ton Precedent™ Units
 - 12.5 – 25 Ton Voyager™ Units
- Digital display indicating the time of day, the day of the week, room temperature, current program operating mode, and current active stage
- Continuous or 3 hour timed override
- Two occupied, two unoccupied programs per day
- L.C.D. readout in F or C (Celsius) and 12 or 24-hour clock
- Keyboard disable to prevent tampering
- Programming on a 7-day basis
- Status indication lights displayed in Digital Display
- Auxiliary relay (Form 1C)
- Auto Fan During Setback
- No Anticipator Required
- No Battery Required
- No accessories required. Each unit is complete and ready for installation
- Remote Room Sensor (ASYSSTAT669)
- Finish: Pantone Cool Gray #2C
- Replacement: SEN-0415
- Installation: 18-HD60D29
- Source: Clarksville

Integrated Comfort™ Systems Sensors For ReliaTel™ Units



ASYSSTAT669

- **Room Sensor**
- Used with Integrated Comfort™ Systems
- Used With:
 - 3 - 10 Ton Precedent™ Units
 - 12.5 - 25 Ton Voyager™ Units
- Finish: Pantone Cool Gray #2C
- Replacement: SEN01448
- Installation: Included with sensor
- Source: St. Paul GCC/Clarksville

Packaged Cooling Convertible 3-10 Tons



Beveled Top
Smoother Design
Small compact cabinet
Recessed access handles

Standard Features:

- American Standard Heating & Air Conditioning scroll compressors on all 3-10 ton units
- Colored and numbered wiring
- Phase Monitor, R-410A 3 Phase Units
- Provisions for through the Base Condensate Drain Connections
- 2" throwaway filters provided on all ton units
- Liquid Line Refrigerant Drier
- Operating Charge of R-410A
- IAQ Sloped Drain Pans
- Single point power for Electric Heat
- Low Ambient to 40°F on Electromechanical models
- Low Ambient to 0°F on ReliaTel™ models
- 5 - year Limited Compressor Warranty
- 1 - year Limited Parts Warranty

Added Flexibility

- Electromechanical or ReliaTel™ controls (**See page LPC-13 for ReliaTel™ Control Information**)
- Standard or high efficiency cooling models available. 17+ available in 3T to 5T. For reference to 17+ please refer to publications RT-PRC048-EN and RT-SLB020-EN
- Convertible airflow (ships in downflow application)
- Fork lift openings on three sides of unit
- Direct or belt drive - standard or oversized motors (Direct for 3-5 ton only)
- We don't prepackage options
- Choose options tailored to suit each job —pay only for what is needed
- Units ship with options installed —and within our standard ship cycle time

Factory Installed Options

- Through-the-Base — Electrical
- Convenience Outlet — Powered or unpowered
- Unit Disconnect Switch
- Smoke Detectors — Supply, return, or both
- Condenser Coil Coating
- Hinged Access Service Panels
- Discharge Air Sensor
- Fan Fail and Clogged Filter Switches
- Condenser Coil Guard — Hail Protection Quality
- Dehumidification Hot Gas Reheat Coil
- Froststat
- Novar Controls
- Comm 3/4 Communications Interface
- 2" Pleated Media filters
- 2" MERV 8 filters or 2" MERV 13 filters
- Multi-Speed & Single Zone VAV ID Airflow
- Demand Control Ventilation
- Stainless Steel Drainpan
- Condensate Drainpan Overflow Switch

The same American Standard Heating & Air Conditioning Quality and Reliability ... with added Flexibility!

Packaged Cooling Convertible 3-5 Tons, R-410A

Table LPC-2-A — 17 Plus - R-410A - ReliaTel™ Controls Only

Tons	Unit Ordering No.	Performance SEER/EER	Cooling Capacity (Btuh)	Cabinet Dimensions (in.) H x W x L	Downflow Supply	Downflow Return	Shipping Weight (lbs.)	MCA**	Max Fuse**
THC - 208-230/3/60 - Three Phase - No Heat									
3	THC037E3R0A0000	17.5	36,500	36 x 44 x 69	18 x 15.5	24 x 14	614	23.3	30
4	THC047E3R0A0000	17.5	50,500	41 x 53 x 88	33 x 17.5	33 x 17.5	787	29.4	40
5	THC067E3R0A0000	17.2	60,000	41 x 53 x 88	33 x 17.5	33 x 17.5	841	32.2	45
THC - 460/3/60 - Three Phase - No Heat									
3	THC037E4R0A0000	17.5	36,500	36 x 44 x 69	18 x 15.5	24 x 14	614	11.4	15
4	THC047E4R0A0000	17.5	50,500	41 x 53 x 88	33 x 17.5	33 x 17.5	787	13.7	20
5	THC067E4R0A0000	17.2	60,000	41 x 53 x 88	33 x 17.5	33 x 17.5	841	15.2	20

Table PC-2-B — Base Unit — 15 SEER High Efficiency — R-410A — Electromechanical or ReliaTel™

Tons	Unit Ordering No.	Performance ^② SEER/EER	Cooling Capacity (Btuh)	Cabinet Dimensions (in.) H x W x L	Downflow Supply	Downflow Return	Shipping Weight (lbs.)	MCA**	Max ^① Fuse**
THC - 208-230/1/60 - Single Phase - No Heat									
3	THC036E1*0A0000	15.2	38,490	36 x 44 x 69	16 x 15.5	24 x 14	555	26.7	40
4	THC048F1*0A0000	15.0	48,930	41 x 53 x 88	33 x 17.5	32.2 x 17.5	798	35.7	50
5	THC060F1*0A0000	15.0	62,480	41 x 53 x 88	33 x 17.5	32.2 x 17.5	823	43.8	70
THC - 208/3/60 - Three Phase - No Heat									
3	THC036E3*0A0000	15.0	38,490	36 x 44 x 69	16 x 15.5	24 x 14	555	21.9	30
4	THC048F3*0A0000	15.0	49,930	41 x 53 x 88	33 x 17.5	32.2 x 17.5	637	28.3	40
5	THC060F3*0A0000	15.0	63,490	41 x 53 x 88	33 x 17.5	32.2 x 17.5	869	32.1	45
THC - 460/3/60 - Three Phase - No Heat									
3	THC036E4*0A0000	15.0	38,490	36 x 44 x 69	16 x 15.5	24 x 14	555	10.2	15
4	THC048F4*0A0000	15.0	49,830	41 x 53 x 88	33 x 17.5	32.2 x 17.5	637	13.8	20
5	THC060F4*0A0000	15.0	63,480	41 x 53 x 88	33 x 17.5	32.2 x 17.5	869	17.0	25

Table LPC-2-C — Base Unit — Standard Efficiency — R-410A — Electromechanical or ReliaTel™

Tons	Unit Ordering No.	Performance SEER/EER	Cooling Capacity (Btuh)	Cabinet Dimensions (in.) H x W x L	Downflow Supply	Downflow Return	Shipping Weight (lbs.)	MCA**	Max Fuse**
TSC - 208-230/1/60 - Single Phase - No Heat									
3	TSC036E1*0A0000	13.0	35,620	36 x 43 x 69	16 x 15.5	24 x 14	555	27.2	40
4	TSC048F1*0A0000	13.0	49,210	36 x 43 x 69	16 x 15.5	24 x 14	586	35.2	50
5	TSC060F1*0A0000	13.0	59,900	36 x 43 x 69	16 x 15.5	24 x 14	636	43.8	70
TSC - 208-230/3/60 - Three Phase - No Heat									
3	TSC036E3*0A0000	13.0	37,150	36 x 43 x 69	16 x 15.5	24 x 14	555	23.0	35
4	TSC048F3*0A0000	13.0	49,450	36 x 43 x 69	16 x 15.5	24 x 14	586	25.2	35
5	TSC060F3*0A0000	13.0	62,270	36 x 43 x 69	16 x 15.5	24 x 14	636	29.5	45
TSC - 460/3/60 - Three Phase - No Heat									
3	TSC036E4*0A0000	13.0	37,150	36 x 43 x 69	16 x 15.5	24 x 14	555	11.7	15
4	TSC048F4*0A0000	13.0	49,450	36 x 43 x 69	16 x 15.5	24 x 14	586	12.5	15
5	TSC060F4*0A0000	13.0	62,270	36 x 43 x 69	16 x 15.5	24 x 14	636	15.5	25
TSC - 575/3/60 - Three Phase - No Heat									
3	TSC036EW*0A0000	13.0	37,150	36 x 43 x 69	16 x 15.5	24 x 14	555	9.4	15
4	TSC048FW*0A0000	13.0	49,450	36 x 43 x 69	16 x 15.5	24 x 14	586	9.0	15
5	TSC060FW*0A0000	13.0	62,270	36 x 43 x 69	16 x 15.5	24 x 14	636	10.1	15

① HACR breaker per NEC.

② SEER applies, 3-5 tons; EER applies 6-10 tons.

* Digit 9 - E = Electromechanical or R = ReliaTel™.

** Information subject to change. Please confirm with current Product Data/Service Facts for current factory production.

Packaged Cooling Convertible 6 - 10 Tons, R-410A

Table LPC-3-A — Base Unit — High Efficiency — R-410A — Electromechanical or ReliaTel™

Tons	Unit Ordering No.	Performance EER	Cooling Capacity (Btuh)	Cabinet Dimensions (in.) H x W x L	Downflow Supply	Downflow Return	Shipping Weight (lbs.)	MCA**	Max [Ⓛ] Fuse**
THC – 208-230/3/60 – Three Phase High Efficiency									
6	THC072F3*0A0000	12.6	72,000	47 x 53 x 88	33 x 17.5	32.13 x 17.5	997	33.9	50
7½	THC092F3*0A0000	12.6	92,000	47 x 53 x 88	33 x 17.5	32.13 x 17.5	1026	41.9	50
8½	THC102F3*0A0000	12.5	103,000	47 x 53 x 88	33 x 17.5	32.13 x 17.5	1026	42	50
10	THC120E3*0A0000	12.5	119,000	51 x 63 x 100	32.25 x 19.25	32.25 x 16.75	1563	50.3	60
THC – 460/3/60 – Three Phase									
6	THC072F4*0A0000	12.6	72,000	47 x 53 x 88	33 x 17.5	32.13 x 17.5	997	16.3	25
7½	THC092F4*0A0000	12.6	92,000	47 x 53 x 88	33 x 17.5	32.13 x 17.5	1026	19.9	25
8½	THC102F4*0A0000	12.5	103,000	47 x 53 x 88	33 x 17.5	32.13 x 17.5	1026	19.9	25
10	THC120E4*0A0000	12.5	119,000	51 x 63 x 100	32.25 x 19.25	32.25 x 16.75	1563	24.9	30

Table LPC-3-B — Base Unit — Standard Efficiency — R-410A — Electromechanical or ReliaTel™

Tons	Unit Ordering No.	Performance SEER/EER	Cooling Capacity (Btuh)	Cabinet Dimensions (in.) H x W x L	Downflow Supply	Downflow Return	Shipping Weight (lbs.)	MCA**	Max Fuse**
TSC – 208-230/3/60 – Three Phase – No Heat									
6	TSC072F3*0A0000	11.2	75,000	42 x 53 x 88	33 x 17.5	32.13 x 17.5	898	36.5	50
7½	TSC090F3*0A0000	11.2	89,000	42 x 53 x 88	33 x 17.5	32.13 x 17.5	815	38.2	60
7½	TSC092F3*0A0000	11.2	94,000	46 x 53 x 88	33 x 17.5	32.13 x 17.5	1009	41.2	50
8½	TSC102F3*0A0000	11.2	102,000	46 x 53 x 88	33 x 17.5	32.13 x 17.5	1048	46.3	60
10	TSC120F3*0A0000	11.3	119,000	46 x 53 x 88	33 x 17.5	32.13 x 17.5	1058	49.6	60
TSC – 460/3/60 – Three Phase – No Heat									
6	TSC072F4*0A0000	11.2	75,000	42 x 53 x 88	33 x 17.5	32.13 x 17.5	898	18.2	25
7½	TSC090F4*0A0000	11.2	89,000	42 x 53 x 88	33 x 17.5	32.13 x 17.5	815	19.5	30
7½	TSC092F4*0A0000	11.2	94,000	46 x 53 x 88	33 x 17.5	32.13 x 17.5	1009	21.5	25
8½	TSC102F4*0A0000	11.2	102,000	46 x 53 x 88	33 x 17.5	32.13 x 17.5	1048	21.9	25
10	TSC120F4*0A0000	11.3	119,000	46 x 53 x 88	33 x 17.5	32.13 x 17.5	1058	22.7	35
TSC – 575/3/60 – Three Phase – No Heat									
6	TSC072FW*0A0000	11.2	75,000	42 x 53 x 88	33 x 17.5	32.13 x 17.5	898	12.7	20
7½	TSC090FW*0A0000	11.2	89,000	42 x 53 x 88	33 x 17.5	32.13 x 17.5	815	14.7	20
7½	TSC092FW*0A0000	11.2	94,000	46 x 53 x 88	33 x 17.5	32.13 x 17.5	1009	15.0	20
8½	TSC102FW*0A0000	11.2	102,000	46 x 53 x 88	33 x 17.5	32.13 x 17.5	1048	17.5	20
10	TSC120FW*0A0000	11.3	119,000	46 x 53 x 88	33 x 17.5	32.13 x 17.5	1058	18.9	25

Ⓛ HACR breaker per NEC.

* Digit 9-E=Electromechanical or R=ReliaTel™.

** Information subject to change. Please confirm with current Product Data/Service Facts for current factory production.

Packaged Cooling Convertible 3-10 Tons (Model Digit Numbers)

Digit	Description	Order Number	Digit	Description	Order Number
1-8	Main Assembly (see previous page)		21	Communications Options ^②	
9	Unit Controls			No Communications Interface	0
	Electro-Mechanical	E		Comm 3/4 Communications Interface	1
	ReliaTel™ Micro-processor	R		Novar 2024 Controls	3
10	(See Heater Table below)			Novar 3051 Controls	4
11	Minor Design Sequence			Novar 3051 Controls Interface with DCV	5
	First Sequence	A		BACnet™ Communications Interface	6
12-13	Service Sequence		22	Refrigeration System Option	
	First Sequence (Factory Supplied)	*,*		Standard Refrigeration System	0
14	Fresh Air Selection			Dehumidification (Hot Gas Reheat Coil) ^⑳	B
	No Fresh Air	0	23	Refrigeration Controls	
	0-50% Manual Outside Air Damper ^⑩	A		Note: Applicable to Digit 7 = E,F	
	0-50% Motorized Outside Air Damper	B		No Refrigeration Control	0
	0-100% Economizer, Dry Bulb without Barometric Relief ^②	C		Froststat ^④	1
	0-100% Economizer, Dry Bulb with Barometric Relief ^②	D		Crankcase Heater	2
	0-100% Economizer, Reference Enthalpy without Barometric Relief ^{①②}	E		Froststat and Crankcase Heater	3
	0-100% Economizer, Reference Enthalpy with Barometric Relief ^{①②}	F	24	Smoke Detector ^{⑤⑦}	
	0-100% Economizer, Comparative Enthalpy without Barometric Relief ^{①②}	G		No Smoke Detector	0
	0-100% Economizer, Comparative Enthalpy with Barometric Relief ^{①②}	H		Return Air Smoke Detector ^{⑥⑦}	A
15	Supply Fan/Drive Type/Motor			Supply Air Smoke Detector	B
	Standard Drive	0		Supply and Return Air Smoke Detectors ^{⑥⑦}	C
	Oversized Motor	1		Plenum Smoke Detector	D
	Optional Belt Drive Motor (3 phase only)	2	25	Monitoring Controls ^②	
	Single Zone VAV	6		No Monitoring Control ^③	0
	Multi-Speed Indoor Fan	7		Clogged Filter Switch ^⑧	1
	VAV Supply Air Temperature Control Standard Motor ..	E		Fan Failure Switch ^③	2
16	Hinged Service Access & Filters			Discharge Air Sensing Tube ^③	3
	Standard Panels & Filters	0		Clogged Filter Switch and Fan Fail Switch ^⑧	4
	Hinged Access Panels & Standard Filters	A		Clogged Filter Switch and Discharge Air Sensing Tube ^⑧	5
	Standard Panels & 2" Pleated Filters MERV 8	B		Fan Fail Switch and Discharge Air Sensing Tube ^⑧	6
	Hinged Access Panels & 2" Pleated Filters MERV 8	C		Clogged Filter and Fan Fail Switches and Discharge Air Sensing Tube ^⑧	7
	Standard Panels/2" MERV 13 Filters	D		Novar Return Air Sensor ^⑨	8
	Hinged Access Panels/2" MERV 13 Filters	E		Novar 3051 Zone Sensor ^⑨	9
17	Condenser Coil Protection			Condensate Drain Pan Overflow Switch	A
	Standard Coil	0		Clogged Filter Switch ^⑧ and Condensate Drain Pan Overflow Switch	B
	Standard Coil with Hail Guard	1		Fan Failure Switch ^③ and Condensate Drain Pan Overflow Switch	C
	Black Epoxy Pre-Coated Condenser Coil	2		Discharge Air Sensing ^③ and Condensate Drain Pan Overflow Switch	D
	Black Epoxy Pre-Coated Condenser Coil with Hail Guard	3		Clogged Filter Switch ^⑧ , Fan Failure Switch ^③ and Condensate Drain Pan Overflow Switch	E
	Complete Coat™ Condenser Coil	4		Clogged Filter Switch ^⑧ , Discharge Air Sensing Tube ^③ and Condensate Drain Pan Overflow Switch	F
	Complete Coat™ Condenser Coil with Hail Guard	5		Fan Failure Switch, Discharge Air Sensing Tube ^③ and Condensate Drain Pan Overflow Switch	G
18	Through the Base Provisions			Clogged Filter Switch ^⑧ , Fan Failure Switch ^③ , Discharge Air Sensing ^③ and Condensate Drain Pan Overflow Switch	H
	No Through the Base Provisions	0	26	System Monitoring Controls	
	Through the Base Electric ^⑪	A		No Monitoring Controls	0
19	Disconnect/Circuit Breaker /Phase Monitor (3 phase only)			Demand Control Ventilation (CO ₂) ^{⑭⑮}	A
	No Disconnect/ Circuit Breaker	0	27	Unit Hardware Enhancements	
	Unit Mounted Non-Fused Disconnect ^⑩	1		No Enhancements	0
	Unit Mounted Circuit Breaker ^⑩	2		Stainless Steel Drain Pan	1
20	Convenience Outlet				
	No Convenience Outlet	0			
	Unpowered Convenience Outlet	A			
	Powered Convenience Outlet (3 phase only) ^③	B			

① Enthalpy control not available factory installed with electro-mechanical controls.
 ② Economizer with Barometric Relief is for downflow configured units only. Order Economizer without Barometric Relief for horizontal configuration. Barometric relief for horizontal configured units must be ordered as field installed accessory BAYBARM010A.
 ③ Requires use of Disconnect or Circuit Breaker.
 ④ Froststat cannot be field installed in electro-mechanical units.
 ⑤ Not available with BAYFRST001A High Temperature Stat accessory.
 ⑥ The return air smoke detector may not fit up or work properly on the Convertible units when used in conjunction with 3rd party accessories such as bolt on heat wheels, economizers and power exhaust. Do not order the return air smoke detectors when using this type of accessory.
 ⑦ Return Air Smoke Detector cannot be ordered with Novar Controls.
 ⑧ These options are standard when ordering Novar Controls.
 ⑨ This options for use when ordering Novar Control only.
 ⑩ The manual outside air damper will ship factory supplied within the unit, but must be field installed.
 ⑪ Through the base electric required when ordering disconnect/circuit breaker options.
 ⑫ Not available with electro-mechanical unit controls.
 ⑬ Novar Sensor utilized with digit 21 = (4) Novar 3051 Controls without Zone Sensor.
 ⑭ Available for T/Y 10 ton standard efficiency models only.

⑮ Available for T/Y 3, 4, 5, 6, 7½, 8½ ton standard/high efficiency models only.
 ⑯ Requires selection of 2" Pleated Filters (option B or C) for Digit 16.
 ⑰ Not available on 6 ton units and all single phase or standard efficiency.
 ⑱ Standard on T/YSC 6, 7½ (single and dual systems), 8½, 10 ton standard efficiency models and T/YHC 4, 5, 6, 7½ ton high efficiency models (except for dehumidification models).
 ⑲ Epoxy coil and epoxy with hailguard options are not available for units with microchannel condenser coil.
 ⑳ Single Zone VAV is only available on 7.5-10 ton high efficiency and 10 ton standard efficiency products with ReliaTel™ controls.
 ㉑ Multi-speed indoor fan available only on 7.5 & 8.5 ton high efficiency, and 10 ton products with ReliaTel™ controls.
 ㉒ Motorized Outside Air Damper is not available on Multi-Speed or SZVAV (Single Zone Variable Air Volume) products.
 ㉓ Froststat standard on Multi-Speed and SZVAV (Single Zone Variable Air Volume) products.
 ㉔ Novar is not available with SZVAV products.
 ㉕ Demand Control Ventilation not available with electromechanical controls.
 ㉖ Demand Control Ventilation Option includes wiring only. The CO₂ sensor is a field-installed only option.
 ㉗ When ordering Dehumidification option, Digit #7 will revert back to E, not F.

Packaged Cooling Convertible 3-10 Tons (Model Digit Numbers)

Heaters (Digit 10)

kW Rating	Digit	Nominal BTUH	No. Stages	Used With	kW Rating	Digit	Nominal BTUH	No. Stages	Used With
208/240/1/60					460/3/60				
3.7/5.0	(A)	12,800/17,100	1	T*C036-060*1	6.0	(B)	20,500	1	T*C036-060*4
7.5/10.0	(D)	25,600/34,100	2	T*C036-060*1	12.0	(E)	41,000	2	T*C036-060*4
10.3/13.8	(F)	35,300/47,100	2	T*C036-060*1	17.6	(G)	59,400	2	T*C036-060*4
13.2/17.6	(G)	45,100/60,100	2	T*C048-060*1	23.0	(J)	78,500	2	T*C060*4
208/240/3/60					9.0	(C)	30,700	1	T*C072-102*4
4.5/6.0	(B)	13,400/20,500	1	T*C036-060*3	18.0	(G)	61,400	1	T*C072-120*4
9.0/12.0	(E)	30,800/59,400	2	T*C036-060*3	27.0	(K)	92,100	2	T*C072-120*4
13.2/17.6	(G)	44,600/59,400	2	T*C036-060*3	36.0	(N)	122,900	2	T*C072-120*4
17.2/23.0	(J)	58,900/78,500	2	T*C060*3	54.0	(P)	184,300	2	T*C120*4
6.75/9.0	(C)	23,000/30,700	1	T*C072-102*3	575/3/60				
13.5/18.0	(G)	46,100/61,400	1	T*C072-120*3	6.0	(B)	20,500	1	T*C036-060*W
20.3/27.0	(K)	69,000/92,100	2	T*C072-120*3	12.0	(E)	41,000	2	T*C036-060*W
27.0/36.0	(N)	92,200/122,900	2	T*C072-120*3	17.6	(G)	59,400	2	T*C036-060*W
40.5/54.0	(P)	138,200/184,300	2	T*C120*3	23.0	(J)	78,500	2	T*C060*W
					9.0	(C)	30,700	1	T*C072-102*W
					18.0	(G)	61,400	1	T*C072-120*W
					27.0	(K)	92,100	2	T*C072-120*W
					36.0	(N)	122,900	2	T*C072-120*W
					54.0	(P)	184,300	2	T*C120*W

Packaged Cooling Convertible 3-10 Tons, R-410A Electric Heaters

Table LPC-6-A — Accessory Electric Heaters – Unit with heater is single circuit / single point power entry

Model Number	Power Supply	kW Rating	Nominal BTUH	No. Stages	Used With
BAYHTRE105A	208-230/1/60	3.8/5.0	12,900/13,400	1	T*C036E1,TSC048-060E1
BAYHTRE110A	208-230/1/60	7.5/10.0	25,600/34,000	2	T*C036E1,TSC048-060E1
BAYHTRE114A	208-230/1/60	10.4/13.8	35,000/47,100	2	T*C036E1,TSC048-060E1
BAYHTRE118A	208-230/1/60	13.2/17.6	45,100/60,100	2	TSC048-060E1
BAYHTRE306B	208-230/3/60	4.5/6.0	13,400/20,500	1	T*C036E3,TSC048-060E3, THC037E3
BAYHTRE312B	208-230/3/60	9.0/12.0	30,800/41,000	2	T*C036E3,TSC048-060E3, THC037E3
BAYHTRE318B	208-230/3/60	13.0/17.4	44,600/59,400	2	T*C036E3,TSC048-060E3, THC037E3
BAYHTRE323B	208-230/3/60	17.3/23.0	44,600/59,400	2	TSC060E3
BAYHTRE406B	460/3/60	6.0	20,500	1	T*C036E4,TSC048-060E4, THC037E4
BAYHTRE412B	460/3/60	12.0	41,000	2	T*C036E4,TSC048-060E4, THC037E4
BAYHTRE418B	460/3/60	17.4	59,400	2	T*C036E4,TSC048-060E4, THC037E4
BAYHTRE423B	460/3/60	17.3/23.0	59,400	2	TSC060E4
BAYHTREW06B	575/3/60	6.0	20,500	1	T*C036EW,TSC048-060EW
BAYHTREW12B	575/3/60	12.0	41,000	2	T*C036EW,TSC048-060EW
BAYHTREW18B	575/3/60	17.4	59,400	2	T*C036EW,TSC048-060EW
BAYHTREW23B	575/3/60	17.3/23.0	59,400	2	TSC060EW
BAYHTRX105A	208-230/1/60	3.8/5.0	12,900/13,400	1	THC048-060F1
BAYHTRX110A	208-230/1/60	7.5/10.0	25,600/34,000	2	THC048-060F1
BAYHTRX114A	208-230/1/60	10.4/13.8	35,000/47,100	2	THC048-060F1
BAYHTRX118A	208-230/1/60	13.2/17.6	45,100/60,100	2	THC048-060F1
BAYHTRX306B	208-230/1/60	4.5/6.0	13,400/20,500	1	THC048-060F3, THC047E3, THC067E3
BAYHTRX312B	208-230/3/60	9.0/12.0	30,800/41,000	2	THC048-060F3, THC047E3, THC067E3
BAYHTRX318B	208-230/3/60	13.0/17.4	44,600/59,400	2	THC048-060F3, THC047E3, THC067E3
BAYHTRX323B	208-230/3/60	17.3/23.0	59,000/78,500	2	THC060F3
BAYHTRX406B	460/3/60	6.0	20,500	1	THC048-060F4, THC047E4, THC067E4
BAYHTRX412B	460/3/60	12.0	41,000	2	THC048-060F4, THC047E4, THC067E4
BAYHTRX418B	460/3/60	18.0	59,400	2	THC048-060F4, THC047E4, THC067E4
BAYHTRX423B	460/3/60	23.0	78,500	2	THC060F4, THC067E4

Packaged Cooling Convertible 6-10 Tons, R-410A Electric Heaters

Table LPC-7-A — Accessory Electric Heaters – Unit with heater is single circuit / single point power entry

Model Number	Power Supply	kW Rating	Nominal BTUH	No. Stages	Used With
BAYHTRS309B	208-230/3/60	6.75/9.0	23,000/30,700	1	TSC072F3
BAYHTRS318B	208-230/3/60	13.5/18.0	46,100/61,400	2	TSC072F3
BAYHTRS327B	208-230/3/60	20.3/27.0	69,000/92,100	2	TSC072F3
BAYHTRS336B	208-230/3/60	27.0/36.0	92,200/122,900	2	TSC072F3
BAYHTRW309A	208-230/3/60	6.75/9.0	23,000/30,700	1	TSC090F3
BAYHTRW318A	208-230/3/60	13.5/18.0	46,100/61,400	1	TSC090F3
BAYHTRW327A	208-230/3/60	20.3/27.0	69,000/92,100	2	TSC090F3
BAYHTRW336A	208-230/3/60	27.0/36.0	92,200/122,900	2	TSC090F3
BAYHTRT309B	208-230/3/60	6.75/9.0	23,000/30,700	1	TSC092F3, TSC102F3
BAYHTRT318B	208-230/3/60	13.5/18.0	46,100/61,400	2	TSC092F3, TSC102F3
BAYHTRT327B	208-230/3/60	20.3/27.0	69,000/92,100	2	TSC092F3, TSC102F3
BAYHTRT336B	208-230/3/60	27.0/36.0	92,200/122,900	2	TSC092F3, TSC102F3
BAYHTRA318A	208-230/3/60	13.5/18	46,100/61,400	1	TSC120F3
BAYHTRA327A	208-230/3/60	20.3/27	69,000/92,100	2	TSC120F3
BAYHTRA336A	208-230/3/60	27/36	92,200/122,900	2	TSC120F3
BAYHTRA354A	208-230/3/60	40.5/54	138,200/184,300	2	TSC120F3
BAYHTRS409B	460/3/60	9.0	30,700	1	TSC072F4
BAYHTRS418B	460/3/60	18.0	61,400	2	TSC072F4
BAYHTRS427B	460/3/60	27.0	92,100	2	TSC072F4
BAYHTRS436B	460/3/60	36.0	122,900	2	TSC072F4
BAYHTRW409A	460/3/60	9	30,700	1	TSC090F4
BAYHTRW418A	460/3/60	18	61,400	1	TSC090F4
BAYHTRW427A	460/3/60	27	92,100	2	TSC090F4
BAYHTRW436A	460/3/60	36	122,900	2	TSC090F4
BAYHTRT409B	460/3/60	9.0	30,700	1	TSC092F4, TSC102F4
BAYHTRT418B	460/3/60	18.0	61,400	2	TSC092F4, TSC102F4
BAYHTRT427B	460/3/60	27.0	92,100	2	TSC092F4, TSC102F4
BAYHTRT436B	460/3/60	36.0	122,900	2	TSC092F4, TSC102F4
BAYHTRA418A	460/3/60	18	61,400	1	TSC120F4**B
BAYHTRA427A	460/3/60	27	92,100	2	TSC120F4**B
BAYHTRA436A	460/3/60	36	122,900	2	TSC120F4**B
BAYHTRA454A	460/3/60	54	184,300	2	TSC120F4**B

Packaged Cooling Convertible 6-10 Tons, R-410A Electric Heaters

Table LPC-8-A — Accessory Electric Heaters – Unit with heater is single circuit / single point power entry

Model Number	Power Supply	kW Rating	Nominal BTUH	No. Stages	Used With
BAYHTRSW09B	575/3/60	9.0	30,700	1	TSC072FW
BAYHTRSW18B	575/3/60	18.0	61,400	2	TSC072FW
BAYHTRSW27B	575/3/60	27.0	92,100	2	TSC072FW
BAYHTRSW36B	575/3/60	36.0	122,900	2	TSC072FW
BAYHTRWW18A	575/3/60	18	61,400	1	TSC090FW
BAYHTRWW27A	575/3/60	27	92,100	2	TSC090FW
BAYHTRWW36A	575/3/60	36	122,900	2	TSC090FW
BAYHTRTW18B	575/3/60	18.0	61,400	2	TSC092FW, TSC102FW
BAYHTRTW27B	575/3/60	27.0	92,100	2	TSC092FW, TSC102FW
BAYHTRTW36B	575/3/60	36.0	122,900	2	TSC092FW, TSC102FW
BAYHTRAW18A	575/3/60	18	61,400	1	TSC120FW
BAYHTRAW36A	575/3/60	36	122,900	2	TSC120FW
BAYHTRAW54A	575/3/60	54	184,300	2	TSC120FW
BAYHTRU309A	208-230/3/60	6.8/9.0	23,000/30,700	1	THC072F3
BAYHTRU318A	208-230/3/60	13.5/18.0	46,100/61,400	1	THC072F3
BAYHTRU327A	208-230/3/60	20.3/27.0	69,000/92,100	2	THC072F3
BAYHTRU336A	208-230/3/60	27.0/36.0	92,100/122,900	2	THC072F3

Packaged Cooling Convertible 6-10 Tons, High Efficiency R-410A Electric Heaters

Table LPC-9-A — Accessory Electric Heaters – Unit with heater is single circuit / single point power entry

Model Number	Power Supply	kW Rating	Nominal BTUH	No. Stages	Used With
BAYHTRA309A	208-230/3/60	9.0	30,700	1	THC092F3, THC102F3
BAYHTRA318A	208-230/3/60	18.0	61,400	1	THC092F3, THC102F3
BAYHTRA327A	208-230/3/60	27.0	92,100	2	THC092F3, THC102F3
BAYHTRA336A	208-230/3/60	36.0	122,900	2	THC092F3, THC102F3
BAYHTRA409A	460/3/60	9.0	30,700	1	THC092F4, THC102F4
BAYHTRA418A	460/3/60	18.0	61,400	1	THC092F4, THC102F4
BAYHTRA427A	460/3/60	27.0	92,100	2	THC092F4, THC102F4
BAYHTRA436A	460/3/60	36.0	122,900	2	THC092F4, THC102F4
BAYHTRD318A	208-230/3/60	13.5/18.0	46,100/61,400	1	THC120E3
BAYHTRD327A	208-230/3/60	20.3/27.0	69,000/92,100	2	THC120E3
BAYHTRD336A	208-230/3/60	27.0/36.0	92,100/122,900	2	THC120E3
BAYHTRD354A	208-230/3/60	40.6/54.0	138,000/184,300	2	THC120E3
BAYHTRU409A	460/3/60	9.0	30,700	1	THC072F4
BAYHTRU418A	460/3/60	18.0	61,400	1	THC072F4
BAYHTRU427A	460/3/60	27.0	92,100	2	THC072F4
BAYHTRU436A	460/3/60	36.0	122,900	2	THC072F4
BAYHTRD418A	460/3/60	18.0	61,400	1	THC120E4
BAYHTRD427A	460/3/60	27.0	92,100	2	THC120E4
BAYHTRD436A	460/3/60	36.0	122,900	2	THC120E4
BAYHTRD454A	460/3/60	54.0	184,300	2	THC120E4

Packaged Cooling Convertible 3-10 Tons Accessories

Table LPC-10-A — Accessories

Model Number	Description	Used With
BAYABRD001C.....	ReliaTel™ Options Module.....	All T*036-120* (ReliaTel™) See Note⑤
BAYASCT001⑥⑦*	Anti-Short-Cycle Timer.....	All T*036-120* (Electro Mechanical)
BAYBARM010A④	Barometric Relief	THC036-060*, THC036E
BAYBARM011A④	Barometric Relief	TSC072-102*, THC092F, TSC120F, THC048*-120*
BAYBCIR001A.....	Bacnet™ Communication Interface	ReliaTel™ Controller (BCI-R)
BAYCCHT010B	Crankcase Heater	TSC036-048*1, 3
BAYCCHT011B	Crankcase Heater	TSC036-048*4, W
BAYCCHT017A	Crankcase Heater	TSC060F1, 3
BAYCCHT018A	Crankcase Heater	TSC060F4, EW
ASYSTAT712B③③	CO ₂ Sensor Kit, Wall Mounted.....	All T*036-120* (ReliaTel™)
ASYSTAT714B③③	CO ₂ Sensor Kit, Duct Mounted.....	All T*036-120* (ReliaTel™)
BAYCURB042A②	Roof Curb.....	THC036E, TSC036*-060*
BAYCURB043A②	Roof Curb.....	THC048F-072F, TSC072-102F, THC092F, TSC120F, THC102
BAYCURB044A	Roof Curb.....	THC120
BAYDFPS003B③⑤	Clogged Filter Switch	All T*036-120* (ReliaTel™)
BAYDFPS004A③⑤	Fan Failure Switch.....	All T*036-120* (ReliaTel™)
BAYDFPS014A	Clogged Filter Switch (w/MERV 13 Filter).....	All T*036-120* (ReliaTel™)
BAYDMPR053B⑨	0-50% Manual Outside Air Damper	THC036E, TSC036*-060*
BAYDMPR056B⑨	0-50% Manual Outside Air Damper	THC048*-120*, TSC072-102*, TSC120F
BAYDMPR051A③	0-50% Motorized Outside Air Damper	THC036E_R, TSC036-060*_R (ReliaTel™)
BAYDMPR052A⑥	0-50% Motorized Outside Air Damper	THC036E_E, TSC036E-060*_E (Electro Mechanical)
BAYDMPR054A③	0-50% Motorized Outside Air Damper	THC048-120*_R, TSC072-120F_R (ReliaTel™)
BAYDMPR055A⑥	0-50% Motorized Outside Air Damper	THC048-120*_E, TSC072-120F_E (Electro Mechanical)
BAYECON085A③	0-100% Dry Bulb Economizer without Barometric Relief ...	THC036E_R, TSC036*-060*_R (ReliaTel™)
BAYECON086A⑥	0-100% Dry Bulb Economizer without Barometric Relief ...	THC036E_E, TSC036E-060*_E (Electro Mechanical)
BAYECON087A③	0-100% Dry Bulb Economizer without Barometric Relief ...	THC048-120*_R, TSC072*-120*_R (ReliaTel™)
BAYECON088A⑥	0-100% Dry Bulb Economizer without Barometric Relief ...	THC048-120*_E, TSC072*-120*_E (Electro Mechanical)
BAYENTH005A①③	Reference Enthalpy Kit.....	BAYECON085A, 087A
BAYENTH006B①③	Comparative Enthalpy Kit.....	BAYECON085A, 087A
BAYENTH001A.....	Enthalpy Control (Solid State).....	BAYECON0086A, 088A
BAYFRST003A③④	High Temperature Stat	All T*036-120E

- ① Kits contain all necessary parts to achieve desired level of enthalpy control.
- ② Lynn Haven Manufacturing has a No-Return policy for this roof curb.
- ③ For use with ReliaTel™ controlled units only.
- ④ Barometric Relief accessory installs in ductwork for horizontal configuration. For downflow configuration, installs in the unit's horizontal return duct. See Installer's Guide for complete instructions.
- ⑤ BAYABRD001C is required when ordering field installed accessories Clogged Filter Switch (BAYDFPS003A), Fan Fail Switch (BAYDFPS004A), Discharge Air Sensing Kit (BAYTUBE004A) or Evaporator Defrost Control (Frostat) (BAYLOAM020B) Ventilation Override Kit (BAYVNOR001B) unless the following options are factory installed: Frostat, Smoke Detector, Clogged Filter Switch, Fan Failure Switch, Discharge Air Sensing Kit. These factory installed options include the ReliaTel™ Options Module.
- ⑥ For use with electromechanical controlled units only.
- ⑦ Activated on Power On.
- ⑧ Field installed accessory requires economizer.
- ⑨ The manual outside air damper will ship factory supplied within the unit, but must be field installed.

Table LPC-11-A — Accessories

Model Number	Description	Used With
BAYGARD037B	Condenser Coil Hail Guard	TSC036-060*, THC036E
BAYGARD040A	Condenser Coil Hail Guard	THC048-060F, TSC072F-090F
BAYGARD041A	Condenser Coil Hail Guard	TSC102, THC102, THC072
BAYGARD070A	Condenser Coil Hail Guard	TSC092, THC120E
BAYGARD141A	Condenser Coil Hail Guard	TSC120F, THC092F
BAYHSDR012A	High Static Drive Kit	THC072F
BAYHSMT082A	2 HP Oversized Motor Kit (208-230/460V)	TSC072F3, 4
BAYHSMT083A	2 HP Oversized Motor Kit (575V)	TSC072FW
BAYHSMT086A	3 HP Oversized Motor Kit (208-230/460V)	TSC090F-102F3, 4
BAYHSMT087A	3 HP Oversized Motor Kit (575V)	TSC090F-102FW
BAYHSMT402A	2 HP Oversized Motor Kit	THC072F3, 4
BAYKSKT255B	Start Kit	TSC036*1-060*1
BAYLMSW001A ^⑩	Power Exhaust Limit Switch	All T*036-120*, R
BAYLOAM020B ^{①③④}	Evaporator Defrost Control (Frostat)	All T*036-120*, R (ReliaTel™)
BAYLSDR006B	Low Static Drive Kit: 3-5T High Efficiency	THC036*-060*
BAYLSDR009A	Low Static Drive Kit	TSC092-102*, THC072*
BAYPWRX026A ^⑥	Power Exhaust (208-230/3 VAC)	TSC072-102F3, TSC120F3, THC072F3, THC092F3, THC102F3, THC120E3
BAYPWRX027A ^⑥	Power Exhaust (460/3 VAC)	TSC072-102F4, TSC120F4, THC072F4, THC092F4, THC102F4, THC120E4
BAYPWRX028A ^⑥	Power Exhaust (575/3 VAC)	TSC072-102FW, TSC120FW
BAYPWRX070A ^⑥	Power Exhaust (208-230/3 VAC)	TSC036-060*3, TCH036-THC060*3, THC037*3, THC047E3, THC067E3
BAYPWRX071A ^⑥	Power Exhaust (460/3 VAC)	TSC036-060*4, TCH036-THC060*4, THC037E4, THC047E4, THC067E4
BAYPWRX072A ^⑥	Power Exhaust (575/3 VAC)	TSC036-060*W
BAYQACB009A ^{②⑤}	Quick Adapt Roof Curb	TSC036-060E, THC036E, THC037E
BAYQACB010A ^{②⑤}	Quick Adapt Roof Curb	TSC036-060E, THC036E, THC037E
BAYQACB011A ^{②⑦}	Quick Adapt Roof Curb	TSC072-102F, TSC120F, THC048-072F, THC047E, THC067E
BAYQACB012A ^{②⑦}	Quick Adapt Roof Curb	TSC072-102F, TSC120F, THC048-072F, THC047E, THC067E
BAYQACB013A ^{②⑦}	Quick Adapt Roof Curb	TSC072-102F, TSC120F, THC048-072F, THC047E, THC067E
BAYRTEM001A ^⑩	Fully Featured ReliaTel™ Economizer Logic Model	All T*036-120*, R
BAYSTAT023 ^③	Remote Potentiometer	All T*036-120*, R
BAYSERV001A ^③	Selective Resistance Service Tester	All T*036-120*, R
BAYSENS016A ^③	Temperature Sensor	All T*036-120*, R
BAYSENS250A ^{③⑩}	CO ₂ Duct Mounted, Sensor Only	All T*036-120*, R (ReliaTel™)
BAYSENS251A ^{③⑩}	CO ₂ Wall Mounted, Sensor Only	All T*036-120*, R (ReliaTel™)
BAYTUBE005A	Discharge Air Sensing Kit	TSC036-060*R, THC036-037E*R
BAYTUBE007A	Discharge Air Sensing Kit	TSC072-102F*R, THC047E-072E*R
BAYTUBE401A	Discharge Air Sensing Kit	TSC120F*R, THC092F*R
BAYTUBE403A	Discharge Air Sensing Kit	TSC102-120F*R
BAYVNOR001B ^{③④⑨}	Ventilation Override Kit w/ReliaTel™ options module	All T*036-120*, R

- ① For ReliaTel™ microprocessor controlled units only. Must be factory installed for electromechanical controlled units.
- ② Lynn Haven Manufacturing has a No-Return policy for this roof curb.
- ③ For use with ReliaTel™ controlled units only.
- ④ BAYABRD001C is required when ordering field installed accessories Clogged Filter Switch (BAYDFPS003A), Fan Fail Switch (BAYDFPS004A), Discharge Air Sensing Kit (BAYTUBE004A) or Evaporator Defrost Control (Frostat) (BAYLOAM020B) Ventilation Override Kit (BAYVNOR001B) unless the following options are factory installed: Frostat, Smoke Detector, Clogged Filter Switch, Fan Failure Switch, Discharge Air Sensing Kit. These factory installed options include the ReliaTel™ Options Module.
- ⑤ BAYQACB009A adapts YCD units BAYCURB021B to accept T°C-5 ton unit. BAYQACB010A adapts YCD units BAYCURB022B to accept T°C unit.
- ⑥ Cannot be used in conjunction with Barometric Relief. Order Economizer without Barometric Relief.
- ⑦ BAYQACB012A adapts YCD units BAYCURB025A to accept T°C 6-10 ton unit. BAYQACB013A adapts YCD units BAYCURB026A to accept T°C 6-10 ton unit.
- ⑧ Interface allows a unit with ReliaTel™ Controls to communicate with Tracer 100, Tracker, VariTrac II, and is the preferred method of communication to Tracer Summit.
- ⑨ Field installed accessory requires economizer.
- ⑩ When ordering a field installed power exhaust on a unit with electromechanical controls, BAYLMSW001A must be ordered.
- ⑪ If any version of comparative or reference enthalpy is ordered, BAYRTEM001A does not need to be ordered.
- ⑫ Order only when unit has factory installed Demand Control Ventilation option.

For complete equipment / combination selections, installation instructions and warranty information, please refer to Product Data/Ratings and/or Installers Guides and Limited Warranty Handbooks.

Packaged Cooling Convertible 3-10 Tons, R-410A Zone Sensors / Thermostats

Table LPC-12-A — Zone Sensors for ReliaTel™ Controlled Units

Model Number	Description	Used With
ASYSTAT106A	Single Setpoint Manual Changeover	T*C036-120*R
ASYSTAT107A	Single Setpoint	T*C036-120*, R
ASYSTAT108A	Dual Setpoint Manual or Auto Changeover	T*C036-120*R
ASYSTAT109A	Dual Setpoint Changeover Sensor	T*C036-120*, R
ASYSTAT111A	Remote Room Sensor	
ASYSTAT777A	Programmable Night Setback w/System Function Lights (Vertical Style)	T*C036-120*R
ASYSTAT708A	Programmable Night Setback w/System Function Lights	T*C036-120*R
ASYSTAT710A	Wall Mounted Humidity Sensor	T*C036,120A,3,4,W-R,T*C036-120*_R
ASYSTAT711A	Duct Mounted Humidity Sensor	T*C036-120*,T*C036-120*_R
BAYMTPL110A	Retrofit Wall Cover Plate Kit 7.25" x 6.0"	ASYSTAT111A

*Either standard or high efficiency models.

Table LPC-12-B — Thermostats — Electromechanical

Model Number	Description	Used With
ASYSTAT712B	CO2 Sensor Kit (Wall Mounted)	T*C036-120*R
ASYSTAT714B	CO2 Sensor Kit (Duct Mounted)	T*C036-120*R

Alternating Lead/Lag – Dual Compressor Models Only —

During periods of part load operation, each compressor cycles alternately as circuit number one, equalizing compressor wear and run time. Enabled by cutting the wire (BLUE) at (RTRM) junction number J3-8. **Standard**

Anti Short Cycle Timer (ASCT) Function — Provides a three (3) minute minimum “ON” time and a three (3) minute minimum “OFF” time for compressors, enhances compressor reliability by ensuring proper oil return. **Standard**

Built In Evaporator Defrost Control (EDC) Function — Provides low ambient cooling down to 0°F. **Standard**

Built In Fan Delay Relay (FDR) Function — Provides custom indoor fan timing sequences for the different types of equipment, enhancing efficiency and reliability. **Standard**

Built In Night Set Back and Unoccupied Functions① — When using a standard dual setpoint/auto change over Zone Sensor Module (ZSM), this function is enabled by applying a short across terminal J6-11 and J6-12. Sets cooling setpoint up a minimum of 7°F, sets heating setpoint back a minimum of 7°F, forces outside air damper (if present) minimum position to zero, and forces fan operation to automatic. **Accessory (requires time clock accessory or field supplied/installed switch or contacts).**

Built In “TEST” Mode — Aids in quick verification of system and control operation, exercises both hardware and software (no special tools required). **Standard**

Built In Unoccupied Mode① — When using a standard single setpoint/manual change over Zone Sensor Module (ZSM), this function is enabled by applying a short across terminal J6-11 and J6-12. Forces outside air damper (if present) minimum position to zero, forces fan operation to automatic. **Accessory (requires time clock accessory or field supplied/installed switch or contacts).**

Direct Digital Control (DDC)① — Proportional Integral (PI) control. Proportional – sets corrective action proportional to deviation from setpoint. Integral – fine tunes the rate of corrective action proportional to the error (results in superior space temperature control). **Standard**

Economizer Preferred Cooling① — Provides fully integrated operation if required. Will not turn on a compressor with the economizer, if the space is recovering adequately with the economizer alone (0.2°F/minute). Allows the equipment to be utilized in more varied applications. **Standard with economizer accessory.**

Emergency Stop Terminals On Low Voltage Terminal Board (LTB-5 and LTB-6) — Provides a convenient point to disable the equipment completely, and immediately. Still provides communication to BAS. **Standard**

Heat Pump Smart Recovery and Smart Staging① — Inhibits auxiliary heat operation if the space is recovering adequately (0.1°F/minute) with the heat pump alone, providing considerable savings in operating costs. **Standard**

Heat Pump Soft Start — Provides a smooth transition into heating after defrost, minimizing noise and compressor stress associated with switch over. **Standard**

Increased Reliability — Fewer components (moving electro-mechanical parts), less likelihood of equipment down time or failure. **Standard**

Integral Electric Heat Staging① — Stages electric heaters “OFF” and “ON”, eliminating the use of outdated sequencers. **Standard**

Intelligent Fallback① — A built in Default Control provides adaptive operation, which allows the equipment to continue to operate, providing comfort in the event of certain component failures. Also, allows emergency operation without a Zone Sensor Module (ZSM). **Standard**

Low Ambient Start Timer (LAST) Function — Bypasses low pressure control when a compressor starts, eliminating nuisance compressor lock outs. **Standard**

Lower Installation Cost — Using a standard Zone Sensor Module (ZSM), control voltage wiring may be run up to five (5) times further than any electromechanical system, with no increase in wire gauge. Example: Electromechanical System – 30 feet maximum using 22 gauge wire. Micro Control System – 150 feet using 22 gauge wire. **Standard**

On Board Diagnostics① — Assist with equipment troubleshooting, if a problem occurrence should take place. **Standard**

Remote Sensing① — All standard Zone Sensor Modules (ZSMs) have remote sensing capabilities, typically achieved by using an expensive program-mable thermostat and remote sensor with electromechanical equipment. **Accessory (requires use of remote sensor).**

Selectable Economizer Dry Bulb Change Over — Allows the capability of selecting the following dry bulb change over points: 63, 67, 70 or 73°F. **Standard with economizer accessory.**

Space Temperature Averaging① — All standard Zone Sensor Modules (ZSMs) have space temperature averaging capabilities, typically achieved by using an expensive programmable thermostat and minimum of four (4) remote sensors with electromechanical equipment. **Averaging with ReliaTel™ can be achieved with two (2) sensors.**

Supply Air Tempering① — A built in feature, once enabled only through an ICS device, may also be enabled using a digital or programmable Zone Sensor Module. When in the HEAT mode (and not actively heating), if supply air temperature drops 10°F below the heating setpoint, heat is turned on until supply air temperature rises to a point 10°F above the heating setpoint. Provides temperate air during the “OFF” cycle, and eliminates cold air dumping from supply ducts. Extremely effective when introducing any quantity of fresh air. **Standard when using a RTOM, ICS device, digital, or programmable Zone Sensor Module.**

Time Delay Relay (TDR) Function — Provides an incremental staging delay between compressors, minimizes equipment current inrush and consumption by keeping compressors from starting simultaneously. **Standard**

Low Pressure and High Pressure Compressor Lockout — 3 trips will lockout control.

① Denotes features lost from utilizing standard conventional stat.

ReliaTel™ Controls

Operation With An Electromechanical Thermostat

When the ReliaTel™ RTRM Thermostat Interface is used, equipment operation differs significantly. The basic equipment protection features remain intact, and the following features and benefits are **LOST**:

- **Direct Digital Control (DDC)** – Proportional Integral (PI) control is lost, equipment is controlled by a thermostat or generic building automation system device.
- **Intelligent Fall back** is lost, if a failure occurs in the device controlling the equipment, operation will cease.
- Installation is more costly, with the addition of a thermostat or generic control, the control wiring size must be increased.
- **Heat Pump Smart Recovery and Smart Staging** is lost, Heat Pump operation becomes more costly unless generic control being applied can accomplish this.
- **Remote Sensing** capabilities are lost, unless generic control being applied can accomplish this.
- **Low ambient disabled economizer and second condensing fan cycling capability.**
- **Space Temperature Averaging** capabilities are lost, unless generic control being applied can accomplish this.
- **Supply Air Tempering** feature is lost, discharge air temperature may be cold when not actively heating if outdoor air is being introduced through the equipment.
- **Built In Night Set Back and Unoccupied** functions are lost, unless generic control being applied can accomplish this.
- **Built In Unoccupied Mode** is lost, unless generic control being applied can accomplish this.
- **Economizer Preferred Cooling Feature** is lost, all compressor operation is locked out below 50°F.

Packaged Cooling with ReliaTel™ Controls 12½-25 Tons, R-410A

12½-25 Ton T*D-F – Downflow

12½-25 Ton T*H-F – Horizontal

- ReliaTel™ control features are listed on page LPC-13
- Built-in anti-short cycle, time-delay relay and minimum on time controls
- 2" throwaway filters
- Liquid line drier
- Built-in fork lift holes

- Operating charge of R-410A
- Quick-Access on 12½ – 25
- Sloped sheet metal drain pan
- Dedicated horizontal and downflow units
- Single point power for electric heat
- Complete line of optional electric heaters
- Internally enhanced coil tubing
- Low ambient to 0°F standard
- Colored and numbered wiring

- Phase monitor
- Quick-adjust idler arm pulley. Adjust belt tension, change belts, adjust airflow quickly (12½ – 25 tons), downflow only
- UL listed and CSA certified
- **5-year limited compressor warranty (12½ – 17½ tons)**
- **1-year limited compressor warranty (20 and 25 tons)**

Table LPC-15-A — High Efficiency ReliaTel™ Units (R-410A)

Tons	Unit Model No.	Power Supply Volts/Phase/Hz	Performance EER	Cooling Capacity (Btu/h)	Dimensions (in.) H x W x L	Shipping Weight (lbs.)	MCA ^②	Max Fuse Size or Max Circuit Breaker ^①	Downflow ^③ Roofcurb
12½	TH*150F3R0A000	208-230/3/60	12.1	140,000	54 x 85 ⁵ / ₁₆ x 122 ⁵ / ₁₆	2373	65	80	BAYCURB027B
15	TH*180F3R0A000	208-230/3/60	12.0	172,000	64 1/8 x 85 ⁵ / ₁₆ x 122 ⁵ / ₁₆	2322	72	90	BAYCURB027B
17½	TH*210F3R0A000	208-230/3/60	11.8	198,000	64 1/8 x 85 ⁵ / ₁₆ x 122 ⁵ / ₁₆	2396	88	110	BAYCURB027B
20	TH*240F3R0A000	208-230/3/60	11.0	242,000	64 1/8 x 85 ⁵ / ₁₆ x 122 ⁵ / ₁₆	2399	104	125	BAYCURB027B
25	TH*300F3R0A000	208-230/3/60	10.6	272,000	64 1/8 x 85 ⁵ / ₁₆ x 122 ⁵ / ₁₆	2365	116	150	BAYCURB027B
12½	TH*150F4R0A000	460/3/60	12.1	140,000	54 x 85 ⁵ / ₁₆ x 122 ⁵ / ₁₆	2373	32	40	BAYCURB027B
15	TH*180F4R0A000	460/3/60	12.0	172,000	64 1/8 x 85 ⁵ / ₁₆ x 122 ⁵ / ₁₆	2322	36	45	BAYCURB027B
17½	TH*210F4R0A000	460/3/60	11.8	198,000	64 1/8 x 85 ⁵ / ₁₆ x 122 ⁵ / ₁₆	2396	42	50	BAYCURB027B
20	TH*240F4R0A000	460/3/60	11.0	242,000	64 1/8 x 85 ⁵ / ₁₆ x 122 ⁵ / ₁₆	2399	50	60	BAYCURB027B
25	TH*300F4R0A000	460/3/60	10.6	272,000	64 1/8 x 85 ⁵ / ₁₆ x 122 ⁵ / ₁₆	2365	56	70	BAYCURB027B
12½	TH*150FWR0A000	575/3/60	12.1	140,000	54 x 85 ⁵ / ₁₆ x 122 ⁵ / ₁₆	2373	25	30	BAYCURB027B
15	TH*180FWR0A000	575/3/60	12.0	172,000	64 1/8 x 85 ⁵ / ₁₆ x 122 ⁵ / ₁₆	2322	29	40	BAYCURB027B
17½	TH*210FWR0A000	575/3/60	11.8	198,000	64 1/8 x 85 ⁵ / ₁₆ x 122 ⁵ / ₁₆	2396	36	45	BAYCURB027B
20	TH*240FWR0A000	575/3/60	11.0	242,000	64 1/8 x 85 ⁵ / ₁₆ x 122 ⁵ / ₁₆	2399	42	50	BAYCURB027B
25	TH*300FWR0A000	575/3/60	10.6	272,000	64 1/8 x 85 ⁵ / ₁₆ x 122 ⁵ / ₁₆	2365	47	60	BAYCURB027B

Table LPC-15-B — High Efficiency ReliaTel™ Units (R-410A) - Multi Speed Indoor Fan

Tons	Unit Model No.	Power Supply Volts/Phase/Hz	Performance EER	Cooling Capacity (Btu/h)	Dimensions (in.) H x W x L	Shipping Weight (lbs.)	MCA ^②	Max Fuse Size or Max Circuit Breaker ^①	Downflow Roofcurb
12½	TH*150F3R0A1B8B	208-230/3/60	12.1	140,000	54 x 85 ⁵ / ₁₆ x 122 ⁵ / ₁₆	2398	65	80	BAYCURB027B
15	TH*180F3R0A1B8B	208-230/3/60	12.0	172,000	64 1/8 x 85 ⁵ / ₁₆ x 122 ⁵ / ₁₆	2347	72	90	BAYCURB027B
17½	TH*210F3R0A1B8B	208-230/3/60	11.8	198,000	64 1/8 x 85 ⁵ / ₁₆ x 122 ⁵ / ₁₆	2421	88	110	BAYCURB027B
20	TH*240F3R0A1B8B	208-230/3/60	11.0	242,000	64 1/8 x 85 ⁵ / ₁₆ x 122 ⁵ / ₁₆	2424	104	125	BAYCURB027B
25	TH*300F3R0A1B8B	208-230/3/60	10.6	272,000	64 1/8 x 85 ⁵ / ₁₆ x 122 ⁵ / ₁₆	2430	116	150	BAYCURB027B
12½	TH*150F4R0A1B8B	460/3/60	12.1	140,000	54 x 85 ⁵ / ₁₆ x 122 ⁵ / ₁₆	2398	32	40	BAYCURB027B
15	TH*180F4R0A1B8B	460/3/60	12.0	172,000	64 1/8 x 85 ⁵ / ₁₆ x 122 ⁵ / ₁₆	2347	36	45	BAYCURB027B
17½	TH*210F4R0A1B8B	460/3/60	11.8	198,000	64 1/8 x 85 ⁵ / ₁₆ x 122 ⁵ / ₁₆	2421	42	50	BAYCURB027B
20	TH*240F4R0A1B8B	460/3/60	11.0	242,000	64 1/8 x 85 ⁵ / ₁₆ x 122 ⁵ / ₁₆	2424	50	60	BAYCURB027B
25	TH*300F4R0A1B8B	460/3/60	10.6	272,000	64 1/8 x 85 ⁵ / ₁₆ x 122 ⁵ / ₁₆	2410	56	70	BAYCURB027B
12½	TH*150FWR0A1B8B	575/3/60	12.1	140,000	54 x 85 ⁵ / ₁₆ x 122 ⁵ / ₁₆	2398	25	30	BAYCURB027B
15	TH*180FWR0A1B8B	575/3/60	12.0	172,000	64 1/8 x 85 ⁵ / ₁₆ x 122 ⁵ / ₁₆	2347	29	40	BAYCURB027B
17½	TH*210FWR0A1B8B	575/3/60	11.8	198,000	64 1/8 x 85 ⁵ / ₁₆ x 122 ⁵ / ₁₆	2421	36	45	BAYCURB027B
20	TH*240FWR0A1B8B	575/3/60	11.0	242,000	64 1/8 x 85 ⁵ / ₁₆ x 122 ⁵ / ₁₆	2424	42	50	BAYCURB027B
25	TH*300FWR0A1B8B	575/3/60	10.6	272,000	64 1/8 x 85 ⁵ / ₁₆ x 122 ⁵ / ₁₆	2410	47	60	BAYCURB027B

① HACR type circuit breaker per NEC.

② Information subject to change. Please confirm with current Product Data/Service Facts for current factory production.

③ Downflow only.

④ 278,000 in the horizontal airflow configuration.

* Digit 3 - H = Horizontal or D = Downflow.

Packaged Cooling with ReliaTel™ Controls 12½-25 Tons, R-410A

12½-25 Ton T*D-F – Downflow

12½-25 Ton T*H-F – H orizontal

- ReliaTel™ control features are listed on page LPC-13
- Built-in anti-short cycle, time-delay relay and minimum on time controls
- 2" throwaway filters
- Liquid line drier
- Built-in fork lift holes

- Operating charge of R-410A
- Quick-Access on 12½ – 25
- Sloped sheet metal drain pan
- Dedicated horizontal and downflow units
- Single point power for electric heat
- Complete line of optional electric heaters
- Internally enhanced coil tubing
- Low ambient to 0°F standard
- Colored and numbered wiring

- Phase monitor
- Quick-adjust idler arm pulley. Adjust belt tension, change belts, adjust airflow quickly (12½ – 25 tons), downflow only
- UL listed and CSA certified
- **5-year limited compressor warranty (12½ – 17½ tons)**
- **1-year limited compressor warranty (20 and 25 tons)**

Table LPC-16-A — ReliaTel™ Units (R-410A) - Standard Efficiency

Tons	Unit Model No.	Power Supply Volts/Phase/Hz	Performance EER	Cooling Capacity (Btuh)	Dimensions (in.) H x W x L	Shipping Weight (lbs.)	MCA ^②	Max Fuse Size or Max Circuit Breaker ^①	Downflow ^③ Roofcurb
12½	TS*150F3R0A0000	208-230/3/60	11.0	140,000	50½ x 71½ x 107½	1781	64	80	BAYCURB026B
15	TS*180F3R0A0000	208-230/3/60	11.0	176,000	54 x 85½ x 122½	2281	75	100	BAYCURB027B
17½	TS*210F3R0A0000	208-230/3/60	11.0	193,000	54 x 85½ x 122½	2292	93	125	BAYCURB027B
20	TS*240F3R0A0000	208-230/3/60	10.0	240,000	54 x 85½ x 122½	2353	108	125	BAYCURB027B
25	TS*300F3R0A0000	208-230/3/60	10.0	272,000	54 x 85½ x 122½	2337	124	150	BAYCURB027B
12½	TS*150F4R0A0000	460/3/60	11.0	140,000	50½ x 71½ x 107½	1781	31	40	BAYCURB026B
15	TS*180F4R0A0000	460/3/60	11.0	176,000	54 x 85 5/16 x 122½	2281	28	50	BAYCURB027B
17½	TS*210F4R0A0000	460/3/60	11.0	193,000	54 x 85 5/16 x 122½	2292	44	60	BAYCURB027B
20	TS*240F4R0A0000	460/3/60	10.0	240,000	54 x 85 5/16 x 122½	2353	52	70	BAYCURB027B
25	TS*300F4R0A0000	460/3/60	10.0	272,000	54 x 85 5/16 x 122½	2337	59	70	BAYCURB027B
12½	TS*150FWR0A0000	575/3/60	11.0	140,000	50½ x 71½ x 107½	1781	23	30	BAYCURB026B
15	TS*180FWR0A0000	575/3/60	11.0	176,000	54 x 85½ x 122½	2281	31	40	BAYCURB027B
17½	TS*210FWR0A0000	575/3/60	11.0	193,000	54 x 85½ x 122½	2292	35	50	BAYCURB027B
20	TS*240FWR0A0000	575/3/60	10.0	240,000	54 x 85½ x 122½	2353	44	60	BAYCURB027B
25	TS*300FWR0A0000	575/3/60	10.0	272,000	54 x 85½ x 122½	2337	48	60	BAYCURB027B

Table LPC-16-B — ReliaTel™ Units (R-410A) - Standard Efficiency - Multi Speed Indoor Fan

Tons	Unit Model No.	Power Supply Volts/Phase/Hz	Performance EER	Cooling Capacity (Btuh)	Dimensions (in.) H x W x L	Shipping Weight (lbs.)	MCA ^②	Max Fuse Size or Max Circuit Breaker ^①	Downflow Roofcurb
12½	TS*150F3R0A1B8B	208-230/3/60	11.0	140,000	50½ x 71½ x 107½	1806	64	80	BAYCURB026B
15	TS*180F3R0A1B8B	208-230/3/60	11.0	176,000	54 x 85½ x 122½	2306	75	100	BAYCURB027B
17½	TS*210F3R0A1B8B	208-230/3/60	11.0	193,000	54 x 85½ x 122½	2317	93	125	BAYCURB027B
20	TS*240F3R0A1B8B	208-230/3/60	10.0	240,000	54 x 85½ x 122½	2378	108	125	BAYCURB027B
25	TS*300F3R0A1B8B	208-230/3/60	10.0	272,000	54 x 85½ x 122½	2402	124	150	BAYCURB027B
12½	TS*150F4R0A1B8B	460/3/60	11.0	140,000	50½ x 71½ x 107½	1806	31	40	BAYCURB026B
15	TS*180F4R0A1B8B	460/3/60	11.0	176,000	54 x 85½ x 122½	2306	28	50	BAYCURB027B
17½	TS*210F4R0A1B8B	460/3/60	11.0	193,000	54 x 85½ x 122½	2317	44	60	BAYCURB027B
20	TS*240F4R0A1B8B	460/3/60	10.0	240,000	54 x 85½ x 122½	2378	52	70	BAYCURB027B
25	TS*300F4R0A1B8B	460/3/60	10.0	272,000	54 x 85½ x 122½	2382	59	70	BAYCURB027B
12½	TS*150FWR0A1B8B	575/3/60	11.0	140,000	50½ x 71½ x 107½	1806	23	30	BAYCURB026B
15	TS*180FWR0A1B8B	575/3/60	11.0	176,000	54 x 85½ x 122½	2306	31	40	BAYCURB027B
17½	TS*210FWR0A1B8B	575/3/60	11.0	193,000	54 x 85½ x 122½	2317	35	50	BAYCURB027B
20	TS*240FWR0A1B8B	575/3/60	10.0	240,000	54 x 85½ x 122½	2378	44	60	BAYCURB027B
25	TS*300FWR0A1B8B	575/3/60	10.0	272,000	54 x 85½ x 122½	2382	48	60	BAYCURB027B

① HACR type circuit breaker per NEC.

② Information subject to change. Please confirm with current Product Data/Service Facts for current factory production.

③ Downflow only.

④ 278,000 in the horizontal airflow configuration.

* Digit 3 - H = Horizontal or D = Downflow.

Packaged Cooling with ReliaTel™ Controls 12½-25 Tons (Model Digit Numbers)

Digit	Description	Order Number	Digit	Description	Order Number		
1	Unit Type		19	Disconnect Switch/Circuit Breaker			
	Packaged Cooling, Electric Heat.....	T		No Disconnect/circuit break.....	0		
	Packaged Gas/Electric.....	Y		Unit Mounted Non-Fused Disconnect Switch.....	1		
2	Efficiency			Unit Mounted Circuit Breaker.....	2		
	Standard Efficiency.....	S	20	Convenience Outlet Option			
High Efficiency.....	H	Without Convenience Outlet.....		0			
3	Airflow Configuration				Unpowered Convenience Outlet.....	A	
	Downflow.....	D		Powered Convenience Outlet.....	B		
4-6	Nominal Gross Cooling Capacity (MBh)		21	Communications Options			
	12½ Tons.....	150		Without Communications Options.....	0		
	15 Tons.....	180		Novar 2024 Controls Interface④.....	3		
	17½ Tons.....	210		Novar 3051 Controls Interface④.....	4		
	20 Tons.....	240		Novar 3051 Communications Interface with Demand Control Ventilation④.....	5		
	25 Tons.....	300		Building Automation Control Network Communications Interface.....	6		
7	Major Design Sequence		22	Refrigeration System Option			
	Microchannel Type Condenser Coils.....	F		Standard refrigeration system.....	0		
8	Voltage Selection				Thermal Expansion Valve (TXV).....	A	
	208-230/60/3.....	3		Dehumidification (Hot Gas Reheat).....	B		
	460/60/3.....	4	23	Refrigeration Controls			
	575/60/3.....	W		Without Refrigeration Controls.....	0		
	380/60/3.....	K		Frostat.....	1		
9	Unit Controls		24	Smoke Detector			
	ReliaTel™.....	R		Without Smoke Detector.....	0		
10	Heating Capacity			Return Air Smoke Detector.....	A		
	No Heat②.....	0		Supply Air Smoke Detector.....	B		
	18 kW Electric Heat②.....	G		Return/Supply Air Smoke Detector.....	C		
	27 kW Electric Heat②.....	K		Plenum Smoke Detector.....	D		
	36 kW Electric Heat②.....	N	25	System Monitoring Controls			
	54 kW Electric Heat②.....	P		No Monitoring Controls.....	0		
	72 kW Electric Heat②.....	R		Clogged Filter Switch.....	1		
	Gas Heat - High①.....	H		Fan Failure Switch.....	2		
	Gas Heat - Low①.....	L		Discharge Air Sensing.....	3		
	Gas Heat - SS Ht Ex - Modulating①.....	V		Clogged Filter Switch and Fan Failure switch.....	4		
	Gas Heat - SS Ht Ex - Low①.....	X		Clogged Filter Switch and Discharge Air Sensing.....	5		
Gas Heat - SS Ht Ex - High①.....	Z	Fan Failure Switch and Discharge Air Sensing.....		6			
11	Minor Design Sequence				Clogged Filter Switch, Fan Failure Switch and Discharge Air Sensing.....	7	
12-13	Service Sequence				NOVAR Return Air Sensor (Novar 2024)④.....	8	
14	Fresh Air Selection				NOVAR Zone Temp Sensor(Novar 3051)④.....	9	
	No Fresh Air.....	0		Condensate Drain Pan Overflow Switch.....	A		
	Econ Dry Bulb w/ Barometric Relief.....	D		Clogged Filter Switch and Condensate Drain Pan Overflow Switch.....	B		
	Econ Reference Enthalpy w/Barometric Relief.....	F		Fan Failure Switch and Condensate Drain Pan Overflow Switch.....	C		
15	Supply Fan/Drive Type/Motor			Discharge Air Sensing and Condensate Drain Pan Overflow Switch.....	D		
	Standard Motor.....	0		Clogged Filter Switch, Fan Failure Switch and Condensate Drain Pan Overflow Switch.....	E		
	Oversized Motor.....	1		Clogged Filter Switch, Discharge Air Sensing Tube and Condensate Drain Pan Overflow Switch.....	F		
	High Efficiency Motor.....	3		Fan Failure Switch, Discharge Air Sensing Tube and Condensate Drain Pan Overflow Switch.....	G		
	Single Zone Variable Air Volume Standard Motor.....	6	26	System Monitoring Controls			
	Multi-Speed Standard Motor.....	7		No Monitoring Controls.....	0		
	Single Zone Variable Air Volume Oversized Motor.....	8			Demand Control Ventilation (CO ₂)⑤.....	A	
	Multi-Speed Oversized Motor.....	9		27	Unit Hardware Enhancements		
	Single Zone Variable Air Volume Standard Motor w/Shaft Ground Ring.....	A			No Enhancements.....	0	
	Multi-Speed Standard Motor w/Shaft Ground Ring.....	B			Stainless Steel Drain Pan.....	1	
	Single Zone Variable Air Volume Oversized Motor w/Shaft Ground Ring.....	C		Note: Most Factory Installed Options available for Downflow Air Discharge units only. Please verify with ordering system for availability.			
Multi-Speed Oversized Motor w/Shaft Ground Ring.....	D						
16	Hinged Service Access / Filters						
	Standard Panels/Standard Filters.....	0					
	Hinged Access/Standard Filters.....	A					
	Standard Panels/MERV 8 Filters.....	B					
	Hinged Access/MERV 8 Filters.....	C					
17	Condenser Coil Protection						
	Standard Coil.....	0					
	Standard Coil With Hail Guard.....	1					
	CompleteCoat™ Condenser Coil.....	4					
	CompleteCoat™ Condenser Coil with Hail Guard.....	5					
18	Through The Base Provisions.						
	No Through The Base Provisions③.....	0					
	Through The Base Electric③.....	A					
	Through The Base Gas①.....	B					
	Through The Base Electric/Gas①.....	C					
	Through The Base Access①.....	D					

① Applicable to Digit 1 Y models only.
② Applicable to Digit 1 T models only.
③ Applicable to Digit 1, T or Y models.

④ Novar is not available with SZ VAV products.
⑤ Demand Control Ventilation Option includes wiring only. The CO₂ sensor is a field-installed only option.

**For additional Controls Information:
See ReliaTel™ and Micro Control features on PC-17 and PC-18.**

Packaged Cooling with ReliaTel™ Controls 12½-25 Tons, R-410A Zone Sensors / Thermostats

Table LPC-18-B — Zone Sensors for ReliaTel™

Model Number	Description	Used With
ASYSTAT106A	Single Setpoint Manual Changeover	YC*150-301
ASYSTAT108A	Dual Setpoint Manual or Automatic Changeover	YC*150-301
ASYSTAT111A	Remote Room Sensor	ASYSTAT777A
ASYSTAT777A	Programmable Night Setback	YC*150-301
ASYSTAT710A	Wall Mounted Humidity Sensor	YFD151,181,241 (with Reheat)
ASYSTAT711A	Duct Mounted Humidity Sensor	YFD151,181,241 (with Reheat)
BAYMTPL110A	Retrofit Wall Cover Plate Kit 7.25" x 6.0"	ASYSTAT777A

Table LPC-19-A — Field Installed Accessories

For complete list of of All Factory Installed Options refer to FIOPS section of this book.

Model Number	Description	Used With
BAYBCIR001A	BACnet™ Communication Interface	All Voyagers
BAYABRD002B ^⑩	ReliaTel™ Options Module	All Voyagers
BAYCO2K002B ^⑩	CO ₂ Sensor Wall Mounted	All Voyagers w/Economizers
BAYCO2K004B ^⑩	CO ₂ Sensor Duct Mounted	All Voyagers w/Economizers
BAYCURB026B ^{⑤⑥}	Downflow Roof Curb (Can not be adapted for horizontal use)	TSD150F
BAYCURB027B ^{⑤⑥}	Downflow Roof Curb (Can not be adapted for horizontal use)	THD150F-300F, TSD180-300F
BAYDFPS005A ^{⑧⑨}	Clogged Filter Switch (MERV 7)	All Voyagers
BAYDFPS006A ^{⑧⑨}	Fan Failure Switch	All Voyagers
BAYDFPS013A	Clogged Filter Switch (MERV 13)	All Voyagers
BAYDMPR029C	0-25% Manual Outside Air Damper	All Voyagers
BAYDMPR057A	0-50% Motorized Outside Air Damper	TSD150F
BAYDMPR058A	0-50% Motorized Outside Air Damper	TSD151F-300F, TSD180F-300F
BAYECON089A ^⑨	Downflow Economizer with Barometric Relief	TSD150F
BAYECON090A ^⑨	Downflow Economizer with Barometric Relief	TSD151F-300F, TSD180F-300F
BAYECON091A	Horizontal Economizer	TSH150F
BAYECON092A	Horizontal Economizer	TSH151F-300F, TSF180F-300F
BAYENTH007A ^{①②}	Reference Enthalpy Kit	All BAYECON089-92A
BAYENTH008A ^{①③}	Comparative Enthalpy Kit	All BAYECON089-92A
BAYFRST003A ^⑦	High Temperature Stat	All Voyagers
BAYGARD144A ^④	Tool-less Hail Guard	TS*150F
BAYGARD145A ^④	Tool-less Hail Guard	TH*150F, TS*210F, TS*240F, TS*300F
BAYGARD150A	Tool-less Hail Guard	TH*180F, TH*210F, TH*240F, TH*300F
BAYHSDR005B ^④	High Static Drive	TS*150F, TH*150F, TH*180F
BAYHSDR010A ^④	High Static Drive	TH*210F, TH*240F, TS*300F
BAYHSDR011A ^④	High Static Drive	TS*210F, TS*240F, TH*300F
BAYHSDR016A	High Static Drive	TS*180F

- ① Kit contains all necessary parts to achieve desired level of Enthalpy Control.
- ② Reference Enthalpy senses outside temperature/humidity and inside return/mixed air temperature/humidity.
- ③ Comparative Enthalpy senses outside temperature/humidity and inside return/mixed air temperature/humidity.
- ④ High static drive and oversized motors are mutually exclusive, Do Not Combine.
- ⑤ Clarksville manufacturing has a no return policy for this roof curb.
- ⑥ For downflow use only. Can not be adapted for horizontal units.
- ⑦ Must be used with either field or factory installed TCI (Trane Communications Interface).
- ⑧ BAYABRD002B is required when ordering field installed BAYDFPS005A or 006A, BAYTUBE008A or 009A and BAYLOAM023A or BAYVNOR002B.
- ⑨ Field or factory installed option.
- ⑩ Field installed accessory. Requires an economizer.

Packaged Cooling with ReliaTel™ Controls 12½-25 Tons Accessories

Table LPC-20-A — Field Installed Accessories

For complete list of of All Factory Installed Options refer to FIOPS section of this book.

Model Number	Description	Used With
BAYHSMT039B①⑥	5HP Oversized Motor Kit (208-230/460V)	TS*150F
BAYHSMT040B①⑥	5HP Oversized Motor Kit (575V)	TS*150F
BAYHSMT055B①⑥	5HP Oversized Motor Kit (208-230/460V)	TS*180F
BAYHSMT042A①⑥	7-1/2HP Oversized Motor Kit (575V)	TS*210F, TH*210F, TS*240F, TH*240F
BAYHSMT072A①⑥	7-1/2HP Oversized Motor Kit (575V)	TS*180F, TH*180F
BAYHSMT098A①⑥	7-1/2HP Oversized Motor Kit (208-230V)	TH*210F, TH*240F
BAYHSMT099A①⑥	7-1/2HP Oversized Motor Kit (460V)	TH*210F, TH*240F
BAYLOAM023A⑥	Evaporator Defrost Control Frostat	TS*150F, TH*150F, TS*180F TS*210F, TS*240F, TS*300F
BAYLOAM031A	Evaporator Defrost Control Frostat	TH*180F, TH*210F, TH*240F, TH*300F
BAYLSDR004A②	Low Static Drive	TS*150F, TS*180F, TS*210F TH*210F, TH*240F, TS*240F
BAYLSDR002A②	Low Static Drive	TH*150F, TH*180F, TH*300F
BAYPWRX029A	Power Exhaust for all Voyagers 12½-25 Ton 230V units	BAYECON089-090A, TCD150-301
BAYPWRX030A	Power Exhaust for all Voyagers 12½-25 Ton 460V units	BAYECON089-090A, TCD150-301
BAYPWRX031A	Power Exhaust for all Voyagers 12½-25 Ton 575V units	BAYECON089-090A, TCD150-301
BAYSERV001A	Selective Resistance Service Tester	All TC*150F-TC*301F
BAYSTAT023③	Remote Potentiometer	All Economizers and 0-50% Motorized Air Dampers
BAYTUBE008A④⑤⑥	Discharge Air Sensing Kit	All TCD150F-TCD301F
BAYTUBE009A④⑤⑥	Discharge Air Sensing Kit	All TCH150F-TCH301F
BAYQACB044A	Adapter Curb	BAYCURB026A/B to BAYCURB027A/B
BAYVNOR002B⑤	Ventilation Override Kit	TC*150-301 w/ReliaTel™ Options Module

- ① High static drive and oversized motors are mutually exclusive, Do Not Combine.
- ② Low static drive and oversized motors are mutually exclusive, Do Not Combine.
- ③ Cannot be used with Integrated Comfort™ Systems.
- ④ Used for true discharge air sensing in both heating and cooling models.
- ⑤ BAYABRD002B is required when ordering field installed BAYDFPS005A or 006A, BAYTUBE008A or 009A and BAYLOAM031A or BAYVNOR002B.
- ⑥ Field or factory installed option.

Table LPC-21-A — Downflow Supplementary Heaters:

Model Number	Power Supply	kW Rating	Nominal BTUH	No. Stages	Used With
AYDHTRK318A	208-230/3/60	13.5/18.0	46,100/61,400	1	TSD150F-180F, THD150F-180F
AYDHTRK336A	208-230/3/60	27.0/36.0	92,200/122,900	2	TSD150F-180F, THD150F-180F
AYDHTRK354A	208-230/3/60	40.5/54.0	138,200/184,300	2	TSD150F-180F, THD150F-180F
AYDHTRL418A	460/3/60	18.0	61,400	1	TSD150F-180F, THD150F-180F
AYDHTRK427A	460/3/60	27.0	92,150	2	THD180F
AYDHTRK436A	460/3/60	36.0	122,900	2	TSD150F-180F, THD150F-180F
AYDHTRK454A	460/3/60	54.0	184,300	2	TSD150F-180F, THD150F-180F
AYDHTRL336A	208-230/3/60	27.0/36.0	92,200/122,900	2	TSD210F-300F, THD210-300F
AYDHTRL354A	208-230/3/60	40.5/54.0	138,200/184,300	2	TSD210F-300F, THD210-300F
AYDHTRK372A	208-230/3/60	54.0/72.0	184,300/245,700	2	TSD210F-300F, THD210-300F
AYDHTRL427A	460/3/60	27.0	92,150	2	THD210F, THD240-300F
AYDHTRL436A	460/3/60	36.0	122,900	2	TSD210F-300F, THD210-300F
AYDHTRL454A	460/3/60	54.0	184,300	2	TSD210F-300F, THD210-300F
AYDHTRK472A	460/3/60	72.0	245,700	2	TSD210F-300F, THD210-300F

Table LPC-21-B — Horizontal Supplementary Heaters:

Model Number	Power Supply	kW Rating	Nominal BTUH	No. Stages	Used With
AYHHTRN318A	208-230/3/60	13.5/18.0	46,000/61,400	1	TSH150F, TSH180F
AYHHTRP336A	208-230/3/60	27.0/36.0	92,200/122,900	2	TSH150F, TSH180F
AYHHTRP354A	208-230/3/60	40.5/54.0	138,200/184,300	2	TSH150F, TSH180F
AYHHTRN418A	460/3/60	18.0	61,400	1	TSH150F, TSH180F
AYHHTRP436A	460/3/60	36.0	122,900	2	TSH150F, TSH180F
AYHHTRP454A	460/3/60	54.0	184,300	2	TSH150F, TSH180F
AYHHTRN336A	208-230/3/60	27.0/36.0	92,200/122,900	2	TSH210-300F, THH210-300F
AYHHTRN354A	208-230/3/60	40.5/54.0	138,200/184,300	2	TSH210-300F, THH210-300F
AYHHTRN372A	208-230/3/60	54.0/72.0	184,300/245,700	2	TSH210-300F, THH210-300F
AYHHTRN436A	460/3/60	36.0	122,900	2	TSH210-300F, THH210-300F
AYHHTRN454A	460/3/60	54.0	184,300	2	TSH210-300F, THH210-300F
AYHHTRN472A	460/3/60	72.0	245,700	2	TSH210-300F, THH210-300F
AYHHTRM318A	208-230/3/60	13.5/18.0	46,100/61,400	1	THH150F, THH180F
AYHHTRM336A	208-230/3/60	27.0/36.0	92,200/122,900	2	THH150F, THH180F
AYHHTRM354A	208-230/3/60	40.5/54.0	138,200/184,300	2	THH150F, THH180F
AYHHTRM418A	460/3/60	18.0	61,400	1	THH150F, THH180F
AYHHTRM436A	460/3/60	36.0	122,900	2	THH150F, THH180F
AYHHTRM454A	460/3/60	54.0	184,300	2	THH150F, THH180F

Note: Unit with heater is single circuit/single point.

Packaged Cooling with ReliaTel™ Controls 12½-25 Tons Heaters

Table LPC-22-A — Downflow Supplementary Heaters:

Model Number	Power Supply	kW Rating	Nominal BTUH	No. Stages	Used With
AYDHTRLW54A	575/3/60	54.0	184,300	2	TSD210-300F, THD210-300F
AYDHTRKW18A	575/3/60	18.0	61,400	1	TSD150-180F, THD150-180F
AYDHTRKW54A	575/3/60	54.0	184,300	2	TSD150-180F, THD150-180F
AYDHTRKW72A	575/3/60	72.0	245,700	2	TSD210-300F, THD210-300F
AYDHTRMW36A	575/3/60	36.0	122,900	2	TSD150-300F, THD150-300F

Table LPC-22-B — Horizontal Supplementary Heaters:

Model Number	Power Supply	kW Rating	Nominal BTUH	No. Stages	Used With
AYHHTRMW18A	575/3/60	18.0	61,400	1	THH150F, THH180F
AYHHTRMW36A	575/3/60	36.0	122,900	2	TSH210F-300F, TSH150F-300F
AYHHTRMW54A	575/3/60	54.0	184,300	2	THH150F, THH180F
AYHHTRNW18A	575/3/60	18.0	61,400	1	TSH150F, TSH180F
AYHHTRNW54A	575/3/60	54.0	184,300	2	TSH210F-300F, THH210F-300F
AYHHTRNW72A	575/3/60	72.0	245,700	2	TSH210F-300F, THH210F-300F
AYHHTRPW36A	575/3/60	36.0	122,900	2	TSH150F, TSH180F
AYHHTRPW54A	575/3/60	54.0	184,300	2	TSH150F, TSH180F

Note: Unit with heater is single circuit/single point.

**For additional Controls Information:
See ReliaTel™ and Micro Control features on LPC-13 and LPC-14.**

Foundation™ Packaged Cooling 15-25 Tons, R-410A



- Scroll compressors on all units
- Operating charge of R-410A
- Low ambient operation to 40°F as standard
- Color coded and numbered wiring
- Single side service access
- Molded handles on service access doors
- Separated high and low voltage compartments
- Liquid Line Refrigerant Drier
- Provisions for through the base connections
- Phase monitor on all units
- Convertible airflow
- Two inch throwaway filters as standard
- Non-corrosive & removable drain pan
- **5-year limited compressor warranty (15 & 17-1/2 tons)**
- **1-year limited compressor warranty (20 & 25 tons)**

Table PC-23-A — Foundation™ — R-410A — Electromechanical Controls

Tons	Unit Model No.	Power Supply Volts/Phase/Hz	Performance EER	Cooling Capacity (Btuh)	Dimensions (in.) H x W x L	Shipping Weight (lbs.)	MCA	Max Fuse Size or Max Circuit Breaker ^①	Downflow Roofcurb
15	EAC180A3E0A0000	208-230/3/60	11.0	183,000	58 ⁵ / ₈ x 86 ¹⁵ / ₁₆ x 123 ¹ / ₈	2,020	79	100	BAYCURB027B
17 ¹ / ₂	EAC210A3E0A0000	208-230/3/60	11.0	212,000	58 ⁵ / ₈ x 86 ¹⁵ / ₁₆ x 123 ¹ / ₈	2,074	91	110	BAYCURB027B
20	EAC240A3E0A0000	208-230/3/60	10.0	252,000	58 ⁵ / ₈ x 86 ¹⁵ / ₁₆ x 123 ¹ / ₈	2,163	117	150	BAYCURB027B
25	EAC300A3E0A0000	208-230/3/60	10.0	290,000	58 ⁵ / ₈ x 86 ¹⁵ / ₁₆ x 123 ¹ / ₈	2,208	124	150	BAYCURB027B
15	EAC180A4E0A0000	460/3/60	11.0	183,000	58 ⁵ / ₈ x 86 ¹⁵ / ₁₆ x 123 ¹ / ₈	2,020	37	45	BAYCURB027B
17 ¹ / ₂	EAC210A4E0A0000	460/3/60	11.0	212,000	58 ⁵ / ₈ x 86 ¹⁵ / ₁₆ x 123 ¹ / ₈	2,074	42	50	BAYCURB027B
20	EAC240A4E0A0000	460/3/60	10.0	252,000	58 ⁵ / ₈ x 86 ¹⁵ / ₁₆ x 123 ¹ / ₈	2,163	53	70	BAYCURB027B
25	EAC300A4E0A0000	460/3/60	10.0	290,000	58 ⁵ / ₈ x 86 ¹⁵ / ₁₆ x 123 ¹ / ₈	2,208	56	70	BAYCURB027B
15	EAC180AWE0A0000	575/3/60	11.0	183,000	58 ⁵ / ₈ x 86 ¹⁵ / ₁₆ x 123 ¹ / ₈	2,020	31	40	BAYCURB027B
17 ¹ / ₂	EAC210AWE0A0000	575/3/60	11.0	212,000	58 ⁵ / ₈ x 86 ¹⁵ / ₁₆ x 123 ¹ / ₈	2,074	34	40	BAYCURB027B
20	EAC240AWE0A0000	575/3/60	10.0	252,000	58 ⁵ / ₈ x 86 ¹⁵ / ₁₆ x 123 ¹ / ₈	2,163	42	50	BAYCURB027B
25	EAC300AWE0A0000	575/3/60	10.0	290,000	58 ⁵ / ₈ x 86 ¹⁵ / ₁₆ x 123 ¹ / ₈	2,208	47	60	BAYCURB027B

^① HACR Circuit Breaker Type Per NEC.

Information subject to change. Please confirm with current Product Data for current factory production.

Foundation™ Packaged Cooling 15-25 Tons Accessories

Table LPC-24-A — Foundation™ - R-410A - Field Installed Accessories

Model Number	Description	Used With
BAYTBUE300A.....	Through the Base Electrical Connections	All Foundation 15-25 Ton Units
BAYDSCF300A.....	Unit Mounted Disconnect, 100 Amp..... Not for use when electric heat installed	EAC180A4* - EAC300A4*, EAC180AW* - EAC300AW*
BAYDSCF301A.....	Unit Mounted Disconnect, 150 Amp..... Not for use when electric heat installed	EAC180A3* - EAC300A3*
BAYDSCF302A.....	Unit Mounted Disconnect, 100 Amp.....	EAC180A3, 4, W with 18Kw Heater EAC180A4, W with 54Kw Heater EAC210-300AW with 72Kw Heater
BAYDSCF303A.....	Unit Mounted Disconnect, 150 Amp.....	EAC180-300A3 with 36Kw Heater EAC210-300A4 with 72Kw Heater
BAYDSCF304A.....	Unit Mounted Disconnect, 250 Amp.....	EAC210-240A3 with 72Kw Heater EAC180-300A3 with 54Kw Heater
BAYDMPR301A.....	Damper, Manual.....	EAC180A* - EAC300A*
BAYDMPR300A.....	Damper, Motorized.....	EAC180A* - EAC300A*
BAYECON300A.....	Economizer, Dry Bulb, Downflow	EAC180A* - EAC300A*
BAYECON301A.....	Economizer, Dry Bulb, Horizontal	EAC180A* - EAC300A*
BAYHZCN300A.....	Horizontal Economizer Conversion Kit.....	EAC180A* - EAC300A*
BAYBARO300A.....	Barometric Relief Damper, 15-25T	EAC180A* - EAC300A*
BAYENTH300A.....	Reference Enthalpy Economizer.....	EAC180A* - EAC300A*
BAYENTH301A.....	Comparative Enthalpy Economizer	EAC180A* - EAC300A*
BAYCURB027B.....	Roof Curb.....	EAC180A* - EAC300A*
BAYHZRT001A.....	Horizontal Duct Conversion Kit	EAC180A* - EAC300A*
BAYCARR001A.....	Carrier Replacement Conversion Kit.....	EAC180A* - EAC300A*
BAYGARD300A.....	Condenser Hail Guard	EAC180A* - EAC300A*
BAYCCHT300A.....	Crankcase Heater, 70W, 230V.....	EAC180A3* - EAC300A3*
BAYCCHT301A.....	Crankcase Heater, 70W, 460V.....	EAC180A4* - EAC300A4*
BAYCCHT302A.....	Crankcase Heater, 70W, 575V.....	EAC180AW* - EAC300AW*
BAYASCT001.....	Compressor Short Cycle Timer.....	EAC180A* - EAC300A*
BAYLOAM300A.....	Low Ambient Control.....	EAC180A* - EAC300A*
BAYLOAM310A.....	Evaporator Defrost Control	EAC180A* - EAC300A*
BAYPWRX300A.....	Power Exhaust, 15-25T, DF, 230V.....	EAC180A3* - EAC300A3*
BAYPWRX301A.....	Power Exhaust, 15-25T, DF, 460V.....	EAC180A4* - EAC300A4*
BAYPWRX302A.....	Power Exhaust, 15-25T, DF, 575V.....	EAC180AW* - EAC300AW*
BAYHSMT300A.....	High Static Motor & Drv, 5HP 230/460V	EAC180A3, EAC180A4
BAYHSMT301A.....	High Static Motor & Drv, 5HP 575V	EAC180AW
BAYHSMT302A.....	High Static Motor & Drv, 7.5HP 230/460V	EAC210A3, EAC240A3
BAYHSMT303A.....	High Static Motor & Drv, 7.5HP 460V	EAC210A4, EAC240A4
BAYHSMT304A.....	High Static Motor & Drv, 7.5HP 575V	EAC210AW, EAC240AW
BAYSHGR003A.....	Shaft Grounding Ring, 0.875" Shaft.....	Used With 5HP VFD Motors
BAYSHGR002A.....	Shaft Grounding Ring, 1.125" Shaft.....	Used With 7.5HP VFD Motors
BAYSHGR004A.....	Shaft Grounding Ring, 1.375" Shaft.....	Used With 10HP VFD Motors
BAYLSDR300A.....	Low Static Drive Option.....	EAC180A* - EAC300A*
BAYHSDR300A.....	High Static Drive Option.....	EAC180A* - EAC300A*
BAYCO2K300A.....	Wall Mounted CO2 Sensor	EAC180A* - EAC300A* with economizer
BAYCO2K301A.....	Duct Mounted CO2 Sensor.....	EAC180A* - EAC300A* with economizer
BAYCOSW300A.....	Drain Pan Overflow Switch.....	EAC180A* - EAC300A*
BAYSTAT300A.....	BACNet Enabled Thermostat.....	EAC180A* - EAC300A*

① Please check availability.

② See HVAC Knowledge Center for a list of compatible Carrier units.

Information subject to change. Please confirm with current Product Data for current factory production

Foundation™ Packaged Cooling 15-25 Tons Heaters

Table LPC-25-A — Foundation™ - R-410A - Field Installed Accessories

Model Number	Power Supply	kW Rating	Nominal BTUH	No. Stages	Used With
BAYHTFA318A	208-230/3/60	13.5/18	46,100/64,400	1	EAC180A3*
BAYHTFA336A	208-230/3/60	27/36	92,200/122,900	2	EAC180A3*, EAC210A3*
BAYHTFB336A	208-230/3/60	27/36	92,200/122,900	2	EAC240A3*, EAC300A3*
BAYHTFA354A	208-230/3/60	40.5/54	138,200/184,300	2	EAC180A3*, EAC210A3*
BAYHTFB354A	208-230/3/60	40.5/54	138,200/184,300	2	EAC240A3*, EAC300A3*
BAYHTFA372A	208-230/3/60	54/72	184,300/245,700	2	EAC210A3*
BAYHTFB372A	208-230/3/60	54/72	184,300/245,700	2	EAC240A3*, EAC300A3*
BAYHTFA418A	460/3/60	18	64,000	1	EAC180A4*
BAYHTFA436A	460/3/60	36	122,900	2	EAC180A4*, EAC210A4*
BAYHTFB436A	460/3/60	36	122,900	2	EAC240A4*, EAC400A4*
BAYHTFA454A	460/3/60	54	184,300	2	EAC180A4*, EAC210A4*
BAYHTFB454A	460/3/60	54	184,300	2	EAC240A4*, EAC400A4*
BAYHTFA472A	460/3/60	72	245,700	2	EAC210A4*
BAYHTFB472A	460/3/60	72	245,700	2	EAC240A4*, EAC400A4*
BAYHTFAW18A	575/3/60	18	64,000	1	EAC180AW*
BAYHTFAW36A	575/3/60	36	122,900	2	EAC180AW*, EAC210AW*
BAYHTFBW36A	575/3/60	36	122,900	2	EAC240AW*, EACW00AW*
BAYHTFAW54A	575/3/60	54	184,300	2	EAC180AW*, EAC210AW*
BAYHTFBW54A	575/3/60	54	184,300	2	EAC240AW*, EACW00AW*
BAYHTFAW72A	575/3/60	72	245,700	2	EAC210AW*
BAYHTFBW72A	575/3/60	72	245,700	2	EAC240AW*, EACW00AW*

Information subject to change. Please confirm with current Product Data for current factory production.

Packaged Heat Pump Convertible 3-10 Tons



Beveled Top
Smoother Design
Small compact cabinet
Recessed access handles

Standard Features:

- American Standard Heating & Air Conditioning scroll compressors on all 3-10 ton units
- ReliaTel™ Controls (See page LPC-13 for ReliaTel™ Control Information)
- Thermal Expansion Valve
- Colored and numbered wiring
- Phase Monitor, R-410A, 3 Phase Units
- Provisions for through the Base Condensate Drain Connections
- Patented Hybrid Condenser Coil for easy cleaning
- 2" throwaway filters provided on 3-10 ton units
- Liquid Line Refrigerant Drier
- Operating Charge of R-410A
- IAQ Sloped Drain Pans
- Single point power for electric Heat
- Low Ambient cooling to 0°F
- Anti-Short Cycle Timer (Standard with ReliaTel™)
- 5 - year Limited Compressor Warranty
- 1 - year Limited Parts Warranty

Added Flexibility

- Convertible airflow
- Fork lift openings on three sides of unit
- Direct or belt drive - standard or oversized motors (Direct for 3-5 ton only)
- We don't prepackage options
- Choose options tailored to suit each job —pay only for what is needed
- Units ship with options installed —and within our standard ship cycle time

Factory Installed Options

- Through-the-Base — Electrical
- Convenience Outlet — Powered or unpowered
- Unit Disconnect Switch
- Circuit Breaker
- Smoke Detectors — Supply, return, or both
- Condenser Coil Coating
- Hinged Access Service Panels
- Discharge Air Sensor
- Fan Fail and Clogged Filter Switches
- Condenser Coil Guard — Hail Protection Quality
- Comm 3/4 Communication Interface
- Froststat
- 2" MERV 8 filters or 2" MERV 13 filters
- Black Epoxy Pre-Coated Coils
- Crankcase Heaters
- Multi-Speed & Single Zone VAV ID Airflow
- Demand Control Ventilation
- Stainless Steel Drainpan
- Condensate Drainpan Overflow Switch

The same American Standard Heating & Air Conditioning Quality and Reliability ... with added Flexibility!

Packaged Heat Pump Convertible 3-10 Tons

Table LPH-2-A — Base Unit — Standard Efficiency — ReliaTel™ Microprocessor Controls

Tons	Unit Ordering No.	Performance ^② SEER/EER	Cooling Capacity (Btuh)	Cabinet Dimensions (in.) H x D x W	Downflow Supply	Downflow Return	Shipping Weight (lbs.)	MCA*	Max ^① Fuse*
WSC – 208-230/1/60 – Single Phase – No Heat									
3	WSC036E1R0A0000	13.0	37,650	36 x 43 x 69	16 x 15.5	24 x 14	589	31.2	45
4	WSC048E1R0A0000	13.0	49,040	36 x 43 x 69	16 x 15.5	24 x 14	600	38.9	60
5	WSC060E1R0A0000	13.0	58,360	41 x 53 x 89	33 x 17.5	32.13 x 17.5	825	44.6	70
WSC – 208-230/3/60 – Three Phase – No Heat									
3	WSC036E3R0A0000	13.0	38,030	36 x 43 x 69	16 x 15.5	24 x 14	589	23.8	35
4	WSC048E3R0A0000	13.0	50,130	36 x 43 x 69	16 x 15.5	24 x 14	600	27.5	40
5	WSC060E3R0A0000	13.0	63,440	41 x 53 x 89	33 x 17.5	32.13 x 17.5	825	30.2	45
6	WSC072E3*0A0000	11.4	78,000	41 x 53 x 89	33 x 17.5	32.13 x 17.5	835	36.3	50
7½	WSC090E3*0A0000	11.1	94,000	47 x 53 x 89	33 x 17.5	32.13 x 17.5	902	38.4	60
10	WSC120E3*0A0000	11.2	126,000	51 x 63 x 100	33 x 17.5	32.25 x 17.5	1388	51.9	60
WSC – 460/3/60 – Three Phase – No Heat									
3	WSC036E4R0A0000	13.0	38,030	36 x 43 x 69	16 x 15.5	24 x 14	589	11.4	15
4	WSC048E4R0A0000	13.0	50,130	36 x 43 x 69	16 x 15.5	24 x 14	600	12.3	15
5	WSC060E4R0A0000	13.0	63,440	41 x 53 x 89	33 x 17.5	32.13 x 17.5	825	14.7	20
6	WSC072E4*0A0000	11.4	78,000	41 x 53 x 89	33 x 17.5	32.13 x 17.5	835	20.3	30
7½	WSC090E4*0A0000	11.1	94,000	47 x 53 x 89	33 x 17.5	32.13 x 17.5	902	19	30
10	WSC120E4*0A0000	11.2	126,000	51 x 63 x 100	33 x 17.5	32.25 x 17.5	1388	26.1	35
WSC – 575/3/60 – Three Phase – No Heat									
3	WSC036EWR0A0000	13.0	38,030	36 x 43 x 69	16 x 15.5	24 x 14	589	8.8	15
4	WSC048EWR0A0000	13.0	50,130	36 x 43 x 69	16 x 15.5	24 x 14	600	9.5	15
5	WSC060EWR0A0000	13.0	63,440	41 x 53 x 89	33 x 17.5	32.13 x 17.5	825	11.0	15
6	WSC072EW0A0000	11.4	78,000	41 x 53 x 89	33 x 17.5	32.13 x 17.5	835	12.4	20
7½	WSC090EW0A0000	11.1	94,000	47 x 53 x 89	33 x 17.5	32.13 x 17.5	902	14.5	20
10	WSC120EW0A0000	11.2	126,000	51 x 63 x 100	33 x 17.5	32.25 x 17.5	1388	21.1	25

* Information subject to change. Please confirm with current Product Data/Service Facts for current factory production.

① HCAR breaker per NEC.

② SEER applies, 3-5 tons; EER applies 6-10 tons.

Light Commercial
Packaged Heat Pumps

Packaged Heat Pump Convertible 3-10 Tons (Model Digit Numbers)

Digit	Description	Order Number	Digit	Description	Order Number
1-8	Main Assembly (see previous page)		21	Communications Options	
9	Unit Controls			No Communications Interface.....	0
	ReliaTel™ Micro-processor.....	R		BACnet™ Communications Interface	6
10	(See Heater Table below)		22	Refrigeration System Option	
11	Minor Design Sequence			Standard Refrigeration System®.....	0
	First Sequence	A	23	Refrigeration Controls	
12-13	Service Sequence			No Refrigeration Control③.....	0
	First Sequence (Factory Assigned).....	*,*		Froststat③.....	1
14	Fresh Air Selection			Crankcase Heater⑩.....	2
	No Fresh Air.....	0		Froststat and Crankcase Heater⑩③.....	3
	Manual Outside Air Damper 0-50%②.....	A	24	Smoke Detector	
	Motorized Outside Air Damper 0-50%②.....	B		No Smoke Detector	0
	Economizer, Dry Bulb 0-100% without			Return Air Smoke Detector⑨.....	A
	Barometric Relief⑤.....	C		Supply Air Smoke Detector.....	B
	Economizer, Dry Bulb 0-100% with			Supply and Return Air Smoke Detectors⑨.....	C
	Barometric Relief⑤.....	D		Plenum Smoke Detector.....	D
	Economizer, Reference Enthalpy 0-100%		25	System Monitoring Controls	
	without Barometric Relief⑤.....	E		No Monitoring Control.....	0
	Economizer, Reference Enthalpy 0-100%			Clogged Filter Switch.....	1
	with Barometric Relief⑤.....	F		Fan Failure Switch	2
	Economizer, Comparative Enthalpy 0-100%			Discharge Air SensingTube	3
	without Barometric Relief⑤.....	G		Clogged Filter Switch and Fan Fail Switch.....	4
	Economizer, Comparative Enthalpy 0-100%			Clogged Filter Switch and Discharge Air	
	with Barometric Relief⑤.....	H		SensingTube	5
15	Supply Fan/Drive Type/Motor			Fan Fail Switch and Discharge Air SensingTube	6
	Standard Drive④.....	0		Clogged Filter and Fan Fail Switches and	
	Oversized Motor	1		Discharge Air SensingTube.....	7
	Optional Belt Drive Motor.....	2		Condensate Drain Pan Overflow Switch	A
	Single Zone Variable Air Volume (SZVAV)	6		Clogged Filter Switch and Condensate Drain	
	Multi-Speed Indoor Fan⑭.....	7		Pan Overflow Switch.....	B
16	Hinged Service Access/Filters			Fan Failure Switch and Condensate Drain	
	Standard Panels/Standard Filters	0		Pan Overflow Switch	C
	Hinged Access Panels/Standard Filters.....	A		Discharge Air Sensing and Condensate Drain	
	Standard Panels/2" MERV 8 Filters	B		Pan Overflow Switch	D
	Hinged Access Panels/2" MERV 8 Filters.....	C		Clogged Filter Switch, Fan Failure Switch and	
	Standard Panels/2" MERV 13 Filters	D		Condensate Drain Pan Overflow Switch	E
	Hinged Access Panels/2" MERV 13 Filters.....	E		Clogged Filter Switch, Discharge Air SensingTube	
17	Condenser Coil Protection			and Condensate Drain Pan Overflow Switch	F
	Standard Coil.....	0		Fan Failure Switch, Discharge Air SensingTube	
	Standard Coil with Hail Guard	1		and Condensate Drain Pan Overflow Switch	G
	Black Epoxy Pre-Coated Condenser Coil	2		Clogged Filter Switch, Fan Failure Switch,	
	Black Epoxy Pre-Coated Condenser Coil			Discharge Air Sensing and Condensate	
	with Hail Guard	3		Drain Pan Overflow Switch	H
18	Through the Base Provisions		26	System Monitoring Controls	
	No Through the Base Provisions	0		No Monitoring Controls.....	0
	Through the Base Electric⑥.....	A		Demand Control Ventilation (CO ₂)⑮.....	A
19	Disconnect/Circuit Breaker (three-phase only)		27	Unit Hardware Enhancements	
	No Disconnect/No Circuit Breaker.....	0		No Enhancements	0
	Unit Mounted Non-Fused Disconnect⑥.....	1		Stainless Steel Drain Pan	1
	Unit Mounted Circuit Breaker⑥.....	2			
20	Convenience Outlet				
	No Convenience Outlet.....	0			
	Unpowered Convenience Outlet	A			
	Powered Convenience Outlet (three-phase only)⑦.....	B			

Light Commercial
Packaged Heat Pumps

① Available on 3-5 ton models.
 ② Manual outside air damper will ship factory supplied within the unit, but must be field installed.
 ③ High pressure control is standard on all units.
 ④ Multispeed direct drive standard on single-phase products. Belt drive standard on three-phase 3-7½ ton. Variable speed direct drive standard on 10 ton.
 ⑤ Economizer with Barometric Relief is for downflow configured units only. Order Economizer without Barometric Relief for horizontal configuration. Barometric Relief for horizontal configured units must be ordered as field installed accessory.
 ⑥ Through the base electric required when ordering disconnect/circuit breaker options.
 ⑦ Requires use of Disconnect or Circuit Breaker.
 ⑧ Standard metering devices are TXVs.
 ⑨ The return air smoke detector may not fit up or work properly on the Precedent units when used in conjunction with 3rd party accessories such as bolt on heat wheels, economizers and power exhaust. Do not order the return air smoke detectors when using this type of accessory.

⑩ Requires hinged access panels.
 ⑪ Crankcase heaters are only available as option on WSC036E, WSC048E1, & WSC060E1. CCH are standard on all other units.
 ⑫ Motorized outside air damper is not available on Multi-Speed or SZVAV (Single Zone Variable Air Volume) products.
 ⑬ Froststat standard on Multi-speed and SZVAV (Single Zone Variable Air Volume) products.
 ⑭ Multi-speed indoor fan only available on 10 ton products.
 ⑮ Demand Control Ventilation Option includes wiring only. The CO₂ sensor is a field-installed only option.

Packaged Heat Pump Convertible 3-10 Tons (Model Digit Numbers)

Heaters (Digit 10)

kW Rating	Digit	Nominal BTUH	No. Stages	Used With	kW Rating	Digit	Nominal BTUH	No. Stages	Used With
208/240/1/60					460/3/60				
3.8/5.0	(A)	12,800/17,100	1	WSC036-060E1	6.0	(B)	20,500	1	WSC036-060E4
7.5/10.0	(D)	25,600/34,100	2	WSC036-060E1	12.0	(E)	41,000	2	WSC036-060E4
10.4/13.8	(F)	35,300/47,100	2	WSC036-060E1	17.4	(G)	59,400	2	WSC036-060E4
13.2/17.6	(G)	45,100/60,100	2	WSC048-060E1	23.0	(J)	78,500	2	WSC060E4
208/240/3/60					9.0 (C) 30,700 1 W*C072-090E4				
4.5/6.0	(B)	13,400/20,500	1	WSC036-060E3	18.0	(G)	61,400	1	W*C072-120E4
9.0/12.0	(E)	30,800/59,400	2	WSC036-060E3	27.0	(K)	92,100	2	W*C072-120E4
13.1/17.4	(G)	44,600/59,400	2	WSC036-060E3	36.0	(N)	122,900	2	W*C072-120E4
17.3/23.0	(J)	58,900/78,500	2	WSC060E3	54.0	(P)	184,300	2	W*C120E4
6.75/9.0	(C)	23,000/30,700	1	W*C072-090E3	575/3/60				
13.5/18.0	(G)	46,100/61,400	1	W*C072-120E3	6.0	(B)	20,500	1	WSC036-060EW
20.3/27.0	(K)	69,000/92,100	2	W*C072-120E3	12.0	(E)	41,000	2	WSC036-060EW
27.0/36.0	(N)	92,200/122,900	2	W*C072-120E3	17.4	(G)	59,400	2	WSC036-060EW
40.5/54.0	(P)	138,200/184,300	2	W*C120E3	23.0	(J)	78,500	2	WSC060EW
					9.0	(C)	30,700	1	W*C072-090EW
					18.0	(G)	61,400	1	W*C072-120EW
					27.0	(K)	92,100	2	W*C072-120EW
					36.0	(N)	122,900	2	W*C072-120EW
					54.0	(P)	184,300	2	W*C120EW

Light Commercial
Packaged Heat Pumps

Packaged Heat Pump Convertible 3-5 Tons, Electric Heaters

Table LPH-5-A — Accessory Electric Heaters – Unit with heater is single circuit / single point power entry

Model Number	Power Supply	kW Rating	Nominal BTUH	No. Stages	Used With
BAYHTRE105A	208-230/1/60	3.8/5.0	12,900/13,400	1	WSC036-048E1
BAYHTRE110A	208-230/1/60	7.5/10.0	25,600/34,000	2	WSC036-048E1
BAYHTRE114A	208-230/1/60	10.4/13.8	35,000/47,100	2	WSC036-048E1
BAYHTRE118A	208-230/1/60	13.2/17.6	45,100/60,100	2	WSC048E1
BAYHTRE306B	208-230/3/60	4.5/6.0	13,400/20,500	1	WSC036-048E3
BAYHTRE312B	208-230/3/60	9.0/12.0	30,800/41,000	2	WSC036-048E3
BAYHTRE318B	208-230/3/60	13.0/17.4	44,600/59,400	2	WSC036-048E3
BAYHTRE406B	460/3/60	6.0	20,500	1	WSC036-048E4
BAYHTRE412B	460/3/60	12.0	41,000	2	WSC036-048E4
BAYHTRE418B	460/3/60	17.4	59,400	2	WSC036-048E4
BAYHTREW06B	575/3/60	6.0	20,500	1	WSC036-048EW
BAYHTREW12B	575/3/60	12.0	41,000	2	WSC036-048EW
BAYHTREW18B	575/3/60	17.4	59,400	2	WSC036-048EW

Table LPH-5-B — Accessory Electric Heaters – Unit with heater is single circuit / single point power entry (5 Ton Only)

Model Number	Power Supply	kW Rating	Nominal BTUH	No. Stages	Used With
BAYHTRX105A	208-230/1/60	3.8/5.0	12,900/13,400	1	WSC060E1
BAYHTRX110A	208-230/1/60	7.5/10.0	25,600/34,000	2	WSC060E1
BAYHTRX114A	208-230/1/60	10.4/13.8	35,000/47,100	2	WSC060E1
BAYHTRX118A	208-230/1/60	13.2/17.6	45,100/60,100	2	WSC060E1
BAYHTRX306B	208-230/3/60	4.5/6.0	13,400/20,500	1	WSC060E3
BAYHTRX312B	208-230/3/60	9.0/12.0	30,800/41,000	2	WSC060E3
BAYHTRX318B	208-230/3/60	13.0/17.4	44,600/59,400	2	WSC060E3
BAYHTRX323B	208-230/3/60	17.3/23.0	59,000/78,500	2	WSC060E3
BAYHTRX406B	460/3/60	6.0	20,500	1	WSC060E4
BAYHTRX412B	460/3/60	12.0	41,000	2	WSC060E4
BAYHTRX418B	460/3/60	18.0	59,400	2	WSC060E4
BAYHTRX423B	460/3/60	23.0	78,500	2	WSC060E4
BAYHTRXW06B	575/3/60	6.0	20,500	1	WSC060EW
BAYHTRXW12B	575/3/60	12.0	41,000	2	WSC060EW
BAYHTRXW18B	575/3/60	18.0	59,400	2	WSC060EW
BAYHTRXW23B	575/3/60	23.0	78,500	2	WSC060EW

Packaged Heat Pump Convertible 6-10 Tons, Electric Heaters and Zone Sensors

Table LPH-6-A — Accessory Electric Heaters – Unit with heater is single circuit / single point power entry

Model Number	Power Supply	kW Rating	Nominal BTUH	No. Stages	Used With
BAYHTRW309A	208-230/3/60	6.8/9.0	23,000/30,700	1	WSC072E3
BAYHTRW318A	208-230/3/60	13.5/18.0	46,100/61,400	1	WSC072E3
BAYHTRW327A	208-230/3/60	20.3/27.0	69,000/92,100	2	WSC072E3
BAYHTRW336A	208-230/3/60	27.0/36.0	92,100/122,900	2	WSC072E3
BAYHTRU309A	208-230/3/60	6.8/9.0	23,000/30,700	1	WSC090E3
BAYHTRU318A	208-230/3/60	13.5/18.0	46,100/61,400	1	WSC090E3
BAYHTRU327A	208-230/3/60	20.3/27.0	69,000/92,100	2	WSC090E3
BAYHTRU336A	208-230/3/60	27.0/36.0	92,100/122,900	2	WSC090E3
BAYHTRB318A	208-230/3/60	13.5/18.0	46,100/61,400	1	WSC120E3
BAYHTRB327A	208-230/3/60	20.3/27.0	69,000/92,100	2	WSC120E3
BAYHTRB336A	208-230/3/60	27.0/36.0	92,100/122,900	2	WSC120E3
BAYHTRB354A	208-230/3/60	40.6/54.0	138,000/184,300	2	WSC120E
BAYHTRW409A	460/3/60	9.0	30,700	1	WSC072E4
BAYHTRW418A	460/3/60	18.0	61,400	1	WSC072E4
BAYHTRW427A	460/3/60	27.0	92,100	2	WSC072E4
BAYHTRW436A	460/3/60	36.0	122,900	2	WSC072E4
BAYHTRU409A	460/3/60	9.0	30,700	1	WSC090E4
BAYHTRU418A	460/3/60	18.0	61,400	1	WSC090E4
BAYHTRU427A	460/3/60	27.0	92,100	2	WSC090E4
BAYHTRU436A	460/3/60	36.0	122,900	2	WSC090E4
BAYHTRB418A	460/3/60	18.0	61,400	1	WSC120E4
BAYHTRB427A	460/3/60	27.0	92,100	2	WSC120E4
BAYHTRB436A	460/3/60	36.0	122,900	2	WSC120E4
BAYHTRB454A	460/3/60	54.0	184,300	2	WSC120E4
BAYHTRWW18A	575/3/60	18.0	61,400	1	WSC072EW
BAYHTRWW27A	575/3/60	27.0	92,100	2	WSC072EW
BAYHTRWW36A	575/3/60	36.0	122,900	2	WSC072EW
BAYHTRUW18A	575/3/60	18.0	61,400	1	WSC090EW
BAYHTRUW27A	575/3/60	27.0	92,100	2	WSC090EW
BAYHTRUW36A	575/3/60	36.0	122,900	2	WSC090EW
BAYHTRBW18A	575/3/60	18.0	61,400	1	WSC120EW
BAYHTRBW36A	575/3/60	36.0	122,900	2	WSC120EW
BAYHTRBW54A	575/3/60	54.0	184,300	2	WSC120EW

Table LPH-6-B — Zone Sensors for ReliaTel™ Controlled Units

Model Number	Description	Used With
BAYMTPL103A	Retrofit Wall Cover Plate Kit 7.25" x 6.0"	ASYSTAT777A
ASYSTAT107A	Single Setpoint Manual Changeover	WSC036-120E
ASYSTAT109A	Dual Setpoint Manual or Auto Changeover	WSC036-120E
ASYSTAT111A	Remote Room Sensor	ASYSTAT777A
ASYSTAT777A	Programmable Night Setback w/System Function Lights (Vertical Style)	WSC036-120E

Packaged Heat Pump Convertible 3-10 Tons Accessories

Table LPH-7-A — Accessories

Model Number	Description	Used With
BAYABRD001C ^④	ReliaTel™ Options Module	All WSC036-120E, See Note ^④
BAYBARM010A ^②	Barometric Relief	WSC036-048E
BAYBARM011A ^②	Barometric Relief	WSC060-120E
BAYBCIR001A	Bacnet™ Communication Interface	ReliaTel™ Controller (BCI-R)
BAYCCHT010B	Crankcase Heater	WSC036E1, E3, WSC048E1
BAYCCHT011B	Crankcase Heater	WSC036E4, EW
BAYCCHT017A	Crankcase Heater	WSC060E1
ASYSTAT712B	CO ₂ Sensor Kit, Wall Mounted	All WSC036-120E
ASYSTAT714B	CO ₂ Sensor Kit, Duct Mounted	All WSC036-120E
BAYCURB042A ^③	Roof Curb	WSC036-048E
BAYCURB043A ^③	Roof Curb	WSC060-090E
BAYCURB044A ^③	Roof Curb	WSC120E
BAYDFPS003B ^④	Clogged Filter Switch (w/Standard & MERV 8 Filter)	All WSC036-120E
BAYDFPS014A ^④	Clogged Filter Switch (MERV 13 Filter)	All WSC036-120E
BAYDFPS004A ^④	Fan Failure Switch	All WSC036-120E
BAYDMPPR053B ^⑥	0-50% Manual Outside Air Damper	WSC036-048E
BAYDMPPR056B ^⑥	0-50% Manual Outside Air Damper	WSC060-120E
BAYDMPPR051A	0-50% Motorized Outside Air Damper	WSC036-048E
BAYDMPPR054A	0-50% Motorized Outside Air Damper	WSC060-120E
BAYECON085A	0-100% Economizer without Barometric Relief	WSC036-048E
BAYECON087A	0-100% Economizer without Barometric Relief	WSC060-120E
BAYENTH005A ^①	Reference Enthalpy Kit	BAYECON085A, 087A
BAYENTH006A ^①	Comparative Enthalpy Kit	BAYECON085A, 087A
BAYFRST003A ^⑤	High Temperature Stat	All WSC036-120E
BAYGARD037B	Condenser Coil Hail Guard	WSC036-048E
BAYGARD040A	Condenser Coil Hail Guard	WSC060E-072E
BAYGARD041A	Condenser Coil Hail Guard	WSC090E
BAYGARD070A	Condenser Coil Hail Guard	WSC120E

① Kits contain all necessary parts to achieve desired level of enthalpy control.

② Barometric Relief accessory installs in ductwork for horizontal configuration. For downflow configuration, installs on the unit's horizontal return duct. Panel see Installer's Guide for complete instructions.

③ Lynn Haven manufacturing has a no return policy for this roof curb.

④ BAYABRD001C is required when ordering field installed accessories Clogged Filter Switch (BAYDFPS003A), Fan Fail Switch (BAYDFPS004A), Discharge Air Sensing Kit (BAYTUBE005A or BAYTUBE007A) or Evaporator Defrost Control (Frostat) (BAYLOAM020B) Ventilation Override Kit (BAYVNOR001B) unless the following options are factory installed: Frostat, Smoke Detector, Clogged Filter Switch, Fan Failure Switch, Discharge Air Sensing Kit. These factory installed options include the ReliaTel™ Options Module.

⑤ Cannot be used in conjunction with factory installed smoke detector.

⑥ The manual outside air damper will ship factory supplied within the unit, but must be field installed.

Packaged Heat Pump Convertible 3-10 Tons Accessories

Table LPH-8-A — Accessories

Model Number	Description	Used With
BAYHSMT403A	2 HP Belt Drive Oversized Motor	WSC072E3, E4
BAYHSMT404A	2 HP Belt Drive Oversized Motor	WSC072EW
BAYHSMT400A	3 HP Belt Drive Oversized Motor	WSC090E3, E4
BAYHSMT401A	3 HP Belt Drive Oversized Motor	WSC090EW
BAYLSDR009A	Low Static Drive	WSC090E*
BAYKSKT255B	Start Kit	WSC036-060E1
BAYPWRX070A	Power Exhaust (208-230/3)	WSC036-060E3
BAYPWRX071A	Power Exhaust (460/3)	WSC036-060E4
BAYPWRX072A	Power Exhaust (575/3)	WSC036-060EW
BAYPWRX026A ^⑥	Power Exhaust (208-230/3)	WSC072-120E3
BAYPWRX027A ^⑥	Power Exhaust (460/3)	WSC072-120E4
BAYPWRX028A ^⑥	Power Exhaust (575/3)	WSC072-120EW
BAYQACB009A ^{②③}	Quick Adapt Roof Curb	WSC036-048E
BAYQACB010A ^{②③}	Quick Adapt Roof Curb	WSC036-048E
BAYQACB011A ^{②⑧}	Quick Adapt Roof Curb	WSC060-090E
BAYQACB012A ^{②⑧}	Quick Adapt Roof Curb	WSC060-090E
BAYQACB013A ^{②⑧}	Quick Adapt Roof Curb	WSC060-090E
BAYQACB111A ^{②③}	Quick Adapt Roof Curb	WSC120E
BAYQACB112A ^{②③}	Quick Adapt Roof Curb	WSC120E
BAYQACB113A ^{②③}	Quick Adapt Roof Curb	WSC120E
BAYRTEM001A ^⑧	Fully Featured ReliaTel™ Economizer Logic Model	WSE036-120E
BAYSENS250A ^{③⑩}	CO ₂ Duct Mounted, Sensor Only	WSC036-120E (ReliaTel™)
BAYSENS251A ^{③⑩}	CO ₂ Wall Mounted, Sensor Only	WSC036-120E (ReliaTel™)
BAYSERV001A	Selective Resistance Service Tester	All WSC036-120E
BAYSTAT023	Remote Potentiometer	All WSC036-120E
BAYTUBE005A ^{①④}	Discharge Air Sensing Kit	WSC036-048E
BAYTUBE007A ^{①④}	Discharge Air Sensing Kit	WSC060-090E
BAYTUBE403A ^{①④}	Discharge Air Sensing Kit	WSC120E
BAYVNOR001B ^{⑨④}	Ventilation Override Kit w/ReliaTel™ options module	All WSC036-120E

- ① Used for true discharge air sensing in both heating and cooling. Required for supply air tempering.
- ② Lynn Haven manufacturing has a no return policy for this roof curb.
- ③ BAYQACB009A adapts WCD models BAYCURB021A roof curb to accept WSC036-048 units. BAYQACB010A adapts WCD models BAYCURB022A roof curb to accept WSC036-048 units. BAYQACB111A adapts WCD models BAYCURB022 roof curb to accept WSC120E. BAYQACB112A adapts WCD models BAYCURB025 roof curb to accept WSC120E. BAYQACB113A adapts WCD models BAYCURB026 roof curb to accept WSC120E.
- ④ BAYABRD001C is required when ordering field installed accessories Clogged Filter Switch (BAYDFPS003A), Fan Fail Switch (BAYDFPS004A), Discharge Air Sensing Kit (BAYTUBE005A or BAYTUBE007A) or Evaporator Defrost Control (Frostat) (BAYLOAM020B) Ventilation Override Kit (BAYVNOR001B) unless the following options are factory installed: Frostat, Smoke Detector, Clogged Filter Switch, Fan Failure Switch, Discharge Air Sensing Kit. These factory installed options include the ReliaTel™ Options Module.
- ⑤ Power Exhaust cannot be used with Barometric Relief. Order Economizer without Barometric Relief.
- ⑥ BAYQACB012A adapts WCD models BAYCURB025 roof curb to accept WSC072-120 units. BAYQACB011A adapts WCD models BAYCURB022B roof curb to accept WSC072-120 units.
- ⑦ BAYQACB013A adapts WCD models BAYCURB026 roof curb to accept WSC060-090E. Field installed accessory. Requires an economizer.
- ⑧ If any version of comparative or reference enthalpy is ordered, BAYRTEM001A does not need to be ordered.

Packaged Heat Pump with ReliaTel™ Controls 12½-20 Tons

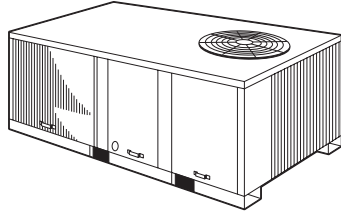

12½ – 20 Ton WSD—Downflow
12½ – 20 Ton WSH—Horizontal

- EER up to 10.6
- ReliaTel™ processor control features are listed on page LPC-13
- Built-in anti-short cycle, time-delay relay and minimum on time controls
- 2" filters for 12½ - 20 ton units
- Liquid line drier
- Built-in fork lift holes
- Operating charge of R-410A
- Quick-Access service panels slide in and out
- Scroll compressors
- Dedicated horizontal and downflow designs
- Single-side access
- Single point power for electric heat
- Complete line of optional electric heaters
- Internally enhanced coil tubing
- Low ambient to 0°F standard
- Colored and numbered wiring
- Common cabinet and accessories Cooling only and Gas/Electric Heat models
- Quick-adjust idler arm pulley
- **5-year limited compressor warranty (12½ – 15 tons)**
- **1-year limited parts warranty (20 tons)**

Table LPH-9-A — Standard — ReliaTel™ Units (R-410A)

Tons	Unit Model No.	Power Supply Volts/Phase/Hz	Performance EER (10)	Cooling Capacity (Btuh)	Dimensions (in.) H x W x L	Shipping Weight (lbs.)	MCA ^⑤	Max Fuse Size or ^④ Max Circuit Breaker	Downflow Roofcurb	
12½	WS*150E3R0A0000	208-230/3/60	10.6	148,000	54 x 85 ⁵ / ₁₆ x 122 ⁵ / ₁₆	2340	68	80	BAYCURB027B	
15	WS*180E3R0A0000	208-230/3/60	10.6	177,000	54 x 85 ⁵ / ₁₆ x 122 ⁵ / ₁₆	2435	74	90	BAYCURB027B	
20	WS*240E3R0A0000	208-230/3/60	9.7	249,000	64 ¹ / ₈ x 85 ⁵ / ₁₆ x 122 ⁵ / ₁₆	2566	116	150	BAYCURB027B	
12½	WS*150E4R0A0000	460/3/60	10.6	148,000	54 x 85 ⁵ / ₁₆ x 122 ⁵ / ₁₆	2340	32	40	BAYCURB027B	
15	WS*180E4R0A0000	460/3/60	10.6	177,000	54 x 85 ⁵ / ₁₆ x 122 ⁵ / ₁₆	2435	36	45	BAYCURB027B	
20	WS*240E4R0A0000	460/3/60	9.7	249,000	64 ¹ / ₈ x 85 ⁵ / ₁₆ x 122 ⁵ / ₁₆	2566	53	60	BAYCURB027B	
12½	WS*150EWR0A0000	575/3/60	10.6	148,000	54 x 85 ⁵ / ₁₆ x 122 ⁵ / ₁₆	2340	25	30	BAYCURB027B	
15	WS*180EWR0A0000	575/3/60	10.6	177,000	54 x 85 ⁵ / ₁₆ x 122 ⁵ / ₁₆	2435	30	35	BAYCURB027B	
20	WS*240EWR0A0000	575/3/60	9.7	249,000	64 ¹ / ₈ x 85 ⁵ / ₁₆ x 122 ⁵ / ₁₆	2566	45	60	BAYCURB027B	
Tons	Supply Downflow W x L ^{①②}	Return Downflow W x L ^{①②}	Supply Horizontal H x W ^{①②}	Return Horizontal H x W ^{①②}	Curb Size H x W x L ^{②③}	Roof Opening W x L ^{①②}				
20	28 ⁹ / ₁₆ x 69 ¹ / ₂	22 ¹ / ₄ x 77	46 ⁷ / ₁₆ x 26 ¹ / ₂	46 ⁷ / ₁₆ x 27 ⁹ / ₁₆	14 ¹ / ₁₆ x 81 x 117 ⁹ / ₁₆	76 ¹ / ₂ x 81				

Table LPH-9-B — Standard — ReliaTel™ Units (R-410A) — Multi-Speed Indoor Fan

Tons	Unit Model No.	Power Supply Volts/Phase/Hz	Performance EER (10)	Cooling Capacity (Btuh)	Dimensions (in.) H x W x L	Shipping Weight (lbs.)	MCA ^⑤	Max Fuse Size or ^④ Max Circuit Breaker	Downflow Roofcurb
12½	WS*150E3R0A1B8B	208-230/3/60	10.6	148,000	54 x 85 ⁵ / ₁₆ x 122 ⁵ / ₁₆	2365	68	80	BAYCURB027B
15	WS*180E3R0A1B8B	208-230/3/60	10.6	177,000	54 x 85 ⁵ / ₁₆ x 122 ⁵ / ₁₆	2460	74	90	BAYCURB027B
20	WS*240E3R0A1B8B	208-230/3/60	9.7	249,000	64 ¹ / ₈ x 85 ⁵ / ₁₆ x 122 ⁵ / ₁₆	2591	116	150	BAYCURB027B
12½	WS*150E4R0A1B8B	460/3/60	10.6	148,000	54 x 85 ⁵ / ₁₆ x 122 ⁵ / ₁₆	2365	32	40	BAYCURB027B
15	WS*180E4R0A1B8B	460/3/60	10.6	177,000	54 x 85 ⁵ / ₁₆ x 122 ⁵ / ₁₆	2460	36	45	BAYCURB027B
20	WS*240E4R0A1B8B	460/3/60	9.7	249,000	64 ¹ / ₈ x 85 ⁵ / ₁₆ x 122 ⁵ / ₁₆	2591	53	60	BAYCURB027B
12½	WS*150EWR0A1B8B	575/3/60	10.6	148,000	54 x 85 ⁵ / ₁₆ x 122 ⁵ / ₁₆	2365	25	30	BAYCURB027B
15	WS*180EWR0A1B8B	575/3/60	10.6	177,000	54 x 85 ⁵ / ₁₆ x 122 ⁵ / ₁₆	2460	30	35	BAYCURB027B
20	WS*240EWR0A1B8B	575/3/60	9.7	249,000	64 ¹ / ₈ x 85 ⁵ / ₁₆ x 122 ⁵ / ₁₆	2591	45	60	BAYCURB027B

① Dimensions are in inches. See Outline Dimensions.

② Interior Dimension.

③ Measurement Includes Curb Flange.

④ HACR type circuit breaker per NEC.

⑤ Information subject to change. Please confirm with current Product Data/Service Facts for current factory production.

* Digit 3 - H = Horizontal or D = Downflow.

Packaged Heat Pump with ReliaTel™ Controls 12½-25 Tons (Model Digit Numbers)

Light Commercial Packaged Heat Pumps

Digit	Description	Order Number	Digit	Description	Order Number
1	Unit Type Packaged Cooling, Electric Heat.....W		19	Disconnect Switch/Circuit Breaker No Disconnect/circuit break..... 0 Unit Mounted Non-Fused Disconnect Switch..... 1 Unit Mounted Circuit Breaker..... 2	
2	Efficiency Standard Efficiency.....S		20	Convenience Outlet Option Without Convenience Outlet..... 0 Unpowered Convenience Outlet..... A Powered Convenience Outlet..... B	
3	Airflow Configuration Downflow.....D Horizontal.....H		21	Communications Options Without Communications Options..... 0 Building Automation Control Network Communications Interface..... 6	
4-6	Nominal Gross Cooling Capacity (MBh) 12½ Tons..... 150 15 Tons..... 180 17½ Tons..... 210 20 Tons..... 240		22	Refrigeration System Option Standard refrigeration system..... 0	
7	Major Design Sequence R-410A Refrigerant.....E		23	Refrigeration Controls Without Refrigeration Controls..... 0 Frostat..... 1	
8	Voltage Selection 208-230/60/3..... 3 460/60/3..... 4 575/60/3.....W		24	Smoke Detector Without Smoke Detector..... 0 Return Air Smoke Detector..... A Supply Air Smoke Detector..... B Return/Supply Air Smoke Detector..... C Plenum Smoke Detector..... D	
9	Unit Controls ReliaTel™.....R		25	System Monitoring Controls No Monitoring Controls..... 0 Clogged Filter Switch..... 1 Fan Failure Switch..... 2 Discharge Air Sensing..... 3 Clogged Filter Switch and Fan Failure..... 4 Clogged Filter Switch and Discharge Air Sensing..... 5 Fan Failure Switch and Discharge Air Sensing..... 6 Clogged Filter Switch, Fan Failure Switch and Discharge Air Sensing..... 7 Condensate Drain Pan Overflow Switch..... A Clogged Filter Switch and Condensate Drain Pan Overflow Switch..... B Fan Failure Switch and Condensate Drain Pan Overflow Switch..... C Discharge Air Sensing and Condensate Drain Pan Overflow Switch..... D Clogged Filter Switch, Fan Failure Switch and Condensate Drain Pan Overflow Switch..... E Clogged Filter Switch, Discharge Air Sensing Tube and Condensate Drain Pan Overflow Switch.... F Fan Failure Switch, Discharge Air Sensing Tube and Condensate Drain Pan Overflow Switch..... G Clogged Filter Switch, Fan Failure Switch, Discharge Air Sensing and Condensate Drain Pan Overflow Switch..... H	
10	Heating Capacity No Heat..... 0 18 kW Electric Heat.....G 36 kW Electric Heat.....N 54 kW Electric Heat.....P 72 kW Electric Heat.....R		26	System Monitoring Controls No Monitoring Controls..... 0 Demand Control Ventilation (CO ₂)Ⓢ..... A	
11	Minor Design Sequence		27	Unit Hardware Enhancements No Enhancements..... 0 Stainless Steel Drain Pan..... 1	
12-13	Service Sequence				
14	Fresh Air Selection No Fresh Air..... 0 Manual Damper.....A Motorized Damper.....B Econ Dry Bulb w/Barometric Relief.....D Econ Reference Enthalpy w/Barometric Relief..... F Econ Comparative Enthalpy w/Barometric Relief..... H				
15	Supply Fan/Drive Type/Motor Standard Motor..... 0 Oversized Motor..... 1 High Efficiency Motor..... 3 Single Zone Variable Air Volume Standard Motor..... 6 Multi-Speed Standard Motor..... 7 Single Zone Variable Air Volume Oversized Motor..... 8 Multi-Speed Oversized Motor..... 9 Single Zone Variable Air Volume Standard Motor w/Shaft Ground Ring..... A Multi-Speed Standard Motor w/Shaft Ground Ring..... B Single Zone Variable Air Volume Oversized Motor w/Shaft Ground Ring..... C Multi-Speed Oversized Motor w/Shaft Ground Ring..... D				
16	Hinged Service Access / Filters Standard Panels/Standard Filters..... 0 Hinged Access/Standard Filters..... A Standard Panels/2" MERV 8 Filters..... B Hinged Access/2" MERV 8 Filters..... C Standard Panels/MERV 13 Filters..... D Hinged Access/MERV 13 Filters..... E				
17	Condenser Coil Protection Standard Coil..... 0 Standard Coil With Hail Guard..... 1 Black Epoxy Pre-Coated Coil..... 2 Black Epoxy Pre-Coated Coil with Hail Guard..... 3				
18	Through The Base Provisions No Through The Base Provisions..... 0 Through The Base Electric..... A Through The Base Access..... D				

Note: Most Factory Installed Options available for Downflow Air Discharge units only. Please verify with ordering system for availability.

Ⓢ Demand Control Ventilation Option includes wiring only. The CO₂ sensor is a field-installed only option.

Packaged Heat Pump with ReliaTel™ Controls 12½-20 Tons Zone Sensors

Table LPH-11-A — Zone Sensors

Model Number	Description	Used With
ASYSTAT107A	Single Setpoint Manual Changeover	WC*150-240
ASYSTAT109A	Dual Setpoint Manual or Automatic Changeover	WC*150-240
ASYSTAT111A	Remote Room Sensor	ASYSTAT777A
ASYSTAT777A	Programmable Night Setback	WC*150-240
BAYMTPL110A	Retrofit Wall Cover Plate Kit 7.25" x 6.0"	ASYSTAT777A

Packaged Heat Pump with ReliaTel™ Controls 12½-20 Tons Accessories

Table LPH-12-A — Field Installed Accessories

Model Number	Description	Used With
BAYABRD002B ^⑥	ReliaTel™ Options Module	All Voyager Heat Pumps
BAYBCIR001A	Bacnet™ Communication Interface	ReliaTel™ Controller (BCI-R)
BAYCO2K002B ^⑦	CO ₂ Sensor Wall Mounted	All Voyager Heat Pumps w/Economizers
BAYCO2K004B ^⑦	CO ₂ Sensor Duct Mounted	All Voyager Heat Pumps w/Economizers
BAYCURB027B ^{③④}	Downflow Only Roof Curb	WSD150E-240E
BAYDFPS005A ^{⑤⑥}	Clogged Filter Switch (MERV 7)	WS*150E-240E
BAYDFPS006A ^{⑤⑥}	Fan Failure Switch	WS*150E-240E
BAYDFPS013A	Clogged Filter Switch (MERV 13)	WS*150E-240E
BAYDMPR029C	0-25% Manual Outside Air Damper	All Packaged Rooftops 12½-20 Tons
BAYDMPR058A	0-50% Motorized Outside Air Damper	WS*150E-240E
BAYECON090A ^⑥	Downflow Economizer with Barometric Relief	WSD150E-240E
BAYECON092A	Horizontal Economizer	WSH150E-240E
BAYENTH007A	Reference Enthalpy Kit	All BAYECON089-92A
BAYENTH008A	Comparative Enthalpy Kit	All BAYECON089-92A
BAYFRST003A	High Temperature Stat	WS*150E-240E
BAYGARD045A ^⑥	Tool-less Hail Guard	WS*150E, WS*180E
BAYGARD050A ^⑥	Tool-less Hail Guard	WS*240E
BAYHSDR005B ^①	High Static Drive	WS*150E-240E
BAYHSMT055B	5HP OVERSIZED MOTOR KIT (208-230/460)	WS*150E, WS*180E
BAYHSMT072A	5HP OVERSIZED MOTOR KIT (575)	WS*150E, WS*180E
BAYHSMT100A	7.5HP OVERSIZED MOTOR KIT (208-230)	WS*240E
BAYHSMT101A	7.5HP OVERSIZED MOTOR KIT (460)	WS*240E
BAYHSMT102A	7.5HP OVERSIZED MOTOR KIT (575)	WS*240E
BAYLOAM023A ^{⑤⑥}	Evaporator Defrost Control (Frostat)	WS*150E, WS*180E
BAYLOAM031A	Evaporator Defrost Control	WS*240E
BAYLSDR004A	Low Static Drive	WS*240E
BAYLSDR011A	Low Static Drive	WS*150E, WS*180E
BAYPWRX029A	Power Exhaust for all Voyagers 12½-20 Ton 230V units	Downflow Only
BAYPWRX030A	Power Exhaust for all Voyagers 12½-20 Ton 460V units	Downflow Only
BAYPWRX031A	Power Exhaust for all Voyagers 12½-20 Ton 575V units	Downflow Only
BAYQACB044A	Adapter Curb	BAYCURB026A/B to BAYCURB027A/B
BAYSERV001A	Selective Resistance Service Tester	All Voyagers 12½-20 Tons
BAYSTAT023	Remote Potentiometer	All BAYECON089-92A
BAYTUBE008A ^{②⑤⑥}	Discharge Air Sensing Kit	All Voyagers 12½-20 Tons Downflow
BAYTUBE009A ^{②⑤⑥}	Discharge Air Sensing Kit	All Voyagers 12½-20 Tons Horizontal
BAYVNOR002B ^⑤	Ventilation Override Kit	WS*150-240E w/ReliaTel™ Options Module

① High static drive and oversized motors are mutually exclusive. Do not Combine.

② Used for true discharge air sensing in both heating and cooling models.

③ Clarksville Manufacturing has a no-return policy for this roof curb.

④ For downflow use only. Can not be adapted for horizontal units.

⑤ BAYABRD002B is required when ordering field installed accessories BAYDFPS005A or 006A, BAYTUBE008A or 009A and BAYLOAM023A, BAYLOAM031A or BAYVNOR002B.

⑥ Field or factory installed option.

⑦ Field installed accessory. Requires an economizer.

* Information subject to change. Please confirm with current Product Data/Service Facts for current factory production.

Packaged Heat Pump with ReliaTel™ Controls 12½-20 Tons Heaters

Table LPH-13-A — Downflow Supplementary Heaters:

Model Number	Power Supply	kW Rating	BTUH	Nominal Stages	Used With
AYDHTRK318A	208-230/3/60	13.5/18.0	46,100/61,400	1	WSD150-180E
AYDHTRK336A	208-230/3/60	27.0/36.0	92,200/122,900	2	WSD150-180E
AYDHTRK354A	208-230/3/60	40.5/54.0	138,200/184,300	2	WSD150-180E
AYDHTRK418A	460/3/60	18.0	61,400	1	WSD150-180E
AYDHTRK436A	460/3/60	36.0	122,900	2	WSD150-180E
AYDHTRK454A	460/3/60	54.0	184,300	2	WSD150-180E
AYDHTRL336A	208-230/3/60	27.0/36.0	92,200/122,900	2	WSD240E
AYDHTRL354A	208-230/3/60	40.5/54.0	138,200/184,300	2	WSD240E
AYDHTRK372A	208-230/3/60	54.0/72.0	184,300/245,700	2	WSD240E
AYDHTRL436A	460/3/60	36.0	122,900	2	WSD240E
AYDHTRL454A	460/3/60	54.0	184,300	2	WSD240E
AYDHTRK472A	460/3/60	72.0	245,700	2	WSD240E
AYDHTRKW18A	575/3/60	18.0	61,400	1	WSD150-180E
AYDHTRKW36A	575/3/60	36.0	122,900	2	WSD150-180E
AYDHTRKW54A	575/3/60	54.0	184,300	2	WSD150-180E
AYDHTRLW36A	575/3/60	36.0	122,900	2	WSD240E
AYDHTRLW54A	575/3/60	54.0	184,300	2	WSD240E
AYDHTRKW72A	575/3/60	72.0	245,700	2	WSD240E

Table LPH-13-B — Horizontal Supplementary Heaters:

AYHHTRM318A	208-230/3/60	13.5/18.0	46,100/61,400	1	WSH150-180E
AYHHTRM336A	208-230/3/60	27.0/36.0	92,200/122,900	2	WSH150-180E
AYHHTRM354A	208-230/3/60	40.5/54.0	138,200/184,300	2	WSH150-180E
AYHHTRM418A	460/3/60	18.0	61,400	1	WSH150-180E
AYHHTRP436A	460/3/60	36.0	122,900	2	WSH150-180E
AYHHTRM454A	460/3/60	54.0	184,300	2	WSH150-180E
AYHHTRN336A	208-230/3/60	27.0/36.0	92,200/122,900	2	WSH240E
AYHHTRN354A	208-230/3/60	40.5/54.0	138,200/184,300	2	WSH240E
AYHHTRN372A	208-230/3/60	54.0/72.0	184,300/245,700	2	WSH240E
AYHHTRN436A	460/3/60	36.0	122,900	2	WSH240E
AYHHTRN454A	460/3/60	54.0	184,300	2	WSH240E
AYHHTRN472A	460/3/60	72.0	245,700	2	WSH240E
AYHHTRMW18A	575/3/60	18.0	61,400	1	WSH150-180E
AYHHTRMW36A	575/3/60	36.0	122,900	2	WSH150-180E
AYHHTRMW54A	575/3/60	54.0	184,300	2	WSH150-180E
AYHHTRNW36A	575/3/60	36.0	122,900	2	WSH240E
AYHHTRNW54A	575/3/60	54.0	184,300	2	WSH240E
AYHHTRNW72A	575/3/60	72.0	245,700	2	WSH240E

Note: Unit with heater is single circuit/single point.

See ReliaTel™ and Micro Control features on LPC-13 and LPC-14.

Packaged Gas/Electric Convertible 3-10 Tons



Beveled Top
Smoother Design
Small compact cabinet
Recessed access handles

Standard Features:

- American Standard Heating & Air Conditioning scroll compressors on all 3-10 ton units
- Colored and numbered wiring
- Phase Monitor, R-410A, 3 Phase Units
- Provisions for through the Base Gas and Condensate Drain Connections
- 2" throwaway filters provided on all units
- Liquid Line Refrigerant Drier
- Operating Charge of R-410A
- IAQ Sloped Drain Pans
- Low Ambient to 40°F on Electromechanical models
- Low Ambient to 0°F on ReliaTel™ models
- 5 - year Limited Compressor Warranty
- 5 - year Limited Heat Exchanger Warranty
- 1 - year Limited Parts Warranty

Added Flexibility

- Electromechanical or ReliaTel™ controls (**See page LPC-13 for ReliaTel™ Control Information**)
- Standard or high efficiency cooling models available. 17+ available in 3T to 5T. For reference to 17+ please refer to publications RT-PRC048-EN and RT-SLB020-EN.
- Low, medium or high heat, single or two stage
- Convertible airflow
- Fork lift openings on three sides of unit
- Direct or belt drive - standard or oversized motors
- We don't prepackage options
- Choose options tailored to suit each job —pay only for what is needed
- Units ship with options installed —and within our standard ship cycle time

Factory Installed Options

- Through-the-Base — Electrical
- Convenience Outlet — Powered or unpowered
- Unit Disconnect Switch
- Circuit Breaker
- Smoke Detectors — Supply, return, or both
- Condenser Coil Coating
- Hinged Access Service Panels
- Discharge Air Sensor
- Fan Fail and Clogged Filter Switches
- Condenser Coil Guard — Hail Protection Quality
- Hot Gas Reheat Coil - Dehumidification
- Expansion valve and split face evaporator coil
- Novar Controls
- Comm 3/4 Communications Interface
- 2" Pleated Media filters (MERV 8 & 13)
- Froststat
- Multi-Speed & Single Zone VAV ID Airflow
- Demand Control Ventilation
- Stainless Steel Drainpan
- Condensate Drainpan Overflow Switch

The same American Standard Heating & Air Conditioning Quality and Reliability ... with added Flexibility!

Packaged Gas/Electric Convertible 6-10 Tons, R-410A

Table LPG-2-A — 17 Plus - R-410A - ReliaTel™ Controls Only

Tons	Unit Ordering No.	Performance ^② EER	Heating Output ^①			Cabinet Dimensions (in.) H x W x L	Downflow Supply	Downflow Return	Shipping Weight (lbs.)	MCA**	Max. Fuse**
			Cooling Capacity (Btuh)	Capacity (Btuh)	AFUE%						
YHC - 208-230/3/60 - Three Phase - Low Heat											
3	YHC037E3RLA0000	17.5	36,500	48,000	78	36 x 44 x 69	18 x 15.5	24 x 14	676	23.3	30
4	YHC047E3RLA0000	17.5	50,500	49,000	80	41 x 53 x 88	33 x 17.5	33 x 17.5	858	29.4	40
5	YHC067E3RLA0000	17.2	60,000	49,000	80	41 x 53 x 88	33 x 17.5	33 x 17.5	917	32.2	45
YHC - 460/3/60 - Three Phase - Low Heat											
3	YHC037E4RLA0000	17.5	36,500	48,000	78	36 x 44 x 69	18 x 15.5	24 x 14	676	11.4	15
4	YHC047E4RLA0000	17.5	50,500	49,000	80	41 x 53 x 88	33 x 17.5	33 x 17.5	858	13.7	20
5	YHC067E4RLA0000	17.2	60,000	49,000	80	41 x 53 x 88	33 x 17.5	33 x 17.5	917	15.2	20
YHC - 208-230/3/60 - Three Phase - Medium Heat											
3	YHC037E3RMA0000	17.5	36,500	64,000	78	36 x 44 x 69	18 x 15.5	24 x 14	676	23.3	30
4	YHC047E3RMA0000	17.5	50,500	64,000	79	41 x 53 x 88	33 x 17.5	33 x 17.5	858	29.4	40
5	YHC067E3RMA0000	17.2	60,000	64,000	79	41 x 53 x 88	33 x 17.5	33 x 17.5	917	32.2	45
YHC - 460/3/60 - Three Phase - Medium Heat											
3	YHC037E4RMA0000	17.5	36,500	64,000	78	36 x 44 x 69	18 x 15.5	24 x 14	676	11.4	15
4	YHC047E4RMA0000	17.5	50,500	64,000	79	41 x 53 x 88	33 x 17.5	33 x 17.5	858	13.7	20
5	YHC067E4RMA0000	17.2	60,000	64,000	79	41 x 53 x 88	33 x 17.5	33 x 17.5	917	15.2	20
YHC - 208-230/3/60 - Three Phase - High Heat											
3	YHC037E3RHA0000	17.5	36,500	80,000	78	36 x 44 x 69	18 x 15.5	24 x 14	676	23.3	30
4	YHC047E3RHA0000	17.5	50,500	96,000	79	41 x 53 x 88	33 x 17.5	33 x 17.5	858	29.4	40
5	YHC067E3RHA0000	17.2	60,000	104,000	80	41 x 53 x 88	33 x 17.5	33 x 17.5	917	32.2	45
YHC - 460/3/60 - Three Phase - High Heat											
3	YHC037E4RHA0000	17.5	36,500	80,000	78	36 x 44 x 69	18 x 15.5	24 x 14	676	11.4	15
4	YHC047E4RHA0000	17.5	50,500	96,000	79	41 x 53 x 88	33 x 17.5	33 x 17.5	858	13.7	20
5	YHC067E4RHA0000	17.2	60,000	104,000	80	41 x 53 x 88	33 x 17.5	33 x 17.5	917	15.2	20

① Downflow Airflow/Horizontal Airflow

② SEER applies, 3-5 tons; EER applies 6-10 tons.

** Information subject to change. Please confirm with current Product Data/Service Facts for current factory production.

Light Commercial
Packaged Gas/Electric

Packaged Gas/Electric Convertible 3-5 Tons, 15 SEER, R-410A

Table LPG-3-A — Base Unit — 15 SEER High Efficiency — Electromechanical or ReliaTel™

Tons	Unit Ordering No.	Performance ^② SEER/EER	Cooling Capacity (Btuh)	Heating Output ^①		Cabinet Dimensions (in.) H x W x L	Downflow Supply	Downflow Return	Shipping Weight (lbs.)	MCA**	Max. Fuse**
				Capacity (Btuh)	AFUE%						
YHC - 208-230/1/60 - Single Phase - Low Heat											
3	YHC036E1*LA0000	15.2	38,490	48,000	78	36 x 43 x 69	16 x 15.5	24 x 14	555	26.7	40
4	YHC048F1*LA0000	15.0	48,930	48,000	80	42 x 53 x 88	33 x 17.5	32.2 x 17.5	798	35.7	50
5	YHC060F1*LA0000	15.0	62,490	48,000	80	42 x 53 x 88	33 x 17.5	32.2 x 17.5	823	43.8	70
YHC - 208-230/3/60 - Three Phase - Low Heat											
3	YHC036E3*LA0000	15.0	38,490	48,000	78	36 x 43 x 69	16 x 15.5	24 x 14	637	21.9	30
4	YHC048F3*LA0000	15.0	49,930	48,000	80	42 x 53 x 88	33 x 17.5	32.2 x 17.5	869	28.3	40
5	YHC060F3*LA0000	15.0	63,490	48,000	80	42 x 53 x 88	33 x 17.5	32.2 x 17.5	894	32.1	45
YHC - 460/3/60 - Three Phase - Low Heat											
3	YHC036E4*LA0000	15.0	38,490	48,000	78	36 x 43 x 69	16 x 15.5	24 x 14	637	10.2	15
4	YHC048F4*LA0000	15.0	49,930	48,000	80	42 x 53 x 88	33 x 17.5	32.2 x 17.5	869	13.8	20
5	YHC060F4*LA0000	15.0	63,490	48,000	80	42 x 53 x 88	33 x 17.5	32.2 x 17.5	894	17.0	25
YHC - 208-230/1/60 - Single Phase - Medium Heat											
3	YHC036E1*MA0000	15.2	38,490	65,000	78	36 x 43 x 69	16 x 15.5	24 x 14	637	26.7	40
4	YHC048F1*MA0000	15.0	48,930	64,000	79	42 x 53 x 88	33 x 17.5	32.2 x 17.5	869	35.7	50
5	YHC060F1*MA0000	15.0	62,490	64,000	79	42 x 53 x 88	33 x 17.5	32.2 x 17.5	894	43.8	70
YHC - 208-230/3/60 - Three Phase - Medium Heat											
3	YHC036E3*MA0000	15.0	38,490	64,000	78	36 x 43 x 69	16 x 15.5	24 x 14	637	21.9	30
4	YHC048F3*MA0000	15.0	49,930	64,000	79	42 x 53 x 88	33 x 17.5	32.2 x 17.5	869	28.3	40
5	YHC060F3*MA0000	15.0	63,490	64,000	79	42 x 53 x 88	33 x 17.5	32.2 x 17.5	894	32.1	45
YHC - 460/3/60 - Three Phase - Medium Heat											
3	YHC036E4*MA0000	15.0	38,490	64,000	78	36 x 43 x 69	16 x 15.5	24 x 14	637	10.2	15
4	YHC048F4*MA0000	15.0	49,930	64,000	79	42 x 53 x 88	33 x 17.5	32.2 x 17.5	869	13.8	20
5	YHC060F4*MA0000	15.0	63,490	64,000	79	42 x 53 x 88	33 x 17.5	32.2 x 17.5	894	17.0	25
YHC - 208-230/1/60 - Single Phase - High Heat											
3	YHC036E1*HA0000	15.2	38,490	96,000	78	36 x 43 x 69	16 x 15.5	24 x 14	637	26.7	40
4	YHC048F1*HA0000	15.0	48,930	96,000	79	42 x 53 x 88	33 x 17.5	32.2 x 17.5	869	35.7	50
5	YHC060F1*HA0000	15.0	62,490	104,000	80	42 x 53 x 88	33 x 17.5	32.2 x 17.5	894	43.8	70
YHC - 208-230/3/60 - Three Phase - High Heat											
3	YHC036E3*HA0000	15.0	38,490	96,000	78	36 x 43 x 69	16 x 15.5	24 x 14	637	21.9	30
4	YHC048F3*HA0000	15.0	49,930	96,000	79	42 x 53 x 88	33 x 17.5	32.2 x 17.5	869	28.3	40
5	YHC060F3*HA0000	15.0	63,490	104,000	80	42 x 53 x 88	33 x 17.5	32.2 x 17.5	894	32.1	45
YHC - 460/3/60 - Three Phase - High Heat											
3	YHC036E4*HA0000	15.0	38,490	96,000	78	36 x 43 x 69	16 x 15.5	24 x 14	637	10.2	15
4	YHC048F4*HA0000	15.0	49,930	96,000	79	42 x 53 x 88	33 x 17.5	32.2 x 17.5	869	13.8	20
5	YHC060F4*HA0000	15.0	63,490	104,000	80	42 x 53 x 88	33 x 17.5	32.2 x 17.5	894	17.0	25

① Downflow Airflow/Horizontal Airflow

② SEER applies, 3-5 tons; EER applies 6-10 tons.

* Digit 9-E=Electromechanical or R=ReliaTel™.

** Information subject to change. Please confirm with current Product Data/Service Facts for current factory production.

Packaged Gas/Electric Convertible 3-5 Tons, 13 SEER, R-410A

Table LPG-4-A — Base Unit — 13 SEER — Electromechanical or ReliaTel™

Tons	Unit Ordering No.	Performance ^② SEER/EER	Cooling Capacity (Btuh)	Heating Output ^①		Cabinet Dimensions (in.) H x W x L	Downflow Supply	Downflow Return	Shipping Weight (lbs.)	MCA**	Max. Fuse**
				Capacity (Btuh)	AFUE%						
YSC –208-230/1/60 – Single Phase – Low Heat											
3	YSC036E1*LA0000	13.0	35,620	48,000	80	36 x 43 x 69	18 x 15.5	12 x 14	607	27.2	40
4	YSC048E1*LA0000	13.0	49,210	48,000	80	36 x 43 x 69	18 x 15.5	12 x 14	638	35.2	50
5	YSC060E1*LA0000	13.0	59,900	48,000	80	36 x 43 x 69	18 x 15.5	12 x 14	688	43.8	70
YSC –208-230/3/60 – Three Phase – Low Heat											
3	YSC036E3*LA0000	13.0	37,150	48,000	80	36 x 43 x 69	18 x 15.5	12 x 14	607	23.0	35
4	YSC048E3*LA0000	13.0	49,450	48,000	80	36 x 43 x 69	18 x 15.5	12 x 14	638	25.2	35
5	YSC060E3*LA0000	13.0	62,270	48,000	80	36 x 43 x 69	18 x 15.5	12 x 14	688	29.5	45
YSC –460/3/60 – Three Phase – Low Heat											
3	YSC036E4*LA0000	13.0	37,150	48,000	80	36 x 43 x 69	18 x 15.5	12 x 14	607	11.7	15
4	YSC048E4*LA0000	13.0	49,450	48,000	80	36 x 43 x 69	18 x 15.5	12 x 14	638	12.5	15
5	YSC060E4*LA0000	13.0	62,270	48,000	80	36 x 43 x 69	18 x 15.5	12 x 14	688	15.5	25
YSC –575/3/60 – Three Phase – Low Heat											
3	YSC036EW*LA0000	13.0	37,150	48,000	80	36 x 43 x 69	18 x 15.5	12 x 14	607	9.4	15
4	YSC048EW*LA0000	13.0	49,450	48,000	80	36 x 43 x 69	18 x 15.5	12 x 14	638	9.0	15
5	YSC060EW*LA0000	13.0	62,270	48,000	80	36 x 43 x 69	18 x 15.5	12 x 14	688	10.1	15
YSC –208-230/1/60 – Single Phase – Medium Heat											
3	YSC036E1*MA0000	13.0	35,620	64,000	80	36 x 43 x 69	18 x 15.5	12 x 14	607	27.2	40
4	YSC048E1*MA0000	13.0	49,210	64,000	80	36 x 43 x 69	18 x 15.5	12 x 14	638	35.2	50
5	YSC060E1*MA0000	13.0	59,900	64,000	80	36 x 43 x 69	18 x 15.5	12 x 14	688	43.8	70
YSC –208-230/3/60 – Three Phase – Medium Heat											
3	YSC036E3*MA0000	13.0	37,150	64,000	81	36 x 43 x 69	18 x 15.5	12 x 14	607	23.0	35
4	YSC048E3*MA0000	13.0	49,450	64,000	81	36 x 43 x 69	18 x 15.5	12 x 14	638	25.2	35
5	YSC060E3*MA0000	13.0	62,270	64,000	81	36 x 43 x 69	18 x 15.5	12 x 14	688	29.5	45
YSC –460/3/60 – Three Phase – Medium Heat											
3	YSC036E4*MA0000	13.0	37,150	64,000	80	36 x 43 x 69	18 x 15.5	12 x 14	607	11.7	15
4	YSC048E4*MA0000	13.0	49,450	64,000	80	36 x 43 x 69	18 x 15.5	12 x 14	638	12.5	15
5	YSC060E4*MA0000	13.0	62,270	64,000	80	36 x 43 x 69	18 x 15.5	12 x 14	688	15.5	25
YSC –575/3/60 – Three Phase – Medium Heat											
3	YSC036EW*MA0000	13.0	37,150	64,000	80	36 x 43 x 69	18 x 15.5	12 x 14	607	9.4	15
4	YSC048EW*MA0000	13.0	49,450	64,000	80	36 x 43 x 69	18 x 15.5	12 x 14	638	9.0	15
5	YSC060EW*MA0000	13.0	62,270	64,000	80	36 x 43 x 69	18 x 15.5	12 x 14	688	10.1	15
YSC –208-230/1/60 – Single Phase – High Heat											
3	YSC036E1*HA0000	13.0	35,620	96,000	80	36 x 43 x 69	18 x 15.5	12 x 14	607	27.2	40
4	YSC048E1*HA0000	13.0	49,210	96,000	80	36 x 43 x 69	18 x 15.5	12 x 14	638	35.2	50
5	YSC060E1*HA0000	13.0	59,900	104,000	80	36 x 43 x 69	18 x 15.5	12 x 14	688	43.8	70
YSC –208-230/3/60 – Three Phase – High Heat											
3	YSC036E3*HA0000	13.0	37,150	96,000	80	36 x 43 x 69	18 x 15.5	12 x 14	607	23.0	35
4	YSC048E3*HA0000	13.0	49,450	96,000	80	36 x 43 x 69	18 x 15.5	12 x 14	638	25.2	35
5	YSC060E3*HA0000	13.0	62,270	104,000	80	36 x 43 x 69	18 x 15.5	12 x 14	688	29.5	45
YSC –460/3/60 – Three Phase – High Heat											
3	YSC036E4*HA0000	13.0	37,150	96,000	80	36 x 43 x 69	18 x 15.5	12 x 14	607	11.7	15
4	YSC048E4*HA0000	13.0	49,450	96,000	80	36 x 43 x 69	18 x 15.5	12 x 14	638	12.5	15
5	YSC060E4*HA0000	13.0	62,270	104,000	80	36 x 43 x 69	18 x 15.5	12 x 14	688	15.5	25
YSC –575/3/60 – Three Phase – High Heat											
3	YSC036EW*HA0000	13.0	37,150	96,000	80	36 x 43 x 69	18 x 15.5	12 x 14	607	9.4	15
4	YSC048EW*HA0000	13.0	49,450	96,000	80	36 x 43 x 69	18 x 15.5	12 x 14	638	9.0	15
5	YSC060EW*HA0000	13.0	62,270	104,000	80	36 x 43 x 69	18 x 15.5	12 x 14	688	10.1	15

① Downflow Airflow/Horizontal Airflow

② SEER applies, 3-5 tons; EER applies 6-10 tons.

* Digit 9-E=Electromechanical or R=ReliaTel™.

** Information subject to change. Please confirm with current Product Data/Service Facts for current factory production.

Light Commercial
Packaged Gas/Electric

Packaged Gas/Electric Convertible 6-10 Tons, High Efficiency, R-410A

Table LPG-5-A — Base Unit — High Efficiency — Electromechanical or ReliaTel™

Tons	Unit Ordering No.	Performance ^② EER	Cooling Capacity (Btuh)	Heating Output ^①		Cabinet Dimensions (in.) H x W x L	Downflow Supply	Downflow Return	Shipping Weight (lbs.)	MCA**	Max. Fuse**
				Capacity (Btuh)	AFUE%						
YHC -208-230/3/60 – Three Phase – Low Heat											
6	YHC072F3*LA0000	12.6	72,000	64,800	80	47 x 53 x 88	33 x 17.5	32.13 x 17.5	997	33.9	50
7½	YHC092F3*LA0000	12.6	92,000	96,000	80	47 x 53 x 88	33 x 17.5	32.13 x 17.5	1124	41.9	50
8½	YHC102F3*LA0000	12.5	103,000	96,000	80	47 x 53 x 88	33 x 17.5	32.13 x 17.5	1124	42	50
10	YHC120E3*LA0000	12.5	119,000	120,000*	80	51 x 63 x 100	32.25 x 19.25	32.25 x 16.75	1563	50.3	60
YHC -460/3/60 – Three Phase – Low Heat											
6	YHC072F4*LA0000	12.6	72,000	64,800	80	47 x 53 x 88	33 x 17.5	32.13 x 17.5	997	16.3	25
7½	YHC092F4*LA0000	12.6	92,000	96,000	80	47 x 53 x 88	33 x 17.5	32.13 x 17.5	1124	19.9	25
8½	YHC102F4*LA0000	12.5	103,000	96,000	80	47 x 53 x 88	33 x 17.5	32.13 x 17.5	1124	19.9	25
10	YHC120E4*LA0000	12.5	119,000	120,000*	80	51 x 63 x 100	32.25 x 19.25	32.25 x 16.75	1563	24.9	30
YHC -208-230/3/60 – Three Phase – Medium Heat											
6	YHC072F3*MA0000	12.6	72,000	96,000	80	47 x 53 x 88	33 x 17.5	32.13 x 17.5	997	33.9	50
7½	YHC092F3*MA0000	12.6	92,000	120,000*	80	47 x 53 x 88	33 x 17.5	32.13 x 17.5	1124	41.9	50
8½	YHC102F3*MA0000	12.5	103,000	120,000*	80	47 x 53 x 88	33 x 17.5	32.13 x 17.5	1124	42	50
10	YHC120E3*MA0000	12.5	119,000	160,000*	80	51 x 63 x 100	32.25 x 19.25	32.25 x 16.75	1563	50.3	60
YHC -460/3/60 – Three Phase – Medium Heat											
6	YHC072F4*MA0000	12.6	72,000	96,000	80	47 x 53 x 88	33 x 17.5	32.13 x 17.5	997	16.3	25
7½	YHC092F4*MA0000	12.6	92,000	120,000*	80	47 x 53 x 88	33 x 17.5	32.13 x 17.5	1124	19.9	25
8½	YHC102F4*MA0000	12.5	103,000	120,000*	80	47 x 53 x 88	33 x 17.5	32.13 x 17.5	1124	19.9	25
10	YHC120E4*MA0000	12.5	119,000	160,000*	80	51 x 63 x 100	32.25 x 19.25	32.25 x 16.75	1563	24.9	30
YHC -208-230/3/60 – Three Phase – High Heat											
6	YHC072F3*HA0000	12.6	72,000	120,000*	80	47 x 53 x 88	33 x 17.5	32.13 x 17.5	997	33.9	50
7½	YHC092F3*HA0000	12.6	92,000	160,000*	80	47 x 53 x 88	33 x 17.5	32.13 x 17.5	1124	41.9	50
8½	YHC102F3*HA0000	12.5	103,000	160,000*	80	47 x 53 x 88	33 x 17.5	32.13 x 17.5	1124	42	50
10	YHC120E3*HA0000	12.5	119,000	200,000*	80	51 x 63 x 100	32.25 x 19.25	32.25 x 16.75	1563	50.3	60
YHC -460/3/60 – Three Phase – High Heat											
6	YHC072F4*HA0000	12.6	72,000	120,000*	80	47 x 53 x 88	33 x 17.5	32.13 x 17.5	997	16.3	25
7½	YHC092F4*HA0000	12.6	92,000	160,000*	80	47 x 53 x 88	33 x 17.5	32.13 x 17.5	1124	19.9	25
8½	YHC102F4*HA0000	12.5	103,000	160,000*	80	47 x 53 x 88	33 x 17.5	32.13 x 17.5	1124	19.9	25
10	YHC120E4*HA0000	12.5	119,000	200,000*	80	51 x 63 x 100	32.25 x 19.25	32.25 x 16.75	1563	24.9	30

① Downflow Airflow/Horizontal Airflow

② SEER applies, 3-5 tons; EER applies 6-10 tons.

* Digit 9-E=Electromechanical or R=ReliaTel™.

** Information subject to change. Please confirm with current Product Data/Service Facts for current factory production.

Packaged Gas/Electric Convertible 6-10 Tons, R-410A

Table LPG-6-A — Base Unit — Standard Efficiency — Electromechanical or ReliaTel™

Tons	Unit Ordering No.	Performance ^② EER	Heating Output ^①			Cabinet Dimensions (in.) H x W x L	Downflow Supply	Downflow Return	Shipping Weight (lbs.)	MCA**	Max. Fuse**
			Cooling Capacity (Btuh)	Capacity (Btuh)	AFUE%						
YSC -208-230/3/60 – Three Phase – Low Heat											
6	YSC072F3*LA0000	11.2	75,000	64,800	80	41 x 53 x 89	33 x 17.5	32.13 x 17.5	936	36.5	50
7½	YSC090F3*LA0000	11.2	89,000	120,000	80	41 x 53 x 89	33 x 17.5	32.13 x 17.5	916	38.2	60
7½	YSC092F3*LA0000	11.2	94,000	97,200	80	47 x 53 x 89	33 x 17.5	32.13 x 17.5	1059	41.2	50
8½	YSC102F3*LA0000	11.2	102,000	97,200	80	47 x 53 x 89	33 x 17.5	32.13 x 17.5	1096	46.3	60
10	YSC120F3*LA0000	11.3	118,000	121,500	80	47 x 53 x 89	33 x 17.5	32.13 x 17.5	1156	49.6	60
YSC -460/3/60 – Three Phase – Low Heat											
6	YSC072F4*LA0000	11.2	75,000	64,800	80	41 x 53 x 89	33 x 17.5	32.13 x 17.5	936	18.2	25
7½	YSC090F4*LA0000	11.2	89,000	120,000	80	41 x 53 x 89	33 x 17.5	32.13 x 17.5	916	19.5	30
7½	YSC092F4*LA0000	11.2	94,000	97,200	80	47 x 53 x 89	33 x 17.5	32.13 x 17.5	1059	21.5	25
8½	YSC102F4*LA0000	11.2	102,000	97,200	80	47 x 53 x 89	33 x 17.5	32.13 x 17.5	1096	21.9	25
10	YSC120F4*LA0000	11.3	118,000	121,500	80	47 x 53 x 89	33 x 17.5	32.13 x 17.5	1156	22.7	35
YSC -575/3/60 – Three Phase – Low Heat											
6	YSC072FW*LA0000	11.2	75,000	64,800	80	41 x 53 x 89	33 x 17.5	32.13 x 17.5	936	12.7	20
7½	YSC090FW*LA0000	11.2	89,000	120,000	80	41 x 53 x 89	33 x 17.5	32.13 x 17.5	916	14.7	20
7½	YSC092FW*LA0000	11.2	94,000	97,200	80	47 x 53 x 89	33 x 17.5	32.13 x 17.5	1059	15.0	20
8½	YSC102FW*LA0000	11.2	102,000	97,200	80	47 x 53 x 89	33 x 17.5	32.13 x 17.5	1096	17.5	20
10	YSC120FW*LA0000	11.3	118,000	121,500	80	47 x 53 x 89	33 x 17.5	32.13 x 17.5	1156	18.9	25
YSC -208-230/3/60 – Three Phase – Medium Heat											
6	YSC072F3*MA0000	11.2	75,000	97,200	80	41 x 53 x 89	33 x 17.5	32.13 x 17.5	936	36.5	50
7½	YSC090F3*MA0000	11.2	89,000	150,000	80	41 x 53 x 89	33 x 17.5	32.13 x 17.5	916	38.2	60
7½	YSC092F3*MA0000	11.2	94,000	121,500	80	47 x 53 x 89	33 x 17.5	32.13 x 17.5	1059	41.2	50
8½	YSC102F3*MA0000	11.2	102,000	121,500	80	47 x 53 x 89	33 x 17.5	32.13 x 17.5	1096	46.3	60
10	YSC120F3*MA0000	11.3	118,000	162,000	80	47 x 53 x 89	33 x 17.5	32.13 x 17.5	1156	49.6	60
YSC -460/3/60 – Three Phase – Medium Heat											
6	YSC072F4*MA0000	11.2	75,000	97,200	80	41 x 53 x 89	33 x 17.5	32.13 x 17.5	936	18.2	25
7½	YSC090F4*MA0000	11.2	89,000	150,000	80	41 x 53 x 89	33 x 17.5	32.13 x 17.5	916	19.5	30
7½	YSC092F4*MA0000	11.2	94,000	121,500	80	47 x 53 x 89	33 x 17.5	32.13 x 17.5	1059	21.5	25
8½	YSC102F4*MA0000	11.2	102,000	121,500	80	47 x 53 x 89	33 x 17.5	32.13 x 17.5	1096	21.9	25
10	YSC120F4*Ma0000	11.3	118,000	162,000	80	47 x 53 x 89	33 x 17.5	32.13 x 17.5	1156	22.7	35
YSC -575/3/60 – Three Phase – Medium Heat											
6	YSC072FW*MA0000	11.2	75,000	97,200	80	41 x 53 x 89	33 x 17.5	32.13 x 17.5	936	12.7	20
7½	YSC090FW*MA0000	11.2	89,000	150,000	80	41 x 53 x 89	33 x 17.5	32.13 x 17.5	916	14.7	20
7½	YSC092FW*MA0000	11.2	94,000	121,500	80	47 x 53 x 89	33 x 17.5	32.13 x 17.5	1059	15.9	20
8½	YSC102FW*MA0000	11.2	102,000	121,500	80	47 x 53 x 89	33 x 17.5	32.13 x 17.5	1096	17.5	20
10	YSC120FW*MA0000	11.3	118,000	162,000	80	47 x 53 x 89	33 x 17.5	32.13 x 17.5	1156	18.9	25
YSC -208-230/3/60 – Three Phase – High Heat											
6	YSC072F3*HA0000	11.2	75,000	121,500	80	41 x 53 x 89	33 x 17.5	32.13 x 17.5	936	36.5	50
7½	YSC090F3*HA0000	11.2	89,000	200,000	80	41 x 53 x 89	33 x 17.5	32.13 x 17.5	916	38.2	60
7½	YSC092F3*HA0000	11.2	94,000	162,000	80	47 x 53 x 89	33 x 17.5	32.13 x 17.5	1059	41.2	50
8½	YSC102F3*HA0000	11.2	102,000	162,000	80	47 x 53 x 89	33 x 17.5	32.13 x 17.5	1096	46.3	60
10	YSC120F3*HA0000	11.3	118,000	205,500	80	47 x 53 x 89	33 x 17.5	32.13 x 17.5	1156	49.6	60
YSC -460/3/60 – Three Phase – High Heat											
6	YSC072F4*HA0000	11.2	75,000	121,500	80	41 x 53 x 89	33 x 17.5	32.13 x 17.5	936	18.2	25
7½	YSC090F4*HA0000	11.2	89,000	200,000	80	41 x 53 x 89	33 x 17.5	32.13 x 17.5	916	19.5	30
7½	YSC092F4*HA0000	11.2	94,000	162,000	80	47 x 53 x 89	33 x 17.5	32.13 x 17.5	1059	21.5	25
8½	YSC102F4*HA0000	11.2	102,000	162,000	80	47 x 53 x 89	33 x 17.5	32.13 x 17.5	1096	21.9	25
10	YSC120F4*HA0000	11.3	118,000	205,500	80	47 x 53 x 89	33 x 17.5	32.13 x 17.5	1156	22.7	35
YSC -575/3/60 – Three Phase – High Heat											
6	YSC072FW*HA0000	11.2	75,000	121,500	80	41 x 53 x 89	33 x 17.5	32.13 x 17.5	936	12.7	20
7½	YSC090FW*HA0000	11.2	89,000	200,000	80	41 x 53 x 89	33 x 17.5	32.13 x 17.5	916	14.7	20
7½	YSC092FW*HA0000	11.2	94,000	162,000	80	47 x 53 x 89	33 x 17.5	32.13 x 17.5	1059	15.9	20
8½	YSC102FW*HA0000	11.2	102,000	162,000	80	47 x 53 x 89	33 x 17.5	32.13 x 17.5	1096	17.5	20
10	YSC120FW*HA0000	11.3	118,000	205,500	80	47 x 53 x 89	33 x 17.5	32.13 x 17.5	1156	18.9	25

① Downflow Airflow/Horizontal Airflow

② SEER applies, 3-5 tons; EER applies 6-10 tons.

* Digit 9-E=Electromechanical or R=ReliaTel™.

** Information subject to change. Please confirm with current Product Data/Service Facts for current factory production.

For complete equipment / combination selections, installation instructions and warranty information, please refer to Product Data/Ratings and/or Installers Guides and Limited Warranty Handbooks.

Light Commercial
Packaged Gas/Electric

Packaged Gas/Electric Convertible 3-10 Tons (Model Digit Numbers)

Digit	Description	Order Number	Digit	Description	Order Number
1-8	Main Assembly (see previous page)		20	Convenience Outlet	
9	Unit Controls			No Convenience Outlet	0
	Electromechanical	E		Unpowered Convenience Outlet	A
	ReliaTel™ Micro-processor	R		Powered Convenience Outlet (three-phase only)⑨	B
10	Heating Capacity		21	Communications Options ③	
	Low	L		No Communications Interface	0
	Medium	M		Novar 2024 Controls⑩	3
	High	H		Novar 3051 Controls without Zone Sensor⑩	4
	Low - Stainless Steel Heat Exchanger	X		Novar 3051 Controls Interface with DCV⑩	5
	Medium - Stainless Steel Heat Exchanger	Y		BACnet™ Communications Interface	6
	High - Stainless Steel Heat Exchanger	Z	22	Refrigeration System Option	
11	Minor Design Sequence			Standard Refrigeration System⑩	0
	First Sequence	A		Dehumidification Option⑫⑬⑭	B
12-13	Service Sequence		23	Refrigeration Controls	
	First Sequence (Factory assigned)	*,*		<i>Note: Applicable to Digit 7 = E, F</i>	
14	Fresh Air Selection			No Refrigeration Control⑮	0
	No Fresh Air	0		Froststat⑮⑯	1
	Manual Outside Air Damper 0-50%⑰	A		Crankcase Heater⑰	2
	Motorized Outside Air Damper 0-50%⑰	B		Froststat⑮⑯ and Crankcase Heater⑰	3
	Economizer, Dry Bulb 0-100% without		24	Smoke Detector ⑰	
	Barometric Relief⑰	C		No Smoke Detector	0
	Economizer, Dry Bulb 0-100% with Barometric Relief⑰ ..	D		Return Air Smoke Detector⑰⑱	A
	Economizer, Reference Enthalpy 0-100% without			Supply Air Smoke Detector	B
	Barometric Relief⑰⑲	E		Supply and Return Air Smoke Detectors⑰⑱	C
	Economizer, Reference Enthalpy 0-100% with			Plenum Smoke Detector	D
	Barometric Relief⑰⑲	F	25	System Monitoring Controls	
	Economizer, Comparative Enthalpy 0-100%			No Monitoring Control⑳	0
	without Barometric Relief⑰⑲	G		Clogged Filter Switch⑳	1
	Economizer, Comparative Enthalpy 0-100%			Fan Failure Switch⑳	2
	with Barometric Relief⑰⑲	H		Discharge Air Sensing Tube⑳	3
15	Supply Fan/Drive Type/Motor			Clogged Filter Switch and Fan Failure Switch⑳	4
	Standard Drive㉑	0		Clogged Filter Switch and Discharge Air Sensing Tube⑳ ..	5
	Oversized Motor	1		Fan Failure Switch and Discharge Air Sensing Tube⑳	6
	Optional Belt Drive Motor㉒	2		Clogged Filter Switch, Fan Failure Switch and	
	Single Zone VAV㉓	6		Discharge Air Sensing Tube⑳	7
	Multi-Speed Indoor Fan㉔	7		Novar Return Air Sensor (NOVAR 2024)㉕㉖	8
	VAV Supply Air Temperature Control Standard Motor㉗ ..	E		Novar Zone Temp Sensor (NOVAR 3051)㉕㉖	9
16	Hinged Service Access/Filters			Condensate Drain Pan Overflow Switch	A
	Standard Panels/Standard Filters	0		Clogged Filter Switch⑳ and Condensate Drain	
	Hinged Access Panels/Standard Filters	A		Pan Overflow Switch	B
	Standard Panels/2" MERV 8 Filters	B		Fan Failure Switch⑳ and Condensate Drain	
	Hinged Access Panels/2" MERV 8 Filters	C		Pan Overflow Switch	C
	Standard Panels/2" MERV 13 Filters	D		Discharge Air Sensing⑳ and Condensate Drain	
	Hinged Access Panels/2" MERV 13 Filters	E		Pan Overflow Switch	D
17	Condenser Coil Protection			Clogged Filter Switch⑳, Fan Failure Switch⑳	
	Standard Coil	0		and Condensate Drain Pan Overflow Switch	E
	Standard Coil with Hail Guard	1		Clogged Filter Switch⑳, Discharge Air Sensing Tube⑳	
	Black Epoxy Pre-Coated Condenser Coil㉘	2		and Condensate Drain Pan Overflow Switch	F
	Black Epoxy Pre-Coated Condenser Coil with			Fan Failure Switch, Discharge Air Sensing Tube⑳ and	
	Hail Guard㉘	3		Condensate Drain Pan Overflow Switch	G
	CompleteCoat™ Condenser Coil	4		Clogged Filter Switch⑳, Fan Failure Switch⑳,	
	CompleteCoat™ Condenser Coil with Hail Guard	5		Discharge Air Sensing⑳ and Condensate	
18	Through the Base Provisions			Drain Pan Overflow Switch	H
	<i>Note: Applicable to Digit 1, T or Y models</i>		26	System Monitoring Controls	
	No Through-the-Base Provisions	0		No Monitoring Controls	0
	Through-the-Base Electric⑳	A		Demand Control Ventilation (CO ₂)㉙㉚	A
	<i>Note: Applicable to Digit 1, Y models only</i>		27	Unit Hardware Enhancements	
	Through-the-Base Gas Piping㉛	B		No Enhancements	0
	Through-the-Base Electric and Gas Piping㉛	C		Stainless Steel Drain Pan	1
19	Disconnect/Circuit Breaker (three-phase only)				
	No Disconnect/No Circuit Breaker	0			
	Unit Mounted Non-Fused Disconnect⑳	1			
	Unit Mounted Circuit Breaker㉜	2			

See Footnotes ①-③ next page.

For complete equipment / combination selections, installation instructions and warranty information, please refer to Product Data/Ratings and/or Installers Guides and Limited Warranty Handbooks.

Packaged Gas/Electric Convertible 3-10 Tons (Model Digit Numbers)

- ① Available on 3-5 Ton models.
- ② Standard on 4-5 Ton E3,4,W and 6-10 Ton Heat Pumps and all High Efficiency models.
- ③ Not available with electromechanical controls.
- ④ Manual outside air damper will ship factory supplied within the unit, but must be field installed.
- ⑤ High pressure control is standard on all units.
- ⑥ On 3-5 ton, multispeed direct drive is standard on single phase and 15 SEER. On 6-10 ton, multispeed direct drive is standard on all 10 ton and 7.5-8.5 ton high efficiency. Belt drive is standard on all other units.
- ⑦ Economizer with Barometric Relief is for downflow configured units only. Order Economizer without Barometric Relief for horizontal configuration. Barometric Relief for horizontal configured units must be ordered as field installed accessory.
- ⑧ Through the base electric required when ordering disconnect/circuit breaker options.
- ⑨ Requires use of Disconnect or Circuit Breaker.

Digit 15 = 0

Standard Efficiency

- 1 Phase = High Efficiency Multispeed Direct Drive Motor
- 3 Phase (3-8½ Ton) = Belt Drive
- 3 Phase (10 Ton) = Ultra High Efficiency Direct Drive Plenum Fan

High Efficiency

- 1 Phase = High Efficiency Multispeed Direct Drive Motor
- 3 Phase (3-5 ton) = High Efficiency Multispeed Direct Drive Motor
- 3 Phase (3-5 ton w/Dehumidification) = Belt Drive Motor
- 3 Phase (7½-10 ton) = Ultra High Efficiency Direct Drive Plenum Fan

Not Available

- Standard Efficiency: 10 Ton w/575V
- High Efficiency: 3-5 ton w/Standard Indoor Motor w/460V

- ⑩ Standard metering devices are TXVs.
- ⑪ Froststat cannot be field installed in electro-mechanical units.
- ⑫ The return air smoke detector may not fit up or work properly on the Precedent units when used in conjunction with 3rd party accessories such as bolt on heat wheels, economizers and power exhaust. Do not order the return air smoke detectors when using this type of accessory.
- ⑬ Return Air Smoke Detector cannot be ordered with Novar Controls.
- ⑭ These options are standard when ordering Novar Controls.
- ⑮ This option is used when ordering Novar Controls.
- ⑯ Includes gas piping and shutoff (field assembly required).
- ⑰ Not available with high temperature duct sensor accessory.
- ⑱ Digit 15 = 2
- ⑲ Novar Sensor utilized with Digit 21 = (4) Novar 3051 Controls without Zone Sensor.
- ⑳ Available for T/Y 10 ton standard efficiency models only.
- ㉑ Available for T/Y 3, 4, 5, 6, 7½, 8½ ton standard/high efficiency models only.
- ㉒ Requires selection of 2" Pleated Filters (option B or C) for Digit 16.
- ㉓ Not available on 6 ton units and all single phase or standard efficiency.
- ㉔ Standard on T/YSC 6, 7½ (single and dual systems), 8½, 10 ton standard efficiency models and T/YHC 4, 5, 6, 7½ ton high efficiency models (except for dehumidification models).
- ㉕ Epoxy coil and epoxy with hailguard options are not available for units with microchannel condenser coil.
- ㉖ Single Zone VAV is only available on 7.5-10 ton high efficiency and 10 ton standard efficiency products with ReliaTel™ controls.
- ㉗ Multi-speed indoor fan available only on 7.5 & 8.5 ton high efficiency, and 10 ton products with ReliaTel™ controls.
- ㉘ Motorized Outside Air Damper is not available on Multi-Speed or SZVAV (Single Zone Variable Air Volume) products.
- ㉙ Froststat standard on Multi-Speed and SZVAV (Single Zone Variable Air Volume) products.
- ㉚ Novar is not available with SZVAV products.
- ㉛ Demand Control Ventilation not available with electromechanical controls.
- ㉜ Demand Control Ventilation Option includes wiring only. The CO₂ sensor is a field-installed only option.
- ㉝ When ordering Dehumidification option, digit #7 will revert back to E, not F.

Table LPG-9-A — Accessories

Model Number	Description	Used With ^①
BAYABRD001C ^③	ReliaTel™ Options Module.....	All Y*C036-120*
BAYASCT001C ^{⑦⑧}	Anti-Short-Cycle Timer.....	All Y*C036-120* w/ Electro Mechanical
BAYBARM010A ^⑨	Barometric Relief	YSC036E, YHC036E, YHC037E
BAYBARM011A ^⑨	Barometric Relief	YSC048E-120E, YHC048-120, YHC047-067
BAYBCIR001A.....	BACnet™ Communication Interface	All Y*C036-120* w/ ReliaTel™
BAYCCHT010B.....	Crankcase Heater	YSC036-048, YSC092-102
BAYCCHT011B.....	Crankcase Heater	YSC036-048, YSC092-102
BAYCCHT017A.....	Crankcase Heater	YSC060-072, YSC090, YSC120
BAYCCHT018A.....	Crankcase Heater	YSC060-072, YSC090, YSC120
BAYCURB042A ^②	Roof Curb.....	YSC036-060E, YSC036-060F, YHC036E, YHC037E
BAYCURB043A ^②	Roof Curb.....	YSC 072-120E, YSC072-120F, YHC072F, YHC047E, YHC067E
BAYCURB044A.....	Roof Curb.....	YHC120F
BAYDFPS003B ^{③⑥}	Clogged Filter Switch.....	All Y*C036-120*
BAYDFPS014A.....	Clogged Filter Switch (MERV 13 Filter)	All Y*C036-120*
BAYDFPS004 ^{③⑥}	Fan Failure Switch.....	All Y*C036-120*
BAYDMPR053A ^⑩	0-50% Manual Outside Air Damper	YSC036-060, YHC036, YHC037
BAYDMPR056B ^⑩	0-50% Manual Outside Air Damper	YSC072-120, YHC048-060, YHC047-067
BAYDMPR051A ^③	0-50% Motorized Outside Air Damper	YSC036-060, YHC036, YHC037 (ReliaTel™)
BAYDMPR052A ^⑦	0-50% Motorized Outside Air Damper	YSC036-060, YHC036 (Electro Mechanical)
BAYDMPR054A ^③	0-50% Motorized Outside Air Damper	YSC072-120, YHC048-060, YHC047-067 (ReliaTel™)
BAYDMPR055A ^⑦	0-50% Motorized Outside Air Damper	YHC048-060, YSC072-120, YHC072-120 (Electro Mechanical)
BAYECON085A ^③	0-100% Dry Bulb Economizer.....	YSC036-060, YHC036, YHC037 (ReliaTel™)
BAYECON086A ^⑦	0-100% Dry Bulb Economizer	YSC036-060, YHC036 (Electro Mechanical) without Barometric Relief
BAYECON087A ^③	0-100% Dry Bulb Economizer	YSC072-120, YHC048-060, YHC047-067 (ReliaTel™)
BAYECON088A ^⑦	0-100% Dry Bulb Economizer	YHC048-060, YSC072-120, YHC072-120 (Electro Mechanical) without Barometric Relief
BAYENTH001A.....	Enthalpy Control (Solid State).....	All Y*C036-120*
BAYENTH005A ^①	Reference Enthalpy Kit.....	All Y*C036-120*
BAYENTH006A ^①	Comparative Enthalpy Kit.....	All Y*C036-120*
BAYFRST003A ^{③④}	High Temperature Stat	All Y*C036-120*
BAYGARD037B.....	Condenser Coil Hail Guard	YSC036-60E, YHC037
BAYGARD040A.....	Condenser Coil Hail Guard	YSC072E-090E, YHC048-060, YHC047-067
BAYGARD041A.....	Condenser Coil Hail Guard	YSC092-120, YHC072
BAYGARD070A.....	Condenser Coil Hail Guard	YHC120E
BAYGARD141A.....	Condenser Coil Hail Guard	YSC102F-120F, YHC072F-102F
BAYHAKT010C.....	High Altitude Kit	All Y*C036-120*

- ① Kits contain all necessary parts to achieve desired level of enthalpy control.
- ② Lynn Haven Manufacturing has a No-Return policy for this roof curb.
- ③ For use with ReliaTel™ controlled units only.
- ④ Cannot be used in conjunction with factory installed Smoke Detector option.
- ⑤ Installs in ductwork for horizontal configuration. For downflow configuration, it installs in the unit's horizontal return duct. See Installer's Guide for more information.
- ⑥ BAYABRD001C is required when ordering field installed accessories Clogged Filter Switch (BAYDFPS003A), Fan Fail Switch (BAYDFPS004A), Discharge Air Sensing Kit (BAYTUBE004A or BAYTUBE005A) or Evaporator Defrost Control (Frostat) (BAYLOAM020B) Ventilation Override Kit (BAYVNOR001B) unless the following options are factory installed: Frostat, Smoke Detector, Clogged Filter Switch, Fan Failure Switch, Discharge Air Sensing Kit. **These factory installed options include the ReliaTel™ Options Module.**
- ⑦ Electromechanical controlled units only
- ⑧ Activated on Power on.
- ⑨ Field installed accessory. Requires an economizer.
- ⑩ The manual outside air damper will ship factory supplied within the unit, but must be field installed.
- ⑪ A=R-22, E=410A

Light Commercial
Packaged Gas/Electric

Packaged Gas/Electric Convertible 3-10 Tons Accessories

Table LPG-10-A — Accessories

Model Number	Description	Used With ^①
BAYHSMT082A	2 HP Oversized motor kit (208-230/460V)	YSC072F3, 4
BAYHSMT083A	2 HP Oversized motor kit (575V)	YSC072FW
BAYHSMT402A	2 HP Oversized motor kit	YHC072F3, 4
BAYHSMT086A	3 HP Oversized motor kit (208-230/460V)	YSC090-102F3, 4
BAYHSMT087A	3 HP Oversized motor kit (575V)	YSC090-102FW
BAYLSDR009A	Low Static Drive Kit	YHC072F
BAYHSDR012A	High Static Drive Kit	YSC072F
BAYKSKT255B	Quick Start Kit	YSC036-060*1
BAYLMSW001A ^⑩	Power Exhaust Limit Switch	All Y*C036-120*
BAYLOAM020B ^{①⑤}	Evaporator Defrost Control (Frostat)	All Y*C036-120*, R (ReliaTel™)
BAYLPKT029C	LP Conversion Kit	YSC072*,H, YSC090-102,M,H, YSC120,L,M,H YHC072*,H, YHC092-102*,M,H, YHC120*,L,M,H
BAYLPKT050B	LP Conversion Kit	YSC036-060*,L,M,H, YSC072*,L,M, YSC090-102*,L YHC036-060*,L,M,H, YHC072*,L,M, YHC092-102*,L
BAYPWRX070A	Power Exhaust (208-230/3 VAC)	YSC036-060*3, YCH036-YHC060*3, YHC037E3, YHC047E3, YHC067E3
BAYPWRX071A	Power Exhaust (460/3 VAC)	YSC036-060*4, YHC036-YHC060*4, YHC037E4, YHC047E4, YHC067E4
BAYPWRX072A	Power Exhaust (575/3 VAC)	YSC036-060*W
BAYPWRX026A	Power Exhaust (208-230/3 VAC)	YSC072-102F3, YSC120F3, YHC072F3, YHC092F3, YHC102F3, YHC120E3
BAYPWRX027A	Power Exhaust (460/3 VAC)	YSC072-102F4, YSC120F4, YHC072F4, YHC092F4, YHC102F4, YHC120E4
BAYPWRX028A	Power Exhaust (575/3 VAC)	YSC072-102FW, YSC120FW
BAYQACB009A	Quick Adapt Roof Curb	YSC036-060*, YHC036E, YHC037E
BAYQACB010A	Quick Adapt Roof Curb	YSC036-060*, YHC036E, YHC037E
BAYQACB011A	Quick Adapt Roof Curb	YSC072-102F, YSC120F, YHC048-072F, YHC047E, YHC067E
BAYQACB012A	Quick Adapt Roof Curb	YSC072-102F, YSC120F, YHC048-072F, YHC047E, YHC067E
BAYQACB013A	Quick Adapt Roof Curb	YSC072-102F, YSC120F, YHC048-072F, YHC047E, YHC067E
BAYRTEM001A ^⑪	Fully Featured ReliaTel™ Economizer Logic Model	All Y*C036-120*
BAYSENS016A ^④	Temperature Sensor	All Y*C036-120*
BAYSENS250A ^{③②}	CO ₂ Duct Mounted, Sensor Only	All Y*C036-120*, R (ReliaTel™)
BAYSENS251A ^{③②}	CO ₂ Wall Mounted, Sensor Only	All Y*C036-120*, R (ReliaTel™)
BAYSERV001A ^④	Selective Resistance Service Tester	All Y*C036-120*
BAYSTAT023 ^④	Remote Potentiometer	All Y*C036-120*
BAYTUBE004A ^{④②⑤}	Discharge Air Sensing Kit	YSC036-060*, R, YHC036E, R
BAYTUBE006A ^{④②⑤}	Discharge Air Sensing Kit	YSC072-102F, R, YHC048-072F, R
BAYTUBE400A	Discharge Air Sensing Kit	YSC120F,R
BAYTUBE402A	Discharge Air Sensing Kit	YHC092-120*,R
BAYVNOR001B ^{④③⑤}	Ventilation Override Kit	All Y*C036-120*

① For use with ReliaTel™ microprocessor controlled units only. Must be factory installed for Electromechanical controlled units.

② Used for true discharge air sensing in both heating and cooling. Required for supply air tempering.

③ Lynn Haven Manufacturing has a No-Return policy for this roof curb.

④ For use with ReliaTel™ controlled units only.

⑤ BAYABRD001C is required when ordering field installed accessories Clogged Filter Switch (BAYDFPS003A), Fan Fail Switch (BAYDFPS004A), Discharge Air Sensing Kit (BAYTUBE004A or BAYTUBE005A) or Evaporator Defrost Control (Frostat) (BAYLOAM020B) Ventilation Override Kit (BAYVNOR001B) unless the following options are factory installed: Frostat, Smoke Detector, Clogged Filter Switch, Fan Failure Switch, Discharge Air Sensing Kit. **These factory installed options include the ReliaTel™ Options Module.**

⑥ BAYQACB009A adapts YCD units BAYCURB021B to accept Y*C 3 -5 ton unit. BAYQACB010A adapts YCD units BAYCURB022B to accept Y*C 3-5 ton unit.

BAYQACB012A adapts YCD units BAYCURB025B to accept Y*C 3-5 ton unit. BAYQACB013A adapts YCD units BAYCURB026B to accept Y*C 6-10 ton unit.

BAYQACB011A adapts YCD units BAYCURB022B to accept Y*C 6-10 ton unit.

⑦ Power Exhaust cannot be used with Barometric Relief. Order Economizer without Barometric Relief.

⑧ Field installed accessory. Requires an economizer.

⑨ E=410A

⑩ When ordering a field installed power exhaust on a unit with electromechanical controls, BAYLMSW001A must be ordered.

⑪ If any version of comparative or reference enthalpy is ordered, BAYRTEM001A does not need to be ordered.

⑫ Order only when unit has factory installed Demand Control Ventilation option.

For complete equipment / combination selections, installation instructions and warranty information, please refer to Product Data/Ratings and/or Installers Guides and Limited Warranty Handbooks.

Packaged Gas/Electric Convertible 3-10 Tons, R-410A Zone Sensors / Thermostats

Table LPG-11-A — Zone Sensors for ReliaTel™ Controlled Units

Model Number	Description	Used With
ASYSTAT106A	Single Setpoint Manual Changeover	Y*C036-120*, R
ASYSTAT107A	Single Setpoint	Y*C036-120*, R
ASYSTAT108A	Dual Setpoint Manual or Auto Changeover	Y*C036-120*, R
ASYSTAT109A	Dual Setpoint Changeover Sensor	Y*C036-120*, R
ASYSTAT111A	Remote Room Sensor	Y*C036*120*, R
ASYSTAT777A	Programmable Night Setback w/System Function Lights (Vertical Style)	Y*C036-120*, R
ASYSTAT708A	Programmable Night Setback w/System Function Lights	Y*C036-120*, R
ASYSTAT710A	Wall Mounted Humidity Sensor	Y*C036-120*
ASYSTAT711A	Duct Mounted Humidity Sensor	Y*C036-120*
BAYMTPL110A	Retrofit Wall Cover Plate Kit 7.25" x 6.0"	ASYSTAT666C

**For additional Controls Information:
See ReliaTel™ and Micro Control features on LPC-13 and LPC-14.**

For complete equipment / combination selections, installation instructions and warranty information, please refer to Product Data/Ratings and/or Installers Guides and Limited Warranty Handbooks.

Packaged Gas/Electric with ReliaTel™ Controls 12½-25 Tons, R-410A

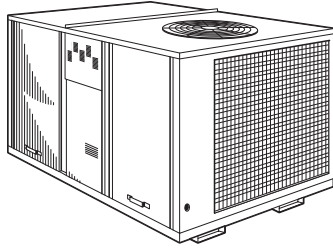

12½ - 25 Ton YHD-F — Downflow
12½ - 25 Ton YHH-F — Horizontal

- Scroll compressors on all units
- **ReliaTel™** control features are listed on page LPC-13
- Operating charge of R-410A
- Built-in anti-short cycle timer, time delay relay and minimum on time controls
- Low Ambient to 0°F standard
- High efficiency drum and tube heat exchanger
- Color coded and numbered wiring
- Two inch throwaway filters on both YCH and YCD to clean air and keep coil maintenance low
- Simple U-shaped airflow pattern results in very low airside energy requirement
- Quick-Access doors and single side access make servicing much faster for lower maintenance costs
- Quick-adjust idler arm pulley. Adjust belt tension, change belts, adjust airflow quickly
- High efficiency gas heat with hot surface ignition for low heating energy costs, low maintenance and high reliability
- Sloped sheet metal drain pans
- **5-year limited compressor and heat exchanger warranty (12½ -17½ tons)**
- **1-year limited compressor and heat exchanger warranty (20 tons)**

Table LPG-12-A — High Efficiency ReliaTel™ Units (R-410A)

Tons	Unit Model No.	Power Supply Volts/Phase/Hz	Performance EER ^③	Cooling Capacity (Btuh)	Heating Output Capacity (Btuh)	Dimensions (in.) H x W x L	Shipping Weight (lbs.)	MCA**	Max Fuse Size or Max Circuit Breaker**	Downflow ^① Roofcurb
YH* - Three Phase Low Heat										
12½	YH*150F3RLA0000	208-230/3/60	12.1	140,000	122,000	54 x 85 ⁵ / ₁₆ x 122 ⁵ / ₁₆	2550	65	80	BAYCURB027B
15	YH*180F3RLA0000	208-230/3/60	12.0	172,000	203,000	64 ¹ / ₈ x 85 ⁵ / ₁₆ x 122 ⁵ / ₁₆	2500	72	90	BAYCURB027B
17½	YH*210F3RLA0000	208-230/3/60	11.8	198,000	203,000	64 ¹ / ₈ x 85 ⁵ / ₁₆ x 122 ⁵ / ₁₆	2578	88	110	BAYCURB027B
20	YH*240F3RLA0000	208-230/3/60	11.0	242,000	203,000	64 ¹ / ₈ x 85 ⁵ / ₁₆ x 122 ⁵ / ₁₆	2581	104	125	BAYCURB027B
25	YH*300F3RLA0000	208-230/3/60	10.6	272,000 ^②	203,000	64 ¹ / ₈ x 85 ⁵ / ₁₆ x 122 ⁵ / ₁₆	2544	116	150	BAYCURB027B
12½	YH*150F4RLA0000	460/3/60	12.1	140,000	122,000	54 x 85 ⁵ / ₁₆ x 122 ⁵ / ₁₆	2550	32	40	BAYCURB027B
15	YH*180F4RLA0000	460/3/60	12.0	172,000	203,000	64 ¹ / ₈ x 85 ⁵ / ₁₆ x 122 ⁵ / ₁₆	2500	36	45	BAYCURB027B
17½	YH*210F4RLA0000	460/3/60	11.8	198,000	203,000	64 ¹ / ₈ x 85 ⁵ / ₁₆ x 122 ⁵ / ₁₆	2578	42	50	BAYCURB027B
20	YH*240F4RLA0000	460/3/60	11.0	242,000	203,000	64 ¹ / ₈ x 85 ⁵ / ₁₆ x 122 ⁵ / ₁₆	2581	50	60	BAYCURB027B
25	YH*300F4RLA0000	460/3/60	10.6	272,000 ^②	203,000	64 ¹ / ₈ x 85 ⁵ / ₁₆ x 122 ⁵ / ₁₆	2544	56	70	BAYCURB027B
12½	YH*150FWRLA0000	575/3/60	12.1	140,000	122,000	54 x 85 ⁵ / ₁₆ x 122 ⁵ / ₁₆	2550	25	30	BAYCURB027B
15	YH*180FWRLA0000	575/3/60	12.0	172,000	203,000	64 ¹ / ₈ x 85 ⁵ / ₁₆ x 122 ⁵ / ₁₆	2500	29	40	BAYCURB027B
17½	YH*210FWRLA0000	575/3/60	11.8	198,000	203,000	64 ¹ / ₈ x 85 ⁵ / ₁₆ x 122 ⁵ / ₁₆	2578	36	45	BAYCURB027B
20	YH*240FWRLA0000	575/3/60	11.0	242,000	203,000	64 ¹ / ₈ x 85 ⁵ / ₁₆ x 122 ⁵ / ₁₆	2581	42	50	BAYCURB027B
25	YH*300FWRLA0000	575/3/60	10.6	272,000 ^②	203,000	64 ¹ / ₈ x 85 ⁵ / ₁₆ x 122 ⁵ / ₁₆	2544	47	60	BAYCURB027B
YH* - Three Phase High Heat										
12½	YH*150F3RHA0000	208-230/3/60	12.1	140,000	203,000	54 x 85 ⁵ / ₁₆ x 122 ⁵ / ₁₆	2550	65	80	BAYCURB027B
15	YH*180F3RHA0000	208-230/3/60	12.0	172,000	284,000	64 ¹ / ₈ x 85 ⁵ / ₁₆ x 122 ⁵ / ₁₆	2500	72	90	BAYCURB027B
17½	YH*210F3RHA0000	208-230/3/60	11.8	198,000	284,000	64 ¹ / ₈ x 85 ⁵ / ₁₆ x 122 ⁵ / ₁₆	2578	88	110	BAYCURB027B
20	YH*240F3RHA0000	208-230/3/60	11.0	242,000	324,000	64 ¹ / ₈ x 85 ⁵ / ₁₆ x 122 ⁵ / ₁₆	2581	104	125	BAYCURB027B
25	YH*300F3RHA0000	208-230/3/60	10.6	272,000	324,000	64 ¹ / ₈ x 85 ⁵ / ₁₆ x 122 ⁵ / ₁₆	2544	116	150	BAYCURB027B
12½	YH*150F4RHA0000	460/3/60	12.1	140,000	203,000	54 x 85 ⁵ / ₁₆ x 122 ⁵ / ₁₆	2550	32	40	BAYCURB027B
15	YH*180F4RHA0000	460/3/60	12.0	172,000	284,000	64 ¹ / ₈ x 85 ⁵ / ₁₆ x 122 ⁵ / ₁₆	2500	36	45	BAYCURB027B
17½	YH*210F4RHA0000	460/3/60	11.8	198,000	284,000	64 ¹ / ₈ x 85 ⁵ / ₁₆ x 122 ⁵ / ₁₆	2578	42	50	BAYCURB027B
20	YH*240F4RHA0000	460/3/60	11.0	242,000	324,000	64 ¹ / ₈ x 85 ⁵ / ₁₆ x 122 ⁵ / ₁₆	2581	50	60	BAYCURB027B
25	YH*300F4RHA0000	460/3/60	10.6	272,000	324,000	64 ¹ / ₈ x 85 ⁵ / ₁₆ x 122 ⁵ / ₁₆	2544	56	70	BAYCURB027B
12½	YH*150FWRHA0000	575/3/60	12.1	140,000	203,000	54 x 85 ⁵ / ₁₆ x 122 ⁵ / ₁₆	2550	25	30	BAYCURB027B
15	YH*180FWRHA0000	575/3/60	12.0	172,000	284,000	64 ¹ / ₈ x 85 ⁵ / ₁₆ x 122 ⁵ / ₁₆	2500	29	40	BAYCURB027B
17½	YH*210FWRHA0000	575/3/60	11.8	198,000	284,000	64 ¹ / ₈ x 85 ⁵ / ₁₆ x 122 ⁵ / ₁₆	2578	36	45	BAYCURB027B
20	YH*240FWRHA0000	575/3/60	11.0	242,000	324,000	64 ¹ / ₈ x 85 ⁵ / ₁₆ x 122 ⁵ / ₁₆	2581	42	50	BAYCURB027B
25	YH*300FWRHA0000	575/3/60	10.6	272,000	324,000	64 ¹ / ₈ x 85 ⁵ / ₁₆ x 122 ⁵ / ₁₆	2544	47	60	BAYCURB027B

① For Downflow units only.

② 278,000 in the Horizontal airflow configuration.

③ Downflow/Horizontal

* Digit 3 D=Downflow or H=Horizontal.

** Information subject to change. Please confirm with current Product Data/Service Facts for current factory production.

Packaged Gas/Electric with ReliaTel™ Controls 12½-25 Tons, R-410A

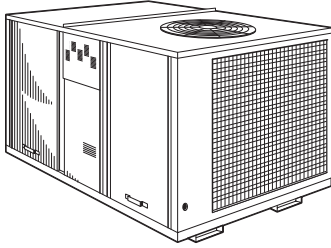

12½ - 25 Ton YHD-F — Downflow
12½ - 25 Ton YHH-F — Horizontal

- Scroll compressors on all units
- ReliaTel™ control features are listed on page LPC-13
- Operating charge of R-410A
- Built-in anti-short cycle timer, time delay relay and minimum on time controls
- Low Ambient to 0°F standard
- High efficiency drum and tube heat exchanger
- Color coded and numbered wiring
- Two inch throwaway filters on both YCH and YCD to clean air and keep coil maintenance low
- Simple U-shaped airflow pattern results in very low airside energy requirement
- Quick-Access doors and single side access make servicing much faster for lower maintenance costs
- Quick-adjust idler arm pulley. Adjust belt tension, change belts, adjust airflow quickly
- High efficiency gas heat with hot surface ignition for low heating energy costs, low maintenance and high reliability
- Sloped sheet metal drain pans
- **5-year limited compressor and heat exchanger warranty (12½ -17½ tons)**
- **1-year limited compressor and heat exchanger warranty (20 tons)**

Table LPG-13-A —High Efficiency ReliaTel™ Units (R-410A) - Multi Speed Indoor Fan

Unit Tons	Unit Model No.	Power Supply Volts/Phase/Hz	Performance EER ^③	Cooling Capacity (Btuh)	Heating Output Capacity (Btuh)	Dimensions (in.) H x W x L	Shipping Weight (lbs.)	Max Fuse Size or Max MCA**	Circuit Breaker**	Downflow ^① Roofcurb
YH* - Three Phase Low Heat										
12½	YH*150F3RLA1B8B	208-230/3/60	12.1	140,000	122,000	54 x 85 ⁵ / ₁₆ x 122 ⁵ / ₁₆	2575	65	80	BAYCURB027B
15	YH*180F3RLA1B8B	208-230/3/60	12.0	172,000	203,000	64 ¹ / ₈ x 85 ⁵ / ₁₆ x 122 ⁵ / ₁₆	2525	72	90	BAYCURB027B
17½	YH*210F3RLA1B8B	208-230/3/60	11.8	198,000	203,000	64 ¹ / ₈ x 85 ⁵ / ₁₆ x 122 ⁵ / ₁₆	2603	88	110	BAYCURB027B
20	YH*240F3RLA1B8B	208-230/3/60	11.0	242,000	203,000	64 ¹ / ₈ x 85 ⁵ / ₁₆ x 122 ⁵ / ₁₆	2606	104	125	BAYCURB027B
25	YH*300F3RLA1B8B	208-230/3/60	10.6	272,000 ^②	203,000	64 ¹ / ₈ x 85 ⁵ / ₁₆ x 122 ⁵ / ₁₆	2609	116	150	BAYCURB027B
12½	YH*150F4RLA1B8B	460/3/60	12.1	140,000	122,000	54 x 85 ⁵ / ₁₆ x 122 ⁵ / ₁₆	2575	32	40	BAYCURB027B
15	YH*180F4RLA1B8B	460/3/60	12.0	172,000	203,000	64 ¹ / ₈ x 85 ⁵ / ₁₆ x 122 ⁵ / ₁₆	2525	36	45	BAYCURB027B
17½	YH*210F4RLA1B8B	460/3/60	11.8	198,000	203,000	64 ¹ / ₈ x 85 ⁵ / ₁₆ x 122 ⁵ / ₁₆	2603	42	50	BAYCURB027B
20	YH*240F4RLA1B8B	460/3/60	11.0	242,000	203,000	64 ¹ / ₈ x 85 ⁵ / ₁₆ x 122 ⁵ / ₁₆	2606	50	60	BAYCURB027B
25	YH*300F4RLA1B8B	460/3/60	10.6	272,000 ^②	203,000	64 ¹ / ₈ x 85 ⁵ / ₁₆ x 122 ⁵ / ₁₆	2589	56	70	BAYCURB027B
12½	YH*150FWRLA1B8B	575/3/60	12.1	140,000	122,000	54 x 85 ⁵ / ₁₆ x 122 ⁵ / ₁₆	2575	25	30	BAYCURB027B
15	YH*180FWRLA1B8B	575/3/60	12.0	172,000	203,000	64 ¹ / ₈ x 85 ⁵ / ₁₆ x 122 ⁵ / ₁₆	2525	29	40	BAYCURB027B
17½	YH*210FWRLA1B8B	575/3/60	11.8	198,000	203,000	64 ¹ / ₈ x 85 ⁵ / ₁₆ x 122 ⁵ / ₁₆	2603	36	45	BAYCURB027B
20	YH*240FWRLA1B8B	575/3/60	11.0	242,000	203,000	64 ¹ / ₈ x 85 ⁵ / ₁₆ x 122 ⁵ / ₁₆	2606	42	50	BAYCURB027B
25	YH*300FWRLA1B8B	575/3/60	10.6	272,000 ^②	203,000	64 ¹ / ₈ x 85 ⁵ / ₁₆ x 122 ⁵ / ₁₆	2589	47	60	BAYCURB027B
YH* - Three Phase High Heat										
12½	YH*150F3RHA1B8B	208-230/3/60	12.1	140,000	203,000	54 x 85 ⁵ / ₁₆ x 122 ⁵ / ₁₆	2575	65	80	BAYCURB027B
15	YH*180F3RHA1B8B	208-230/3/60	12.0	172,000	284,000	64 ¹ / ₈ x 85 ⁵ / ₁₆ x 122 ⁵ / ₁₆	2525	72	90	BAYCURB027B
17½	YH*210F3RHA1B8B	208-230/3/60	11.8	198,000	284,000	64 ¹ / ₈ x 85 ⁵ / ₁₆ x 122 ⁵ / ₁₆	2603	88	110	BAYCURB027B
20	YH*240F3RHA1B8B	208-230/3/60	11.0	242,000	324,000	64 ¹ / ₈ x 85 ⁵ / ₁₆ x 122 ⁵ / ₁₆	2606	104	125	BAYCURB027B
25	YH*300F3RHA1B8B	208-230/3/60	10.6	272,000	324,000	64 ¹ / ₈ x 85 ⁵ / ₁₆ x 122 ⁵ / ₁₆	2609	116	150	BAYCURB027B
12½	YH*150F4RHA1B8B	460/3/60	12.1	140,000	203,000	54 x 85 ⁵ / ₁₆ x 122 ⁵ / ₁₆	2575	32	40	BAYCURB027B
15	YH*180F4RHA1B8B	460/3/60	12.0	172,000	284,000	64 ¹ / ₈ x 85 ⁵ / ₁₆ x 122 ⁵ / ₁₆	2525	36	45	BAYCURB027B
17½	YH*210F4RHA1B8B	460/3/60	11.8	198,000	284,000	64 ¹ / ₈ x 85 ⁵ / ₁₆ x 122 ⁵ / ₁₆	2603	42	50	BAYCURB027B
20	YH*240F4RHA1B8B	460/3/60	11.0	242,000	324,000	64 ¹ / ₈ x 85 ⁵ / ₁₆ x 122 ⁵ / ₁₆	2606	50	60	BAYCURB027B
25	YH*300F4RHA1B8B	460/3/60	10.6	272,000	324,000	64 ¹ / ₈ x 85 ⁵ / ₁₆ x 122 ⁵ / ₁₆	2589	56	70	BAYCURB027B
12½	YH*150FWRHA1B8B	575/3/60	12.1	140,000	203,000	54 x 85 ⁵ / ₁₆ x 122 ⁵ / ₁₆	2575	25	30	BAYCURB027B
15	YH*180FWRHA1B8B	575/3/60	12.0	172,000	284,000	64 ¹ / ₈ x 85 ⁵ / ₁₆ x 122 ⁵ / ₁₆	2525	29	40	BAYCURB027B
17½	YH*210FWRHA1B8B	575/3/60	11.8	198,000	284,000	64 ¹ / ₈ x 85 ⁵ / ₁₆ x 122 ⁵ / ₁₆	2603	36	45	BAYCURB027B
20	YH*240FWRHA1B8B	575/3/60	11.0	242,000	324,000	64 ¹ / ₈ x 85 ⁵ / ₁₆ x 122 ⁵ / ₁₆	2606	42	50	BAYCURB027B
25	YH*300FWRHA1B8B	575/3/60	10.6	272,000	324,000	64 ¹ / ₈ x 85 ⁵ / ₁₆ x 122 ⁵ / ₁₆	2589	47	60	BAYCURB027B

① For Downflow units only.

② 278,000 in the Horizontal airflow configuration.

③ Downflow/Horizontal

* Digit 3 D=Downflow or H=Horizontal.

** Information subject to change. Please confirm with current Product Data/Service Facts for current factory production.

Packaged Gas/Electric with ReliaTel™ Controls 12½-25 Tons, R-410A

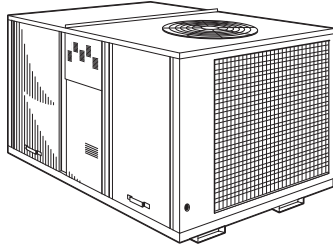

12½ - 25 Ton YSD-F — Downflow
12½ - 25 Ton YSH-F — Horizontal

- Scroll compressors on all units
- **ReliaTel™** control features are listed on page LPC-13
- Operating charge of R-410A
- Built-in anti-short cycle timer, time delay relay and minimum on time controls
- Low Ambient to 0°F standard
- High efficiency drum and tube heat exchanger
- Color coded and numbered wiring
- Two inch throwaway filters on both YCH and YCD to clean air and keep coil maintenance low
- Simple U-shaped airflow pattern results in very low airside energy requirement
- Quick-Access doors and single side access make servicing much faster for lower maintenance costs
- Quick-adjust idler arm pulley. Adjust belt tension, change belts, adjust airflow quickly
- High efficiency gas heat with hot surface ignition for low heating energy costs, low maintenance and high reliability
- Sloped sheet metal drain pans
- **5-year limited compressor and heat exchanger warranty (12½ -17½ tons)**
- **1-year limited compressor and heat exchanger warranty (20 tons)**

Table LPG-14-A — Standard Efficiency ReliaTel™ Units (R-410A)

Tons	Unit Model No.	Power Supply Volts/Phase/Hz	Performance EER	Cooling Capacity (Btuh)	Heating Output Capacity (Btuh)	Dimensions (in.) H x W x L	Shipping Weight (lbs.)	MCA**	Max Fuse Size or Max Circuit Breaker**	Downflow [Ⓛ] Roofcurb
YS* - Three Phase Low Heat										
12½	YS*150F3RLA0000	208-230/3/60	11.0	140,000	122,000	50½ x 71½ x 107½	1781	68	80	BAYCURB026B
15	YS*180F3RLA0000	208-230/3/60	11.0	176,000	203,000	54 x 85½ x 122½	2281	75	100	BAYCURB027B
17½	YS*210F3RLA0000	208-230/3/60	11.0	193,000	203,000	54 x 85½ x 122½	2292	93	125	BAYCURB027B
20	YS*240F3RLA0000	208-230/3/60	10.0	240,000	203,000	54 x 85½ x 122½	2353	108	125	BAYCURB027B
25	YS*300F3RLA0000	208-230/3/60	10.0	272,000	203,000	54 x 85½ x 122½	2337	124	150	BAYCURB027B
12½	YS*150F4RLA0000	460/3/60	11.0	140,000	122,000	50½ x 71½ x 107½	1781	32	40	BAYCURB026B
15	YS*180F4RLA0000	460/3/60	11.0	176,000	203,000	54 x 85½ x 122½	2281	28	50	BAYCURB027B
17½	YS*210F4RLA0000	460/3/60	11.0	193,000	203,000	54 x 85½ x 122½	2292	44	60	BAYCURB027B
20	YS*240F4RLA0000	460/3/60	10.0	240,000	203,000	54 x 85½ x 122½	2353	52	70	BAYCURB027B
25	YS*300F4RLA0000	460/3/60	10.0	272,000	203,000	54 x 85½ x 122½	2337	59	70	BAYCURB027B
12½	YS*150FWRLA0000	575/3/60	11.0	140,000	122,000	50½ x 71½ x 107½	1781	24	30	BAYCURB026B
15	YS*180FWRLA0000	575/3/60	11.0	176,000	203,000	54 x 85½ x 122½	2281	31	40	BAYCURB027B
17½	YS*210FWRLA0000	575/3/60	11.0	193,000	203,000	54 x 85½ x 122½	2292	35	50	BAYCURB027B
20	YS*240FWRLA0000	575/3/60	10.0	240,000	203,000	54 x 85½ x 122½	2353	44	60	BAYCURB027B
25	YS*300FWRLA0000	575/3/60	10.0	272,000	203,000	54 x 85½ x 122½	2337	48	60	BAYCURB027B
YS* - Three Phase High Heat										
12½	YS*150F3RHA0000	208-230/3/60	11.0	140,000	203,000	50½ x 71½ x 107½	1781	68	80	BAYCURB026B
15	YS*180F3RHA0000	208-230/3/60	11.0	176,000	284,000	54 x 85½ x 122½	2281	75	100	BAYCURB027B
17½	YS*210F3RHA0000	208-230/3/60	11.0	193,000	284,000	54 x 85½ x 122½	2292	93	125	BAYCURB027B
20	YS*240F3RHA0000	208-230/3/60	10.0	240,000	324,000	54 x 85½ x 122½	2353	108	125	BAYCURB027B
25	YS*300F3RHA0000	208-230/3/60	10.0	272,000	324,000	54 x 85½ x 122½	2337	124	150	BAYCURB027B
12½	YS*150F4RHA0000	460/3/60	11.0	140,000	203,000	50½ x 71½ x 107½	1781	32	40	BAYCURB026B
15	YS*180F4RHA0000	460/3/60	11.0	176,000	284,000	54 x 85½ x 122½	2281	28	50	BAYCURB027B
17½	YS*210F4RHA0000	460/3/60	11.0	193,000	284,000	54 x 85½ x 122½	2292	44	60	BAYCURB027B
20	YS*240F4RHA0000	460/3/60	10.0	240,000	324,000	54 x 85½ x 122½	2353	52	70	BAYCURB027B
25	YS*300F4RHA0000	460/3/60	10.0	272,000	324,000	54 x 85½ x 122½	2337	59	70	BAYCURB027B
12½	YS*150FWRHA0000	575/3/60	11.0	140,000	203,000	50½ x 71½ x 107½	1781	24	30	BAYCURB026B
15	YS*180FWRHA0000	575/3/60	11.0	176,000	284,000	54 x 85½ x 122½	2281	31	40	BAYCURB027B
17½	YS*210FWRHA0000	575/3/60	11.0	193,000	284,000	54 x 85½ x 122½	2292	35	50	BAYCURB027B
20	YS*240FWRHA0000	575/3/60	10.0	240,000	324,000	54 x 85½ x 122½	2353	44	60	BAYCURB027B
25	YS*300FWRHA0000	575/3/60	10.0	272,000	324,000	54 x 85½ x 122½	2337	48	60	BAYCURB027B

Ⓛ For Downflow units only.

* Digit 3 D=Downflow or H=Horizontal.

** Information subject to change. Please confirm with current Product Data/Service Facts for current factory production.

Packaged Gas/Electric with ReliaTel™ Controls 12½-25 Tons, R-410A

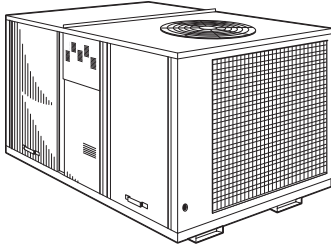

12½ - 25 Ton YSD-F — Downflow
12½ - 25 Ton YSH-F — Horizontal

- Scroll compressors on all units
- **ReliaTel™** control features are listed on page LPC-13
- Operating charge of R-410A
- Built-in anti-short cycle timer, time delay relay and minimum on time controls
- Low Ambient to 0°F standard
- High efficiency drum and tube heat exchanger
- Color coded and numbered wiring
- Two inch throwaway filters on both YCH and YCD to clean air and keep coil maintenance low
- Simple U-shaped airflow pattern results in very low airside energy requirement
- Quick-Access doors and single side access make servicing much faster for lower maintenance costs
- Quick-adjust idler arm pulley. Adjust belt tension, change belts, adjust airflow quickly
- High efficiency gas heat with hot surface ignition for low heating energy costs, low maintenance and high reliability
- Sloped sheet metal drain pans
- **5-year limited compressor and heat exchanger warranty (12½ -17½ tons)**
- **1-year limited compressor and heat exchanger warranty (20 tons)**

Table LPG-15-A — Standard Efficiency ReliaTel™ Units (R-410A) - Multi Speed Indoor Fan

Tons	Unit Model No.	Power Supply Volts/Phase/Hz	Performance EER	Cooling Capacity (Btuh)	Heating Output Capacity (Btuh)	Dimensions (in.) H x W x L	Shipping Weight (lbs.)	Max Fuse Size or Max Circuit Breaker** MCA**	Downflow [Ⓛ] Roofcurb
YS* - Three Phase Low Heat									
12½	YS*150F3RLA1B8B	208-230/3/60	11.0	140,000	122,000	50⅞ x 71⅝ x 107⅝ ₁₆	1806	64	80 BAYCURB026B
15	YS*180F3RLA1B8B	208-230/3/60	11.0	176,000	203,000	54 x 85⅝ ₁₆ x 122⅝ ₁₆	2306	75	100 BAYCURB027B
17½	YS*210F3RLA1B8B	208-230/3/60	11.0	193,000	203,000	54 x 85⅝ ₁₆ x 122⅝ ₁₆	2317	93	125 BAYCURB027B
20	YS*240F3RLA1B8B	208-230/3/60	10.0	240,000	203,000	54 x 85⅝ ₁₆ x 122⅝ ₁₆	2378	108	125 BAYCURB027B
25	YS*300F3RLA1B8B	208-230/3/60	10.0	272,000	203,000	54 x 85⅝ ₁₆ x 122⅝ ₁₆	2402	124	150 BAYCURB027B
12½	YS*150F4RLA1B8B	460/3/60	11.0	140,000	122,000	50⅞ x 71⅝ ₈ x 107⅝ ₁₆	1806	31	40 BAYCURB026B
15	YS*180F4RLA1B8B	460/3/60	11.0	176,000	203,000	54 x 85⅝ ₁₆ x 122⅝ ₁₆	2306	28	50 BAYCURB027B
17½	YS*210F4RLA1B8B	460/3/60	11.0	193,000	203,000	54 x 85⅝ ₁₆ x 122⅝ ₁₆	2317	44	60 BAYCURB027B
20	YS*240F4RLA1B8B	460/3/60	10.0	240,000	203,000	54 x 85⅝ ₁₆ x 122⅝ ₁₆	2378	52	70 BAYCURB027B
25	YS*300F4RLA1B8B	460/3/60	10.0	272,000	203,000	54 x 85⅝ ₁₆ x 122⅝ ₁₆	2382	59	70 BAYCURB027B
12½	YS*150FWRLA1B8B	575/3/60	11.0	140,000	122,000	50⅞ x 71⅝ ₈ x 107⅝ ₁₆	1806	23	30 BAYCURB026B
15	YS*180FWRLA1B8B	575/3/60	11.0	176,000	203,000	54 x 85⅝ ₁₆ x 122⅝ ₁₆	2306	31	40 BAYCURB027B
17½	YS*210FWRLA1B8B	575/3/60	11.0	193,000	203,000	54 x 85⅝ ₁₆ x 122⅝ ₁₆	2317	35	50 BAYCURB027B
20	YS*240FWRLA1B8B	575/3/60	10.0	240,000	203,000	54 x 85⅝ ₁₆ x 122⅝ ₁₆	2378	44	60 BAYCURB027B
25	YS*300FWRLA1B8B	575/3/60	10.0	272,000	203,000	54 x 85⅝ ₁₆ x 122⅝ ₁₆	2382	48	60 BAYCURB027B
YS* - Three Phase High Heat									
12½	YS*150F3RHA1B8B	208-230/3/60	11.0	140,000	203,000	50⅞ x 71⅝ ₈ x 107⅝ ₁₆	1806	64	80 BAYCURB026B
15	YS*180F3RHA1B8B	208-230/3/60	11.0	176,000	284,000	54 x 85⅝ ₁₆ x 122⅝ ₁₆	2306	75	100 BAYCURB027B
17½	YS*210F3RHA1B8B	208-230/3/60	11.0	193,000	284,000	54 x 85⅝ ₁₆ x 122⅝ ₁₆	2317	93	125 BAYCURB027B
20	YS*240F3RHA1B8B	208-230/3/60	10.0	240,000	324,000	54 x 85⅝ ₁₆ x 122⅝ ₁₆	2378	108	125 BAYCURB027B
25	YS*300F3RHA1B8B	208-230/3/60	10.0	272,000	324,000	54 x 85⅝ ₁₆ x 122⅝ ₁₆	2402	124	150 BAYCURB027B
12½	YS*150F4RHA1B8B	460/3/60	11.0	140,000	203,000	50⅞ x 71⅝ ₈ x 107⅝ ₁₆	1806	31	40 BAYCURB026B
15	YS*180F4RHA1B8B	460/3/60	11.0	176,000	284,000	54 x 85⅝ ₁₆ x 122⅝ ₁₆	2306	28	50 BAYCURB027B
17½	YS*210F4RHA1B8B	460/3/60	11.0	193,000	284,000	54 x 85⅝ ₁₆ x 122⅝ ₁₆	2317	44	60 BAYCURB027B
20	YS*240F4RHA1B8B	460/3/60	10.0	240,000	324,000	54 x 85⅝ ₁₆ x 122⅝ ₁₆	2378	52	70 BAYCURB027B
25	YS*300F4RHA1B8B	460/3/60	10.0	272,000	324,000	54 x 85⅝ ₁₆ x 122⅝ ₁₆	2382	59	70 BAYCURB027B
12½	YS*150FWRHA1B8B	575/3/60	11.0	140,000	203,000	50⅞ x 71⅝ ₈ x 107⅝ ₁₆	1806	23	30 BAYCURB026B
15	YS*180FWRHA1B8B	575/3/60	11.0	176,000	284,000	54 x 85⅝ ₁₆ x 122⅝ ₁₆	2306	31	40 BAYCURB027B
17½	YS*210FWRHA1B8B	575/3/60	11.0	193,000	284,000	54 x 85⅝ ₁₆ x 122⅝ ₁₆	2317	35	50 BAYCURB027B
20	YS*240FWRHA1B8B	575/3/60	10.0	240,000	324,000	54 x 85⅝ ₁₆ x 122⅝ ₁₆	2378	44	60 BAYCURB027B
25	YS*300FWRHA1B8B	575/3/60	10.0	272,000	324,000	54 x 85⅝ ₁₆ x 122⅝ ₁₆	2382	48	60 BAYCURB027B

[Ⓛ] For Downflow units only.

* Digit 3 D=Downflow or H=Horizontal.

** Information subject to change. Please confirm with current Product Data/Service Facts for current factory production.

Packaged Cooling with ReliaTel™ Controls 12½-25 Tons (Model Digit Numbers)

Digit	Description	Order Number	Digit	Description	Order Number		
1	Unit Type		19	Disconnect Switch/Circuit Breaker			
	Packaged Cooling, Electric Heat.....	T		No Disconnect/circuit break.....	0		
2	Efficiency	Packaged Gas/Electric.....	Y	Unit Mounted Non-Fused Disconnect Switch.....	1		
		Standard Efficiency.....	S	Unit Mounted Circuit Breaker.....	2		
3	Airflow Configuration	High Efficiency.....	H	20	Convenience Outlet Option		
		Downflow.....	D			Without Convenience Outlet.....	0
4-6	Nominal Gross Cooling Capacity (MBh)	Horizontal.....	H	Unpowered Convenience Outlet.....	A		
		12½ Tons.....	150	Powered Convenience Outlet.....	B		
		15 Tons.....	180	21	Communications Options	Without Communications Options.....	0
		17½ Tons.....	210			Novar 2024 Controls Interface④.....	3
		20 Tons.....	240			Novar 3051 Controls Interface④.....	4
25 Tons.....	300	Novar 3051 Communications Interface with Demand Control Ventilation③.....	5				
7	Major Design Sequence	Building Automation Control Network Communications Interface.....	F	6			
		Microchannel Type Condenser Coils.....	F	22	Refrigeration System Option	Standard refrigeration system.....	0
8	Voltage Selection	208-230/60/3.....	3			Thermal Expansion Valve (TXV).....	A
		460/60/3.....	4	Dehumidification (Hot Gas Reheat).....	B		
		575/60/3.....	W	23	Refrigeration Controls	Without Refrigeration Controls.....	0
		380/60/3.....	K			Frostat.....	1
		9	Unit Controls			ReliaTel™.....	R
10	Heating Capacity			No Heat②.....	0	Return Air Smoke Detector.....	A
		18 kW Electric Heat②.....	G	Supply Air Smoke Detector.....	B		
		27 kW Electric Heat②.....	K	Return/Supply Air Smoke Detector.....	C		
		36 kW Electric Heat②.....	N	Plenum Smoke Detector.....	D		
		54 kW Electric Heat②.....	P	25	System Monitoring Controls	No Monitoring Controls.....	0
		72 kW Electric Heat②.....	R			Clogged Filter Switch.....	1
		Gas Heat - High①.....	H			Fan Failure Switch.....	2
		Gas Heat - Low①.....	L	Discharge Air Sensing.....	3		
		Gas Heat - SS Ht Ex - Modulating①.....	V	Clogged Filter Switch and Fan Failure switch.....	4		
		Gas Heat - SS Ht Ex - Low①.....	X	Clogged Filter Switch and Discharge Air Sensing.....	5		
Gas Heat - SS Ht Ex - High①.....	Z	Fan Failure Switch and Discharge Air Sensing.....	6				
11	Minor Design Sequence	Clogged Filter Switch, Fan Failure Switch and Discharge Air Sensing.....		7			
		NOVAR Return Air Sensor (Novar 2024)④.....		8			
12-13	Service Sequence	NOVAR Zone Temp Sensor(Novar 3051)④.....		9			
		Condensate Drain Pan Overflow Switch.....		A			
14	Fresh Air Selection	Clogged Filter Switch and Condensate Drain Pan Overflow Switch.....		B			
		No Fresh Air.....	0	Fan Failure Switch and Condensate Drain Pan Overflow Switch.....	C		
15	Supply Fan/Drive Type/Motor	Discharge Air Sensing and Condensate Drain Pan Overflow Switch.....		D			
		Econ Dry Bulb w/ Barometric Relief.....	D	Clogged Filter Switch, Fan Failure Switch and Condensate Drain Pan Overflow Switch.....	E		
		Econ Reference Enthalpy w/Barometric Relief.....	F	Clogged Filter Switch, Discharge Air Sensing Tube and Condensate Drain Pan Overflow Switch.....	F		
		Econ Comparative Enthalpy w/Barometric Relief.....	H	Fan Failure Switch, Discharge Air Sensing Tube and Condensate Drain Pan Overflow Switch.....	G		
		16	Hinged Service Access / Filters	Clogged Filter Switch, Fan Failure Switch, Discharge Air Sensing and Condensate Drain Pan Overflow Switch.....		H	
				Standard Panels/Standard Filters.....	0	26	System Monitoring Controls
		Hinged Access/Standard Filters.....	A	Demand Control Ventilation (CO ₂)⑤.....	A		
		Standard Panels/MERV 8 Filters.....	B	27	Unit Hardware Enhancements	No Enhancements.....	0
		Hinged Access/MERV 8 Filters.....	C			Stainless Steel Drain Pan.....	1
		Standard Panels/MERV 13 Filters.....	D			Note: Most Factory Installed Options available for Downflow Air Discharge units only. Please verify with ordering system for availability.	
		Hinged Access/MERV 13 Filters.....	E				
		17	Condenser Coil Protection	Standard Coil.....	0		
				Standard Coil With Hail Guard.....	1		
				CompleteCoat™ Condenser Coil.....	4		
				CompleteCoat™ Condenser Coil with Hail Guard.....	5		
18	Through The Base Provisions.			No Through The Base Provisions③.....	0		
		Through The Base Electric③.....	A				
		Through The Base Gas①.....	B				
		Through The Base Electric/Gas①.....	C				
		Through The Base Access①.....	D				

① Applicable to Digit 1 Y models only.
 ② Applicable to Digit 1 T models only.
 ③ Applicable to Digit 1, T or Y models.

④ Novar is not available with SZ VAV products.
 ⑤ Demand Control Ventilation Option includes wiring only. The CO₂ sensor is a field-installed only option.

Light Commercial
Packaged Gas/Electric

Table LPG-17-A — Field Installed Accessories

Model Number	Description	Used With
BAYABRD002B ^⑧	ReliaTel™ Options Module	All Voyagers
BAYBCIR001A	Bacnet™ Communication Interface	ReliaTel™ Controller (BCI-R)
BAYCO2K002B	CO ₂ Sensor Wall Mounted	All Voyagers
BAYCO2K004B	CO ₂ Sensor Duct Mounted	All Voyagers
BAYCURB026B ^{⑤⑥}	Downflow Only Roof Curb	YSD150F
BAYCURB027B ^{⑤⑥}	Downflow Only Roof Curb	YHD150-YHD300F, YSD180-YSD300F
BAYDFPS005A ^{⑦⑧}	Clogged Filter Switch (MERV 7)	All Voyagers
BAYDFPS006A ^{⑦⑧}	Fan Failure Switch	All Voyagers
BAYDFPS031A	Clogged Filter Switch (MERV 13)	All Voyagers
BAYDMPR029C	0-25% Manual Outside Air Damper	All Voyagers
BAYDMPR057A	0-50% Motorized Outside Air Damper	YSD150F
BAYDMPR058A	0-50% Motorized Outside Air Damper	YHD150-300F, YSD150-300F
BAYECON089A ^②	Downflow Economizer with Barometric Relief	YSD150F
BAYECON090A ^②	Downflow Economizer with Barometric Relief	YHD150-300F, YSD150-300F
BAYECON091A	Horizontal Economizer	YSH150F
BAYECON092A	Horizontal Economizer	YHH150-300F, YSH180-300F
BAYENTH007A ^{①②}	Reference Enthalpy Kit	All BAYECON089A-092A
BAYENTH008A ^{①③}	Comparative Enthalpy Kit	All BAYECON089A-092A
BAYFRST003A	High Temperature Stat	All Voyagers
BAYGARD144A ^④	Tool-less Hail Guard	YS*150F
BAYGARD145A ^④	Tool-less Hail Guard	YH*150F, YS*180F-300F
BAYGARD150A ^④	Tool-less Hail Guard	YH*210F-300F, YH*180F
BAYHSDR005B ^④	High Static Drive	YS*150, 180F, YH*150F, 180F
BAYHSDR010A	High Static Drive	YH*210F, 240F, YS*300F
BAYHSDR011A	High Static Drive	YS*210F, 240F, YH*300F

- ① Kit contains all necessary parts to achieve desired level of Enthalpy Control.
- ② Reference Enthalpy senses outside temperature/humidity.
- ③ Comparative Enthalpy senses outside temperature/humidity and inside return/mixed air temperature/humidity.
- ④ High static drive and oversized motors are mutually exclusive, Do Not Combine.
- ⑤ See Accessory IOM for operational characteristics.
- ⑥ Clarksville Manufacturing has a no-return policy for this roof curb.
- ⑦ BAYABRD002 is required when ordering BAYDFPS005A or 006A, BAYTUBE008A or 009A and BAYLOAM023A or BAYVNOR002B.
- ⑧ Field or factory installed option.
- * Either horizontal or downflow models

**For additional Controls Information:
See ReliaTel™ and Micro Control features on LPC-13 and LPC-14.**

Packaged Gas/Electric with ReliaTel™ Controls 12½-25 Tons Accessories

Table LPG-18-A — Field Installed Accessories

Model Number	Description	Used With
BAYHSMT039B ^{①④}	5HP Oversized Motor Kit (208-230/460V)	YS*150F
BAYHSMT040B ^④	5HP Oversized Motor Kit (575V)	YS*150F
BAYHSMT055B ^{①④}	5HP Oversized Motor Kit (208-230/460V)	YS*180F
BAYHSMT042A ^{②④}	7-1/2HP Oversized Motor Kit (575V)	YS*210F, 240F, YH*210F, 240F
BAYHSMT072A ^{②④}	7-1/2HP Oversized Motor Kit (575V)	YS*180F, YH*180F
BAYHSMT098A ^{②④}	7-1/2HP Oversized Motor Kit (230V)	YH*210F, YH*240F
BAYHSMT099A ^{②④}	7-1/2HP Oversized Motor Kit (460V)	YH*210F, YH*240F
BAYLOAM023A ^③	Evaporator Defrost Control	YS*150F, YH*150F, YS*180F, YS*210F, 240F, 300F
BAYLOAM031A	Evaporator Defrost Control	YH*210F, 240F, 300F, 180F
BAYLPKT018A	LP Conversion Kit	YC*150F-YC*301F
BAYLSDR004A ^②	Low Static Drive	YS*150F, 180F, 210F, YH*210F, YS*240F, YH*241F
BAYLSDR002A ^②	Low Static Drive	YH*150F, 180F, YS*300F
BAYPWRX029A	Power Exhaust for all Voyagers 12½-25 Ton 230V units	Downflow Only
BAYPWRX030A	Power Exhaust for all Voyagers 12½-25 Ton 460V units	Downflow Only
BAYPWRX031A	Power Exhaust for all Voyagers 12½-25 Ton 575V units	Downflow Only
BAYSERV001A	Selective Resistance Service Tester	YC*150F-YC*301F
BAYSTAT023	Remote Potentiometer	YC*150F-YC*301F
BAYTUBE008A ^{③④}	Discharge Air Sensing Kit	YCD150F-YCD301F
BAYTUBE009A ^{③④}	Discharge Air Sensing Kit	YCH150F-YCH301F
BAYQACB044A	Adapter Curb	BAYCURB026A/B to BAYCURB027A/B
BAYVNOR002B ^③	Ventilation Override Kit	YC*150F-YC*301F

① High static drive and oversized motors are mutually exclusive, Do Not Combine.
 ② Low static drive and oversized motors are mutually exclusive, Do Not Combine.
 ③ BAYABRD002 is required when ordering BAYDFPS005A or 006A, BAYTUBE008A or 009A and BAYLOAM023A, BAYLOAM031A or BAYVNOR002B.
 ④ Field or factory installed option.
 * Either horizontal or downflow models

Light Commercial
Packaged Gas/Electric

Packaged Gas/Electric with ReliaTel™ Controls 12½-25 Tons, R-22, R-410A Zone Sensors / Thermostats

Table LPG-18-A — Zone Sensors — ReliaTel™

Model Number	Description	Used With
ASYSTAT106A	Single Setpoint Manual Changeover	YC*150-301
ASYSTAT108A	Dual Setpoint Manual or Automatic Changeover	YC*150-301
ASYSTAT111A	Remote Room Sensor	ASYSTAT777A
ASYSTAT777A	Programmable Night Setback	YC*150-301
ASYSTAT710A	Wall Mounted Humidity Sensor	YHD150, 180, 240F (with Reheat)
ASYSTAT711A	Duct Mounted Humidity Sensor	YHD150, 180, 240F (with Reheat)
BAYMTPL110A	Retrofit Wall Cover Plate Kit 7.25" x 6.0"	ASYSTAT777A

**For additional Controls Information:
See ReliaTel™ and Micro Control features on LPC-13 and LPC-14.**

Packaged Unit Accessories 12 1/2-25 Tons

12 1/2 – 25 Ton Packaged Gas/Electric,
Electric/Electric and Heat Pump

Dedicated Airflow Design

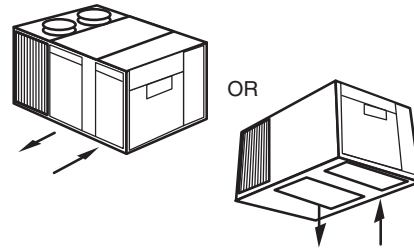

Typical Downflow Application

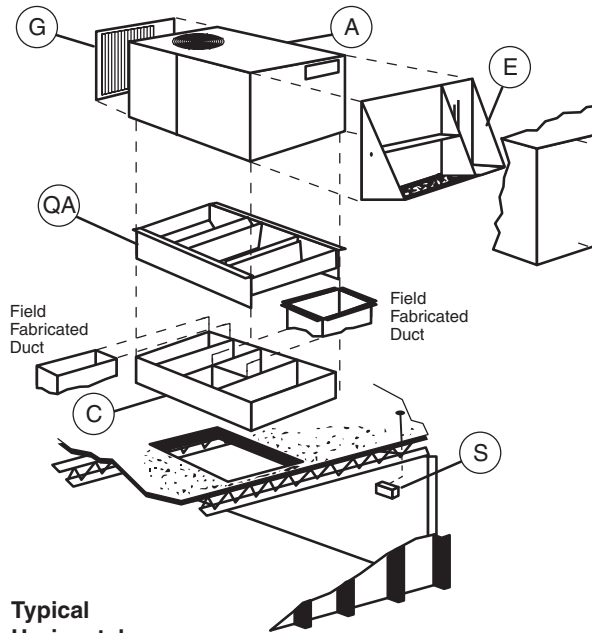

Typical Horizontal Application

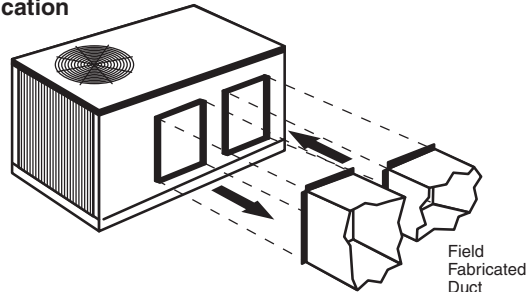

Typical Economizer Application

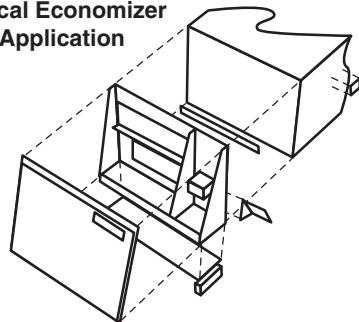

Factory Supplied Accessories

- (A) Unit
Y*D/H, T*D/H, WSD/H
- (G) Coil Guard (BAYGARD)
- (E) Economizer (Downflow and Horizontal) (BAYECON)
- (D) Fresh Air Damper (BAYDMPR)
Manual (0-25%) Motorized (0-50%)
- (S) Sensor/Thermostat
- (C) Curb (BAYCURB)
- (QA) Quick Adapt Curb...Field Supplied (BAYCURB)
- (PE) Power Exhaust (BAYPWRX)

Power Exhaust Accessory

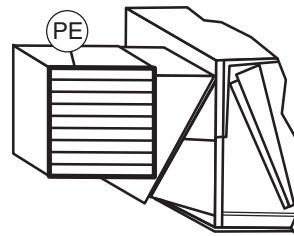

Foundation™ Packaged Gas/Electric 15-25 Tons, R-410A

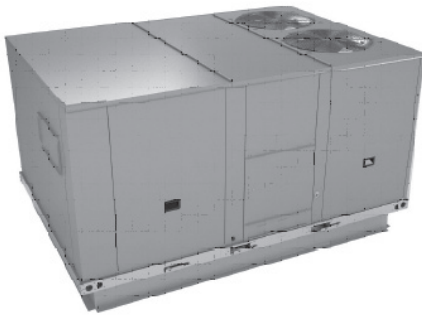

- Scroll compressors on all units
- Operating charge of R-410A
- Low ambient operation to 40°F as standard
- Color coded and numbered wiring
- Single side service access
- Molded handles on service access doors
- Liquid Line Refrigerant Drier
- Provisions for through the base connections
- Phase monitor on all units
- Convertible airflow on most models
- Two inch throwaway filters as standard
- Non-corrosive & removable drain pan
- Separated high and low voltage compartments
- **5-year limited compressor and heat exchanger warranty (15 & 17-1/2 tons)**
- **1-year limited compressor and heat exchanger warranty (20 & 25 tons)**

Table LPG-20-A — Foundation™ — R-410A — Electromechanical Controls

Tons	Unit Model No.	Power Supply Volts/Phase/Hz	Performance EER	Cooling Capacity (Btuh)	Heating Output Capacity (Btuh)	Dimensions (in.) H x W x L	Shipping Weight (lbs.)	MCA	Max Fuse Size or Max Circuit Breaker ^②	Downflow Roofcurb
GAC - Three Phase Low Heat										
15	GAC180A3ELA0000	208-230/3/60	11.0	183,000	192,000	58 ⁵ / ₈ x 86 ⁵ / ₁₆ x 123 ¹ / ₈	2,183	79	100	BAYCURB027B
17 ¹ / ₂	GAC210A3ELA0000	208-230/3/60	11.0	212,000	192,000	58 ⁵ / ₈ x 86 ⁵ / ₁₆ x 123 ¹ / ₈	2,238	91	110	BAYCURB027B
20	GAC240A3ELA0000	208-230/3/60	10.0	252,000	192,000	58 ⁵ / ₈ x 86 ⁵ / ₁₆ x 123 ¹ / ₈	2,327	117	150	BAYCURB027B
25	GAC300A3ELA0000	208-230/3/60	10.0	290,000	192,000	58 ⁵ / ₈ x 86 ⁵ / ₁₆ x 123 ¹ / ₈	2,327	124	150	BAYCURB027B
15	GAC180A4ELA0000	460/3/60	11.0	183,000	192,000	58 ⁵ / ₈ x 86 ⁵ / ₁₆ x 123 ¹ / ₈	2,183	37	45	BAYCURB027B
17 ¹ / ₂	GAC210A4ELA0000	460/3/60	11.0	212,000	192,000	58 ⁵ / ₈ x 86 ⁵ / ₁₆ x 123 ¹ / ₈	2,238	42	50	BAYCURB027B
20	GAC240A4ELA0000	460/3/60	10.0	252,000	192,000	58 ⁵ / ₈ x 86 ⁵ / ₁₆ x 123 ¹ / ₈	2,327	53	70	BAYCURB027B
25	GAC300A4ELA0000	460/3/60	10.0	290,000	192,000	58 ⁵ / ₈ x 86 ⁵ / ₁₆ x 123 ¹ / ₈	2,327	56	70	BAYCURB027B
15	GAC180AWELA0000	575/3/60	11.0	183,000	192,000	58 ⁵ / ₈ x 86 ⁵ / ₁₆ x 123 ¹ / ₈	2,183	31	40	BAYCURB027B
17 ¹ / ₂	GAC210AWELA0000	575/3/60	11.0	212,000	192,000	58 ⁵ / ₈ x 86 ⁵ / ₁₆ x 123 ¹ / ₈	2,238	34	40	BAYCURB027B
20	GAC240AWELA0000	575/3/60	10.0	252,000	192,000	58 ⁵ / ₈ x 86 ⁵ / ₁₆ x 123 ¹ / ₈	2,327	42	50	BAYCURB027B
25	GAC300AWELA0000	575/3/60	10.0	290,000	192,000	58 ⁵ / ₈ x 86 ⁵ / ₁₆ x 123 ¹ / ₈	2,327	47	60	BAYCURB027B
GAC - Three Phase Medium Heat										
15	GAC180A3EMA0000	208-230/3/60	11.0	183,000	256,000	58 ⁵ / ₈ x 86 ⁵ / ₁₆ x 123 ¹ / ₈	2,183	79	100	BAYCURB027B
17 ¹ / ₂	GAC210A3EMA0000	208-230/3/60	11.0	212,000	256,000	58 ⁵ / ₈ x 86 ⁵ / ₁₆ x 123 ¹ / ₈	2,238	91	110	BAYCURB027B
20	GAC240A3EMA0000	208-230/3/60	10.0	252,000	256,000	58 ⁵ / ₈ x 86 ⁵ / ₁₆ x 123 ¹ / ₈	2,327	117	150	BAYCURB027B
25	GAC300A3EMA0000	208-230/3/60	10.0	290,000	256,000	58 ⁵ / ₈ x 86 ⁵ / ₁₆ x 123 ¹ / ₈	2,327	124	150	BAYCURB027B
15	GAC180A4EMA0000	460/3/60	11.0	183,000	256,000	58 ⁵ / ₈ x 86 ⁵ / ₁₆ x 123 ¹ / ₈	2,183	37	45	BAYCURB027B
17 ¹ / ₂	GAC210A4EMA0000	460/3/60	11.0	212,000	256,000	58 ⁵ / ₈ x 86 ⁵ / ₁₆ x 123 ¹ / ₈	2,238	42	50	BAYCURB027B
20	GAC240A4EMA0000	460/3/60	10.0	252,000	256,000	58 ⁵ / ₈ x 86 ⁵ / ₁₆ x 123 ¹ / ₈	2,327	53	70	BAYCURB027B
25	GAC300A4EMA0000	460/3/60	10.0	290,000	256,000	58 ⁵ / ₈ x 86 ⁵ / ₁₆ x 123 ¹ / ₈	2,327	56	70	BAYCURB027B
15	GAC180AWEMA0000	575/3/60	11.0	183,000	256,000	58 ⁵ / ₈ x 86 ⁵ / ₁₆ x 123 ¹ / ₈	2,183	31	40	BAYCURB027B
17 ¹ / ₂	GAC210AWEMA0000	575/3/60	11.0	212,000	256,000	58 ⁵ / ₈ x 86 ⁵ / ₁₆ x 123 ¹ / ₈	2,238	34	40	BAYCURB027B
20	GAC240AWEMA0000	575/3/60	10.0	252,000	256,000	58 ⁵ / ₈ x 86 ⁵ / ₁₆ x 123 ¹ / ₈	2,327	42	50	BAYCURB027B
25	GAC300AWEMA0000	575/3/60	10.0	290,000	256,000	58 ⁵ / ₈ x 86 ⁵ / ₁₆ x 123 ¹ / ₈	2,327	47	60	BAYCURB027B
GAD - Three Phase High Heat^①										
15	GAD180A3EHA0000	208-230/3/60	11.0	183,000	280,000	58 ⁵ / ₈ x 86 ⁵ / ₁₆ x 123 ¹ / ₈	2,183	79	100	BAYCURB027B
17 ¹ / ₂	GAD210A3EHA0000	208-230/3/60	11.0	212,000	320,000	58 ⁵ / ₈ x 86 ⁵ / ₁₆ x 123 ¹ / ₈	2,238	91	110	BAYCURB027B
20	GAD240A3EHA0000	208-230/3/60	10.0	252,000	320,000	58 ⁵ / ₈ x 86 ⁵ / ₁₆ x 123 ¹ / ₈	2,327	117	150	BAYCURB027B
25	GAD300A3EHA0000	208-230/3/60	10.0	290,000	320,000	58 ⁵ / ₈ x 86 ⁵ / ₁₆ x 123 ¹ / ₈	2,327	124	150	BAYCURB027B
15	GAD180A4EHA0000	460/3/60	11.0	183,000	280,000	58 ⁵ / ₈ x 86 ⁵ / ₁₆ x 123 ¹ / ₈	2,183	37	45	BAYCURB027B
17 ¹ / ₂	GAD210A4EHA0000	460/3/60	11.0	212,000	320,000	58 ⁵ / ₈ x 86 ⁵ / ₁₆ x 123 ¹ / ₈	2,238	42	50	BAYCURB027B
20	GAD240A4EHA0000	460/3/60	10.0	252,000	320,000	58 ⁵ / ₈ x 86 ⁵ / ₁₆ x 123 ¹ / ₈	2,327	53	70	BAYCURB027B
25	GAD300A4EHA0000	460/3/60	10.0	290,000	320,000	58 ⁵ / ₈ x 86 ⁵ / ₁₆ x 123 ¹ / ₈	2,327	56	70	BAYCURB027B
15	GAD180AWEHA0000	575/3/60	11.0	183,000	280,000	58 ⁵ / ₈ x 86 ⁵ / ₁₆ x 123 ¹ / ₈	2,183	31	40	BAYCURB027B
17 ¹ / ₂	GAD210AWEHA0000	575/3/60	11.0	212,000	320,000	58 ⁵ / ₈ x 86 ⁵ / ₁₆ x 123 ¹ / ₈	2,238	34	40	BAYCURB027B
20	GAD240AWEHA0000	575/3/60	10.0	252,000	320,000	58 ⁵ / ₈ x 86 ⁵ / ₁₆ x 123 ¹ / ₈	2,327	42	50	BAYCURB027B
25	GAD300AWEHA0000	575/3/60	10.0	290,000	320,000	58 ⁵ / ₈ x 86 ⁵ / ₁₆ x 123 ¹ / ₈	2,327	47	60	BAYCURB027B

① Downflow Airflow Configuration Only - High Heat Models.

② HACR Circuit Breaker Type Per NEC.

Information subject to change. Please confirm with current Product Data for current factory production.

For complete equipment / combination selections, installation instructions and warranty information, please refer to Product Data/Ratings and/or Installers Guides and Limited Warranty Handbooks.

Foundation™ Packaged Gas/Electric 15-25 Tons Accessories

Table LPG-21-A — Foundation™ — R-410A— Field Installed Accessories

Model Number	Description	Used With
BAYTBUE300A	Through the Base Electrical Connections	All Foundation 15-25 Ton Units
BAYDSCF300A	Unit Mounted Disconnect, 100 Amp	GA*180A4* - GA*300A4*, GA*180AW* - GA*300AW*
BAYDSCF301A	Unit Mounted Disconnect, 150 Amp	GA*180A3* - GA*300A3*
BAYTBGF300A	Through the Base Gas Connection, 400 MBH	GA*180A* - GA*300A*
BAYLPKT300A	Propane Conversion Kit	GA*180A* - GA*300A*
BAYHAKT300A	High Altitude Conversion Kit	GA*180A* - GA*300A*
BAYDMPR301A	Damper, Manual	GA*180A* - GA*300A*
BAYDMPR300A	Damper, Motorized	GA*180A* - GA*300A*
BAYECON300A	Economizer, Dry Bulb, Downflow	GA*180A* - GA*300A*
BAYECON301A	Economizer, Dry Bulb, Horizontal	GA*180A* - GA*300A*
BAYHZCN300A	Horizontal Economizer Conversion Kit	GA*180A* - GA*300A*
BAYBARO300A	Barometric Relief Damper, 15-25T	GA*180A* - GA*300A*
BAYENTH300A	Reference Enthalpy Economizer	GA*180A* - GA*300A*
BAYENTH301A	Comparative Enthalpy Economizer	GA*180A* - GA*300A*
BAYCURB027B	Roof Curb	GA*180A* - GA*300A*
BAYHZRT001A	Horizontal Duct Conversion Kit	GA*180A* - GA*300A*
BAYCARR001A	Carrier Replacement Conversion Kit	GA*180A* - GA*300A*
BAYGARD300A	Condenser Hail Guard	GA*180A* - GA*300A*
BAYCCHT300A	Crankcase Heater, 70W, 230V	GA*180A3 - GA*300A3
BAYCCHT301A	Crankcase Heater, 70W, 460V	GA*180A4 - GA*300A4
BAYCCHT302A	Crankcase Heater, 70W, 575V	GA*180AW - GA*300AW
BAYASCT001	Compressor Short Cycle Timer	GA*180A* - GA*300A*
BAYLOAM300A	Low Ambient Control	GA*180A* - GA*300A*
BAYLOAM310A	Evaporator Defrost Control	GA*180A* - GA*300A*
BAYPWRX300A	Power Exhaust, 15-25T, DF, 230V	GA*180A3 - GA*300A3
BAYPWRX301A	Power Exhaust, 15-25T, DF, 460V	GA*180A4 - GA*300A4
BAYPWRX302A	Power Exhaust, 15-25T, DF, 575V	GA*180AW - GA*300AW
BAYHSMT300A	High Static Motor & Drv, 5HP 230/460V	GA*180A3, GA*180A4
BAYHSMT301A	High Static Motor & Drv, 5HP 575V	GA*180AW
BAYHSMT302A	High Static Motor & Drv, 7.5HP 230/460V	GA*210A3, GA*240A3
BAYHSMT303A	High Static Motor & Drv, 7.5HP 460V	GA*210A4, GA*240A4
BAYHSMT304A	High Static Motor & Drv, 7.5HP 575V	GA*210AW, GA*240AW
BAYSHGR003A	Shaft Grounding Ring, 0.875" Shaft	5HP VFD Motors
BAYSHGR002A	Shaft Grounding Ring, 1.125" Shaft	7.5HP VFD Motors
BAYSHGR004A	Shaft Grounding Ring, 1.375" Shaft	10HP VFD Motors
BAYLSDR300A	Low Static Drive Option	GA*180A* - GA*300A*
BAYHSDR300A	High Static Drive Option	GA*180A* - GA*300A*
BAYCO2K300A	Wall Mounted CO2 Sensor	GA*180A* - GA*300A* with economizer
BAYCO2K301A	Duct Mounted CO2 Sensor	GA*180A* - GA*300A* with economizer
BAYCOSW300A	Drain Pan Overflow Switch	GA*180A* - GA*300A*
BAYSTAT300A	BACNet Enabled Thermostat	GA*180A* - GA*300A*

① Please check availability.

② See HVAC Knowledge Center for a list of compatible Carrier units.

Information subject to change. Please confirm with current Product Data for current factory production.

Light Commercial
Packaged Gas/Electric

3-25 Ton Packaged Units Roof Curb Compatibility Information

Table LAC/IN-1-A — 3-10 Ton Convertible Packaged Units Roof Curb Compatibility

BAYCURB042			BAYCURB043			BAYCURB044		
T/YSC	T/YHC	WSC	T/YSC	T/YHC	WSC	T/YSC	T/YHC	WSC
036A	033A	036A	072A	072A	072A		092E	120E
048A	036A	048A	090A	092A	090A		102E	
060A	043A	060A	092A	102A	120A		120E	
036E	048A	036E	102A	120A	060E			
048E	060A	048E	120A	048E	072E			
060E	063A		072E	060E	090E			
	036E		090E	072E				
			092E	092E*				
			102E	102E*				
			120E	120E*				

* = This curb is used for retrofit or replacement applications only for these units.

Table LAC/IN-1-B — 12½-25 Ton Packaged Units Roof Curb Compatibility Reference for Packaged Units Manufactured Prior to 2002

BAYCURB021A/B			BAYCURB022A/B			BAYCURB025A/B			BAYCURB026A/B			BAYCURB027A/B		
YCD	TCD	WCD	YCD	TCD	WCD	YCD	TCD	WCD	YCD	TCD	WCD	YCD	TCD	WCD
036A	036C	036C	061C	061C	075A	102A	102A	120A	121C	121C	150A	181B	181B	240A
036C	037C	048C	074C	074C	075C	102B	102B	120B	150A	150A	150B	181C	181C	240B
037C	048C	060C	075A	075A	090A	103B	103B		150B	150B	180A	210A	210A	150E
048A	049C		075B	075B	090C	103C	103C		150D	150D	180B	210B	210B	180E
048C	060C		075C	075C		120A	120A		151B	151B		211B	211B	240E
049C			086C	086C		120B	120B		151C	151C		211C	211C	
060A			090A	090A		121B	121B		180A	180A		240A	240A	
060C			090B	090B		150C	150C		180B	180B		240B	240B	
			090C	090C					210C	210C		241B	241B	
			090D	090D					150E	150E		241C	241C	
			091D	091C								300B	300B	
			102C	091D								301C	301C	
			120C	102C								180E	180E	
				120C								210E	210E	
												211E	211E	
												240E	240E	
												241E	241E	
												300E	300E	
												151E	151E	
												181E	181E	
												301E	301E	

General Notes:

- ① If ordering Thru-The-Base options, the curb must be an April 1994 to present model curb to allow Thru-The-Base connections. The older curb models do not allow for these connections. The units will still fit the curb, but the Thru-The-Base connections will not be available.
- ② **TCD036A, TCD048A, TCD060A, WCD036A, WCD048A, WCD060A** are not 12½-25 Ton units. These units were manufactured in Ft. Smith, AR and will not fit any 12½-25 Ton curbs.
- ③ All horizontal 3-7½ ton, all horizontal 102C, and all horizontal 120C units will fit the downflow curbs, but BAYINSL101A kit must be installed across the bottom of the evaporator section of the unit to prevent condensate leakage into the space.
- ④ If another manufacturer's curb was used initially, the adapter curb may not fit.

Table LAC/IN-1-C — Convertible 3-10 Ton Curb Adapters

Model Number	Description
BAYQACB009A	Quick Adapt Roof Curb Converts BAYCURB021 to Convertible 3 - 5 Ton
BAYQACB010A	Quick Adapt Roof Curb Converts BAYCURB022 to Convertible 3 - 5 Ton
BAYQACB011A	Quick Adapt Roof Curb Converts BAYCURB022 to Convertible 6 - 10 Ton
BAYQACB012A	Quick Adapt Roof Curb Converts BAYCURB025 to Convertible 6 - 10 Ton
BAYQACB013A	Quick Adapt Roof Curb Converts BAYCURB026 to Convertible 6 - 10 Ton
BAYQACB044A	Quick Adapt Roof Curb Converts BAYCURB026 to BAYCURB027
BAYQACB500A	Quick Adapt Roof Curb Converts CRRFCURB001A01 to BAYCURB042A
BAYQACB501A	Quick Adapt Roof Curb Converts CRRFCURB001A01 to BAYCURB043A
BAYQACB502A	Quick Adapt Roof Curb Converts CRRFCURB001A03 to BAYCURB043A

Note: If another manufacturer's curb was used initially, the adapter curb may not fit

For complete equipment / combination selections, installation instructions and warranty information, please refer to Product Data/Ratings and/or Installers Guides and Limited Warranty Handbooks.

6-20 Ton Split Systems

Table LAC/IN-2-A — Cooling Component Selection Summary

UNIT	TTA073D	TTA090D	TTA120D	TTA120E	TTA120F	TTA150E	TTA180E	TTA180F	TTA240E	TTA240F
Refrigerant ckts	1	1	1	2	1 (Manifold)	2	2	1 (Manifold)	2	1 (Manifold)
Minimum step (tons)	6	7.5	10	5	5	6.25	7.5	7.5	10	10
GAS LINE					GAS LINE					
Tube diameter (in.)										
Horizontal (& drops)	1 1/8	1 3/8	1 3/8	1 1/8	1 3/8	1 1/8	1 3/8	1 5/8	1 3/8	1 5/8
Vertical (up)	1 1/8	1 3/8	1 3/8	1 1/8	1 1/8	1 1/8	1 3/8	1 3/8	1 3/8	1 5/8
Access port 3/ckt	Schraeder valve w/ core*	Schraeder valve w/ core*	Schraeder valve w/ core*	Schraeder valve w/ core*	Schraeder valve w/ core*	Schraeder valve w/ core*	Schraeder valve w/ core*	Schraeder valve w/ core*	Schraeder valve w/ core*	Schraeder valve w/ core*
LIQUID LINE					LIQUID LINE					
Tube diameter (in.)	1/2	5/8	1/2	1/2	1/2	1/2	1/2	5/8	1/2	5/8
Filter drier	DHY01123**	DHY01232**	DHY01123**	DHY01123**	DHY01123**	DHY01123**	DHY01123**	DHY01131**	DHY01123**	DHY01132**
Sight glass 1/ckt	GLS00853	GLS00830	GLS00853	GLS00853	GLS00853	GLS00853	GLS00853	GLS00830	GLS00853	GLS00830
Access port 2/ckt	Schraeder valve w/ core*	Schraeder valve w/ core*	Schraeder valve w/ core*	Schraeder valve w/ core*	Schraeder valve w/ core*	Schraeder valve w/ core*	Schraeder valve w/ core*	Schraeder valve w/ core*	Schraeder valve w/ core*	Schraeder valve w/ core*

Check valve selections: 3/8 = VAL08459, 1/2 = VAL08460, 5/8 = VAL01722

Table LAC/IN-2-B — TWA Component Selection Summary

UNIT	TWA073D	TWA090D	TWA120D	TWA180E	TWA240E
Refrigerant ckts	1	1	1	2	2
Minimum step (tons)	6	7.5	10	7.5	10
GAS LINE					
Tube diameter (in.)					
Horizontal (& drops)	1 1/8	1 3/8	1 3/8	1 3/8	1 3/8
Vertical (up)	1 1/8	1 3/8	1 3/8	1 3/8	1 3/8
Access port 3/ckt	Schraeder valve w/core*	Schraeder valve w/core*	Schraeder valve w/core*	Schraeder valve w/core*	Schraeder valve w/core*
LIQUID LINE					
Tube diameter (in.)	1/2	5/8	1/2	1/2	5/8
Filter drier	DHY01123 (QTY 2)**		DHY01123 (QTY 2)**	DHY01123 (QTY 2)**	DHY01123 (QTY 2)**
Sight glass 1/ckt	GLS00853	GLS00830	GLS00853	GLS00853	GLS00853
Access port 2/ckt	Schraeder valve w/core*	Schraeder valve w/core*	Schraeder valve w/core*	Schraeder valve w/core*	Schraeder valve w/core*

Check valve selections: 3/8 = VAL08459, 1/2 = VAL08460, 5/8 = VAL01722

*Valve body VAL01483, valve core COR00006, valve cap CAP00072.

**The heat pump products require two filters and two check valves: one set-oriented for liquid in the cooling direction, and one set-oriented for liquid in the heating direction. For units with line lengths in excess of 80 ft, the included filters must be removed and filters from the table must be installed close to the air handler.

Table LAC/IN-2-C — Expansion Valves for TTA/TWA 6-20 Ton Applications*

Refrigerant	Manufacturer	Tonnage Range	Model Number	Part Number	Model Number w/ Check Valve	Part Number
R-410A	Sporlan	2-3	ERZE-2-ZGA	VAL09476	RCZE-2.0-ZGA	VAL08085
R-410A	Sporlan	3-4	ERZE-3-ZGA	VAL09477	RCZE-3.0-ZGA	VAL08086
R-410A	Sporlan	4-5	ERZE-4-ZGA	VAL09478	RCZE-4.0-ZGA	VAL08087
R-410A	Sporlan	5-6	ERZE-5-ZGA	VAL09479	RCZE-5.0-ZGA	VAL08088
R-410A	Sporlan	6-8	ERZE-6-ZGA	VAL09480	RCZE-6.0-ZGA	VAL08089
R-410A	Sporlan	8-11	ERZE-8-ZGA	VAL09481	—	—
R-410A	Sporlan	11-14	ERZE-12½-ZGA	VAL09482	—	—
R-410A	Sporlan	14-17	ERZE-15-ZGA	VAL09483	—	—
R-410A	Sporlan	17-23	OZE-20-ZGA	VAL09485	—	—

This page contains limited data to fully determine if the application will work or to select required accessories. Please refer to publication SS-APG009-EN for complete details and examples.

For complete equipment / combination selections, installation instructions and warranty information, please refer to Product Data/Ratings and/or Installers Guides and Limited Warranty Handbooks.

6-20 Tons Split System

Table LAC/IN-3-A — Allowable Elevation Difference: Cooling-only TTA above indoor unit

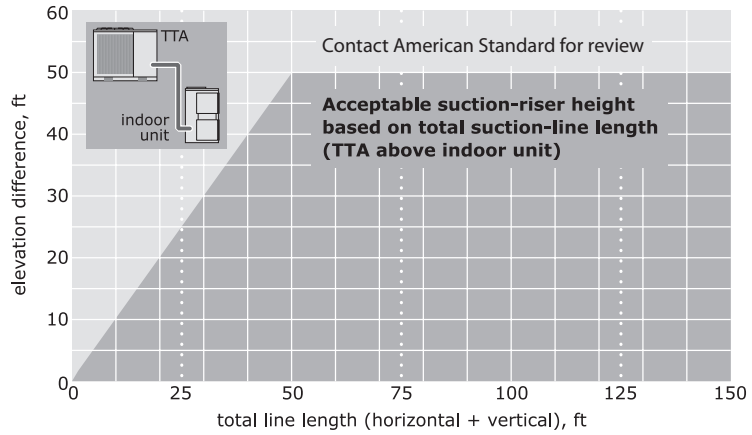

Table LAC/IN-3-B — Allowable Elevation Difference: TWA heat pump above indoor unit

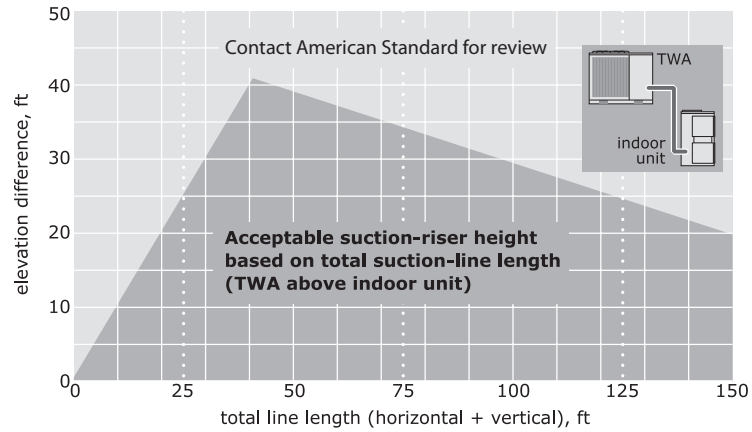
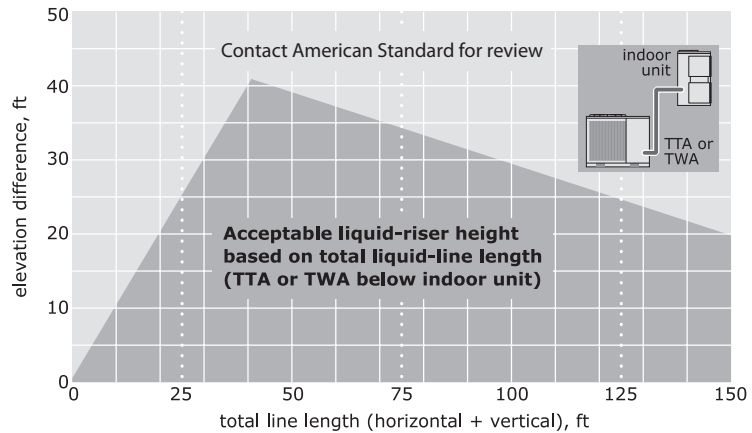

Table LAC/IN-3-C — Allowable Elevation Difference: TTA or TWA above indoor unit



American Standard[®]
HEATING & AIR CONDITIONING

6200 Troup Highway
Tyler, Texas 75707

<http://www.americanstandardair.com>

© 2014 American Standard Heating & Air Conditioning All rights reserved