



◆-----◆
Steel Roofing & Siding

Installation Guide
◆-----◆

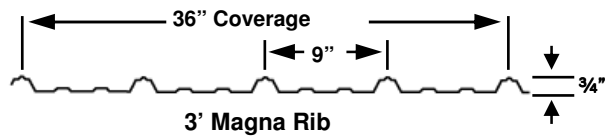
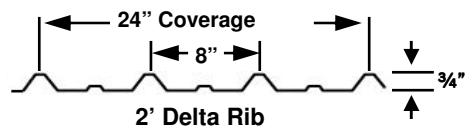



TABLE OF CONTENTS

Page	Descriptions
3	Disclaimers / Care & Maintenance
4-5	Safety Notes / Handling
6	Storage / Cutting
7	Insulation/Vapor Barrier/Underlayment
8-9	Panel Installation
10	Rodent Guard / C Casing
11	Jamb Cap / Outside Corner
12	Eave Trim / W Valley Flashing
13	Endwall Flashing / Sidewall Flashing
14	Transition Pitch Change
15	Prow Gable Trim
16	Gable Trim / Top Shed Flashing
17	Ridge Cap
18	Vent Pipe Flashing
19	Last Panel Termination
20	Panel Appendix
21	Trim Application Appendix
22-23	Sliding Door Assembly
24	Contact Us



DISCLAIMERS

This guide should be read in its entirety before beginning installation. This guide is supplied by Metallion Industries for use by its customers. These instructions do not replace or supercede local or state building codes, and do not portray all situations. Contact your contractor, architect, or local building department for further assistance if needed.

Metallion Industries will not assume any responsibility for personal injury, property damage, or other problems which may result from improper installation or other usage of the products.

The specifications and drawings in this manual are subject to change without notice or obligation to make changes in products previously purchased.

CARE & MAINTENANCE

Steel roofing usually requires very little maintenance. If you have a low pitch roof and/or valleys, you may need to remove debris or residue from the roof to prevent the trapping of moisture against the metal. Some flashings may need to be re-sealed periodically in order to maintain optimum weather-tightness.

If you need to wash the roof, you can use a pressure washer and/or use a mixture of one cup detergent (containing less than .5% phosphate) mixed with five gallons of warm water. Another mixture could be one cup of household ammonia mixed with five gallons of warm water.

Wear clean, non-marking, soft soled shoes when walking on the panels to avoid shoe marks or damage to the finish.



SAFETY NOTES

Never use unsecured or partially installed panels as a working platform. Do not walk on panels until they are in place on the roof and the fasteners are installed.

Metal roofing panels can be very slippery when wet, dusty, frosty, or oily. Do not attempt to walk on a metal roof under these conditions. Wearing soft soled shoes will improve traction and minimize damage to the painted surface.

Always take note of your surroundings when on the roof. Be aware of the locations of roof openings, roof edges, equipment, co-workers, etc.

Always wear proper clothing and safety attire. Wear proper clothing, eye protection, and gloves when working with sheet metal in order to minimize the potential for cuts, abrasions and other injuries. Hearing protection should be used when power-cutting metal panels. When working on a roof, fall protection is highly recommended. Follow all OSHA Safety requirements.

Installing metal roofing or flashing on windy days can be hazardous to your health and should be avoided if possible.



HANDLING PANEL BUNDLES

Handling panels with care is important, from the time it arrives at the jobsite until it is installed on the structure. Depending on how the panels are packaged, it may be necessary to use a spreader bar with a crane or forklift. Reckless maneuvering or too much handling and moving can cause the panels to rub against each other and mar the painted surface.

**Use a spreader bar
to support long loads**

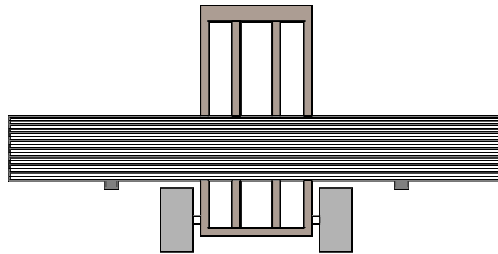

**Use double straps when lifting
long loads with a crane, not single**

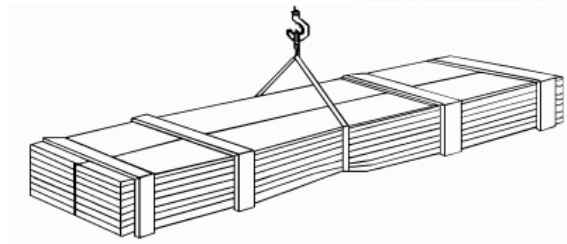



STORAGE

Store the panels and other materials in a dry, well ventilated area, away from traffic. Storing panels in a wet condition can cause the deterioration of the painted surface, so you need to elevate one end of the bundle (see illustration). Any moisture that may have accumulated during shipping can then run off.

If outdoor storage cannot be avoided, protect the metal with a breathable canvas or waterproof paper cover. Leave the bottom of the cover loose to allow air circulation. Do not use plastic which causes sweating or condensation.

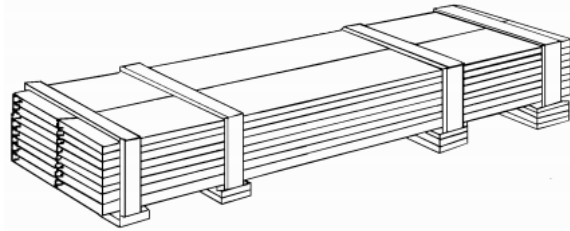

CUTTING

Steel panels and trim should be cut with nibblers, tin snips, a profile shear, or a circular saw with a steel-cutting blade. When using a steel-cutting blade, make sure that all filings are cleaned off of the panel after cutting, as they will rust and pit the surface of the panel.

Some homeowners use a wood saw blade turned around backward in the saw, which is generally not recommended. Do not use an abrasive blade—it will burn the paint and galvanizing at the cut edge and will void the warranty.



INSULATION/VAPOR BARRIER

We recommend that you install a vapor barrier (either insulated or non-insulated) before installing the roof panels. This will help prevent your building from sweating. See a Sales person for condensation control options.

Ruffco or similar non-insulated vapor barrier is installed the same way as CCB (condensation control blanket), Low -E Foil, or Vapor Plus. Start the roll at the eave line and unroll it up and over the ridge down to the opposite eave line. If you are venting through the ridge, you will need to cut the vapor barrier at the ridge and leave a 3-4" gap to allow air movement. The insulation should be used as soon as possible after it arrives at the job site to minimize chances of damage.

Over solid sheeting, apply either 15# or 30# felt paper horizontally starting at the eave line lapping a minimum of 3" as you work towards the ridge line. Ice and water shield (smooth, not granulated) is also an acceptable underlayment. A #14 Type "S" screw may be used in this application for better wind resistance.

FRAMING

Girt spacing should be no more than 36" for normal siding applications. It is recommended that the purlin spacing for roofing be no more than 24" for normal application with a slope of at least 2-1/2" per foot. See your engineered plans for design specifications. The recommended slope is 4" per foot for larger buildings with long runs.



PANEL INSTALLATION

Both roofing and siding should be started vertically at the end of the building, opposite the direction of the prevailing winds (see illustration #1). Prior to installation of panels, any flashing going underneath the panel should be installed. Otherwise, always begin flashing installation from the bottom and work up. It is imperative, when installing PBR, that the short leg of the panel be installed on top of the full load-bearing leg. When installing Magna Rib or Delta Rib, you must make sure that the side of the panel with the anti-siphon groove is the bottom lap. (See Panel Appendix page)

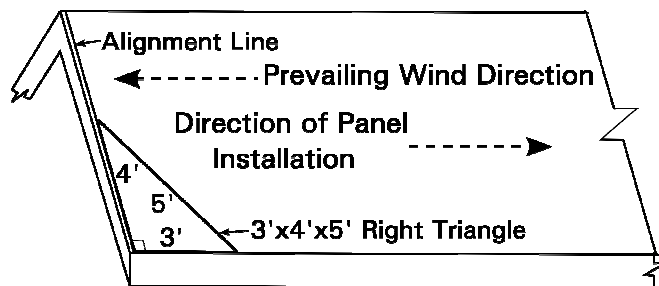

Place an alignment line along the gable end where the first roof panel will be installed. Check roof for squareness by making a 3' line across the eaves. (see illustration #1). Completing the 3' x 4' x 5' right angle triangle should place the 4' edge (or the 3' edge) of the triangle parallel with the gable. (You can use any multiples of 3', 4', 5', such as 6', 8', 10', or 9', 12', 15' for a larger, more accurate square.) If the roof is out of square, **align the first panel with the eave edge**. Slight variations or out-of-square conditions can be covered by the gable trim.



PANEL INSTALLATION, cont.

Overhang at eave edge: depending on the pitch of the roof, the use or absence of gutters, and other circumstances, we recommend an overhang anywhere from ½" to 2". The ridge cap will compensate for slight differences in panel length at the peak.

Align the edge of the first panel with the alignment line constructed along the starting gable. Lay down the second and third panels, checking the alignment, and making sure they are square. This will ensure that a sawtooth effect at the eaves and ridge is avoided.

Fastening: The screws should be installed in the flat area adjacent to the ribs, and tightened so that the washer is compressed properly. Proper tightening and location of fasteners will help insure a leak-resistant roof. See Panel Appendix page for illustrations.

Siding: Metal siding should be installed using the standard fastening and overlap patterns. Do not run the siding sheets all the way to the ground. Instead, use a protective base of concrete, treated wood, or similar material and stop the siding sheets 6" above grade.

Weatherproofing: On the PBR profile, installers should use sidelap tape and stitch screws where the sides of the panels overlap. Although it is not required, these accessories will offer better leak protection as well as a better wind uplift protection. For more complete weatherproofing, use closure tapes, regardless of pitch. When endlapping panels, Clear Seal or butyl tape should be used at the end of both the top and bottom sheets where the sheets overlap. End lapping, depending on the pitch of the roof, should never be less than 12".

After you are finished installing the panels and flashing, make sure to remove all tools and debris from the roof. Metal shavings may cause rust marks.



RODENT GUARD

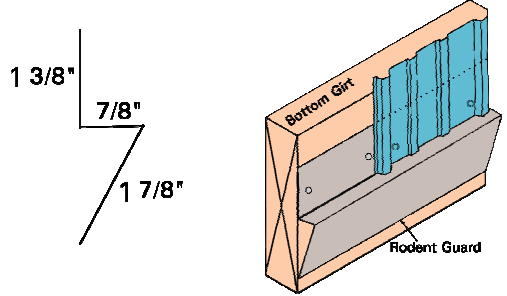

Rodent Guard seals off the bottoms of panels at the floor level, and helps to prevent the entrance of rodents and insects. It also serves well as a base for the setting of panels.

C CASING

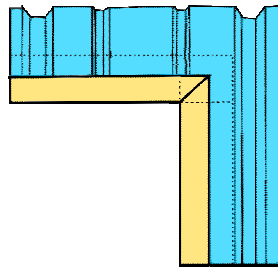
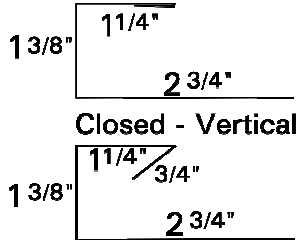
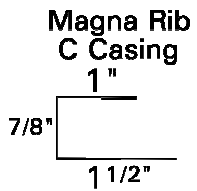

C Casing is used to trim around the bottom, sides, and top of windows and doors. It can also be used to cap raw panel edges (vertically) or to cap the panel end (i.e. horizontally at the top of a wall).



JAMB CAP

1 1/2" C Jamb - Specify width | 1"

1 1/2" L Jamb - Specify width

Jamb Cap is used for trimming around overhead doors. It can be either a "C" shape or "L" shape. There are two options for fastening: nail through each small leg on the "C" shape, or screw through the face on the "L" shape.

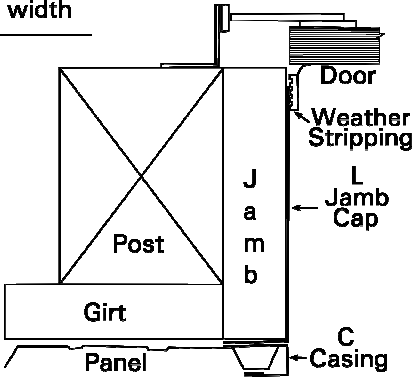

OUTSIDE CORNER

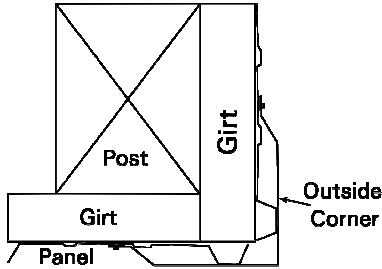
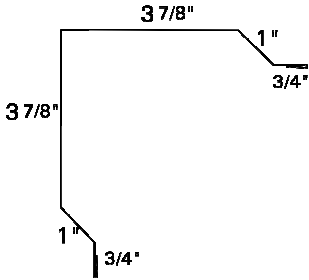

The Outside Corner straddles the ribs of the panels where they meet at the corner of the building. The Inside Corner has similar dimensions but with a reverse middle bend.



EAVE TRIM

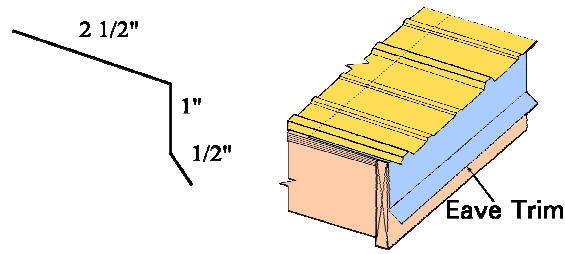

Install the eave trim using low profile screws or nails before installing the panels. For 2/12 roof pitch or less, apply a bead of Clear seal on top of the trim, below the line of screws. You may also use solid foam closure under the panel on top of the Eave Trim to stop rain, snow, etc. from blowing in underneath the panel.

W-VALLEY FLASHING

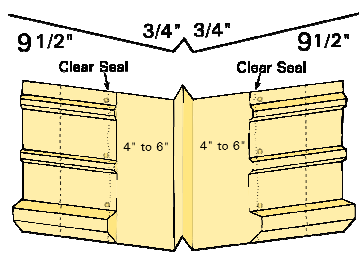

Install W-valley flashing with low profile screws. Cut the panels at the angle of the valley. For 2/12 roof pitch or less, apply a bead of Clear seal on top of the W-valley, below the line of screws.

It is important to leave 4 - 6 inches between the end of the panels and the middle "V" of the W-valley to allow water and debris to drain off properly.



ENDWALL FLASHING

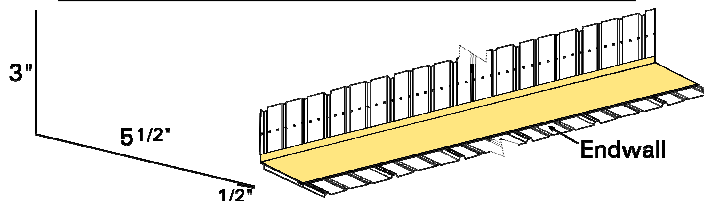

Endwall is used where the end of the panel runs into the wall. After installing panels, fasten lower edge of flashing to roof panel ribs with $\frac{3}{4}$ " stitch screws. For the most weather-tight application, the 3" upper leg needs to go behind your wall siding. If that is not an option, fasten screws through the upper leg of the flashing into wood siding with Clear behind the Endwall flashing. If you have metal siding, you may also install solid foam closure behind the upper leg of the flashing to stop rain, snow, etc. from falling in between the ribs of the panel. You may also install solid foam closure to stop rain, snow, etc. from blowing in between the roof panels and the bottom leg of the Endwall flashing.

SIDEWALL FLASHING

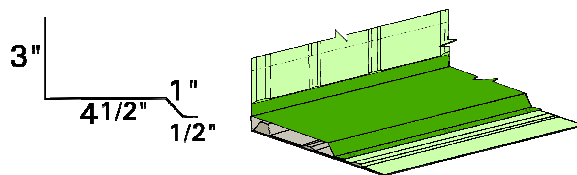

Sidewall flashing is applied when the side of the roof panel runs along an adjacent wall. For the most weather-tight application, the 3" upper leg needs to go behind your wall siding. If that is not an option, see the instructions listed above under Endwall Flashing.



TRANSITION PITCH CHANGE

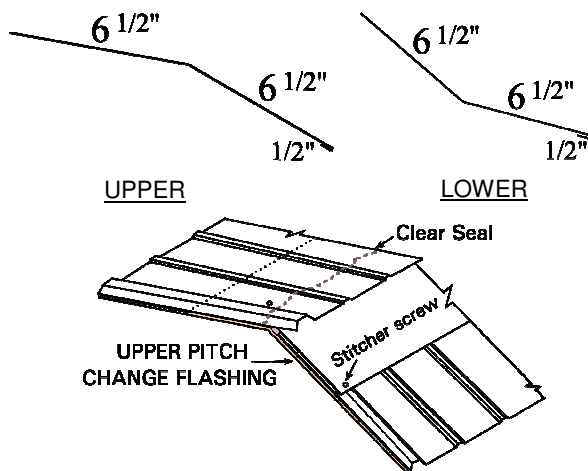

Install panels on the lower pitch first. Under the Pitch Change, you may want to install solid foam closure to stop rain, snow, fir needles, etc. from blowing up under the flashing.

Install the flashing over the lower panels using 3/4" stitcher screws at each rib and/or low profile screws on the top leg of the flashing, under where the upper panels will be.

Before installing the upper panels, lay a bead of approved sealant for the upper panels to sit on. Be sure this bead is downhill of the low profile screws. Install the upper panels, covering the low profile screws.

Note: When installing the lower roof's panels, make sure to leave enough room for the flashing and the upper roof panel ribs.

Note: We need both pitches to fabricate the flashing. Give the pitch of the upper roof, then the lower roof; e.g. 5/12 - 2/12.



PROW GABLE TRIM

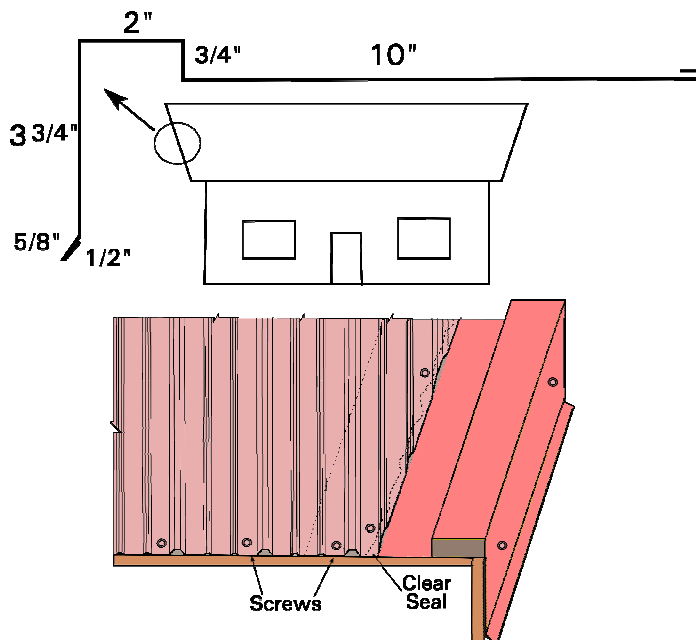

This gable trim is designed for use on a prow-type roof where the ridge is wider than the eave. It is applied the same way as W-Valley. It is basically half of a valley.

Fasten the Prow Gable at two places: to the fascia board every 12"-24" with exposed painted trim fasteners, and on the roof deck with low profile screws under where the panels will be.

Before installing the panels, run a bead of approved sealant or mastic under the panels below the screws as illustrated above. Be sure to back the ribs off of the panels about 2 to 4 inches from the raised portion of the flashing to allow water and debris to drain off the roof and not accumulate.



GABLE TRIM

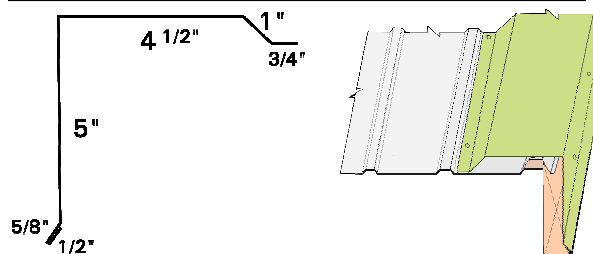

The Gable trim is installed on top of the panel over the rib before the Ridge cap is installed. It is fastened to the fascia board approximately every 24" with 1/4" hex head screws.

If the rib of the last panel does not end flush with the gable edge, you'll need to make an artificial rib by cutting the panel vertically 3/4" past the fascia and bending that 3/4" up to form a rib. Refer to the Last Panel Termination page for detailed instructions.

TOP SHED FLASHING

The Top Shed flashing is simply a Ridge Cap for a single-sloped roof. Refer to the section on Ridge Cap for venting, non-venting, and closure options. Install the roof panels by lining them up with the eaves. After the Gable trim is installed, fasten the Top Shed flashing at every rib of each panel with 3/4" stitch screws. You may also fasten through the face of the Top Shed flashing into the fascia or the wall siding.

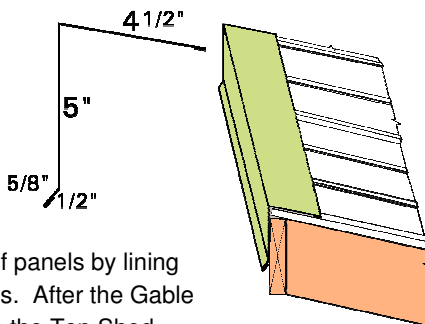



**METALLION
INDUSTRIES**

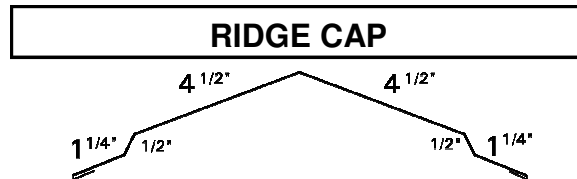

The Ridge cap is used to seal the point at which two upward slopes meet. This can be both along the ridge of the roof as well as a covering for a hip. Install the roof panels by lining them up with the eaves. After the Gable trim is installed, fasten the Ridge cap at every rib of each panel with 3/4" stitch screws.

Since debris, insects, and blowing rain can find easy access under the ridge cap, closures are recommended to either completely or partially seal the opening. There are two options for closures:

1. Vented: Use Uni-Vent (breathable) closure between the Ridge cap and the panel. This will allow the building or attic space to breathe.
2. Non-vented: Use solid foam closure, which will not allow the building or attic space to vent under the Ridge cap.

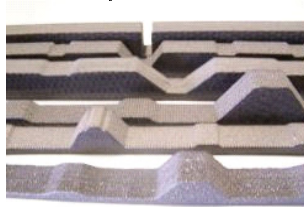
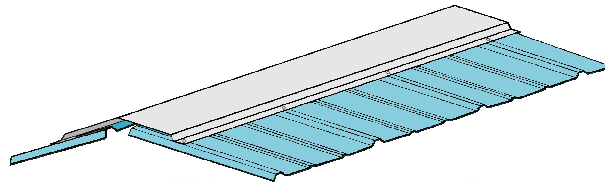



VENT PIPE FLASHING

Aztec Standard Master Flash®

- Made of EPDM or Silicone, these flashings are compounded specifically for maximum resistance to weathering due to ozone and ultra-violet light.
- Fast, one piece construction allows for easy on-site installation in approximately 5 minutes.
- The soft aluminum base is designed to form a seal on most panel configurations and roof pitches regardless of pipe location.

Installation:

1. Trim the pipe flashing to an opening 20% smaller than the pipe.
2. Wet the flashing with water and slide it over the pipe.
3. Press Master Flash down, bending it to conform to roof profile or roof irregularities. A blunt tool will help press flashing into tight roof angles.
4. Apply sealant under the flashing and fasten with roofing screws, spaced no more than 1 1/2" apart.

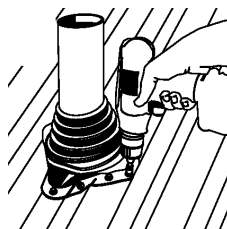

Note: If pipe has a seam, apply sealant where flashing crosses the seam. Apply sealant on upper edge of flashing wherever it is not tight to the roof.



Retrofit Master Flash®

Retrofit Master Flash is designed to seal existing pipes/vents where a standard pull-over flashing cannot be assembled. The split design allows for an easy wrap around installation. Snap rivets and cable tie are included.



LAST PANEL TERMINATION

In case the last panel in a run does not end exactly at the edge, follow these steps to ensure a proper installation.

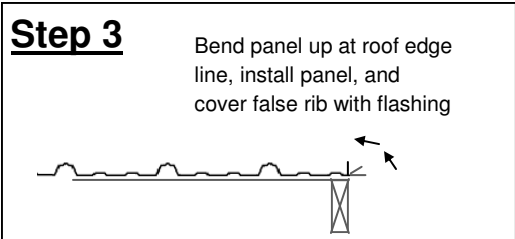
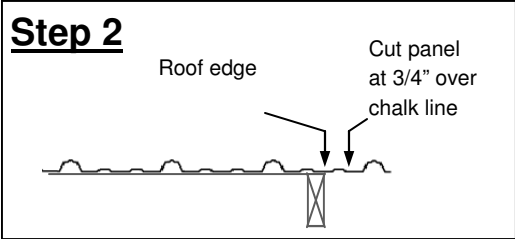
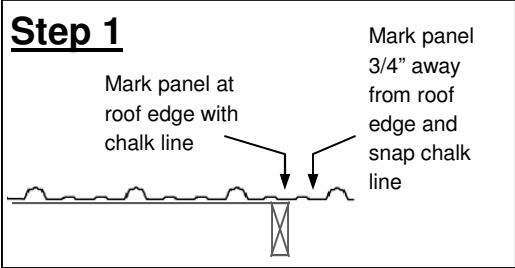



LAP AND FASTENING PATTERNS

The recommended fastening pattern for these panels is next to each rib as noted (horizontally) and every 2' up the panel (vertically). On the PBR panel, the stitch screw is placed every 2' up the rib.

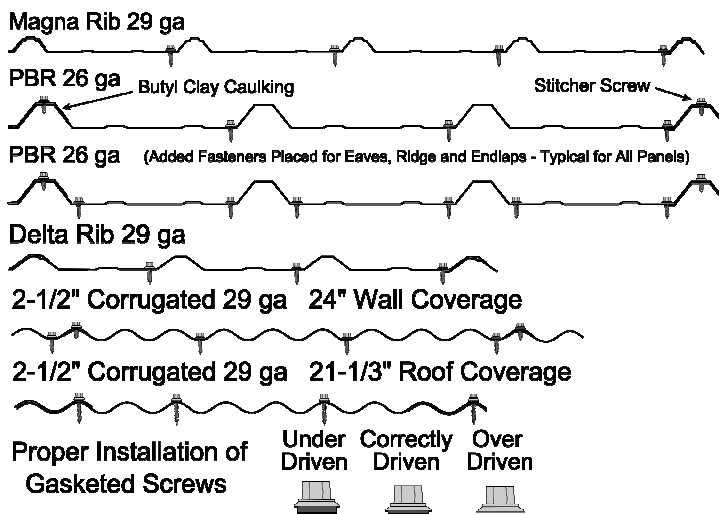



TRIM INSTALLATION DISPLAY

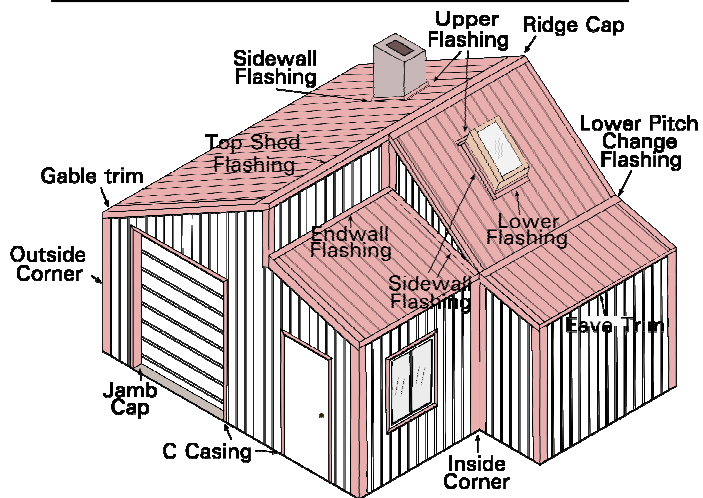



SLIDING DOOR ASSEMBLY

1. Measure the opening, width first, then height. Plan for the door to overlap 1 1/2" to 3" on the width on each side and a 3/4" to 1" overlap on the height.
2. Cut vertical rails to height calculated in Step 1, and the horizontal girts to correct widths. Use a 2 x 6 for the bottom girt. Recommended spacing is 24" for 2 x 4's; 30" on centers for 2 x 6's.
3. In the top horizontal girt, drill (2) 17/32" holes centered 1" in from the inward face and 12" (24" for doors 12' and over) in from each end for mounting trolleys (one hole on each end).
4. Lay vertical rails with J-trim facing upward on a flat, even surface and insert all girts into the verticals. Space girts as noted in Step 2. Allow the 2 x 6 bottom girt to drop 3" below the verticals for clearance of the bottom door guide.
5. Diagonally square the door frame by measuring from corner to corner and adjusting the rails until both measurements are equal. Fasten with one screw in both ends of each girt.
6. Carefully turn the frame over, re-square, and fasten with 2 screws at each corner joint. Fasten all horizontal girts with 4 screws per joint (2 per side).
7. Install metal skin and fasten to each girt. Install trolley hangers in the top rail holes drilled in Step 3. See instructions in trolley package.

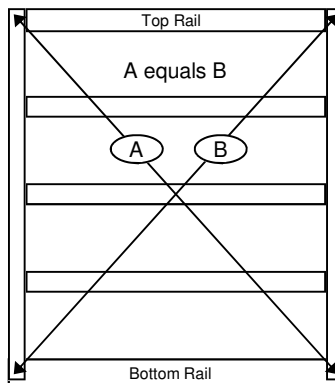



SLIDING DOOR ASSEMBLY, cont.

8. (See drawing below) Position and install track (#1) as needed to allow for proper door opening and overlap noted in Step 1. Level the track and attach to the header with 5/16" bolts at least 1-1/2" long every 24" on center.
9. Position the door leaf beneath one end of the track and lift vertically to insert the wheels (#2) of the first trolley into the track. Roll the door forward until the second set of trolley wheels can be inserted into the track. Use the trolley hanger adjustments to move the door up-or-down and in-or-out relative to the building until the door rolls freely in the track.
10. Install track cover brackets (#4) and track cover (#5). Mount one adjustable door stop (#6) at each end of the track run. Install one adjustable stay roller (#7) or door guide where the door overlaps the building wall. Install door handle (#8), latch, and weath-erseal if desired.

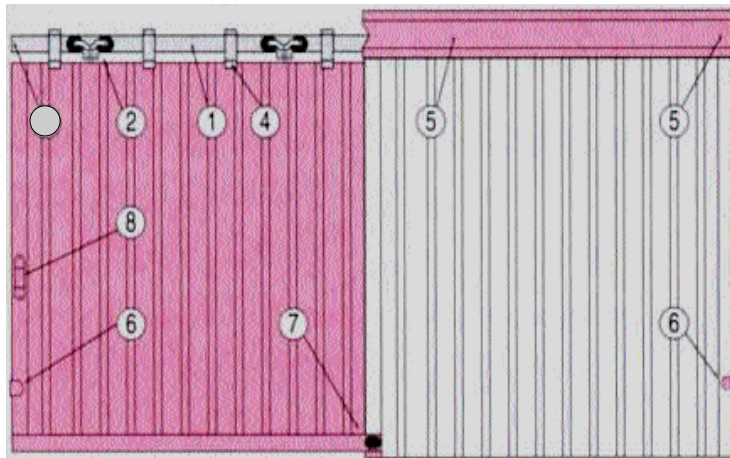



www.metallionindustries.com

Hours: Mon.—Fri. 8—5:30

850 NW Park Avenue

Estacada, OR

Fax 503-630-7770

503-630-7740

“Live Every Day For Jesus!”