

Installation

Residential Generator Sets

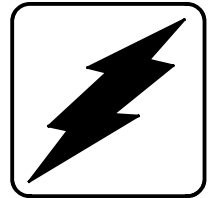

Models:

15RESA

30RESA

KOHLER[®]
POWER SYSTEMS

ISO 9001
KOHLER
POWER SYSTEMS
NATIONALLY REGISTERED

TP-6725 11/09

California Proposition 65

⚠ WARNING

Engine exhaust from this product contains chemicals known to the State of California to cause cancer, birth defects, or other reproductive harm.

Product Identification Information

Product identification numbers determine service parts. Record the product identification numbers in the spaces below immediately after unpacking the products so that the numbers are readily available for future reference. Record field-installed kit numbers after installing the kits.

Generator Set Identification Numbers

Record the product identification numbers from the generator set nameplate(s).

Model Designation _____

Specification Number _____

Serial Number _____

Accessory Number

Accessory Description

Accessory Number	Accessory Description
_____	_____
_____	_____
_____	_____
_____	_____
_____	_____
_____	_____
_____	_____
_____	_____
_____	_____
_____	_____
_____	_____
_____	_____
_____	_____
_____	_____
_____	_____
_____	_____
_____	_____
_____	_____
_____	_____
_____	_____
_____	_____
_____	_____
_____	_____
_____	_____
_____	_____

Controller Identification

Record the controller description from the generator set operation manual, spec sheet, or sales invoice.

Controller Description _____

Engine Identification

Record the product identification information from the engine nameplate.

Manufacturer _____

Model Designation _____

Serial Number _____

Table of Contents

Product Identification Information	2
Safety Precautions and Instructions	5
Introduction	9
Service Assistance	10
Section 1 General	11
1.1 Introduction	11
1.2 Enclosed Generator Sets	11
1.3 Unit-Mounted Radiator Cooling	11
1.3.1 Cooling System Features	11
1.3.2 Recommended Coolant	11
1.4 Fuel Supply	11
1.4.1 Fuel Lines	11
1.4.2 Gas Regulators	11
1.5 Electrical System	12
1.5.1 Line Circuit Breakers	12
1.5.2 Electrical Connections	12
1.5.3 Load Lead Connections	12
1.5.4 Ground and Neutral Connections	12
1.5.5 Terminal Connector Torque	12
1.5.6 Battery Chargers	14
1.5.7 Alternator Factory Connection	14
1.5.8 Automatic Transfer Switches	14
Section 2 Installation Instructions	15
2.1 Introduction	15
2.1.1 Location Factors	15
2.1.2 Mounting Surface	16
2.1.3 Vibration Isolation	16
2.1.4 Lifting Generator Set	16
2.2 Installation Procedure	16
2.2.1 Prepare Site	17
2.2.2 Mount and Ground Generator Set	17
2.2.3 Connect AC and DC Wiring	18
2.2.4 Install Engine Starting Battery	19
2.2.5 Install and Connect Fuel Supply	20
2.2.6 Fuel Conversion Procedures	22
2.2.7 Add Coolant	23
2.2.8 Operation Tests	24
Section 3 Accessories	25
3.1 Introduction	25
3.2 Common Fault and Run Relay Board	25
3.3 Remote Digital Gauge	26
3.4 Block Heaters	26
3.5 Oil Makeup Kit	26
3.6 OnCue Home Generator Management System	26
Section 4 Controller	27
4.1 Advanced Digital Control (ADC 2100)	27
4.2 Code Version	27
4.3 Controller Automatic Power Down	27
4.4 Controller Configuration	27
4.5 Voltage Adjustments	31

Table of Contents, continued

Section 5 Dimension Drawings	35
Appendix A Abbreviations	39

Safety Precautions and Instructions

IMPORTANT SAFETY INSTRUCTIONS. Electromechanical equipment, including generator sets, transfer switches, switchgear, and accessories, can cause bodily harm and pose life-threatening danger when improperly installed, operated, or maintained. To prevent accidents be aware of potential dangers and act safely. Read and follow all safety precautions and instructions. **SAVE THESE INSTRUCTIONS.**

This manual has several types of safety precautions and instructions: Danger, Warning, Caution, and Notice.

DANGER

Danger indicates the presence of a hazard that **will cause severe personal injury, death, or substantial property damage.**

WARNING

Warning indicates the presence of a hazard that **can cause severe personal injury, death, or substantial property damage.**

CAUTION

Caution indicates the presence of a hazard that **will or can cause minor personal injury or property damage.**

NOTICE

Notice communicates installation, operation, or maintenance information that is safety related but not hazard related.

Safety decals affixed to the equipment in prominent places alert the operator or service technician to potential hazards and explain how to act safely. The decals are shown throughout this publication to improve operator recognition. Replace missing or damaged decals.

Accidental Starting

WARNING

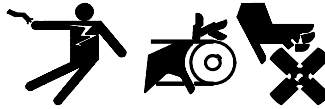

**Accidental starting.
Can cause severe injury or death.**

Disconnect the battery cables before working on the generator set. Remove the negative (-) lead first when disconnecting the battery. Reconnect the negative (-) lead last when reconnecting the battery.

Disabling the generator set. Accidental starting can cause severe injury or death. Before working on the generator set or connected equipment, disable the generator set as follows: (1) Move the generator set master switch to the OFF position. (2) Disconnect the power to the battery charger. (3) Remove the battery cables, negative (-) lead first. Reconnect the negative (-) lead last when reconnecting the battery. Follow these precautions to prevent starting of the generator set by an automatic transfer switch, remote start/stop switch, or engine start command from a remote computer.

Battery

WARNING



**Sulfuric acid in batteries.
Can cause severe injury or death.**

Wear protective goggles and clothing. Battery acid may cause blindness and burn skin.

WARNING



**Explosion.
Can cause severe injury or death.
Relays in the battery charger
cause arcs or sparks.**

Locate the battery in a well-ventilated area. Isolate the battery charger from explosive fumes.

Battery gases. Explosion can cause severe injury or death. Battery gases can cause an explosion. Do not smoke or permit flames or sparks to occur near a battery at any time, particularly when it is charging. Do not dispose of a battery in a fire. To prevent burns and sparks that could cause an explosion, avoid touching the battery terminals with tools or other metal objects. Remove all jewelry before servicing the equipment. Discharge static electricity from your body before touching batteries by first touching a grounded metal surface away from the battery. To avoid sparks, do not disturb the battery charger connections while the battery is charging. Always turn the battery charger off before disconnecting the battery connections. Ventilate the compartments containing batteries to prevent accumulation of explosive gases.

Battery electrolyte is a diluted sulfuric acid. Battery acid can cause severe injury or death. Battery acid can cause blindness and burn skin. Always wear splashproof safety goggles, rubber gloves, and boots when servicing the battery. Do not open a sealed battery or mutilate the battery case. If battery acid splashes in the eyes or on the skin, immediately flush the affected area for 15 minutes with large quantities of clean water. Seek immediate medical aid in the case of eye contact. Never add acid to a battery after placing the battery in service, as this may result in hazardous spattering of battery acid.

Battery short circuits. Explosion can cause severe injury or death. Short circuits can cause bodily injury and/or equipment damage. Disconnect the battery before generator set installation or maintenance. Remove all jewelry before servicing the equipment. Use tools with insulated handles. Remove the negative (-) lead first when disconnecting the battery. Reconnect the negative (-) lead last when reconnecting the battery. Never connect the negative (-) battery cable to the positive (+) connection terminal of the starter solenoid. Do not test the battery condition by shorting the terminals together.

Battery acid cleanup. Battery acid can cause severe injury or death. Battery acid is electrically conductive and corrosive. Add 500 g (1 lb.) of bicarbonate of soda (baking soda) to a container with 4 L (1 gal.) of water and mix the neutralizing solution. Pour the neutralizing solution on the spilled battery acid and continue to add the neutralizing solution to the spilled battery acid until all evidence of a chemical reaction (foaming) has ceased. Flush the resulting liquid with water and dry the area.

Engine Backfire/Flash Fire

⚠ WARNING

<p>Fire. Can cause severe injury or death.</p> <p>Do not smoke or permit flames or sparks near fuels or the fuel system.</p>

Servicing the fuel system. A flash fire can cause severe injury or death. Do not smoke or permit flames or sparks near the carburetor, fuel line, fuel filter, fuel pump, or other potential sources of spilled fuels or fuel vapors. Catch fuels in an approved container when removing the fuel line or carburetor.

Servicing the air cleaner. A sudden backfire can cause severe injury or death. Do not operate the generator set with the air cleaner removed.

Combustible materials. A fire can cause severe injury or death. Generator set engine fuels and fuel vapors are flammable and explosive. Handle these materials carefully to minimize the risk of fire or explosion. Equip the compartment or nearby area with a fully charged fire extinguisher. Select a fire extinguisher rated ABC or BC for electrical fires or as recommended by the local fire code or an authorized agency. Train all personnel on fire extinguisher operation and fire prevention procedures.

Exhaust System

⚠ WARNING

<p>Carbon monoxide. Can cause severe nausea, fainting, or death.</p> <p>The exhaust system must be leakproof and routinely inspected.</p>

Generator set operation. Carbon monoxide can cause severe nausea, fainting, or death. Carbon monoxide is an odorless, colorless, tasteless, nonirritating gas that can cause death if inhaled for even a short time. Avoid breathing exhaust fumes when working on or near the generator set. Never operate the generator set inside a building. Never operate the generator set where exhaust gas could seep inside or be drawn into a potentially occupied building through windows, air intake vents, or other openings.

Carbon monoxide detectors. Carbon monoxide can cause severe nausea, fainting, or death. Install carbon monoxide detectors on each level of any building adjacent to the generator set. Locate the detectors to adequately warn the building's occupants of the presence of carbon monoxide. Keep the detectors operational at all times. Periodically test and replace the carbon monoxide detectors according to the manufacturer's instructions.

Carbon monoxide symptoms. Carbon monoxide can cause severe nausea, fainting, or death. Carbon monoxide is a poisonous gas present in exhaust gases. Carbon monoxide is an odorless, colorless, tasteless, nonirritating gas that can cause death if inhaled for even a short time. Carbon monoxide poisoning symptoms include but are not limited to the following:

- Light-headedness, dizziness
- Physical fatigue, weakness in joints and muscles
- Sleepiness, mental fatigue, inability to concentrate or speak clearly, blurred vision
- Stomachache, vomiting, nausea

If experiencing any of these symptoms and carbon monoxide poisoning is possible, seek fresh air immediately and remain active. Do not sit, lie down, or fall asleep. Alert others to the possibility of carbon monoxide poisoning. Seek medical attention if the condition of affected persons does not improve within minutes of breathing fresh air.

Fuel System

⚠ WARNING

Explosive fuel vapors. Can cause severe injury or death.

Use extreme care when handling, storing, and using fuels.

The fuel system. Explosive fuel vapors can cause severe injury or death. Vaporized fuels are highly explosive. Use extreme care when handling and storing fuels. Store fuels in a well-ventilated area away from spark-producing equipment and out of the reach of children. Never add fuel to the tank while the engine is running because spilled fuel may ignite on contact with hot parts or from sparks. Do not smoke or permit flames or sparks to occur near sources of spilled fuel or fuel vapors. Keep the fuel lines and connections tight and in good condition. Do not replace flexible fuel

lines with rigid lines. Use flexible sections to avoid fuel line breakage caused by vibration. Do not operate the generator set in the presence of fuel leaks, fuel accumulation, or sparks. Repair fuel systems before resuming generator set operation.

Explosive fuel vapors can cause severe injury or death. Take additional precautions when using the following fuels:

Propane (LP)—Adequate ventilation is mandatory. Because propane is heavier than air, install propane gas detectors low in a room. Inspect the detectors per the manufacturer's instructions.

Natural Gas—Adequate ventilation is mandatory. Because natural gas rises, install natural gas detectors high in a room. Inspect the detectors per the manufacturer's instructions.

Gas fuel leaks. Explosive fuel vapors can cause severe injury or death. Fuel leakage can cause an explosion. Check the LP vapor gas or natural gas fuel system for leakage by using a soap and water solution with the fuel system test pressurized to 6–8 ounces per square inch (10–14 inches water column). Do not use a soap solution containing either ammonia or chlorine because both prevent bubble formation. A successful test depends on the ability of the solution to bubble.

Hazardous Noise

CAUTION



Hazardous noise.
Can cause hearing loss.

Never operate the generator set without a muffler or with a faulty exhaust system.

Engine noise. Hazardous noise can cause hearing loss. Generator sets not equipped with sound enclosures can produce noise levels greater than 105 dBA. Prolonged exposure to noise levels greater than 85 dBA can cause permanent hearing loss. Wear hearing protection when near an operating generator set.

Hazardous Voltage/ Moving Parts

DANGER



Hazardous voltage.
Will cause severe injury or death.

Disconnect all power sources before opening the enclosure.

WARNING



Hazardous voltage. Moving parts.
Can cause severe injury or death.

Operate the generator set only when all guards and electrical enclosures are in place.

WARNING



Hazardous voltage.
Backfeed to the utility system can cause property damage, severe injury, or death.

If the generator set is used for standby power, install an automatic transfer switch to prevent inadvertent interconnection of standby and normal sources of supply.

CAUTION



Welding the generator set.
Can cause severe electrical equipment damage.

Never weld components of the generator set without first disconnecting the battery, controller wiring harness, and engine electronic control module (ECM).

Grounding electrical equipment. Hazardous voltage can cause severe injury or death. Electrocutation is possible whenever electricity is present. Ensure you comply with all applicable codes and standards. Electrically ground the generator set, transfer switch, and related equipment and electrical circuits. Turn off the main circuit breakers of all power sources before servicing the equipment. Never contact electrical leads or appliances when standing in water or on wet ground because these conditions increase the risk of electrocution.

Disconnecting the electrical load. Hazardous voltage can cause severe injury or death. Disconnect the generator set from the load by turning off the line circuit breaker or by disconnecting the generator set output leads from the transfer switch and heavily taping the ends of the leads. High voltage transferred to the load during testing may cause personal injury and equipment damage. Do not use the safeguard circuit breaker in place of the line circuit breaker. The safeguard circuit breaker does not disconnect the generator set from the load.

Welding on the generator set. Can cause severe electrical equipment damage. Before welding on the generator set perform the following steps: (1) Remove the battery cables, negative (-) lead first. (2) Disconnect all engine electronic control module (ECM) connectors. (3) Disconnect all generator set controller and voltage regulator circuit board connectors. (4) Disconnect the engine battery-charging alternator connections. (5) Attach the weld ground connection close to the weld location.

Installing the battery charger. Hazardous voltage can cause severe injury or death. An ungrounded battery charger may cause electrical shock. Connect the battery charger enclosure to the ground of a permanent wiring system. As an alternative, install an equipment grounding conductor with circuit conductors and connect it to the equipment grounding terminal or the lead on the battery charger. Install the battery charger as prescribed in the equipment manual. Install the battery charger in compliance with local codes and ordinances.

Connecting the battery and the battery charger. Hazardous voltage can cause severe injury or death. Reconnect the battery correctly, positive to positive and negative to negative, to avoid electrical shock and damage to the battery charger and battery(ies). Have a qualified electrician install the battery(ies).

Short circuits. Hazardous voltage/current can cause severe injury or death. Short circuits can cause bodily injury and/or equipment damage. Do not contact electrical connections with tools or jewelry while making adjustments or repairs. Remove all jewelry before servicing the equipment.

Engine block heater. Hazardous voltage can cause severe injury or death. The engine block heater can cause electrical shock. Remove the engine block heater plug from the electrical outlet before working on the block heater electrical connections.

Electrical backfeed to the utility. Hazardous backfeed voltage can cause severe injury or death. Install a transfer switch in standby power installations to prevent the connection of standby and other sources of power. Electrical backfeed into a utility electrical system can cause severe injury or death to utility personnel working on power lines.

Heavy Equipment

⚠ WARNING

<p>Unbalanced weight. Improper lifting can cause severe injury or death and equipment damage.</p> <p>Do not use lifting eyes. Lift the generator set using lifting bars inserted through the lifting holes on the skid.</p>

Hot Parts

⚠ WARNING

<p>Hot coolant and steam. Can cause severe injury or death.</p> <p>Before removing the pressure cap, stop the generator set and allow it to cool. Then loosen the pressure cap to relieve pressure.</p>

⚠ WARNING

<p>Hot engine and exhaust system. Can cause severe injury or death.</p> <p>Do not work on the generator set until it cools.</p>

⚠ WARNING

<p>Hot engine oil. Can cause severe injury or death.</p> <p>Avoid skin contact with hot oil. Do not start or operate the generator set with the engine oil filler cap removed, as hot oil can spray out. Ensure that the lubrication system is not under pressure when servicing. Do not work on the generator set until it cools.</p>

Servicing the exhaust system. Hot parts can cause severe injury or death. Do not touch hot engine parts. The engine and exhaust system components become extremely hot during operation.

Notice

NOTICE

Canadian installations only. For standby service connect the output of the generator set to a suitably rated transfer switch in accordance with Canadian Electrical Code, Part 1.

This manual provides installation instructions for 15 and 30 kW residential generator set models listed on the front cover. Operation manuals are available separately.

Information in this publication represents data available at the time of print. Kohler Co. reserves the right to change this publication and the products represented without notice and without any obligation or liability whatsoever.

Read this manual and carefully follow all procedures and safety precautions to ensure proper equipment operation and to avoid bodily injury. Read and follow the Safety Precautions and Instructions section at the beginning of this manual. Keep this manual with the equipment for future reference.

List of Related Materials

Figure 1 identifies related literature available for the generator sets covered in this manual. Only trained and qualified personnel should install or service the generator set.

Literature Type	Part Number
Operation Manual (Generator)	TP-6726
Parts Catalog*	TP-6319
Service Manual (Engine)	TP-6724
Service Manual (Generator Set)	TP-6198
Wiring Diagram Manual (Generator Set)	TP-6719
* One Parts Catalog combines generator and engine information.	

Figure 1 Related Literature

Warranty Registration

Complete the startup and installation checklists supplied with the startup notification form. Complete and sign the startup notification form and return copies to an authorized Kohler distributor/dealer as instructed on the form.

Service Assistance

For professional advice on generator power requirements and conscientious service, please contact your nearest authorized Kohler distributor/dealer.

- Consult the Yellow Pages under the heading Generators—Electric.
- Visit the Kohler Power Systems website at KohlerPower.com.
- Look at the labels and stickers on your Kohler product or review the appropriate literature or documents included with the product.
- Call toll free in the US and Canada 1-800-544-2444.
- Outside the US and Canada, call the nearest regional office.

Headquarters Europe, Middle East, Africa (EMEA)

Kohler Power Systems
3 rue de Brennus
93200 Saint Denis
France
Phone: (33) 1 49 178300
Fax: (33) 1 49 178301

Asia Pacific

Power Systems Asia Pacific Regional Office
Singapore, Republic of Singapore
Phone: (65) 6264-6422
Fax: (65) 6264-6455

China

North China Regional Office, Beijing
Phone: (86) 10 6518 7950
(86) 10 6518 7951
(86) 10 6518 7952
Fax: (86) 10 6518 7955

East China Regional Office, Shanghai
Phone: (86) 21 6288 0500
Fax: (86) 21 6288 0550

India, Bangladesh, Sri Lanka

India Regional Office
Bangalore, India
Phone: (91) 80 3366208
(91) 80 3366231
Fax: (91) 80 3315972

Japan, Korea

North Asia Regional Office
Tokyo, Japan
Phone: (813) 3440-4515
Fax: (813) 3440-2727

Latin America

Latin America Regional Office
Lakeland, Florida, USA
Phone: (863) 619-7568
Fax: (863) 701-7131

1.1 Introduction

Review this section and the Safety Precautions before starting the installation procedure. The generator set specification sheet also contains data that may be required during the installation process.

The generator set and accessories must be installed by an authorized Kohler distributor/dealer or authorized representative. The installation must comply with all applicable national and local codes.

1.2 Enclosed Generator Sets

Install the generator set outdoors. Enclosed generator sets include a factory-supplied sound enclosure. The exhaust systems of enclosed units are complete for outdoor installations. Review Section 1 and then refer to Section 2 for the outdoor installation of enclosed units.

Note: DO NOT install enclosed units inside a building.

1.3 Unit-Mounted Radiator Cooling

The generator set is equipped with a unit-mounted radiator common cooling system.

1.3.1 Cooling System Features

The system's major components include an engine-driven fan and circulating water pump, a radiator, and a thermostat. The pump circulates water through the engine until it reaches operating temperature. Then the engine thermostat opens, allowing water circulation through the radiator. The thermostat restricts water flow as necessary to prevent overcooling. The fan blows air from the engine side of the radiator across the cooling surface.

1.3.2 Recommended Coolant

Add antifreeze before starting the generator set or energizing the block heater.

The generator set manufacturer recommends a solution of 50% ethylene glycol and 50% clean, softened water to provide freezing protection to -37°C (-34°F) and boiling protection to 129°C (256°F). A 50/50 solution also inhibits corrosion. Consult the engine manufacturer's instructions for engine coolant specifications. See the List of Related Materials in the Introduction.

1.4 Fuel Supply

Gas fuel systems operate on either LP (liquefied petroleum) or natural gas. Refer to the generator set specification sheet and Section 2.2.5 for more detailed information on fuel requirements.

Note: Design and install gas fuel systems in accordance with NFPA-54, National Fuel Gas Code, and applicable local codes.

1.4.1 Fuel Lines

Gas lines. Never use fuel piping to ground electrical equipment. The gas supplier is responsible for installation, repair, and alteration to gas piping.

Use Schedule 40 black-iron pipe for gas piping. Copper tubing may be used if the fuel does not contain hydrogen sulfide or other ingredients that react chemically with copper.

Line size. Size piping according to the requirements of the equipment. Refer to the the instructions in Section 2.2.5. In addition to actual fuel consumption, consider the following pressure loss factors:

- Pipe length
- Other appliances on the same fuel supply
- Number of fittings

Flexible connections. Rigid mount the piping but protect it from vibration. Use flexible connections spanning a minimum of 152 mm (6 in.) between the stationary piping and the engine fuel inlet connection.

1.4.2 Gas Regulators

Gas regulators reduce high incoming fuel pressures to lower levels acceptable for engines. See the generator set specification sheet for fuel supply pressure requirements.

Primary gas regulator. The primary regulator reduces the high pressure from a tank or transmission line to the lower pressure required by the secondary regulator on the engine. The fuel supplier provides the primary regulator. The fuel supplier is also responsible for providing sufficient gas pressure to operate the primary regulator.

Secondary gas regulator. The secondary regulator is factory-installed on the generator set engine and controls the inlet pressure to the engine. The models covered by this manual use an electronic pressure regulator. See Section 2.2.6.

Note: The Integrated Electronic Pressure Regulator (IEPR) and air/fuel mixer are specially calibrated emission-control devices. Do not adjust the IEPR or the air/fuel mixer.

1.5 Electrical System

Before installing the generator set, provide for electrical connections through conduit to the transfer switch and other accessories for the generator set. Route DC leads in separate conduit from AC conductors. Carefully install the selected generator set accessories. Route wiring to the generator set through flexible connections. Comply with all applicable codes when installing a wiring system.

1.5.1 Line Circuit Breakers

AC circuit protection. All AC circuits must include circuit breaker or fuse protection. If the generator set is not equipped with a factory-installed circuit breaker, select a circuit breaker for up to 125% of the rated generator set output current. The circuit breaker must open all ungrounded conductors. The circuit breaker or fuse must be mounted within 7.6 m (25 ft.) of the alternator output terminals.

1.5.2 Electrical Connections

Several electrical connections must be made between the generator set and other components of the system for proper operation. Most field-installed accessory kits include installation instructions. Comply with applicable national and local codes when installing a wiring system.

Size the wire according to the length of run and 115% of the circuit current (amperage) as directed by the National Electrical Code® (NEC) in ANSI/NFPA 70.

For Canadian installations, refer to the Canadian Electrical Code (CEC).

1.5.3 Load Lead Connections

Feed load leads to the generator set junction box through the nonservice side of the box. See Figure 1-1. Route DC leads in separate conduit from AC conductors.

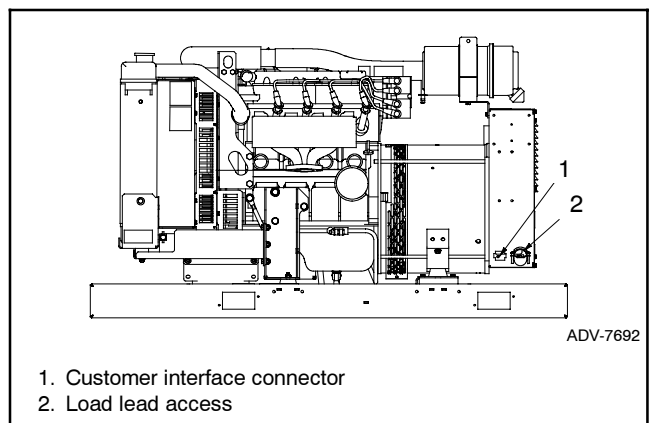

Figure 1-1 Load Lead Access (enclosure not shown)

1.5.4 Ground and Neutral Connections

Ground the generator set. The grounding method must comply with NEC and local codes. Connect the grounding strap to the generator set ground lug. See Section 2.2.2 for the ground lug location.

Various regulations and site configurations including the National Electrical Code (NEC), local codes, and the type of transfer switch used in the application determine the grounding of the neutral at the generator. NEC 2002 Section 250.20 is one example that has a very good explanation of the neutral grounding requirements for generators.

Generator sets are shipped with the generator neutral attached to the generator in the junction box. At installation, the neutral can be grounded at the generator set or lifted from the ground stud and isolated if the installation requires an ungrounded neutral connection at the generator. The generator set will operate properly with the neutral either bonded to ground or isolated from ground at the generator.

1.5.5 Terminal Connector Torque

Use the torque values shown in Figure 1-2 or Figure 1-3 for terminal connectors. Refer to UL-486A, UL-486B, and UL-486E for information on terminal connectors for aluminum and/or copper conductors. Comply with

applicable national and local codes when installing a wiring system.

Note: If a connector has a clamp screw such as a slotted, hexagonal head screw with more than one means of tightening, test the connector using both applicable torque values provided in Figure 1-3.

Socket Size Across Flats, mm (in.)	Tightening Torque, Nm (in. lb.)
3.2 (1/8)	5.1 (45)
4.0 (5/32)	11.4 (100)
4.8 (3/16)	13.8 (120)
5.6 (7/32)	17.0 (150)
6.4 (1/4)	22.6 (200)
7.9 (5/16)	31.1 (275)
9.5 (3/8)	42.4 (375)
12.7 (1/2)	56.5 (500)
14.3 (9/16)	67.8 (600)

Note: For values of slot width or length not corresponding to those specified, select the largest torque value associated with the conductor size. Slot width is the nominal design value. Slot length is to be measured at the bottom of the slot.

Figure 1-2 Tightening Torque for Pressure Wire Connectors with Internal-Drive Socket-Head Screws

Wire Size for Unit Connection	Tightening Torque, Nm (in. lb.)			
	Slot Head 4.7 mm (No. 10) or Larger*		Hexagonal Head—External Drive Socket Wrench	
	Slot Width <1.2 mm (0.047 in.) Slot Length <6.4 mm (0.25 in.)	Slot Width >1.2 mm (0.047 in.) Slot Length >6.4 mm (0.25 in.)	Split-Bolt Connectors	Other Connections
18-10 (0.82-5.3)	2.3 (20)	4.0 (35)	9.0 (80)	8.5 (75)
8 (8.4)	2.8 (25)	4.5 (40)	9.0 (80)	8.5 (75)
6-4 (13.3-21.2)	4.0 (35)	5.1 (45)	18.6 (165)	12.4 (110)
3 (26.7)	4.0 (35)	5.6 (50)	31.1 (275)	16.9 (150)
2 (33.6)	4.5 (40)	5.6 (50)	31.1 (275)	16.9 (150)
1 (42.4)	—	5.6 (50)	31.1 (275)	16.9 (150)
1/0-2/0 (53.5-67.4)	—	5.6 (50)	43.5 (385)	20.3 (180)
3/0-4/0 (85.0-107.2)	—	5.6 (50)	56.5 (500)	28.2 (250)
250-350 (127-177)	—	5.6 (50)	73.4 (650)	36.7 (325)
400 (203)	—	5.6 (50)	93.2 (825)	36.7 (325)
500 (253)	—	5.6 (50)	93.2 (825)	42.4 (375)
600-750 (304-380)	—	5.6 (50)	113.0 (1000)	42.4 (375)
800-1000 (406-508)	—	5.6 (50)	124.3 (1100)	56.5 (500)
1250-2000 (635-1016)	—	—	124.3 (1100)	67.8 (600)

* For values of slot width or length not corresponding to those specified, select the largest torque value associated with the conductor size. Slot width is the nominal design value. Slot length is to be measured at the bottom of the slot.

Note: If a connector has a clamp screw such as a slotted, hexagonal head screw with more than one means of tightening, test the connector using both applicable torque values.

Figure 1-3 Tightening Torque for Screw-Type Pressure Wire Connectors

1.5.6 Battery Chargers

An engine-driven, battery-charging alternator charges the battery whenever the generator set operates. Engine-driven systems can quickly restore the charge used in a normal cranking cycle.

When the engine is not operating, a very low charge rate from an AC-powered battery charger is usually sufficient to maintain a full charge on the batteries. Select an automatic float/equalize battery charger with a 3 amp or greater rating.

Use separate, self-contained battery chargers or units built into the automatic transfer switch. Run leads from a transfer switch-mounted battery charger in conduit separate from the conduit that holds the generator load cables or remote engine-start circuits.

1.5.7 Alternator Factory Connection

Figure 1-4 shows the factory connection for the single-phase 120/240 V 60 Hz generator set. The generator set is not reconnectable.

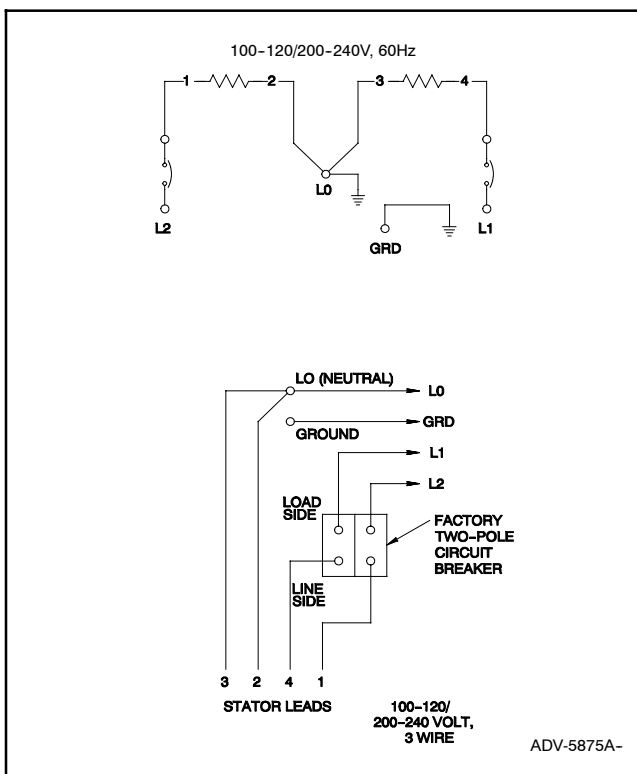

Figure 1-4 Single-Phase Factory Connection, 120/240 V 60 Hz

1.5.8 Automatic Transfer Switches

A typical standby system has at least one automatic transfer switch connected to the generator set output to automatically transfer the electrical load to the generator set if the normal source fails. When normal power returns, the switch transfers the load back to the normal power source and then signals the generator set to stop.

The transfer switch uses a set of contacts to signal the engine/generator to start. When the normal source fails and the generator set master switch is in the AUTO position, the transfer switch contacts close to start the generator set.

The engine start terminals are usually located near the transfer switch contactor with an engine start decal identifying the terminals. Use the transfer switch wiring diagrams to identify the engine start terminals prior to making connections.

Connect the transfer switch engine-start contacts or a remote manual engine-start switch to the engine start connectors on the generator set. Use the remote harness with pigtail to connect to leads 3 and 4 from the ADC 2100 generator set controller to the engine-start leads from the ATS. Size the wire according to the transfer switch connection and the length of run. Use separate conduit for the DC engine-start leads and the AC generator set load cables and battery charger leads.

Section 2 Installation Instructions

2.1 Introduction

Have the generator set installed by an authorized Kohler distributor/dealer or authorized representative. Install the equipment in compliance with the National Electrical Code (NEC) and local codes. For Canadian installations, refer to the Canadian Electrical Code (CEC).

Note: These instructions outline one procedure for installing the generator set. Local codes may require different procedures.

The generator set must be installed outdoors. The exhaust systems on enclosed units are designed for outdoor installation only. Review the information in Section 1, General, before beginning the installation procedure.

Note: **DO NOT** install enclosed generator sets inside a building.

Note: Install carbon monoxide (CO) detector(s) on each level of any building adjacent to a generator set. Locate the detectors to adequately warn the building's occupants of the presence of carbon monoxide.

Read and follow the safety precautions in this manual and observe the decals on the equipment. Refer to the diagrams and drawings in Section 5 for dimensions and electrical connections during the installation procedure. Read the entire installation procedure and obtain the accessories and tools needed before beginning installation. Perform the steps in the order shown.

To install optional accessories, follow the instructions provided with each kit.

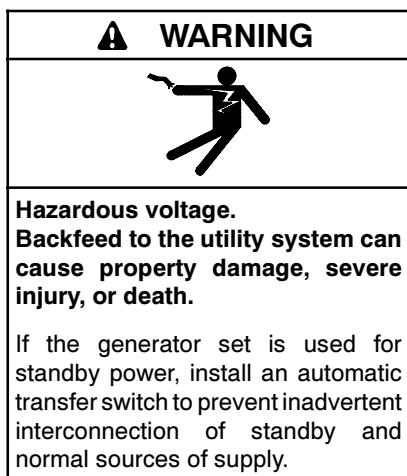

Grounding electrical equipment. Hazardous voltage can cause severe injury or death. Electrocutation is possible whenever electricity is present. Ensure you comply with all applicable codes and standards. Electrically ground the generator set, transfer switch, and related equipment and electrical circuits. Turn off the main circuit breakers of all power sources before servicing the equipment. Never contact electrical leads or appliances when standing in water or on wet ground because these conditions increase the risk of electrocution.

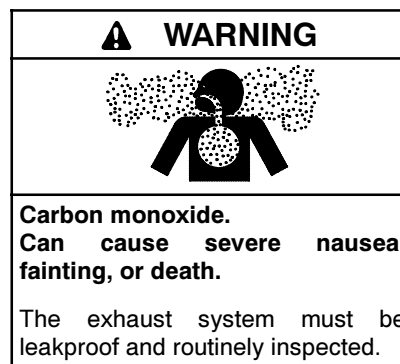

Generator set operation. Carbon monoxide can cause severe nausea, fainting, or death. Carbon monoxide is an odorless, colorless, tasteless, nonirritating gas that can cause death if inhaled for even a short time. Avoid breathing exhaust fumes when working on or near the generator set. Never operate the generator set inside a building. Never operate the generator set where exhaust gas could seep inside or be drawn into a potentially occupied building through windows, air intake vents, or other openings.

Carbon monoxide detectors. Carbon monoxide can cause severe nausea, fainting, or death. Install carbon monoxide detectors on each level of any building adjacent to the generator set. Locate the detectors to adequately warn the building's occupants of the presence of carbon monoxide. Keep the detectors operational at all times. Periodically test and replace the carbon monoxide detectors according to the manufacturer's instructions.

2.1.1 Location Factors

Ideally, the generator set should be mounted on concrete at ground level. For above-ground installations, including roof installations, weight considerations are especially important. The building engineer must determine whether the structure can support the weight of the generator set.

The location of the generator set must:

- Support the weight of the generator set and related equipment such as batteries, radiators, and mounting pad(s). Keep in mind that the mounting pad weight may exceed the weight of the generator set.

- Meet applicable fire rating codes and standards.
- Position the generator set over a noncombustible surface. **DO NOT** allow accumulation of combustible materials under or around the generator set.
- Permit vibration isolation to reduce noise and prevent damage.
- Not be subject to flooding.
- Provide clearance for cooling air flow and access for service. See Section 2.2 for required clearances from obstructions and combustible materials.
- Allow safe expulsion of exhaust.
- Minimize the risk of public or unauthorized access.

Notice

DO NOT locate the generator set near patios, decks, play areas, or animal shelters. Keep items such as lawn furniture, toys, sports equipment, and all combustible materials away from the generator set exhaust outlet.

Remind family members, children, and visitors to use caution near the generator set. Generator sets connected to automatic transfer switches start automatically during exercise periods and power outages. Some generator set components become hot when the generator set is running and remain hot for a time after the generator set shuts down.

2.1.2 Mounting Surface

The manufacturer recommends a single, level concrete mounting pad. This method provides maximum stability for the generator set. The recommended mounting pad dimensions are shown in the dimension drawings in Section 5.

Refer to the generator set dimension drawings for conduit and fuel-line placement. The drawings give dimensions for electrical and fuel connection rough-ins and stub-ups.

2.1.3 Vibration Isolation

The generator set is equipped with neoprene vibration isolators. Connections between the generator set or its mounting base and any conduits or fuel lines must include flexible sections to prevent breakage and to isolate vibration.

2.1.4 Lifting Generator Set

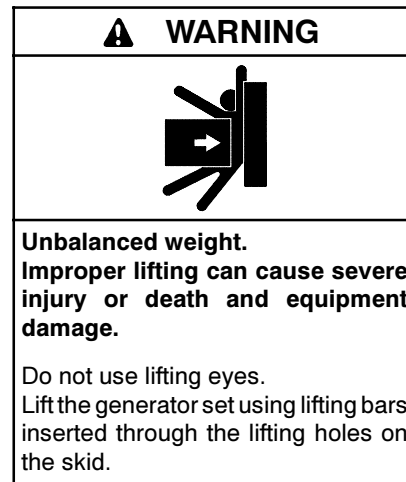

Enclosed units weigh approximately 500 kg (1100 lb.). Use equipment that is rated for the generator set's weight to lift the unit into place. Lift the enclosure and generator set together as one unit.

DO NOT lift the generator set using the lifting eyes attached to the engine and/or alternator. These eyes cannot support the generator set's weight. Instead, insert lifting hooks or lifting bars through the four holes in the mounting skid. The placement of the holes maintains balance during lifting.

2.2 Installation Procedure

Tools Required:

- Multimeter (for measuring voltage and current)
- Frequency meter (may be part of multimeter)
- Manometer (for measuring fuel pressure)
- Torque wrench
- Wrenches
- Screwdrivers
- Socket wrenches or nut drivers
- Pliers
- Safety glasses or goggles
- Drill with bits and hole saw

Installer/Customer-Supplied Items:

- One 12-volt battery with a minimum rating of 525 cold cranking amps (CCA) at 0°F.
- Remote harness with pigtail connector (to connect ATS engine start, if used)
- Gravel or crushed stone
- Concrete mounting pad
- Cables and conduit
- Fuel supply line with shutoff valve and pipe sealant (provided by fuel supplier)
- Carbon monoxide (CO) detector(s)

Available Accessories:

- Air cleaner restriction indicator
- Battery
- Battery charger
- Battery heater
- Block heater
- Flexible fuel lines
- Maintenance kit (includes filters and belt)
- Natural gas strainer
- Relay kit, includes common fault and auxiliary run relays
- Remote digital gauge
- Remote harnesses
- Rodent guards

2.2.1 Prepare Site

Choose a location that is at least 0.9 m (3 ft.) from any building or structure and near the incoming gas service. Allow a minimum of 2.4 m (8 ft.) clearance beyond the exhaust end of the generator set. Plan the installation so that the exhaust end of the generator set is not directed toward the building or any openings where exhaust gas could be drawn into the building.

Install carbon monoxide detectors on each level of any building adjacent to the generator set. Locate the detectors to adequately warn the building's occupants of the presence of carbon monoxide.

1. Obtain a building permit and contact your local utility companies to mark the locations of underground pipes and cables.
2. Prepare an area for mounting the generator set.
 - a. Clear all combustible materials, including plants and shrubs, building materials, and lawn furniture, from an area at least 2.4 m (8 ft.) beyond the exhaust end of the generator set.

- b. Spread a 76 mm (3 in.) thick layer of gravel to support the concrete mounting pad. For the mounting pad dimensions, see Figure 5-2 or for weather enclosures or Figure 5-4 for sound enclosures.
- c. Lay a 100 mm (4 in.) thick concrete pad on the gravel layer. Include mounting bolts and stub-ups for the fuel supply and electrical conduit. See Figure 5-2 or Figure 5-4 for the mounting pad dimensions, mounting bolts, and stub-up locations.

2.2.2 Mount and Ground Generator Set

1. Place the generator set on the concrete mounting pad. Secure the generator set with mounting bolts anchored in the concrete pad.
2. Remove the enclosure doors and alternator-end panel to gain access to the junction box and other generator set components during installation.
3. Ground the generator set. The grounding method must comply with NEC and local codes. Connect the grounding strap to the generator set ground lug, terminal GRD inside the junction box. See Figure 2-1.

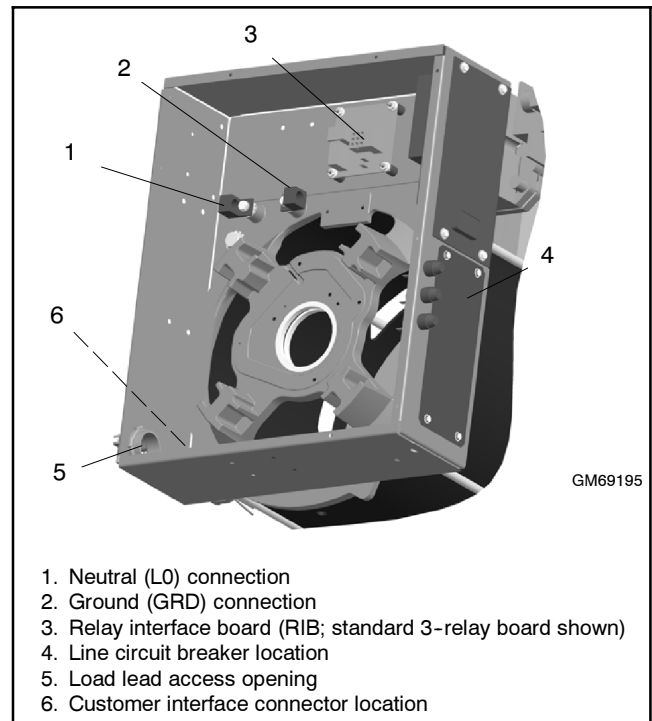

Figure 2-1 Generator Set Junction Box

Generator sets are shipped with the generator set neutral attached to the generator set in the junction box. At installation, the neutral can be grounded at the generator set or lifted from the ground stud and isolated if the installation requires an ungrounded neutral connection at the generator set. The generator set will operate properly with the neutral either bonded to ground or isolated from ground at the generator set.

Various regulations and site configurations including the National Electrical Code (NEC), local codes, and the type of transfer switch used in the application determine the grounding of the neutral at the generator set. NEC 2002 Section 250.20 is one example that has a very good explanation of the neutral grounding requirements for generator sets.

2.2.3 Connect AC and DC Wiring

Note: Have a licensed electrician make the following electrical connections. All connections must comply with state and local codes.

Size the wire according to the length of run and 115% of the circuit current (amperage) as directed by the National Electrical Code® (NEC) in ANSI/NFPA 70. See Figure 2-1 and refer to the wiring diagrams in Section 5, Diagrams and Drawings.

Refer to Section 1.5 for additional information about connecting the electrical system.

Load Lead and Engine Start Connections

1. Install a 120 VAC receptacle for the generator set battery charger and block heater, if equipped. Supply power to the receptacle through a circuit that is powered at all times, by the utility and by the generator set during utility power outages.
2. Some codes require the use of a disconnect switch. Check the code requirements for your location and install a disconnect switch, if required.

3. Use separate conduit for the power cables and the low voltage engine start leads. Local codes and the length of run as well as the transfer switch wire size requirements will determine the wire size needed for the AC leads. Route the load leads into the junction box through the access opening in the back of the box.
4. Connect the load leads from the line circuit breaker in the generator set junction box to the transfer switch emergency power connection points. See Figure 2-1 and refer to transfer switch installation manual for ATS connection instructions.
5. Use the remote harness with pigtail connector at the customer interface connector to connect engine start leads 3 and 4 to the engine start terminals on the transfer switch. Refer to the transfer switch installation manual for ATS connection instructions.
6. If an auxiliary fault switch is used, connect it to leads 30 and N at the customer interface connector.

Optional Run/Common Fault Relay Interface Board (RIB)

The optional Run/Common Fault Relay interface board (RIB) has five relays and a customer connection harness. The standard RIB has three relays with no customer connections required. See Figure 2-1 for the RIB location.



The common fault relay is energized on a fault. The auxiliary run relay is energized when the generator set is running. When a relay is energized, the normally open contacts close and the normally closed contacts open.

Connect customer equipment to connector P24 on the optional relay board harness. Use 16 gauge or larger leads for the relay connections. Connect to each relay's normally open or normally closed contacts depending on the requirements for the connected equipment. See Figure 2-2 and the manufacturer's instructions for the connected equipment.

Lead Number	P24 Pin Number	Connection
88	6	Common fault relay normally open
89	2	Common fault relay common
90	3	Common fault relay normally closed
91	4	Run relay normally open
92	1	Run relay common
93	5	Run relay normally closed

Figure 2-2 Optional Relay Connections

2.2.4 Install Engine Starting Battery

 WARNING

<p>Explosion. Can cause severe injury or death. Relays in the battery charger cause arcs or sparks.</p> <p>Locate the battery in a well-ventilated area. Isolate the battery charger from explosive fumes.</p>

Battery gases. Explosion can cause severe injury or death. Battery gases can cause an explosion. Do not smoke or permit flames or sparks to occur near a battery at any time, particularly when it is charging. Do not dispose of a battery in a fire. To prevent burns and sparks that could cause an explosion, avoid touching the battery terminals with tools or other metal objects. Remove all jewelry before servicing the equipment. Discharge static electricity from your body before touching batteries by first touching a grounded metal surface away from the battery. To avoid sparks, do not disturb the battery charger connections while the battery is charging. Always turn the battery charger off before disconnecting the battery connections. Ventilate the compartments containing batteries to prevent accumulation of explosive gases.

Use a 12 VDC battery with a minimum rating of 525 CCA.

1. Verify that the generator set master switch is in the OFF/RESET position.
2. Ensure that the starting battery is fully charged before placing the battery in service.
3. Clean the battery posts and/or adapters if necessary.
4. Install battery post adapters, if needed.
5. See the dimension drawing in Section 5 for the battery rack location. Place the battery on the battery rack on the skid.
6. Connect the red battery cable to the positive (+) battery terminal.
7. Connect the black battery cable to the negative (-) battery terminal.
8. Place the boots over the battery terminals.
9. Plug the battery charger, if equipped, into the 120 VAC power supply.

2.2.5 Install and Connect Fuel Supply

⚠ WARNING

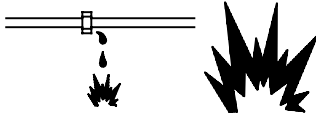

**Explosive fuel vapors.
Can cause severe injury or death.**

Use extreme care when handling, storing, and using fuels.

The fuel system. Explosive fuel vapors can cause severe injury or death. Vaporized fuels are highly explosive. Use extreme care when handling and storing fuels. Store fuels in a well-ventilated area away from spark-producing equipment and out of the reach of children. Never add fuel to the tank while the engine is running because spilled fuel may ignite on contact with hot parts or from sparks. Do not smoke or permit flames or sparks to occur near sources of spilled fuel or fuel vapors. Keep the fuel lines and connections tight and in good condition. Do not replace flexible fuel lines with rigid lines. Use flexible sections to avoid fuel line breakage caused by vibration. Do not operate the generator set in the presence of fuel leaks, fuel accumulation, or sparks. Repair fuel systems before resuming generator set operation.

Note: Have the fuel piping and regulator installed by the fuel supplier. The fuel supply installation must comply with NFPA and local codes.

1. See Figure 2-3 and the generator set spec sheet for the fuel supply requirements. Add up the fuel requirements for the generator set plus all other gas-fired equipment fueled by the same supply.
2. Check that the primary regulator and gas meter have sufficient capacity for the fuel requirements for the generator set plus all other gas-fired equipment. Have the fuel supplier install a larger gas meter, if necessary.

Model	Gas Flow Rate, Btu/hr.
15 kW	200000
30 kW	450000

Figure 2-3 Gas Flow Rate (natural gas and LP)

3. Measure the pipe length from the primary gas pressure regulator to the pipe connection on the generator set fuel inlet. Add 2.4 m (8 ft.) to the measured length for each 90 degree elbow. Use the pipe size indicated in Figure 2-4 for the total length of pipe.

Maximum Pipe Length, m (ft.)	Pipe Size	
	15 kW	30 kW
6.1 m (20 ft.)	3/4 in. NPT	1 1/4 in. NPT
9.1 m (30 ft.)	1 in. NPT	1 1/4 in. NPT
18.3 m (60 ft.)	1 in. NPT	1 1/2 in. NPT
30.5 m (100 ft.)	1 1/4 in. NPT	1 1/2 in. NPT
45.7 m (150 ft.)	1 1/4 in. NPT	2 in. NPT
61.0 m (200 ft.)	1 1/4 in. NPT	2 in. NPT

Figure 2-4 Fuel Pipe Sizes

4. Have your fuel supplier install a manual fuel shutoff valve and rigid gas piping. Bring the pipe to within 254 mm (10 in.) of the generator set fuel inlet location. See Figure 2-5.



Figure 2-5 Manual Fuel Shutoff Valve (outdoor installation shown)

5. Remove the enclosure door on the service side of the unit.
6. Connect the fuel supply:
 - a. Apply pipe sealant that is approved for fuel connections to the threaded fuel connections.
 - b. Use a section of flexible fuel line to connect the fuel supply to the fuel inlet connection on the generator set. See Figure 2-6 and Figure 2-7 for the fuel inlet connection location.
 - c. Open the manual fuel valves and leak test all fuel connections using soapy water. If a leak is detected, close the fuel valves, disconnect the lines at the location of the leak, clean the fittings, and apply fresh pipe sealant. Reconnect the lines and recheck for leaks.

Note: After the system installation is complete, you will be instructed to check for fuel leaks with the generator set running. See Section 2.2.8, Operation Tests.

7. Verify that the fuel system is set up for the fuel being used (natural gas or LP). See Section 2.2.6.

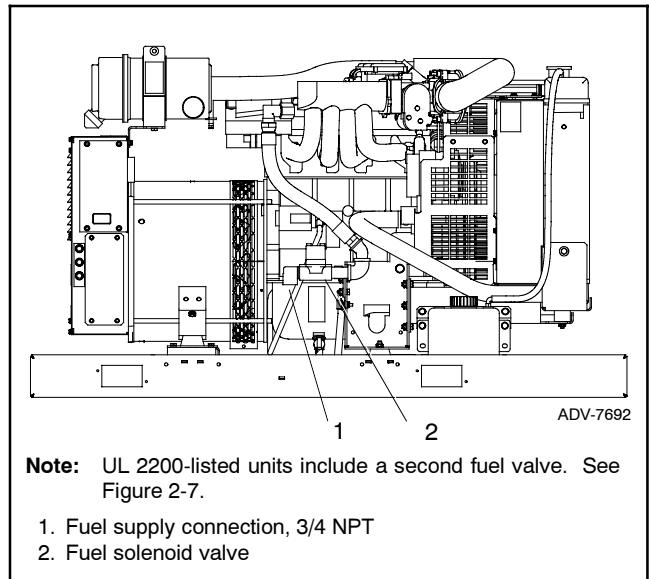

Figure 2-6 Fuel Supply Connection Location (Generator set enclosure not shown)

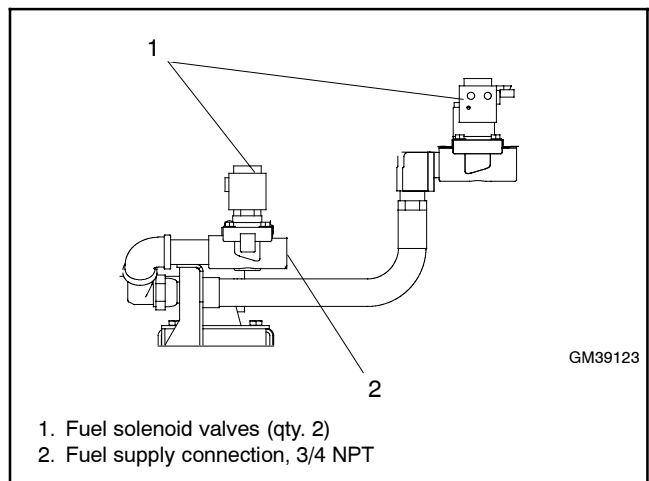

Figure 2-7 Fuel Supply Connection with Two Fuel Valves

2.2.6 Fuel Conversion Procedures

Note: The Integrated Electronic Pressure Regulator (IEPR) and air/fuel mixer are specially calibrated emission-control devices. Do not adjust the IEPR or the air/fuel mixer.

Check the connections to the fuel solenoid valve to verify that the fuel system is set up for the type of fuel that will be used. See Figure 2-6 for the location of the fuel solenoid valve.

To change the fuel type, change the connection to the fuel solenoid valve as described below and shown in Figure 2-8.

LP Connections:

- Disconnect lead 73A from the fuel valve.
- Connect lead 73B to the fuel valve.
- Connect lead 65 to lead N3 (ground).

Natural Gas Connections:

- Disconnect lead 65 from N3.
- Disconnect lead 73B from the fuel valve.
- Connect lead 73A to the fuel valve.

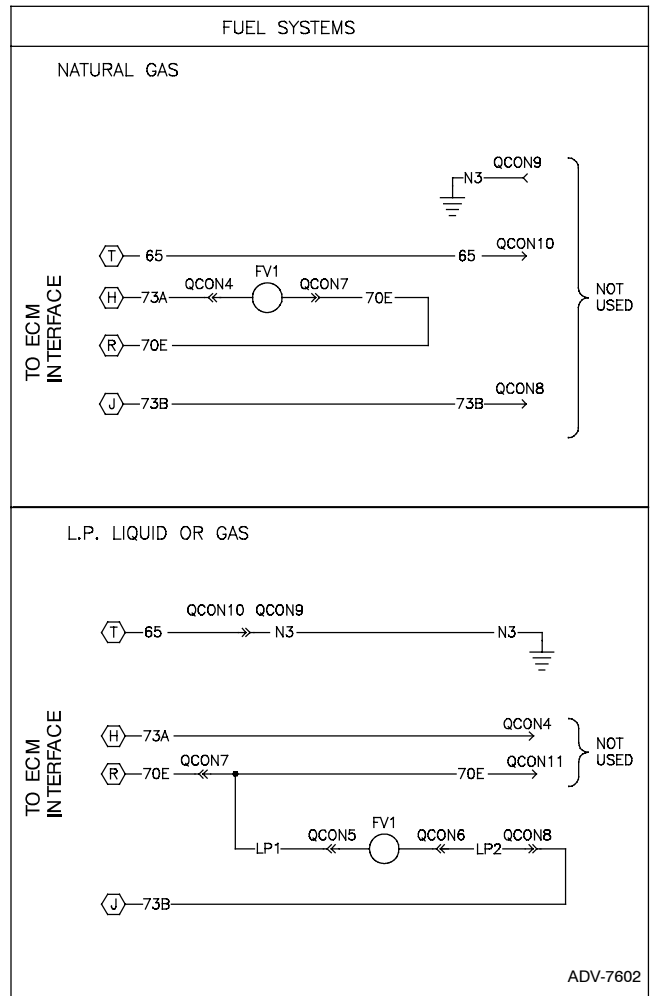

Figure 2-8 Fuel Type Connections

2.2.7 Add Coolant

Follow the instructions below to fill the cooling system.

1. Close the radiator's coolant drain valve and tighten the hose clamps.

Note: Do not add coolant to a hot engine. Adding coolant to a hot engine can cause the cylinder block or cylinder head to crack. Wait until the engine has cooled.

2. Fill the radiator with the recommended coolant mixture of 50% ethylene glycol and 50% clean, softened water to inhibit rust/corrosion and prevent freezing. See Figure 2-9 for coolant capacity. Do not replace the pressure cap at this time.

Note: A coolant solution of 50% ethylene glycol provides freezing protection to -37°C (-34°F) and overheating protection to 129°C (265°F). A coolant solution with less than 50% ethylene glycol may not provide adequate freezing and overheating protection. A coolant solution with more than 50% ethylene glycol can cause engine or component damage. Do not use alcohol or methanol antifreeze or mix them with the specified coolant.

Model	Coolant Capacity, L (Gal.)
15 kW	11.5 (3.0)
30 kW	11.5 (3.0)

Figure 2-9 Coolant Capacity

3. Check the oil level before operating the engine.
4. Operate the engine with the radiator's pressure cap removed until the thermostat opens and the radiator upper hose becomes hot.
5. Stop the engine and allow it to cool.
6. Add coolant to the radiator to just below the overflow tube on the filler neck. See Figure 2-10 for the overflow tube location.
7. Replace the radiator's pressure cap.
8. Maintain the coolant level in the coolant overflow bottle between the High and Low markings. See Figure 2-10 for the coolant overflow bottle location.

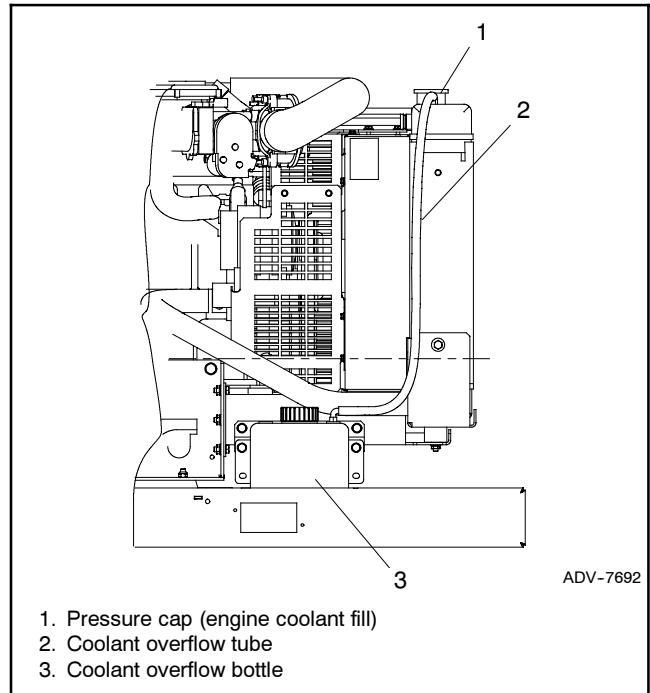
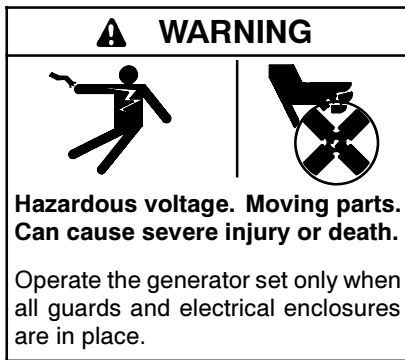

Figure 2-10 Coolant Fill

2.2.8 Operation Tests



1. Verify that all guards are in place. Install the enclosure's end panels and nonservice side door.
2. Check the items in the Prestart Checklist in the generator set operation manual.
3. Move the generator set master switch to the RUN position to start the generator set.
4. Use a digital voltmeter (DVM) to check the output voltage from the generator set. If voltage adjustments are required, refer to Section 4.5 for instructions to use the ADC 2100 voltage adjustment menu.
5. Perform voltage checks as described in the ATS operation and installation manual. Close the main circuit breaker on the main distribution panel when instructed to connect power in the test procedure.
6. Move the generator set master switch to OFF and then to the AUTO position.
7. Install the enclosure's service-side door. Verify that all enclosure doors and panels are installed.
8. Test the system operation as described in the ATS operation and installation manual.
9. Set the exerciser on the transfer switch to exercise the generator set weekly. Refer to the instructions in the ATS operation and installation manual.

Section 3 Accessories

3.1 Introduction

Accessories are available factory-installed and/or shipped loose. Obtain the most current list of accessories from the generator set specification sheet or by contacting an authorized Kohler distributor/ dealer.

Have accessories installed by your local authorized Kohler distributor/dealer or authorized representative. Follow the installation instructions provided with each kit.

Use separate conduit for AC and DC leads to reduce the possibility of electrical interference. Use shielded cable for all analog inputs. Verify that the leads and conduit do not interfere with the operation of the generator set or obstruct the service areas.

Verify that the accessory installation complies with the National Electrical Code (NEC) and all applicable local and state codes.

Accessory Wiring. To determine the appropriate size for the customer-supplied wiring of engine battery-powered accessories, use the guidelines in Figure 3-1. Use 18–20 gauge wire for signal wires up to 305 m (1000 ft.).

Length, m (ft.)	Wire Gauge
30.5 (100)	18–20
152.4 (500)	14
304.8 (1000)	10

Figure 3-1 Wire Length and Size, Lead N and 42B

Refer to the wiring diagram manual for more information regarding generator set electrical connections.

The following sections detail a few common accessories and their functions. The instructions provided with the accessory kit supersede these instructions, if different.

3.2 Common Fault and Run Relay Board

The optional relay board replaces the standard relay interface board (RIB) and provides two additional relays to control customer-provided equipment:

- Common fault relay
- Auxiliary run relay

The relay board location is shown in Figure 3-2. Connect customer equipment to the relay board harness. Figure 3-3 lists the customer connections.

The common fault relay is energized on a fault. The auxiliary run relay is energized when the generator set is running. Connect to each relay’s normally open or normally closed contacts depending on the application.

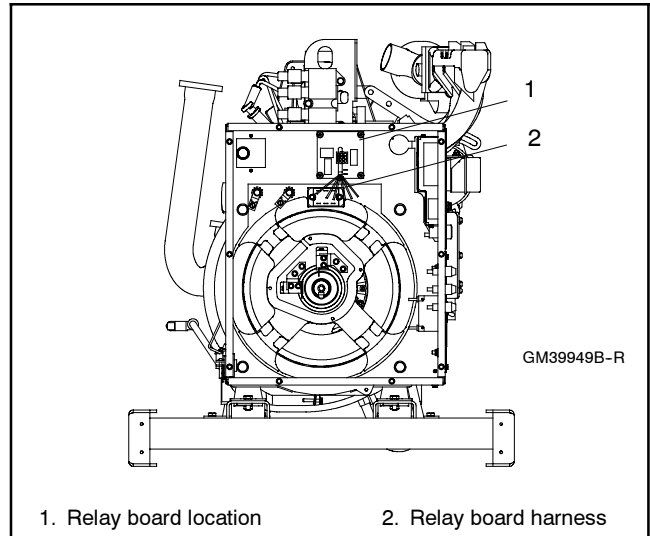

Figure 3-2 Common Fault and Run Relay Board

Harness Lead Number	Connector Pin Number	Connection
88	6	Common fault relay normally open
89	2	Common fault relay common
90	3	Common fault relay normally closed
91	4	Run relay normally open
92	1	Run relay common
93	5	Run relay normally closed

Figure 3-3 Common Fault and Run Relay Board Harness Connections

3.3 Remote Digital Gauge

The Remote Digital Gauge allows for remote starting/stopping and monitoring of certain generator set functions. See Figure 3-4. The Remote Digital Gauge connects to the 12-pin customer-interface connector. Refer to TT-1439 for instructions to install, connect, and operate the gauge.

Note: The Remote Digital Gauge will not display the oil pressure in this application.



Figure 3-4 Remote Digital Gauge

The ADC 2100 communications parameter Cn must be set to Cn01 or Cn06 to communicate with the gauge. See Section 4.3 for important controller power down information. See Section 4.4 for more information on controller configuration.

Use one or more remote extension harness kits to connect the gauge to the generator set. Do not use more than 3 remote harness kits and do not exceed 22.86 m (75 ft.) in harness length. See Figure 2 for kit selection.

Remote Extension Harness Kit Number	Length, m (ft.)
GM32333-KP1	4.6 (15)
GM32333-KP2	7.6 (25)

Figure 2 Remote Extension Harness Kits (for gauge to generator set)

3.4 Block Heaters

Block heaters are available as installed accessories on all generator sets. Use block heaters on all standby applications where the generator set is subject to temperatures below 16°C (60°F). Connect the block heater to a power source that is energized when the generator set is not running.

Note: Block heater damage. The block heater will fail if the energized heater element is not immersed in coolant. Fill the cooling system before turning on the block heater. Run the engine until it is warm and refill the radiator to purge the air from the system before energizing the block heater.

3.5 Oil Makeup Kit

The optional oil makeup kit, available for 30 kW generator sets, provides an additional 2 quarts of oil for extended run time. The kit also provides a large glass sight gauge that allows quick and easy checks of the oil level. Follow the instructions provided with the kit to add oil, if necessary, and to check the height of the oil level sight gauge during generator set installation.

3.6 OnCue Home Generator Management System

The OnCue™ Home Generator Management System allows monitoring and control of your generator set from a personal computer located in your home or at other remote locations. OnCue can also be configured to send email or text message notifications in the event of a generator set fault.

The OnCue system is available separately as a loose kit. Follow the instructions provided with the OnCue kit to install the network bridge inside the generator set junction box, connect to your ethernet router and cable or DSL modem, and configure the system for monitoring and notification.

4.1 Advanced Digital Control (ADC 2100)

The generator sets use the Advanced Digital Control (ADC 2100). The ADC 2100 uses password-protected menus for generator output adjustments and controller configuration.

This section contains instructions for using the controller's password-protected menus to check and adjust the generator output and controller configuration. The controller configuration and generator set output are factory-set and should not require field adjustment under normal circumstances. Check and adjust the configuration and/or output when:

- The controller has been replaced.
- The voltage requires adjustment for a particular application.
- Troubleshooting generator set problems.

Have controller setup and adjustment performed only by an authorized Kohler distributor/dealer or authorized representative.

4.2 Code Version

These models require ADC 2100 application code version 3.25 or later. The code version is displayed as you enter the controller configuration mode. See Figure 4-2.

4.3 Controller Automatic Power Down

With the generator set master switch in the AUTO position, there are three possible controller power modes.

48-hour power down. If the ADC 2100 controller is not configured for a CAN gauge (communications parameter setting Cn00, see Section 4.4), the controller will power down after 48 hours of no activity. If the generator set has been started, the controller will power

down 48 hours after the generator stops. A remote start signal from a transfer switch or remote switch connected to engine start leads 3 and 4 will signal the controller to power up and the generator set to start.

Continuous power mode. If the ADC 2100 is configured for a CAN gauge (communications parameter setting Cn01), the controller will not power down. The ADC 2100 remains powered at all times to allow remote start commands from the remote CAN gauge.

1-hour power down. Setting the communications parameter to Cn06 will cause the controller to power down after 1 hour of no activity. In this mode, a remote start/stop switch or the generator set master switch must be used to activate the controller after it has powered down. Controller application code version 1.21 or higher is required for the 1-hour power down option.

4.4 Controller Configuration

The controller configuration for each generator model is set at the factory and should not normally require changes. The controller's configuration mode allows adjustment of the system parameters listed in this section. Use the instructions in this section to check the configuration after installation and change them to match the settings shown in Figure 4-1, if necessary.

Note: If the controller is replaced, the new ADC 2100 will need to be configured to the settings for the generator set as described in this section.

Note: The controller will automatically exit the configuration mode without saving any changes after about 1 minute if no buttons are pressed. Start the configuration procedure over again from the beginning if the controller exits the configuration mode before the settings have been saved.

Parameter	Setting	Definition
Unit's system voltage and frequency	Uu01	Single phase, 3 wire, 60 Hz, 120/240 VAC
Unit configuration	Uc01	Standby
Engine type	Ec11	15 and 30 kW
Engine data input types	Ed01	15/30 kW
Battery Voltage	Bt12	Battery voltage 12 VDC
Communications	Cn00	No CAN communications, 48-hour power down (factory setting)
	Cn01	J1939 (use for Remote Digital Gauge), no power down
	Cn06	Enables J1939 communications and 1-hour ADC 2100 power down after engine stop for either: a. Remote start/stop switch b. Automatic transfer switch c. Remote Digital Gauge with remote start/stop switch and replacement harness

Figure 4-1 Configuration Parameters

Follow the instructions in Figure 4-2 to enter the configuration mode while the engine is not running and then step through the parameters. Use the up (Λ) and down (∇) arrow buttons to select the appropriate setting for the application.

Note: Be sure to save your settings before exiting the configuration mode. See Figure 4-4. The controller reverts to the last saved settings when the master switch is moved to the OFF/RESET position.

Voltage/frequency setting (Uu). Set the system voltage and frequency to the value shown in Figure 4-1.

Note: This parameter sets the nominal system voltage and frequency. To adjust the output (measured) voltage, see Section 4.5.

Unit configuration (Uc). This parameter sets the generator set type: marine, standby, or mobile.

Engine configuration (Ec). The engine configuration must match the generator set engine type.

Advanced configuration mode (Adnc). The data input types, battery voltage, and communications setting can be changed in the advanced configuration mode. Press the up arrow button when *Adnc* is displayed to enter the advanced configuration mode. See Figure 4-3.

Engine data input types (Ed). This setting defines the types of senders used on the generator set engine.

Battery voltage (Bt). This setting toggles between 12 and 24 VDC for the engine starting battery voltage. The generator set uses a 12-volt battery, Bt12.

Communications setting (Cn). This setting allows the user to set the controller for communication with optional meters. The factory setting is Cn00, no CAN communications. Change this setting to Cn01 or Cn06 if an optional Remote Digital Gauge is used. See Figure 4-1.

Controller Configuration Mode:

Hold the Select button:



Move the generator set master switch to the RUN position. (The generator set engine will not start.)

Wait about 5 seconds until the display shows the program version number. (The number may be different than the one shown here.)

Press the down arrow key and then the up arrow key 3 times to enter the configuration mode. (This is the controller "password.")

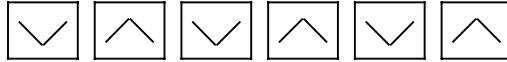

Display:

Now release the Select button.

Press:



or



To set the voltage/frequency setting to Uu01. See Figure 4-1.



To step to the next parameter, unit configuration Uc.



or



To change the unit configuration setting to Uc01, if necessary.



To step to the next parameter, engine type Ec.



or



To change the engine type to Ec11, if necessary.



To step to the next parameter, advanced configuration mode or save mode selection.

Now either save your settings or enter the Advanced Configuration Mode to set the engine data inputs, battery voltage, and communications.

Press:



To enter advanced configuration mode.
Go to Figure 4-3.

or



or











To proceed to the save mode without entering the advanced configuration mode.
Go to Figure 4-4.

Note: Shaded boxes show which number in the controller display changes when the up or down arrow key is pressed.

Figure 4-2 Configuration Mode (system voltage/frequency, unit configuration, and engine type parameters)

Pressing the up arrow key at the Adnc display (See Figure 4-2) puts you into the Advanced Configuration Mode.

Press:



	or		To set the engine data input type to Ed01. See Figure 4-1.	E d 0 1
			To enter battery voltage selection mode.	
	or		To toggle between 12 and 24 VDC. Set this parameter to 12 VDC.	B t 1 2
			To enter communications selection mode.	
	or		To set the communications parameter Cn. See Figure 4-1.	C n 0 0
			To enter SAVE mode. Go to Figure 4-4.	S A V E

Note: Be sure to save your settings before exiting the configuration mode. The controller reverts to the last saved settings when the master switch is moved to the OFF/RESET position.

Figure 4-3 Advanced Configuration Mode (engine data input type, battery voltage, and engine communications)

There are 3 options when the display says SAVE:

Press:

	To return to the first parameter, system voltage/frequency Uu, to check or change settings before saving. See Figure 4-2.	U u 0 1
or		
	To save changes.	Y E S
or		
	To discard changes without saving.	n o

“Yes” or “no” flashes when the up or down arrow is pressed and then the controller exits the configuration mode. The display returns to the runtime hours.

X X X X

Now move the master switch to OFF/RESET.

* X in the runtime hours display above denotes any number from 0 to 9.

Figure 4-4 Save Mode (after configuring generator set parameters)

4.5 Voltage Adjustments

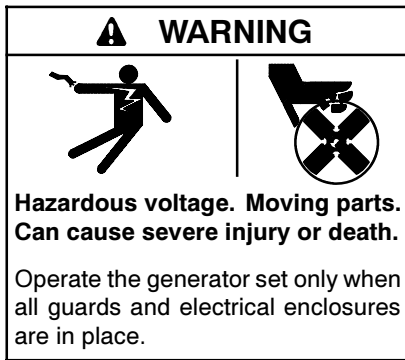

Short circuits. Hazardous voltage/current can cause severe injury or death. Short circuits can cause bodily injury and/or equipment damage. Do not contact electrical connections with tools or jewelry while making adjustments or repairs. Remove all jewelry before servicing the equipment.

The controller's adjustment mode allows adjustment of the output voltage, if necessary. Have adjustments performed by an authorized Kohler distributor/ dealer or service technician.

Note: A digital voltmeter is required for these adjustments.

Use a voltmeter to check the output voltage. If the output voltage is not within specifications, use the ADC controller to adjust the output voltage while the generator set is running. The flowcharts in Figure 4-6 and Figure 4-7 outline the adjustment procedures.

Note: Be sure to save your settings before exiting the configuration mode.

Voltage changes are lost if they are not saved before the generator set shuts down. The generator set continues to run with the new settings until it shuts down but then reverts to the previous settings at the next startup if the changes have not been saved.

Pressing the Select button when SAVE is displayed returns to the first parameter, voltage adjust (1P).

Note: Refer to the flowcharts in Figure 4-6 and Figure 4-7 during the voltage adjustment procedure.

Voltage Adjustment Procedure

1. With the generator set off, connect a digital multimeter to the output leads or an electrical outlet on the load side of the generator set. Set the meter to measure AC voltage.
2. Start the generator set by moving the generator set master switch to the RUN position.
3. Use the ADC controller to adjust the voltage (parameter 1P) until the output voltage reaches the desired value. See Figure 4-5 for the approximate change in voltage per step in parameter 1P. See Figure 4-6 for adjustment instructions.

Measured Voltage, VAC	Voltage Change per Step, VAC	
	Coarse Adjust	Fine Adjust
85-132	5	0.5
180-251	7	0.7

Figure 4-5 Voltage Adjustment (approximate)

4. Adjust the voltage stability (gain, parameter 2P) to minimize light flicker. See Figure 4-6 for adjustment instructions.
5. Readjust the voltage, if necessary.
6. Save the controller settings as described in Figure 4-7.
7. Stop the generator set.

Output Voltage Adjustment Mode:

Move the generator set master switch to the RUN position. The generator set engine starts and the controller display shows the engine runtime hours.

Display :*

X X X X

Hold:



Wait about 5 seconds until the display changes from runtime hours to the program version number.

X.XX

Press the down arrow key and then the up arrow key 3 times to enter the adjustment mode. (This is the controller "password.")

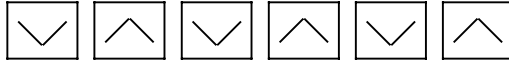

1 P X X

The controller is now in the voltage coarse adjustment mode.

Press:



or



To raise or lower the voltage in large increments (approximately 5-7 volts per step).

1 P X X



To enter fine voltage adjustment mode.

1 P X X



or



To raise or lower the voltage in smaller increments (approximately 0.5-0.7 volts per step).

2 P X X



To enter coarse voltage stability (gain) adjustment mode.



or



To raise or lower the voltage stability (gain) in large increments.

2 P X X



To enter fine voltage stability (gain) adjustment mode.



or



To raise or lower the voltage stability (gain) in smaller increments.

3 P 0 X



To enter volts/Hz adjustment mode.



or



To raise or lower the volts/Hz: 00=low; 09= high

Continued on Figure 4-7.

* Shaded boxes show which character in the controller display changes for each adjustment. X in the examples above denotes any number from 0 to 9. The actual values may vary from model-to-model.

TP6196

Figure 4-6 Output Voltage Adjustments

Continued from Figure 4-6:

Display : *



To enter SAVE mode.

S A V E

Note: Be sure to save your settings before exiting the configuration mode. The controller reverts to the last saved settings when the master switch is moved to the OFF/RESET position.

**There are 3 options when the display says SAVE:
Press:**

S A V E



To return to the first parameter, coarse voltage adjustment, to check or change settings before saving. See Figure 4-6.

1 P x x

or



To save changes.

Y E S

or



To discard changes without saving.

n o

“Yes” or “no” flashes when the up or down arrow is pressed and then the controller exits the configuration mode. The display returns to the runtime hours.

X X X X

Now move the master switch to OFF/RESET.

* X in the examples above denotes any number from 0 to 9. The actual values may vary from model-to-model.

Figure 4-7 Output Voltage Adjustments, Continued

Notes

Section 5 Dimension Drawings

Figure 5-1 lists the drawing numbers and page numbers.

Note: See TP-6719, Wiring Diagram Manual, for wiring diagrams and schematics.

Dimension Drawing Description	Drawing Number	Page
Weather Housing with Sound Kit	ADV-7694 Sheet 1	36
Sound Enclosure	ADV-7694 Sheet 2	37
Installation Clearances	ADV-7694 Sheet 3	38

Figure 5-1 Drawing Numbers and Locations

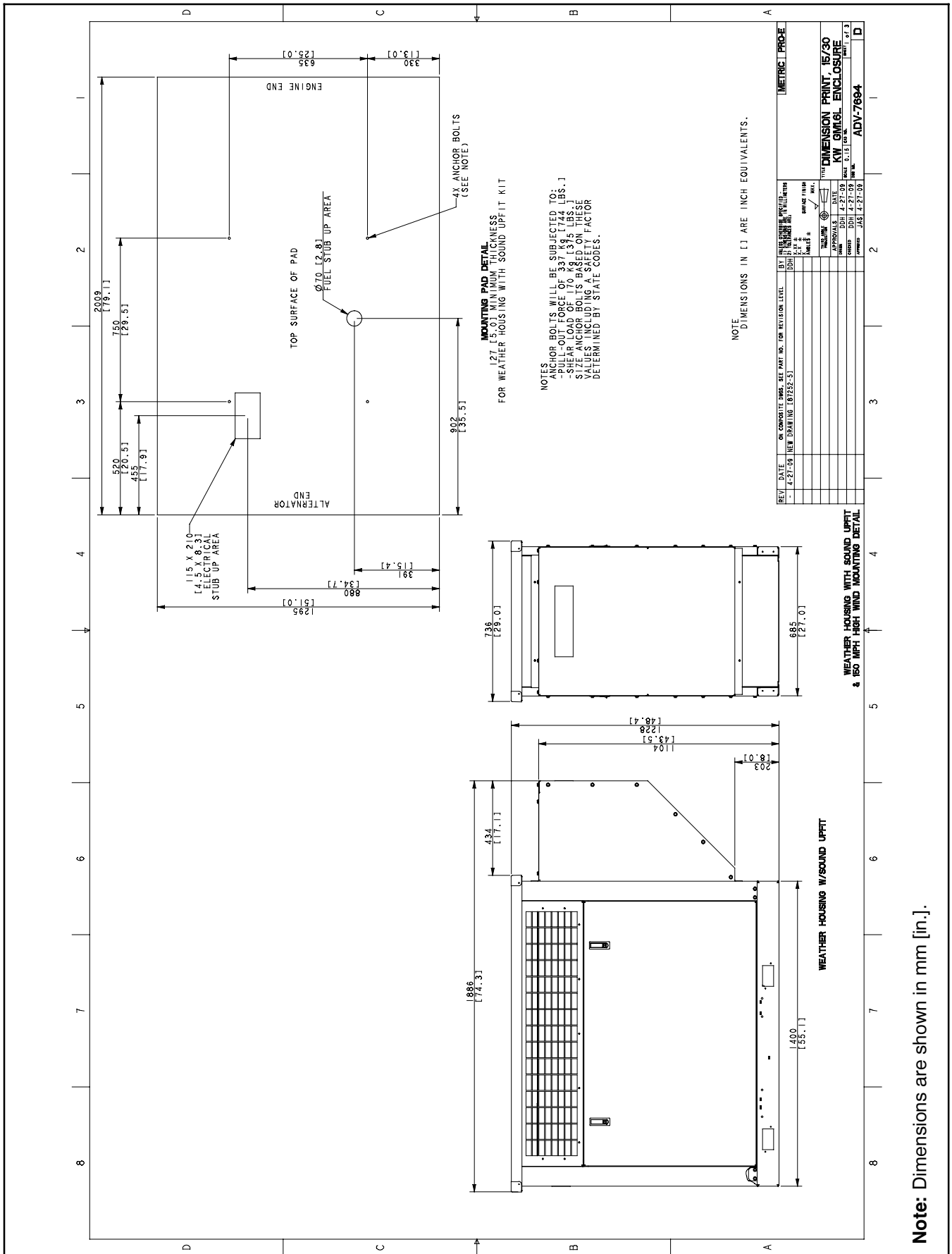

Note: Dimensions are shown in mm [in.].

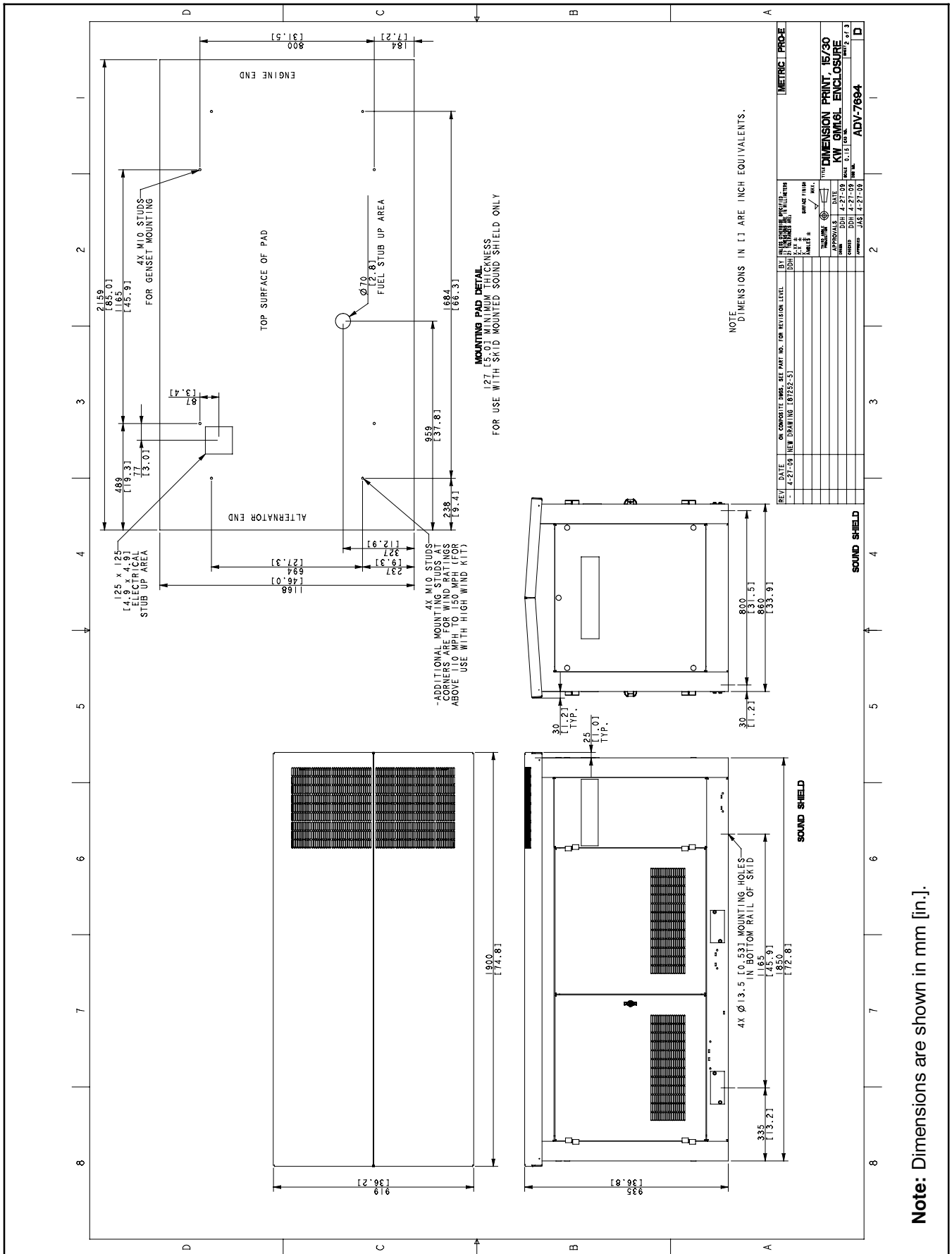

Figure 5-3 Dimension Drawing, Sound Enclosure, ADV-7694, Sheet 2

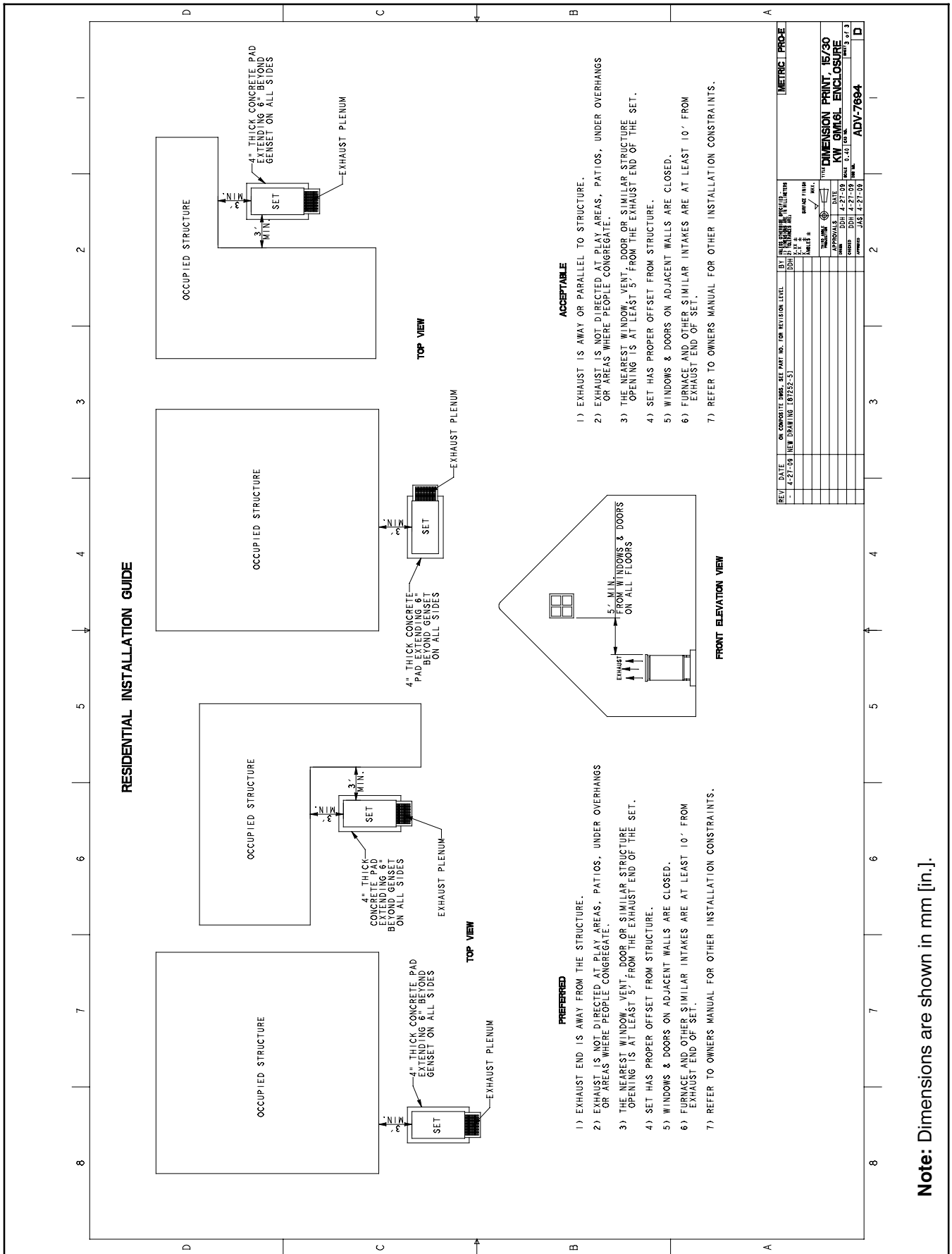

Figure 5-4 Installation Clearances, ADV-7694, Sheet 3

Appendix A Abbreviations

The following list contains abbreviations that may appear in this publication.

A, amp	ampere	cfm	cubic feet per minute	est.	estimated
ABDC	after bottom dead center	CG	center of gravity	E-Stop	emergency stop
AC	alternating current	CID	cubic inch displacement	etc.	et cetera (and so forth)
A/D	analog to digital	CL	centerline	exh.	exhaust
ADC	advanced digital control; analog to digital converter	cm	centimeter	ext.	external
adj.	adjust, adjustment	CMOS	complementary metal oxide substrate (semiconductor)	F	Fahrenheit, female
ADV	advertising dimensional drawing	cogen.	cogeneration	fglass.	fiberglass
Ah	amp-hour	com	communications (port)	FHM	flat head machine (screw)
AHWT	anticipatory high water temperature	coml	commercial	fl. oz.	fluid ounce
AISI	American Iron and Steel Institute	Coml/Rec	Commercial/Recreational conn.	flex.	flexible
ALOP	anticipatory low oil pressure	cont.	connection	freq.	frequency
alt.	alternator	CPVC	chlorinated polyvinyl chloride	FS	full scale
Al	aluminum	crit.	critical	ft.	foot, feet
ANSI	American National Standards Institute (formerly American Standards Association, ASA)	CRT	cathode ray tube	ft. lb.	foot pounds (torque)
AO	anticipatory only	CSA	Canadian Standards Association	ft./min.	feet per minute
APDC	Air Pollution Control District	CT	current transformer	ftp	file transfer protocol
API	American Petroleum Institute	Cu	copper	g	gram
approx.	approximate, approximately	cUL	Canadian Underwriter's Laboratories	ga.	gauge (meters, wire size)
AQMD	Air Quality Management District	CUL	Canadian Underwriter's Laboratories	gal.	gallon
AR	as required, as requested	cu. in.	cubic inch	gen.	generator
AS	as supplied, as stated, as suggested	cw.	clockwise	genset	generator set
ASE	American Society of Engineers	CWC	city water-cooled	GFI	ground fault interrupter
ASME	American Society of Mechanical Engineers	cyl.	cylinder	GND, ⊕	ground
assy.	assembly	D/A	digital to analog	gov.	governor
ASTM	American Society for Testing Materials	DAC	digital to analog converter	gph	gallons per hour
ATDC	after top dead center	dB	decibel	gpm	gallons per minute
ATS	automatic transfer switch	dB(A)	decibel (A weighted)	gr.	grade, gross
auto.	automatic	DC	direct current	GRD	equipment ground
aux.	auxiliary	DCR	direct current resistance	gr. wt.	gross weight
avg.	average	deg., °	degree	H x W x D	height by width by depth
AVR	automatic voltage regulator	dept.	department	HC	hex cap
AWG	American Wire Gauge	DFMEA	Design Failure Mode and Effects Analysis	HCHT	high cylinder head temperature
AWM	appliance wiring material	dia.	diameter	HD	heavy duty
bat.	battery	DI/EO	dual inlet/end outlet	HET	high exhaust temp., high engine temp.
BBDC	before bottom dead center	DIN	Deutsches Institut für Normung e. V. (also Deutsche Industrie Normenausschuss)	hex	hexagon
BC	battery charger, battery charging	DIP	dual inline package	Hg	mercury (element)
BCA	battery charging alternator	DPDT	double-pole, double-throw	HH	hex head
BCI	Battery Council International	DPST	double-pole, single-throw	HHC	hex head cap
BDC	before dead center	DS	disconnect switch	HP	horsepower
BHP	brake horsepower	DVR	digital voltage regulator	hr.	hour
blk.	black (paint color), block (engine)	E, emer.	emergency (power source)	HS	heat shrink
blk. htr.	block heater	ECM	electronic control module, engine control module	hsg.	housing
BMEP	brake mean effective pressure	EDI	electronic data interchange	HVAC	heating, ventilation, and air conditioning
bps	bits per second	EFR	emergency frequency relay	HWT	high water temperature
br.	brass	e.g.	for example (<i>exempli gratia</i>)	Hz	hertz (cycles per second)
BTDC	before top dead center	EG	electronic governor	IC	integrated circuit
Btu	British thermal unit	EGSA	Electrical Generating Systems Association	ID	inside diameter, identification
Btu/min.	British thermal units per minute	EIA	Electronic Industries Association	IEC	International Electrotechnical Commission
C	Celsius, centigrade	EI/EO	end inlet/end outlet	IEEE	Institute of Electrical and Electronics Engineers
cal.	calorie	EMI	electromagnetic interference	IMS	improved motor starting
CAN	controller area network	emiss.	emission	in.	inch
CARB	California Air Resources Board	eng.	engine	in. H ₂ O	inches of water
CB	circuit breaker	EPA	Environmental Protection Agency	in. Hg	inches of mercury
cc	cubic centimeter	ES	engineering special, engineered special	in. lb.	inch pounds
CCA	cold cranking amps	ESD	electrostatic discharge	Inc.	incorporated
ccw.	counterclockwise			ind.	industrial
CEC	Canadian Electrical Code			int.	internal
cert.	certificate, certification, certified			int./ext.	internal/external
cfh	cubic feet per hour			I/O	input/output
				IP	iron pipe
				ISO	International Organization for Standardization
				J	joule
				JIS	Japanese Industry Standard

k	kilo (1000)	MTBO	mean time between overhauls	rms	root mean square
K	kelvin	mtg.	mounting	rnd.	round
kA	kiloampere	MTU	Motoren-und Turbinen-Union	ROM	read only memory
KB	kilobyte (2 ¹⁰ bytes)	MW	megawatt	rot.	rotate, rotating
KBus	Kohler communication protocol	mW	milliwatt	rpm	revolutions per minute
kg	kilogram	μF	microfarad	RS	right side
kg/cm ²	kilograms per square centimeter	N, norm.	normal (power source)	RTU	remote terminal unit
kgm	kilogram-meter	NA	not available, not applicable	RTV	room temperature vulcanization
kg/m ³	kilograms per cubic meter	nat. gas	natural gas	RW	read/write
kHz	kilohertz	NBS	National Bureau of Standards	SAE	Society of Automotive Engineers
kJ	kilojoule	NC	normally closed	scfm	standard cubic feet per minute
km	kilometer	NEC	National Electrical Code	SCR	silicon controlled rectifier
kOhm, kΩ	kilo-ohm	NEMA	National Electrical Manufacturers Association	s, sec.	second
kPa	kilopascal	NFPA	National Fire Protection Association	SI	<i>Systeme international d'unites</i> , International System of Units
kph	kilometers per hour	Nm	newton meter	SI/EO	side in/end out
kV	kilovolt	NO	normally open	sil.	silencer
kVA	kilovolt ampere	no., nos.	number, numbers	SN	serial number
kVAR	kilovolt ampere reactive	NPS	National Pipe, Straight	SNMP	simple network management protocol
kW	kilowatt	NPSC	National Pipe, Straight-coupling	SPDT	single-pole, double-throw
kWh	kilowatt-hour	NPT	National Standard taper pipe thread per general use	SPST	single-pole, single-throw
kWm	kilowatt mechanical	NPTF	National Pipe, Taper-Fine	spec	specification
kWth	kilowatt-thermal	NR	not required, normal relay	specs	specification(s)
L	liter	ns	nanosecond	sq.	square
LAN	local area network	OC	overcrank	sq. cm	square centimeter
L x W x H	length by width by height	OD	outside diameter	sq. in.	square inch
lb.	pound, pounds	OEM	original equipment manufacturer	SS	stainless steel
lbm/ft ³	pounds mass per cubic feet	OF	overfrequency	std.	standard
LCB	line circuit breaker	opt.	option, optional	stl.	steel
LCD	liquid crystal display	OS	oversize, overspeed	tach.	tachometer
ld. shd.	load shed	OSHA	Occupational Safety and Health Administration	TD	time delay
LED	light emitting diode	OV	overvoltage	TDC	top dead center
Lph	liters per hour	oz.	ounce	TDEC	time delay engine cooldown
Lpm	liters per minute	p., pp.	page, pages	TDEN	time delay emergency to normal
LOP	low oil pressure	PC	personal computer	TDES	time delay engine start
LP	liquefied petroleum	PCB	printed circuit board	TDNE	time delay normal to emergency
LPG	liquefied petroleum gas	pF	picofarad	TDOE	time delay off to emergency
LS	left side	PF	power factor	TDON	time delay off to normal
L _{wa}	sound power level, A weighted	ph., ∅	phase	temp.	temperature
LWL	low water level	PHC	Phillips® head Crimptite® (screw)	term.	terminal
LWT	low water temperature	PHH	Phillips® hex head (screw)	THD	total harmonic distortion
m	meter, milli (1/1000)	PHM	pan head machine (screw)	TIF	telephone influence factor
M	mega (10 ⁶ when used with SI units), male	PLC	programmable logic control	TIR	total indicator reading
m ³	cubic meter	PMG	permanent magnet generator	tol.	tolerance
m ³ /hr.	cubic meters per hour	pot	potentiometer, potential	turbo.	turbocharger
m ³ /min.	cubic meters per minute	ppm	parts per million	typ.	typical (same in multiple locations)
mA	milliampere	PROM	programmable read-only memory	UF	underfrequency
man.	manual	psi	pounds per square inch	UHF	ultrahigh frequency
max.	maximum	psig	pounds per square inch gauge	UL	Underwriter's Laboratories, Inc.
MB	megabyte (2 ²⁰ bytes)	pt.	pint	UNC	unified coarse thread (was NC)
MCCB	molded-case circuit breaker	PTC	positive temperature coefficient	UNF	unified fine thread (was NF)
MCM	one thousand circular mils	PTO	power takeoff	univ.	universal
meggar	megohmmeter	PVC	polyvinyl chloride	US	undersize, underspeed
MHz	megahertz	qt.	quart, quarts	UV	ultraviolet, undervoltage
mi.	mile	qty.	quantity	V	volt
mil	one one-thousandth of an inch	R	replacement (emergency) power source	VAC	volts alternating current
min.	minimum, minute	rad.	radiator, radius	VAR	voltampere reactive
misc.	miscellaneous	RAM	random access memory	VDC	volts direct current
MJ	megajoule	RDO	relay driver output	VFD	vacuum fluorescent display
mJ	millijoule	ref.	reference	VGA	video graphics adapter
mm	millimeter	rem.	remote	VHF	very high frequency
mOhm, mΩ	milliohm	Res/Coml	Residential/Commercial	W	watt
MOhm, MΩ	megohm	RFI	radio frequency interference	WCR	withstand and closing rating
MOV	metal oxide varistor	RH	round head	w/	with
MPa	megapascal	RHM	round head machine (screw)	w/o	without
mpg	miles per gallon	rly.	relay	wt.	weight
mph	miles per hour			xfrm	transformer
MS	military standard				
ms	millisecond				
m/sec.	meters per second				
MTBF	mean time between failure				

Notes

Notes

TP-6725 11/09

© 2009 by Kohler Co. All rights reserved.

KOHLER[®] POWER SYSTEMS

KOHLER CO. Kohler, Wisconsin 53044
Phone 920-565-3381, Fax 920-459-1646
For the nearest sales/service outlet in the
US and Canada, phone 1-800-544-2444
KohlerPower.com

Kohler Power Systems
Asia Pacific Headquarters
7 Jurong Pier Road
Singapore 619159
Phone (65) 6264-6422, Fax (65) 6264-6455