

**ISO-FLAMES**  
**A PRODUCT OF EARTHCORE INDUSTRIES, LLC.**  
**INSTALLATION, OPERATION, MAINTENANCE and**  
**OWNER'S MANUAL**  
**STADIUM BURNER SET**

**IMPORTANT:** This manual contains assembly rules, installation steps and guidelines, and use and maintenance instructions for Iso-Flames Stadium Burner Set gas appliance. This manual must become the property of and be reviewed by all current and future users of this product. It is the responsibility of the general contractor and the installer of this product that the instructions in this manual are followed exactly. This product must be installed in strict accordance with the gas log manufacturer's listing and explicit installation and operation instructions.

**This Listed Top Vented Gas Log Appliance is  
designed for use with Natural Gas or  
Propane (LP) Gas only.**

**WARNING: If the information in this manual is not followed exactly, a fire or explosion may result causing property damage, personal injury or loss of life.**

- Do not store or use gasoline or any other flammable vapors or liquids in the vicinity of this or any other appliance.

**- WHAT TO DO IF YOU SMELL GAS:**

- \* Do not try to light any appliance.
- \* Do not touch any electrical switch.
- \* Do not use any phone in your building.
- \* Immediately call your gas supplier from a neighbor's phone. Follow the gas supplier's instructions.
- \* If you cannot reach your gas supplier, call the fire department.

**- NOT FOR USE WITH SOLID FUEL.**  
**- The flue damper must be in the full open position when burning the gas logs.**

**-This appliance complies with National Safety and is tested and listed to ANSI Z21.50b - 2009 as vented gas fireplaces.**  
**- Installation and service must be performed by a locally certified gas service agent, licensed plumber or the gas supplier.**  
**-Installation must conform to local codes. Check local codes prior to installation.**  
**In the absence of local codes, installation must conform with current National Fuel Gas Code, ANSI Z223.1.**

**INSTALLER: Leave this manual with the appliance.**  
**CONSUMER: Retain this manual for future reference.**



PFS Report No. 09-79

SAP No. 506022-03

© 2009 ECI

Issued: September 1, 2009

Revision: 001

**THIS MANUAL CAN ONLY BE REPRODUCED IN ITS ENTIRETY**

## Table of Contents

ISO-FLAMES Gas Log System Owners Manual .....	3
General Information .....	4
Safety Instruction Prior to Installation/Pilot Assembly Wire Diagram.....	4-5
Gas Log Burner Installation .....	6-8
ISO-FLAMES Gas Log Assembly Instructions.....	9-10
Safety Instruction Before Lighting & Lighting Instructions .....	11-12
Troubleshooting & Maintenance .....	13
Optional Iso-Flame Wall Switch Instructions.....	14
Customer Service & Warranty .....	15
Warranty Card .....	16

# Stadium Burner ISO-FLAMES Gas Log Installation

ISO-FLAMES® Gas Log System

OWNER'S MANUAL  
Installation & Operating Instructions  
ISO-FLAMES Gas Log Systems  
24" - 30"

THE ISO-FLAMES GAS LOG SYSTEM MUST BE INSTALLED BY A LICENSED PLUMBER OR GAS FITTER AND IN ACCORDANCE WITH ALL LOCAL/STATE/FEDERAL CODES.

## WARNINGS

1. READ THESE INSTRUCTIONS COMPLETELY BEFORE USING THE ISO-FLAMES GAS LOG SYSTEM.
2. The ISO-FLAMES gas log system must be installed in the Isokern B-Vent (IBV) fireplace series.
3. Minimum fireplace opening must adhere to the size chart listed on page 6 of this owner's manual.
4. Fireplace must adhere to: noncombustible hearth extending minimum twenty inches (20"), noncombustible material extending a minimum of twelve inches (12") above the top of the fire box opening; noncombustible materials extending minimum eight inches (8") on both sides of fireplace opening.
5. If the information in this owner's manual is not followed exactly, a fire or explosion may result causing property damage, personal injury or loss of life.
6. Do not store or use gasoline or other flammable vapors and liquids in the vicinity of the ISO-FLAMES gas log system.
7. What to do if you smell gas:
  - A. Do not try to light the ISO-FLAMES gas log system or any appliance.
  - B. Do not touch electrical switches or the telephone.
  - C. From your neighbor's telephone, call your gas supplier and follow the gas supplier's instructions.
  - D. If you cannot reach your gas supplier, call the fire department.
8. Improper installation, adjustment, alteration, service or maintenance can cause injury or loss of life. Refer to this owner's manual for assistance.
9. Do not install the ISO-FLAMES gas log system in a manufactured home or mobile home.
10. **Installer: Leave this owner's manual for the consumer; consumer: save this owner's manual for future reference.**

## General Information

### Tools Required:

1. Adjustable wrench
2. 3/8" flaring tool
3. Open-end wrench (7/16")
4. Open-end wrench (3/4")
5. Pipe thread sealer (Non-hardening)
6. Slip-joint pliers (7")
7. Flat blade screwdriver
8. Pipe wrench (10")
9. 50/50 soap & water solution
10. Flashlight

### System Contents:

The ISO-FLAMES gas log system consists of the following items. If any of the items below are damaged or missing, call us directly at (800) 642-2920 and we will promptly answer your call.

1. ISO-FLAMES gas log burner with remote control valve
2. 3/8" x 1/2" brass supply fitting
3. Flared aluminum manifold with 3/8" brass flare nut
4. Embers
5. Gas Logs
6. Twig gas logs
7. Lava rock
8. Optional damper stop
9. Optional 3/8" x 1/2" brass elbow
10. Hand-held remote control
11. Wall Switch Mount (Optional)

## Safety Instructions Prior To Installation

### WARNING:

1. When used without fresh air, the ISO-FLAMES gas log system may give off carbon monoxide, an odorless and poisonous gas. You must make adequate air supply accessibility or provisions for combustion and ventilation; carbon monoxide poisoning may lead to death.
2. Check the ISO-FLAMES gas log system for proper gas type; the gas type will be marked on the rating plate. A liquid propane ISO-FLAMES gas log system must have a standing pilot; a manual valve or a key valve is never to be used with liquid propane.
3. The installation and provisions for combustion and ventilation air must conform with the National Fuel Gas Code, ANSI Z223.1/NFPA 54, or the CSA B 149.1, National Gas and Propane Installation Code.
4. Solid-fuels must not be burned in a fireplace where the ISO-FLAMES gas log system is installed.
5. Fireplace chimney must have a permanent vent opening to the atmosphere of not less than ten inch inside diameter. (10")
6. Fireplace must adhere to: noncombustible hearth extending minimum twenty inches (20"), noncombustible material extending a minimum of twelve inches (12") above the top of the fire box opening; noncombustible materials extending minimum eight inches (8") on both sides of fireplace opening.
7. Minimum fireplace opening must adhere to the size chart listed on next page:

## Safety Instructions Prior To Installation/Pilot Assembly Wire Diagram

ISO-FLAMES BURNER	FIREPLACE WIDTH	FIREPLACE HEIGHT MINIMUM	BTU NATURAL GAS	BTU LIQUID PROPANE
24"	36"	30"	50,000	50,000
30"	46"	30"	65,000	65,000

### 8. Gas supply pressures:

GAS SUPPLY PRESSURE	NATURAL GAS	LIQUID PROPANE
Minimum inlet gas supply pressure for the purpose of input adjustment	5" w.c.	10.5" w.c.
Maximum inlet gas supply pressure	7" w.c.	13" w.c.
Manifold pressure	6" w.c.	10" w.c.

The ISO-FLAMES gas log system's gas control valve must be disconnected from gas supply piping system during any pressure testing of the ISO-FLAMES gas log system at test pressures in excess of 1/2 psi (3.5kpa). The ISO-FLAMES gas log system must be isolated from the gas piping system by closing the gas control valve during any pressure testing of the gas supply piping system at test pressures less than 1/2 psi (3.5kPa).

9. All ISOFLAME gas log assembly systems (whether with Safety Pilot Valve or Remote Pilot Valve) are equipped with a 1/8 NPT plugged tapping, accessible for test gage connection, immediately upstream of the gas supply connection to the appliance.

10. The ISO-FLAMES gas logs are convertible if done by a certified gas technician.

11. Keep the ISO-FLAMES gas log system's area clear and free from combustible materials such as gasoline and other flammable vapors and liquids.

12. Do not use the ISO-FLAMES gas log system if any part has been immersed in water. Call a qualified service technician to inspect the ISO-FLAMES gas log system. Replace any part of the ISO-FLAMES gas log system that has been immersed in water.

13. The fireplace chimney and flue needs to be inspected and cleaned once a year by a qualified service technician.

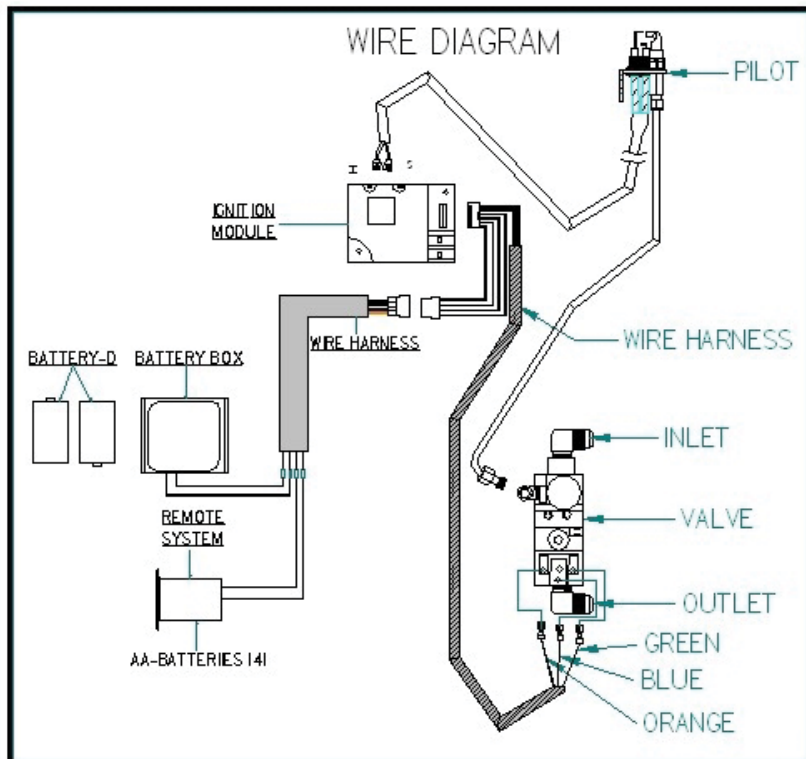

## ISO-FLAMES Gas Log Burner Installation

The gas control valve is installed on the right side of the ISO-FLAMES gas log burner. If the gas supply line comes into the left side of the fireplace, the gas supply line must continue to the right side of the fireplace (as close to the rear fire box wall as possible) and terminate behind the gas valve inlet using rigid 1/2" black iron pipe. At this point only the 3/8" aluminum manifold can be used to complete the connection to the gas control valve. It may be necessary to cut and reflare the aluminum manifold to the desired length for proper positioning of the burner pan.

Step 1. Remove all ashes and debris from fireplace.

Step 2. Be sure gas control valve to fireplace is in the OFF position.

Step 3. Place the ISO-FLAMES gas log burner in fireplace with grate spokes toward front of fireplace and vertical baffle should be in line with chimney.

### NATURAL GAS OR LIQUID PROPANE

A. Apply pipe thread sealer to gas supply line coming into fireplace and install 3/8" x 1/2" brass supply fitting; tighten.

B. Install longer end of flared aluminum manifold with 3/8" brass flair nut to 3/8" x 1/2" brass supply fitting connected to gas supply line coming into fireplace, and shorter end to rear of gas control valve; tighten.

C. When connections are complete, NEVER TEST FOR GAS LEAKS WITH A LIT MATCH OR FLAME. Slowly turn gas control valve to the ON position and use 50/50 soap and water solution with a toothbrush or small paint brush over all gas connections. A leak will be evident by observation of bubbles on gas connections. If bubbles are observed, retighten leaking gas connectors.

### Gas Log Installation:

See pages 9 & 10. Logs are reversible for either a classic bark look, or a rugged split look.

**WARNING:** Failure to position items in accordance with these diagrams or failure to use only parts specifically approved with the ISO-FLAMES gas log system may result in property damage or personal injury.

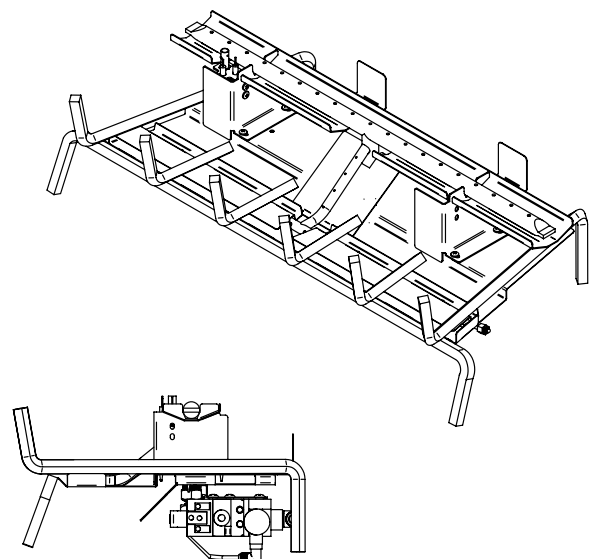
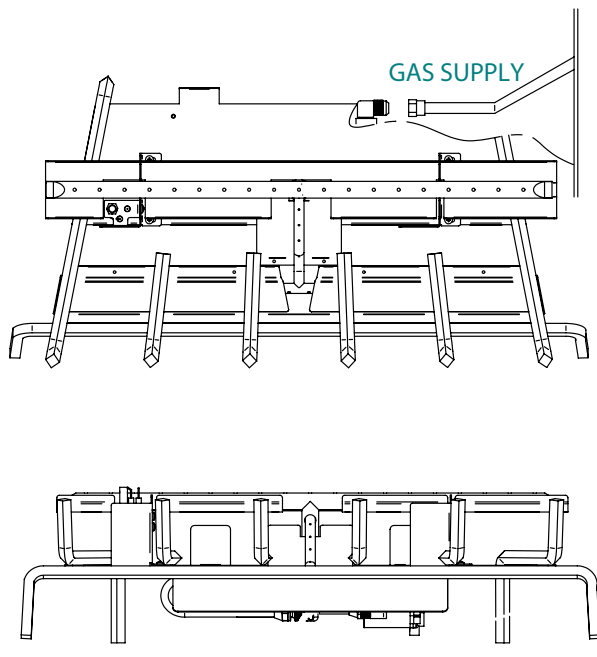

## Gas Log Burner Installation

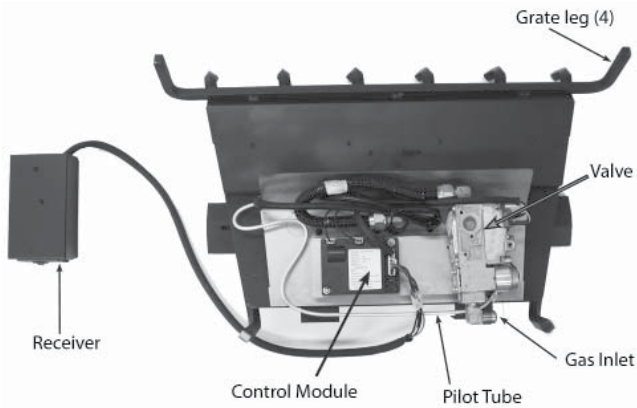

Fig. 1 - Burner System Detail - Bottom View

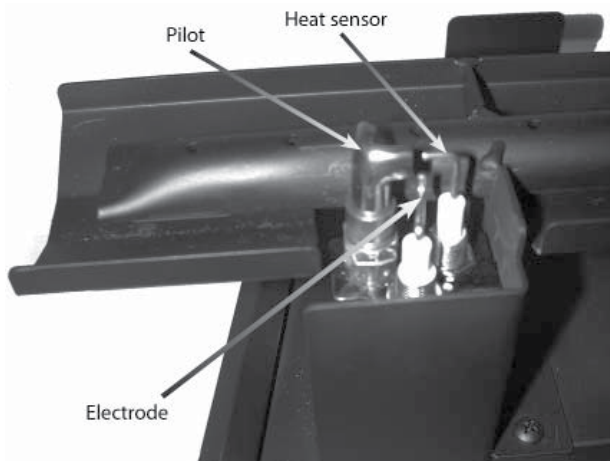

Fig. 2 - Burner System Detail - Pilot Assy

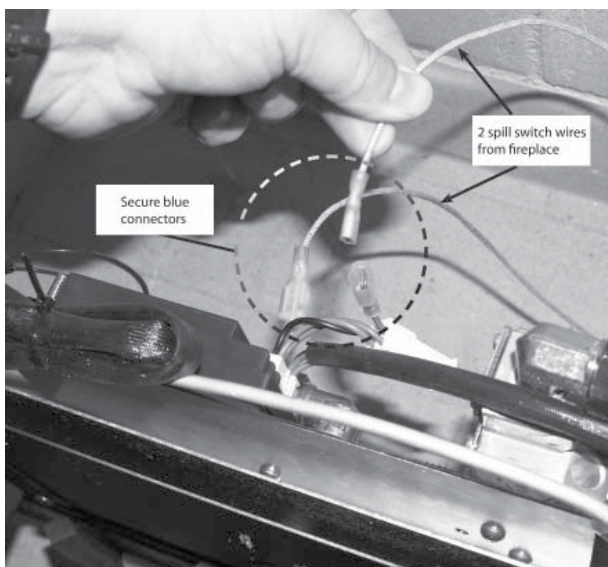

Fig. 3 - Connect spill switch wires

1. MAKE SURE THE FIREPLACE GAS SUPPLY IS TURNED OFF.
2. Place the burner system in the fireplace. Rest it upward, on the front grate fingers to expose and allow access to the bottom rear of the burner controls.
3. Locate the two spill switch wires coming out of the hole in the lower right side of the fireplace. Connect the spill switch wires to the two free wires (coming from the control module) located at the rear of the burner system (see Fig. 3).
4. Place the burner system down so that it rests on the burner grate legs. Center the burner toward the rear of the fireplace. (Reference Fig. 5 for orientation.)
5. Locate the gas-supply stub inside the fireplace and remove the cap, if attached (see Fig. 4).
6. Use pipe compound resistant to all gases or Teflon tape to attach the supplied elbow to the gas-supply stub. Then attach the flex connector (coming off of the burner system) to the elbow (see Fig. 4).

## Gas Log Burner Installation (cont.)

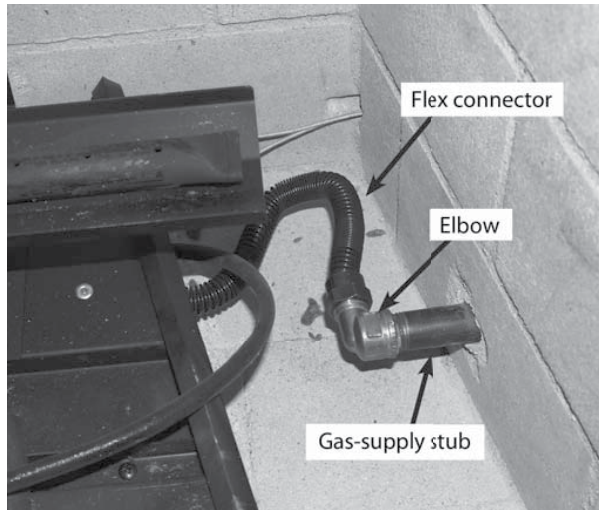

Fig. 4 - Connect gas supply

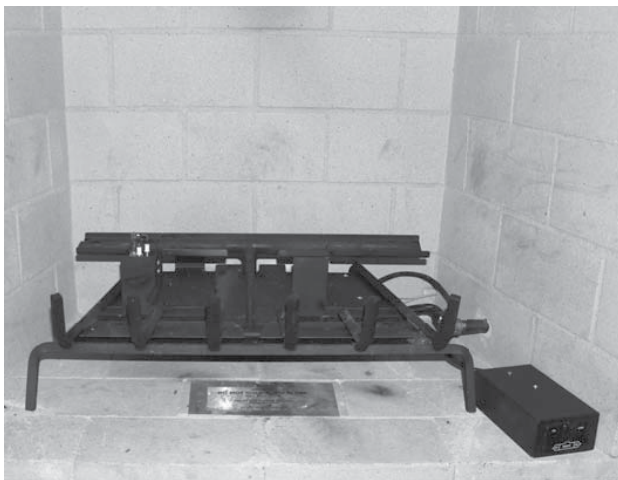

Fig. 5 - Remote box location

7. LEAK TEST: Turn on the fireplace gas supply, and test at all connections for leaks using the appropriate soapy water solution. If bubbles appear, a leak is present. Turn off the gas and tighten at all connections. Repeat until no leaks are present. If a leak persists, turn off the gas supply and contact the local gas company or dealer. **NEVER USE A FLAME TO CHECK FOR LEAKS.**
8. Place the remote receiver box at the right front corner of the fireplace. Be sure to run its wire in between the two grate legs on the right side of the burner system, and that the wire remains away from the burner system and its flame during operation. (See Fig. 5.)
9. Spread the supplied lava rock on the floor of the firebox around the front and sides of the burner system. The lava rock may be placed around the rear, top, and left side of the remote receiver box. Leave the front of the box clear for control access.  
  
DO NOT place any lava rock on the burner system, or behind it.
10. Proceed to the "ISO-Flames Gas Log Assembly Instructions" section for ember and log placement.



## ISO-FLAMES Gas Log Assembly Instructions



This instruction contains suggested log placement for the ISO-FLAMES log set. Some flexibility is possible in log placement to suit your individual preference provided excessive sooting does not result from flames striking the logs too directly (see important below). The suggested log placement will allow for superior flame pattern and appearance. Please read these instructions completely and carefully before beginning.

**Important:** Although there is some flexibility with the log placement, adequate spacing between the logs is **NECESSARY** and **MUST** be maintained for best performance. Some carbon build up (sooting) may occur where the flames strike the logs, and should not be a concern, unless excessive. If sooting is excessive, rearrange the top logs to allow more opening for the flame.

**WARNING:** Use only parts specifically approved for use with this gas log set. Failure to do so may result in property damage or personal injury. Check with your local dealer if you need more information.

**CAUTION:** Burn hazard! Logs will remain hot for some time after use. If you need to reposition any log to maintain the proper layout, use heat resistant gloves or allow logs adequate time to cool before handling.

## ISO-FLAMES Gas Log Assembly Instructions (cont.)

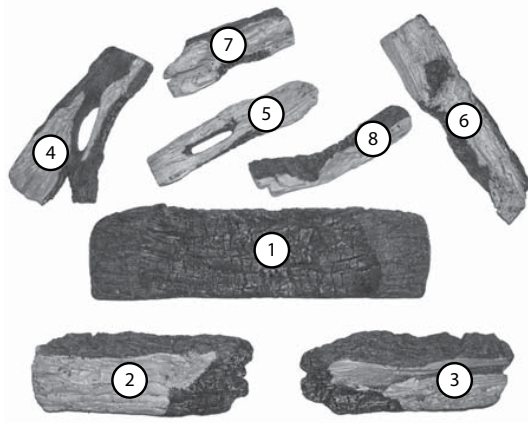

Fig. 2-1

Note: Highlighting added to improve clarity.

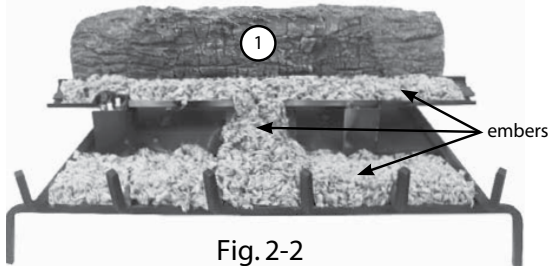

Fig. 2-2

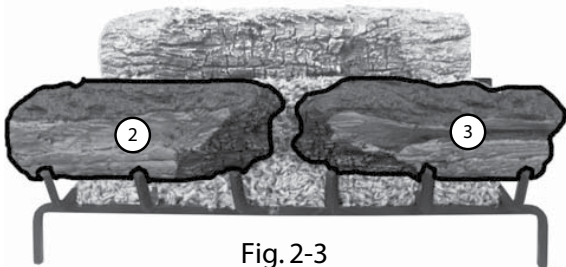

Fig. 2-3

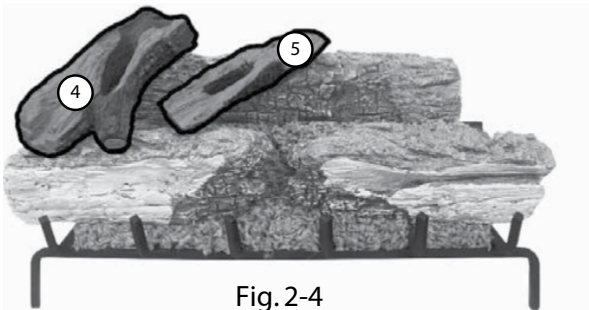

Fig. 2-4

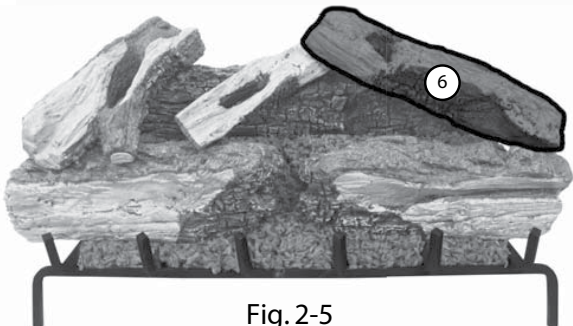

Fig. 2-5

### LOG LIST

1. Bottom rear log
2. Bottom left log
3. Bottom right log
4. Middle left log
5. Middle center log
6. Middle right log
7. Top left log
8. Top right log

### LOG PLACEMENT

Each log in this gas log set is numbered here to assist in the log placement procedure.

1. Prior to log placement, spread the provided embers evenly over the designated areas on the burner, as shown in Fig. 2-2.
2. Set the bottom rear log #1 at the rear of the grate (Fig. 2-2). Center the log, with its back up against the burner tabs.
3. Set the bottom left and right logs #2-3 at the front of the burner with the charred ends facing inward. Leave a small gap in between the two charred ends. (Fig. 2-3). Center the logs, with their backs up against the burner tabs. (The bottom left log is longer and will slightly stick outward more than the bottom right log.)
4. Position the middle center log #4 on the left side of the log set, resting on logs #1 and #2 as shown. Position the middle center log #5 in a similar manner (with more of an angle), toward the center of the log set. (Fig. 2-4.)
5. Position the middle right log #6 on the right side of the log set, resting on logs #3 and #5 as shown in Fig. 2-5.
6. Position the top left log #7 at a slight angle on top of logs #4 and #5 as shown. The charred end should rest downward. Complete log placement by positioning the top right log #8 at an angle on top of log #6, with the bottom end resting in between the charred section of logs #1 and #2. (Fig. 2-6.)

### Final Log Placement

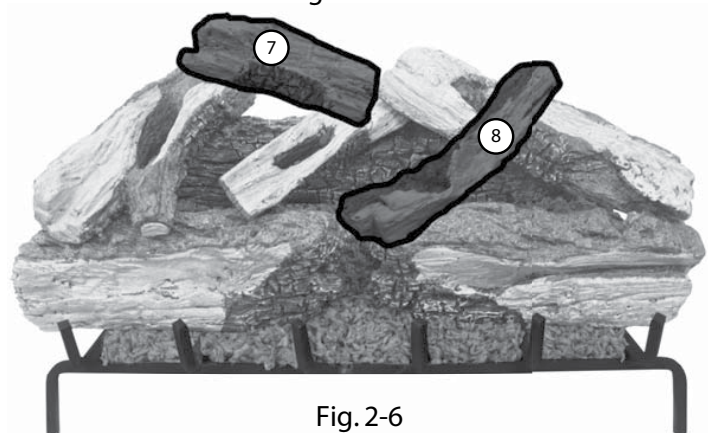

Fig. 2-6

# Safety Instructions Before Lighting & Lighting Instructions

## FOR YOUR SAFETY READ BEFORE LIGHTING

**WARNING:** If you do not follow these Instructions exactly, a fire or explosion may result causing property damage, personal injury or loss of life.

A. This appliance has a pilot which must be lit by hand. When lighting the pilot follow these instructions exactly.

B. BEFORE LIGHTING smell all around the appliance area for gas. Be sure to smell next to the floor.

### WHAT TO DO IF YOU SMELL GAS

- Do not try to light any appliance
- Do not touch any electric switch; do not use any phone in your building;
- Immediately call your gas supplier from a neighbor's phone. Follow the gas supplier's instructions.
- If you cannot reach your gas supplier, call the fire department.

D. Do not use this appliance if any part has been under water. Immediately call a qualified service technician to inspect the appliance and to replace any part of the control system and any gas control which has been under water.

## LIGHTING INSTRUCTIONS

1. STOP! Read the safety information on the other side.
2. Turn "OFF" any electrical appliance
3. When operated with remote system flip the receiver control to the "Remote" position, and turn unit "ON" and "OFF" by using the remote transmitter.
4. Flip the receiver switch to the "ON" position when manually operated. This transmits a rapid series of sparks at the pilot head and will ignite the gas.

- Sparks cease when the pilot flame is lit and stable. After a short time, the pilot will then light the main burner.

**CAUTION:** IF THE BURNER DOES NOT IGNITE WITHIN 20 SECONDS, STOP WAIT 5 MINUTES, THEN REPEAT STEPS 2. THRU 4. ABOVE.

- Normally, the pilot should remain lit. If it goes out, repeat step 3 or 4.
- If the pilot will not stay lit after several tries, turn the wall switch to OFF (Fig.3) and call service technician or gas supplier.
- Periodically check the pilot for proper flame pattern (Fig. 1)

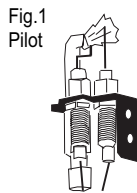

Fig.3



Fig.2



## TO TURN OFF GAS TO THE APPLIANCE

1. Simply flip the receiver switch to the "OFF" position when manually operated. The gas flow will cease, and all the flames (main burner and pilot) will go out.
2. For remote operation, press the "OFF" button on the remote.

**WARNING:** Improper installation, adjustment, alteration, service or maintenance can cause injury or property damage. Refer to manual. For assistance or additional information consult a qualified installer, service agency or the gas supplier.

### FOR YOUR SAFETY

Do not store or use gasoline or other flammable vapors or liquids in the vicinity of this or any other appliance.

100234

## Lighting Instructions (cont.)

**Important:** The ISO-FLAMES Series gas log system must be installed by a licensed plumber or gas fitter per code.

**WARNING:** For safe operation of the ISO-FLAMES gas log system, a minimum inlet gas supply pressure of 5" w.c. is required

for natural gas; minimum gas supply inlet pressure 10.5" w.c. is required for liquid propane.

Improper installation, adjustment, alteration, service or maintenance can cause injury or property damage. For assistance or additional information, consult a qualified service technician or the gas supplier.

The ISO-FLAMES gas log system must be installed in an IBV only.

Minimum fireplace opening must adhere to the size chart listed on page 6 of this owner's manual.

Fireplace chimney must have a permanent vent opening to the atmosphere of not less than 10" diameter.

**CAUTION:** If you do not follow these instructions exactly, a fire or explosion may result causing property damage, personal injury or loss of life.

A. The ISO-FLAMES gas log system has a pilot assembly and it must be lit by hand. When lighting the pilot, follow these instructions exactly.

B. Before lighting the pilot, smell for gas around the ISO-FLAMES gas log system and next to the floor; gas can be heavier than air.

**What to do if you smell gas:**

1. Do not try to light the ISO-FLAMES gas log system or any appliance.

2. Do not touch electrical switches or the telephone.

3. From your neighbor's telephone, call your gas supplier and follow the gas supplier's instructions.

4. If you cannot reach your gas supplier, call the fire department.

C. Open the Damper by moving the Damper Lever (located at the top right of the firebox opening) from left to right.

D. Do not use the ISO-FLAMES gas log system if any part has been immersed in water. Call a qualified service technician to inspect the ISO-FLAMES gas log system. Replace any part of the ISO-FLAMES gas log system that has been immersed in water.



## Troubleshooting & Maintenance

PROBLEM	REASON	SOLUTION
Pilot will not light	Air in gas supply line	Bleed gas supply line
	Pilot hood blocked	<ul style="list-style-type: none"> <li>• Check for debris or dirt</li> <li>• Clean pilot</li> </ul>
	Low gas pressure	<ul style="list-style-type: none"> <li>• Check gas line for size and blockage</li> </ul>
	Dirty pilot	<ul style="list-style-type: none"> <li>• Pilot should be blue and hitting the thermocouple properly</li> <li>• Clean pilot</li> </ul>
Pilot will not stay lit	Pilot hood not aimed at thermocouple	Pilot hood bent; replace pilot or angle pilot hood properly so pilot flame hits thermocouple 1/2" below tip of thermocouple
	Pilot line bent	Replace pilot line
	Thermocouple is loose	Tighten thermocouple nut at gas control valve
	Thermocouple cracked	Replace thermocouple
	Thermocouple worn out	Replace thermocouple
	Excessive down draft	<ul style="list-style-type: none"> <li>• Install chimney cap</li> <li>• Outside Chimney too close to other peaks</li> <li>• Check chimney flue for proper height</li> <li>• Poorly designed chimney</li> </ul>
Gas log burner goes out	Low gas pressure; pilot fades	<ul style="list-style-type: none"> <li>• Dirty pilot</li> <li>• Gas line sized improperly</li> </ul>
	Thermocouple is loose	Tighten thermocouple nut at gas control valve
	Thermocouple worn out	Replace thermocouple

### Maintenance:

The ISO-FLAMES gas log system will last a lifetime, but periodic maintenance (at least once a year) is recommended.

Can you clean it yourself? Yes you can if you have the proper training! Safety is of prime concern so we recommend that you call your Earthcore authorized dealer for proper maintenance. If an Earthcore dealer is unavailable, call us directly at 800 642-2920 and we will promptly answer your call.

## OPTIONAL ISO-FLAMES WALL SWITCH INSTRUCTIONS

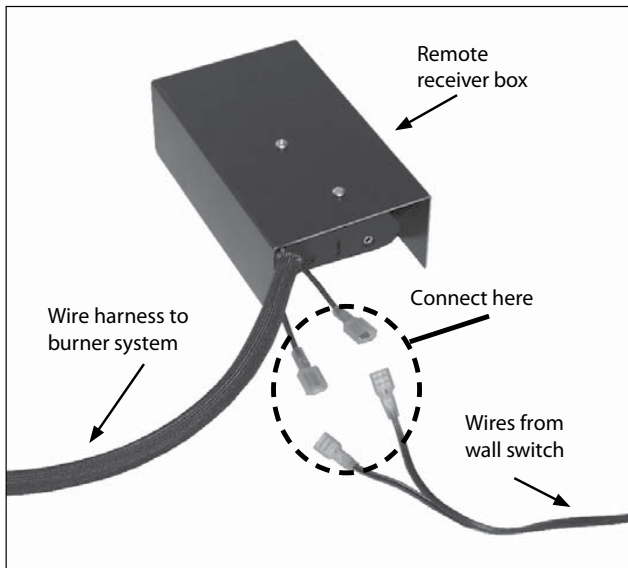

Fig. 1 - Connect wall switch to remote receiver box

### Installation

1. Install the wall switch in the desired location within 15 feet from the burner system in the fireplace.
2. Run the supplied wire from the wall switch to the burner system.
3. Locate the two wires coming out of the rear of the remote receiver box, and connect them to the two wires routed in from the wall switch (see Fig. 1).

**CAUTION:** Do not supply 110V AC to the wall switch or burner system. This is a self contained circuit.

### Operation

When using the wall switch to operate the burner system; the control located on the remote receiver box must be in the OFF position.

Alternately; when using the remote system, the wall switch must be in the OFF position.

## ISO-FLAMES Customer Service & Warranty

### Customer Service

Earthcore Industries, LLC is committed to customer service and exceeding customer expectations. We are available Monday - Friday 8:30 AM to 4:30 PM EST toll free at 800 642-2920 to provide technical assistance and answer any questions you may have.

### Warranty

THE WARRANTY MENTIONED HERE IS ONLY FOR THE ISO-FLAMES GAS LOG SET.

Earthcore Industries 20+ years of success is the result of exceeding customer expectations and as Earthcore looks ahead, this principle remains at the core of Earthcore culture.

You have a ONE YEAR PARTS WARRANTY with Earthcore products.

If you should accidentally break a log, or if there is another issue you may have with the ISO-FLAMES gas log system, please call your Earthcore Industries, LLC authorized dealer or call us directly at 800 642-2920.

It is important for you to register your ISO-FLAMES gas log system with Earthcore. Please complete the warranty card included in this manual on page 16.

1. The ISO-FLAMES gas log burner has a one year warranty against any performance defects.
2. The ISO-FLAMES gas logs have a one year warranty against breakage; except breakage due to mishandling or negligence.
3. If the ISO-FLAMES gas log burner was purchased with a gas control valve, the gas control valve has a one year warranty against any performance defects.
4. All painted surfaces that get wet due to rain, flooding, household pets, wild animals or birds, or get damaged due to negligence or disaster, have no warranty.
5. Embers and lava rock that get wet due to rain, flooding, household pets, wild animals or birds, or get damaged due to negligence or disaster, have no warranty.

# Warranty Card

Please cut along dashed lines and send to:

Earthcore Industries, LLC  
6899 Phillips Industrial Blvd.  
Jacksonville, FL 32256

Attn: Technical Department

## Warranty Card

Date of Purchase: \_\_\_\_\_

Name: \_\_\_\_\_

Address: \_\_\_\_\_

City, State: \_\_\_\_\_

Phone No. \_\_\_\_\_

Gas Log Burner Size:    24"    30" (Circle One)

Gas Control Valve Type:    remote control                      safety pilot

Gas Type:            Natural Gas            or            Liquid Propane (LP) - (Circle One)

Comments: \_\_\_\_\_

Purchased from: Name: \_\_\_\_\_

City, State: \_\_\_\_\_

Phone Number: \_\_\_\_\_

Installed by:    Name: \_\_\_\_\_

City, State: \_\_\_\_\_

Phone Number: \_\_\_\_\_