

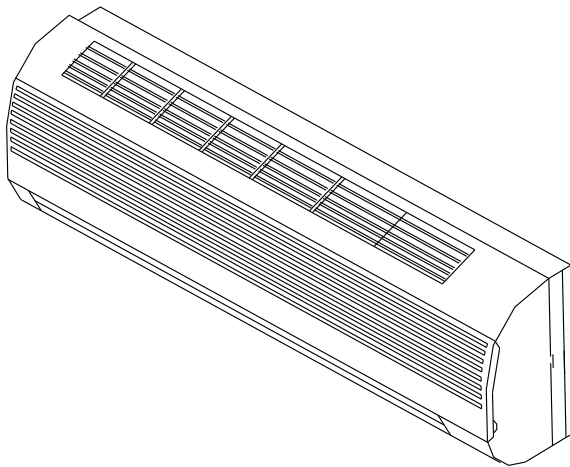

# SPLIT AIR-CONDITIONER OWNER 'S MANUAL



**Thank you for selecting super quality Air Conditioner. To ensure satisfactory operation for many years to come, this Owner's Manual should be read carefully before using your air conditioner. After reading, store it in a safe place. Please refer to the manual for questions on use or in the event that any irregularities occur.**

**This Air Conditioner should be used for household use.**

# CONTENTS

---

SAFETY PRECAUTIONS .....	1
NAMES OF THE PARTS .....	3
INDOOR UNIT DISPLAY.....	4
EMERGENCY FUNCTION & AUTO-RESTART FUNCTION .....	5
REMOTE CONTROL .....	6
MODES OF OPERATION .....	9
PROTECTION .....	14
INSTALLATION MANUAL.....	15
MAINTENANCE .....	24
TROUBLESHOOTING .....	25

In line with the company's policy of continual product improvement, the aesthetic and dimensional characteristics, technical data and accessories of this appliance may be changed without notice.

## SAFETY RULES AND RECOMMENDATIONS FOR THE INSTALLER

- ⚠ Read this guide before installing and using the appliance.
- ⚠ During the installation of the indoor and outdoor units the access to the working area should be forbidden to children. Unforeseeable accidents could happen.
- ⚠ Make sure that the base of the outdoor unit is firmly fixed.
- ⚠ Check that air cannot enter the refrigerant system and check for refrigerant leaks when moving the air conditioner.
- ⚠ Carry out a test cycle after installing the air conditioner and record the operating data.
- ⚠ The ratings of the fuse installed in the built-in control unit are 3.15A / 250V for 220V type and 3.15A/125V for 110V type.
- ⚠ The user must protect the indoor unit with a fuse of suitable capacity for the maximum input current or with another overload protection device.
- ⚠ Ensure that the mains voltage corresponds to that stamped on the rating plate. Keep the switch or power plug clean. Insert the power plug correctly and firmly into the socket, thereby avoiding the risk of electric shock or fire due to insufficient contact.
- ⚠ Check that the socket is suitable for the plug, otherwise have the socket changed.

- ⚠ Do not install the appliance at a distance of less than 50 cm from inflammable substances (alcohol, etc.) Or from pressurised containers (e.g. spray cans).
- ⚠ If the appliance is used in areas without the possibility of ventilation, precautions must be taken to prevent any leaks of refrigerant gas from remaining in the environment and creating a danger of fire.
- ⚠ The packaging materials are recyclable and should be disposed of in the separate waste bins. Take the air conditioner at the end of its useful life to a special waste collection centre for disposal.
- ⚠ Only use the air conditioner as instructed in this booklet. These instructions are not intended to cover every possible condition and situation. As with any electrical household appliance, common sense and caution are therefore always recommended for installation, operation and maintenance.
- ⚠ The appliance must be installed in accordance with applicable national regulations.
- ⚠ Before accessing the terminals, all the power circuits must be disconnected from the power supply.

## SAFETY RULES AND RECOMMENDATIONS FOR THE USER

- ⚠ Do not try to install the conditioner alone; always contact specialized technical personnel.
- ⚠ Cleaning and maintenance must be carried out by specialised technical personnel. In any case disconnect the appliance from the mains electricity supply before carrying out any cleaning or maintenance.
- ⚠ Ensure that the mains voltage corresponds to that stamped on the rating plate. Keep the switch or power plug clean. Insert the power plug correctly and firmly into the socket, thereby avoiding the risk of electric shock or fire due to insufficient contact.
- ⚠ Do not pull out the plug to switch off the appliance when it is in operation, since this could create a spark and cause a fire, etc.

- ⚠ Never remain directly exposed to the flow of cold air for a long time. The direct and prolonged exposition to cold air could be dangerous for your health. Particular care should be taken in the rooms where there are children, old or sick people.
- ⚠ If the appliance gives off smoke or there is a smell of burning, immediately cut off the power supply and contact the Service Centre.
- ⚠ The prolonged use of the device in such conditions could cause fire or electrocution.
- ⚠ Have repairs carried out only by an authorised Service Centre of the manufacturer. Incorrect repair could expose the user to the risk of electric shock, etc.

## SAFETY RULES AND RECOMMENDATIONS FOR THE USER

- ⚠ This appliance has been made for air conditioning domestic environments and must not be used for any other purpose, such as for drying clothes, cooling food, etc.
- ⚠ The packaging materials are recyclable and should be disposed of in the separate waste bins. Take the air conditioner at the end of its useful life to a special waste collection centre for disposal.
- ⚠ Always use the appliance with the air filter mounted. The use of the conditioner without air filter could cause an excessive accumulation of dust or waste on the inner parts of the device with possible subsequent failures.
- ⚠ The user is responsible for having the appliance installed by a qualified technician, who must check that it is earthed in accordance with current legislation and insert a thermomagnetic circuit breaker.

- ⚠ Unhook the automatic switch if you foresee not to use the device for a long time.  
The airflow direction must be properly adjusted.
- ⚠ The flaps must be directed downwards in the heating mode and upwards in the cooling mode.
- ⚠ Only use the air conditioner as instructed in this booklet. These instructions are not intended to cover every possible condition and situation. As with any electrical household appliance, common sense and caution are therefore always recommended for installation, operation and maintenance.
- ⚠ Ensure that the appliance is disconnected from the power supply when it will remain inoperative for a long period and before carrying out any cleaning or maintenance.
- ⚠ Selecting the most suitable temperature can prevent damage to the appliance.

## SAFETY RULES AND PROHIBITIONS

- ⊘ Do not bend, tug or compress the power cord since this could damage it. Electrical shocks or fire are probably due to a damaged power cord. Specialised technical personnel only must replace a damaged power cord.
- ⊘ Do not use extensions or gang modules.
- ⊘ Do not touch the appliance when barefoot or parts of the body are wet or damp.
- ⊘ Do not obstruct the air inlet or outlet of the indoor or the outdoor unit.  
The obstruction of these openings causes a reduction in the operative efficiency of the conditioner with possible consequent failures or damages.
- ⊘ In no way alter the characteristics of the appliance.
- ⊘ Do not install the appliance in environments where the air could contain gas, oil or sulphur or near sources of heat.
- ⊘ This appliance is not intended for use by persons (including children) with reduced physical, sensory or mental capabilities, or lack of experience and knowledge, unless they have been given supervision or instruction concerning use of the appliance by a person responsible for their safety.

- ⊘ Do not climb onto or place any heavy or hot objects on top of the appliance.
- ⊘ Do not leave windows or doors open for long when the air conditioner is operating.
- ⊘ Do not direct the airflow onto plants or animals.
- ⊘ A long direct exposition to the flow of cold air of the conditioner could have negative effects on plants and animals.
- ⊘ Do not put the conditioner in contact with water.  
The electrical insulation could be damaged and thus causing electrocution.
- ⊘ Do not climb onto or place any objects on the outdoor unit
- ⊘ Never insert a stick or similar object into the appliance. It could cause injury.
- ⊘ Children should be supervised to ensure that they do not play with the appliance. If the supply cord is damaged, it must be replaced by the manufacturer, its service agent or similarly qualified persons in order to avoid a hazard.

# NAMES OF THE PARTS

## INDOOR UNIT

No.	Description
1	Front panel
2	Air filter
3	Optional filter (if installed)
4	LED Display
5	Signal receiver
6	Terminal block cover
7	Ionizer generator(if installed)
8	Deflectors
9	Emergency button
10	Indoor unit rating label
11	Airflow direction flaps
12	Remote control

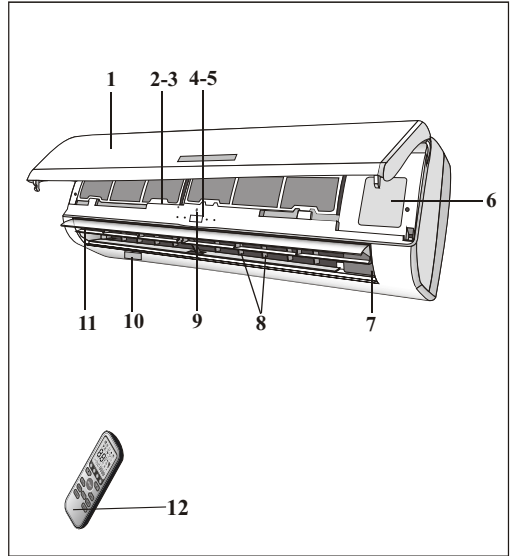

## OUTDOOR UNIT

No.	Description
13	Air outlet grille
14	Outdoor unit rating label
15	Cover
16	gas valve
17	liquid valve

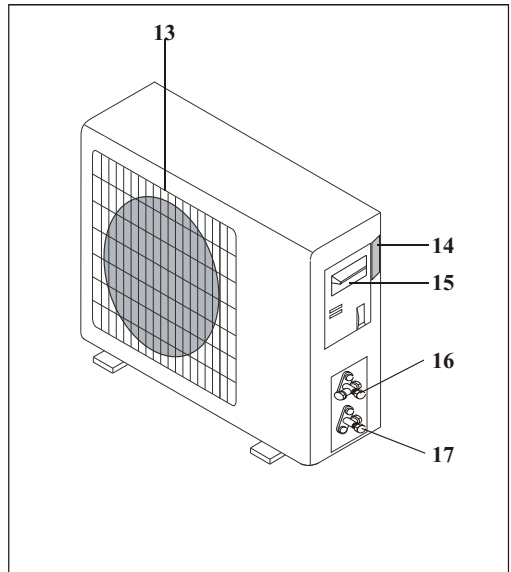

## WALL AIR-CONDITIONER

- The conditioner is made up of two or more units connected between themselves through copper pipes (properly insulated) and an electrical connecting cable.
- The indoor unit is installed on the walls of the room to be conditioned.
- The outdoor unit is installed on the floor or on the wall on suitable brackets.
- Technical data of the air conditioner are printed on the labels placed on the indoor and outdoor units.
- The remote control has been designed for an easy and fast use.

*Note: the above figures are only intended to be a simple diagram of the appliance and may not correspond to the appearance of the units that have been purchased.*

# INDOOR UNIT DISPLAY

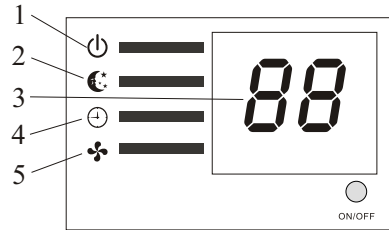
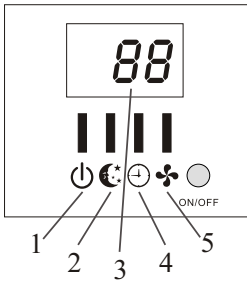
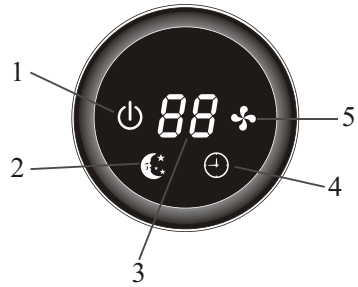
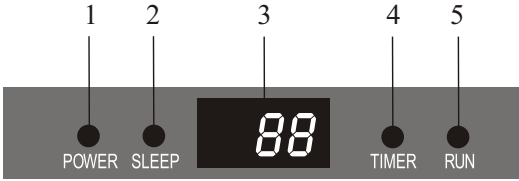

No.	Led		Function
1	POWER	⏻	Shows that the unit is powered
2	SLEEP	☾	SLEEP mode
3	Temperature display (if present)	88	Indicates the set temperature in °C or ° F
4	TIMER	⊕	TIMER mode
5	RUN	⋄	Unit working

⚠ *The shape and position of switches and indicators may vary according to the model, but their function is the same.*

# EMERGENCY FUNCTION & AUTO-RESTART FUNCTION

## AUTO-RESTART FUNCTION

The appliance is preset auto-restart function by manufacturer. With this function the air conditioner can keep the selected settings after a blackout or a voltage drop.

To deactivate the AUTO-RESTART function, proceed as follows:

1. Switch the air conditioner off and plug it off.
  2. Press the emergency button meanwhile plug it in.
  3. Keep pressing the emergency button for more than 10 seconds until you hear four short beeps from the unit. The AUTO-RESTART function is off.
- To activate the AUTO-RESTART function, follow the same procedure until you hear three short beeps from the unit.

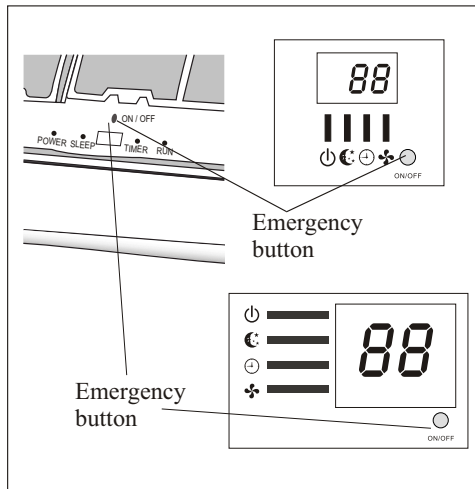



## EMERGENCY FUNCTION

If the remote control is lost, proceed as follows:

Lift the unit's front panel to reach the emergency button of the air conditioner

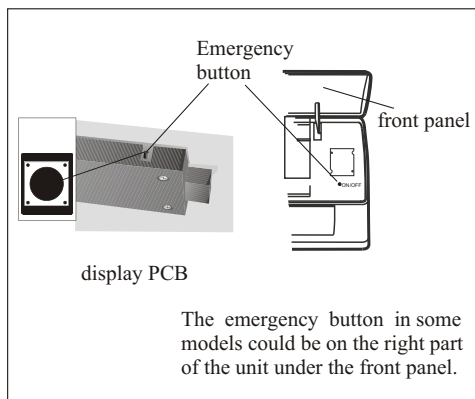
1. If you press the button once (one beep), the air conditioner will work in forced cooling function;
2. If you press the button twice (two beeps), the unit will work in forced heating function.
3. To switch off the unit, you just need to press the button again (a single long beep). After 30 minutes in forced function, the air conditioner will automatically start working in FEEL mode. The FEEL function is described in page 13.



 *The shape and position of the emergency button may vary according to the model, but their function is the same.*

Remark: the external static pressure of heat pumps is 0 Pa for all models.

# REMOTE CONTROL

No.	Button	Function
1	▲ (TEMP UP)	Increase the temperature or time by 1 unit
2	▼ (TEMP DN)	Decrease the temperature or time by 1 unit
3	ON/OFF	To switch the conditioner on and off.
4	FAN	To select the fan speed of auto/low/mid/high
5	TIMER	To set automatic switching-on/off
6	SLEEP	To activate the function "SLEEP"
7	ECO	In cooling mode, press this button, the temperature will increase 2°C on the base of setting temperature In heating mode, press this button, the temperature will decrease 2°C on the base of setting temperature
8	MODE	To select the mode of operation
9	SUPER	In cooling mode, press this button, the unit will give the maximum cooling temperature with 16°C In heating mode, press this button, the unit will give the maximum heating temperature with 31°C
10	SWING	To activate or deactivate of the movement of the "DEFLECTORS"
11	CLOCK	When you press this button, the time will be flickering; then through "▲" and "▼", you can adjust the time (one time you press, one minute you adjust; and if you continue to press, the time change rapidly), after adjusting to your required time, please press this button again to fix the time.
12	DISPLAY	To switch on/off the LED display (if present)
13	HEALTHY	To switch - on /off HEALTHY function. It is a button which controls the ionizer or plasma generator only for inverter type.
14	3D	This button is useless for wall-mounted type. When you press "3D", the horizontal and vertical vanes will swing together at the same time.
15	RESET	To restart REMOTE CONTROL
16	ANTI-MILDEW	To activate the function ANTI-MILDEW

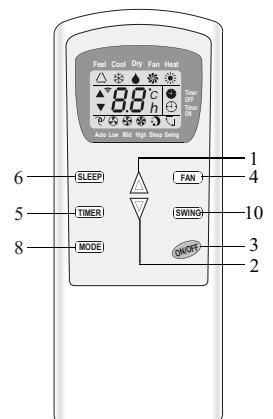
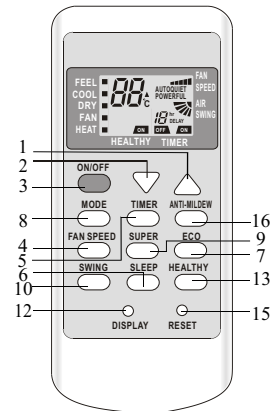
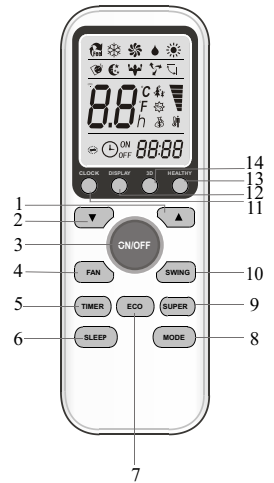

⚠ The outlook and some function of remote control may vary according to the model.

⚠ The shape and position of buttons and indicators may vary according to the model, but their function is the same.





































⚠ The unit confirms the correct reception of each press button with a beep.



# REMOTE CONTROL

## Remote control DISPLAY

### Meaning of symbols on the liquid crystal display

No.	Symbols	Meaning
1	 or 	FEEL mode indicator
2		COOLING indicator
3		DEHUMIDIFYING indicator
4		FAN ONLY OPERATION indicator
5		HEATING indicator
6	 or 	SIGNAL RECEPTION indicator
7	 or <b>TIMER OFF</b> or 	TIMER OFF indicator
8	 or <b>TIMER ON</b> or 	TIMER ON indicator
9	 or  or  or <b>(FLASH)</b>	AUTO FAN indicator
10	 or  or 	LOW FAN SPEED indicator
11	 or  or 	MIDDLE FAN SPEED indicator
12	 or  or 	HIGH FAN SPEED indicator
13	<b>QUIET</b> or  or 	SLEEP indicator
14		COMFORTABLE SLEEP indicator (optional)
15		I FEEL indicator(optional)
16	 or 	FLAP SWING indicator
17		FLAP and Deflectors SWING indicator
18	 or <b>POWERFUL</b>	SUPER indicator
19	 or <b>HEALTHY ON</b>	HEALTHY indicator
20	 or <b>EC</b>	ECO indicator
21		ANTI-MILDEW indicator
22		BATTERY indicator
23	<b>88:88</b>	CLOCK indicator

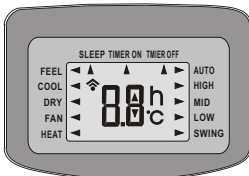
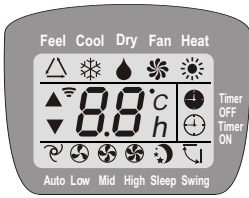

# REMOTE CONTROL

## Preliminary Instructions

### How to insert the batteries

Remove the cover from the battery compartment , by sliding it in the direction of the arrow

Insert the new batteries, ensuring that the (+) and (-) directions are correct

Refit the cover by sliding it into place.

⚠ Use 2 LRO 3 AAA (1.5V) batteries . Do not use rechargeable batteries . Replace the old batteries with new ones of the same type when the display is no longer legible.

The remote control batteries must be disposed of in accordance with the applicable laws in force in the country of use.

⚠ Refer to picture 1:

- i. When you insert the batteries for the first time in the remote control or if you change them, you will see a DIP switch under the back cover.

DIP switch on position	Function
°C	The display is adjusted in degree celsius
°F	The display is adjusted in degree fahrenheit.
Cool	The remote control is adjusted in only cooling mode
Heat	The remote control is adjusted in only heating mode

- ii. BE CAREFUL: After adjusting the function, you need to take out the batteries and repeat again the procedure described above.

⚠ Refer to picture 2:

When you insert the batteries for the first time in the remote control or if you change them, you need to program the remote control of only cooling or heat pump air conditioners.

This is very easy: as soon as you insert the batteries, the symbols ❄ (COOL ■) and ☀ (HEAT ■) start flashing. If you push whatever button when the symbol ❄ (COOL ■) is displayed, the remote control is adjusted in only cooling mode . If you push whatever button when the symbol ☀ (HEAT ■) is displayed , the remote control is adjusted in heating mode.

⚠ BE CAREFUL: if you adjust the remote control in cooling mode, it will not be possible to activate the heating function in units with heating pump . you need to take out the batteries and repeat again the procedure described above.

1. Direct the remote control toward the conditioner.
2. Check that there are no objects between the remote control and the receiver on the conditioner.
3. Never leave the remote control exposed to the rays of the sun.
4. Keep the remote control at a distance of at least 1m from the television or other electrical appliances.

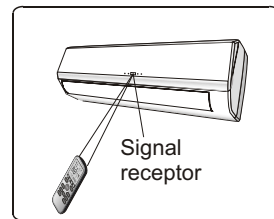
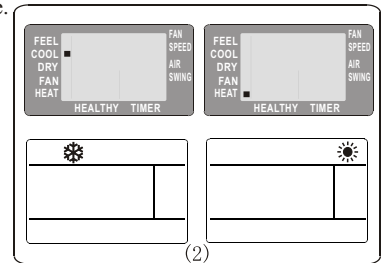
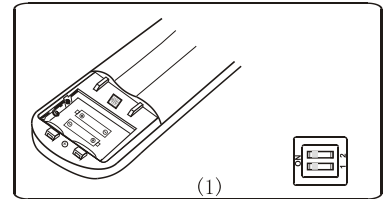
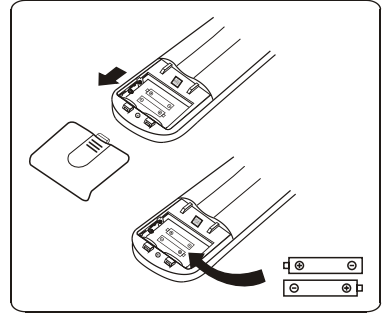

Recommendations for locating and using the remote control (if present)  
The remote control may be kept in a wall-mounted holder

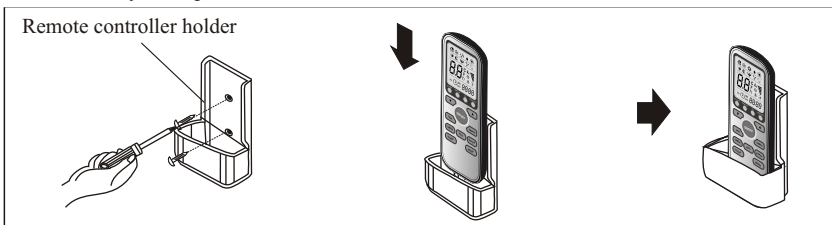

# MODES OF OPERATION

The conditioner is designed to create the comfortable climatic conditions for the people in the room.

It can cool and dehumidify (and heat in models with heat pump) the air in a completely automatic way.

The air sucked by the fan enters from the grill of the front panel and passes through the filter, which keeps the dust. Then it is conveyed through the heat exchanger and cooled and dehumidified or heated through the heat exchanger.

The heat removed from the room is drained outside.

When the cycle has finished the fan gives back the fresh air in the room; the direction of the air outlet is regulated by the flaps, which are motorized up and down, and manually moved right and left by the vertical deflectors.

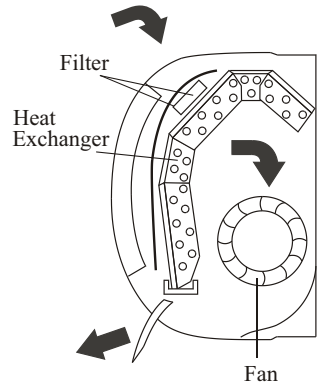

## “SWING” CONTROL OF THE AIR FLOW



- The air outlet flow is uniformly distributed in the room.
- It is possible to position the direction of the air in the optimal solution.

The key **[SWING]** activates the “FLAP”, the air flow is directed alternatively from up to down.

In order to guarantee an even diffusion of the air in the room.

- In cooling mode, orient the flaps in horizontal direction;
- In heating mode, orient the flaps downward as the warm air always tends to rise upward.

The deflectors are positioned manually and placed under the flaps. They allow to direct the air flow rightward or leftward.

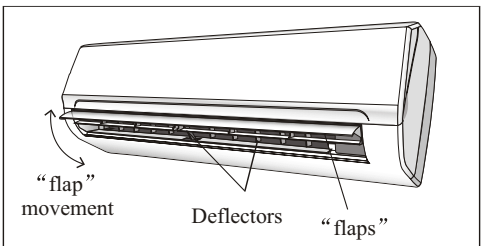
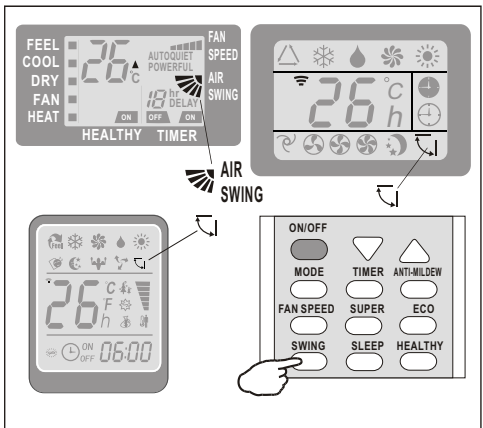

**⚠** This adjustment must be done with the appliance switched off.

### CAUTION!

Never position “Flaps” manually, the delicate mechanism activating them could be seriously damaged!

### DANGER!

Never insert your hand or objects in the air outlet of the units! These units contain a fan that turns at high speed.

# MODES OF OPERATION

## COOLING MODE

**COOL ■** The cooling function allows the air conditioner to cool the room and at the same time reduces the humidity in the air.

To activate the cooling function ( COOL ), press the **MODE** button until the symbol ❄️ ( COOL ■ ) appears on the display.

The cooling cycle is activated by setting the keys ▲ or ▼ at a temperature lower than that of the room.

To optimize the functioning of the conditioner, adjust the temperature ( 1 ), the speed ( 2 ) and the direction of the air flow ( 3 ) by pressing the keys indicated

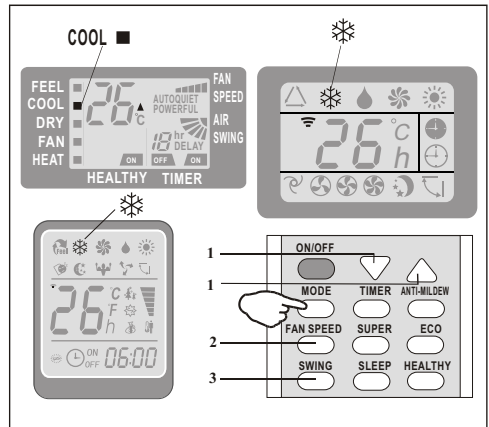

## HEATING MODE

**HEAT ■** The heating function allows the air conditioner to produce hot air.

To activate the heating function ( HEAT ), press the **MODE** button until the symbol ☀️ ( HEAT ■ ) appears on the display.

With the keys ▲ or ▼ set a temperature higher than that of the room..

To optimize the functioning of the conditioner adjust the temperature ( 1 ), the speed ( 2 ) and the direction of the air flow ( 3 ) by pressing the keys indicated

⚠️ The appliance is fitted with a Hot Start function, which delays appliance to startup in a few seconds to ensure an immediate output of hot air.

⚠️ In HEATING operation, the appliance can automatically activate a defrost cycle, which is essential to free the condenser from an excessive deposit of frost. This procedure usually lasts for 2-10 minutes during defrosting, fans stop operation. After defrosting, it returns to HEATING mode automatically.

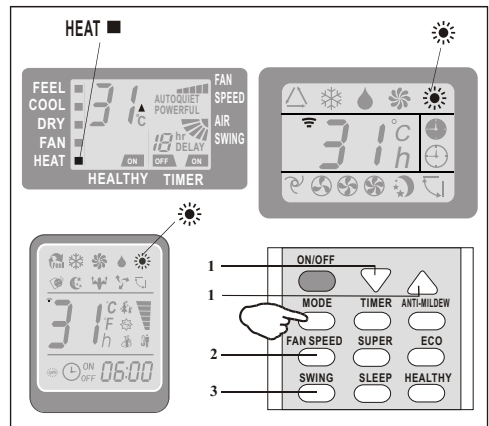

# MODES OF OPERATION

## TIMER MODE----TIMER ON



To set the automatic switching-on of the air conditioner

To program the time start, the appliance should be off. Press **TIMER**, Set the temperature with pressing the key ▲ or ▼. Press **TIMER** Again, set the time with pressing the key ▲ or ▼, Press the key more times till on the display you can read the time which passes between the programming and the timed start.

### IMPORTANT!

Before proceeding with the timed start : program the working mode with the key **MODE** (2) and the fan speed with the key **FAN** (3) . Switch the conditioner off (with the key **ON/OFF** ).

Note: To cancel the setted function ,press the **TIMER** button again.

Note: In case of power off, it is necessary to set **TIMER ON** again

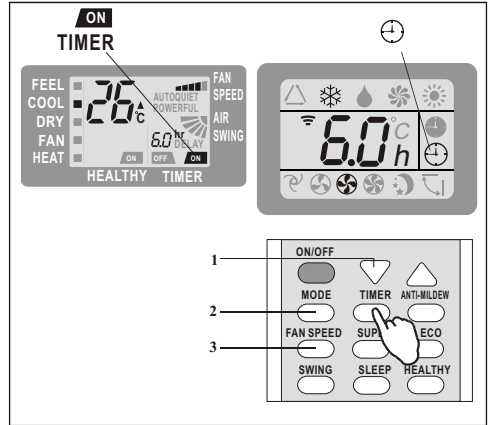

Indoor display

## TIMER MODE----TIMER OFF



To set the automatic switching-off of the air conditioner

The timed stop is programmed with the appliance on. Press **TIMER**, Set the time pressing the key ▲ or ▼, Press the key more times till on the display you can read the time which passes between the programming and the timed stop.

Note: To cancel the setted function, press the **TIMER** button again.

Note: In case of power off, it is necessary to set **TIMER OFF** again

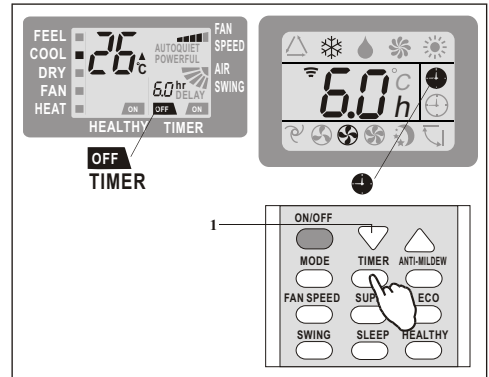

Indoor display

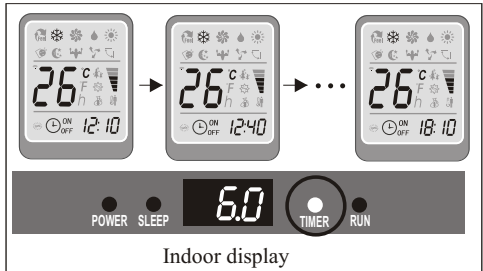

Indoor display

⚠ Note: While the time was right settled, the **TIMER** function of this remote (clock function) can set by half hours

# MODES OF OPERATION

## FAN MODE



The conditioner works in only ventilation.

To set the FAN mode, Press **MODE** until  ( **FAN ■** ) appears in the display.

With pressing **FAN** button the speed changes in the following sequence: LOW/ MEDIUM/HIGH /AUTO in FAN mode.

The remote control also stores the speed that was set in the previous mode of operation.

In FEEL mode (automatic) the air conditioner automatically chooses the fan speed and the mode of operation (COOLING or HEATING).

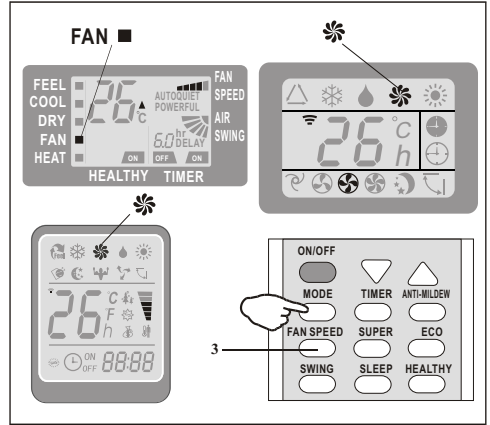

## DRY MODE



This function reduces the humidity of the air to make the room more comfortable.

To set the DRY mode, Press **MODE** until  ( **DRY ■** ) appears in the display. An automatic function of alternating cooling cycles and air fan is activated.

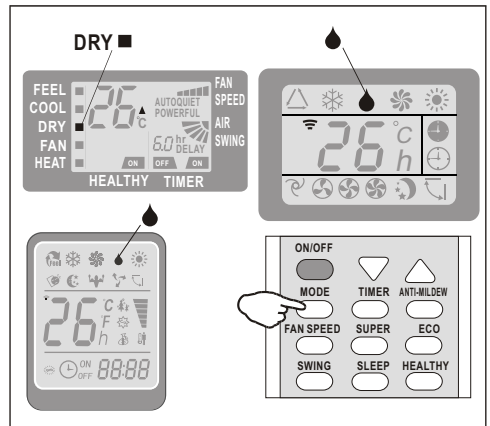

# MODES OF OPERATION

## FEEL MODE



Automatic mode.

To activate the FEEL (automatic) mode of operation, press the **[MODE]** button on the remote control until the symbol  $\Delta$  (FEEL  $\blacksquare$ ) appears in the display.

In the FEEL mode the fan speed and the temperature are set automatically according to the room temperature (tested by the probe which is incorporated in the indoor unit) to ensure user comfort.

Ambient temp	Operation mode	Auto temp.
< 20°C	HEATING (FOR HEAT PUMP TYPE) FAN (FOR COOL ONLY TYPE)	23°C
20°C~26°C	DRY	18°C
> 26°C	COOL	23°C

To optimize the working of the conditioner, adjust the temperature (only  $\pm 2^\circ\text{C}$ ) (1), the speed (2) and the direction of the air flow (3) by pressing the buttons indicated

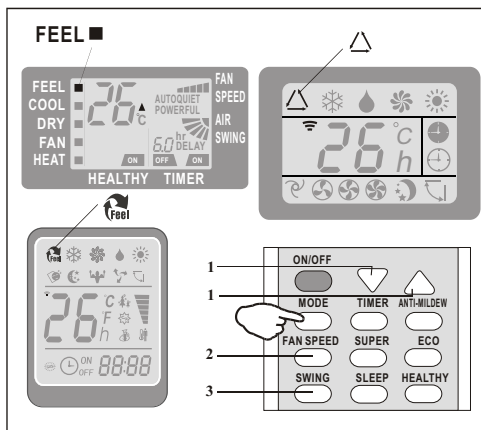

## SLEEP MODE



To activate the SLEEP mode of operation, press the **[SLEEP]** button on the remote control until the symbol  $\text{☾}$  (AUTOQUIET) appears in the display.

The function "SLEEP" automatically adjusts the temperature to make the room more comfortable during the night sleep. In cooling or dry mode, the set temperature will automatically raise by  $1^\circ\text{C}$  every 60 minutes, to achieve a total rise of  $2^\circ\text{C}$  during the first 2 hours of work.

In heating mode the set temperature is gradually decreased by  $2^\circ\text{C}$  during the first 2 hours of work.

After 10 hours running in sleep mode the air conditioner is switched off automatically.

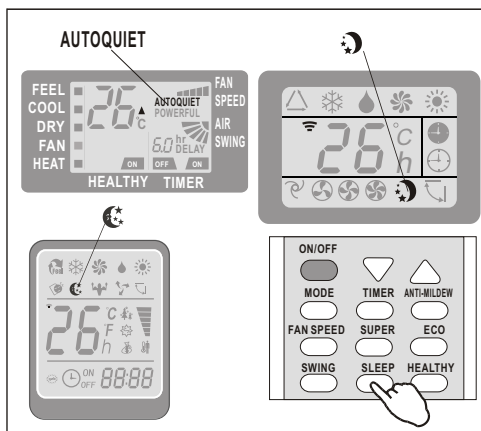

Indoor display

# PROTECTION

The protective device maybe trip and stop the appliance in the cases listed below.

## For T1 Climate condition models:

No.	MODEL	
1	Heating	Outdoor air temperature is over 24°C
		Outdoor air temperature is below -7°C
		Room temperature is over 27°C
2	Cooling	Outdoor air temperature is over 43°C
		Room temperature is below 21 °C
3	Dry	Room temperature is below 18° C

## For Tropical (T3) Climate condition models:

No.	MODEL	
1	Heating	Outdoor air temperature is over 24°C
		Outdoor air temperature is below -7°C
		Room temperature is over 27°C
2	Cooling	Outdoor air temperature is over 52°C
		Room temperature is below 21 °C
3	Dry	Room temperature is below 18° C

 After stopping and restarting the air conditioner or after changing the mode during operation, the system does not restart immediately, Until after 3 minutes(Protection function for the compressor)



# INSTALLATION MANUAL---Selecting the Installation Place

## INDOOR UNIT

- Install the indoor unit level on a strong wall that is not subject to vibrations.
- The inlet and outlet ports should not be obstructed: the air should be able to blow all over the room.
- Do not install the unit near a source of heat, steam, or flammable gas.
- Install the unit near an electric socket or private circuit.
- Do not install the unit where it will be exposed to direct sunlight.
- Install the unit where connection between indoor and outdoor unit is as easy as possible.
- Install the unit where it is easy to drain the condensed water.
- Check the machine operation regularly and leave the necessary spaces as shown in the picture.
- Install the indoor unit where the filter can be easily accessible.

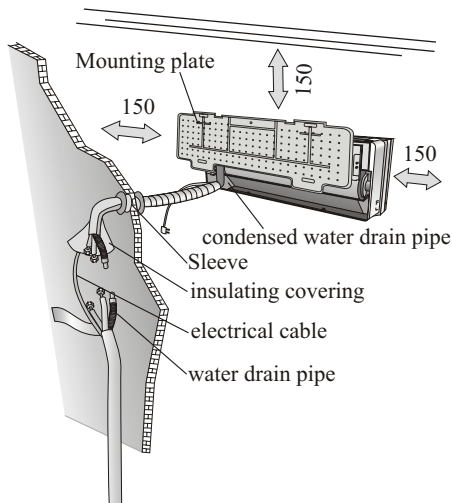

minimum space to be left (mm) showing in the picture

## OUTDOOR UNIT

- Do not install the outdoor unit near sources of heat, steam or flammable gas.
- Do not install the unit in too windy or dusty places.
- Do not install the unit where people often pass. Select a place where the air discharge and operating sound level will not disturb the neighbours.
- Avoid installing the unit where it will be exposed to direct sunlight (otherwise use a protection, if necessary, that should not interfere with the air flow).
- Leave the spaces as shown in the picture for the air to circulate freely.
- Install the outdoor unit in a safe and solid place.
- If the outdoor unit is subject to vibration, place rubber gaskets onto the feet of the unit.

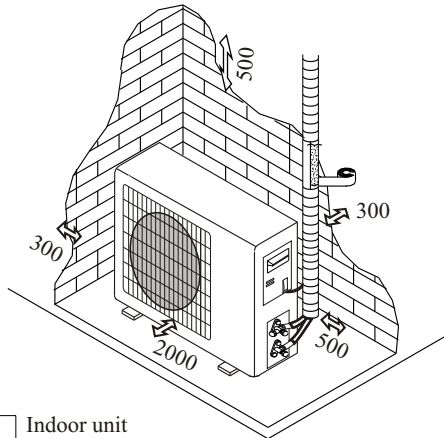

### Installation Diagram

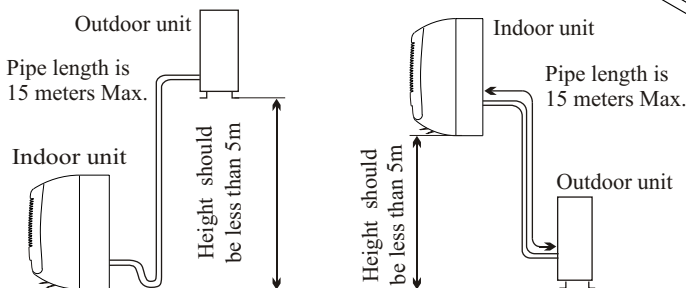

Only persons and/or companies qualified and experienced in the installation, service and repair of refrigerant products should be permitted to do so. The purchaser must ensure that the person and/or company who is to install, service or repair this air conditioner has qualifications and experience in refrigerant products.

# INSTALLATION MANUAL---Installation of the Indoor unit

Before starting installation, decide on the position of the indoor and outdoor units, taking into account the minimum space required around the units

⚠ Install the indoor unit in the room to be air conditioning, avoiding to install in corridors or communal areas.

⚠ Install the indoor unit at a height of at least 2.5 m from the ground.

**To install, proceed as follows:**

## Installation of the mounting plate

1. By using a level, put the mounting plate in a perfect square position vertically and horizontally.
2. Drill 32 mm deep holes in the wall to fix the plate;
3. Insert the plastic anchors into the hole;
4. Fix the mounting plate by using the provided tapping screws
5. Check that the mounting plate is correctly fixed;

*Note : The shape of the mounting plate may be different from the one above, but installation method is similar .*

## Drilling a hole in the wall for the piping

1. Decide where to drill the hole in the wall for the piping ( if necessary ) according to the position of the mounting plate;
2. Install a flexible flange through the hole in the wall to keep the latter intact and clean.

⚠ The hole must slope downwards towards the exterior

*Note : Keep the drain pipe down towards the direction of the wall hole, otherwise leakage may occur.*

## Electrical connections---Indoor unit

1. Lift the front panel.
2. Take off the cover as indicated in the picture ( by removing a screw or by breaking the hooks).
3. For the electrical connections, see the circuit diagram on the right part of the unit under the front panel.
4. Connect the cable wires to the screw terminals by following the numbering ,Use wire size suitable to the electric power input (see name plate on the unit) and according to all current national safety code requirements.
5. The cable connecting the outdoor and indoor units must be suitable for outdoor use.
6. The plug must be accessible also after the appliance has been installed so that it can be pulled out if necessary.
7. An efficient earth connection must be ensured.
8. If the power cable is damaged, it must be replaced by an authorised Service Centre.

*Note: The cable wires has been connected to the main PCB of indoor unit by manufacturer according to the model without terminal block*

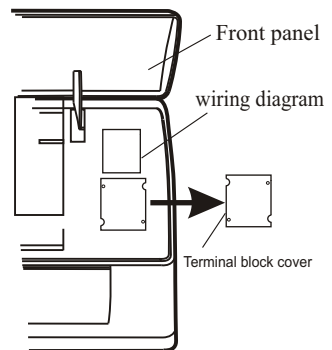
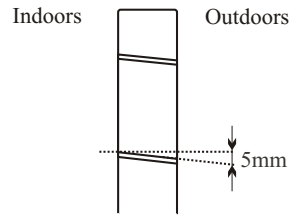
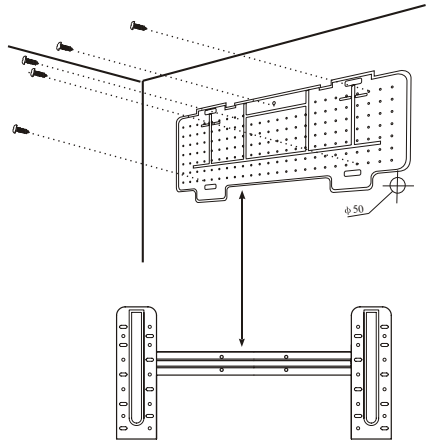

# INSTALLATION MANUAL---Installation of the Indoor unit

## Refrigerant piping connection

The piping can be run in the 3 directions indicated by numbers in the picture . When the piping is run in direction 1 or 3, cut a notch along the groove on the side of the indoor unit with a cutter.

Run the piping in the direction of the wall hole and bind the copper pipes , the drain pipe and the power cables together with the tape with the drain pipe at the bottom, so that water can flow freely.

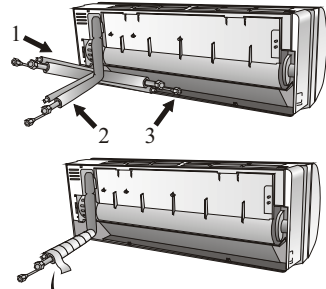

Shape the connection pipe

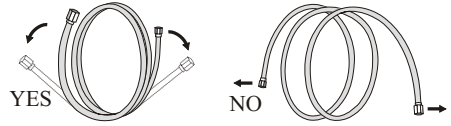

Extending the rolled pipe

## Connections to the indoor unit

1. Remove the indoor unit pipe cap (check that there is no debris inside).
2. Insert the flare nut and create a flange at the extreme end of the connection pipe.
3. Tighten the connections by using two wrenches working in opposite directions

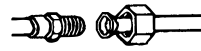

torque wrench

## Indoor unit condensed water drainage

The indoor unit condensed water drainage is fundamental for the success of the installation.

1. Place the drain hose below the piping, taking care not to create siphons.
2. The drain hose must slant downwards to aid drainage.
3. Do not bend the drain hose or leave it protruding or twisted and do not put the end of it in water . If an extension is connected to the drain hose , ensure that it is lagged when it passes into the indoor unit.
4. If the piping is installed to the right, the pipes, power cable and drain hose must be lagged and secured onto the rear of the unit with a pipe connection.
  - 1) Insert the pipe connection into the relative slot.
  - 2) Press to join the pipe connection to the base.

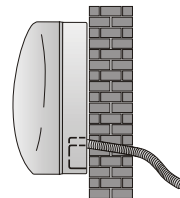

YES

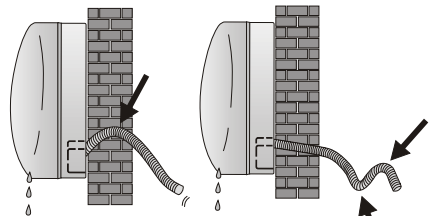

NO

NO

# INSTALLATION MANUAL---Installation of the Indoor unit

## INSTALLATION OF THE INDOOR UNIT

After having connected the pipe according to the instructions, install the connection cables. Now install the drain pipe. After connection, lag the pipe, cables and drain pipe with the insulating material.

1. Arrange the pipes ,cables and drain hose well.
2. Lag the pipe joints with insulating material , securing it with vinyl tape.
3. Run the bound pipe , Cables and drain pipe through the wall hole and mount the indoor unit onto the upper part of the mounting plate securely.
4. Press and push the lower part of the indoor unit tightly against the mounting plate

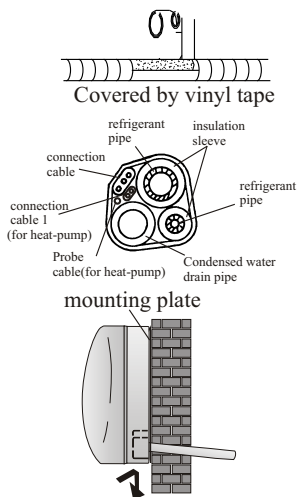

# INSTALLATION MANUAL---Installation of the outdoor unit

- The outdoor unit should be installed on a solid wall and fastened securely.
- The following procedure must be observed before connecting the pipes and connecting cables : decide which is the best position on the wall and leave enough space to be able to carry out maintenance easily.
- Fasten the support to the wall using screw anchors which are particularly suited to the type of wall;
- Use a larger quantity of screw anchors than normally required for the weight they have to bear to avoid vibration during operation and remain fastened in the same position for years without the screws becoming loose.
- The unit must be installed following the national regulations.

## Outdoor unit condensed water drainage (only for heat pump models)

The condensed water and the ice formed in the outdoor unit during heating operation can be drained away through the drain pipe

1. Fasten the drain port in the 25mm hole placed in the part of the unit as shown in the picture.
2. Connect the drain port and the drain pipe.  
Pay attention that water is drained in a suitable place.

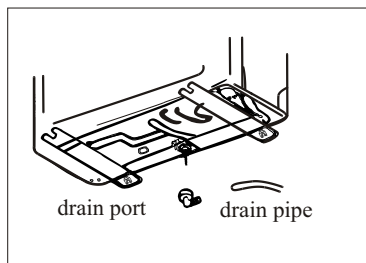

# INSTALLATION MANUAL---Installation of the outdoor unit

## ELECTRICAL CONNECTIONS

1. Take the cover away.
2. Connect the cable wires to the terminal board using the same numbering as in the indoor unit.
3. For the electrical connections, see the wiring diagram on the back of the cover
4. Fasten the cables with a cable-clamp.
5. An efficient earth connection must be ensured.
6. Replace the covers .

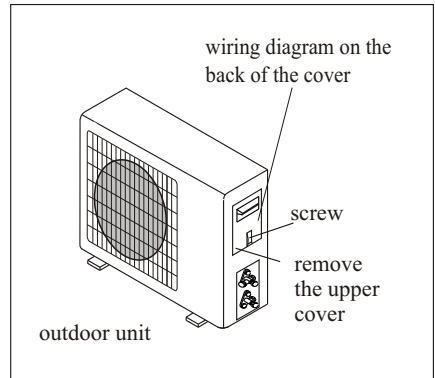

## CONNECTING THE PIPES

Screw the flare nuts to the outdoor unit coupling with the same tightening procedures described for the indoor unit.

To avoid leakage, pay attention to the following points:

1. Tighten the flare nuts using two wrenches. Pay attention not to damage the pipes.
2. If the tightening torque is not sufficient, there will probably be some leakage. With excessive tightening torque there will also be some leakage, as the flange could be damaged.
3. The surest system consists in tightening the connection by using a fix wrench and a torque wrench: in this case use the table on page 21.

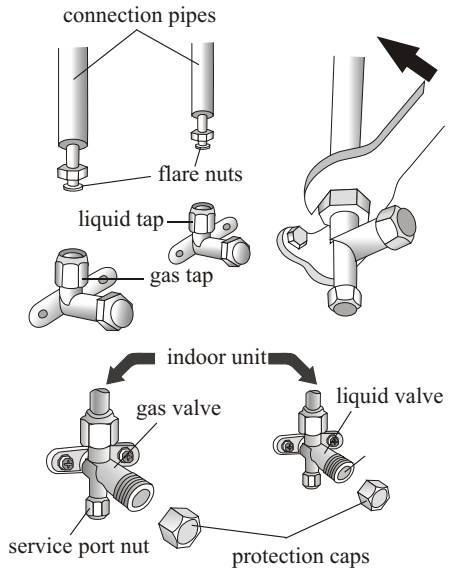

## BLEEDING

Air and humidity left inside the refrigerant circuit can cause compressor malfunction. After having connected the indoor and outdoor units, bleed the air and humidity from the refrigerant circuit by using a vacuum pump.

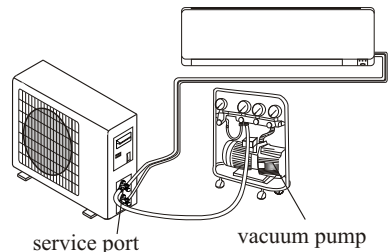

# INSTALLATION MANUAL---Installation of the outdoor unit

## BLEEDING

The air and humidity left inside the refrigerant circulation can cause compressor malfunction. After having connected the indoor and outdoor units, bleed the air and humidity from the refrigerant circulation using a vacuum pump.

- (1) Unscrew and remove the caps from the 2 - way and 3-way valves.
- (2) Unscrew and remove the cap from the service port.
- (3) Connect the vacuum pump hose to the service port.
- (4) Operate the vacuum pump for 10 - 15 minutes until an absolute vacuum of 10 mm Hg has been reached.
- (5) With the vacuum pump still in operation, close the low - pressure knob on the vacuum pump coupling. Stop the vacuum pump.
- (6) Open the 2 - way valve by 1/4 turn and then close it after 10 seconds. Check all the joints for leaks using liquid soap or an electronic leak device.
- (7) Turn the body of the 2-way and 3-way valves. Disconnect the vacuum pump hose.
- (8) Replace and tighten all the caps on the valves.

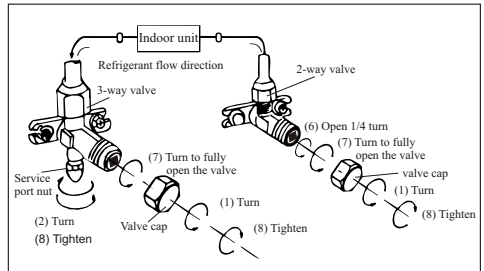
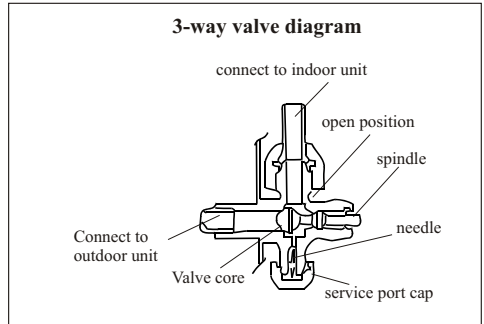

## INSTALLATION MANUAL--- final stages

1. Wind insulating covering around the joints of the indoor unit and fix it with insulating tape.
2. Fix the exceeding part of the signal cable to the piping or to the outdoor unit.
3. Fix the piping to the wall ( after having coated it with insulating tape) using clamps or insert them into plastic slots.
4. Seal the hole in the wall through which the piping is passed so that no air or water can fill.

### Indoor unit test

- Do the ON/OFF and FAN operate normally?
- Does the MODE operate normally?
- Do the set point and TIMER function properly?
- Does each lamp light normally?
- Do the flap for air flow direction operate normally?
- Is the condensed water drained regularly?

### Outdoor unit test

- Is there any abnormal noise or vibration during operation?
- Could the noise, the air flow or the condensed water drainage disturb the neighbours?
- Is there any coolant leakage?

*Note: the electronic controller allows the compressor to start only three minutes after voltage has reached the system.*

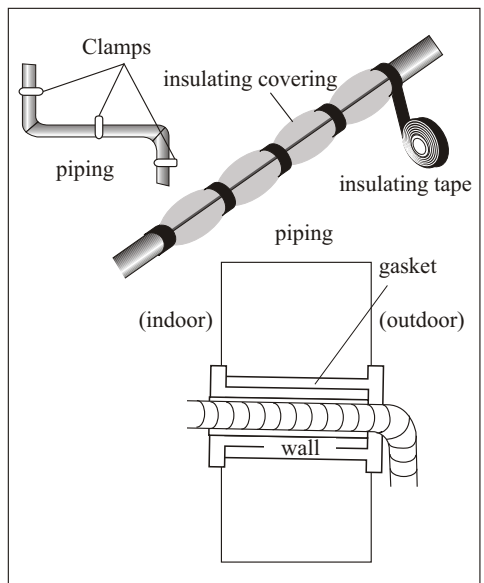

# INSTALLATION MANUAL---Information for the installer

<b>FIXED-SPEED TYPE MODEL capacity (Btu/h)</b>	<b>5k</b>	<b>7k</b>	<b>9k</b>	<b>12k</b>	<b>15/18k</b>	<b>22/24k</b>	<b>28/30k</b>
Liquid pipe diameter	1/4 " (φ6)	1/4 " (φ6)	1/4 " (φ6)	1/4 " (φ6)	1/4 " (φ6)	3/8 " (φ9.52)	3/8 " (φ9.52)
Gas pipe diameter	3/8 " (φ9.52)	3/8 " (φ9.52)	3/8 " (φ9.52)	1/2 " (φ12)	1/2 " (φ12)	5/8 " (φ15.88)	5/8 " (φ15.88)
Lenght of pipe with standard charge	3m	3m	3m	3m	4m	4m	4m
Maximum distance between indoor and outdoor unit	15m	15m	15m	15m	15m	15m	15m
Additional gas charge	20g/m	20g/m	20g/m	20g/m	30g/m	30g/m	30g/m
Max. diff. in level between indoor and outdoor unit	5m	5m	5m	5m	5m	5m	5m
Type of refrigerant(1)	R22	R22 R407C	R22 R407C	R22 R407C	R22 R407C	R22 R407C	R22 R407C

<b>FIXED-SPEED TYPE MODEL capacity (Btu/h)</b>	<b>7k</b>	<b>9k</b>	<b>12k</b>	<b>15/18k</b>	<b>22/24k</b>	<b>28/30k</b>
Liquid pipe diameter	1/4 " (φ6)	1/4 " (φ6)	1/4 " (φ6)	1/4 " (φ6)	3/8 " (φ9.52)	3/8 " (φ9.52)
Gas pipe diameter	3/8 " (φ9.52)	3/8 " (φ9.52)	3/8 " (φ9.52)	1/2 " (φ12)	5/8 " (φ15.88)	5/8 " (φ15.88)
Lenght of pipe with standard charge	3m	3m	3m	4m	4m	4m
Maximum distance between indoor and outdoor unit	15m	15m	15m	15m	15m	15m
Additional gas charge	20g/m	20g/m	20g/m	30g/m	30g/m	30g/m
Max. diff. in level between indoor and outdoor unit	5m	5m	5m	5m	5m	5m
Type of refrigerant(1)	R410A	R410A	R410A	R410A	R410A	R410A

<b>INVERTER TYPE MODEL capacity (Btu/h)</b>	<b>9k</b>	<b>12k</b>	<b>15/18k</b>	<b>22/24k</b>
Liquid pipe diameter	1/4 " (φ6)	1/4 " (φ6)	1/4 " (φ6)	3/8 " (φ9.52)
Gas pipe diameter	3/8 " (φ9.52)	1/2 " (φ12)	1/2 " (φ12)	5/8 " (φ15.88)
Lenght of pipe with standard charge	3m	3m	4m	4m
Maximum distance between indoor and outdoor unit	15m	15m	15m	15m
Additional gas charge	20g/m	20g/m	30g/m	30g/m
Max. diff. in level between indoor and outdoor unit	5m	5m	5m	5m
Type of refrigerant(1)	R22 R410A	R22 R410A	R22 R410A	R22 R410A

(1) Refer to the data rating label sticked on the outdoor unit.

## TIGHTENING TORQUE FOR PROTECTION CAPS AND FLANGE CONNECTION

<b>PIPE</b>	<b>TIGHTENING TORQUE [N x m]</b>	<b>CORRESPONDING STRESS (using a 20 cm wrench)</b>	<b>TIGHTENING TORQUE [N x m]</b>
1/4 " (φ6)	15 - 20	wrist strength	Service port nut 7 - 9
3/8 " (φ9.52)	31 - 35	arm strength	Protection caps 25 - 30
1/2 " (φ12)	35 - 45	arm strength	
5/8 " (φ15.88)	75 - 80	arm strength	

# INSTALLATION MANUAL---Information for the installer

## WIRING DIAGRAM

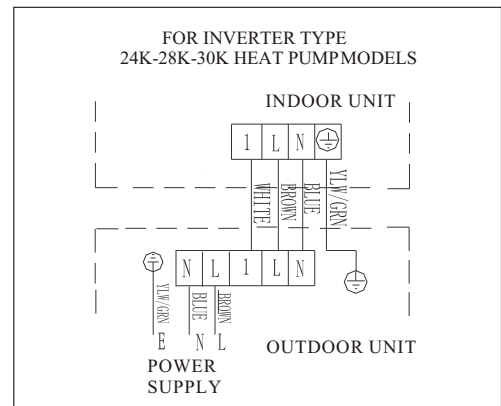
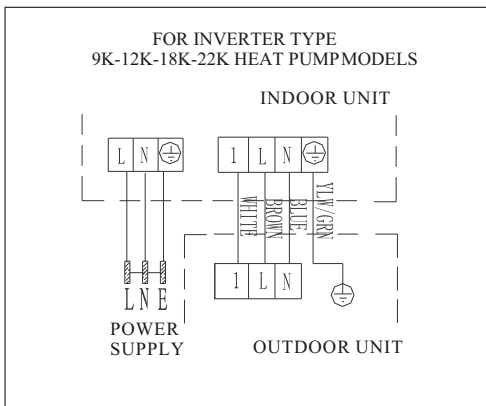
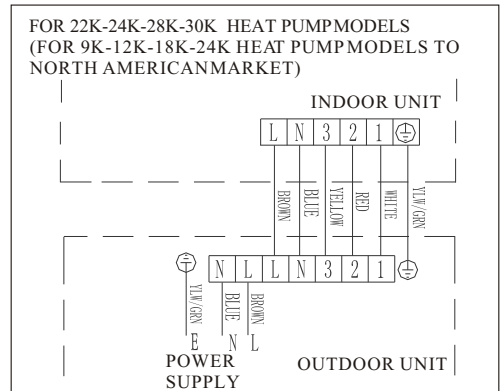
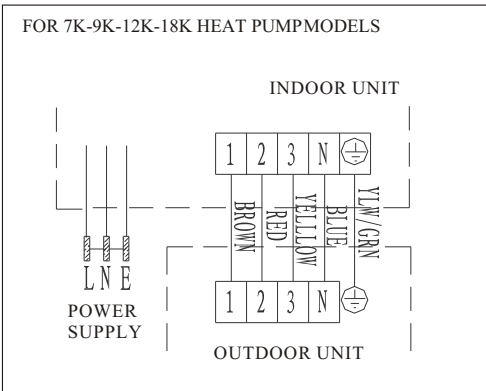
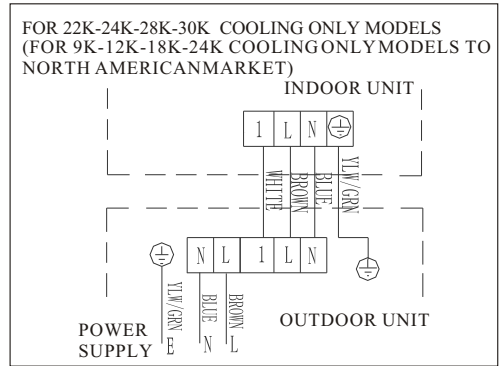
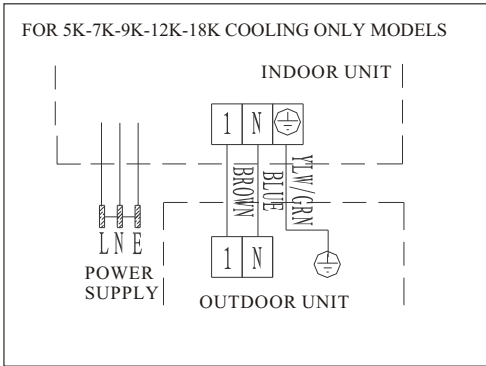

Please see the pasted diagram instruction on the unit first

Note: The cable wires has been connected to the main PCB of indoor unit by manufacturer according to the model without terminal block, see the wiring diagram on the right part of the unit under the front panel and the back of the outdoor cover



# INSTALLATION MANUAL---Information for the installer

## CABLE WIRES SPECIFICATION

MODEL capacity (Btu/h)		5k	7k	9k	12k	15/18k	22/24k	28/30k
		sectional area						
Power supply cable	N	1.0mm <sup>2</sup> AWG18	1.0mm <sup>2</sup> AWG18	1.0mm <sup>2</sup> AWG18	1.0mm <sup>2</sup> (1.5mm) AWG18 (AWG16)	1.5mm <sup>2</sup> AWG16	2.5mm <sup>2</sup> AWG14 H05RN-F	4.0mm <sup>2</sup> AWG12
	L	1.0mm <sup>2</sup> AWG18	1.0mm <sup>2</sup> AWG18	1.0mm <sup>2</sup> AWG18	1.0mm <sup>2</sup> (1.5mm) AWG18 (AWG16)	1.5mm <sup>2</sup> AWG16	2.5mm <sup>2</sup> AWG14 H05RN-F	4.0mm <sup>2</sup> AWG12
	E	1.0mm <sup>2</sup> AWG18	1.0mm <sup>2</sup> AWG18	1.0mm <sup>2</sup> AWG18	1.0mm <sup>2</sup> (1.5mm) AWG18 (AWG16)	1.5mm <sup>2</sup> AWG16	2.5mm <sup>2</sup> AWG14 H05RN-F	4.0mm <sup>2</sup> AWG12
Connection supply cable	N	1.0mm <sup>2</sup>	1.0mm <sup>2</sup>	1.0mm <sup>2</sup>	1.0mm <sup>2</sup> (1.5mm)	1.5mm <sup>2</sup>	0.75mm <sup>2</sup>	0.75mm <sup>2</sup>
	L	1.0mm <sup>2</sup>	1.0mm <sup>2</sup>	1.0mm <sup>2</sup>	1.0mm <sup>2</sup> (1.5mm)	1.5mm <sup>2</sup>	0.75mm <sup>2</sup>	0.75mm <sup>2</sup>
	1	1.0mm <sup>2</sup>	1.0mm <sup>2</sup>	1.0mm <sup>2</sup>	1.0mm <sup>2</sup> (1.5mm)	1.5mm <sup>2</sup>	0.75mm <sup>2</sup>	0.75mm <sup>2</sup>
	2	0.75mm <sup>2</sup>	0.75mm <sup>2</sup>	0.75mm <sup>2</sup>	0.75mm <sup>2</sup>	0.75mm <sup>2</sup>	0.75mm <sup>2</sup>	0.75mm <sup>2</sup>
	3	0.75mm <sup>2</sup>	0.75mm <sup>2</sup>	0.75mm <sup>2</sup>	0.75mm <sup>2</sup>	0.75mm <sup>2</sup>	0.75mm <sup>2</sup>	0.75mm <sup>2</sup>
	⊕	0.75mm <sup>2</sup>	0.75mm <sup>2</sup>	0.75mm <sup>2</sup>	0.75mm <sup>2</sup>	0.75mm <sup>2</sup>	0.75mm <sup>2</sup>	0.75mm <sup>2</sup>

INVERTER TYPE MODEL capacity (Btu/h)				9k	12k	18/22k	24k	
		sectional area						
Power supply cable	N			1.0mm <sup>2</sup> (1.5mm) AWG18 (AWG16)	1.0mm <sup>2</sup> (1.5mm) AWG18 (AWG16)	1.5mm <sup>2</sup> AWG16	2.5mm <sup>2</sup> AWG14	
	L			1.0mm <sup>2</sup> (1.5mm) AWG18 (AWG16)	1.0mm <sup>2</sup> (1.5mm) AWG18 (AWG16)	1.5mm <sup>2</sup> AWG16	2.5mm <sup>2</sup> AWG14	
	E			1.0mm <sup>2</sup> (1.5mm) AWG18 (AWG16)	1.0mm <sup>2</sup> (1.5mm) AWG18 (AWG16)	1.5mm <sup>2</sup> AWG16	2.5mm <sup>2</sup> AWG14	
Connection supply cable	N			1.0mm <sup>2</sup> (1.5mm)	1.0mm <sup>2</sup> (1.5mm)	1.5mm <sup>2</sup>	0.75mm <sup>2</sup>	
	L			1.0mm <sup>2</sup> (1.5mm)	1.0mm <sup>2</sup> (1.5mm)	1.5mm <sup>2</sup>	0.75mm <sup>2</sup>	
	1			1.0mm <sup>2</sup> (1.5mm)	1.0mm <sup>2</sup> (1.5mm)	1.5mm <sup>2</sup>	0.75mm <sup>2</sup>	
	⊕			1.0mm <sup>2</sup> (1.5mm)	1.0mm <sup>2</sup> (1.5mm)	1.5mm <sup>2</sup>	0.75mm <sup>2</sup>	

Type for 220V of fuse used on indoor unit controller for 7K , 9K , 12K 15K , 16K , 18K , 22K , 24K , 30K is 50T with rating 3.15 A , 250V Type for 110V of fuse used on indoor unit controller for 7K, 9K 12k is 50T with rating 3.15 A , 125V ; Type of fuse used on inverter outdoor unit controller for 7K, 9K , 12K is 61T with rating 15 A , 250V , for 18K , 22K , 24K is 65TS with rating 25A , 250V.

# MAINTENANCE

Periodic maintenance is essential for keeping your air conditioner efficient.

Before carrying out any maintenance, disconnect the power supply by putting the installation on/ off switch to “off” .

## INDOOR UNIT

### ANTIDUST FILTERS

1. Open the front panel following the direction of the arrow
2. Keeping the front panel raised with one hand, take out the air filter with the other hand
3. Clean the filter with water ; if the filter is soiled with oil, it can be washed with warm water (not exceeding 45°C).  
Leave to dry in a cool and dry place.
4. Keeping the front panel raised with one hand, insert the air filter with the other hand
5. Close

The electrostatic and the deodorant filter (if installed) cannot be washed or regenerated and must be replaced with new filters once every 6 months.

### CLEANING THE HEAT EXCHANGER

1. Open the front panel of the unit and lift it till its greatest stroke and then unhook it from the hinges to make the cleaning easier.
2. Clean the indoor unit using a cloth with the water (not higher than 40°C) and neutral soap. Never use aggressive solvents or detergents.
3. If the battery of the outdoor unit is clogged, remove the leaves and the waste and remove the dust with air jet or a bit of water.

### END OF SEASON MAINTENANCE

1. Disconnect the automatic switch or the plug.
2. Clean and replace the filters
3. On a sunny day let the conditioner work in ventilation for some hours, so that the inside of the unit can dry completely..

### REPLACING THE BATTERIES

When:

- There is no confirmation beep from the indoor unit.
- The LCD doesn't activate.

How:

- Take off the cover at back.
- Place the new batteries respecting the symbols + and - .

N.B: Use only new batteries. Remove the batteries from the remote control when the conditioner is not in operation

**WARNING!** Do not throw batteries into common rubbish, they should be disposed of in the special containers situated in the collection points.

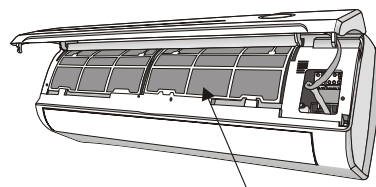
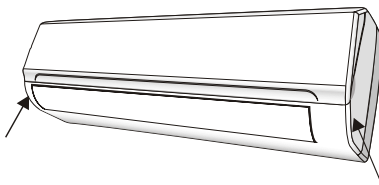

antidust filter

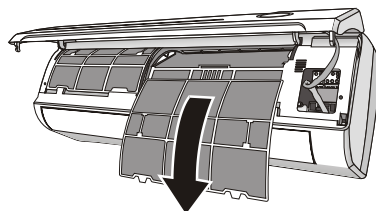

# TROUBLESHOOTING

MALFUNCTION	POSSIBLE CAUSES
The appliance does not operate	Power failure/plug pulled out
	Damaged indoor/outdoor unit fan motor
	Faulty compressor thermomagnetic circuit breaker
	Faulty protective device or fuses.
	Loose connections or plug pulled out
	It sometimes stops operating to protect the appliance.
	Voltage higher or lower than the voltage range
	Active TIMER-ON function
Damaged electronic control board	
Strange odour	Dirty air filter
Noise of running water	Back flow of liquid in the refrigerant circulation
A fine mist comes from the air outlet	This occurs when the air in the room becomes very cold, for example in the “COOLING” or “DEHUMIDIFYING/DRY” modes.
A strange noise can be heard	This noise is made by the expansion or contraction of the front panel due to variations in temperature and does not indicate a problem.
Insufficient airflow, either hot or cold	Unsuitable temperature setting.
	Obstructed air conditioner intakes and outlets.
	Dirty air filter.
	Fan speed set at minimum.
	Other sources of heat in the room.
The appliance does not respond to commands	No refrigerant.
	Remote control is not near enough to indoor unit.
	The batteries of remote control nearly has no power.
The display is off	Obstacles between remote control and signal receiver in indoor unit.
	Active LIGHT function
	Power failure
Switch off the air conditioner immediately and cut off the power supply in the event of:	Strange noises during operation.
	Faulty electronic control board
	Faulty fuses or switches.
	Spraying water or objects inside the appliance.
	Overheated cables or plugs.
Very strong smells coming from the appliance.	

## ERROR SIGNALS ON THE DISPLAY

In case of error, the display on the indoor unit shown the following error codes:

	RUN lamp	Description of the trouble
<b>E1</b>	flashes once	The fault of indoor temperature sensor
<b>E2</b>	flashes twice	The fault of indoor pipe temperature sensor
<b>EE</b>	flashes 6 times	Malfunction of indoor fan motor.