

CLICK ANYWHERE on THIS PAGE TO RETURN to SAMSUNG HVAC
MANUALS & AGE at [InspectApedia.com](https://www.inspectApedia.com)

Air conditioner

User manual/Installation manual

AR**NSPX** / AR**NVPX**

- Thank you for purchasing this Samsung air conditioner.
- Before operating this unit, please read this user manual carefully and retain it for future reference.



DB68-07475A-00

SAMSUNG

Contents

Safety Information	4
Safety Information	4
At a Glance	9
Indoor Unit Overview	9
Display	
Remote Control Overview	10
Inserting batteries	
Remote Control Operation	11
Operation modes • Controlling temperature • Controlling fan speed • Controlling air flow direction	
Power Smart Features	13
Cooling Operation	13
Cool mode • 2-Step cooling function • Wind-Free Cooling function	
Dehumidifying Operation	15
Dry mode	
Air Purifying Operation	15
Ionizer function	
Heating Operation	16
Heat mode	
Quick Smart Features	17
Auto mode • Fan mode • Fast function • Comfort function • Beep sound function • Quiet function • Display lighting function • Wi-Fi function (Samsung Connect App)	
Energy-Saving Features	21
Energy-Saving Operation	21
Electricity consumption check • Single user function • Timed on/Timed off function • good'sleep function	
Cleaning and Maintenance	24
Cleaning at a Glance	24
Troubleshooting	27
Connect App	29
Installation	33
Safety Information on Installation	33
Preparation	35
Step 1.1 Choosing the installation location	
Step 1.2 Unpacking	
Step 1.3 Checking and preparing accessories and tools	
Step 1.4 Drilling a hole through the wall	
Step 1.5 Taping the pipes, cables, and drain hose	

Indoor Unit Installation

39

Step 2.1 Disassembling the cover panel

Step 2.2 Disassembling the installation plate

Step 2.3 Connecting the power and communication cables (assembly cable)

Step 2.4 Optional: Extending the power cable

Step 2.5 Installing and connecting the drain hose

Step 2.6 Optional: Extending the drain hose

Step 2.7 Optional: Changing the direction of the drain hose

Step 2.8 Installing and connecting the assembly pipes to the refrigerant pipes (assembly pipe)

Step 2.9 Shortening or extending the refrigerant pipes (assembly pipe)

Step 2.10 Fixing the installation plate

Step 2.11 Fixing the indoor unit to the installation plate

Step 2.12 Assembling the cover panel

Outdoor Unit Installation

47

Step 3.1 Fixing the outdoor unit in place

Step 3.2 Connecting the power and communication cables and the refrigerant pipes

Step 3.3 Evacuating the air

Step 3.4 Adding refrigerant

Indoor Unit Installation

50

Step 4.1 Performing the gas leak tests

Step 4.2 Running the Smart Install mode

Step 4.3 Performing final check and trial operation



***Correct Disposal of This Product
(Waste Electrical & Electronic Equipment)***

(Applicable in countries with separate collection systems)

This marking on the product, accessories or literature indicates that the product and its electronic accessories (e.g. charger, headset, USB cable) should not be disposed of with other household waste at the end of their working life. To prevent possible harm to the environment or human health from uncontrolled waste disposal, please separate these items from other types of waste and recycle them responsibly to promote the sustainable reuse of material resources.

Household users should contact either the retailer where they purchased this product, or their local government office, for details of where and how they can take these items for environmentally safe recycling.

Business users should contact their supplier and check the terms and conditions of the purchase contract. This product and its electronic accessories should not be mixed with other commercial wastes for disposal.



Correct disposal of batteries in this product

This marking on the battery, manual or packaging indicates that the batteries in this product should not be disposed of with other household waste at the end of their working life. Where marked, the chemical symbols Hg, Cd or Pb indicate that the battery contains mercury, cadmium or lead above the reference levels in EC Directive 2006/66.

Safety Information

Before using your new air conditioner, please read this manual thoroughly to ensure that you know how to safely and efficiently operate the extensive features and functions of your new appliance.

Because the following operating instructions cover various models, the characteristics of your air conditioner may differ slightly from those described in this manual. If you have any questions, call your nearest contact centre or find help and information online at www.samsung.com.

WARNING

Hazards or unsafe practices that may result in severe personal injury or death.

CAUTION

Hazards or unsafe practices that may result in minor personal injury or property damage.

 Follow directions.

 Do NOT attempt.

 Make sure the machine is grounded to prevent electric shock.

 Cut off the power supply.

 Do NOT disassemble.

FOR INSTALLATION

WARNING

 Use a power cord with this product's power specifications or higher and use the power cord for this appliance only. In addition, do not use an extension cord.

- Extending the power cord may result in electric shock or fire.
- Do not use an electric transformer. This may result in electric shock or fire.
- If the voltage/frequency/rated current condition is different, it may cause fire.

The installation of this appliance must be performed by a qualified technician or service company.

- Failing to do so may result in electric shock, fire, explosion, problems with the product, or injury and may also void warranty on the installed product.

Install an Isolation Switch next to the Air Conditioner (but not on the panels of the Air Conditioner) and circuit breaker dedicated to the air conditioner.

- Failing to do so may result in electric shock or fire.

Fix the outdoor unit firmly so that the electric part of the outdoor unit is not exposed.

- Failing to do so may result in electric shock, fire, explosion, or problems with the product.

 Do not install this appliance near a heater, or inflammable material. Do not install this appliance in a humid, oily or dusty location, in a location exposed to direct sunlight and water (or rain). Do not install this appliance in a location where gas may leak.

- This may result in electric shock or fire.

Never install the outdoor unit in a location such as on a high external wall where it could fall.

- If the outdoor unit falls, it may result in injury, death or property damage.

 This appliance must be properly grounded. Do not ground the appliance to a gas pipe, plastic water pipe, or telephone line.

- Failing to do so may result in electric shock, fire, and explosion.
- Make sure to use a socket-outlet with ground.

 **CAUTION**

 Install your appliance on a level and hard floor that can support its weight.

- Failing to do so may result in abnormal vibrations, noise, or problems with the product.

Install the drain hose properly so that water drains correctly.

- Failing to do so may result in water overflowing and property damage. Avoid adding drain to waste pipes as odours may arise in the future.

When installing the outdoor unit, make sure to connect the drain hose so that draining is performed correctly.

- The water generated during heating by the outdoor unit may overflow and result in property damage.
In particular, in winter, if a block of ice falls, it may result in injury, death or property damage.

FOR POWER SUPPLY

 **WARNING**

 When the circuit breaker is damaged, contact your nearest service centre.

 Do not pull or excessively bend the power line. Do not twist or tie the power line. Do not hook the power line over a metal object, place a heavy object on the power line, insert the power line between objects, or push the power line into the space behind the appliance.

- This may result in electric shock or fire.

 **CAUTION**

 When not using the air conditioner for a long period of time or during a thunder/lightning storm, cut the power at the circuit breaker.

- Failing to do so may result in electric shock or fire.

FOR USING

 **WARNING**

 If the appliance is flooded, please contact your nearest service centre.

- Failing to do so may result in electric shock or fire.

If the appliance generates a strange noise, a burning smell or smoke, cut off the power supply immediately and contact the nearest service centre.

- Failing to do so may result in electric shock or fire.

In the event of a gas leak (such as propane gas, LP gas, etc.), ventilate immediately without touching the power line. Do not touch the appliance or power line.

- Do not use a ventilating fan.
- A spark may result in an explosion or fire.

To reinstall the air conditioner, please contact your nearest service centre.

- Failing to do so may result in problems with the product, water leakage, electric shock, or fire.
- Delivery service for the product is not provided. If you reinstall the product in another location, additional construction expenses and an installation fee will be charged.
- Especially, when you wish to install the product in an unusual location such as in an industrial area or near the seaside where it is exposed to salt in the air, please contact your nearest service centre.



Do not touch the circuit breaker with wet hands.

- This may result in electric shock.

Do not turn the air conditioner off with the circuit breaker while it is operating.

- Turning the air conditioner off and then on again with the circuit breaker may cause a spark and result in electric shock or fire.

After unpacking the air conditioner, keep all packaging materials well out of the reach of children, as packaging materials can be dangerous to children.

- If a child places a bag over its head, it may result in suffocation.

Do not touch the air flow blade with your hands or fingers during heating.

- This may result in electric shock or burns.

Do not insert your fingers or foreign substances into the air inlet/outlet of the air conditioner.

- Take special care that children do not injure themselves by inserting their fingers into the product.

Do not strike or pull the air conditioner with excessive force.

- This may result in fire, injury, or problems with the product.

Do not place an object near the outdoor unit that allows children to climb onto the machine.

- This may result in children seriously injuring themselves.

Do not use this air conditioner for long periods of time in badly ventilated locations or near infirm people.

- Since this may be dangerous due to a lack of oxygen, open a window at least once an hour.



If any foreign substance such as water has entered the appliance, cut off the power supply and contact the nearest service centre.

- Failing to do so may result in electric shock or fire.



Do not attempt to repair, disassemble, or modify the appliance yourself.

- Do not use any fuse (such as copper, steel wire, etc.) other than the standard fuse.

- Failing to do so may result in electric shock, fire, problems with the product, or injury.

**CAUTION**

Do not place objects or devices under the indoor unit.

- Water dripping from the indoor unit may result in fire or property damage.

Check that the installation frame of the outdoor unit is not broken at least once a year.

- Failing to do so may result in injury, death or property damage.

Max current is measured according to IEC standard for safety and current is measured according to ISO standard for energy efficiency.



Do not stand on top of the appliance or place objects (such as laundry, lighted candles, lighted cigarettes, dishes, chemicals, metal objects, etc.) on the appliance.

- This may result in electric shock, fire, problems with the product, or injury.

Do not operate the appliance with wet hands.

- This may result in electric shock.

Do not spray volatile material such as insecticide onto the surface of the appliance.

- As well as being harmful to humans, it may also result in electric shock, fire or problems with the product.

Do not drink the water from the air conditioner.

- The water may be harmful to humans.

Do not apply a strong impact to the remote control and do not disassemble the remote control.

Do not touch the pipes connected with the product.

- This may result in burns or injury.

Do not use this air conditioner to preserve precision equipment, food, animals, plants or cosmetics, or for any other unusual purposes.

- This may result in property damage.

Avoid directly exposing humans, animals or plants to the air flow from the air conditioner for long periods of time.

- This may result in harm to humans, animals or plants.

This appliance is not intended for use by persons (including children) with reduced physical, sensory or mental capabilities, or lack of experience and knowledge, without supervision or instruction concerning use of the appliance by a person responsible for their safety. Children should be supervised to ensure that they do not play with the appliance.

FOR CLEANING



WARNING



Do not clean the appliance by spraying water directly onto it. Do not use benzene, thinner or alcohol to clean the appliance.

- This may result in discolouration, deformation, damage, electric shock or fire.

Before cleaning or performing maintenance, cut off the power supply and wait until the fan stops.

- Failing to do so may result in electric shock or fire.



CAUTION



Take care when cleaning the surface of the heat exchanger of the outdoor unit since it has sharp edges.

- This should be done by a qualified technician. Please contact your installer or service centre.



Do not clean the inside of the air conditioner by yourself.

- For cleaning inside the appliance, contact your nearest service centre.
- When cleaning the filter, refer to the descriptions in the 'Cleaning at a Glance' section.
- Failing to do so may result in damage, electric shock or fire.
- Make sure to prevent any injury from sharp edges of the surface when handling the heat exchanger.

Indoor Unit Overview

The actual product may differ slightly from the image depicted below.

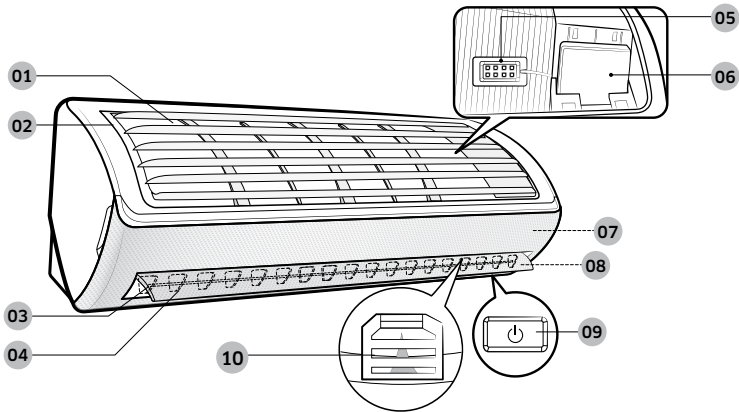

- | | |
|------------------------------------|--|
| 01 Air intake | 06 Wi-Fi module |
| 02 Air filter | 07 Wind-Free panel |
| 03 Air flow blade (up and down) | 08 Display |
| 04 Air flow blade (left and right) | 09 Power button /Remote control receiver |
| 05 Room temperature sensor | 10 (Inside) Ionizer |

Display

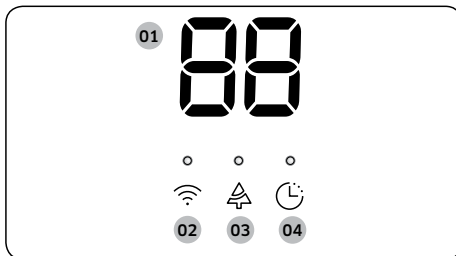

- | | |
|----|---|
| 01 | Temperature indicator
Filter reset indicator (CF)
Electricity consumption indicator
Auto clean indicator (C !)
Defrost indicator (DF) |
| 02 | Wi-Fi indicator |
| 03 | Ionizer indicator |
| 04 | Timer indicator
good'sleep indicator
Auto clean indicator |

Remote Control Overview

At a Glance

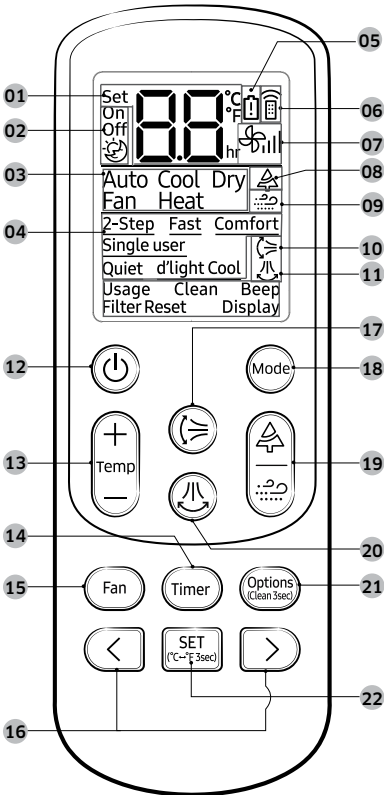

- 01 Set temperature indicator
- 02 Timer option indicator
- 03 Operation mode indicator
- 04 Options indicator
- 05 Low battery indicator
- 06 Transmit indicator
- 07 Fan speed indicator
- 08 Ionizer indicator
- 09 Wind-Free indicator
- 10 Vertical air swing indicator
- 11 Horizontal air swing indicator
- 12 Power button
- 13 Temperature button
- 14 Timer button
- 15 Fan speed button
- 16 Direction button / Selection button
- 17 Vertical air swing button
- 18 Mode button
- 19 Ionizer/ Wind-Free button
- 20 Horizontal air swing button
- 21 Options / Clean button
- 22 SET button / Temperature type button (°C↔°F)

Inserting batteries

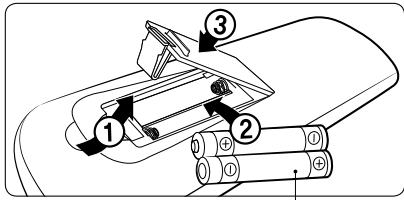

two 1.5V AAA type batteries

NOTE

- The descriptions in this manual are primarily made based on the remote control buttons.
- Although Heat(AR**NVPX***) and d'light Cool is displayed on the remote control display, it is not available on this model.

Remote Control Operation

You can use the air conditioner easily by selecting a mode and then by controlling the temperature, fan speed, and air direction.

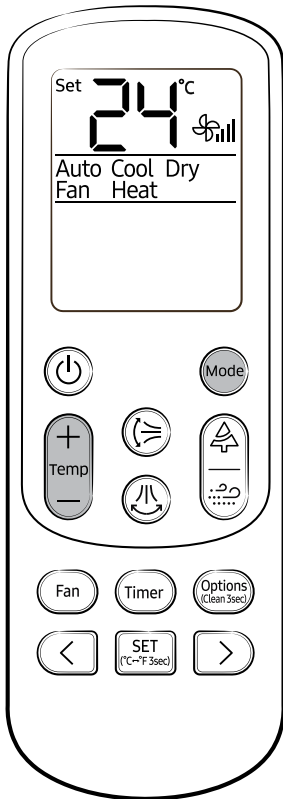

Operation modes

You can change the current mode between Auto, Cool, Dry, Fan, and Heat by pressing the  button.

Controlling temperature

You can control the temperature in each mode as follows:

Mode	Temperature control
Auto/Cool/Heat	Adjust by 1 °C between 16 °C and 30 °C.
Dry	Adjust by 1 °C between 18 °C and 30 °C.
Fan	You cannot control the temperature.

You can switch between Celsius and Fahrenheit indications on the remote control.



▶ Press and hold for 3 or more seconds

NOTE

- The temperature indications on the indoor unit are not switched.
- This function is canceled when the remote control batteries are replaced. In this case, run this function again.

You can use the Cool, Dry, and Heat modes in the following conditions:

Mode	Cool	Dry	Heat
Indoor temperature	16 °C to 32 °C	18 °C to 32 °C	27 °C or less AR**NSPX***
Outdoor temperature	16 °C to 52 °C AR**NVPX***	16 °C to 52 °C AR**NVPX***	-15 °C to 24 °C AR**NSPX***
	-10 °C to 46 °C AR**NSPX***	-10 °C to 46 °C AR**NSPX***	
Indoor humidity	80% or less relative humidity	-	-

- If the air conditioner operates in a high humidity environment in the Cool mode for an extended period of time, condensation may occur.
- If the outdoor temperature drops to -15°C, the heating capacity may decrease to as much as 60% to 70% of the specified capacity (AR**NSPX***).

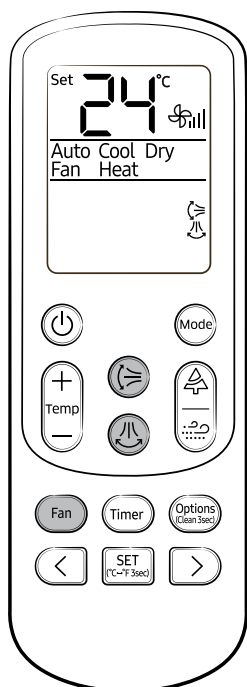

Controlling fan speed

You can select the following fan speeds in each mode:

Mode	Available fan speeds
Auto/Dry	🌀 (Auto)
Cool/Heat	🌀 (Auto), 🌀 (Low), 🌀 (Med), 🌀 (High), 🌀 (Turbo)
Fan	🌀 (Low), 🌀 (Med), 🌀 (High), 🌀 (Turbo)

Controlling air flow direction

Keep the air flow in a constant direction by stopping the movements of the vertical and horizontal air flow blades.

In operation ►  or 

NOTE

- If you adjust the vertical air flow blade manually, it may not close completely when you turn off the air conditioner.
- If you adjust the horizontal air flow blade manually, it may not operate normally.
- You can control the air flow direction when the good'sleep function is running while in the Heat mode, but not while in the Cool mode (AR**NSPX***).

Cooling Operation

The smart and powerful cooling functions of the Samsung air conditioner keep an enclosed space cool and comfortable.

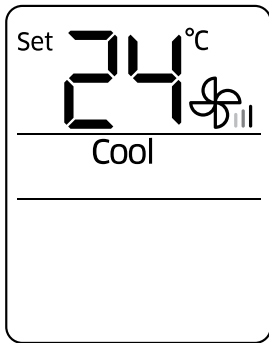

Cool mode

Use the Cool mode to stay cool in hot weather.



NOTE

- For comfort, keep the temperature difference between the indoor and outdoor air within 5 °C in the Cool mode.
- After selecting the Cool mode, select a function, temperature, and fan speed that you want to apply.
 - To cool your room quickly, select a low temperature and a strong fan speed.
 - To save energy, select a high temperature and a weak fan speed.
 - As the indoor temperature approaches the set temperature, the compressor will operate at a low speed to save energy.

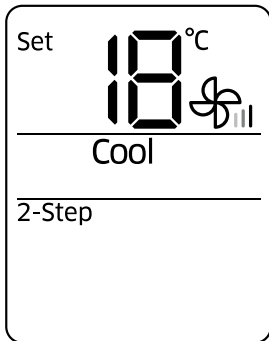

2-Step cooling function

Strong cooling operation starts to reach the desired temperature in the first step. When the room temperature nearly reaches the desired temperature, the fan speed and the air flow direction are controlled properly. When it reaches the desired temperature, the Wind-Free Cooling operation starts to provide mild breeze.

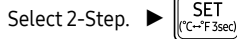

NOTE

- When the indoor temperature rises by some elements such as solar radiation, door opening and closing, or ventilation, the Wind-Free Cooling operation is cancelled and then changed to a strong cooling operation automatically.
- The air flow blade is automatically adjusted to control air flow according to the indoor temperature.

Change of the air flow blade by temperature	
○	●

- : Open (Breeze comes out from the air flow blade)
- : Close (Breeze comes out from the Wind-Free panel)
- If you select the 2-Step cooling function while such functions as Wind-Free Cooling, Fast, Comfort, Quiet, Single user, good'sleep function are running, these functions are cancelled.

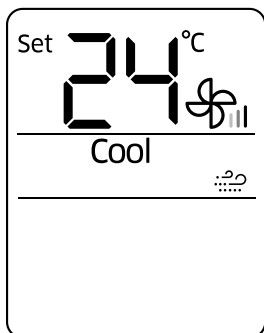

Wind-Free Cooling function

Use the Wind-Free Cooling function to enjoy mild cool breeze exuding from fine holes on the Wind-Free panel with the air flow blade closed, instead of getting cool wind directly. The automated control of the temperature and fan speed according to the indoor temperatures keeps your room cool and pleasant.

In the Cool/Dry/Fan mode ▶ 



NOTE

- To cancel this function, press the  button again.
- If the Wind-Free Cooling function is cancelled, the air conditioner returns to the original fan speed.
- You can adjust the set temperature during the Wind-Free Cooling function, and recommended set temperatures are 24 to 26 °C. However, you cannot change the set temperature in the Fan mode.
- You can use the Wind-Free Cooling function when the Cool, Dry, or Fan mode is running.
- If the room temperature goes high because of rise of external temperature, heat from cooking, or other reason, operate the Wind-Free Cooling function after operating in the Cool mode.
- If you select the Wind-Free Cooling function in the Fan mode, the compressor stops working so that cool air does not come out. However, mild breeze comes out and starts to clean the air in the room.
- When indoor humidity becomes higher relatively while the Wind-Free Cooling function is running, the air flow blade is open to control the air flow smoothly in the room. When the indoor temperature and humidity are changed, the air flow blade is closed and the Wind-Free Cooling function starts to operate.

Change of the air flow blade by temperature and humidity



- : Open (Breeze comes out from the air flow blade)
- : Close (Breeze comes out from the Wind-Free panel)

- If the air conditioner is installed over the bed, adjust the set temperature from 25 to 27 °C to use the Wind-Free Cooling function while sleeping or using the good'sleep function.
- If you select the Wind-Free Cooling function while such functions as 2-step cooling, Fast, Comfort, Single user, Quiet or air flow direction (, ) function are running, these functions are cancelled.

Dehumidifying Operation

The dehumidifying function of the Samsung air conditioner keeps an enclosed space dry and comfortable.

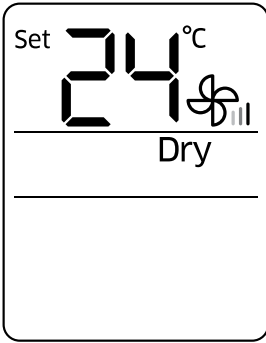

Dry mode

Use the Dry mode in rainy or humid weather.



NOTE

- The lower the set temperature is, the greater the dehumidifying capacity is. When the current humidity seems to be high, adjust the set temperature to a low temperature.
- You cannot use the Dry mode for heating. The Dry mode is designed to produce a cooling side-effect.

Air Purifying Operation

The air purification function of the Samsung air conditioner keeps the air in an enclosed space purified.

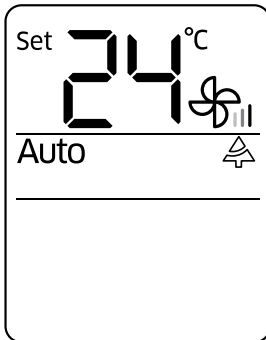

Ionizer function

Use the Ionizer function to purify your room with negative ions produced by the air conditioner. This function is available in the Auto, Cool, Dry, Fan, and Heat modes.

In the Auto, Cool, Dry, Fan, or Heat mode ▶ 

NOTE

- You can adjust the set temperature, except for in the Fan mode.
- When the Ionizer function is additionally selected while a specific mode is running, there is little difference in electricity consumption and operating noise.

Heating Operation

The heating functions of the Samsung air conditioner keep an enclosed space warm and comfortable.

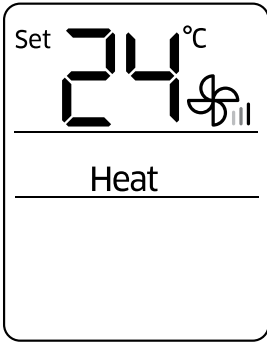

Heat mode

Use the Heat mode to stay warm.



NOTE

- This mode is supported by heating models only: AR**NSPX*** series.
- While the air conditioner warms up, the fan may not operate for about 3 to 5 minutes at the beginning to prevent cold blasts.
- If the air conditioner heats insufficiently, use an additional heating appliance in combination with the air conditioner.
- When the outdoor temperature is low and the humidity is high in Heat mode, frost may develop on the outdoor heat exchanger. This may also decrease the heating efficiency. If this occurs, the air conditioner runs the defrost function for 5 to 12 minutes to remove frost from the outdoor heat exchanger.
- When the defrost function is running, steam is produced on the outdoor unit. The air conditioner moves the vertical air flow blade to the lowest position, as shown in the left figure, to prevent cold air from coming out from the indoor unit.
 - A. The position of the vertical air flow blade when the defrost function is running (The blade looks almost closed.)
 - B. The position range of the vertical air flow blade when the Heat mode is running.
- When the defrost function is running, no air comes out from the indoor unit in order to prevent cold air from coming out. When the defrost function is finished, warm air comes out after a while.
- The cycle of the defrost function may be shortened depending on the amount of frost on the outdoor unit.
- The cycle of the defrost function may be shortened depending on the humidity from rain and snow, too.
- When the defrost function is running, you cannot select other functions with the remote control. Select them after the defrost function is finished.

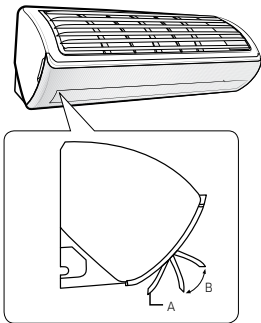

Quick Smart Features

There is a variety of extra functionality provided by the Samsung air conditioner.

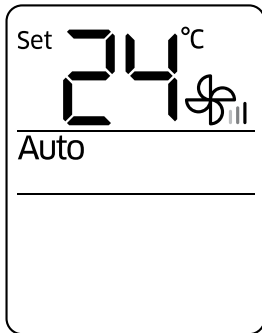

Auto mode

Use the Auto mode when you want the air conditioner to automatically control the operation. The air conditioner will provide the most comfortable atmosphere that it can.



NOTE

- When the indoor temperature seems to be higher or lower than the set point, the air conditioner automatically produces either cool air to cool down the indoor temperature or warm air to warm up the indoor temperature.

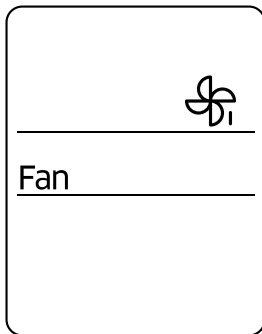

Fan mode

Use the Fan mode to run the air conditioner like a common fan. The air conditioner provides a natural breeze.



NOTE

- If the air conditioner will not be used for an extended period of time, dry the air conditioner by running it in the Fan mode for 3 or 4 hours.
- The outdoor unit is designed not to operate in the Fan mode to prevent cold air from entering through the unit. This is a normal operation and not a fault with the air conditioner.

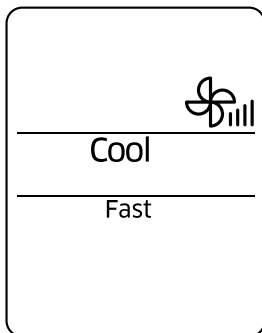

Fast function

Use the Fast function to quickly cool or heat your room. This function is the most powerful cooling and heating function provided by the air conditioner. You can select this function both in the Cool and Heat modes.



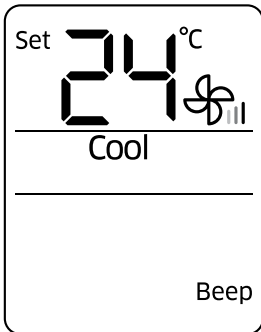
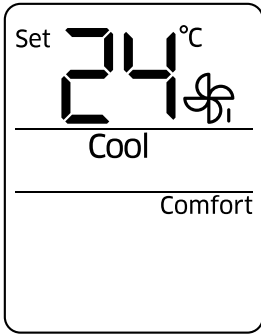

NOTE

- If you select the Fast function while such functions as 2-Step cooling, Wind-Free Cooling, Comfort, Single user, Quiet, or good'sleep are running, these functions are cancelled.
- You can change the air flow direction.
- You cannot change the set temperature and the fan speed.
- When you select the Fast function in the Heat mode, you may not be able to increase the fan speed in order to prevent cool air from blowing.

Comfort function

Use the Comfort function when you feel the current cooling or heating effect is too strong. The air conditioner provides a mild cooling or heating. You can select this function both in the Cool and Heat modes.

In the Cool or Heat mode ▶ ▶ ▶

Select Comfort. ▶

NOTE

- You can change the set temperature and the air flow direction.
- You cannot change the fan speed.
- If you select the Comfort function while such functions as 2-Step cooling, Wind-Free Cooling, Fast, Single user, Quiet, or good'sleep are running, these functions are cancelled.
- If you feel cooling or heating effect in the Comfort function is weak, cancel the Comfort function.

Beep sound function

Use the Beep sound function to turn on or off the beep sound that plays when you press a button on the remote control.

▶ ▶ Select Beep. ▶

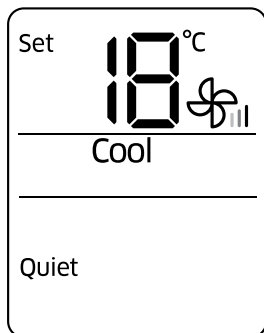

Quiet function

Use the Quiet function to reduce operating noise. You can select this function both in the Cool and Heat modes.

In the Cool or Heat mode ▶  ▶   ▶

Select Quiet. ▶ 

NOTE

- You can change the set temperature and the air flow direction.
- You cannot change the fan speed.
- If you select the Quiet function while such functions as 2-Step cooling, Wind-Free Cooling, Fast, Comfort, Single user, or good'sleep are running, these functions are cancelled.

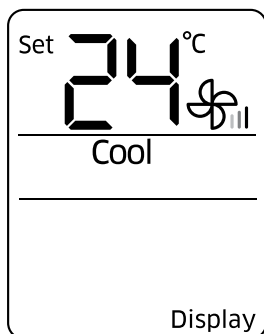

Display lighting function

Use the Display lighting function to turn on or off the lighting of the indoor unit display.

 ▶   ▶ Select Display. ▶ 

NOTE

- The Display lighting function does not operate when the indoor unit is turned off.
- The Timer () indicator does not disappear, even if you turn off the Display lighting function.
- If you change the current mode or function when the Display lighting function is on, the Display lighting function turns off.

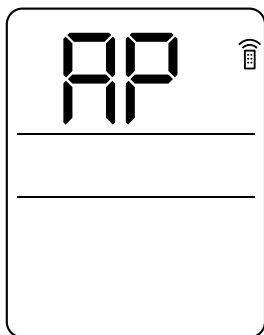

Wi-Fi function (Samsung Connect App)

When you turn on the Wi-Fi function, the Transmit () indicator blinks and **AP** appears on the remote control display for a few seconds. Then both of them disappear.

In operation ►  ► Hold down 4 seconds.

NOTE

- For further information, refer to Connect App chapter in this manual.
- Samsung Connect App may not be available on some models.

Energy-Saving Operation

The smart energy-saving functions of the Samsung air conditioner reduce electricity consumption.

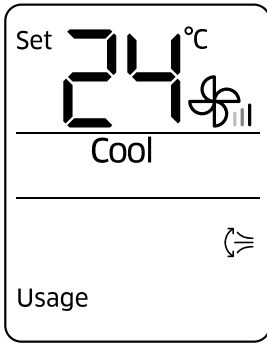

Electricity consumption check

Use the Usage function to check the amount of electricity consumed by using the air conditioner. The amount consumed is displayed on the indoor unit display for a few seconds, and the set indoor temperature appears.

In operation ▶ ▶ ▶

Select Usage. ▶

The value range displayed is between 0.1 kWh and 99 kWh. Electricity consumption is calculated from the moment the air conditioner turns on. The value is reset when the air conditioner turns off.

NOTE

- The usage shown on the indoor unit display may slightly differ from the amount of electricity actually consumed.
- You can view electricity consumption only when the air conditioner is operating.

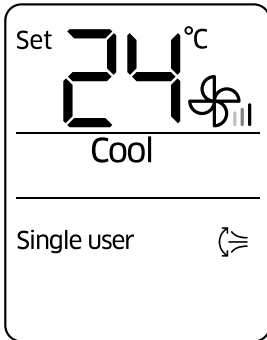

Single user function

Use the Single user function to reduce electricity consumption while staying cool or warm. You can select this function in the Cool and Heat modes.

In the Cool or Heat mode ▶ ▶ ▶

Select Single user. ▶



NOTE

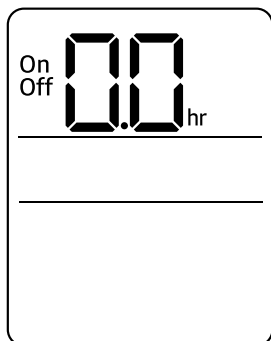

- When the Single user function starts, the pattern appears on the remote control for a few seconds, and vertical air swing begins automatically.
- After selecting the Single user function, you can change the set temperature (24 °C to 30 °C in the Cool mode, 16 °C to 30 °C in the Heat mode), fan speed, and vertical air flow direction.
- When the Single user function is turned on in the Cool mode while the set temperature is set to lower than 24 °C, the set temperature is automatically raised to 24 °C. But if the set temperature is set to between 25 °C and 30 °C, it remains the same.
- Even after you turn off the Single user function, vertical air swing continues until you turn it off with the Vertical air swing () button.
- If you select the Single user while such function as 2-Step cooling, Wind-Free Cooling, Fast, Comfort, Quiet, or good'sleep are running, these modes are cancelled.





Timed on/Timed off function

Use the Timed on/Timed off to turn on or off the air conditioner after the time that you set.

 (Select On or Off among On, Off, and ) ▶

  (Set the on/off time.) ▶ 

- Press the  (Timer) button to change the current function between On, Off, and  (good'sleep).  (good'sleep) is displayed in the Cool and Heat mode only.

NOTE

- You can set a time between 0.5 and 24 hours. Set the time interval to 0.0 to cancel the Timed on/off function.
- Once you start the Timed on/off function, the Timer  indicator is displayed on the indoor unit display.
- After starting the Timed on function, you can change the mode and the set temperature. You cannot change the set temperature while the Fan mode is running.
- You cannot set the same time for both of the Timed on and Timed off functions.

Combining Timed on and Timed off	
When the air conditioner is off	Example) Timed on: 3 hours, Timed off: 5 hours The air conditioner turns on after 3 hours from the moment you start Timed on/off, remains on for 2 hours, then turns off automatically.
When the air conditioner is on	Example) Timed on: 3 hours, Timed off: 1 hour The air conditioner turns off after 1 hour from the moment you start Timed on/off, then turns on after 2 hours from the moment it is turned off.

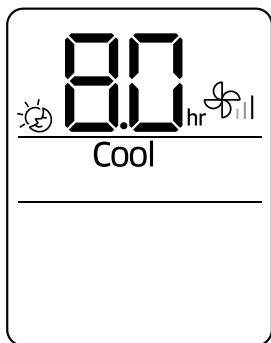

good'sleep function

Use the good'sleep function to get a good sleep at night and to save energy. You can select this function both in the Cool and Heat modes.

In the Cool or Heat mode ► (Timer) (Select  among On, Off, and ) ►



(◀) (▶) (Set the operation time.) ► (SET (°C~°F 3sec))

- Press the (Timer) (Timer) button to change the current function between On, Off, and  (good'sleep).

NOTE

- You can adjust the set temperature by 1 °C between 16 °C and 30 °C.
- The recommended and optimal set temperatures in the good'sleep function are as follows:





Mode	Recommended set temperature	Optimal set temperature
Cool	25 °C to 27 °C	26 °C
Heat	21 °C to 23 °C	22 °C

- Once you start the good'sleep function, the Timer () indicator appears on the indoor unit display.
- The good'sleep function can be operated with the Wind-Free Cooling function. Select the Wind-Free Cooling function to get mild breeze. To select or cancel the Wind-Free Cooling function, press the  button.
- You can set the operation time to between 0.5 and 12 hours. Set the operation time to 0.0 to cancel the good'sleep function.
- The default operation time for the good'sleep function in the Cool mode is 8 hours. If the operation time is set to over 5 hours, the Wake up function begins 1 hour before the set time. The air conditioner stops automatically when the operation time expires.
- When the Timed on, Timed off, and good'sleep functions are overlapped, the air conditioner operates its timer with only the function that you have started most recently.
- If you select the good'sleep function while such functions as 2-step cooling, Fast, Comfort, Quiet, Single user function are running, these functions are cancelled.

Cleaning at a Glance

Running Auto clean

1 Method 1: Press the  button for 3 seconds or more.

Method 2:  →   → Select [Clean] → 

• The indoor unit display shows :







2 The Auto clean function is activated.

3 When operation is off, auto clean starts for 10 min.
• The indoor unit display shows cleaning progress (from 1 to 99%).

4 The air conditioner is automatically turned off.

To deactivate the Auto clean function

Method 1: Press the  button for 3 seconds or more.

Method 2:  →   → Select [Clean] → 

To cancel the Auto clean operation

Press the  button twice within 20 seconds.



NOTE

- When the air conditioner is off, the Auto clean function starts immediately; when the air conditioner is in operation, the Auto clean function starts as soon as the air conditioner stops running.
- If you starts a function while in the Auto clean operation, the Auto clean function is reset, and then is restarted when that function is stopped or completed.

Cleaning the indoor unit exterior and outdoor unit heat exterior

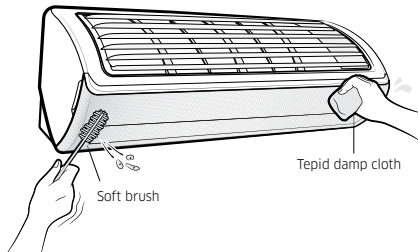

Before cleaning, be sure to turn off the equipment and disconnect the power plug.

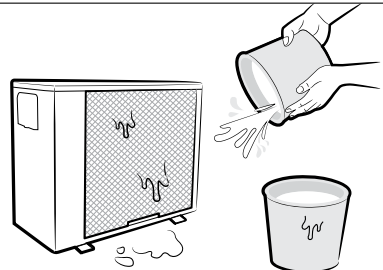

Spray water to clean the dust.

⚠ CAUTION

- Do not clean the display by using alkaline detergent.
- Do not use sulphuric acid, hydrochloric acid, or organic solvents (such as thinner, kerosene, and acetone) to clean the surfaces. Do not put any stickers on it as this can damage the surface of the air conditioner.
- When you clean and inspect the heat exchanger on the outdoor unit, contact the local service centre for help.

Cleaning the filter

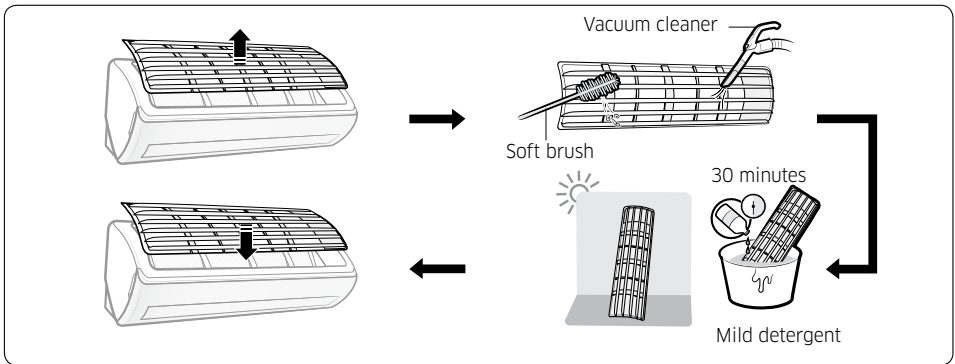

⚠ CAUTION

- Do not scrub the air filter with a brush or other cleaning utensil. This may damage the filter.
- Do not expose the air filter to direct sunlight when drying it.

📖 NOTE

- Clean the air filter every 2 weeks. Cleaning term may vary depending on the usage and environmental conditions.
- If the air filter dries in a humid area, it may produce offensive odours. Clean it again and dry it in a well-ventilated area.

Resetting the filter-cleaning reminder

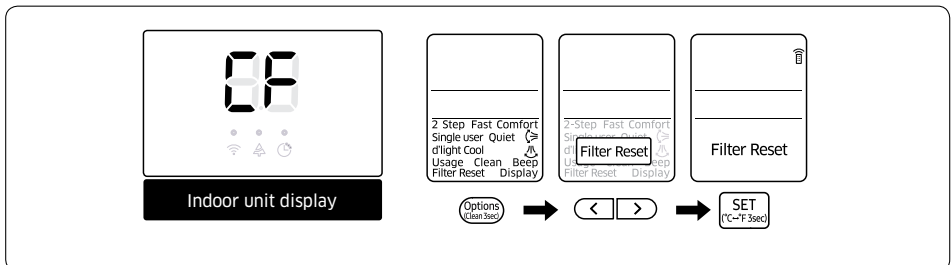

Tip on cleaning the Wind-Free panel

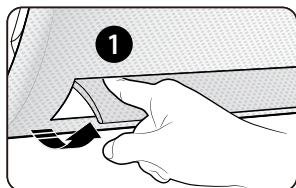

Gently push the air flow blade with your finger until it is open.

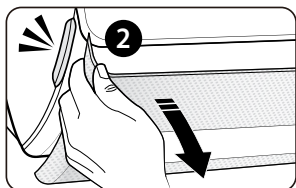

Hold and pull both sides of the Wind-Free panel until it is detached from the air conditioner.

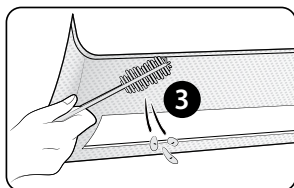

Remove the dust with a soft brush or vacuum cleaner.

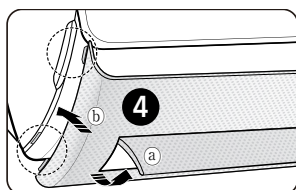

Gently push the air flow blade with your finger to open (a), then align and engage the protrusions (top left, top right, bottom left, bottom right) on the Wind-Free panel into the groves on the front panel (b).

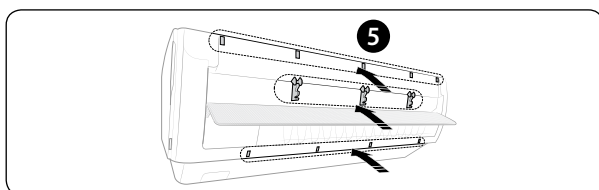

Push the 5 latches on top, 3 on center, and 4 on bottom with your hand.

CAUTION

- If you assemble the air flow blade without pushing it by hand, it may be obstructed by the Wind-Free panel and may not open when the air conditioner operates.

Troubleshooting

If the air conditioner operates abnormally, refer to the following chart to save time and unnecessary expenses.

Problem	Solution
The air conditioner does not work at all.	<ul style="list-style-type: none"> • Check the power status, then operate the air conditioner again. • Switch on the circuit breaker, plug in the power cord, then operate the air conditioner again. • Make sure that the isolator is turned on. • Check whether the Timed off function is running. Operate the air conditioner again by pressing the Power button.
I cannot change the temperature.	<ul style="list-style-type: none"> • Check whether the Fan or Fast mode is running. In these modes, the air conditioner controls the set temperature automatically, and you cannot change the set temperature.
Cool or warm air does not come out of the air conditioner.	<ul style="list-style-type: none"> • Check whether the set temperature is higher in the Cool mode or lower in the Heat mode than the current temperature. Press the Temperature button on the remote control to change the set temperature. • Check whether the air filter is blocked with dirt. If the air filter is blocked, the cooling and heating performance may decrease. Remove dirt regularly. • Check whether the outdoor unit is covered or installed near obstacles. Remove the coverings and obstacles. • Check whether the air conditioner is running the defrost function. When ice forms in winter or the outdoor temperature is too low, the air conditioner runs the defrost function automatically. While this function is running, the indoor fan stops and warm air does not come out. • Check whether doors or windows are open. This may cause poor cooling or heating performance. Close the doors and windows. • Check whether the air conditioner is turned on immediately after the cooling or heating operation stops. In this case, only the fan runs to protect the outdoor unit compressor. • Check whether the pipe length is too long. When the pipe length exceeds the maximum pipe length, the cooling and heating performance may decrease.
I cannot change the air flow direction.	<ul style="list-style-type: none"> • Check whether the good'sleep function is running. While this function is running, you cannot control the air flow direction. (But you can control the air flow direction if this function is running in the Heat mode.)
I cannot change the fan speed.	<ul style="list-style-type: none"> • When the Auto, Dry, or Fast mode is running or the good'sleep function is running in the Cool mode, the air conditioner controls the fan speed automatically and you cannot change the fan speed.

Problem	Solution
The remote control does not work.	<ul style="list-style-type: none"> • Replace the batteries in the remote control with new ones. • Make sure that nothing is blocking the remote control sensor. • Check whether there are strong lighting apparatus near the air conditioner. Strong light which comes from fluorescent bulbs or neon signs may interrupt the electric waves.
The Timed on/off function does not work.	<ul style="list-style-type: none"> • Check whether you pressed the SET button on the remote control after setting the time.
The indicator blinks continuously.	<ul style="list-style-type: none"> • Press the Power button to turn off the air conditioner or disconnect the power plug. If the indicator is still blinking, contact the service centre.
Odours permeate in the room during operation.	<ul style="list-style-type: none"> • Check whether the air conditioner is running in a smoky area. Ventilate the room or operate the air conditioner in the Fan mode for 3 to 4 hours. (There are no components used in the air conditioner that emit a strong odour.) • Check whether the drains are clean. Clean them regularly.
An error is indicated.	<ul style="list-style-type: none"> • If the indoor unit indicator blinks, contact the nearest service centre. Be sure to pass the error code to the service centre.
Noise is generated.	<ul style="list-style-type: none"> • When refrigerant flow changes, noise may be generated, depending on the status of the air conditioner. This is a normal operation.
Smoke is generated from the outdoor unit.	<ul style="list-style-type: none"> • It may not be a fire but it can be a steam generated from the outdoor heat exchanger while the defrost function is running in the Heat mode in winter.
Water drops from the pipe connections of the outdoor unit.	<ul style="list-style-type: none"> • Condensation may develop when the ambient temperature changes excessively. This is a normal operation.

Connect App



SAMSUNG
Connect

This product is the Smart Air conditioner which supports Samsung Connect App Service.

Connecting network

NOTE

- This Wi-Fi Aircon support only below three encryption.
 - Open (No encryption), WPA/TKIP, WPA2/AES
 - You may not be able to establish Wi-Fi connection if other type of encryption is used.
- For Wi-Fi Aircon installation, select indoor unit location near to wireless router. In case Wi-Fi signal strength is weakened, Smart App. may be disconnected depending on the Wi-Fi signal strength.
- Smart-Phone should be in the Wi-Fi signal zone to use Smart App.
- For Mobile broadband internet access, Smart App. can be used when Mobile Broadband Dongle is activated to use Wi-Fi.
- This product supports only DHCP(Dynamic Host Configuration Protocol). If users use an existing wireless router, the DHCP server option function should be activated.
- Select a channel for the wireless router that is not currently being used.
- If a wireless router is connected by other than the above modes, the router may not be connected with the air conditioner or may not work. To use 802.11n, using WPA2/AES is recommended.
- The quality of wireless network connection can be affected by the surrounding wireless environment.
- If an internet service provider has permanently registered the users PC or MAC address (a unique identifying number), the air conditioner might not be connected to internet. When appliances other than a PC are to be connected to Internet, ask your ISP (Internet service provider) about the procedures required to connect to the internet

- If your internet service provider requires an ID or a password to connect to the internet, your air conditioner may not be able to connect to the internet. If this is the case, you must enter your ID or password when connecting to the internet.
- The internet connection may fail because of a firewall problem. If this is the case, contact your internet service provider.
- If you cannot connect to the internet even after you have followed the procedures of your internet service provider, please contact a samsung service center.

Connecting the wireless IP router with an air conditioner

- For wireless router installation, refer to the user manual of the corresponding router.
- Samsung smart air conditioner supports the communication protocols of IEEE802.11 b/g/n(2.4Ghz).
- For wireless router installation, refer to the user manual of each manufacturing company. Samsung does not provide customers with the wireless router manual.
- Uncertified router may not be able to connect with an air conditioner.
- Certified router has the logo of below on the package or user manual.

Downloading the Samsung Connect app

- You can download the Samsung Connect app on your smart phone by searching "Samsung Connect" on Play Store, Galaxy Apps or iPhone App Store.

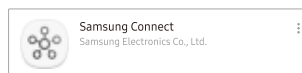

NOTE

- The Samsung Connect app supports Android OS 6.0 (marshmallow) or higher with third-party phones, Android OS 5.0 (lollipop) or higher with Samsung phones, iOS 10.0 or higher. and it is optimized with Samsung smart phones (Galaxy S or Note series).
If you launch the app on a smart phone manufactured by other companies, some functions may operate differently.
- The Samsung Connect app may change without prior notice to improve product usability and performance.

Registering Samsung account

Log in with a Samsung account

- To use the Samsung Connect app, Samsung account is required. Log in the system following the instructions from the Samsung Connect app. You do not need to install an app.

NOTE

- If you have a Samsung smart phone account, log in with the account. If you are Samsung smart phone user, automatically log in followed.

Connecting the air conditioner to Samsung Connect app

- To control the air conditioner remotely, first connect the air conditioner to Samsung Connect app. Download and install the app, and then configure the settings by following the instructions on the screen.

Registering your air conditioner to the Samsung Connect app

- 1 Make sure your smart phone is connected to the wireless network. If not connected, launch the **Settings** app, select the **wireless network (Wi-Fi)** to On. And then select an AP to connect.
- 2 Launch the Samsung Connect app on your smart

phone.

- 3 When a pop-up window appears to indicate that a new device is found, touch **Add**.
 - When you run the Samsung Connect app, products other than the ones you want to connect to may be found if other Samsung Connect-compatible products exist in the surroundings. (Temporarily disconnect the power cables from products other than the ones you want to connect to.)
 - When pop-up window does not appear, touch "Add device" and then select a product to connect from the list.
- 4 Connect your product to the Samsung Connect app by following the instructions on your smart phone.

WARNING

- RF exposure warning statement – for keeping 20cm distance when installing this module.
- Warning that this module should not be installed and operating simultaneously with other radio without additional evaluation or FCC filing.
- Instruction for host system labeling, the host system should have proper label showing that it "Contains FCC ID : A3LSWL-B70F"
- Your device uses non-harmonised frequency and is intended for use in all European countries. The WLAN can be operated in the EU without restriction indoors, but cannot be operated outdoors in France.

Specifications

Wi-Fi	
Frequency Range	Transmitter Power(Max)
2412 - 2472 MHz	20 dBm

Controlling the air conditioner with Samsung Connect App

You can skillfully control the air conditioner.

Category	Function	Description
Monitoring	Set temperature	Displays the set temperature.
	Current temperature	Displays the current temperature.
Control	Power	Turns on or off the air conditioner.
	Mode	Selects the desired operation.
	Temperature	Adjusts the indoor set temperature.
	Fan Speed	Sets the fan speed of operation mode.
	Wind direction	Sets the fan directions of operation mode.
	Wind Free	Turns on or off the Wind Free function.
	Purity	Turns on or off the Purity function.
	Schedule	<p>Sets On or Off timer for each function.</p> <ul style="list-style-type: none"> The maximum number of schedule for On/Off timer function is 10. Set time for On timer and Off timer should be different. Once the On/Off timer is set, the setting remains even if you unplug the air conditioner and plug in it again.
	Options	<p>Selects an option function of operation mode.</p> <ul style="list-style-type: none"> The available options might be different depending on the air conditioner model. The fan speed and fan direction are set automatically according to the selected options. For detailed information on the options of the product, refer to the user manual.
	Settings	<p>Sets additional functions.</p> <ul style="list-style-type: none"> Press the Settings button on the control screen to check or set detailed information of air conditioner. The functions of Clean, Filter, Beep, My Wind, and Energy Monitor can be set. <ul style="list-style-type: none"> When the Beep function is off, the beep sound from the device will be mute.
About Device	<p>Selects a service function.</p> <ul style="list-style-type: none"> On About Device screen, you can use Version Info, Help Desk, Tutorial, and Self Check menus. 	

Troubleshooting

Before you make a call to Service center, be sure to check chart below because you will be charged for visits and consultations.

The Samsung Connect App is not searched on app market.

The Samsung Connect app supports Android OS 6.0 (mashmallow) or higher with third-party phones, Android OS 5.0 (lollipop) or higher with Samsung phones, and iOS 10.0 or higher.

After installing the Samsung Connect app, the air conditioner is not connected to the app.

Connect the air conditioner to a wireless router before using the app.

The SSID connection to the product is not made immediately.

If the connection is lost when the product is in AP mode, disable the "Smart network switch" function on your smart phone and try again.

The air conditioner is not connected to a wireless router.

Make sure that the SSID (name) of the wireless router is a combination of English and numeric characters. When the SSID contains any special characters, change its name.

The air conditioner is not connected at the server registration step.

After accessing the router settings page, disable the firewall of the router and try it again.

The country error occurred in the Samsung account during connection.

After being logged out, log in your previous Samsung account and the delete existing devices. Log in the system again with a new Samsung account and configure the settings.

A failure message appears while adding devices.

It may have failed temporarily due to obstacle or the distance from the place where the router is installed. Please try again later.

Turn off the air conditioner and then reconnect the power after 30 seconds. Then try again.

A guide message is appears on the Samsung Connect app screen.

Perform inspection by following the message.

Open Source Announcement

The software included in this product contains open source software. You may obtain the complete corresponding source code for a period of three years after the last shipment of this product by sending an email to <mailto:oss.request@samsung.com>.

It is also possible to obtain the complete corresponding source code in a physical medium such as a CD-ROM; a minimal charge will be required.

The following URL http://opensource.samsung.com/opensource/SMART_AT_051/seq/0 leads to the download page of the source code made available and open source license information as related to this product. This offer is valid to anyone in receipt of this information.



Safety Information on Installation

Carefully follow the precautions listed below because they are essential to guarantee the safety of both the air conditioner and the workers.

- Always disconnect the air conditioner from the power supply before servicing it or accessing its internal components.
- Verify that installation and testing operations are performed by qualified personnel.
- Verify that the air conditioner is not installed in an easily accessible area.

General information

- Carefully read the content of this manual before installing the air conditioner and store the manual in a safe place in order to be able to use it as reference after installation.
- For maximum safety, installers should always carefully read the following warnings.
- Store the operation and installation manual in a safe location and remember to hand it over to the new owner if the air conditioner is sold or transferred.
- This manual explains how to install an indoor unit with a split system with two SAMSUNG units. The use of other types of units with different control systems may damage the units and invalidate the warranty. The manufacturer shall not be responsible for damages arising from the use of non compliant units.
- The manufacturer shall not be responsible for damage originating from unauthorised changes or the improper connection of electric and requirements set forth in the "Operating limits" table, included in the manual, shall immediately invalidate the warranty.
- The air conditioner should be used only for the applications for which it has been designed: the indoor unit is not suitable to be installed in areas used for laundry.
- Do not use the units if damaged. If problems occur, switch the unit off and disconnect it from the power supply.
- In order to help prevent electric shocks, fires or injuries, always stop the unit, disable the protection switch and contact SAMSUNG's technical support if the unit produces smoke, if the power cable is hot or damaged or if the unit is very noisy.
- Always remember to inspect the unit, electric connections, refrigerant tubes and protections regularly. These operations should be performed by qualified personnel only.
- The unit contains moving parts, which should always be kept out of the reach of children.
- Do not attempt to repair, move, alter or reinstall the unit. If performed by unauthorised personnel, these operations may cause electric shocks or fires.
- Do not place containers with liquids or other objects on the unit.
- All the materials used for the manufacture and packaging of the air conditioner are recyclable.
- The packing material and exhaust batteries of the remote control (optional) must be disposed of in accordance with current laws.
- The air conditioner contains a refrigerant that has to be disposed of as special waste. At the end of its life cycle, the air conditioner must be disposed of in authorised centres or returned to the retailer so that it can be disposed of correctly and safely.

Installation of the unit

- **IMPORTANT:** When installing the unit, always remember to connect first the refrigerant tubes, then the electrical lines. Always disassemble the electric lines before the refrigerant tubes.
- Upon receipt, inspect the product to verify that it has not been damaged during transport. If the product appears damaged, **DO NOT INSTALL** it and immediately report the damage to the carrier or retailer (if the installer or the authorised technician has collected the material from the retailer.)
- After completing the installation, always carry out a functional test and provide the instructions on how to operate the air conditioner to the user.
- Do not use the air conditioner in environments with hazardous substances or close to equipment that release free flames to avoid the occurrence of fires, explosions or injuries.
- Our units must be installed in compliance with the spaces indicated in the installation manual to ensure either accessibility from both sides or ability to perform routine maintenance and repairs. The units' components must be accessible and that can be disassembled in conditions of

complete safety either for people or things. For this reason, where it is not observed as indicated into the Installation Manual, the cost necessary to reach and repair the unit (in safety, as required by current regulations in force) with slings, trucks, scaffolding or any other means of elevation won't be considered in-warranty and will be charged to end user.

- When installing the outdoor unit at the seaside, make sure that it is not directly exposed to sea breeze. If you cannot find an adequate place free from direct sea breeze, construct a protection wall or a protective fence.
 - Install the outdoor unit in a place (such as near buildings etc.) where it can be protected from sea breeze. Failure to do so may cause a damage to the outdoor unit.

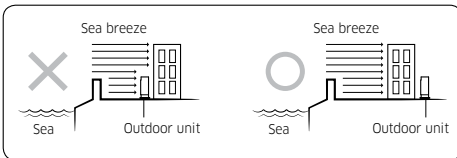

- If you cannot avoid installing the outdoor unit at the seaside, construct a protection wall around to block the sea breeze.
- Construct a protection wall with a solid material such as concrete to block the sea breeze. Make sure that the height and the width of the wall are 1.5 times larger than the size of the outdoor unit. Also, secure a space larger than 600 mm between the protection wall and the outdoor unit for exhausted air to ventilate.

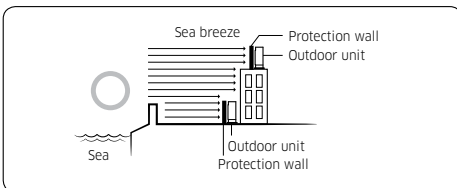

- Install the unit in a place where water can drain smoothly.
- If you have any difficulty finding installation location as prescribed above, contact your manufacturer for details.
- Be sure to clean the sea water and the dust on the

heat exchanger of the outdoor unit and apply a corrosion inhibitor on it. (At least once in a year.)

Power supply line, fuse, or circuit breaker

- Always make sure that the power supply is compliant with current safety standards. Always install the air conditioner in compliance with current local safety standards.
- Always verify that a suitable grounding connection is available.
- Verify that the voltage and frequency of the power supply comply with the specifications and that the installed power is sufficient to ensure the operation of any other domestic appliance connected to the same electric lines.
- Always verify that the cut-off and protection switches are suitably dimensioned.
- Verify that the air conditioner is connected to the power supply in accordance with the instructions provided in the wiring diagram included in the manual.
- Always verify that electric connections (cable entry, section of leads, protections...) are compliant with the electric specifications and with the instructions provided in the wiring scheme. Always verify that all connections comply with the standards applicable to the installation of air conditioners.
- Be sure not to perform power cable modification, extension wiring, and multiple wire connection.
 - It may cause electric shock or fire due to poor connection, poor insulation, or current limit override.
 - When extension wiring is required due to power line damage, refer to "Step 2.4 Optional: Extending the power cable" in the installation manual.

Preparation

Step 1.1 Choosing the installation location

Overview of installation location requirements

100 mm or more

125 mm or more

125 mm or more

Drain hose hole
You can select the direction of draining (left or right).

Maximum pipe height

Make at least one round to reduce noise and vibration.

Maximum pipe length

The actual units may look different from the images depicted here.

(Unit : m)

Model	Pipe length		Pipe height
	Minimum	Maximum	Maximum
10*** **12***** **13*****	3	15	8
18*** **19***** **24***** **25*****	3	30	15

Outdoor Unit

Outer wall

Indoor Unit

Cut insulation to have rainwater drained

CAUTION Make a U-trap (A) on the pipe (which is connected to the indoor unit) at outer wall and cut the bottom part of the insulation (about 10 mm) to prevent rainwater from getting inside through the insulation.

CAUTION

- Comply with the length and height limits described in the figure above.

Minimum clearances for the outdoor unit

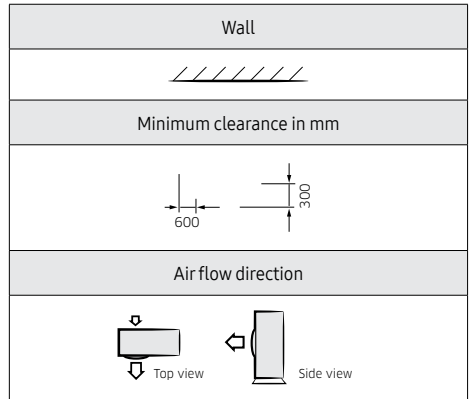

When installing 1 outdoor unit (6 cases)

(Unit: mm)

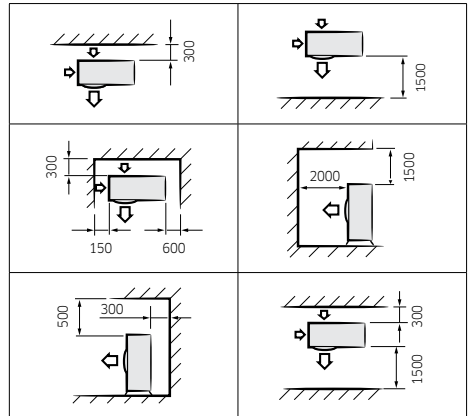

When installing more than 1 outdoor unit (5 cases)

(Unit: mm)

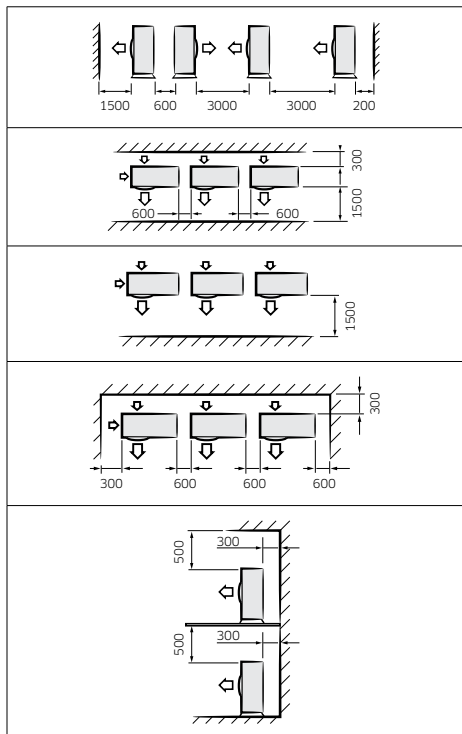

Step 1.2 Unpacking

Unpacking the indoor unit

- 1 Open the indoor unit package.
- 2 Remove the left and right cushions.
- 3 Pull out the unit from the package.

Unpacking the outdoor unit

- 1 Remove the package.
- 2 Remove the top cushion.
- 3 Pull out the unit from the bottom cushion.

Step 1.3 Checking and preparing accessories and tools

Accessories















Accessories in the indoor unit package

Installation plate (1) **10** **12** **13**	Installation plate (1) **18** **19** **24** **25**
Remote control (1)	Remote control holder (1)
Remote control battery (2)	User and Installation Manual (1)
M4 x 12 tapping screw (2)	Cap screw (2)

⚠ CAUTION

- If the outdoor unit is installed with any insufficient clearance, it may generate sound and affect the whole product.
- Be sure to install the outdoor unit in a level place where its vibration does not affect the whole product.

Optional accessories

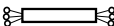
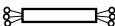
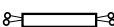
Insulated assembly pipe, Ø 6.35 mm (1)	Insulated assembly pipe, Ø 9.52 mm (1) **10***** **12***** **13*****
	
Insulated assembly pipe, Ø 12.70 mm (1) **18***** **19*****	Insulated assembly pipe, Ø 15.88 mm (1) **24***** **25*****
	
Pipe clamp B (3)	Pipe clamp A (3)
	
Drain Hose, 2 m long (1)	Foam Insulation (1)
	
Vinyl tape (2)	PE T3 foam tube insulation (1)
	
Putty 100 g (1)	Drain plug (1)
	
M4 x 25 tapped screw (6)	Cement nail (6)
	
3-wire Power Cable (1)	3-wire Assembly Cable (1)
	
2-wire Assembly Cable (1)	
	

Accessories in the outdoor unit package

Rubber leg (4)

NOTE

- A flare nut is attached to the end of each pipe of an evaporator or a service port. Use flare nuts when connecting the pipes.
- Wire assembly cables are optional. If they are not supplied, use standard cables.
- The drain plug and the rubber legs are included only when the air conditioner is supplied without assembly pipes.
- If these accessories are supplied, they are in the accessory package or outdoor unit package.

Tools

General tools

- Vacuum pump (Backward flowing prevention)
- Manifold gauge
- Stud finder
- Torque wrench
- Pipe cutter
- Reamer
- Pipe bender
- Spirit level
- Screwdriver
- Spanner
- Drill
- L-wrench
- Measuring tape

Tools for test operation

- Thermometer
- Resistance meter
- Electroscop

Step 1.4 Drilling a hole through the wall

Before fixing the installation plate to a wall and then fixing the indoor unit to the installation plate, a window frame, or a gypsum board, you must determine the position of a hole (with 65 mm inner diameter) through which the pipe bundle (consisting of power and communication cables, refrigerant pipes, and drain hose) will pass and then drill that hole.

- 1 Determine the position of a 65 mm hole in consideration of the possible directions of the pipe bundle and the minimum distances between the hole and the installation plate.

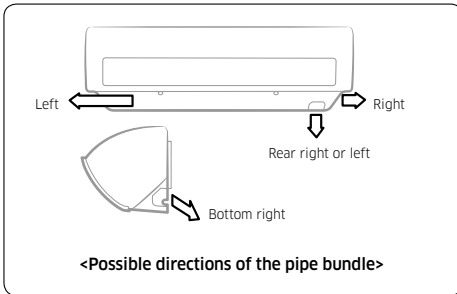

CAUTION

- If changing the pipe direction from left to right, do not drastically bent it but slowly turn it in the opposite direction as shown. Otherwise, the pipe may be damaged in the process.

(Unit : mm)

Model	A	B	C	D
10*** **12***** **13*****	36	120	81	36
18*** **19***** **24***** **25*****	33	110	110	33

Pipe bundle hole: \varnothing 65 mm

- 2 Drill the hole.

CAUTION

- Be sure to drill only one hole.
- Make sure that the hole slants downwards so that the drain hose slants downwards to drain water well.

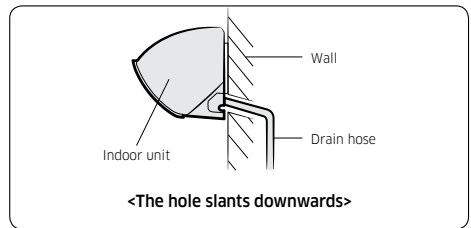

Step 1.5 Taping the pipes, cables, and drain hose

- 1 Wrap foam insulation on parts without insulation on the ends of the refrigerant pipes, as shown in the figure. This wrapping minimises condensation problem.

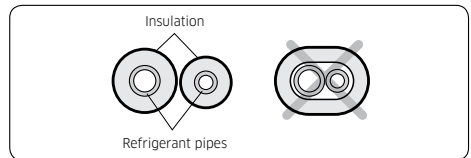

- 2 Wind the refrigerant pipes, power cable, communication cable and drain hose with vinyl tape to make a pipe bundle.

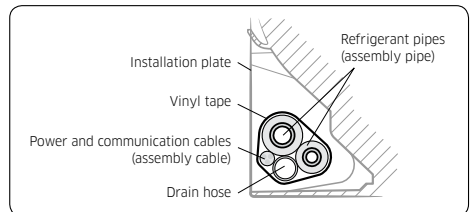

Indoor Unit Installation



Please scan this QR code for detail video of indoor unit installation.

Step 2.1 Disassembling the cover panel

- 1 Remove the cap screws, then the screws.

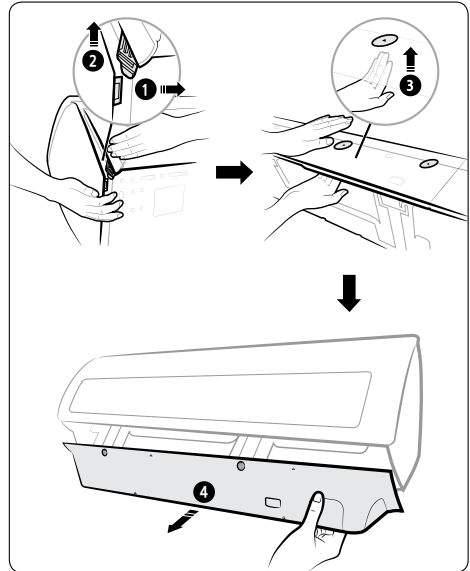
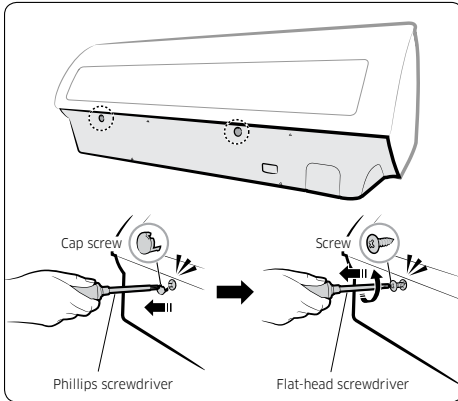

Step 2.2 Disassembling the installation plate

- 2 Unlock the side hooks (1, 2), then centre hooks (3). Then unlock the bottom hooks (4) to pull out the cover panel.

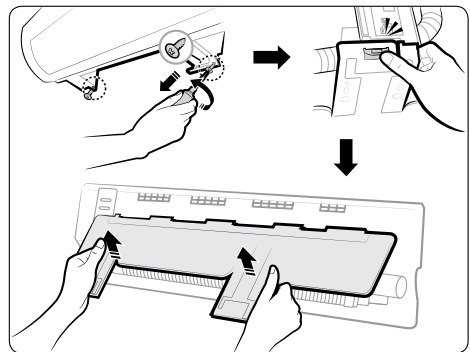
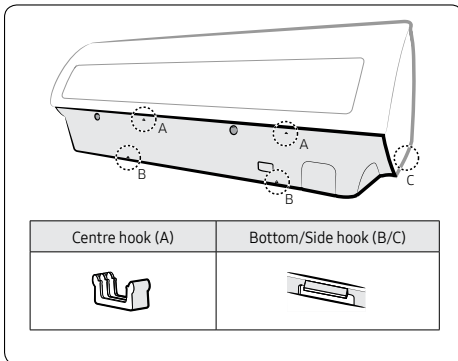

Step 2.3 Connecting the Power and communication cables (assembly cable)

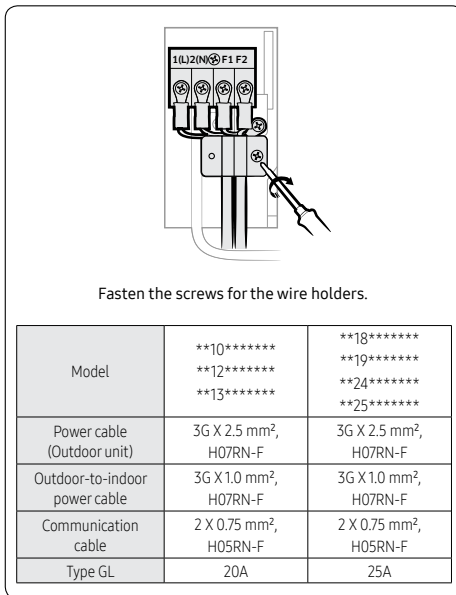
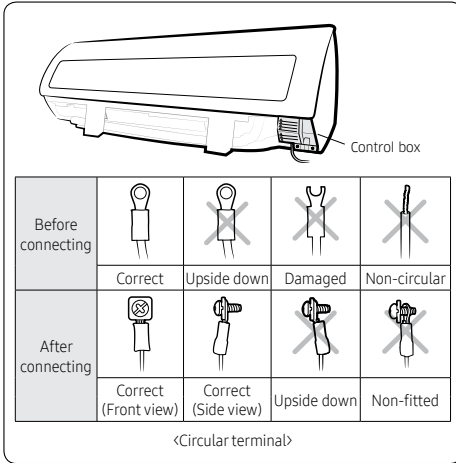

- When performing electrical and earthing works, be sure to comply with the 'technical standards of electrical installations' and the 'wiring regulations' in the local regulations.
- Tighten the terminal block screw to 1.2-1.8 N•m (1.2-1.8 kgf•cm).

NOTE

- Each wire is labelled with the corresponding terminal number.
- Use shield cable (Category 5; less than 50pF/m) for noisy environmental site.
- Power supply cords of parts of appliances for outdoor use shall not be lighter than polychloroprene sheathed flexible cord. (Code designation IEC: 60245 IEC66/CENELEC: H07RN-F, IEC: 60245 IEC57 CENELEC: H05RN-F, IEC: 60227 IEC53: H05VV-F)
- Power & Communication cable shall not exceed 30m.

CAUTION

- For the terminal block wiring, use a wire with a ring terminal socket only. Regular wires without a ring terminal socket may become a hazard due to overheating of the electrical contact during installation.
- If you need to extend the pipe, be sure to extend the cable, too.

(Unit : m)

Model	Cable (Maximum)
10*** **12***** **13***** **18***** **19***** **24***** **25*****	30





- Do not connect two or more different cables to extend the length. This connection may cause fire.
- Each circular terminal must match the size of its corresponding screw in the terminal block.
- After connecting the cables, make sure that terminal numbers on the indoor and outdoor units match.
- Ensure that power and communication cables are separated, they must not be in the same cable.

WARNING

- Connect the wires firmly so that wires cannot be pulled out easily. (If they are loose, it could cause burn-out of the wires.)

Step 2.4 Optional: Extending the power cable

1 Prepare the following tools.

Tools	Spec	Shape
Crimping pliers	MH-14	
Connection sleeve (mm)	20xØ7.0 (HxOD)	
Insulation tape	Width 18 mm	
Contraction tube (mm)	50xØ8.0 (LxOD)	

2 As shown in the figure, peel off the shields from the rubber or wire of the power cable.

- Peel off 20 mm of cable shields from the pre-installed tube.

CAUTION

- For information about the power cable specifications for indoor and outdoor units, refer to the installation manual.
- After peeling off cable wires from the pre-installed tube, insert a contraction tube.

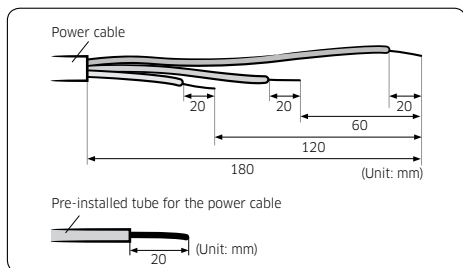

3 Insert both sides of core wire of the power cable into the connection sleeve.

- Method 1: Push the core wire into the sleeve from both sides.
- Method 2: Twist the wire cores together and push it into the sleeve.

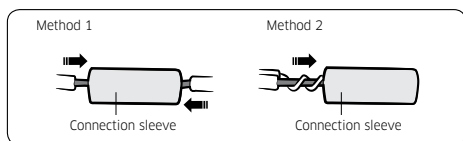

4 Using a crimping tool, compress the two points and flip it over and compress another two points in the same location.

- The compression dimension should be 8.0.

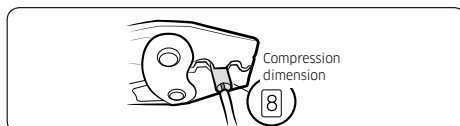

- After compressing it, pull both sides of the wire to make sure it is firmly pressed.

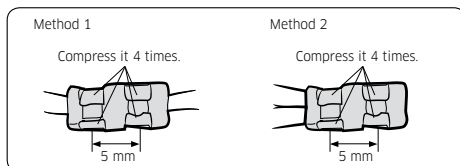

5 Wrap it with the insulation tape twice or more and position your contraction tube in the middle of the insulation tape. Three or more layers of insulation are required.

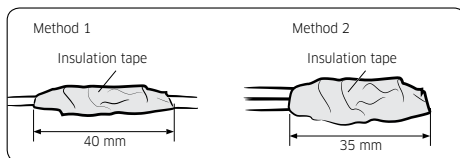

6 Apply heat to the contraction tube to contract it.

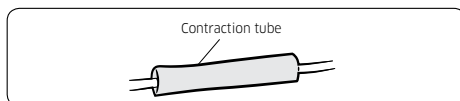

7 After tube contraction work is completed, wrap it with the insulation tape to finish.

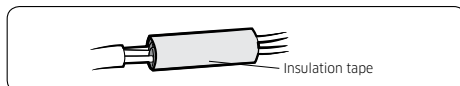

CAUTION

- Make sure that the connection parts are not exposed to outside.
- Be sure to use insulation tape and a contraction tube made of approved reinforced insulating materials that have the same level of withstand voltage with the power cable. (Comply with the local regulations on extensions.)

⚠ WARNING

- In case of extending the electric wire, please **DO NOT** use a round-shaped pressing socket.
 - Incomplete wire connections can cause electric shock or a fire.

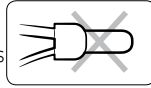

Step 2.5 Installing and connecting the drain hose

- 1 Install the drain hose.

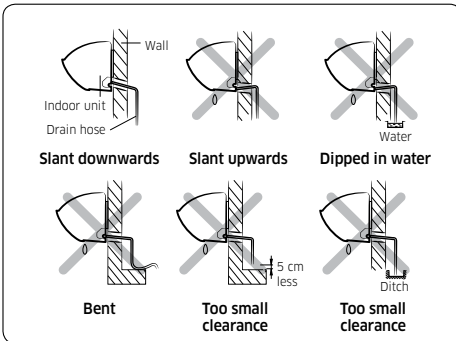
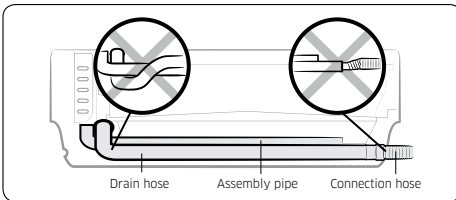

- 2 Pour water into the drain pan. Check whether the hose is well drained.

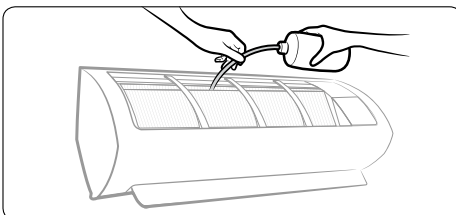

⚠ CAUTION

- Make sure that the indoor unit is in upright position when you pour water to check for leakage. Make sure that the water does not overflow onto the electrical part.
- If the diameter of the connection hose is smaller than the product's drain hose, water leakage may occur.
- Inadequate installation may cause water leakage.
- If the drain hose is routed inside the room, insulate the hose so that dripping condensation does not damage the furniture or floors.
- Do not box in or cover the drain hose connection. Drain hose connection must be easily accessible and serviceable.

Step 2.6 Optional: Extending the drain hose

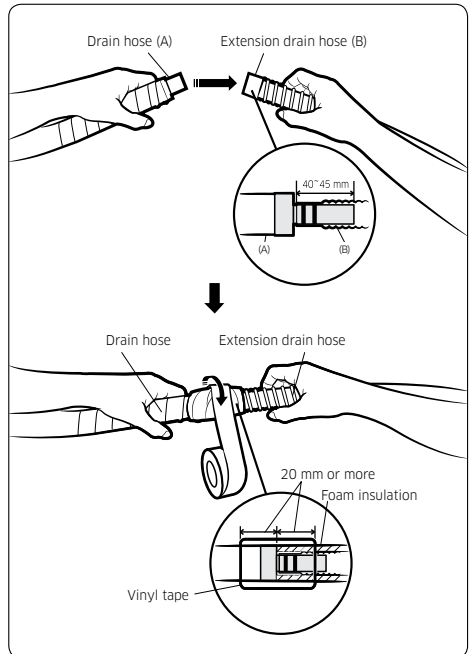

Step 2.7 Optional: Changing the direction of the drain hose

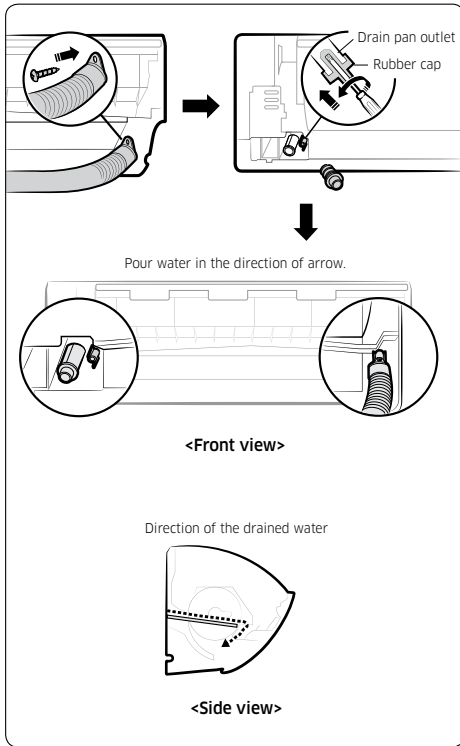

⚠ CAUTION

- Make sure that the indoor unit is in upright position when you pour water to check for leakage. Make sure that the water does not overflow onto the electrical part.

Step 2.8 Installing and connecting the assembly pipes to the refrigerant pipes (assembly pipe)

Connect indoor and outdoor units with field-supplied copper pipes by means of flare connections. Use insulated seamless refrigeration grade pipe only, (Cu DHP type according to ISO1337), degreased and deoxidized, suitable for operating pressures of at least 4200 kPa and for burst pressure of at least 20700 kPa. Under no circumstances must sanitary type copper pipe be used.

There are 2 refrigerant pipes of different diameters:

- The smaller one is for the liquid refrigerant
- The larger one is for the gas refrigerant

A short liquid refrigerant pipe and a short gas refrigerant pipe are already fitted to the air conditioner. The connection procedure for the refrigerant pipes varies according to the exit position of each pipe when facing the wall:

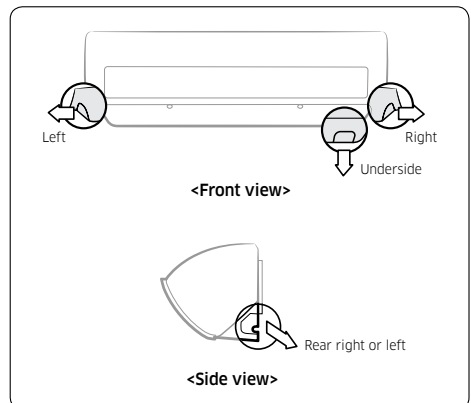

- 1 Cut out the appropriate knock-out piece (A, B, C) on the rear of the indoor unit unless you connect the pipe directly from the rear.
- 2 Smooth the cut edges.
- 3 Remove the protection caps of the pipes and connect the assembly pipe to each pipe. Tighten the nuts first with your hands, and then with a torque wrench, applying the following torque:

Outer diameter (mm)	Torque (N•m)	Torque (kgf•cm)
ø 6.35	14 to 18	140 to 180
ø 9.52	34 to 42	350 to 430
ø 12.70	49 to 61	500 to 620
ø 15.88	68 to 82	690 to 830

NOTE

- If you want to shorten or extend the pipes, see Step 2.9 Shortening or extending the refrigerant pipes (assembly pipe) on page 44.
- Cut off the remaining foam insulation.
 - If necessary, bend the pipe to fit along the bottom of the indoor unit. Then pull it out through the appropriate hole.
 - The pipe should not project from the rear of the indoor unit.
 - The bending radius should be 100 mm or more.
 - Pass the pipe through the hole in the wall.
 - Fix the indoor unit on the wall. Pass the cables, pipes and hose through the knock-out hole which would be connected to the outdoor unit.
 - Use 2 screws to fix the indoor unit as shown in the picture 2.
 - Assemble the Guide into the position of A or B as shown in the picture 3.

NOTE

- The pipe will be insulated and fixed permanently into position after finishing the installation and the gas leak test. For further details, see Step 4.1 Performing the gas leak tests on page 50.

CAUTION

- Tighten the flare nut with a torque wrench according to specified method. If the flare nut is over-tightened, the flare may break and cause refrigerant gas leakage.
- Do not box in or cover the pipe connection. All refrigerant pipe connection must be easily accessible and serviceable.

Step 2.9 Shortening or extending the refrigerant pipes (assembly pipe)

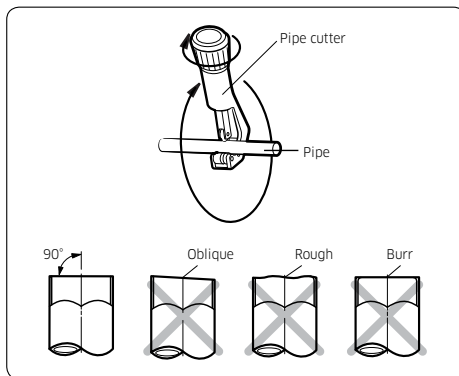

Diagram of a pipe flare with dimensions D, A, and L. It also shows a flare angle of $90 \pm 2^\circ$ and $45 \pm 2^\circ$, and a radius R of 0.4 to 0.8.

(Unit: mm)

Outer diameter (D)	Depth (A)	Flare dimension (L)
ø 6.35	1.3	8.7 to 9.1
ø 9.52	1.8	12.8 to 13.2
ø 12.70	2.0	16.2 to 16.6
ø 15.88	2.2	19.3 to 19.7

Diagram showing the connection of an indoor outlet pipe to a connecting pipe using a flare nut.

Outer diameter (mm)	Torque (N•m)	Torque (kgf•cm)
ø 6.35	14 to 18	140 to 180
ø 9.52	34 to 42	350 to 430
ø 12.70	49 to 61	500 to 620
ø 15.88	68 to 82	690 to 830

⚠ CAUTION

- If you need a pipe longer than specified in piping codes and standards, you must add refrigerant to the pipe. Otherwise, the indoor unit may freeze.
- While removing burrs, put the pipe face down to make sure that the burrs do not get in to the pipe.

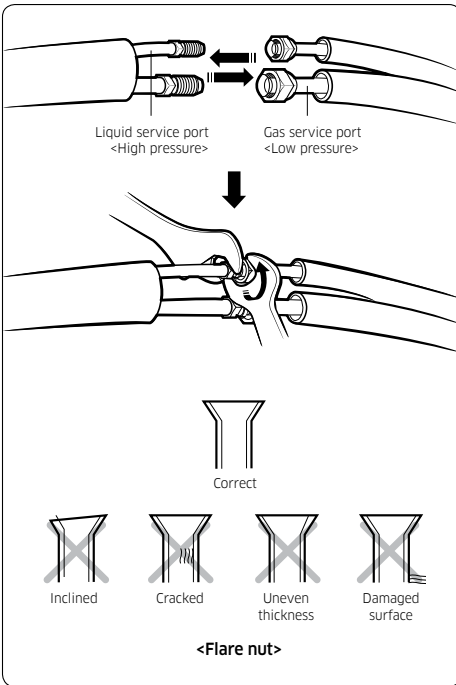

📖 NOTE

- Excessive torque may cause gas leakage. When extending the pipe with welding or brazing, ensure that nitrogen is used during the welding or brazing process. The joint must be accessible and serviceable.

⚠ CAUTION

- Tighten the flare nut at the specified torque. If the flare nut is over-tightened, it may break to cause leakage of refrigerant gas.

Step 2.10 Fixing the installation plate

You can install the indoor unit on a wall, window frame, or gypsum board.

⚠ WARNING

- Make sure that the wall, window frame, or gypsum board can withstand the weight of the indoor unit. If you install the indoor unit in a place where it is not strong enough to withstand the unit's weight, the unit could fall and cause injury.

When fixing the indoor unit on a wall

Fix the installation plate to the wall giving attention to the weight of the indoor unit.

(Unit : mm)

Model	A	B	C	D
10 **12** **13**	36	120	81	36
18 **19** **24** **25**	33	110	110	33

Pipe bundle hole: Ø 65 mm

📖 NOTE

- If you mount the plate to a concrete wall using plastic anchors, make sure that gaps between the wall and the plate, created by projected anchor, is less than 20 mm.

When fixing the indoor unit on a window frame

- 1 Determine the positions of the wooden uprights to be attached to the window frame.
- 2 Attach the wooden uprights to the window frame giving attention to the weight of the indoor unit.
- 3 Attach the installation plate to the wooden upright using tapping screws.

When fixing the indoor unit on a gypsum board

- 1 Use stud finder to find out locations of the studs.
- 2 Fix the plate hanger on two studs.

CAUTION

- If you fix the indoor unit on a gypsum board, use only specified anchor bolts on reference positions. Otherwise, the gypsum surrounding the joints may crumble over time and cause the screws to be loosened and stripped. This may lead to physical injury or equipment damage.
- Search for other spots if there are less than two studs, or the distance between the studs are different from the plate hanger.
- Fix the installation plate without inclining to one side.

Step 2.11 Fixing the indoor unit to the installation plate

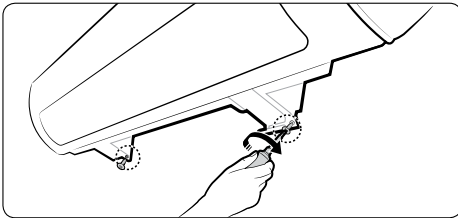

CAUTION

- Make sure that the pipe bundle does not move when you install the indoor unit onto the installation plate.

Step 2.12 Assembling the cover panel

- 1 Lock the side hooks (D), then centre hooks (B). Then lock the bottom hooks (C) to engage the cover panel in place.
- 2 Fasten the screw (A-①), then assemble the cap screws (A-②).

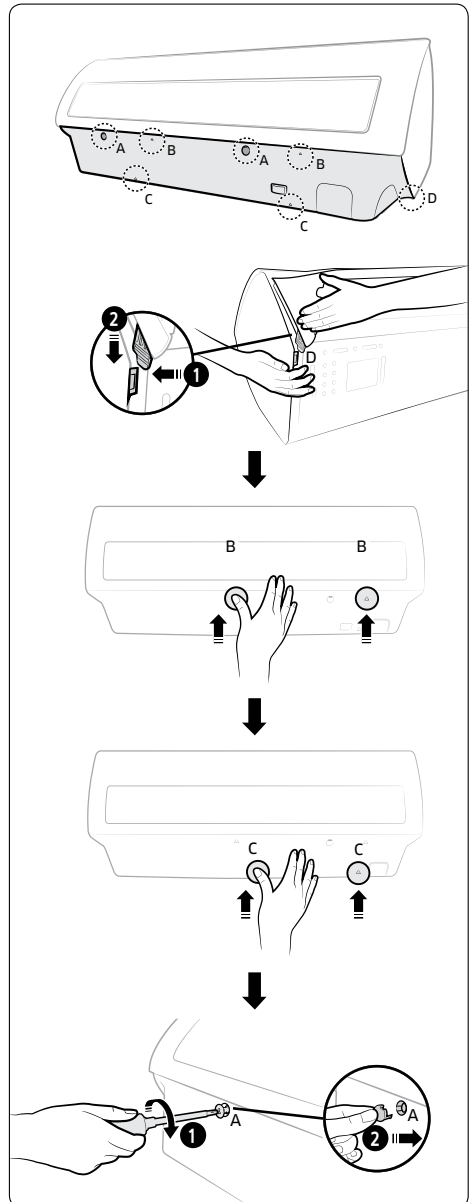

Outdoor Unit Installation

Step 3.1 Fixing the outdoor unit in place

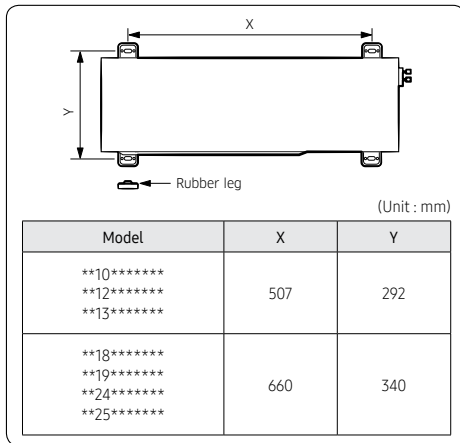

- 1 Place the outdoor unit as directed on the top of the unit to let the discharged air out properly.
- 2 Fix the outdoor unit in level to an appropriate support using anchor bolts.

NOTE

- Secure the rubber legs to help prevent the generation of noise and vibration.
- If the outdoor unit is exposed to strong winds, install shield plates around the outdoor unit so that the fan can operate correctly.

Optional: Fixing the outdoor unit to a wall with a rack

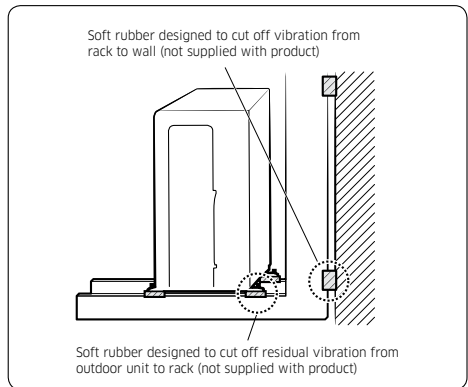

NOTE

- Make sure that the wall can support the weights of the rack and the outdoor unit.
- Install the rack close to the column as much as possible.

Step 3.2 Connecting the power and communication cables and the refrigerant pipes

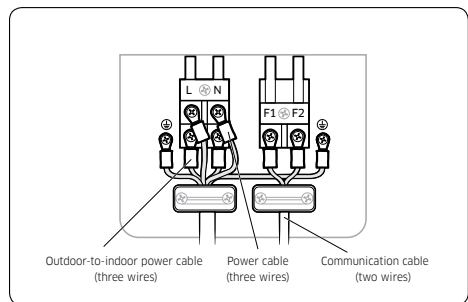

CAUTION

- Be sure to fix the power cables and communication cable with a cable clamp.

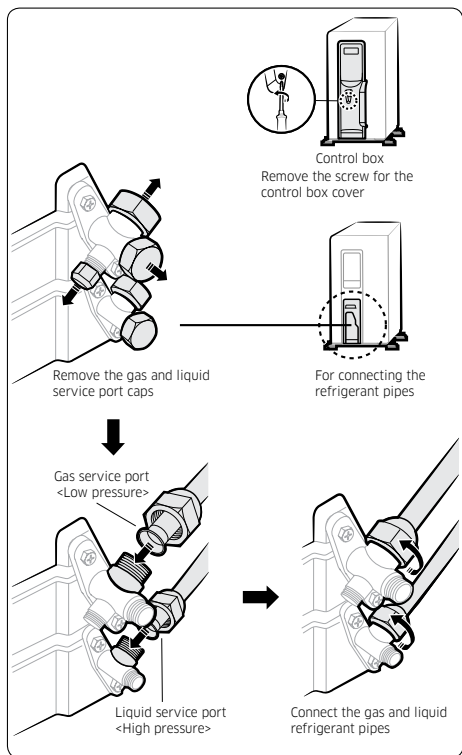

Step 3.3 Evacuating the air

The outdoor unit is loaded with sufficient R-410A refrigerant. Do not vent R-410A into atmosphere: it is a fluorinated greenhouse gas, covered by Kyoto Protocol, with a Global Warming Potential (GWP) = 2088. You should evacuate the air in the indoor unit and in the pipe. If air remains in the refrigerant pipes, it affects the compressor. It may cause reduction of cooling capacity and malfunction. Use a vacuum pump.

⚠ CAUTION

- When installing, make sure there is no leakage. When recovering the refrigerant, ground the compressor first before removing the connection pipe. If the refrigerant pipe is not properly connected and the compressor works with the stop valve open, the pipe inhales the air and it makes the pressure inside of the refrigerant cycle abnormally high. It may cause explosion and injury.

1 Leave the system in the standby mode.

⚠ WARNING

- Do not turn on the system! This is necessary for better vacuum operation (full OPEN position of Electronic Expansion Valve).
- 2 Connect the charging hose of the low pressure side of manifold gauge to a gas service port as seen in the picture.

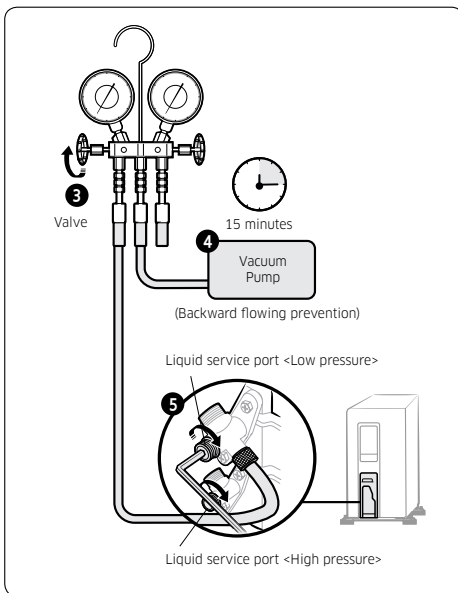

- 3 Open the valve of the low pressure side of manifold gauge anticlockwise.
- 4 Evacuate the air in the connected pipes using the vacuum pump for about 15 minutes.
 - Make sure that pressure gauge shows -0.1 MPa (-76 cmHg, 5 torr) after about 10 minutes. This procedure is very important to avoid a gas leak.
 - Close the valve of the low pressure side of manifold gauge clockwise.
 - Turn off the vacuum pump.
 - Check for 2 minutes if there is any pressure change.
 - Remove the hose of the low pressure side of manifold gauge.
- 5 Set a valve cork of liquid and gas service port to the open position.

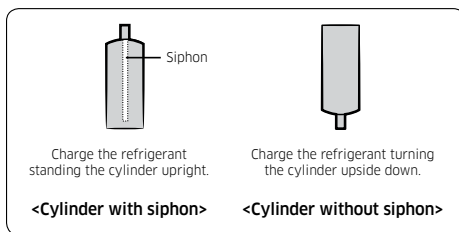

NOTE

- If R-410A refrigerant is charged with gas, the composition of the charged refrigerant changes and the characteristics of the equipment vary.
- During the measuring operation of refrigerant quantity added, use electronic scales. If cylinder doesn't have siphon, upset it.

Step 3.4 Adding refrigerant

If you use a pipe longer than the length specified in the piping codes and standards, you must add 15g of refrigerant R-410A for each extra metre. If you use a pipe shorter than the length specified in the piping codes and standards, the evacuating time is normal. Refer to the Service Manual for further details.

CAUTION

- The remaining air in the Refrigeration cycle, which contains moisture, may cause malfunction of the compressor.
- Always contact the service centre or a professional installation agency for product installation.

R-410A is a mixed type of refrigerant. It is necessary for recharging under conditions of liquid. When recharging refrigerant from the refrigerant cylinder to the equipment, take the following instructions: Before recharging, check whether the cylinder has a siphon or not. There are two ways to recharge the refrigerant:

Installation Inspection

Step 4.1 Performing the gas leak tests

- 1 Before inspecting the leakage, use a torque wrench to close the cap for the stop valve. (Comply with a tightening torque for each size of the diameter, and tighten the cap firmly to prevent any leakage.)

Tightening torque for charging port cap (Refer to the table)

Outer diameter (mm)	Tightening torque	
	Body cap (N•m)	Charging port cap (N•m)
ø 6.35	20 to 25	10 to 12
ø 9.52	20 to 25	
ø 12.70	25 to 30	
ø 15.88	30 to 35	
Over ø 19.05	35 to 40	

(1 N•m = 10 kgf•cm)

- 2 Insert inert gas into the pipes connected to indoor and outdoor units.
- 3 Test leakage on the connection parts of the indoor and outdoor units with soap lather or liquid.

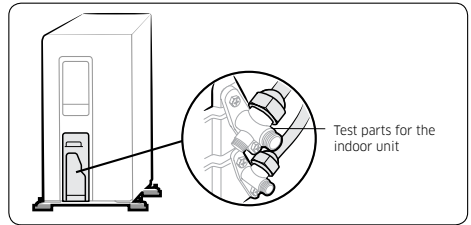
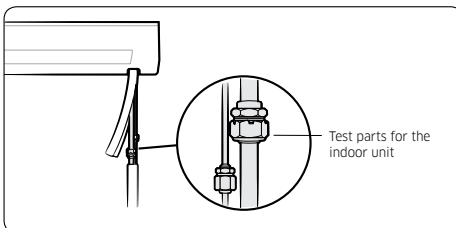

Step 4.2 Running the Smart Install mode

- 1 Make sure that the air conditioner is in the standby status.
- 2 Hold down the (Power), (Mode), and (SET / Temperature type (°C↔°F)) buttons on the remote control simultaneously for 4 seconds.
- 3 Wait until Smart Install mode succeeds or fails. It takes approximately 7 to 13 minutes.
 - While Smart Install mode is proceeding:



Type	Display	LED Display
Indoor unit indicator	 The progress is displayed as a number between 0 and 99 on the indoor unit display.	 The LEDs on the indoor unit display blink in sequence, then all of them blink simultaneously. These operations repeat.

- When Smart Install mode succeeds: Smart Install mode ends with ringing sound, and the air conditioner is in standby status.
- When Smart Install mode fails: An error message is displayed on the indoor unit display, and Smart Install mode ends.

NOTE





- Smart Install mode can be operated only with the supplied remote control.
- During the Smart install mode procedure, remote control cannot be operated.

When error occurs, take necessary measures by referring to the following table. For more information on necessary measures for errors, refer to the service manual.

Error indicator				Error	Measures for the installer to take
88 Display	LED Display				
	LED 1	LED 2	LED 3		
					
E 101	○	◐	◐	Communication error between indoor and outdoor units	<ul style="list-style-type: none"> Check the connection wire between the indoor and outdoor units (whether the power cable or communication cable is crossed or not).
E 121	○	◐	○	Error on indoor temperature sensor	<ul style="list-style-type: none"> Check the connection of the connector.
E 122 E 123	◐	◐	○	Error on indoor heat exchanger	<ul style="list-style-type: none"> Check the connection of the connector.
E 154	○	○	◐	Error on indoor fan motor	<ul style="list-style-type: none"> Check the connection of the connector. Remove foreign substance. (Check for the cause that restrains motor.)
88 display and all LEDs blink. E 162 E 163	◐	◐	◐	EEPROM/Option error	<ul style="list-style-type: none"> Re-set options.
E422	●	○	◐	Refrigerant flow blocking error	<ul style="list-style-type: none"> Check if the stop valve is completely open. Check if there is any blockage in the refrigerant pipe which connects the indoor and outdoor units. Check for refrigerant leak.
E554	●	○	◐	Lack of refrigerant (for inverter models only)	<ul style="list-style-type: none"> Check if a sufficient amount of refrigerant is additionally charged for the pipe longer than specified in piping codes and standards. Check for refrigerant leak between valve and pipe connection.
	* This LED pattern appears when an error occurs on the outdoor unit.				

* ○ : Off, ◐ : Blinking, ● : On

Step 4.3 Performing final check and trial operation



- 1 Check the following:
 - Strength of the installation site
 - Tightness of pipe connection to detect gas leak
 - Electric wiring connection
 - Heat-resistant insulation of the pipe
 - Drainage
 - Grounding conductor connection
 - Correct operation (Take the following steps.)
- 2 Press the  (Power) button on the remote control to check the following:
 - The indicator on the indoor unit lights up.
 - The airflow blade opens and the fan gears up for operation.
- 3 Press the  (Mode) button to select Cool or Heat mode. Then take the following sub-steps:
 - In Cool mode, use the Temperature button to set the set temperature to 16 °C.
 - In Heat mode, use the Temperature button to set the set temperature to 30 °C.
 - Check whether, approximately 3 to 5 minutes later, the outdoor unit starts, and a cool or warm air blows out.
 - After 12 minutes of stationary condition, check the indoor unit air treatment.
- 4 Press the  (Air swing) button to check whether the airflow blades work properly.
- 5 Press the  (Power) button to stop the trial operation.

Pumping down for removing the product

Pump-down is an operation intended to collect all the system refrigerant in the outdoor unit. This operation must be carried out before disconnecting the refrigerant tubing in order to avoid refrigerant loss to the atmosphere.

WARNING

- After installing the product, be sure to perform leak tests on the piping connections. After pumping down refrigerant to inspect or relocate the outdoor unit, be sure to stop the compressor and then remove the connected pipes.
 - Do not operate the compressor while a valve is open due to refrigerant leakage from a pipe or an unconnected or incorrectly connected pipe. Failure to do so may cause air to flow into the compressor and too a high pressure to develop inside the refrigerant circuit, leading to an explosion or product malfunction.

- 1 Hold down the  (Power) button on the indoor unit for 5 seconds. Beep sounds immediately to indicate that the product is ready for pump down procedure.
- 2 Let the compressor run for more than 5 minutes.
- 3 Release the valve caps on High and Low pressure side.
- 4 Use L-wrench to close the valve on the high pressure side.
- 5 After approximately 1 minute, close the valve on the low pressure side.
- 6 Stop operation of the air conditioner by pressing the  (Power) button on the indoor unit or remote control.
- 7 Disconnect the pipes.

CAUTION

- Compressor damage may occur if the compressor is run at a negative suction pressure.

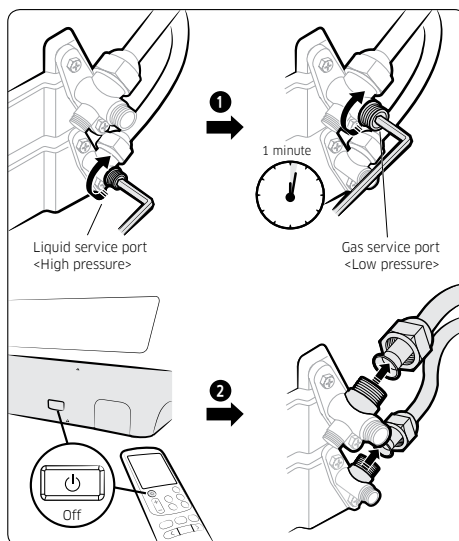

QUESTIONS OR COMMENTS?

COUNTRY	CALL	OR VISIT US ONLINE AT
JORDAN	0800-22273 06 577444	www.samsung.com/levant
MOROCCO	080 100 22 55	www.samsung.com/n_africa/support
IQAQ	80010080	www.samsung.com/levant/support

