



SPLIT-TYPE AIR CONDITIONERS

English

OPERATING INSTRUCTIONS

MSZ-A09NA
MSZ-A12NA
MSZ-A15NA
MSZ-A17NA



For customers

Thank you very much for purchasing this Mitsubishi room air conditioner.

- To use this unit correctly and safely, be sure to read this operating instructions before use. Keep this manual carefully for later reference.
- Be sure to receive a guarantee card from your dealer and check that the purchased date and shop name, etc. are entered correctly.
- This air conditioner should not be installed by the customer. (Safety and performance functions cannot be assured.)



CONTENTS

SAFETY PRECAUTIONS	2
NAME OF EACH PART	3
PREPARATION BEFORE OPERATION	4
AUTO CHANGEOVER... AUTO MODE OPERATION	6
MANUAL OPERATION (COOL, DRY, HEAT).....	7
AIR FLOW VELOCITY AND DIRECTION ADJUSTMENT	7
POWERFUL OPERATION	9
ECONO COOL OPERATION	9
TIMER OPERATION (ON/OFF TIMER)	10
WHEN THE AIR CONDITIONER IS NOT GOING TO BE USED FOR A LONG TIME	10
MAINTENANCE	10
CLEANING THE FRONT PANEL	11
CLEANING THE AIR FILTER (CATECHIN)	11
CLEANING THE AIR CLEANING FILTER.....	12
REPLACEMENT OF THE AIR CLEANING FILTER	12
BEFORE CONTACTING THE SERVICE REPRESENTATIVE, CHECK THE FOLLOWING AGAIN	13
WHEN YOU THINK THAT TROUBLE HAS OCCURRED	13
INSTALLATION, RELOCATION AND INSPECTION	14







SAFETY PRECAUTIONS

- Since rotating parts and parts which could cause an electric shock are used in this product, be sure to read these "Safety Precautions" before use.
- Since the cautionary items shown here are important for safety, be sure to observe them.
- Stop using the air conditioner and consult your dealer in case any troubles or abnormality occurs.

Marks and their meanings

-  **WARNING:** Incorrect handling could cause a serious hazard, such as death, serious injury, etc. with a high probability.
-  **CAUTION:** Incorrect handling could cause a serious hazard depending on the conditions.





Meanings of symbols used in this manual

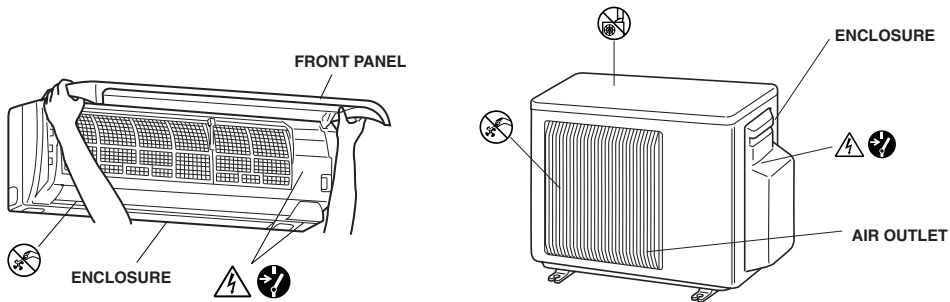

-  : Be sure not to do.
 -  : Be sure to follow the instruction.
 -  : Never insert your finger or stick, etc.
 -  : Never step onto the indoor/outdoor unit and do not put anything on them.
 -  : Danger of electric shock. Be careful.
 -  : Be sure to shut off the power.
- After reading this manual, keep it together with the installation manual in a handy place for easy reference.

Warning positions



- This air conditioner is NOT intended for use by children or infirm persons without supervisions.

 WARNING	
	<p>Do not use intermediate connection of the power supply cord or the extension cord and do not connect many devices to one AC outlet.</p> <ul style="list-style-type: none"> • A fire or an electric shock may result from poor contact, poor insulation, exceeding the permissible current, etc.
	<p>Do not scratch or process the power supply cord, etc.</p> <ul style="list-style-type: none"> • Do not put heavy object on the power supply cord and do not scratch or process the cord. The cord may be damaged and this may cause a fire or an electric shock.
	<p>Do not turn the breaker off/on during operation.</p> <ul style="list-style-type: none"> • This may cause a fire due to spark, etc. • Be sure to turn off the breaker absolutely after switching the indoor unit off with the remote controller.
	<p>Do not expose your skin directly to cool air for a long time.</p> <ul style="list-style-type: none"> • This could damage your health.
	<p>Installation, repairs or relocation should not be done by the customer.</p> <ul style="list-style-type: none"> • If this is done incorrectly, it may cause a fire, an electric shock, or injury from the unit falling, water leaking, etc. Consult your dealer. • If the power supply cord is damaged, it must be replaced by the manufacturer or its service agent in order to avoid a hazard.
 	<p>Do not insert your finger or a stick, etc. into the air inlet/outlet.</p> <ul style="list-style-type: none"> • Since the fan rotates at high speed, this may cause an injury. • Young children should be supervised to ensure that they do not play with the air conditioner.
	<p>When an abnormality (burning smell, etc.) occurs, stop the air conditioner and turn off the breaker.</p> <ul style="list-style-type: none"> • If the unit continues to be operated in an abnormal condition, it may cause a fire, trouble, etc. In this case, consult your dealer.

 CAUTION	
	<p>When the air filter is to be removed, do not touch the metal parts of the indoor unit.</p> <ul style="list-style-type: none"> • This may cause an injury.
	<p>Do not touch the air inlet or aluminum fin of the outdoor unit.</p> <ul style="list-style-type: none"> • This may cause an injury.
	<p>Do not put a vase or glass on the indoor unit.</p> <ul style="list-style-type: none"> • Water dropping into the indoor unit may deteriorate the insulation, causing electric shock.
	<p>Do not use an insecticide or flammable spray.</p> <ul style="list-style-type: none"> • This may cause a fire or deformation of the cabinet.
	<p>Do not put a pet or houseplant where it will be exposed to direct airflow.</p> <ul style="list-style-type: none"> • This could injure the pet or plant.
	<p>Do not place other electric appliances or furniture under the indoor/outdoor unit.</p> <ul style="list-style-type: none"> • Water may drip down from the unit, and this may cause damage or malfunction to them.
	<p>Do not leave the unit on an installation stand which is damaged.</p> <ul style="list-style-type: none"> • The unit may fall and this may cause an injury.
	<p>Do not step onto an unstable bench when maintaining the unit, etc.</p> <ul style="list-style-type: none"> • This may cause an injury, etc. if you fall down.
	<p>Do not pull the power supply cord.</p> <ul style="list-style-type: none"> • The core wire of the power supply cord may be disconnected and this may cause a fire.
	<p>Do not charge or disassemble the batteries and do not throw them into a fire.</p> <ul style="list-style-type: none"> • This may result in leakage, fire or an explosion.
	<p>Do not operate the unit for a long time in high humidity, e.g. leaving a door or window open.</p> <ul style="list-style-type: none"> • In the cooling mode, if the unit is operated in a room with high humidity (80% RH or more) for a long time, water condensed in the air conditioner may drop and wet or damage furniture, etc.

SAFETY PRECAUTIONS

⚠ CAUTION

⊘	Do not operate the unit at low outside temperature (less than 14°F) in the cooling mode.
	<ul style="list-style-type: none"> In the cooling mode, if the unit is operated at low outside temperature (less than 14°F), water condensed in the air conditioner may drop and wet or damage furniture, etc.
	Do not use the unit for special purposes.
!	<ul style="list-style-type: none"> Do not use this air conditioner to preserve precision devices, food, animals, plants and art objects. This may cause deterioration of quality, etc.
	Do not put a stove, etc. where they are exposed to direct airflow.
	<ul style="list-style-type: none"> This may cause imperfect combustion.
	When the unit is to be cleaned, switch it off and turn off the breaker.
	<ul style="list-style-type: none"> Since the fan rotates at high speed during operation, this may cause an injury.
⚡	When the unit is not going to be used for a long time, turn off the breaker.
	<ul style="list-style-type: none"> Otherwise, dirt may collect and this may cause a fire.
	Replace the 2 batteries of the remote controller with new ones of same type.
	<ul style="list-style-type: none"> Using an old battery together with a new one may result in heat generation, leakage or an explosion.
⚠	If liquid from the batteries gets onto your skin or clothes, wash it well with clean water.
	<ul style="list-style-type: none"> If liquid from the batteries gets into your eyes, wash them well with clean water and consult a doctor at once.
⚡	Ventilate well in using the unit with a stove, etc.
	<ul style="list-style-type: none"> An oxygen shortage may occur.
⚡	Do not operate switches with wet hands.
	<ul style="list-style-type: none"> This may cause an electric shock.
⚡	Do not clean the air conditioner with water or put a vase or glass on it.
	<ul style="list-style-type: none"> Water may enter the unit and degrade the insulation. This may cause an electric shock.
⊘	Do not step or put anything on the indoor/outdoor unit.
	<ul style="list-style-type: none"> This may cause an injury, etc. if you or something falls down.

For installation

⚠ WARNING

⊘	<ul style="list-style-type: none"> Consult your dealer for installation of the air conditioner. Since special techniques and work are required, installation should not be done by the customer. If this is done incorrectly, it may cause a fire, an electric shock, injury or water leaking.
	Do not install the unit where flammable gas could leak.
	<ul style="list-style-type: none"> If gas leaks and collects around the unit, it may cause an explosion.

⚠ CAUTION

!	Ground the unit.
	<ul style="list-style-type: none"> Do not connect the ground to a gas pipe, water pipe, lightning rod or the ground of a telephone. If the grounding is incorrect, it may cause an electric shock.
	Install a Ground Fault Interrupt (GFI) circuit breaker depending on the place where the air conditioner is to be installed (humid places, etc.).
	<ul style="list-style-type: none"> If the Ground Fault Interrupt (GFI) circuit breaker is not installed, it may cause an electric shock.
!	Drain should be fully drained.
	<ul style="list-style-type: none"> If the drainage route is incomplete, water may drop from the unit. This may wet and damage the furniture.

NAME OF EACH PART

Indoor unit

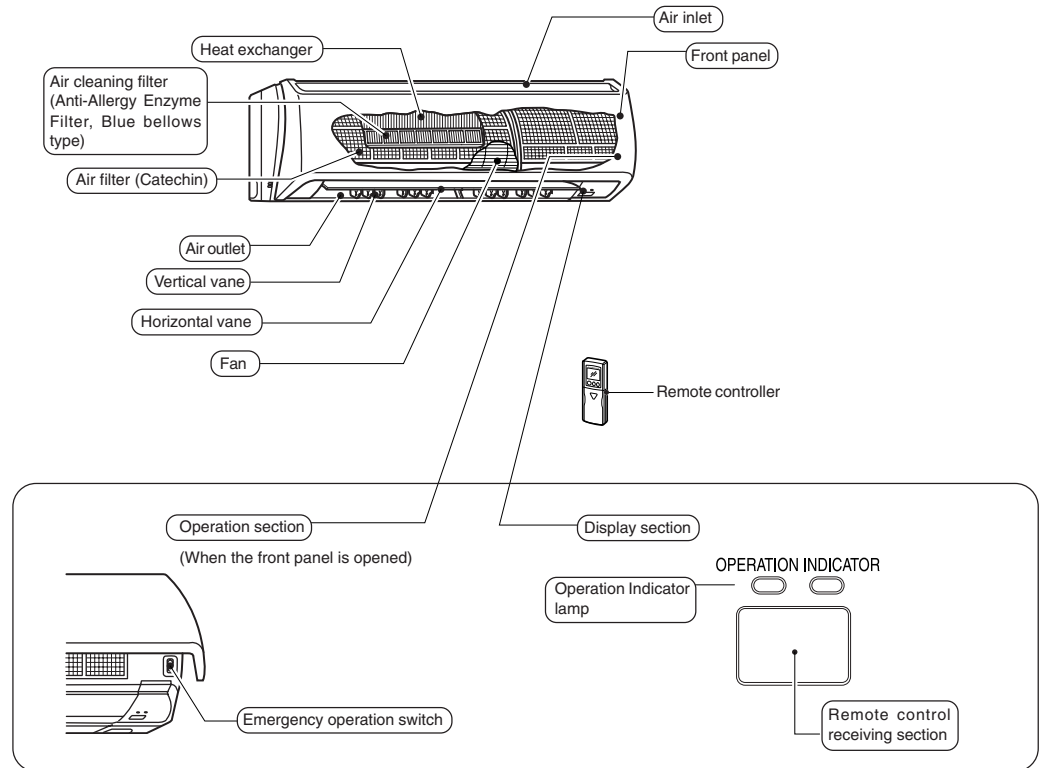

Outdoor unit

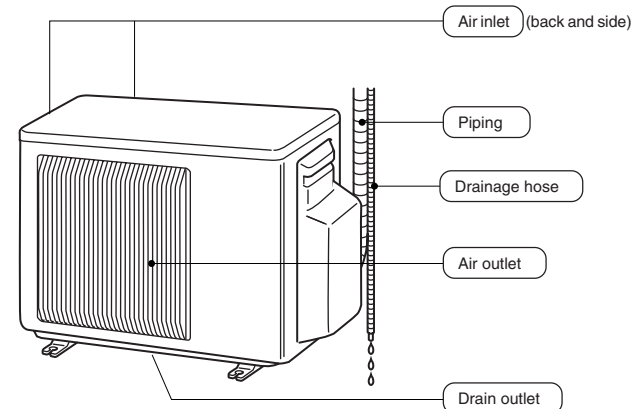

NAME OF EACH PART

Remote controller

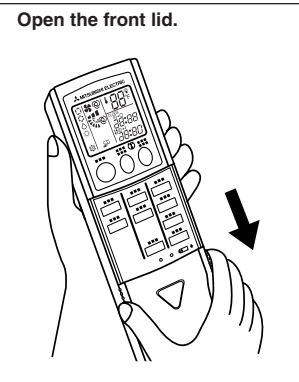
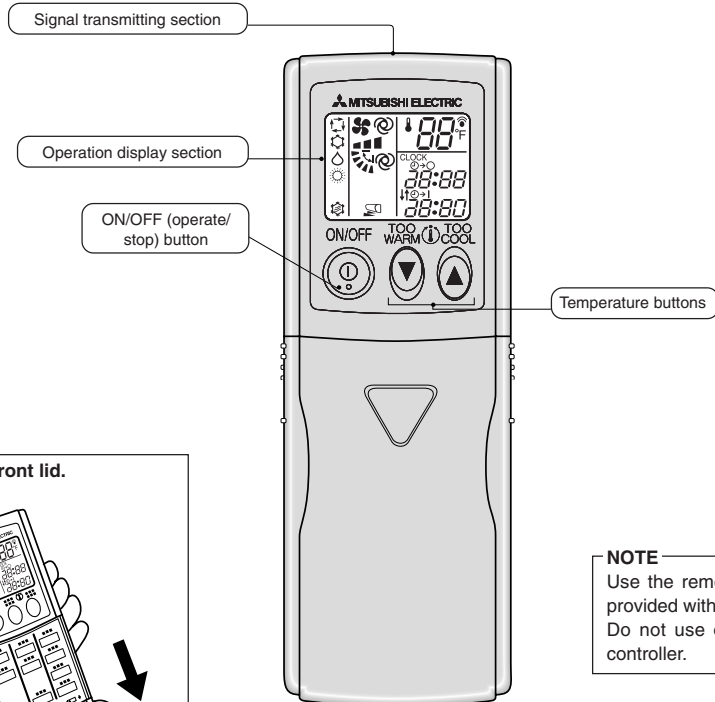

(This diagram shows an overall view.)

NOTE
Use the remote controller provided with the unit only. Do not use other remote controller.

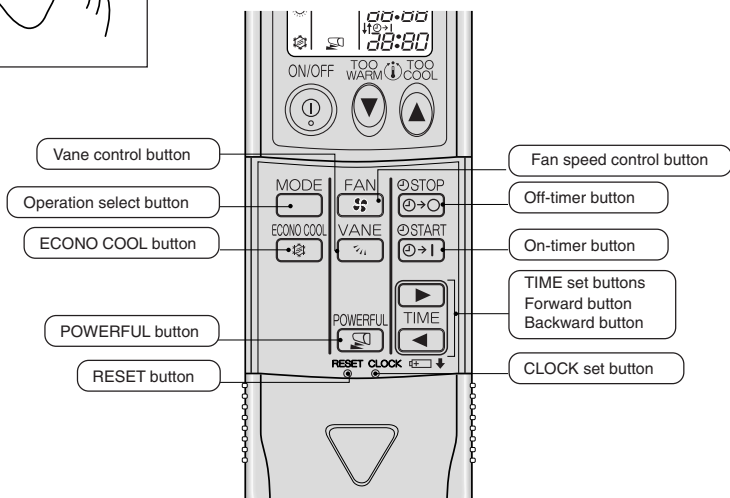

PREPARATION BEFORE OPERATION

Auto restart function

These models are equipped with an auto restart function. If you do not want to use this function, please consult the service representative because the setting of the unit needs to be changed.

Auto restart function is ...

When the indoor unit is controlled with the remote controller, the operation mode, the set temperature and the fan speed are stored in the memory. If a power failure occurs or the main power is turned off during operation, "Auto restart function" sets automatically to start operating in the same mode as the one set with the remote controller just before the shutoff of the main power. (Refer to page 6 for details.)

Breaker for the air conditioner

Turn the breaker on.

PREPARATION BEFORE OPERATION

Remote controller

How to set the batteries and the current time

- 1 Remove the front lid and insert batteries. Then reattach the front lid.

Insert the minus pole of the batteries first. Check if the polarity of the batteries is correct.

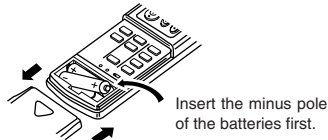

- 2 Press the RESET button.

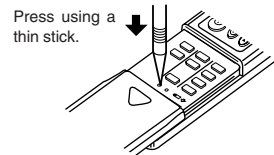

- If the RESET button is not pressed, the remote controller may not operate correctly.
- Be sure to press the RESET button not too strongly.

- 3 Press the CLOCK set button.

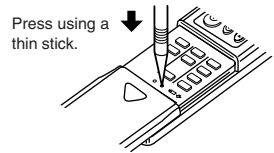

- 4 Press the (Forward) and (Backward) buttons (TIME SET buttons) to set the current time.

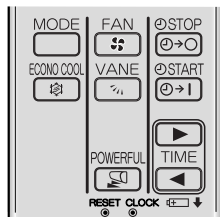

- Each time the button is pressed, the set time increases by 1 minute, and each time the button is pressed, the set time decreases by 1 minute.
- Pressing those buttons longer increases/decreases the set time by 10 minutes.

- 5 Press the CLOCK set button again and close the front lid.

Handling of the remote controller

- The range that the signal can reach is about 20 ft. when the remote controller is pointed at the front of the indoor unit.
- When a button is pressed, one or two beeps will be heard from the indoor unit. If no sound is heard, operate again.
- Use the remote controller carefully. If it is dropped, thrown or it gets wet, the remote controller may not operate.

When installing on a wall, etc.

- Install the remote controller holder in a position where the signal reception sound (beep) can be heard from the indoor unit when the button is pressed.

How to install/remove the remote controller

Installing :Insert the remote controller downward.
Removing :Pull it up.

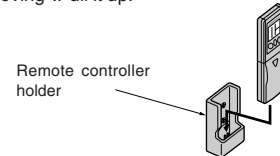

Dry-cell batteries

■ Reference for replacing batteries

Replace the batteries with new AAA alkaline batteries in the following cases:

- When the indoor unit does not respond to the remote control signal.
- When the display on the remote controller becomes dim.
- When a button of the remote controller is pressed, all displays appear on the screen, and then disappear immediately.

Do not use manganese batteries. The remote controller could malfunction.

- The service life of an alkaline battery is about 1 year. However, a battery whose time limit is approaching may be exhausted soon. The recommended usable time limit is indicated (month/year) on the bottom of the battery.
- To prevent liquid leakage, take out all batteries when the remote controller is not going to be used for a long time.

⚠ CAUTION:

If liquid from the batteries gets onto your skin or clothes, wash it well with clean water.

If liquid from the batteries gets into your eyes, wash them well with clean water and consult a doctor at once.

- Do not use rechargeable batteries.
- Replace the 2 batteries with new ones of the same type.
- Dispose of exhausted batteries in the correct manner.

When the remote controller cannot be used (emergency operation)

When the batteries of the remote controller run out or the remote controller malfunctions, the emergency operation can be done using the EMERGENCY OPERATION switch.

- 1 Press the EMERGENCY OPERATION switch.

- Each time the EMERGENCY OPERATION switch is pressed, the unit will operate in order of EMERGENCY COOL MODE, EMERGENCY HEAT MODE and STOP MODE.

However, when the EMERGENCY OPERATION switch is once pressed, the unit will operate in test run for 30 minutes and then the operation mode shifts to EMERGENCY MODE.

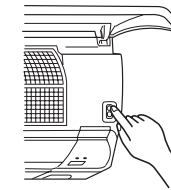

- Details of EMERGENCY MODE are as shown below. However, the temperature control does not work for 30 minutes in test run and the unit is set to continuous operation. The fan speed is set to High in test run and shifts to Medium after 30 minutes.

Operation mode	COOL	HEAT
Set temperature	75°F	75°F
Fan speed	Medium	Medium
Horizontal vane	Auto	Auto

- The operation mode is indicated by the Operation Indicator lamp on the indoor unit as following figure.

Operation Indicator lamp

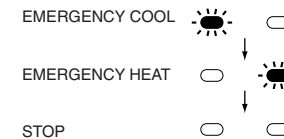

AUTO CHANGEOVER... AUTO MODE OPERATION

An automatic cooling and heating changeover operation system ensures easy control and year-round air conditioning.

Once the desired temperature is set, unit operation is switched automatically between cooling and heating according to the room temperature. In addition, fan control of the outdoor unit enables cooling operation at outside temperature as low as 14 °F.

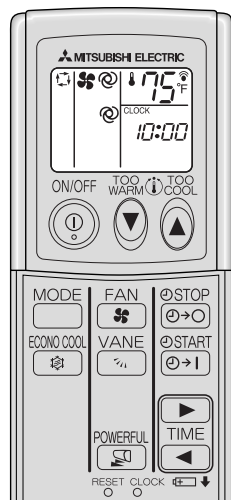

To select the AUTO mode:

- 1 Press the button.
- 2 Select the (AUTO) mode by pressing the button.

Each time this button is pressed, the operation mode is changed in sequence:
 (AUTO) → (COOL) → (DRY) → (HEAT)
 The set temperature is also displayed on the remote controller.

To stop operation:

- 1 Press the button.

After the operation mode is set once, the operation starts in the same mode as the one set previously from the next time by simply pressing the button.

When the set temperature is to be changed:

- Press the button to lower the temperature. One press lowers the temperature by about 1°F.
- Press the button to raise the temperature. One press raises the temperature by about 1°F.

Description of “AUTO CHANGEOVER”

(1) Initial mode

- ① When unit starts the operation with AUTO operation from off;
 - If the room temperature is higher than the set temperature, operation starts in COOL mode.
 - If the room temperature is equal to or lower than the set temperature, operation starts in HEAT mode.

(2) Mode change

- ① COOL mode changes to HEAT mode when about 15 minutes have passed with the room temperature 4 degrees below the set temperature.
- ② HEAT mode changes to COOL mode when about 15 minutes have passed with the room temperature 4 degrees above the set temperature.

NOTE:

If two or more indoor units are operating in multi system, there might be a case that the indoor unit, which is operating in (AUTO), cannot change over to the other operating mode (COOL↔HEAT) and becomes a state of standby. Refer to the detailed information for multi system air conditioner explained on the right.

Description of “AUTO RESTART FUNCTION”

- These units are equipped with an auto restart function. When the main power is turned on, the air conditioner will start operation automatically in the same mode as the one set with the remote controller before the shutoff of the main power.
- If the unit was set to off with the remote controller before the shutoff of the main power, it will remain stopped even after the main power is turned on.
- If the unit was in the emergency operation before the shutoff of the main power, it will start operation, when main power comes on, in the same mode as the one set with the remote controller before the emergency operation.
- If the unit is operated in (AUTO) mode before power failure, the operation mode (COOL, DRY or HEAT) is not stored in the memory. When the main power is turned on, the unit decides the operation mode by the initial room temperature at restart and starts operation again.

Information for multi system air conditioner

Multi system air conditioner can connect two or more indoor units with one outdoor unit. According to the capacity, two or more units can operate simultaneously.

- When you try to operate two or more indoor units with one outdoor unit simultaneously, one for the cooling and the other for heating, the operation mode of the indoor unit that operates earlier is selected. The other indoor units that will start the operation later cannot operate, indicating an operation state. (Refer to the table of Operation Indicator lamp below.) In this case, please set all the indoor units to the same operation mode.
- When indoor unit starts the operation while the defrosting of outdoor unit is being done, it takes a few minutes (max. 10 minutes) to blow out the warm air.
- In the heating operation, the indoor unit that does not operate may get warm or the sound of refrigerant flowing may be heard. This is not a malfunction since the refrigerant continuously flows into the indoor unit that does not operate.

Details of display on the indoor unit

The operation indicator at the right side of the indoor unit indicates the operation state.



Operation indicator lamp

Indication	Operation state	Difference between target temperature and room temperature
	This shows that the air conditioner is operating to reach the target temperature. Please wait until the target temperature is obtained.	About 4°F or more
	This shows that the room temperature is approaching the target temperature.	About 4°F or less
	This shows a state of standby for operation. Please refer to Information for multi system air conditioner above.	—

MANUAL OPERATION (COOL, DRY, HEAT)

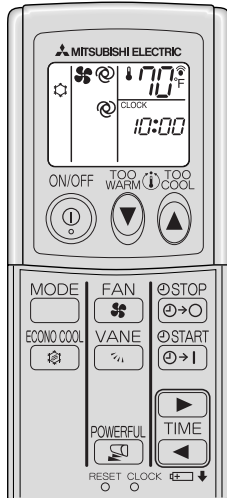

To select the COOL, DRY or HEAT mode:

- 1 Press the button.
- 2 Select the operation mode by pressing the button.
Each time this button is pressed, the operation mode is changed in sequence:
 (AUTO) → (COOL) → (DRY) → (HEAT)

To stop operation:

- Press the button.
After the operation mode is set once, the operation starts in the same mode as the one set previously from the next time by simply pressing the button.

When the set temperature is to be changed:

- Press the button to lower the temperature. One press lowers the temperature by about 1°F.
- Press the button to raise the temperature. One press raises the temperature by about 1°F.

In COOL operation

- When the outside temperature is low, the fan of the outdoor unit turns on and off frequently or decreases the rotation speed to maintain sufficient cooling capacity.

In DRY operation

- The temperature control (temperature setting) cannot be done.
- The room temperature is slightly lowered in this operation mode.

The details of the display on the indoor unit are explained on page 6.

If the air conditioner doesn't cool or heat effectively...

If the fan speed is set to Low or AUTO, sometimes the air conditioner may not cool or heat the air effectively. In this case, change the fan speed to Med. or upper.

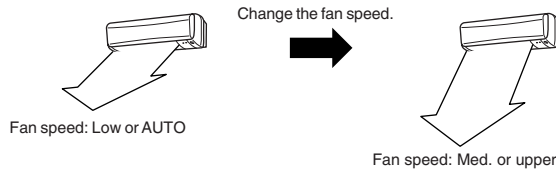

AIR FLOW VELOCITY AND DIRECTION ADJUSTMENT

AIR FLOW velocity and direction can be selected as required.

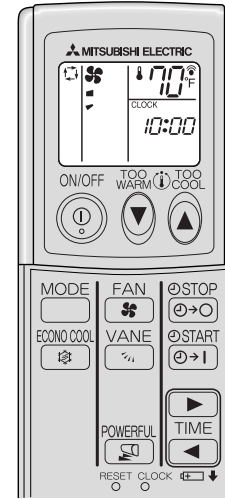

To change the AIR FLOW velocity, press the button.

Each time the button is pressed, the fan speed is changed in sequence:
■ (Low) → ■■ (Med.) → ■■■ (High) → (AUTO)

- If the operating sound of the air conditioner disturbs your sleep, use the ■ (Low) notch.

To change the AIR FLOW blowing direction vertically, press the button.

Each time the button is pressed, the angle of the horizontal vane is changed in sequence: (1) → (2) → (3) → (4) → (SWING) → (AUTO)

SWING OPERATION

Use the swing operation for the air flow to reach all corners of the room.





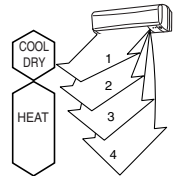

Recommended horizontal vane range for more efficient air-conditioning

Use the (AUTO) position usually.
Use position (1) in the COOL or DRY mode and use positions (2) to (4) in the HEAT mode when adjusting to your requirements.

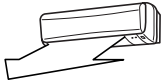

AIR FLOW VELOCITY AND DIRECTION ADJUSTMENT

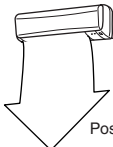
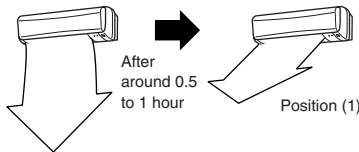
Movement of the horizontal vane

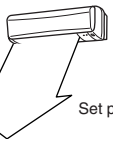
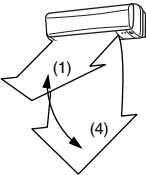
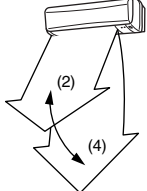
	COOL/DRY	HEAT
AUTO	 <p>Horizontal position</p> <ul style="list-style-type: none"> The vane automatically moves to horizontal position. It will not swing. <p>NOTE: Air blows out upper than position (1).</p> <ul style="list-style-type: none"> To constantly change the air flow direction, select  (SWING) with the  button. 	<p>At the start of heating operation</p>  <p>Horizontal position</p> <p>Very small air flow</p> <p>When air becomes warm...</p>  <p>Position (4)</p> <ul style="list-style-type: none"> Immediately after the air conditioner starts operating, the vane stays at horizontal position. Once the air from the indoor unit becomes sufficiently warm, the vane moves to position (4). Once the air conditioner starts operating, the fan speed increases gradually as the air from the indoor unit gets warmer, and continues until the set speed is finally reached.
MANUAL	 <p>After around 0.5 to 1 hour</p> <p>Position (1)</p> <p>When the air flow direction is set to position (2), (3) or (4)</p> <ul style="list-style-type: none"> After around one hour of operation, the air conditioner automatically moves the vane to position (1). To change the air flow direction to the original setting, operate the VANE button on the remote controller again. The vane does not move to the straight-down position in the COOL and DRY mode. 	<p>At the start of heating operation</p>  <p>Horizontal position</p> <p>Very small air flow</p> <p>When air becomes warm...</p>  <p>Set position</p> <ul style="list-style-type: none"> Immediately after the air conditioner starts operating, the vane stays at horizontal position. Once the air from the indoor unit becomes sufficiently warm, the vane moves to the position corresponding to the set direction of air flow. Once the air conditioner starts operating, the fan speed increases gradually as the air from the indoor unit gets warmer, and continues until the set speed is finally reached.
SWING	<ul style="list-style-type: none"> The vane moves intermittently between positions (1) and (4). The vane stops for a brief period at positions (1) and (4). 	<ul style="list-style-type: none"> The vane moves intermittently between positions (2) and (4). The vane stops for a brief period at positions (2) and (4). 

NOTE:

- Adjust the vertical AIR FLOW direction using the remote controller. Moving the horizontal vane manually can cause trouble.
- When the operation mode changes in  (AUTO) mode, the horizontal vane is automatically changed to the position in each mode.



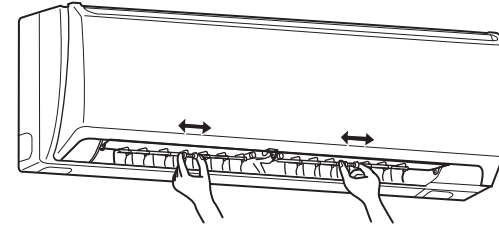



To change the horizontal direction of the air flow, move the vertical vane manually.



Adjust the vane before operation starts.

Since the horizontal vane moves automatically, your fingers may be caught.

To change the air flow direction not to blow directly onto your body.

To change the air flow direction	When to use this function?	COOL/DRY	HEAT
<p>Pressing and holding the  button for 2 seconds or more causes the horizontal vane to reverse and move to horizontal position.</p>  <p>Horizontal position</p>	<p>Use this function if you don't want the air from the indoor unit to blow directly onto your body.</p> <ul style="list-style-type: none"> Depending on the shape of the room, the air may blow directly onto your body. Press the  button again to return the vane to the previously-set position. 	<p>The air conditioner starts the cooling or drying operation approx. 3 minutes after the vane has moved to the horizontal position.</p> <ul style="list-style-type: none"> When the  button is pressed again, the vane returns to the previously-set position and the air conditioner starts the cooling or drying operation in approx. 3 minutes. 	<p>The air conditioner starts heating operation approx. 3 minutes after the vane has moved to the horizontal position.</p> <ul style="list-style-type: none"> Sometimes the area around your feet may not warm. To warn the area around the feet, set the horizontal vane to  (AUTO) or the downward-blowing position. When the  button is pressed again, the vane returns to the previously-set position and the air conditioner starts heating operation in approx. 3 minutes.

NOTE:

- If you make the air flow not to blow directly onto your body by pressing  button, the compressor stops for 3 minutes even during the operation of the air conditioner.
- The air conditioner operates with decreased air flow until the compressor turns on again.

POWERFUL OPERATION

Use this operation when you want to cool/heat your room within a short time period.



Perform the following operations while the unit is operating in the MANUAL COOL/HEAT mode.

Press the **POWERFUL** button.

The air conditioner automatically adjusts the fan speed and the set temperature, and operates the POWERFUL mode. The POWERFUL mode is automatically released 15 minutes after operation starts, and the operation mode returns to the mode prior to POWERFUL operation.

POWERFUL mode

Fan speed	Position of horizontal vane
POWERFUL-high*	Set position**

- * Exclusive for POWERFUL mode
- ** When the position of the horizontal vane is set to (AUTO) during cooling operation, the air is blown downward.

To release the POWERFUL mode before it is released automatically:

Press the **POWERFUL** button again.

POWERFUL mode is also released in the following ways:

- By pressing the **ON/OFF** button
- By pressing the **FAN** button
- By pressing the **ECONO COOL** button
- By setting the ON timer

The **TOO WARM** and **TOO COOL** buttons are not available during the POWERFUL operation.

The **VANE** button is available.

ECONO COOL OPERATION

Use this operation when you want to be comfortable in COOL mode even with energy saved.

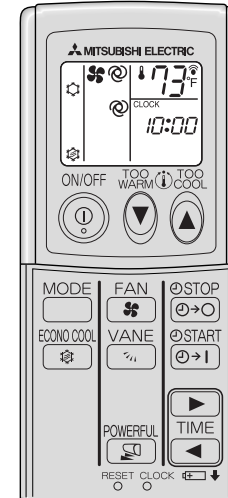

Perform the following operations while the unit is operating in the MANUAL COOL mode.

Press the **ECONO COOL** button.

When the (ECONO COOL) operation is selected in COOL mode, the air conditioner performs swing operation vertically in various cycle according to the temperature of air conditioner. Also SET TEMPERATURE is automatically set 4°F higher than in COOL mode.

To release the ECONO COOL operation:

Press the **ECONO COOL** button again.

- When the **VANE** button or the **POWERFUL** button is pressed or the operation mode is changed during the ECONO COOL operation, ECONO COOL operation is released.
- The **FAN** button, the **TOO WARM** or **TOO COOL** button and ON/OFF timer (explained below) are available.

What is "ECONO COOL"?

Swing air flow (change of air flow) makes you feel cooler than constant air flow. So, even though the set temperature is automatically set 4°F higher, it is possible to perform cooling operation with keeping comfort. As a result, energy can be saved.



TIMER OPERATION (ON/OFF TIMER)



It is convenient to set the timer when you go to bed, when you get home, when you get up, etc.

How to set the ON timer

- 1 Press the  button during operation.

Each time the button is pressed, the ON timer mode alternates between ON and OFF.

- 2 Set the time of the timer using the TIME buttons  (Forward) and  (Backward).

Each time the  button is pressed, the set time increases by 10 minutes; each time the  button is pressed, the set time decreases by 10 minutes.

To release the ON timer:

- 1 Press the  button.

Programming timer operation

The ON timer and the OFF timer can be used in combination. The timer of the set time that is reached first will operate first. (“↑↓” mark indicates the order of timer operations.)

- If the current time has not been set, the timer operation cannot be used.



NOTE:



If the main power is turned off or a power failure occurs while AUTO START/STOP timer is active, the timer setting is cancelled. As these models are equipped with an auto restart function, the air conditioner starts operating with timer cancelled at the same time that power is restored.

How to set the OFF timer

- 1 Press the  button during operation.

Each time the button is pressed, the OFF timer mode alternates between ON and OFF.

- 2 Set the time of the timer using the TIME buttons  (Forward) and  (Backward).

Each time the  button is pressed, the set time increases by 10 minutes; each time the  button is pressed, the set time decreases by 10 minutes.

To release the OFF timer:

- 1 Press the  button.

WHEN THE AIR CONDITIONER IS NOT GOING TO BE USED FOR A LONG TIME

When it is not going to be used for a long time:

- 1 Perform the FAN operation for 3 or 4 hours to dry the inside of the air conditioner.

- To perform FAN operation, set the remote controller to the highest temperature in the MANUAL COOL mode. (Refer to page 7.)

- 2 Turn off the breaker.



CAUTION:

Turn off the breaker when the air conditioner is not going to be used for a long time.

Dirt may collect and this may cause a fire.

- 3 Remove the batteries from the remote controller.

CAUTION:

To prevent liquid leakage, take out all batteries when the remote controller is not going to be used for a long time.

When the air conditioner is to be used again:

- 1 Clean the air filter and install it in the indoor unit.

(Refer to page 11 for cleaning instructions.)

- 2 Check that the air inlet and outlet of the indoor/outdoor units are not blocked with any obstacles.

- 3 Check that the ground is connected correctly.

CAUTION:

Ground the unit.

Do not connect the ground to a gas pipe, water pipe, lightning rod or the ground of a telephone. If the grounding is incorrect, it may cause an electric shock.

MAINTENANCE

Before starting maintenance

- 1 Turn off the breaker.



CAUTION:

When the unit is to be cleaned, switch it off and turn off the breaker. Since the fan rotates at high speed during operation, it may cause an injury.

Cleaning the indoor unit

- 1 Clean the unit using a soft dry cloth.

- If the dirt is noticeable, wipe the unit with a cloth soaked in a solution of mild detergent diluted in lukewarm water.
- Do not use gasoline, benzene, thinner, polishing powder, or insecticide. The unit may be damaged.
- The front panel may come off if it is lifted up past its level position. If the front panel comes off, refer to step 3 in CLEANING THE FRONT PANEL.

CLEANING THE FRONT PANEL

Front panel

- 1 Hold both ends of the front panel and lift the panel up until a “click” is heard. (1) Holding the hinges, lift the panel up until it is level, and pull the hinges forward to remove the front panel. (2)

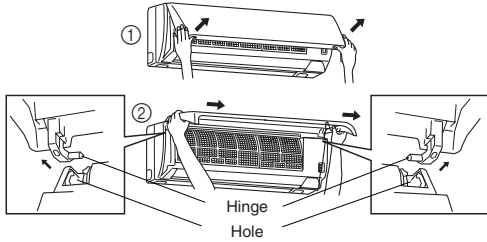

CAUTION:

- Do not drop the front panel or pull it out forcibly. The panel may be damaged.
- Do not step onto an unstable bench when removing or installing the front panel. This may cause an injury, etc. if you fall down.

- 2 Wipe the front panel with a soft dry cloth or wash it with water. After washing the panel, wipe up the remaining water with a soft dry cloth and let it dry out of direct sunlight.

- If the dirt is noticeable, wipe the front panel with a cloth soaked in a solution of mild detergent diluted in lukewarm water.
- Do not use gasoline, benzine, thinner, polishing powder, or insecticide and do not wash the front panel with a scrubbing brush or the hard surface of a sponge.
- Do not soak the front panel in water/lukewarm water longer than two hours and do not expose the panel to direct sunlight, heat, or flames when drying it. The panel may be deformed or discolored.

- 3 Hold both ends of the front panel, keep the panel level, and insert the hinges into the holes on the upper part of the indoor unit until they click into place. Then, close the front panel securely and press the three positions on the front panel as indicated by the arrows.

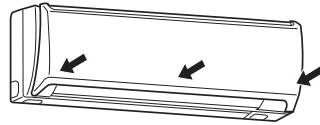

CLEANING THE AIR FILTER (CATECHIN)

Cleaning the air filter (about once every 2 weeks)

- 1 Remove the air filter.

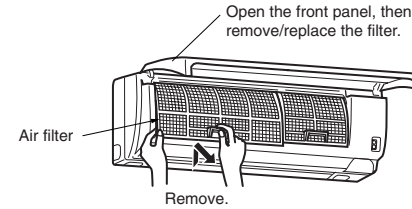

CAUTION:

When the air filter is to be removed, do not touch the metal parts of the indoor unit. This may cause an injury.

- 2 Remove dirt from the air filter using a vacuum cleaner or by washing the filter with water.

- Do not wash with scrubbing brush or hard surface of sponge. Otherwise, the filter may deform.
- If the dirt is noticeable, wash the filter with a solution of mild detergent diluted in lukewarm water.
- If hot water (120 °F or more) is used, the filter may be deformed.

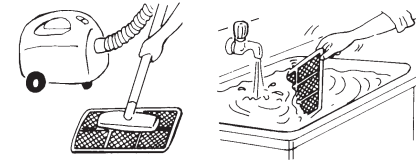

- 3 After washing with water/lukewarm water, dry the air filter well in the shade.

- Do not expose the air filter to direct sunlight or heat from a fire when drying it.

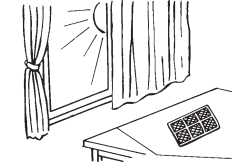

- 4 Install the air filter. (Securely install its tabs.)

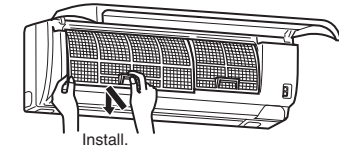

What is “Catechin air filter”?

The air filter is dyed with a natural material, catechin, that is contained in tea. The catechin air filter deodorizes odor and noxious gases such as formaldehyde, ammonia, and acetaldehyde. Moreover, it restrains the activity of the viruses adhering to the filter.

CLEANING THE AIR CLEANING FILTER

Cleaning the air cleaning filter (about once every 3 months)

1 Remove the air filter (left one).

The air cleaning filter is not attached to the right side air filter.

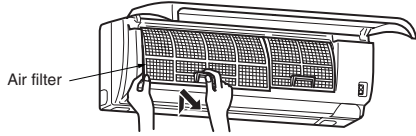

2 Pull up the tabs on both sides of the air cleaning filter (blue bellows type) from the air filter.

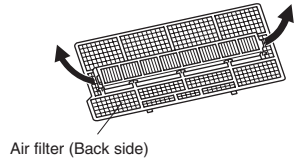

3 Soak the filter together with its frame in lukewarm water and wash it.

- If the dirt is noticeable, use a solution of mild detergent diluted in lukewarm water.
- If hot water (120°F or more) is used, the filter may be deformed.
- Do not use a scrubbing brush or sponge. This may damage the surface of the filter.
- Do not use a chlorine detergent.



4 After rinsing with water/lukewarm water, shake off the excess water and dry the filter well in the shade.

- Do not expose the filter to direct sunlight or heat from a fire when drying it.

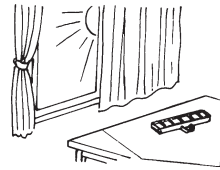

REPLACEMENT OF THE AIR CLEANING FILTER

When the capacity is lowered because of dirt, etc., it is necessary to replace the air cleaning filter.

Air cleaning filter replacement (about once every year)

1 Remove the air filter (left one).

The air cleaning filter is not attached to the right side air filter.

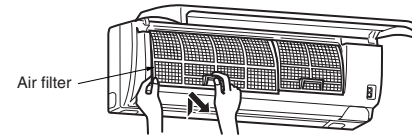

2 Pull up the tabs on both sides of the air cleaning filter (blue bellows type) from the air filter.

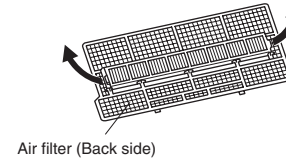

3 Attach a new air cleaning filter to the air filter so that all 8 tabs on the air filter are securely installed.

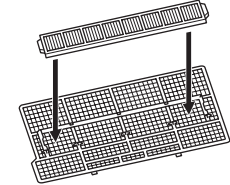

4 Install the air filter. (Securely install its tabs.)

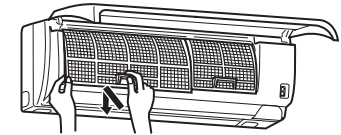

5 Securely close the front panel.

Air cleaning filter

- If the air cleaning filter is clogged, it may lower the unit's capacity or cause condensation at the air outlet.
- The air cleaning filter is disposable. The standard usable term is about 1 year.

Optional parts Optional parts are available from your local dealer.

Name of parts	AIR CLEANING FILTER (Anti-Allergy Enzyme Filter)
Parts number	MAC-415FT-E

This optional part is for the replacement of the left side filter only. No optional part is available for the right side filter.

BEFORE CONTACTING THE SERVICE REPRESENTATIVE, CHECK THE FOLLOWING AGAIN

Question	Check points
The air conditioner cannot be operated.	<ul style="list-style-type: none"> Is the breaker turned on? Is the fuse blown? Is the ON timer set? (Page 10)
The horizontal vane does not move.	<ul style="list-style-type: none"> Is the horizontal vane attached to the indoor unit correctly? Is the fan guard deformed?
The room cannot be cooled or heated sufficiently.	<ul style="list-style-type: none"> Is the temperature setting correct? (Page 7) Is the filter clean? (Page 11) Are there any obstacles blocking the air inlet or outlet of the indoor or outdoor unit? Is a window or door open?
The air from the indoor unit smells strange.	<ul style="list-style-type: none"> Is the filter clean? (Page 11)
The display on the remote controller does not appear or it is dim. The indoor unit does not respond to the remote control signal.	<ul style="list-style-type: none"> Are the batteries exhausted? (Page 5) Is the polarity (+, -) of the batteries correct? (Page 5) Are any buttons on the remote controller of other electric appliances being pressed?
When a power failure occurs.	<ul style="list-style-type: none"> Does the air conditioner start operating again? If the air conditioner had operated before the power failure, as these models are equipped with an auto restart function, the air conditioner should start operating again. (Refer to Description of "AUTO RESTART FUNCTION" on page 6.)

Even if the above items are checked, when the air conditioner does not recover from the trouble, stop using the air conditioner and consult your dealer.

In the following cases, stop using the air conditioner and consult your dealer.

- When water leaks or drops from the indoor unit.
- When the left operation indicator lamp blinks.
- When the breaker trips frequently.
- The remote control signal may not be received in a room where an electronic ON/OFF type fluorescent lamp (inverter-type fluorescent lamp, etc.) is used.
- Operation of the air conditioner may interfere with radio or TV reception in areas where the reception is weak. An amplifier may be required for the affected device.
- When thunder is heard, stop operation and turn off the breaker. Otherwise, the electrical parts may be damaged.

WHEN YOU THINK THAT TROUBLE HAS OCCURRED

Question	Answer (not a malfunction)
The air conditioner cannot be operated for about 3 minutes when restarted.	<ul style="list-style-type: none"> This protects the air conditioner according to instructions from the microprocessor. Please wait.
Cracking sound is heard.	<ul style="list-style-type: none"> This sound is generated by the expansion/contraction of the front panel, etc. due to change in temperature.
The air from the indoor unit smells strange.	<ul style="list-style-type: none"> The air conditioner may suck in an odor adhering to the wall, carpet, furniture, cloth, etc. and blow it out with the air.
The fan of the outdoor unit does not rotate even though the compressor is running. Even if the fan starts to rotate, it stops soon.	<ul style="list-style-type: none"> When the outside temperature is low, the fan may not operate to maintain sufficient cooling capacity.
The sound of water flowing is heard.	<ul style="list-style-type: none"> This is the sound of refrigerant flowing inside the air conditioner. This is the sound of condensed water flowing in the heat exchanger. This is the sound of the heat exchanger defrosting.
The sound as burbling is heard.	<ul style="list-style-type: none"> This sound is heard when the outside air is absorbed from the drain hose in turning on the range hood or the ventilation fan and that makes water flowing in the drain hose spout out. This sound is also heard when the outside air blows into the drain hose in case the outside wind is strong.
The room cannot be cooled sufficiently.	<ul style="list-style-type: none"> When a ventilation fan or a gas cooker is used in a room, the cooling load increases, resulting in an insufficient cooling effect. When the outside air temperature is high, the cooling effect may not be sufficient.
Mist is discharged from the air outlet of the indoor unit.	<ul style="list-style-type: none"> The cool air from the air conditioner rapidly cools moisture in the air inside the room, and it turns into mist.
Mechanical sound is heard from the indoor unit.	<ul style="list-style-type: none"> This is the switching sound in turning on/off the fan or the compressor.
The swing operation of the HORIZONTAL VANE is suspended for about 15 seconds, then restarted.	<ul style="list-style-type: none"> This is for the swing operation of the HORIZONTAL VANE to be performed normally.

Question	Answer (not a malfunction)
The air flow direction changes during operation. The direction of the horizontal vane cannot be adjusted with the remote controller.	<ul style="list-style-type: none"> When the air conditioner is operated in COOL or DRY mode, if the operation continues with air blowing down for 1 hour, the direction of the air flow is automatically set to position (1) to prevent condensed water from dropping. In the heating operation, if the air flow temperature is too low or when defrosting is being done, the horizontal vane position is automatically set to horizontal.
Water leaks from the outdoor unit.	<ul style="list-style-type: none"> During COOL and DRY operations, pipe or pipe connecting sections are cooled and this causes water to condense. In the heating operation, the defrosting operation makes water frozen on the outdoor unit melt and drip down. In the heating operation, water condensed on the heat exchanger drips down.
White smoke is discharged from the outdoor unit.	<ul style="list-style-type: none"> In the heating operation, vapor generated by the defrosting operation looks like white smoke.
Air does not blow out soon in the heating operation.	<ul style="list-style-type: none"> Please wait as the air conditioner is preparing to blow out warm air.
The operation is stopped for about 10 minutes in the heating operation.	<ul style="list-style-type: none"> Defrosting of the outdoor unit is being done (Defrosting operation). Since this is completed in 10 minutes, please wait. (When the external temperature is too low and humidity is too high, frost is formed.)
Hissing sound is sometimes heard.	<ul style="list-style-type: none"> This is the sound when the flow of refrigerant inside the air conditioner is switched.
The room cannot be heated sufficiently.	<ul style="list-style-type: none"> When the outside air temperature is low, the heating effect may not be sufficient.
In a multi-unit system, the indoor unit which is not operating becomes warm and a sound, similar to water flowing, is heard from the unit.	<ul style="list-style-type: none"> A small amount of refrigerant continues to flow into the indoor unit even though it is not operating.
The air conditioner starts the operation only with the main power turned on, though you do not operate the unit with the remote controller.	<ul style="list-style-type: none"> These models are equipped with an auto restart function. When the main power is turned off without stopping the air conditioner with the remote controller and is turned on again, the air conditioner will start operation automatically in the same mode as the one set with the remote controller just before the shutoff of the main power.

INSTALLATION, RELOCATION AND INSPECTION

Installation place

Avoid installing the air conditioner in the following places.

- Where flammable gas could leak.

⚠ CAUTION:

Do not install the unit where flammable gas could leak. If gas leaks and collects around the unit, it may cause an explosion.

- Where there is much machine oil.
- Salty places such as the seaside.
- Where sulfide gas is generated such as a hot spring.
- Where oil is splashed or where the area is filled with oily smoke.
- Where there is high-frequency or wireless equipment.

⚠ WARNING:

If the air conditioner operates but does not cool or heat (depending on model) the room, consult your dealer since there may be a refrigerant leak. Be sure to ask the service representative whether there is refrigerant leakage or not when repairs are carried out.

The refrigerant charged in the air conditioner is safe. Refrigerant normally does not leak, however, if refrigerant gas leaks indoors, and comes into contact with the fire of a fan heater, space heater, stove, etc., harmful substances will be generated.

Electrical work

- Provide an exclusive circuit for the power supply of the air conditioner.
- Be sure to observe the breaker capacity.
- Use the correct power (voltage and frequency) indicated on the unit to operate the air conditioner and use only fuses or breakers with specified capacity. Do not use pieces of wire instead of fuses.

⚠ WARNING:

- **The customer should not install this unit. If installation is done incorrectly, it may cause a fire, an electric shock, or injury from the unit falling, water leaking, etc.**
- **Do not use intermediate connection of the power supply cord or the extension cord and do not connect many devices to one AC outlet. A fire or an electric shock may result from poor contact, poor insulation, exceeding the permissible current, etc. Consult your dealer.**
- **The unit should be installed by licensed contractor according to local code requirements.**

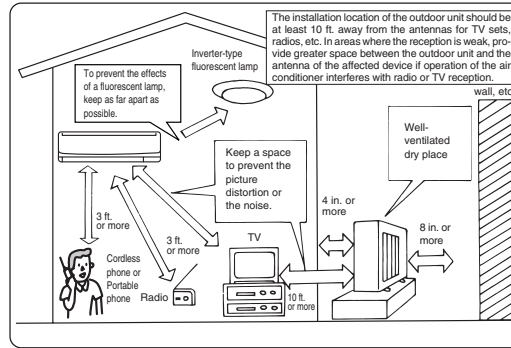

⚠ CAUTION:

- **Ground the unit.**

Do not connect the ground to a gas pipe, water pipe, lightning rod or the ground of a telephone. If the grounding is incorrect, it may cause an electric shock.

- **If the air conditioner is installed in a high humidity area or near a water source, a Ground Fault Interrupt (GFI) circuit breaker should be installed to protect against an electric shock.**

Inspection and maintenance

- When the air conditioner is used for several seasons, the capacity may be lowered due to dirt inside the unit.
- Depending on the condition, an odor may be generated or dehumidified water may not drain out smoothly due to dirt, dust, etc.
- It is recommended that the unit be inspected and maintained (charged) by specialist in addition to normal maintenance. Consult your dealer.

Operating sound considerations

- Do not put an object around the air outlet of the outdoor unit. This may lower the capacity or increase the volume of the operating sound.
- If an abnormal sound is heard during operation, consult your dealer.

Relocation

- When the air conditioner is to be removed or re-installed because of rebuilding, moving, etc., special techniques and work are required.

⚠ WARNING:

Repairs or relocation should not be done by the customer.

If this is done incorrectly, it may cause a fire, an electric shock, or an injury from the unit falling, water leaking, etc. Consult your dealer.

Disposal

To dispose of this product, consult your dealer.

If you have any questions, consult your dealer.



SG79Y636H01