

Owner's Manual

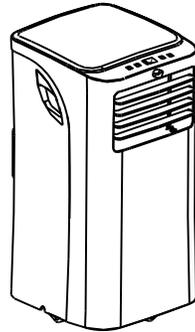

CLICK in this page to return to air conditioner information, manuals, installation, diagnosis, repair guides at InspectApedia.com



Portable Room Air Conditioner Owner's Manual for:

PS-81B
PS-101B

Comfort-Aire

Read This Manual

Inside you will find many helpful hints on how to use and maintain your air conditioner properly. Just a little preventive care on your part can save you a great deal of time and money over the life of your air conditioner. You'll find many answers to common problems in the chart of troubleshooting tips. If you review our chart of Troubleshooting Tips first, you may not need to call for service at all.

CAUTION

- Contact the authorized service technician for repair or maintenance of this unit.
- Contact the installer for installation of this unit.
- The air conditioner is not intended for use by young children or infirm persons without supervision.
- Young children should be supervised to ensure that they do not play with the air conditioner.
- If the power cord is to be replaced, replacement work shall be performed by authorized personnel only.
- Installation work must be performed in accordance with the national wiring standards by authorized personnel only.
- When there are wide differences between “USER’S MANUAL” and “Remote controller Illustration” on function description, the description on “USER’S MANUAL” shall prevail.

CONTENTS

SOCIABLE REMARK

Sociable remark.....2

SAFETY PRECAUTIONS

Safety rules3
 Operating condition3
 Electrical information4

IDENTIFICATION OF PARTS

Accessories4
 Names of parts.....5

AIR CONDITIONER FEATURES

Electronic control operating instructions6

OPERATING INSTRUCTIONS

Operating instructions7

INSTALLATION INSTRUCTIONS

Location9
 Window kit installation9
 Exhaust hose installation12
 Water drainage13

CARE AND MAINTENANCE

Care and cleaning14

TROUBLESHOOTING TIPS

Trouble shooting14

NOTE

The rating data indicated on the energy label is based on the testing condition of installing the un-extended air exhaust duct without adaptor A & B (The duct and the adaptor A & B are listed in the accessories chart of the Instruction Manual). See the right figure. At the same time, the unit must be operate on the COOL MODE and HIGH FAN SPEED by remote controller.

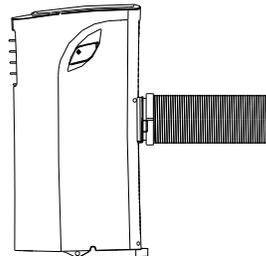

SOCIABLE REMARK

When using this air conditioner in the European countries, the following information must be followed:

DISPOSAL: Do not dispose this product as unsorted municipal waste. Collection of such waste separately for special treatment is necessary.

It is prohibited to dispose of this appliance in domestic household waste.

For disposal, there are several possibilities:

- A) The municipality has established collection systems, where electronic waste can be disposed of at least free of charge to the user.
- B) When buying a new product, the retailer may take back the old product free of charge.
- C) The manufacture may take back the old appliance for disposal free of charge to the user.
- D) As old products contain valuable resources, they can be sold to scrap metal dealers.

Wild disposal of waste in forests and landscapes endangers your health when hazardous substances leak into the ground-water and find their way into the food chain.

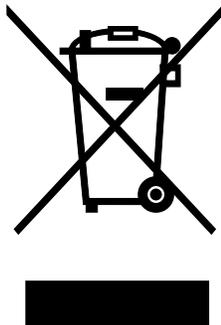

SAFETY PRECAUTIONS

Safety rules

To prevent injury to the user or other people and property damage, the following instructions must be followed. Incorrect operation due to ignoring of instructions may cause harm or damage.

Always do this

- Your air conditioner should be used in such a way that it is protected from moisture. e.g. condensation, splashed water, etc. Do not place or store your air conditioner where it can fall or be pulled into water or any other liquid. Unplug immediately if it occurs.
- Always transport your air conditioner in a vertical position and stand on a stable, level surface during use.
- Turn off the product when not in use.
- Always contact a qualified person to carry out repairs. If damaged power supply cord must be replaced with a new power supply cord obtained from the product manufacturer and not repaired.
- Keep an air path of at least 30cm all around the unit from walls, furniture and curtains.
- If the air conditioner is knocked over during use, turn off the unit and unplug from the main supply immediately.
- Always use the switch on the control panel.

Never do this

- Do not operate your air conditioner in a wet room such as a bathroom or laundry room.
- Do not touch the unit with wet or damp hands or when barefoot.
- Do not press the buttons on the control panel with anything other than your fingers.
- Do not remove any fixed covers. Never use this appliance if it is not working properly, or if it has been dropped or damaged.
- Never use the plug to start and stop the unit.
- Do not cover or obstruct the inlet or outlet grilles.
- Do not use hazardous chemicals to clean or come into contact with the unit. Do not use the unit in the presence of flammable substances or vapour such as alcohol, insecticides, petrol, etc.
- Do not allow children to operate the unit unsupervised.
- Do not use this product for functions other than those described in this instruction manual.

Energy Save

- Use the unit in the recommended room size.
- Locate the unit where furniture cannot obstruct the air flow.
- Keep blinds/curtains closed during the sunniest part of the day.
- Keep the filters clean.
- Keep doors and windows closed to keep cool air in and warm air out (cooling mode) or keep warm air in and cool air out(heating mode)..

Operating condition

- The air conditioner must be operated within the temperature range indicated below:

MODE	ROOM TEMPERATURE
COOL	17°C(62°F)~35°C(95°F)
DRY	13°C(55°F)~35°C(95°F)
HEAT(heat pump type)	5°C(41°F)~30°C(86°F)
HEAT(electrical heat type)	≤30°C/86°F

Suggested tools for window kit installation

1. Screwdriver(medium size Phillips)
2. Tape measure or ruler
3. Knife or scissors
4. Saw(In the event that the window kit needs to be cut down in size because the window is too narrow for direct installation)

IDENTIFICATION OF PARTS

For your safety

- Do not store or use gasoline or other flammable vapors and liquids in the vicinity of this or any other appliance.
- Avoid fire hazard or electric shock. Do not use an extension cord or an adaptor plug. Do not remove any prong from the power cord.

▲ WARNING Electrical Information

- Be sure the electrical service is adequate for the model you have chosen. This information can be found on the serial plate, which is located on the side of the cabinet and behind the grille.
- Be sure the air conditioner is properly grounded. To minimize shock and fire hazards, proper grounding is important. The power cord is equipped with a three-prong grounding plug for protection against shock hazards.
- Your air conditioner must be used in a properly grounded wall receptacle. If the wall receptacle you intend to use is not adequately grounded or protected by a time delay fuse or circuit breaker, have a qualified electrician install the proper receptacle.
- Ensure the receptacle is accessible after the unit installation.

Accessories

PARTS :	PARTS NAME :	QUANTITY :
	Exhaust hose(supplied), adapter B(round mouth or flat month:depending on models) and Window Slider Kit and bolt (※)	1 set
	Adaptor B(round mouth) (※)	1 set
	Wall Exhaust Adaptor A(※)	1 pc
	Expansion Plug and wooden screw(※)	4/ pc
	Foam seal (※)	3/pc
	Remote Controller and Battery (For remote control models only)	1set
	Drain hose	1pc

NOTE: Optional parts(※), some models without.

- Check that all the accessories are included in the package and please refer to the installation instructions for their usage.

NOTE: All the illustrations in this manual are for explanation purpose only. Your air conditioner may be slightly different. The actual shape shall prevail.

IDENTIFICATION OF PARTS

NAMES OF PARTS

Front

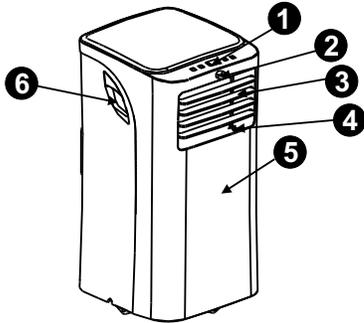

Fig.1

- ① Operation Panel
- ② Remote Signal Receptor
- ③ Horizontal Louver Control Lever (adjust manually)
- ④ Vertical Louver Control Lever (adjust manually)
- ⑤ Panel
- ⑥ Carrying Handle (both sides)

Rear

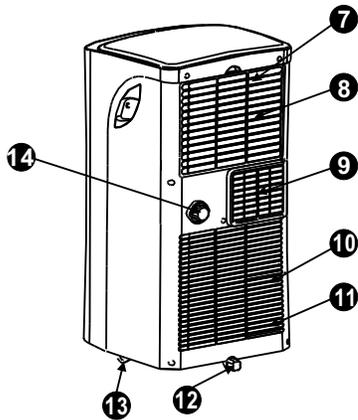

Fig.2

- ⑦ Upper Air Filter (Behind the grille)
- ⑧ Air Intake
- ⑨ Air Outlet
- ⑩ Lower Air Filter (Behind the grille)
- ⑪ Air Intake
- ⑫ Bottom tray drain outlet
- ⑬ Wheel
- ⑭ Drain Outlet

AIR CONDITIONER FEATURES

ELECTRONIC CONTROL OPERATING INSTRUCTIONS

Before you begin, thoroughly familiarize yourself with the control panel and remote controller and all its functions, then follow the symbol for the functions you desire.

The unit can be controlled by the unit control panel alone or with the remote controller .

NOTE: This manual does not include Remote Controller Operations, see the <<Remote Controller Instruction>> packed with the unit for details.

OPERATION PANEL OF THE AIR CONDITIONER

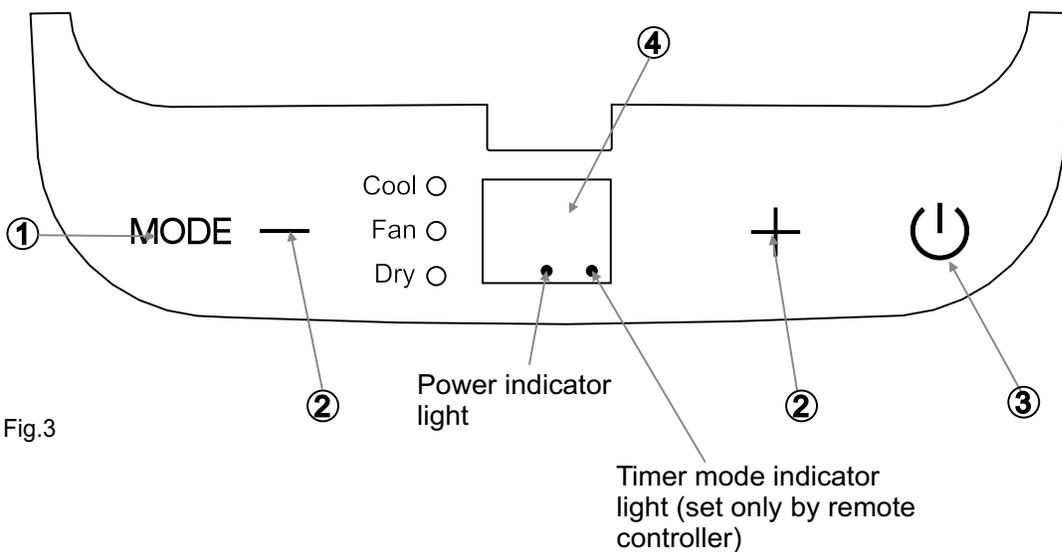

Fig.3

OPERATING INSTRUCTIONS

① **MODE select button**

Selects the appropriate operating mode. Each time you press the button, a mode is selected in a sequence that goes from COOL, FAN and DRY. The mode indicator light illuminates under the different mode setting.

NOTE: On above modes, the unit operates the auto fan speed automatically. You can set fan speed only by the remote controller on COOL and FAN modes.

② **UP(+) and DOWN(-) button**

Used to adjust (increasing/decreasing) temperature settings in 1°C/2°F (or 1°F) increments in a range of 17°C/62°F to 30°C/88°F (or 86°F).

NOTE: The control is capable of displaying temperature in degrees Fahrenheit or degrees Celsius. To convert from one to the other, press and hold the Up and Down buttons at the same time, for 3 seconds.

③ **ON-OFF button**

Power switch on/off.

④ **LED Display**

Shows the set temperature while on cool mode. While on DRY and FAN modes, it shows the room temperature.

Error codes:

- E1-** Room temperature sensor error-
Unplug the unit and plug it back in.
If error repeats, call for service.
- E2-** Evaporator temperature sensor error-
Unplug the unit and plug it back in.
If error repeats, call for service.
- E4-** Display panel communication error-
Unplug the unit and plug it back in.
If error repeats, call for service.

Protection codes:

- P1-** Bottom tray is full - Connect the drain hose and drain the collected water away. If error repeats, call for service.

Operating Instructions

COOL operation

- Press the "MODE" button until the "COOL" indicator light comes on. The unit will operate the auto fan speed automatically.
- Press the ADJUST buttons "▲" or "▼" to select your desired room temperature. The temperature can be set within a range of 17°C-30°C/62°F-88°F (or 86°F).
- Press the "FAN" button on the remote controller to choose the fan speed.

DRY operation

- Press the "MODE" button until the "DRY" indicator light comes on.
- Under this mode, you cannot select a fan speed or adjust the temperature.
- Keep windows and doors closed for the best dehumidifying effect.
- Do not put the duct to window.

FAN operation

- Press the "MODE" button until the "FAN" indicator light comes on. The unit will operate the auto fan speed automatically. The temperature cannot be adjusted on fan mode.
- Press the "FAN" button on the remote controller to choose the fan speed.
- Do not put the duct to window.

SLEEP operation

This feature can be activated from the remote control ONLY.

To activate SLEEP feature, the set temperature will increase by 1°C/2°F (or 1°F) in 30 minutes. The set temperature will then increase by another 1°C/2°F (or 1°F) after an additional 30 minutes. This new temperature will be maintained for 7 hours before it returns to the originally selected temperature. This ends the Sleep mode and the unit will continue to operate as originally programmed.

NOTE: This feature is unavailable under FAN or DRY mode.

OPERATING INSTRUCTIONS

Other features

Auto-Restart

If the unit breaks off unexpectedly due to a power outage, it will restart with the previous function setting automatically when the power resumes.

Wait 3 minutes before resuming operation

After the unit has stopped, it can not be restarted for 3 minutes. This is to protect the unit. Operation will automatically start after 3 minutes.

POWER MANAGEMENT feature

When the ambient temperature is lower than the setting temperature for a period of time, the unit will automatically operate power management feature. The compressor and fan motor will stop. When the ambient temperature is higher than the setting temperature, the unit will automatically quit the power management feature. The compressor and (or) fan motor will run.

Air flow direction adjustment

Adjust the air flow direction manually (Fig.4):

- The louver can be set to the desired position manually.
- Do not place any heavy objects or other loads on the louver, doing so will cause damage to the unit.
- **Ensure the louver is fully opened under heating operation.**
- **Keep the louver fully opened during operation.**

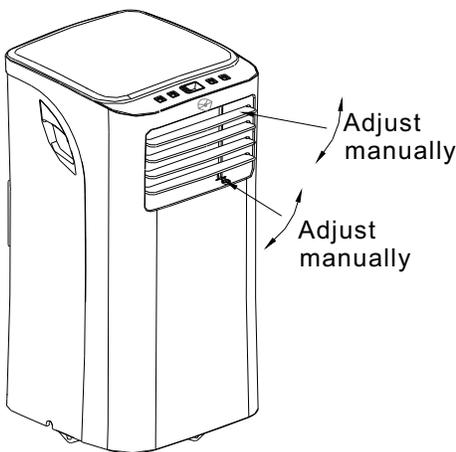
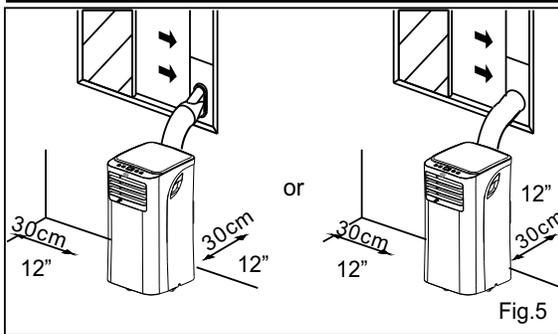

Fig.4

INSTALLATION INSTRUCTIONS (optional)



INSTALLATION INSTRUCTIONS

Location

- The air conditioner should be placed on a firm foundation to minimize noise and vibration. For safe and secure positioning, place the unit on a smooth, level floor strong enough to support the unit.
- The unit has casters to aid placement, but it should only be rolled on smooth, flat surfaces. Use caution when rolling on carpet surfaces. Do not attempt to roll the unit over objects.
- The unit must be placed within reach of a properly rated grounded socket.
- Never place any obstacles around the air inlet or outlet of the unit.
- Allow at least 30cm of space from the wall for efficient air-conditioning.

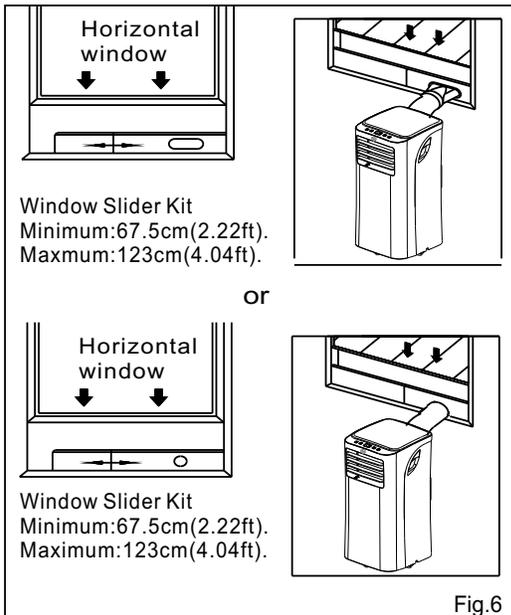

Window Slider kit Installation

Your window slider kit has been designed to fit most standard "Vertical" and "horizontal" window applications. However, it may be necessary for you to improvise/modify some aspects of the installation procedures for certain types of window. Please refer to Fig. 6 & Fig.7 for minimum and maximum window openings. Window slider kit can be fixed with a bolt (see Fig.7a).

Note: If the window opening is less than the mentioned minimum length of the window slider kit, cut the side with a hole in it short to fit for the window opening. Never cut out the hole in window slider kit.

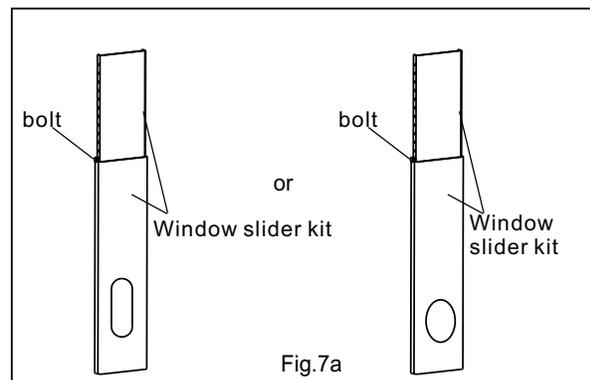
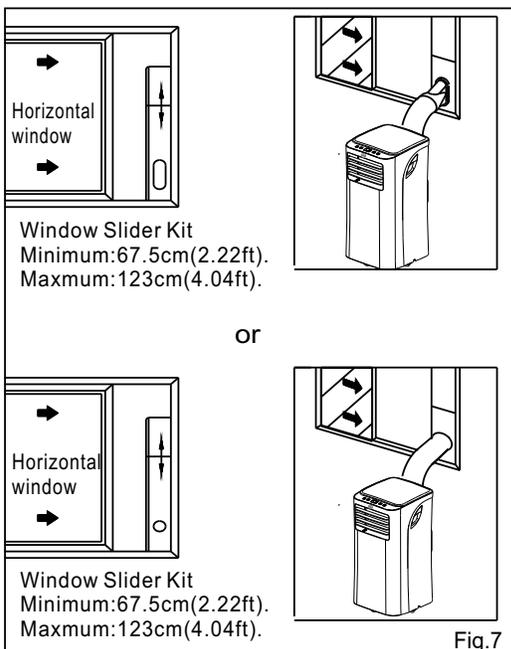

INSTALLATION INSTRUCTIONS (optional)

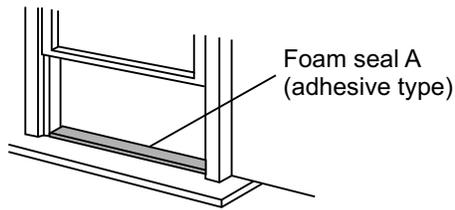

Fig. 8

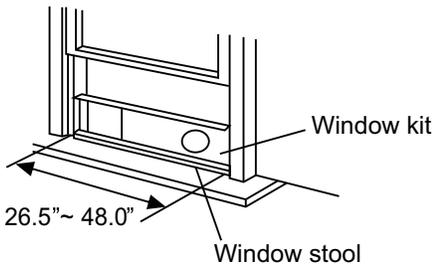
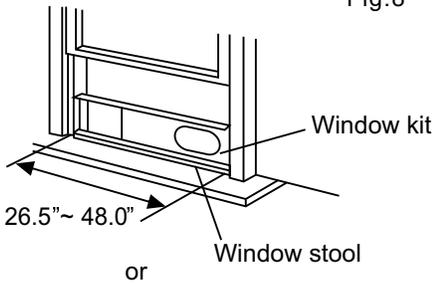

Fig. 9

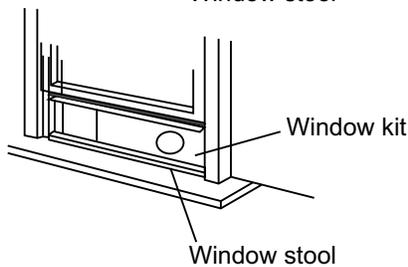
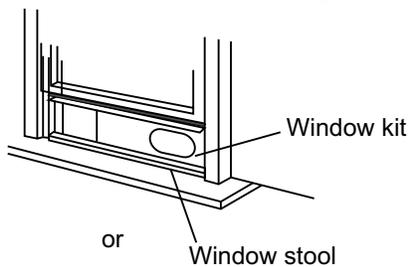

Fig. 10

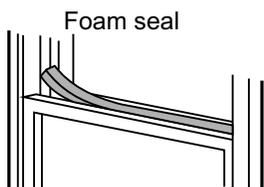

Fig. 11

Installation in a double-hung sash window

1. Cut the foam seal(adhesive type) to the proper length and attach it to the window stool. Fig.8
2. Attach the window slider kit to the window stool. Adjust the length of the window slider kit according to the width of window, shorten the adjustable window kit if the width of window is less than 26.5 inches. Open the window sash and place the window slider kit on the window stool. See Fig.9.
3. Cut the foam seal(adhesive type) to the proper length and attach it on the top of the window. Shown as in Fig.10.
4. Close the window sash securely against the window.
5. Cut the foam seal to an appropriate length and seal the open gap between the top window sash and outer window sash. Shown as in Fig.11.

INSTALLATION INSTRUCTIONS (optional)

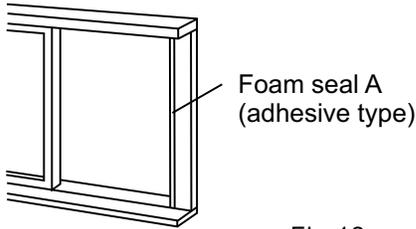
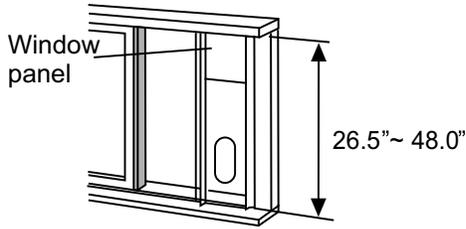

Fig.12



or

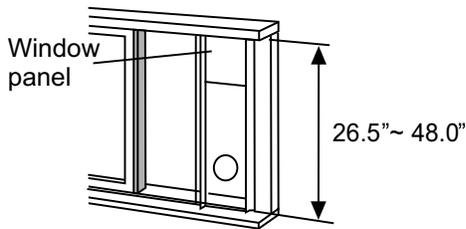

Fig.13

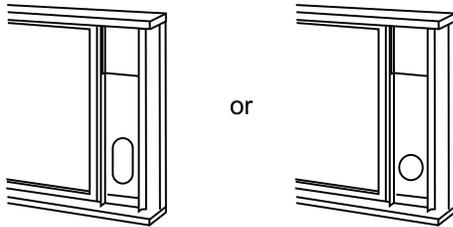

Fig.14

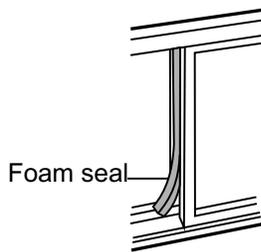

Fig.15

Installation in a sliding sash window

1. Cut the foam seal(adhesive type) to the proper length and attach it to the window frame, Fig.12.
2. Attach the window slider kit to the window stool. Adjust the length of the window slider kit according to the width of window, shorten the adjustable window kit if the width of window is less than 26.5 inches. Open the window sash and place the window slider kit on the window stool. See Fig.13.
3. Cut the foam seal(adhesive type) to the proper length and attach it on the top of the window. Shown as in Fig.14.
4. Close the sliding sash securely against the window.
5. Cut the foam seal to an appropriate length and seal the open gap between the top window sash and outer window sash. Shown as in Fig.15.

INSTALLATION INSTRUCTIONS (optional)



Fig. 16

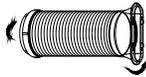

Fig. 17

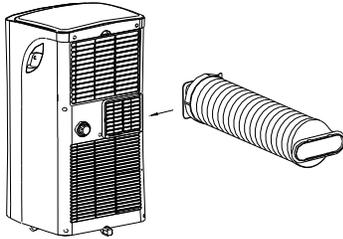

Fig. 18

Exhaust hose installation:

The exhaust hose and adaptor must be installed or removed in accordance with the usage mode.

COOL, AUTO mode	Install
FAN, DEHUMIDIFY mode	Remove

1. Install the window Exhaust adaptor B onto the exhaust hose as shown in Fig. 16. or Fig. 17. Refer to the previous pages for window kit installation.
2. Push the Exhaust hose into the air outlet opening along the the arrow direction(See Fig. 18).

The exhaust hose can be installed into the wall

(Not applicable to units without adaptor A, expansion plugs and wooden screws of Accessories).

1. Prepare a hole in the wall. Install the wall Exhaust adaptor A onto the wall(outside) by using 4 expansion plugs and wooden screws, be sure to fix thoroughly. (See Fig. 19)
2. Attach the Exhaust hose adaptor B(round mouth) to wall Exhaust adaptor A.

Note:

Cover the hole using the adaptor cap when not in use.

- The duct can be compressed or extended moderately according to the installation requirement, but it is desirable to keep the duct length to a minimum.

IMPORTANT:

DO NOT OVER BEND THE DUCT (SEE Fig. 20)

⚠ CAUTION:

Make sure that there is no obstacle around the air outlet of the exhaust hose (in the range of 500mm) so that the exhaust system works properly.

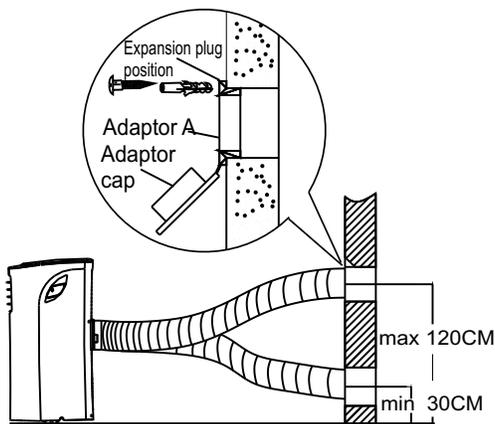

Fig. 19

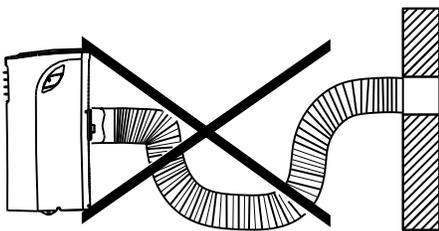

Fig. 20

INSTALLATION INSTRUCTIONS

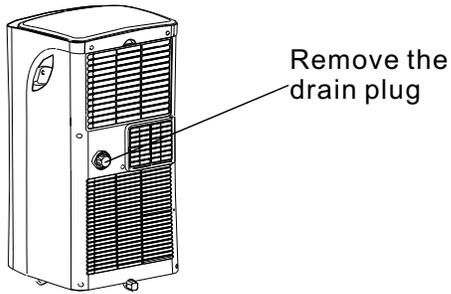

Fig.21

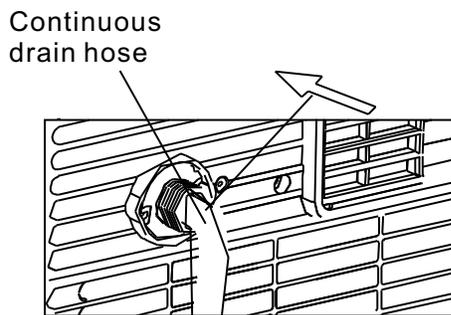

Fig.22

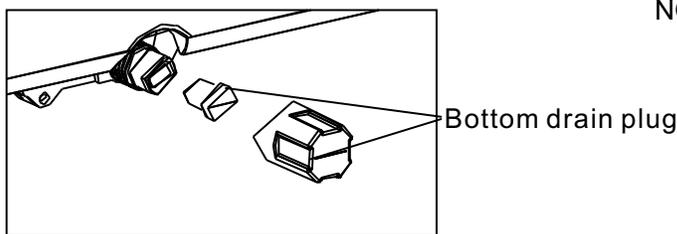

Fig.23

Water drainage:

- During dehumidifying modes, remove the drain plug from the back of the unit, install the drain connector (5/8" universal female mender) with 3/4" hose (locally purchased). For the models without drain connector, just attach the drain hose to the hole. Place the open end of the hose directly over the drain area in your basement floor. Please refer to Fig.21 & 22.

- When the water level of the bottom tray reaches a predetermined level, the unit beeps 8 times, the digital display area shows "P1". At this time the air conditioning/dehumidification process will immediately stop. However, the fan motor will continue to operate (this is normal).

Carefully move the unit to a drain location, remove the bottom drain plug and let the water drain away (Fig.23). Re-install the bottom drain plug and Restart the machine until the "P1" symbol disappears. If the error repeats, call for service.

NOTE: Be sure to reinstall the bottom drain plug before using the unit.

CARE AND CLEANING

Air Filter Cleaning

- Push the vent handle to the Vent Closed position (where applicable). Open the front panel.
- Take the filter by the center and pull up and out.
- Wash the filter using liquid dishwashing detergent and warm water. Rinse filter thoroughly. Gently shake excess water from the filter. Be sure the filter is thoroughly dry before replacing. Or, instead of washing you may vacuum the filter clean.

Note: Never use hot water over 40°C (104°F) to clean the air filter. Never attempt to operate the unit without the air filter.

Cabinet Cleaning

- Be sure to unplug the air conditioner to prevent shock or fire hazard. The cabinet and front may be dusted with an oil-free cloth or washed with a cloth dampened in a solution of warm water and mild liquid dishwashing detergent. Rinse thoroughly and wipe dry.
- Never use harsh cleaners, wax or polish on the cabinet front.
- Be sure to wring excess water from the cloth before wiping around the controls. Excess water in or around the controls may cause damage to the air conditioner.
- Plug in air conditioner.

Winter Storage

If you plan to store the air conditioner during the winter, remove it carefully from the window according to the installation instructions. Cover it with plastic or return it to the original carton.

TROUBLESHOOTING TIPS

Before calling for service, review this list. It may save your time and expense. This list includes common occurrences that are not the result of defective workmanship or materials in this appliance.

Problem	Solution
Air conditioner does not start	<i>Wall plug disconnected. Push plug firmly into wall outlet.</i>
	<i>House fuse blown or circuit breaker tripped. Replace fuse with time delay type or reset circuit breaker.</i>
	<i>Plug Current Device Tripped. Press the RESET button.</i>
	<i>Power is OFF. Turn power ON.</i>
Air from unit does not feel cold enough	<i>Room temperature below 62°F(17°C). Cooling may not occur until room temperature rises above 62°F(17°C).</i>
	<i>Temperature sensing behind air filter element touching cold coil. Keep it from the cold coil.</i>
	<i>Set to a Lower temperature.</i>
	<i>Compressor stopped when changing modes. Wait for 3 minutes after set to the COOL mode.</i>
Air conditioner cooling, but room is too warm- ice forming on cooling coil behind decorative front.	<i>Outdoor temperature below 64°F(18°C). To defrost the coil, set FAN ONLY mode.</i>
	<i>Air filter may be dirty. Clean filter. Refer to Care and Cleaning section. To defrost, set to FAN ONLY mode.</i>
	<i>Thermostat set too cold for night-time cooling. To defrost the coil, set to FAN ONLY mode. Then, set temperature to a Higher setting.</i>

TROUBLESHOOTING TIPS

Problem	Solution
Air conditioner cooling, but room is too warm- NO ice forming on cooling coil behind decorative front.	<i>Dirty air filter- air restricted. Clean air filter. Refer to Care and Cleaning section.</i>
	<i>Temperature is set too High, set temperature to a Lower setting.</i>
	<i>Air directional louvers positioned improperly. Position louvers for better air distribution.</i>
	<i>Front of units is blocked by drapes, blinds, furniture, etc. - restricts air distribution. Clear blockage in front of unit.</i>
	<i>Doors, windows, registers, etc. Open- cold air escapes. Close doors, windows, registers.</i>
	<i>Unit recently turned on in hot room. Allow additional time to remove " Stored heat" from walls, ceiling, floor and furniture.</i>
Air conditioner turns on and off rapidly	<i>Dirty air filter- air restricted. Clean air filter.</i>
	<i>Outside temperature extremely hot. Set FAN speed to a Higher setting to bring air past cooling coils more frequently.</i>
Noise when unit is cooling	<i>Air movement sound. This is normal . If too loud, set to a slower FAN setting.</i>
	<i>Window vibration - poor installation. Refer to installation instructions or check with installer.</i>
Water dripping INSIDE when unit is cooling.	<i>Improper installation. Tilt air conditioner slightly to the outside to allow water drainage. Refer to installation instructions - check with installer.</i>
Water dripping OUTSIDE when unit is cooling.	<i>Unit removing large quantity of moisture from humid room. This is normal during excessively humid days.</i>
Remote Sensing Deactivating Prematurely (some models)	<i>Remote control not located within range. Place remote control within 20 feet & 180°, radius of the front of the unit.</i>
	<i>Remote control signal obstructed. Remove obstruction.</i>
Room too cold	<i>Set temperature too low. Increase set temperature.</i>

Due to ongoing product improvements, specifications and dimensions are subject to change and correction without notice or incurring obligations. Determining the application and suitability for use of any product is the responsibility of the installer. Additionally, the installer is responsible for verifying dimensional data on the actual product prior to beginning any installation preparations.

Incentive and rebate programs have precise requirements as to product performance and certification. All products meet applicable regulations in effect on date of manufacture; however, certifications are not necessarily granted for the life of a product. Therefore, it is the responsibility of the applicant to determine whether a specific model qualifies for these incentive/rebate programs.



1900 Wellworth Ave. • Jackson, MI 49203
517.787.2100 • www.marsdelivers.com • www.heatcontroller.com