



Protecting Building Utility Systems From Flood Damage

Principles and Practices for the Design and Construction of
Flood Resistant Building Utility Systems

FEMA P-348, Edition 2 / February 2017



FEMA

About the Cover

There are various approaches to protect building utilities from flood damage. The photograph on the left shows an elevated water heater in the garage of a Florida residence, taken by Steve Martin of the Florida Floodplain Management Office and used with permission. The FEMA photograph on the top right shows two elevated air conditioning compressors outside a North Carolina residence. The FEMA photograph on the bottom right shows a floodproofed fuel pump enclosure in a New York City commercial high-rise following Hurricane Sandy. Note these same cover photographs can be found on the banner at the start of each section of the publication, along with a fourth FEMA photograph showing elevated boilers in a New Jersey fire station following Hurricane Sandy.

All other photographs in this document are public domain or taken by FEMA or a FEMA contractor.

All illustrations or comments in this document were created by FEMA or a FEMA contractor unless otherwise noted.

Questions on this manual are welcome and should be addressed to FEMA Building Science (<http://www.fema.gov/building-science>) through the FEMA Building Science Helpline at FEMA-Buildingsciencehelp@fema.dhs.gov or call (866) 927-2104.



Protecting Building Utility Systems From Flood Damage

Principles and Practices for the Design and
Construction of Flood Resistant Building
Utility Systems

FEMA P-348, Edition 2 / February 2017



FEMA



Acknowledgements

Authors and Key Contributors

David K. Low, P.E., DK Low and Associates
Deborah Mills, CFM, Dewberry
Rebecca Quinn, CFM, RCQuinn Consulting
Adam Reeder, P.E., CFM, CDM Smith
John Squerciati, P.E., CFM, Dewberry

Reviewers and Contributors

Stuart Adams, CFM, Stantec
Daniel Bass, RA, CFM, FEMA Headquarters
Emily Booth, E.I.T., CFM, CDM Smith
Larry Buss, ASFPM
Diana Castro, AECOM
William Coulbourne, P.E., SE, AECOM
Gary Ehrlich, National Association of Homebuilders
Mark Heinrich, P.E., LEED AP BD+C, Dewberry
John Ingargiola, E.I.T., CFM, CBO, FEMA Headquarters
Russell James, P.E., LEED AP BD+C, Dewberry
Laurel McGinley, P.E., Dewberry
Kim Paarlberg, International Code Council
Manuel Perotin, P.E., CDM Smith
John “Bud” Plisich, FEMA Region IV
George Riedel, CFM, Michael Baker Corporation
Adrienne Sheldon, P.E., CFM, AECOM

ACKNOWLEDGEMENTS

Dan Spafford, FEMA Headquarters

Pat Suber, FEMA Headquarters

French Wetmore, CFM, French & Associates

Gregory Wilson, CFM, FEMA Headquarters

Stacy Wright, AICP, CFM, Atkins

Technical Editing, Layout and Illustration

Erin Ashley, PhD, LEED AP, Atkins

Jennifer Hill, Dewberry

Julie Liptak, Stantec

Lee-Ann Lyons, AECOM

Daniel Medina, PhD, P.E., CFM, Atkins

Samuel Rosenberg, Dewberry

Billy Rupert, AECOM



Table of Contents

Acknowledgements	i
Acronyms	xi
1.0 Introduction – Building Systems and Flood Hazards	1-1
1.1 Intended Audience	1-2
1.2 How to Use this Publication	1-2
1.2.1 Basic Process	1-2
1.2.2 Icons	1-3
1.3 Background.....	1-3
1.3.1 The National Flood Insurance Program (NFIP).....	1-3
1.3.2 Regulated Flood Hazard Areas.....	1-4
1.3.3 Risk Assessment and Risk Reduction	1-7
1.4 Flood Hazard Characteristics and Flood Loads	1-9
1.4.1 Flood Elevation or Flood Depth	1-9
1.4.2 Flood Velocity	1-10
1.4.3 Wave Loads	1-10
1.4.4 Other Impacts of Flooding	1-11
1.5 NFIP Flood Insurance Considerations	1-13
2.0 Regulatory Framework – NFIP Regulations and Building Codes	2-1
2.1 NFIP Regulations for Building Systems/Utilities.....	2-1
2.2 Achieving Compliance – New Construction, Substantial Improvement and Substantial Damage	2-2

TABLE OF CONTENTS

2.3 Compliance Not Required – Non-Conforming Existing Buildings, No Substantial Improvement or Substantial Damage 2-3

2.4 Building Codes..... 2-4

2.5 Standards..... 2-6

2.6 Building Occupancies 2-7

 2.6.1 Residential 2-8

 2.6.2 Non-Residential..... 2-8

3.0 Compliance and Mitigation Measures 3-1

3.1 Elevation and Relocation 3-1

3.2 Component Protection..... 3-3

 3.2.1 Protection of Exposed Risers, Conduits, and Cables 3-6

 3.2.2 Protection of Duct Systems 3-7

 3.2.3 Specially Designed Equipment 3-7

3.3 Other Mitigation Options – Partial Protection Measures 3-8

 3.3.1 Flood Damage-Resistant Materials 3-8

 3.3.2 Fast Replacement of Components 3-8

 3.3.3 Emergency Measures..... 3-9

 3.3.4 Quick-Connect Mechanisms 3-11

 3.3.5 Summary of Mitigation Concepts for Building Utility Systems..... 3-11

4.0 Mitigation Measures for Residential Buildings 4-1

4.1 Heating, Ventilation and Air Conditioning (HVAC) 4-6

 4.1.1 Flood Risks to HVAC Components 4-8

 4.1.2 Mitigation for HVAC Components 4-10

 4.1.2.1 Mitigation for Primary Components..... 4-13

 4.1.2.2 Mitigation for Secondary Components 4-17

4.2 Electrical Systems 4-21

 4.2.1 Flood Risks to Electrical Systems 4-24

 4.2.2 Mitigation for Electrical Systems..... 4-25

 4.2.2.1 Mitigation for Primary Components 4-25

 4.2.2.2 Mitigation of Secondary Components 4-28

4.2.2.3	Mitigation of Miscellaneous Electrical Systems	4-30
4.2.2.4	Other Mitigation Considerations for Electrical Systems	4-30
4.3	Plumbing Systems.....	4-31
4.3.1	Flood Risks to Plumbing Systems.....	4-35
4.3.2	Mitigation for Plumbing Systems.....	4-35
4.3.2.1	Mitigation for Private Wells.....	4-39
4.3.2.2	Mitigation for Onsite Waste Disposal Systems.....	4-40
4.3.3	Mitigation for Fire Protection Systems.....	4-41
4.3.4	Mitigation for Pools and Spas.....	4-42
4.4	Fuel Systems and Tanks.....	4-43
4.4.1	Flood Risk to Fuel Systems and Tanks.....	4-45
4.4.2	Mitigation for Fuel Systems and Tanks	4-47
4.5	Conveyances – Elevators and Lifts	4-51
4.5.1	Mitigation Measures for Elevators	4-53
4.5.2	Mitigation Measures for Lifts	4-54
5.0	Mitigation Measures for Non-Residential Buildings	5-1
5.1	Heating, Ventilation and Air Conditioning (HVAC)	5-7
5.1.1	Flood Risks to HVAC Components	5-11
5.1.2	Mitigation for HVAC Components	5-12
5.1.2.1	Mitigation for Primary Components.....	5-12
5.1.2.2	Mitigation for Secondary Components	5-15
5.2	Electrical Systems	5-18
5.2.1	Flood Risks to Electrical Systems	5-22
5.2.2	Mitigation for Electrical Systems.....	5-22
5.2.2.1	Mitigation for Primary Components	5-22
5.2.2.2	Mitigation for Secondary Components	5-25
5.2.2.3	Mitigation for Emergency and Standby Power Systems.....	5-25
5.2.2.4	Mitigation for Miscellaneous Electrical Systems.....	5-27
5.3	Plumbing Systems.....	5-28
5.3.1	Flood Risks to Plumbing Systems.....	5-30
5.3.2	Mitigation for Potable Water Systems	5-30

TABLE OF CONTENTS

5.3.2.1	Mitigation for Primary Components.....	5-30
5.3.2.2	Mitigation for Secondary Components	5-32
5.3.3	Mitigation for Drain, Waste and Vent (DWV) Systems.....	5-32
5.3.4	Mitigation for Fire Suppression Systems	5-35
5.3.5	Mitigation for Pools and Spas	5-36
5.4	Fuel Systems and Tanks.....	5-37
5.4.1	Flood Risk to Fuel Systems.....	5-39
5.4.2	Mitigation for Fuel Systems and Tanks	5-39
5.5	Conveyances – Elevators and Escalators	5-43
5.5.1	Mitigation for Elevators.....	5-46
5.5.2	Mitigation for Escalators	5-47

Appendices

Appendix A – FEMA Assistance.....	A-1
Appendix B – References	B-1
Appendix C – Resources	C-1
Appendix D – FEMA Offices.....	D-1

Figures

Figure 1-1.	Basic utility flood protection decision process flow chart.....	1-3
Figure 1-2.	Conceptual FIRM showing representative riverine flood zones.	1-6
Figure 1-3.	Conceptual FIRM showing representative coastal flood zones.	1-7
Figure 1-4.	Hydrostatic forces.....	1-9
Figure 1-5.	Hydrodynamic forces.	1-10
Figure 1-6.	Flood-borne debris impact.....	1-11
Figure 3-1.	Air conditioning compressor elevated on a pedestal.	3-2
Figure 3-2.	Air conditioning compressor elevated on a cantilevered platform.....	3-2
Figure 3-3.	Protective flood barrier surrounding shed housing back-up power generator.	3-4
Figure 3-4.	Dry floodproofing with a substantially impermeable watertight wall and access gate used to protect mechanical and plumbing equipment.....	3-6
Figure 3-5.	Techniques for proper placement of sandbags	3-10
Figure 3-6.	Gravel-filled containers formed a barrier to protect University of Iowa facilities during a flood event. (2008)	3-10

Figure 3-7. Portable boiler provides heat during repair of flood damage3-11

Figure 4-1. Example of a residence supplied by two forced-air HVAC systems.4-7

Figure 4-2. Elevated HVAC condenser units in a coastal zone with a protective railing installed (Galveston Island, Texas).4-12

Figure 4-3. Elevated HVAC condenser unit on cantilevered platform (Port Bolivar, Texas).4-12

Figure 4-4. Placing the interior HVAC unit on an elevated platform and placing the exterior units at a higher grade provides greater protection from flooding.4-13

Figure 4-5. Replacing a vertical style interior HVAC unit with an elevated horizontal style unit and placing exterior units at a higher grade provides greater protection from flooding. ...4-14

Figure 4-6. Relocating the basement HVAC unit to the first floor and placing exterior units at a higher grade provides greater flood protection than in-place elevation.....4-15

Figure 4-7. Dry floodproofing with a substantially impermeable watertight wall and access gate used to protect mechanical and plumbing equipment.....4-16

Figure 4-8. Alternate dry floodproofing methods for protecting equipment.....4-17

Figure 4-9. Creating a concealed soffit to allow a duct trunkline to be relocated4-20

Figure 4-10. Typical residential electrical system.4-21

Figure 4-11. Typical residential electrical system with an on-site standby generator.4-23

Figure 4-12. Combination meter socket and circuit breaker service disconnect used to allow a main panel to be elevated and protected from flooding when the electrical meter cannot be moved.....4-26

Figure 4-13. Home with elevated standby generator, transfer switch and normal/emergency panel. The utility meter and branch circuits below the flood protection level remain vulnerable to damage.4-27

Figure 4-14. Flanged connection (quick connect) for connecting temporary generator (Milford, DE).....4-27

Figure 4-15. Deck provides meter access and allows the meter and main service panel to be elevated and protected from flooding. Electrical components placed below the flood protection level remain vulnerable to flood damage.....4-28

Figure 4-16. Elevating electrical components and routing wiring above the flood protection level protects several primary and secondary electrical components from flood damage.4-29

Figure 4-17. Placing electrical components to reduce risk from moving floodwater.4-30

Figure 4-18. Typical residential plumbing system configuration for a home served by a municipal domestic water system.4-31

Figure 4-19. Components of an on-site potable water system supplied by a well.4-32

Figure 4-20. DWV system that discharges into a municipal sanitary sewer line.....4-33

Figure 4-21. DWV system that discharges into an onsite waste disposal (septic) system.....4-34

Figure 4-22. Relocation of a primary plumbing system components to an upper floor.4-36

TABLE OF CONTENTS

Figure 4-23. Floor drain with ball float check valve.....4-38

Figure 4-24. Combination gate and check valve.4-39

Figure 4-25. Sanitary well cap4-39

Figure 4-26. Concrete well cap and the uppermost section of concrete casing.4-39

Figure 4-27. Septic tank with lids and gasketed access covers, concrete risers, and riser caps.....4-41

Figure 4-28. Typical elements of a residential fuel oil system.....4-44

Figure 4-29. Typical elements of a residential flammable gas system – liquid propane (LP) with tank and pressure regulator (left side); natural gas (NG) with meter (right side).4-45

Figure 4-30. Elevation of fuel system components raises the flood protection level.4-47

Figure 4-31. Protecting fuel piping from moving floodwater.4-48

Figure 4-32. Fuel tank elevated on a supporting frame4-49

Figure 4-33. Fuel tank elevated on structural fill.....4-49

Figure 4-34. An underground fuel tank with sealed cover. Concrete used to resist buoyancy.4-50

Figure 4-35. Above-ground tank secured with helical earth anchors.....4-50

Figure 4-36. Typical elements of hydraulic elevators (left) and traction elevators (right). (Source: Otis Elevator Company).4-52

Figure 4-37. Residential coastal building with passenger lift circled in red.4-53

Figure 4-38. Float switch to control cab descent. (Source: Otis Elevator Company).4-54

Figure 5-1. Primary components of a non-residential, hydronic HVAC system. Note that HVAC components on upper floors are not shown on this simplified graphic.5-7

Figure 5-2. Indoor water-cooled chiller (left) with rooftop evaporative cooling tower (right) in Bridgeville, Delaware.....5-9

Figure 5-3. Air-Cooled rooftop chiller in Georgetown, Delaware.5-9

Figure 5-5. Dual fuel (fuel oil and propane) boiler, Dagsboro, Delaware.5-10

Figure 5-4. Chilled water pump, Georgetown, Delaware.5-10

Figure 5-5. Dual fuel (fuel oil and propane) boiler, Dagsboro, Delaware.....5-10

Figure 5-6. AHU with a separate chilled water coil (green labels) and hot water coil (yellow labels). The coils are within the unit and are not visible. (Dagsboro, Delaware)5-11

Figure 5-7. Cooling tower placed on an elevated frame. Port Bolivar, Texas. (Hurricane Ike, October 18, 2008.)5-13

Figure 5-8. In-Place Equipment Elevation of primary HVAC components elevated on supports or frames. Note the source of the flooding in the basement areas can greatly impact the effectiveness of flood protection measures.5-14

Figure 5-9. Flood risk reduced by relocating primary HVAC components from a subgrade basement level to a higher floor.5-15

Figure 5-10. Simplified diagram depicting primary components of a non-residential electrical system..... 5-20

Figure 5-11. Electrical schematic/riser diagram for a typical non-residential building..... 5-21

Figure 5-12. Simplified diagram showing primary components of a non-residential electrical system mitigated by in-place elevation. Note the source of flooding in basement areas can greatly impact the effectiveness of flood protection measures..... 5-24

Figure 5-13. Simplified diagram showing primary electrical system components mitigated by relocation to higher floors..... 5-24

Figure 5-14. Example of protected emergency power system components. The BFE (shown approximately in red) is below the second floor so primary components of the electrical system were elevated well above the required flood elevation..... 5-26

Figure 5-15. Exterior view (top left) and interior views (bottom right) of elevated emergency generator and switchgear at medical center in Galveston, TX. Figure 5-14 is an exterior view of the electric room..... 5-26

Figure 5-16. Simplified plumbing systems in a non-residential building..... 5-29

Figure 5-17. Placement recommendation for water meters exposed to moving floodwater. 5-31

Figure 5-18. Combination check valve and gate valve. 5-34

Figure 5-19. Floor drain with ball float check valve..... 5-35

Figure 5-20. Fire protection piping and sprinkler heads installed along the building ceiling 5-35

Figure 5-21. Typical elements of a non-residential building supplied with liquid fuel or flammable gas. 5-38

Figure 5-22. Fuel tank and fuel equipment protected within a flood-resistant vault..... 5-41

Figure 5-23. Fuel tank placed in floodproof vault in basement of commercial high-rise (New York, NY). ... 5-41

Figure 5-24. Protection of fuel system components exposed to moving floodwaters. 5-42

Figure 5-25. Typical elements of non-residential and large residential hydraulic elevators (left) and traction elevators (right) (Source: Otis Elevator Company)..... 5-44

Figure 5-26. Typical elements of an escalator (Source: Otis Elevator Company)..... 5-45

Figure 5-27. Float switch to control cab descent (Source: Otis Elevator Company)..... 5-46

Figure 5-28. Hydraulic elevator in New York City hospital flooded during Hurricane Sandy..... 5-47

Figure A-1. HMA grants cycle process and the roles and responsibilities of FEMA and State and local governments. A-4

Figure D-1. FEMA Regions and locations of Regional Offices. D-1

Tables

Table 2-1. Summary of I-Code and standard references for building utility systems in flood hazard areas.. 2-7

Table 3-1. Summary of Mitigation Concepts for Building Utility Systems. 3-12

Table 4-1. Summary of utility mitigation measures for residential buildings..... 4-3

Table 4-2. Typical primary and secondary components of residential HVAC Systems..... 4-8

TABLE OF CONTENTS

Table 4-3.	Typical primary and secondary components of a residential electrical system.	4-24
Table 4-4.	Typical elements of residential plumbing systems.....	4-34
Table 4-5.	Typical elements of residential fuel systems.	4-43
Table 4-6.	Typical elements of conveyances	4-53
Table 5-1.	Summary of utility mitigation measures for non-residential buildings.....	5-5
Table 5-2.	Typical elements of non-residential HVAC systems.....	5-8
Table 5-3.	Typical elements of a non-residential electrical system.	5-21
Table 5-4.	Typical elements of non-residential plumbing systems.	5-28
Table 5-5.	Typical elements of non-residential fuel systems.....	5-37
Table 5-6.	Typical elements of non-residential conveyances.....	5-43
Table A-1.	Flood Mitigation Projects Eligible for Funding Under HMA Programs.....	A-3
Table A-2.	Cost-Share Requirements for the HMA Program Grants.....	A-5
Table A-3.	Eligibility of Subapplicants for HMA Program Grants.....	A-5
Table A-4.	Summary of FEMA assistance resources.....	A-9
Table D-1.	FEMA Region Contact Information	D-1



List of Acronyms

A

AC	Air conditioning
AHU	Air handling unit
ASCE	American Society of Civil Engineers
ATS	Automatic transfer switch
AWC	American Wood Council

B

BCA	Benefit-Cost Analysis
BCR	Benefit-Cost Ratio
BFE	Base Flood Elevation
BW-12	Biggert-Waters Flood Insurance Reform Act of 2012

C

CATV	Cable television
CAZ	Coastal A Zone
CCTV	Closed circuit television
CFM	Cubic feet per minute
CFR	Code of Federal Regulations

D

DFE	Design Flood Elevation
DWV	Drain, waste, and vent
DX	Direct expansion

E

EMS	Emergency Medical Services
ERV	Energy Recovery Ventilator

F

FEMA	Federal Emergency Management Agency
FIRM	Flood Insurance Rate Map
FIS	Flood Insurance Study
FMA	Flood Mitigation Assistance

G

GFCI	Ground-fault circuit interrupter
------	----------------------------------

H

HFIAA	Homeowner Flood Insurance Affordability Act (2014)
HMA	Hazard Mitigation Assistance
HMGF	Hazard Mitigation Grant Program
HRV	Heat Recovery Ventilator
HVAC	Heating, ventilation and air conditioning

I

I-Codes	The International Codes
IAPMO	International Association of Plumbing and Mechanical Officials
IBC	International Building Code
ICC	Increased Cost of Compliance
ICC	International Code Council
IEBC	International Existing Building Code
IFGC	International Fuel Gas Code
IMC	International Mechanical Code
IPC	International Plumbing Code
IPSDC	International Private Sewage Disposal Code
IRC	International Residential Code
ISPCS	International Swimming Pool and Spa Code
IT	Information technology

L

LiMWA	Limit of Moderate Wave Action
LP	Liquid propane

M

MEP	Mechanical, Electrical, and Plumbing
MSC	FEMA Flood Map Service Center
MTS	Manual transfer switch

N

NEC	National Electric Code (NFPA 70)
NEMA	National Electrical Manufacturers Association
NFIP	National Flood Insurance Program
NFPA	National Fire Protection Association
NG	Natural gas
NIOSH	National Institute for Occupational Safety & Health
NWS	National Weather Service

P

PA	Public Assistance
PDM	Pre-Disaster Mitigation
PNP	Private nonprofit organization
PRP EE	Preferred Risk Policy Eligibility Extension
psi	Pounds per square inch
PVC	Polyvinyl chloride

S

SD	Substantial Damage
SFHA	Special Flood Hazard Area
SI	Substantial Improvement

U

UMC	Uniform Mechanical Code
UPC	Uniform Plumbing Code

LIST OF ACRONYMS

USEC Uniform Solar Energy Code
USPSHTC Uniform Swimming Pool, Spa and Hot Tub Code

V

VPL Vertical platform lift

W

WFCM Wood Frame Construction Manual



1.0 Introduction – Building Systems and Flood Hazards

During the past 30 years, flooding in the U.S. has resulted in an annual average of nearly \$8 billion in flood losses (adjusted for inflation) and 82 fatalities (NWS, 2015). Because of anticipated changes in climate conditions, stronger storms and rising sea levels, flood risk to coastal and interior flood-prone areas is only expected to increase, along with its associated losses (U.S. Global Change Research Program, 2014).

A significant portion of flood damage is attributed to critical building systems including mechanical, electrical, plumbing and other utility elements. Residents, communities and businesses are all impacted when building utility systems are damaged and cause delays in post-flood building re-occupancy.

This publication illustrates the design and construction of utility systems that comply with the National Flood Insurance Program (NFIP) requirements for construction of new residential and non-residential structures in flood-prone areas. It is also useful when evaluating structures that will undergo Substantial Improvement (see Note on page 1-4), guiding users to meet floodplain management regulations and building code requirements. Even if compliance is not required, many building owners may find that applying mitigation measures described in this publication will not only reduce future flood damage, but also facilitate recovery after flooding.

This publication addresses mitigation measures for the following building system utilities, equipment, and equipment components:

- **Mechanical equipment and appliances:** heating and cooling equipment and appliances, exhaust systems, duct systems, boilers and water heaters, hydronic piping, and solar energy systems
- **Electrical systems:** service equipment, feeders, panelboards, switches, fuse boxes, cabinets and control panels, outlets, receptacles, wiring, and emergency power generators



NOTE

When a building system, equipment or equipment component is mentioned in this publication, every element and component is included, even if not specifically mentioned or listed here.

- **Communications:** telephone, cable, fiber optic, internet, and Wi-Fi systems.
- **Plumbing:** water supply piping, water treatment systems, sanitary drainage, fixtures, laundry appliances, plumbing vents, septic tanks, fire protection systems, and pumps and equipment for pools and spas.
- **Water supply systems:** wells, water connections, and filtration and treatment systems.
- **Fuel systems:** fuel gas and oil supply pipes, oil tanks, propane tanks, meters, pumps, and gas and oil-fired equipment, and appliances.
- **Conveyances:** elevators, escalators, and lifts.

In addition, the best practices presented in this publication will improve community resilience and function through:

- Reduced vulnerability of building system utilities to flooding
- Reduced recovery time, occupant displacement, and business downtime
- Potential reduced NFIP insurance premiums
- Increased peace of mind

1.1 Intended Audience

This publication is intended for use by people responsible for designing, constructing, operating, or maintaining residential and non-residential buildings, and by local officials responsible for enforcing floodplain management regulations and building codes. Chapters 1, 2, 3, and 4 are of interest to local officials, building owners and architects, engineers, builders, and contractors for residential buildings. Chapters 1, 2, 3, and 5 are of value to local officials, building owners, architects, engineers, builders, contractors and property managers of non-residential buildings and multi-family buildings.

As used in this publication, “residential buildings” refers to detached one- and two-family dwellings and townhouses not more than three stories in height, which are dwellings within the scope of the *International Residential Code*[®] (IRC[®]).

As used in this publication, “non-residential buildings” are all structures within the scope of the *International Building Code*[®] (IBC[®]), which are structures not within the scope of the IRC. These buildings include, but are not limited to: health care facilities, public safety buildings (e.g., police, fire, and EMS), government buildings, schools, college and university campus structures, shopping centers, manufacturing sites, commercial office buildings, etc. Notably, residential buildings that exceed the limits of the IRC are within the scope of the IBC. See Section 2.6 for a discussion of building occupancies and the terms “residential” and “non-residential.”

1.2 How to Use this Publication

1.2.1 Basic Process

When planning and, ultimately, installing building utility systems, the basic process illustrated in Figure 1-1 should be followed to ensure selection of appropriate flood risk reduction measures for building utility systems that satisfy building code requirements, manufacturer specifications, and local floodplain management regulations.

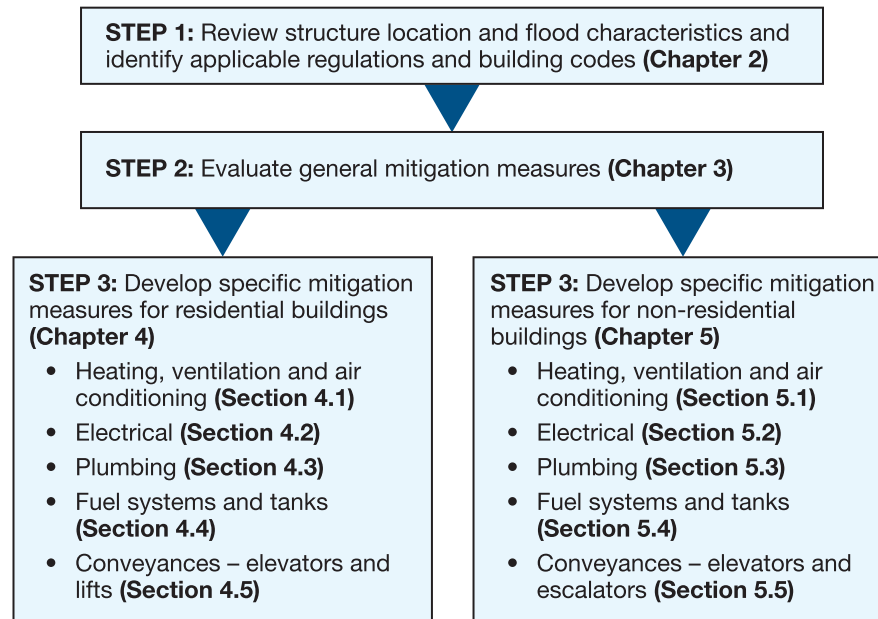

Figure 1-1. Basic utility flood protection decision process flow chart.

1.2.2 Icons

The following icons are used to signal information that emphasizes specific points.



Note: Contains important information or references.



Warning: Highlights potential dangers or concerns.

1.3 Background

1.3.1 The National Flood Insurance Program (NFIP)

The NFIP is a Federal program that was established by the National Flood Insurance Act of 1968 to respond to increased national flood recovery costs during the mid-twentieth century. Owners of property located in communities that participate in the NFIP are able to purchase Federal insurance as protection against flood losses. Flood insurance pays claims when a qualifying flood event occurs. Federal disaster assistance is only available if flooding is declared a major disaster by the President.

Participation in the NFIP is based on an agreement between individual States, Tribes, and communities and the Federal Government. To participate in the NFIP, a community must adopt and enforce floodplain management regulations that meet or exceed the NFIP minimum requirements.

NFIP requirements for buildings and structures located in the identified Special Flood Hazard Area (SFHA) are in 44 Code of Federal Regulations Section 60.3 (44 CFR §60.3). The criteria require that new construction and Substantially Improved structures be built with electrical, heating, ventilation, plumbing and air conditioning equipment and that other service facilities be designed and/or located to prevent water from accumulating in their components during flooding [44 CFR §60.3(a)(3)(iv)]. 44 CFR §60.3 continues with the provision that all public utilities and facilities such as sewer, gas, electrical, and water systems are to be located and constructed to minimize flood damage [see §60.3(a)(4)(ii)] and provides specific requirements for water supply systems [§60.3(a)(5)] and sanitary sewage and onsite waste disposal systems [§60.3(a)(6)].

The NFIP regulations and model building codes require adherence to requirements for new construction and Substantial Improvement located in SFHAs. The design and installation guidance in this publication is also applicable to structures that are not required to comply with those requirements, such as those outside of the SFHA and those that do not have improvement or repair costs exceeding 50 percent of their current market value (see Note on this page).

1.3.2 Regulated Flood Hazard Areas

The NFIP Risk Standard: The One-Percent-Annual-Chance Flood

The NFIP can offer affordable flood insurance by using risk management (floodplain management) principles to reduce flood losses. The Federal Government established the standard for mapping and regulating flood risk to be the one-percent-annual-chance flood, also referred to as the “base flood” and sometimes called the “100-year flood.” The base flood represents a magnitude and frequency that has a 1 percent chance of being equaled or exceeded in any given year. A flood of this magnitude has a 26 percent (1 in 4) chance of occurring over the life of a 30-year mortgage. The one-percent-annual-chance flood standard has been used since the NFIP’s inception and is used in more than 22,200 participating communities.



NOTE

Substantial Improvement is any repair, rehabilitation, addition or other improvement of a structure, the cost of which equals or exceeds 50 percent of its market value before the “start of construction” of the improvement. This includes structures that have incurred **Substantial Damage**, regardless of the actual repair work performed or the reason for the damage.

Some communities have adopted a cumulative Substantial Improvement value, tracking the cost of improvements over time. See your building official or floodplain administrator for more information.

Additional information on meeting requirements for building systems and utilities follows in this chapter and Chapters 2, 3, 4, and 5.



NOTE

Base Flood Elevation (BFE) – The elevation of the base flood relative to the datum specified on a community’s Flood Insurance Rate Map (FIRM). In any given year, there is a one-percent chance that the base flood will be equaled or exceeded. The BFE is the NFIP’s minimum elevation used for design and construction of buildings. Areas affected by the base flood are shown as Special Flood Hazard Areas (SFHAs) on FIRMs.

Design Flood Elevation (DFE) – The elevation of the design flood relative to the datum specified on a community’s flood hazard map. This elevation is the higher of the base flood or the value designated for a flood hazard area on a community flood map or otherwise designated. Communities may designate another flood elevation in order to regulate based on a flood of record, to account for future increases in flood levels based on upland development or to incorporate freeboard. The International Codes® (I-Codes®) and the American Society of Civil Engineers (ASCE) Standard *Flood Resistant Design and Construction* (ASCE 24) use this term.

Freeboard – An added margin of safety expressed in feet above a specific flood elevation, usually the BFE. Some States, Tribes, and many community regulations require freeboard. Freeboard can account for unknown factors, future development and floods higher than the base flood. For example, if a regulation or code requires a two-foot freeboard, then new construction and Substantially Improved buildings and their utility systems must be elevated or floodproofed to a minimum of two feet above the BFE. The I-Codes and ASCE 24 incorporate additional height into building elevation requirements.

Flood Protection Level – The level (elevation) of the flood used in design of buildings, including building utility systems, equipment and equipment components. As used in this publication, the flood protection level refers to the elevation required by the NFIP, building codes, or locally-adopted regulations. In addition, flood protection level refers to the level selected to provide the desired level of protection when compliance with a code or regulation is not required and designers and owners elect to elevate or protect building utility systems.

The Regulated Floodplain: The Special Flood Hazard Area (SFHA)

Floodplains are areas subject to inundation from floodwaters. The Federal Emergency Management Agency (FEMA) prepares Flood Insurance Studies (FISs) and defines and delineates areas at risk for one-percent-annual-chance flooding on Flood Insurance Rate Maps (FIRMs). These areas are called Special Flood Hazard Areas (SFHAs). Communities that participate in the NFIP adopt FISs and associated FIRMs, which are then used to regulate development. FISs are prepared using specified engineering models and the physical, hydrologic, and climate conditions in effect at the time the studies were conducted. The resulting FIRMs are drawn incorporating the FIS data. FIRMs and FISs are thus a “snapshot” of flood risk at a certain time, and can become outdated as topographic, hydrologic, land use or climate conditions change or as engineering methods, data collection and



NOTE

SFHAs shown on FIRMs indicate areas subject to floodplain management regulations. They also show where the purchase of flood insurance is mandatory for buildings financed through federally-backed mortgages and by some other lenders.

models improve. The FIS, FIRMs and associated flood data adopted by communities are referred to as “effective” until replaced by a new FIS or FIRM.

Figures 1-2 and 1-3 illustrate how riverine and coastal flood zones are delineated on FIRMs. Flood zone designations reflect the nature of the flood conditions expected during the base flood. Where detailed studies are prepared, FIRMs also show base flood elevations, or BFEs. In the absence of detailed studies, SFHAs without BFEs are delineated using the best available information.

In inland communities (Figure 1-2), SFHAs subject to riverine flooding are identified as Zone A. Some FIRMs show floodways along waterways for which detailed studies have been prepared. Floodways are channels and adjacent land areas that must be reserved in order to convey the base flood without cumulatively increasing the water surface elevation more than a designated height (usually one foot). FIRMs also show shaded Zone X areas that are outside the SFHA but are subject to flooding with a 0.2-percent-annual chance of occurrence (also called the 500-year flood). Unshaded Zone X areas are land areas at higher elevations than SFHAs and shaded Zone X areas.

In coastal areas (Figure 1-3), SFHAs identified as Zone V are subject to inundation as well as wave heights of 3.0 feet and higher. SFHAs inland of Zone V, or inland of shorelines where Zone V is not delineated, are identified as Zone A. The Limit of Moderate Wave Action (LiMWA), delineated on FIRMs prepared after 2009, is the inland limit of the 1.5-foot base flood wave height. The Zone A area seaward of the LiMWA is known as a Coastal A Zone. Wave heights between 1.5 and 3.0 feet are expected during the base flood in Coastal A Zones.

Online Access to the FEMA Map Service Center

The FEMA Flood Map Service Center (MSC) is the official public source for flood hazard information produced in support of the NFIP. Use of the MSC enables owners, engineers, architects, builders and government officials to find official flood maps, access a range of other flood hazard products, and take advantage of tools to more clearly understand the flood risk for specific structures and sites. The MSC can be accessed at <http://msc.fema.gov/portal>. Technical support is available at 1-877-FEMA-MAP or 1-877-336-2627 from 8:00 AM to 6:30 PM, Eastern Time, Monday through Friday.

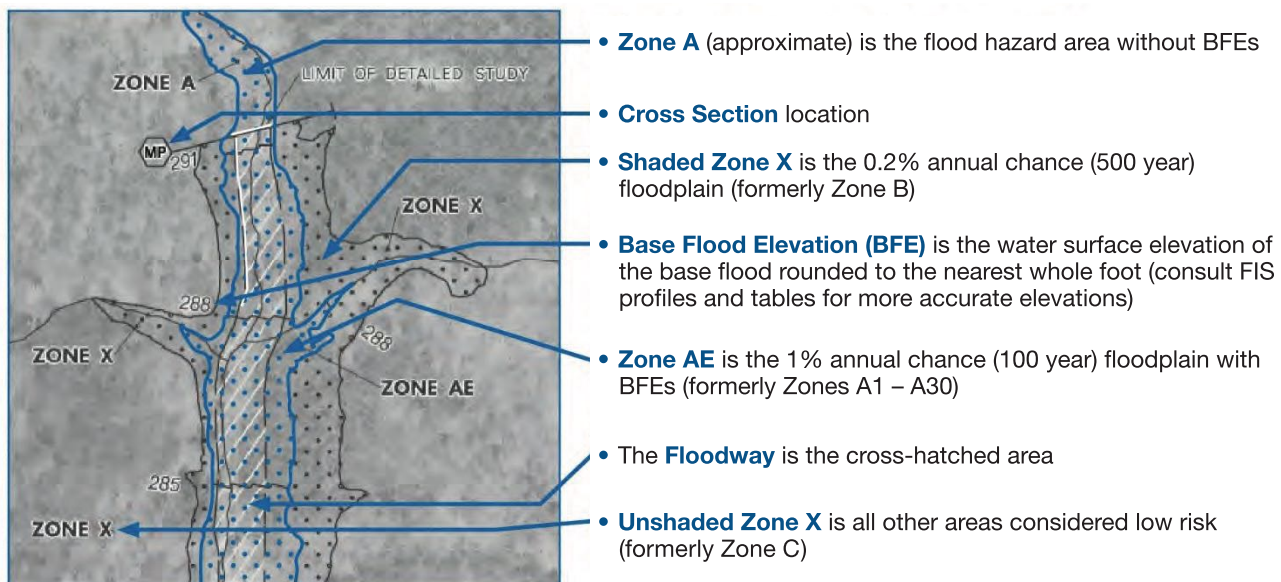

Figure 1-2. Conceptual FIRM showing representative riverine flood zones.

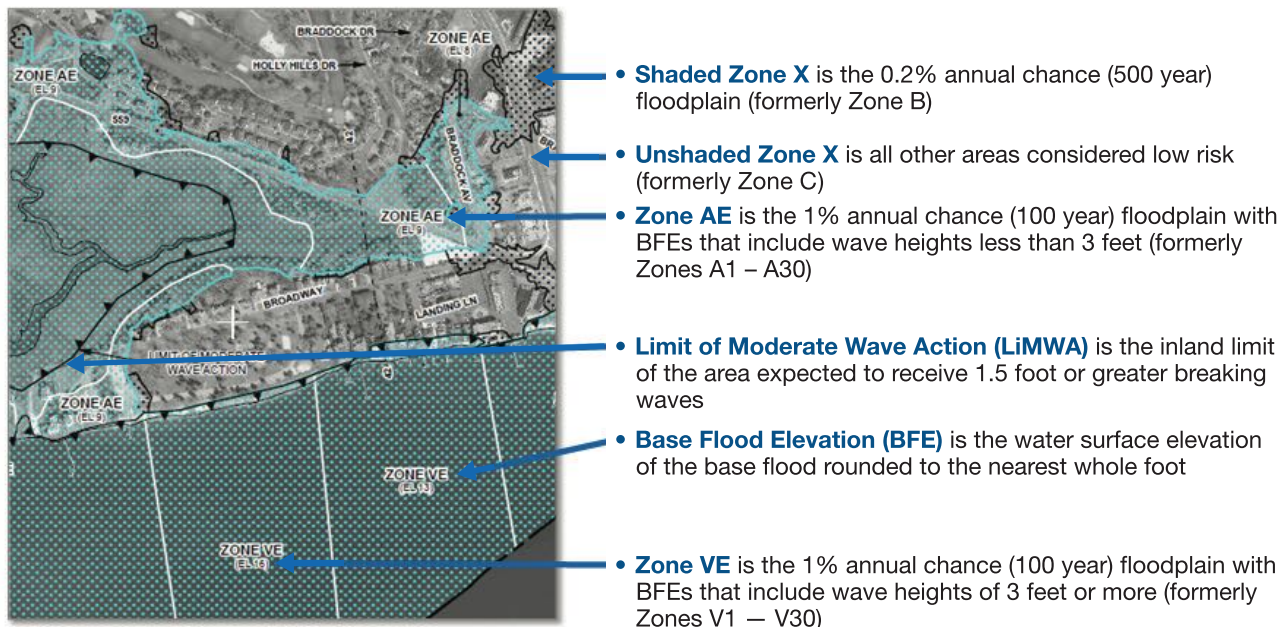

Figure 1-3. Conceptual FIRM showing representative coastal flood zones.

1.3.3 Risk Assessment and Risk Reduction

Preparing a flood-resistant building design, including supporting utility systems and their repair, replacement, or upgrade, should begin with a risk assessment. Compliance with regulatory standards and potential increased resistance to flooding may be best achieved by successfully identifying and managing flood risks.

Risk assessment is the process of quantifying the total flood risk to a building (including its utility systems) located in an SFHA or an area prone to flooding. Designers and builders should be informed on current hazard and risk information and understand how risk affects design decisions and client requirements. It is recommended that designers and builders:

- Use the most current published flood hazard data to determine site or building utility vulnerability. For most communities, the FIS is the best available information, although many communities and regional agencies develop studies that include additional information.
- Conduct a detailed risk assessment or update an existing assessment if there are indications that site or watershed conditions may have changed significantly since the hazard data were published or if published hazard data are not representative of a site’s exposure to flooding.
- Consider how site or watershed conditions may change over the expected life of a structure or building utility system, accounting for factors such as anticipated upland development and increased frequency and magnitude of extreme weather events.



WARNING

Meeting minimum regulatory and code requirements for building siting, design and construction does not guarantee the building will be safe from all flooding. Floods more severe than the base flood can and do occur. It is up to designers and building owners to determine the level of acceptable risk to a structure’s utilities and whether to exceed the minimum requirements.

- Upon completion of a risk assessment, review design options that will best mitigate the effects of flooding for the proposed project. Building owners may find potential flood damage costs or loss of function unacceptable, leading them to work with designers to determine mitigation options and reduce risk to an acceptable level.

Risk reduction is composed of two aspects: *reduction of exposure to physical damage* and *risk management through insurance*. While eliminating all flood risk may not be feasible, a risk reduction evaluation determines the **acceptable level of residual risk**. Residual risk is the risk that remains after mitigation measures are implemented. Risk management, including identifying acceptable levels of residual risk, underlies the entire design and construction process. The initial, unmitigated risk is reduced through compliance with floodplain management regulations and building codes, application of best practices, and purchase of insurance to provide financial protection for residual risks. Each risk reduction element decreases the residual risk. The more elements that are applied, the smaller the remaining residual risk will be.

FIS and FIRM Limitations

FIRMs do not identify all areas subject to flooding as indicated by the documented occurrence of damage in areas outside of mapped SFHAs. In some places, areas included in the SFHA have never flooded – although that does not mean those areas are not prone to flooding. Damage from floods associated with hurricanes and other coastal storms such as Floyd (1999), Alison (2001), Katrina (2005), Rita (2005) and Sandy (2012), along with the Midwest floods in 1993, 1994, 2008 and 2015 occurred far beyond the mapped SFHA. FEMA also reports many insurance claims are paid for damage that occurs outside of mapped SFHAs.

Building owners and designers should be aware that many watersheds have been significantly altered by ongoing urban and suburban development. The increased prevalence of paved areas causes rainfall runoff to flow rapidly over impervious surfaces like roads, parking lots, and rooftops. Some storm drainage systems do not have the capacity to manage increased runoff volumes, contributing to localized flooding. In addition, floodplains are dynamic systems that have been altered through natural processes and wetland and floodplain filling for agriculture, urban development, transportation, flood control projects, and other land uses.

While floodplain modeling procedures have become more precise, resources are not available at the Federal, State, or community levels to fully fund comprehensive flood hazard mapping. In addition, in some areas of the country, future flood risk could be compounded by climate change and sea level rise impacts. As a consequence, the building utility best practices presented in this publication should be considered by owners, designers, and builders working with utility systems.

1.4 Flood Hazard Characteristics and Flood Loads

The NFIP and building codes require that buildings located in flood hazard areas resist flotation, collapse, and lateral movement associated with flooding. This section is an overview of flooding characteristics that determine flood loads, the forces that act on inundated buildings and building elements.



NOTE

Additional information on flood hazard characteristics, flood load calculations, and design requirements is available in:

- ASCE 7, *Minimum Design Loads for Buildings and Other Structures*;
- ASCE 24, *Flood Resistant Design and Construction*;
- FEMA P-55, *Coastal Construction Manual: Principles and Practices of Planning, Siting, Designing, Constructing, and Maintaining Residential Buildings in Coastal Areas*; and
- FEMA P-259, *Engineering Principles and Practices of Retrofitting Flood-Prone Residential Structures*.

1.4.1 Flood Elevation or Flood Depth

Hydrostatic Loads. Hydrostatic loads are forces or pressures that are associated with standing or slowly moving floodwater and are one of the main causes of flood damage. Hydrostatic loads can cause severe deflection or displacement of buildings and utility components if water levels on opposite sides of the component (inside and outside buildings) are substantially different (Figure 1-4):

- **Lateral hydrostatic load:** Standing water or slowly moving water can induce horizontal hydrostatic forces against a structure if floodwater levels on both sides of a wall are not equal.
- **Vertical hydrostatic load (buoyancy):** Building elements that are lighter than water are subject to buoyancy and if designed to be watertight (substantially impermeable), submerged portions of buildings and building system components are subject to flotation.

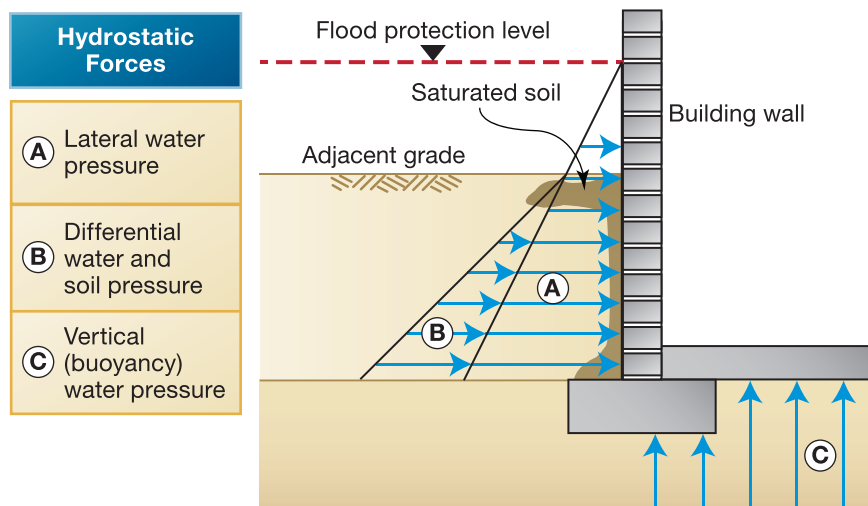

Figure 1-4. Hydrostatic forces.

1.4.2 Flood Velocity

Hydrodynamic Loads. Hydrodynamic loads are imposed on an object, such as a building or building component, by moving water flowing against and around it. Load-inducing forces illustrated in Figure 1-5 include positive frontal pressure against the structure, drag effect along the sides, and negative pressure on the downstream side. Hydrodynamic forces are one of the main causes of flood damage. Hydrodynamic forces are of particular concern along rivers and streams with high velocity floodwater and in coastal and other areas subject to storm surge.

Moving floodwater imposes hydrodynamic forces on submerged foundations and building elements, including utility system components located below flood levels. Hydrodynamic forces can destroy solid walls and dislodge buildings with inadequate connections or load paths. Moving floodwater can also transport large quantities of sediment and debris that can cause additional damage.

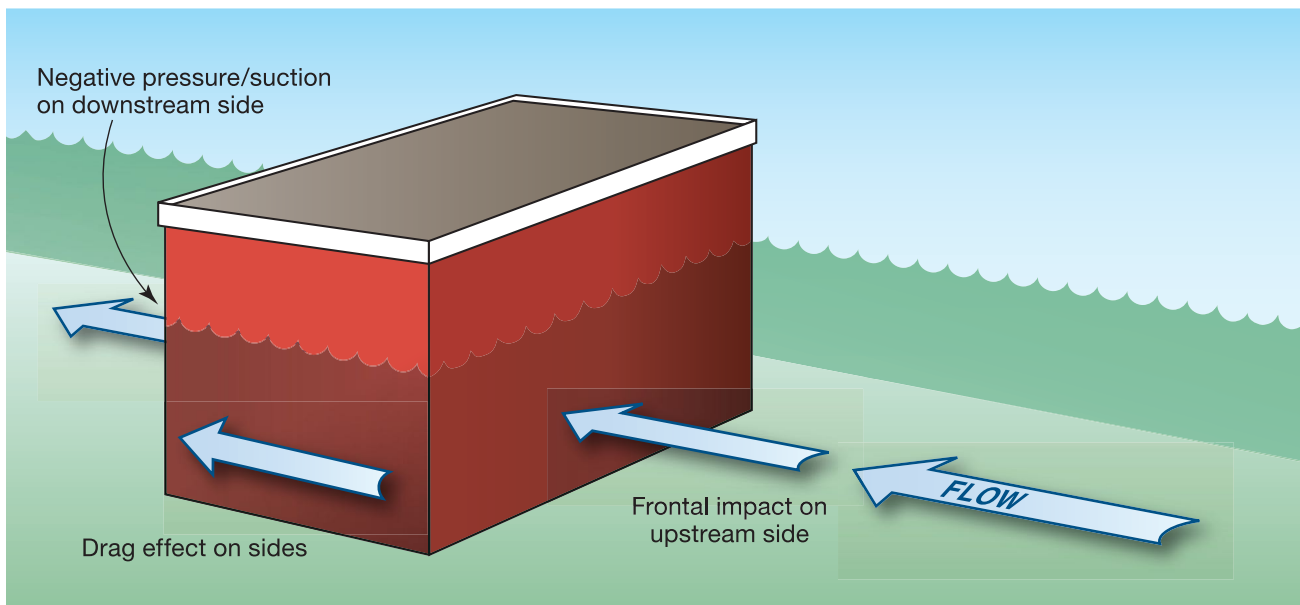

Figure 1-5. Hydrodynamic forces.

1.4.3 Wave Loads

In coastal areas, moving floodwater is usually associated with one or more of the following:

- Storm surge and wave runup flowing landward through breaks in sand dunes, levees, or across low-lying areas
- Outflow (seaward flow) of floodwater driven into bay or upland areas by a storm
- Strong currents along the shoreline driven by storm waves moving in an angular direction to the shore.

Wave Action. Wave action describes the behavior of wind-driven waves in floodplains along shorelines. The height of waves associated with the base flood can vary by flood zone: in Zone V, wave heights equal or exceed 3 feet, while in Coastal A Zones (LiMWA's), wave heights are between 1.5 and 3 feet. Waves can affect buildings in a number of ways:

- **Breaking wave loads:** The force created by waves breaking against a vertical surface causes the most severe damage to coastal buildings and is often ten or more times greater than the force created by high winds during a storm event. For this reason, elevated coastal structures supported on open foundations (piles or columns) that are free of underlying obstructions and have minimal exposure to breaking waves withstand coastal storms better than non-elevated coastal structures on other types of foundations.
- **Wave runup and wave slam:** Wave runup occurs as waves break and run up beaches, sloping surfaces, and vertical surfaces. Wave runup can drive large volumes of water against or around coastal buildings, creating hydrodynamic forces that, although generally smaller than breaking wave forces and drag forces associated with high velocity water, can cause localized erosion and scour. The action of wave crests striking the elevated portion of a structure is known as “wave slam.” Wave slam introduces potentially large lateral and vertical loads on the lower portions of elevated structures, typically resulting in damaged floor systems.

1.4.4 Other Impacts of Flooding

Flood-borne debris impact. Flood-borne debris produced by floods and coastal storms typically includes materials from damaged carports, decks, porches, awnings, steps, ramps, breakaway wall panels, portions of buildings, entire buildings, shipping containers, fuel tanks, pad-mounted equipment, vehicles, boats, piles and dock decking, fences, destroyed erosion control structures, and a variety of smaller objects. Typical flood-borne debris is capable of damaging or destroying unreinforced masonry walls, light wood frame construction, and small-diameter posts and piles, as well as the structural components they support (Figure 1-6). Debris trapped by cross-bracing, closely spaced piles, grade beams or other building components is also capable of transferring flood and wave loads to the foundation of an elevated structure. Impact loads also are impacted by ice, trees, and other objects transported by floodwater.

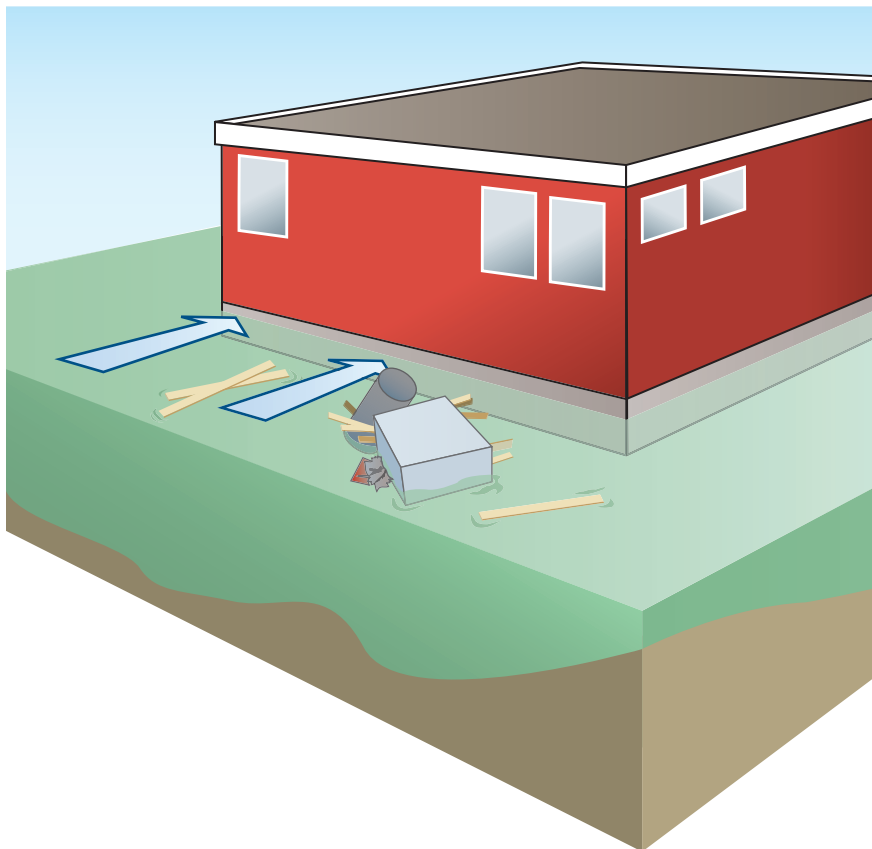

Figure 1-6. Flood-borne debris impact.

Erosion and Scour. Erosion refers to the wearing or washing away of riverbanks, shorelines and land surfaces. It is part of the larger process of fluvial morphology and shoreline change. Due to the dynamic nature of erosion, it is one of the most complex hazards to understand and is difficult to accurately predict at a specific flood-prone site. Scour is localized erosion that occurs when waters move around foundational elements and other obstructions. Determining potential scour is critical in designing foundations to ensure the foundation does not fail due to a loss in either bearing capacity, embedment depth or anchoring.

Duration and Rate of Rise.

- **Duration:** Duration is the measure of how long flooding remains above normal levels. The duration of riverine flooding is primarily a function of watershed size and the steepness of valley topography. Rivers that drain large watersheds and those with relatively flat topography experience high water for weeks or months. Coastal flooding typically is of shorter duration – usually only one or two tide cycles depending on how fast storms move through affected areas. Prolonged contact with floodwater may make it difficult to achieve the required or desired level of flood protection because of damage to building materials and seepage.
- **Rate of Rise:** Rate of rise is the measure of how quickly floodwater rises above normal levels. Areas with steep topography and small drainage areas may experience flash flooding, during which floodwater can rise very quickly with little or no warning. Large rivers typically rise more slowly. In coastal areas, the rate of rise at specific locations may be affected by how fast storms approach the shore, offshore bathymetry and the shape of the land. Building protection measures that require active intervention by building managers or occupants may not be appropriate in areas with rapid rates of rise (faster than 5 feet per hour).

Contaminants in floodwater. Residents, business owners, and property managers should assume that anything touched by floodwater is contaminated and will have to be disinfected or discarded. Mud or sediments left by floodwater may contain chemicals from landscaping and agricultural to household and industrial sources. All materials, building components and building systems contacted by floodwater should be cleaned, disinfected and dried as quickly as possible.

- **Chemical (heavy metals, petroleum products, pesticides, and industrial and agricultural chemicals):** Floodwater carries chemical contaminants. In urban areas, stormwater runoff and floodwater carry chemicals; heavy metals from industrial sites and vehicles; petrochemicals such as oil, grease, and gasoline; herbicides; and pesticides. Similarly, flooding in rural agricultural areas also carry petrochemicals, sediment, heavy metals, and pesticides and herbicides from farming operations.
- **Biological (bacterial and fungal):** Bacterial contamination comes from sewage treatment plants and on-site septic systems that are overwhelmed or inadequate to handle flooding, as well as livestock farming operations in rural areas. Biological contaminants carry the risk of streptococcus and pneumococcus infections along with tetanus and other diseases. When floodwater recedes, exposed surfaces usually host various fungal contaminants (molds), including species with potentially serious health impacts. Of



WARNING

After flooding, it is critically important that all inundated building utility systems are thoroughly inspected for damage to determine whether they are safe to use or re-energize. Simply drying out systems may not be adequate to prevent the potential negative health effects of contamination or mold, or the threat of fire from corroded system components.

great concern are mold-infected heating, ventilation, and air conditioning (HVAC) ductwork, which can exacerbate lung and breathing conditions if not properly cleaned or replaced.

- **Salt water contamination:** Salt water is corrosive and can cause damage and weakening of important building system and utility components and connectors. Salt water can be especially damaging to electrical conductors.

1.5 NFIP Flood Insurance Considerations

NFIP flood insurance policies provide coverage for two types of insurable property: building and contents. Policies for damage to buildings are separate from policies for damage to contents. NFIP flood insurance policies do not provide coverage for damage to land, landscaping, decks, docks, piers, boat houses, or outbuildings and accessory buildings like sheds, swimming pools, or gazebos.

Building coverage includes:

- The insured building and its foundation
- Electrical and plumbing systems
- Central air conditioning equipment, furnaces, and water heaters
- Refrigerators, cooking stoves, and built-in appliances such as dishwashers
- Permanently installed carpeting over unfinished flooring

Contents coverage includes:

- Clothing, furniture, and electronic equipment
- Curtains
- Portable and window air conditioners
- Portable microwaves and dishwashers
- Carpeting that is not already included in property coverage
- Clothing washers and dryers

Building owners can purchase flood insurance directly through the NFIP, but most purchase insurance through traditional private sector insurers. Some insurance companies that are not part of the NFIP offer coverage, usually in extremely high-risk areas or for buildings whose replacement value or contents value far exceeds the limits of the NFIP coverage.



NOTE

Designers and building owners should consult with insurance agents to determine how design options may affect the rating of NFIP flood insurance policies, when policies may be purchased, and the nature and limitations of coverage.

Recent NFIP Reforms and Potential Impacts on Flood Insurance Premiums

On March 21, 2014, President Obama signed the Homeowner Flood Insurance Affordability Act (HFIAA) of 2014. This law repealed or modified certain provisions of the Biggert-Waters Flood Insurance Reform Act of 2012 (BW-12) and made additional changes to other aspects of the NFIP not covered by BW-12.



NOTE

For more information on NFIP reform, visit www.fema.gov/flood-insurance-reform.

HFIAA slows some flood insurance premium rate increases and offers relief to certain policyholders who experienced steep premium increases in 2013 and early 2014 resulting from enactment of BW-12. Flood insurance rates and other charges were revised for new or existing policies starting on April 1, 2015. In addition to insurance rates, other changes resulting from BW-12 and HFIAA will be implemented over time and will further affect the cost of NFIP flood insurance policies.

The April 2015 changes included an increase in the NFIP Reserve Fund Assessment, the implementation of an annual surcharge on all new and renewed policies, an additional deductible option, an increase in the Federal Policy Fee and rate increases for most policies. Other key changes that will impact future insurance rates include:

- Limiting annual rate increases for individual premiums and rate classes to 18 percent until premiums reach their full risk rates
- Limiting premium increases for average rate classes to 15 percent
- Mandating premium increases for certain subsidized policy holders under BW-12 and HFIAA
- Implementing a new procedure for Preferred Risk Policy Eligibility Extension (PRP EE), a cost-saving coverage option for property owners whose buildings were newly mapped into a SFHA. The PRP EE premiums will be the same as the PRP, which offers low-cost coverage to owners and tenants of eligible residential and non-residential buildings located in moderate- to low-risk areas for the first year (calculated before fees and assessments).



2.0 Regulatory Framework – NFIP Regulations and Building Codes

The NFIP regulations and requirements described in this chapter pertain to electrical, heating, ventilation, plumbing, and air conditioning equipment components, as well as other services. These requirements are intended to apply to all building utility systems, equipment, and equipment components. Therefore, each time any one component or system is mentioned throughout this publication, all components and systems are implied to be included. This consistency better ensures that buildings exposed to base flood events suffer minimal damage and can be swiftly restored to their fully-functioning condition. This chapter also describes model building codes and standards for buildings and their utility systems and components.

A discussion of methods to reduce flood damage, even when compliance is not required by floodplain management regulations or building codes, may be found in Section 2.3.

The distinction between residential buildings and non-residential buildings, which determines the appropriate method of flood protection, is explored in Section 2.6.

2.1 NFIP Regulations for Building Systems/Utilities

The NFIP’s minimum requirements for new construction and Substantially Improved buildings may be found in 44 CFR §60.3(a)(3). Communities are required to:

“Review all permit applications to determine whether proposed building sites will be reasonably safe from flooding. **If a proposed building site is in a flood-prone area, all new construction and substantial improvements shall** (i) be designed (or modified) and adequately anchored to prevent flotation, collapse, or lateral movement of the structure resulting from hydrodynamic and hydrostatic loads, including the effects of buoyancy, (ii) be constructed with materials resistant to flood damage, (iii) be constructed by methods and practices that minimize flood damages, and **(iv) be constructed with electrical, heating, ventilation, plumbing, and air conditioning equipment and other service facilities**

that are designed and/or located so as to prevent water from entering or accumulating within the components during conditions of flooding.” [emphasis added]

Protection methods described in Chapter 3 of this publication, such as elevation and relocation (Section 3.1) and component protections (Section 3.2), may be used to satisfy NFIP requirements. These methods, along with other measures that provide partial protection (Section 3.3), should be considered even when compliance is not required. Additional details regarding protection of utility systems and equipment for dwellings and other occupancies may be found in Chapter 4 (one- and two-family dwellings) and Chapter 5 (non-residential and multi-family buildings).

2.2 Achieving Compliance – New Construction, Substantial Improvement and Substantial Damage

New construction and Substantially Improved and Substantially Damaged buildings located in SFHAs must fully comply with NFIP regulations, including those that apply to building utility systems noted in Section 2.1. NFIP regulations (44 CFR §60.3) define Substantial Improvement and Substantial Damage:

Substantial Improvement means any reconstruction, rehabilitation, addition, or other improvement of a structure whose cost equals or exceeds 50 percent of the structure’s market value before the “start of construction.” This term includes structures that have incurred “Substantial Damage,” regardless of the actual repair work performed. The term does not, however, include either:

1. Any structural improvement project whose purpose is to correct existing violations of state or local health or sanitary or safety code specifications that have been identified as the minimum necessary for safe living conditions by local code enforcement; or
2. Any alterations to a “historic structure,” provided that the alteration will not preclude the structure’s continued designation as a “historic structure.”

Substantial Damage is damage of any origin sustained by a structure whereby the cost of restoring the structure to its pre-damage condition would equal or exceed 50 percent of the structure’s pre-damage market value. **Substantial Damage is implied to be included in each mention of Substantial Improvement throughout this publication, as the requirements for floodplain management and building code regulation compliance are identical.**

It is incumbent upon communities to evaluate proposals for all repairs, alterations, additions, and other improvements in order to determine whether the combined work (repairs and improvements) constitutes Substantial Improvement. It is critical that communities enforce building codes and floodplain management regulations to increase these structures’ resistance to future flooding. Building utility systems may achieve compliance through:



NOTE

When compliance is required, the minimum level of protection established by the NFIP is the base flood elevation (BFE). State and local floodplain management requirements and building codes may require a higher flood protection level. This publication uses “flood protection level” to refer to the required level of protection or the desired level of protection if compliance is not required.

- **Elevation:** installing or locating utility systems and components at or above the flood protection level required by local regulations or building codes.
- **Relocation:** moving existing utility systems and components to locations at or above the flood protection level required by local regulations or codes (i.e., moving a furnace out of a below grade enclosure or basement). Elevation and relocation are discussed in Section 3.1.
- **Component protection:** the implementation of techniques to protect a system, equipment component, or group of components located below the elevation required by local regulations or codes from exposure to floodwater. Component protection is discussed in Section 3.2.

2.3 Compliance Not Required – Non-Conforming Existing Buildings, No Substantial Improvement or Substantial Damage

Non-conforming existing residential and non-residential buildings built before communities joined the NFIP are not required to comply with NFIP regulations unless they are proposed to be Substantially Improved or have incurred Substantial Damage. Owners of these existing buildings may elect to implement mitigation measures that reduce flood risk and the costs of post-flood damage repairs and system restoration.

Where compliance is not required, protection of building utilities systems can be achieved using a number of measures including elevation, relocation, component protection, or other measures that provide partial protection as described in Chapter 3. These approaches can be used to improve flood damage resistance of non-conforming buildings, especially in areas subject to repetitive, low-level flooding. The principles of these measures apply, with two key differences:

- Elevation, relocation, and component protection can be accomplished at elevations lower than the elevation required for compliance.
- Component protection may be used for residential and non-residential buildings, whereas component protection may be used only for non-residential structures when NFIP compliance is required.

Even if compliance is not required, owners of existing buildings may want to reduce vulnerability to future flooding. **Partial protection measures** for building systems and components, described in Section 3.3, can reduce damage and facilitate recovery. While protection by elevation, relocation, or component protection is preferable, some owners may prefer a lower-cost partial method of protection, which may include using flood damage-resistant materials, designing system components to facilitate replacement, installing quick-connect flanges to flood-vulnerable equipment, and employing emergency measures such as sandbags, temporary flood barriers, and flood wrapping systems. As previously stated, these measures are optional unless buildings are Substantially Improved or have incurred Substantial Damage, in which case full compliance would be required.



NOTE

The measures described in this publication can be used to reduce flood damage in areas subject to flooding, even if those areas are not shown on FIRMs. FEMA reports that nearly 20 percent of NFIP flood insurance claims are paid for damage to buildings located in areas identified as low-risk Zone X.

2.4 Building Codes

Model building codes include provisions pertaining to anticipated hazards such as flood, wind, seismic, snow, and soil conditions. Two organizations maintain the most widely used model building codes: the International Code Council, Inc. (ICC) and the National Fire Protection Association (NFPA). Model codes are updated every three years, but there is usually a lag of two or more years between the publication of a model code and adoption by States and communities.

Model building codes are neither Federal laws nor regulations. They are typically adopted by States and communities to standardize enforcement of safe building practices. Some States and communities modify the model codes. Users should check with their applicable authorities to determine if and how adopted codes in their State or community vary from the model codes.

An adopted building code establishes legal requirements for building design and construction. In many States, the codes are adopted at the State level and local enforcement is mandated. Conversely, some States do not adopt codes, but have many communities that do at the local level.

The **International Code Council, Inc.** develops and publishes the International Codes (I-Codes) and conducts a comprehensive training and certification program. Table 2.1 at the end of Section 2.5 provides a list of sections from the I-Codes and the ASCE 24 standards that pertain to building utility systems in flood-hazard areas. The I-Codes include:

- **The International Building Code® (IBC)** is largely a performance-based model code with some prescriptive requirements. Performance-based codes state the intended functional result of a requirement and separate the intent from the means of compliance. The IBC refers to many standards that are, in effect, part of the code's requirements. For construction in flood hazard areas, including building systems, the IBC refers to ASCE 24, Flood Resistant Design and Construction, which is discussed in greater detail in Section 2.5. For equipment and utilities requirements, the IBC also refers to the *International Mechanical Code® (IMC)*, *International Fuel Gas Code® (IFGC)*, *International Plumbing Code® (IPC)*, *International Swimming Pool and Spa Code® (ISPSC)*, and *International Private Sewage Disposal Code® (IPSDC)*.
- **The International Residential Code® (IRC)** is a prescriptive-oriented model code with some performance standards. A prescriptive code specifies construction requirements and methods that are deemed to be in compliance with performance standards. In most cases, dwellings can be constructed without involving registered design professionals such as licensed engineers and architects. The 2015 IRC (Section R322.1.6) requires electrical systems, equipment, and components; heating, ventilating, air conditioning; plumbing appliances and plumbing fixtures; duct systems; and other service equipment to



NOTE

More detailed information on how to integrate building codes and floodplain management requirements, including those that apply to building utility systems, can be found in *Reducing Flood Losses through the International Codes: Coordinating Building Codes and Floodplain Management Regulations*; Fourth Edition (2014).



NOTE

FEMA has prepared excerpts of the flood provisions from the 2015, 2012, and 2009 I-Codes, and highlights from 2014 and 2005 ASCE 24 (described in Section 2.5). The excerpts are available at <https://www.fema.gov/building-code-resources>.

be located at or above the required elevation for the dwelling, which is the BFE plus 1 foot, or the design flood elevation (whichever is higher). Alternatively, those elements may be below the required elevation if designed and installed to resist flood loads and prevent water from entering or accumulating within the components. Electrical wiring systems are permitted below the required elevation if they conform to the IRC's electrical requirements for wet locations.

- **The International Existing Building Code® (IEBC)** specifies requirements for work on existing buildings including repair, alteration, additions, change of occupancy, moved structures, and historic buildings. The IEBC requires buildings in flood hazard areas to be brought into compliance with the flood resistant requirements of the IBC or IRC, as applicable, if the buildings are Substantially Improved or have incurred Substantial Damage.
- **The International Mechanical Code® (IMC)** requires mechanical systems, equipment and appliances to be located at or above the elevation required by IBC Section 1612, which references ASCE 24. Alternatively, components are allowed below the required elevation if designed and installed to resist flood loads and prevent water from entering and accumulating within the components. ASCE 24 Chapter 7 specifies general requirements, and specific requirements for mechanical, heating, ventilation, and air conditioning systems may be found in Section 7.4. Both the IMC and ASCE 24 state that mechanical systems and equipment must not be mounted on or penetrate walls intended to break away under flood loads. Air intake openings and exhaust outlets must be installed at or above the elevation specified in IBC Section 1612. IMC specifies that duct systems and plenum spaces must either be located above the elevation required in IBC Section 1612 or be designed to prevent water from entering or accumulating inside their components while also resisting flood loads, including the effects of buoyancy. In addition, fuel oil system components must be elevated or capable of resisting flood loads. Requirements for elevators may be found in ASCE 24 Section 7.5.
- **The International Fuel Gas Code® (IFGC)** requires fuel gas appliances, equipment and systems to be located at or above the elevation required by IBC Section 1612, which references ASCE 24. Alternatively, components are permitted below the required elevation if designed and installed to resist flood loads and prevent water from entering and accumulating inside the components. ASCE 24 Chapter 7 specifies general requirements, with specific requirements for mechanical, heating, ventilation and air conditioning systems in Section 7.4.
- **The International Plumbing Code® (IPC)** requires plumbing systems and equipment to be located and installed as required by IBC Section 1612, which references ASCE 24. Alternatively, components are permitted below the required elevation if designed and installed to resist flood loads and prevent water from entering and accumulating inside. ASCE 24 Chapter 7 specifies general requirements, with specific requirements for buried and exposed plumbing systems, plumbing systems below minimum elevations, and sanitary systems detailed in Section 7.3. Both the IMC and ASCE 24 state that plumbing systems, pipes, and fixtures must not be mounted on or penetrate walls intended to break away under flood loads.
- **The International Swimming Pool and Spa Code® (ISPSC)** requires equipment serving pools and spas to be elevated or anchored to prevent flotation and protected to prevent water from entering or accumulating within the components. Electrical equipment installed in flood-prone locations must be supplied by branch circuits that have ground-fault circuit interrupter (GFCI) protection for personnel.
- **The International Private Sewage Development Code® (IPSDC)** requires soil absorption systems to be located outside of flood-hazard areas or, if permitted in flood-prone areas, the site must be located to minimize the effects of inundation. Septic tanks must be anchored to counter buoyancy and vent termination and service manholes must be at least two feet above the base flood elevation or fitted with covers to prevent the inflow of floodwater and outflow of tank contents.

The **National Fire Protection Association (NFPA)** develops and maintains model codes and numerous standards, including:

- **Building Construction and Safety Code® (NFPA 5000)**, a performance-based model code applicable to all buildings and structures, including dwellings. The NFPA 5000 refers to many standards that are, in effect, part of the code. ASCE 24 is the referenced standard for building design and construction of in flood hazard areas.
- **National Electric Code® (NFPA 70)**, is a regionally adoptable standard for the safe installation of electrical wiring and equipment in the United States. In some cases, the NEC is amended, altered, and superseded by regional regulations issued by local governing bodies.

The **International Association of Plumbing and Mechanical Officials (IAPMO)** develops and maintains the **Uniform Mechanical Code® (UMC)**, **Uniform Plumbing Code® (UPC)**, **Uniform Solar Energy Code® (USEC)**, and the **Uniform Swimming Pool, Spa and Hot Tub Code® (USPSHTC)**. Each model code specifies requirements for building utility systems and components and has requirements applicable to buildings and structures in flood hazard areas.

2.5 Standards

ASCE 24 *Flood Resistant Design and Construction* is part of a series of standards published by the American Society of Civil Engineers. ASCE 24 provides minimum requirements for flood-resistant design and construction of structures located totally or partially in flood hazard areas including alluvial fans, flash flood areas, mudslide areas, erosion prone areas, and high-velocity flow areas. ASCE generally updates standards every five years.

The IBC specifies, “The design and construction of buildings and structures located in flood hazard areas, including areas subject to high velocity wave action, shall be in accordance with ASCE 24.” The IRC requires dwellings in floodways to comply with ASCE 24 and allows dwellings in any flood hazard area to be designed and constructed in accordance with ASCE 24.

ASCE 24 specifies minimum requirements for building performance (flood loads), elevating or dry floodproofing methods relative to flood elevations, enclosures below elevated buildings, flood damage-resistant materials, and methods for attendant utilities and equipment. ASCE 24 Chapter 7 specifies requirements for both utility elevation and equipment and utility systems that are located below required elevations. The required elevation depends on the type of building and the level of the minimum flood protection standard. Table 2-1 includes a list of ASCE 24 sections related to building systems and utilities in flood hazard areas.



NOTE

The term “attendant utilities and equipment” is defined in ASCE 24. ASCE 24 establishes requirements for attendant utilities and equipment associated with buildings in flood hazard areas. The term is broadly defined as “attendant utilities and equipment—utilities, mechanical, electrical, fuel gas, plumbing, HVAC, and related equipment, as well as services associated with new construction and substantial improvements.”

Table 2-1. Summary of I-Code and standard references for building utility systems in flood hazard areas.

Code/ Standard	HVAC	Electrical	Plumbing	Fuel Systems and Tanks	Conveyances
2015 IBC	1612.4, ASCE 24	1612.4, ASCE 24	1612.4, ASCE 24	1612.4, ASCE 24	1612.4, ASCE 24, 3001.2
ASCE 24-14	7.1; 7.4	7.1; 7.2	7.1; 7.3	7.1; 9.7	7.1; 7.5
2015 IRC	R322.1.6; M1301.1.1; M1401.5; M1601.4.10; M1701.2; M2001.4; M2201.6	R322.1.6	R322.1.6; P2601.3; P2602.2; P2705.1; P3001.3; P3101.5	R322.1.6; G2404.7; R322.1.6; R322.2.4; R322.3.7	R322.1.6
2015 IMC, IPC, IFGC	IMC: 301.16; 401.4; 501.3.1; 602.4; 603.13; 1206.9.1; 1210.8.6; 1305.2.1		IPC: 309.1; 309.2; 309.3	IFGC: 301.11	
2015 UMC, UPC	UMC: 305.2; 603.9; 607.2		UPC: 301.4		

2.6 Building Occupancies

NFIP regulations establish minimum requirements for buildings and structures in SFHAs (44 CFR Section 60.3). Some requirements apply to all buildings and structures across all flood zones, such as 44 CFR Sections 60.3(a) and (b). Specific utility systems requirements in the NFIP regulations apply based on flood zone designation:

- The requirements for Zone A apply to all buildings and structures, residential or non-residential. Dry floodproofing is allowed in non-residential buildings. [44 CFR §60.3(c)]
- The requirements for Zone V apply to all buildings and structures located in the coastal high hazard area, regardless of use classification. [44 CFR §60.3(e)]



NOTE

For design, specification, and installation of utilities and equipment, the distinction between residential and non-residential buildings is important because “component protection” is allowed only for non-residential buildings in Zone A. Component protection is described in Section 3.2.

The NFIP uses but does not define the terms “residential” and “non-residential.” For application of the I-Codes, the terms are defined in ASCE 24 and are used to determine whether buildings may be dry floodproofed. This publication uses the terms described in Sections 2.6.1 and 2.6.2.

While the NFIP *Flood Insurance Manual* defines residential and non-residential buildings, those definitions are used for insurance purposes and should not be used to determine which floodplain management requirements apply to specific buildings, nor should they determine compliance for building utility systems. For example, for insurance rating purposes, nursing homes are considered “non-residential,” and thus qualify for higher policy limits than residential buildings. However, FEMA floodplain management guidance describes residential buildings as those in which people live, sleep, or are cared for on a 24-hour basis.

2.6.1 Residential

Residential buildings include detached one- and two-family dwellings and townhouses not more than three stories. The IRC applies to buildings that are “detached one- and two-family dwellings and townhouses not more than three stories above grade plane in height with a separate means of egress and their accessory structures not more than three stories above grade plane in height.” The IRC does not require plans and construction documents to be prepared by a registered design professional (licensed engineer or architect) unless specifically required by State or local regulations. Certification of design is required for dwellings in coastal high hazard areas (Zone V). The 2015 IRC now requires Coastal A Zone dwelling designs to be certified by registered design professionals.

Chapter 4 describes requirements and best practices for building utility systems and equipment for dwellings within the scope of the IRC. Those specific requirements are additions to the general requirements described in Chapter 3 that apply to utility systems, equipment, and components for all buildings.

2.6.2 Non-Residential

Non-residential buildings include all non-residential structures and critical facilities, as well as residential occupancies other than dwellings within the scope of the IRC. The IBC’s scope applies to all buildings and structures that are not within the scope of the IRC. The IBC requires registered design professionals to prepare designs and construction documents unless applicable State or local statutes specify otherwise.

Some buildings and structures governed by the IBC are residential in nature. The IBC details “Residential Group R” (Section 310) and “Institutional Group I” (Section 308). Both include buildings and areas within buildings that are residential in nature (see Note on the following page).

Chapter 5 describes requirements and best practices for utility systems and equipment systems for all buildings and structures within the scope of the IBC. Those specific requirements are additions to the general requirements described in Chapter 3 that apply to utility systems, equipment, and components for all buildings.



NOTE

TERMINOLOGY FOR RESIDENTIAL AND NON-RESIDENTIAL BUILDINGS

IBC Section 308 Institutional Group I includes “the use of a building or structure, or a portion thereof, in which care or supervision is provided to persons who are or are not capable of self-preservation without physical assistance or in which persons are detained for penal or correctional purposes or in which the liberty of occupants is restricted.” This group includes, among others, board and care treatment centers and facilities, hospitals, nursing homes, prisons, correctional/detention centers, and certain day care facilities.

IBC Section 310 Residential Group R includes “the use of a building or structure, or a portion thereof, for sleeping purposes when not classified as an Institutional Group I or when not regulated by the IRC.” This group includes, among others, transient lodging (hotels, motels, lodging and boarding houses), apartment houses, dormitories, and small group homes that provide 24-hour care (assisted living facilities, group homes, halfway houses, and rehabilitation and care facilities).

ASCE 24-14 Residential is defined to include “(1) buildings and structures and portions thereof where people live or that are used for sleeping purposes on a transient or non-transient basis; (2) structures including but not limited to one- and two-family dwellings, townhouses, condominiums, multifamily dwellings, apartments, congregate residences, boarding houses, lodging houses, rooming houses, hotels, motels, apartment buildings, convents, monasteries, dormitories, fraternity houses, sorority houses, vacation time-share properties; and (3) institutional facilities where people are cared for or live on a 24-hour basis in a supervised environment, including but not limited to board and care facilities, assisted living facilities, halfway houses, group homes, congregate care facilities, social rehabilitation facilities, alcohol and drug centers, convalescent facilities, hospitals, nursing homes, mental hospitals, detoxification facilities, prisons, jails, reformatories, detention centers, correctional centers, and prerelease centers.”

ASCE 24-14 Nonresidential is defined as “any building or structure or portion thereof that is not classified residential.”



3.0 Compliance and Mitigation Measures

This chapter presents an overview of the mitigation measures available to bring utility systems, equipment, and components into compliance with NFIP requirements for new construction or Substantial Improvement and repair of Substantial Damage. These measures are generally applicable to both residential and non-residential buildings, although some may be used only for non-residential buildings when compliance is required. When compliance is not required, certain measures may also be used to reduce flood vulnerability for existing buildings, resulting in reduced recovery time and cost.

Chapter 4 of this publication provides additional details regarding building utility system mitigation measures for HVAC, electric, plumbing, water and wastewater, as well as conveyance systems in one- and two-family dwellings and townhouses with three or fewer stories. Chapter 5 discusses specific mitigation information on ways to reduce flood damage to complex utility systems commonly found in multi-family, non-residential, and mixed-use buildings.

3.1 Elevation and Relocation

Elevation: Installing or locating utility systems and components at or above the flood protection level required by local floodplain management regulations or building codes.

Relocation: Moving existing utility systems and components previously installed below the base flood elevation to less vulnerable locations, preferably above the flood protection level required for new construction.

Compliance with elevation or relocation requirements generally entails installing exterior equipment on platforms, pedestals, or the rooftop. Interior equipment can be installed on platforms inside enclosures below elevated buildings, or installed or relocated to floors at or above the required elevation. Pedestals are typically masonry structures (Figure 3-1). Platforms may be free-standing,



NOTE REGARDING BEST PRACTICE

When buildings are elevated or protected higher than the minimum required flood protection level, equipment serving the buildings should be elevated or located at least to the same height. This measure not only protects the equipment from the same level of risk as the building, but allows access to the best available rates for NFIP insurance policies as well.

self-supporting structures or they may be cantilevered from, or knee-braced to, buildings (Figure 3-2). In flood hazard areas identified as Zone V on FIRMs, pedestals must not be sited under or immediately adjacent to buildings because they could obstruct the free passage of floodwater and waves.



Figure 3-1. Air conditioning compressor elevated on a pedestal.



Figure 3-2. Air conditioning compressor elevated on a cantilevered platform.

Depending on building characteristics, some systems or equipment may be suspended from walls, floor systems, or roof framing to raise them above the required elevation. Additionally, protection must be provided for any element or component that extends from the ground to the building, such as water supply pipes, sanitary drainage pipes, gas and fuel lines, or underground electric service. Table 3-1 at the end of this chapter summarizes elevation and relocation measures.

Replacement of equipment and systems that serve existing buildings provides an opportunity to reduce vulnerability to future flooding. When buildings are Substantially Improved or repaired after incurring Substantial Damage, the buildings and their equipment and utilities must be brought into compliance with the same requirements that apply to new construction. Elevating or relocating equipment achieves compliance. Dry floodproofing (also called component protection) below the elevation required for protection by using substantially impermeable, watertight vaults or utility rooms may achieve compliance in non-residential buildings.



NOTE

Platforms and pedestals used to elevate equipment must resist flood loads and other applicable loads. Equipment on outdoor platforms and pedestals must be anchored to resist applicable wind loads. In regions with significant seismic risk, equipment on platforms must be anchored to resist seismic loads.

When replacement of equipment and systems is not part of Substantial Improvement, relocating equipment from lower to higher elevations provides some protection against flood damage and may help occupants return to the building more quickly after a flood. Relocation is especially effective when equipment is moved from below-grade areas (i.e., basements) to higher floors. In some cases, small above-ground additions can be added to existing buildings to serve as utility rooms for relocated equipment.

Above-Ground Fuel Storage Tanks. Above-ground fuel storage tanks located in SFHAs must be designed to resist flotation, collapse, and lateral movement. Anchoring straps and cables should resist the effects of corrosion and be able to withstand buoyancy forces when the tank is empty. Fill openings, outlets, vents, and cleanouts should be either above the required flood protection level or designed to prevent the entry of floodwater and loss of contents during flooding.



NOTE

Section 4.4.2 provides details on mitigation of fuel storage tanks for one- and two-family dwellings. Section 5.4.2 provides details on mitigation of fuel storage tanks for multi-family residential and non-residential buildings.

In flood hazard areas identified as Zone A on FIRMs (all zones that start with the letter “A”), above-ground tanks may be either elevated or, if constructed, installed, and anchored to resist potential buoyant and other flood forces, placed below the required flood protection level. Tanks associated with non-residential buildings may also be protected by component protection (see Section 3.2.3). In areas where large flood-borne debris is likely, bollards or barriers should be designed to protect tanks from debris impact.

In coastal flood hazard areas identified as Zone V on FIRMs (all zones that start with the letter “V”), above-ground tanks cannot be located under elevated buildings or attached to buildings below the lowest floor because they can become obstructions to the free passage of floodwater and waves. If located away from buildings, above-ground tanks may be elevated on pile-supported platforms that are designed to resist wave-related loads. The potential effects of scour and erosion that lower the ground around the supports should be considered.

3.2 Component Protection

Component Protection: The implementation of techniques to protect a system, equipment component, or group of equipment components from exposure to floodwater when located below the required flood protection level. Component protection is permitted for non-residential buildings in SFHAs outside of coastal high hazard areas (i.e., only in areas identified on FIRMs as Zone A). Component protection may be used for building utility systems, components, and equipment that serve elevated non-residential buildings. Table 3-1 at the end of this chapter summarizes component protection measures.



WARNING

The design effectiveness of component protection using a barrier or walled structure is limited by the height of the wall, and there is no residual protection once floodwater overtops or breaches the wall.

The NFIP requires that non-residential buildings in Zone A be designed with their lowest floors at or above the BFE or, if not elevated, to be dry floodproofed. Dry floodproofing is achieved by designing and constructing measures that result in watertight structures, including attendant utilities and equipment, with all elements substantially impermeable to the passage of water. Structural components must have the capacity to resist flood loads and penetrations through walls and floors below the required flood elevation and must be watertight. Although they can be effective, the engineering challenges and measures necessary for complete floodproofing and flood load resis-

tance can be costly. A thorough discussion of dry floodproofing, including limitations and guidance, is included in *Floodproofing Non-Residential Buildings* (FEMA P-936).

Most component protection and dry floodproofing measures require human intervention to properly place or deploy one or more elements, such as mountable flood shields and closure panels. Components often feature materials that must be maintained, such as gaskets and fasteners. Operations and maintenance plans with specific instructions for periodic implementation drills and regular maintenance are critical for effectiveness. Refer to ASCE 24 Chapter 6 for more information.



WARNING

Floodproofing measures that require human intervention are effective only if there is enough warning time to mobilize the necessary labor and safely evacuate the building.

Flood Barriers. Barriers around building system utility components are a primary way to achieve component protection. Flood barriers or walled structures must be designed with a foundation and walls suitable to protect the building system utility components from floodwater. Barriers or walls may be located in a building's interior or exterior. Sometimes called floodwalls, these barriers are usually freestanding, permanent engineered structures constructed of reinforced concrete or masonry (Figure 3-3). Flood barriers protect components from inundation to a specified level of protection. To provide that level of protection, barriers must be designed to resist hydrostatic loads, hydrodynamic loads, and loads from flood-borne debris and ice.

Figure 3-3. Protective flood barrier surrounding shed housing back-up power generator.



Design of barrier foundations and walls to resist flood loads and conditions must be undertaken by a qualified registered design professional. After flood conditions are identified, characteristics of the flood barrier and equipment installation must be determined, including:

- The height of the wall, which is a function of the depth of water and the level of protection required or desired. If a flood barrier is used for equipment serving new construction or buildings that are Substantially Improved or repaired after incurring Substantial Damage, the height of the barrier is determined by the elevation required for compliance.
- Dimensions of the flood barrier, which must provide sufficient space around the equipment for service and maintenance.

- Access to equipment, which can be provided by a doorway with a removable flood shield or panel or a specially designed door to prevent water entry. Permanently installed doors are recommended to eliminate the need to locate and install flood shields when flood conditions are expected. Depending on the height of the wall, access may be provided by stairs.
- Connections to buildings served by equipment located inside a flood barrier. Penetrations of the flood barrier and any portion of a dry-floodproofed building below the required flood protection level should be avoided. When unavoidable, such penetrations must be sealed to avoid becoming a pathway for seepage of floodwater. FEMA P-936 details measures to protect building penetrations.
- Accumulation of rainfall. If the area enclosed by the flood barrier is not covered with a roof, the flood barrier design should address how interior rainfall accumulation will be handled. Estimates of likely total rainfall amounts should be obtained and measured against the equipment height from the floor. Some level of protection against inundation by accumulated rainfall is achieved by typical equipment installations, but added slab or pad thickness, or other means to raise the equipment above the floor may be necessary.



NOTE

Floodproofing measures are either passive or active depending on whether they require human intervention. Passive measures do not require human intervention and are recommended whenever possible. Active (or emergency) measures require human intervention and are effective only if there is enough warning time to mobilize the necessary labor and equipment and to evacuate the building safely.

Dry Floodproofing and Flood Barriers for Equipment Rooms and Machine Rooms. Areas inside non-residential buildings can be dry floodproofed or surrounded by flood barriers to provide component protection (Figure 3-4). The same issues described above for flood barriers, including resistance to flood loads, access doors or stairs, and penetrations through the walls and floor of the dry-floodproofed area or room must be addressed during design. This approach, sometimes called “core area protection,” may be feasible in the following situations:

- Under elevated non-residential buildings to protect machine or equipment rooms that cannot be relocated or elevated in place.
- Inside enclosed areas under elevated non-residential buildings that are otherwise limited to parking, storage, and building access and are designed using “wet floodproofing” techniques to protect machine or equipment rooms.
- Inside non-residential buildings built before flood requirements were adopted. Retrofit options may be considered as part of bringing non-residential buildings that are Substantially Improved or incurred Substantial Damage into compliance (see Section 2.2), or if compliance is not required and an owner elects to implement damage reduction measures (see Section 2.3).

Interior equipment in machine rooms and vaults require access and ventilation, which may require specially designed ventilation systems and “submarine” doors. Because dry floodproofing measures are rarely completely watertight, a system to prevent and drain seepage and infiltration is required. Sump pumps powered by emergency power sources are recommended. Note that these enclosures are not intended to be occupied when flooding is predicted.

Figure 3-4. Dry floodproofing with a substantially impermeable watertight wall and access gate used to protect mechanical and plumbing equipment.

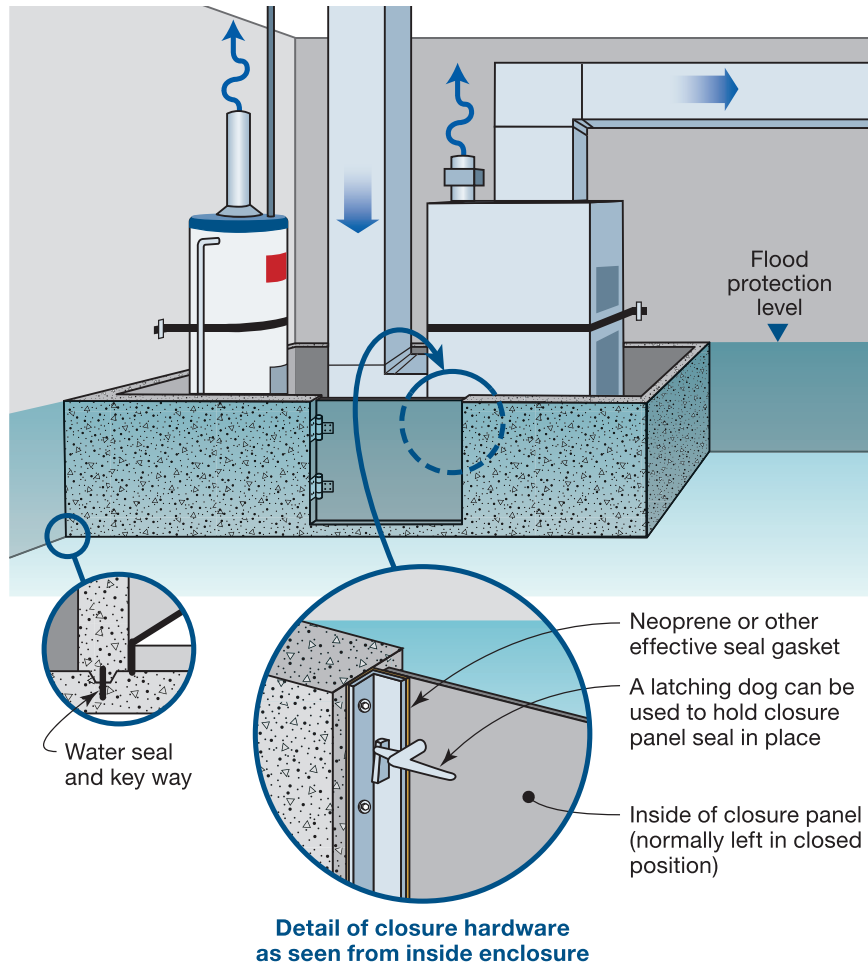

3.2.1 Protection of Exposed Risers, Conduits, and Cables

Underground utilities, including water supply, sanitary drainage, gas service, and electric service, are exposed to flooding when they extend from the ground supply source to elevated buildings. Connecting risers, conduits, and cables should be installed to resist anticipated flood loads, including impact from flood-borne debris. Exposed utility system connection components and equipment elements can be protected in several ways:

- Installing risers, conduits, and cables on the most sheltered side of interior piles or other vertical foundation members. In coastal areas, installation on the landward side of pilings or columns provides protection. Similarly, in riverine areas, installation should be on the downstream side of columns, pilings, and posts, or located inside foundation perimeter walls (crawlspaces).



NOTE

Sections 4.2.2.4 and 4.4.2 provide details on mitigation of exposed risers, conduits and cables for one- and two-family dwelling systems. Section 5.4.2 provides details on mitigation of exposed risers for multi-family residential and non-residential buildings.

- Protecting risers, conduits, and cables by enclosing them in insulated, rigid, watertight conduits or chases with welded seams designed to withstand flood and debris impact forces.
- Installing utility equipment components and connectors so they do not penetrate through walls designed to break away under flood loads. In coastal high-hazard areas, walls that surround enclosures used for parking, storage and building access must be breakaway walls.

3.2.2 Protection of Duct Systems

Duct systems distribute air throughout buildings. Systems include the ducts, duct fittings, dampers, plenums, fans, and accessory air handling equipment and appliances. As with other utility system components, the most effective way to meet the minimum requirements for flood resistant construction is to install all duct system elements at or above the required elevation.

Standard duct system components are not intended to prevent floodwater from entering or accumulating within them and are not installed to resist flood loads if submerged. Duct system components should only be installed below the required flood protection level if the components are constructed of flood damage-resistant materials. In addition, they must be designed to prevent the entry and accumulation of floodwater, and must be anchored and installed with hangers and supports capable of resisting flood loads, including buoyancy. This approach should be examined carefully. Supply and return ducts and plenums that are sealed to prevent the entry of floodwater must be strong enough to withstand the effects of buoyancy and debris impact. It is important to note that typical straps and hangers installed with standard spacing are not able to carry the weight of saturated insulation after floodwater recedes.



NOTE

Section 4.1.2 provides details on mitigation of duct systems for one- and two-family dwellings. Section 5.1.2.2 provides details on mitigation of duct systems for multi-family residential and non-residential buildings.



WARNING

Installation of ducts between joists or below floor systems of buildings may require floors to be higher than the minimum required elevation so that the ducts are high enough to meet the floodplain management regulations and code requirements.

3.2.3 Specially Designed Equipment

Although difficult to achieve, an alternative provided by NFIP regulations allows equipment to be located below the BFE, provided that the equipment is designed, constructed, and installed to “prevent water from entering or accumulating within the components during conditions of flooding.” While not explicitly stated, the performance expectation is that equipment will be serviceable after flooding recedes, with only minor repair and cleaning so that buildings may be reoccupied quickly.

To satisfy the expectation that flooded equipment will be serviceable, the equipment must be specially designed to withstand submersion in floodwater that may contain sediment, salts, and other contaminants (refer to Section 1.5.1). Regular maintenance should be performed according to manufacturer instructions. In addition, equipment permitted below the BFE must:



WARNING

Specially designed equipment is not permitted below the BFE in buildings located in coastal high-hazard areas (Zone V) due to a requirement that space below such buildings be free of obstructions.

- Be anchored to resist flood loads during conditions as severe as the base flood;
- Be protected from flood-borne debris;
- Not act as a pathway for water to enter buildings; and
- Have connections designed to be submerged.

Restrooms, bathrooms, and similar uses are not allowed below the BFE when compliance is required because use of enclosures is limited to vehicle parking, storage, and building access. Backflow valves for fixtures such as toilets, sinks, showers, and floor drains can be used to prevent backflow of floodwater only when those fixtures are in dry-floodproofed areas of non-residential buildings. If work on a building is not required to comply with the NFIP minimum requirements, then backflow valves may be used for bathroom fixtures and floor drains to reduce flood damage.

3.3 Other Mitigation Options – Partial Protection Measures

There are situations – particularly for existing buildings that are not Substantially Improved or Substantially Damaged – in which elevation, relocation, or component protection measures are not feasible, or owners may determine that the cost of such measures is not warranted. This situation may occur when buildings are subject to significant flood forces, or when buildings have basements containing utility systems that cannot be readily elevated, relocated, or floodproofed. In these situations, other measures can provide partial protection of building utility systems. Table 3-1 at the end of this chapter summarizes other measures and associated partial protection measures.

3.3.1 Flood Damage-Resistant Materials

Flood damage-resistant materials can be used to provide partial protection to elements located below the required elevation. Most flood damage-resistant materials are commonly used for exterior finishes, structural elements, and interior building finishes. However, there are some materials and finishes that can be used to reduce flood impacts to building utility systems, such as:

- Uninsulated stainless steel ductwork in HVAC systems designed to be submerged;
- Most piping materials used in plumbing systems; and
- Corrosion-resistant coatings and finishes used to protect components located in elevator pits.



NOTE

Refer to FEMA NFIP Technical Bulletin 2, *Flood Damage-Resistant Materials Requirements* for a list of flood damage-resistant materials.

Although flood damage-resistant materials do not eliminate damage, they can help reduce it and facilitate cleanup to allow for swift restoration of building services.

3.3.2 Fast Replacement of Components

If components of a building utility system cannot be elevated, relocated, or protected with component protection measures, another mitigation measure is to install these elements in a manner that allows for quick isolation and cost-efficient replacement if damaged. Although this approach does not eliminate flood damage to building utility systems, it can help isolate the damage and allow for quicker service restoration.

Examples of these measures are:

- Installing sections of HVAC ductwork that are exposed to flooding with brackets and joints that allow for quick removal and replacement;
- Installing electrical wiring using corrosion resistant raceway systems that facilitate replacement of conductors exposed to flooding;
- Electrically isolating components installed in areas subject to flooding from components at higher elevations; and
- Installing separate branch circuits or feeders that are isolated from the rest of the electrical system and protected using ground fault circuit interrupters (GFCIs).

3.3.3 Emergency Measures

Emergency measures are temporary procedures implemented in the period between the recognition of a flood threat and when flooding actually occurs. These measures may be used to provide some protection to buildings or portions of buildings. Some commonly used emergency measures with variable effectiveness are briefly described below. “Active measures” are those requiring intervention or activity such as filling and placing sandbags, activating a flood protection system or deploying flood gates. “Passive measures” are those which are in place, ready to function without intervention such as protective flood barriers or an automatic generator.



NOTE

Refer to Section 4.4 of FEMA P-936, *Floodproofing Non-Residential Buildings* for additional details on emergency measures.

Sandbags: Temporary barriers constructed of sandbags can be used to protect structures or system components from flooding or provide additional height to existing flood barriers before flooding reaches critical levels (see Figure 3-5). However, unless emergency placement is planned and deployed under the direction of trained personnel, most sandbag barriers are not fully effective and leaking and failure are common. Due to the intensive effort and amount of time needed for proper placement, and the limited protection they afford, sandbag walls should not be considered a reliable long-term protection measure.

Temporary Flood Barriers: A number of vendors offer temporary, self-supporting flood barriers that can be assembled, moved into place, anchored, and filled with water, sand or gravel and then removed after flood threats have passed (see Figure 3-6). These barriers must be sized for the site or building. Caution should be exercised when considering use of temporary barriers for flood depths greater than three feet. Training and annual drills are important so personnel know how to deploy the barriers. Proper storage, including cleaning after deployment, is necessary to protect the materials over long periods of time.

Flood Wrapping Systems: Flood wrapping systems are temporary emergency measures in which plastic or other synthetic waterproof sheeting material is used to seal buildings and prevent water intrusion into the building and associated systems. Depending on building configuration, use of a wrapping system may be effective to protect an equipment or machine room from frequent flooding.

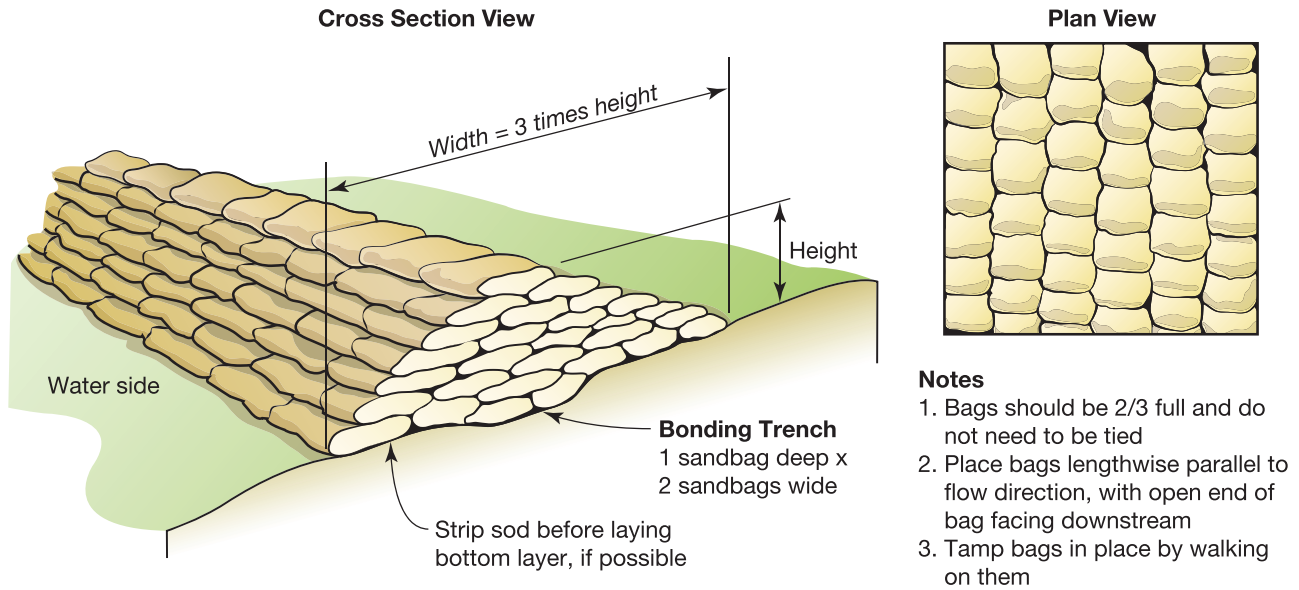

Figure 3-5. Techniques for proper placement of sandbags.

Figure 3-6. Gravel-filled containers formed a barrier to protect University of Iowa facilities during a flood event (2008).



3.3.4 Quick-Connect Mechanisms

When equipment essential to a building utility system cannot be elevated, relocated, or dry-floodproofed (component protection), quick-connect mechanisms (often called “flanged connections” or “service flanges”) can be used to disconnect equipment components prior to the onset of flooding. If the disconnected equipment is small or lightweight, it can be moved to a location above the anticipated flood level and then quickly reconnected after floodwater recedes. If the equipment is too large or heavy to move or is damaged, having quick-connect mechanisms allow for the connection of temporary equipment such as boilers, chillers, and generators until damaged equipment is repaired or replacement equipment is delivered (Figure 3-7). Although the installation of quick-connect mechanisms may not eliminate flood damage and service losses associated with flooded building utility systems, this measure can reduce damage and speed the restoration of utility services and building function.



Figure 3-7. Portable boiler provides heat during repair of flood damage.

3.3.5 Summary of Mitigation Concepts for Building Utility Systems

Table 3-1 summarizes mitigation concepts for building utility systems. Table 3-1 can be a starting point to help identify the most appropriate mitigation actions for building utility systems that warrant further examination based on the guidance in Chapter 4 and Chapter 5. The appropriate mitigation action for any part of the utility systems that serve buildings depends on whether a building is a new construction, Substantial Improvement, or a repair of Substantial Damage, in which case compliance is required. If compliance or conformance is not required, some mitigation actions may reduce vulnerability to flood damage. Other factors must be considered in the context of a specific building’s characteristics, such as whether action must be taken when flooding threatens (active or passive measures), the degree of protection required or desired and the relative cost.

Table 3-1. Summary of Mitigation Concepts for Building Utility Systems.

Mitigation Actions for Building Utility Systems	New Construction and SI/SD				Compliance or Conformance Not Required (not SI/SD) All Zones	Factors for Consideration		
	Residential		Nonresidential			Active or Passive ²	Degree of Protection ³	Relative Cost ⁴
	Zone A	Zone V (CAZ ¹)	Zone A	Zone V (CAZ ¹)				
Elevation and Relocation								
Elevate on pedestal, or pier/post-supported platform	✓	Not permitted	✓	Not permitted	✓	Passive	High	\$
Elevate on pile-supported or knee-braced platform	✓	✓	✓	✓	✓	Passive	High	\$\$
Relocate to required elevation (pedestal/platform), next higher floor, or roof	✓	✓	✓	✓	✓	Passive	High	\$\$
Relocate for component protection (dry-flood-proofed vault, machine room, flood barrier)	Not permitted	Not permitted	✓	Not permitted	✓	Active or Passive	Moderate	\$\$\$
Component Protection								
Dry floodproof (building, portion of building, vault, machine room)	Not permitted	Not permitted	✓	Not permitted	✓	Active or Passive	Moderate	\$\$\$
Flood barrier (outside or inside)	Not permitted	Not permitted	✓	Not permitted	✓	Active or Passive	Moderate	\$\$\$
Specially designed equipment	✓	Not permitted	✓	Not permitted	✓	Active or Passive	Moderate	\$\$\$
Partial Protection Measures								
Flood damage-resistant materials	Not permitted	Not permitted	Not permitted	Not permitted	✓	Passive	Low	\$\$
Facilitate replacement of below-BFE components	Not permitted	Not permitted	Not permitted	Not permitted	✓	Active	Low	\$
Emergency measures	Not permitted	Not permitted	Not permitted	Not permitted	✓	Active	Low	\$\$
Quick-connect mechanisms for below-BFE equipment	Not permitted	Not permitted	Not permitted	Not permitted	✓	Active	Low	\$

Table Notes:

1) FEMA recommends enforcing Zone V requirements in Coastal A Zone (CAZ), the area seaward of Limit of Moderate Wave Action (LiMWA).

2) Active or Passive

Active Requires human intervention, flood warning time, and significant maintenance to be effective

Passive Do not require human intervention or flood warning time with limited maintenance to be effective

3) Degree of Protection

Low Typically effective for lower flood depths (less than 3 ft.) and lower flood velocities (less than 5 ft./s)

Moderate Typically effective for moderate flood depths (4 to 6 ft.) and moderate flood velocities (5 to 10 ft./s)

High Typically effective for higher flood depths (8 ft. or more) and higher velocities (10 ft./s or more) or wave action

4) Relative Cost

\$ Generally low cost relative to other measures

\$\$ Generally moderate cost relative to other measures

\$\$\$ Generally high cost relative to other measures



4.0 Mitigation Measures for Residential Buildings

Chapter 4 describes mitigation measures for residential buildings, with a specific focus on detached one- and two-family homes and townhouses up to three stories in height. The discussions in this chapter also apply to larger residential buildings, (i.e. those covered by IBC Section 310 – Occupancy Group R), but many – particularly high-rise or mixed use buildings – may have mechanical, electrical, and plumbing (MEP) systems similar to those found in commercial buildings. Therefore, for those buildings, the guidance provided in Chapter 5 may be more appropriate. It should be noted, however, that regulations limit mitigation options for residential buildings, and so not all mitigation options discussed in Chapter 5 can be implemented in new construction or in Substantially Improved or Substantially Damaged residential buildings. For the purposes of Chapter 4 and Chapter 5, Substantial Damage requirements are covered by the Substantial Improvement requirements.

The guidance herein is generally consistent with requirements for new construction and Substantially Improved residences, but can also be applied on a voluntary basis to existing buildings not Substantially Improved or Substantially Damaged to increase flood resiliency. This chapter describes mitigation *measures* rather than specific construction techniques because there are often many ways to reduce exposure to flooding while meeting state and local codes, ordinances, referenced standards, and NFIP criteria.

NFIP regulations [44 CFR §60.3(a)(3)] state that:

All new construction and Substantial Improvements shall be constructed with electrical, heating, ventilation, plumbing, and air conditioning equipment and other service facilities that are designed and/or located so as to prevent water from entering or accumulating in the components during conditions of flooding.

This requirement is reflected in the IRC, where Section 322 requires the following to be elevated above the flood protection level:

- heating, ventilating, duct systems, and air conditioning systems, equipment and components;
- electrical systems, equipment and components;
- plumbing appliances, plumbing fixtures; and
- other service equipment.

Exceptions are allowed only when components are designed and installed to prevent water entry or where equipment can resist flood loads, including buoyancy. While it may be practical to prevent water entry into a few utility components (e.g., sealed water piping), it is often difficult to resist flood forces that tend to crush or dislodge submerged equipment. Thus, elevating utility systems is often the only practical option for flood protection.

Chapter 2 outlined information on building system NFIP requirements and building codes and other regulations that may apply. Because building codes and NFIP regulations vary by state and local government, one should always consult with local building officials to verify that all new construction or Substantial Improvement proceeds in accordance with applicable regulations. The local building official will also determine the required permits for residential utility system mitigation projects.

The following mitigation actions will be discussed in this chapter:

- **Elevation:** This measure involves elevating vulnerable components of the MEP systems by placing them on raised platforms or frames, preferably above the flood protection level. For new construction and Substantially Improved buildings, elevation is usually the only option recognized by the NFIP for mitigating residential equipment vulnerable to flood damage. In this document, elevation may be referred to as “in-place elevation” to distinguish it from the more involved, but generally more effective mitigation approach of relocation.
- **Relocation:** This measure involves moving vulnerable components of building utility systems to a higher level or higher floor in the home. Relocation is often the method that offers the least residual risk.
- **Component protection (Dry floodproofing):** This measure involves the installation of flood resistant barriers and can be used to protect vulnerable components of MEP systems (see Note). The NFIP does not recognize dry floodproofing for residential buildings as a mitigation measure; therefore, it is not an option for new construction and Substantially Improved buildings (see Warning). Nonetheless, dry floodproofing can reduce flood risks in instances other than Substantial Improvement or Substantial Damage.
- **Other Measures (Wet floodproofing):** Partial system mitigation can reduce flood damage. Certain HVAC components that have some resistance to flood damage and can be readily cleaned and repaired, may be used instead of elevation or dry floodproofing. The NFIP, the IRC and ASCE 24 allow components to be exposed to floodwater, provided they can resist flood forces and are designed and installed to prevent floodwater entry. However, it can be difficult to obtain flood-resistant utility components, particularly those that prevent floodwater entry and can resist flood loads.



NOTE: DRY FLOODPROOFING

Since it is extremely difficult to make buildings and systems completely watertight, some minimal water entry should be expected in dry floodproofed spaces that protect residential building components. Refer to Chapter 5 for technical details on specific dry floodproofing requirements for non-residential buildings.



WARNING

In addition to dry floodproofing prohibitions for new construction, Substantial Improvements, and repairs to Substantial Damage, avoid dry floodproofing residential buildings in a manner that will render the structure in violation of the NFIP.

It is advantageous to describe MEP systems as consisting of primary components and secondary components. **Primary components** are those that must operate to provide MEP service (heat, ventilation, air conditioning, electrical

power, potable water, etc.) to any portion of the home. **Secondary components** are those that, if damaged or rendered inoperable, do not interrupt the function of the entire system; portions of the home can still be served even when some secondary components have been damaged by floodwater.

Table 4-1 summarizes mitigation approaches for various MEP systems and indicates where they are discussed in this chapter. General principles are provided in Chapter 3, Compliance and Mitigation Measures.



NOTE: FLOOD PROTECTION LEVEL

This publication uses the term *flood protection level* to address the minimum elevation that the owner uses as a level of flood protection. For new construction, existing construction deemed to be Substantially Improved or Substantially Damaged, and houses otherwise directed by the authority having jurisdiction, the BFE or design flood elevation usually refers to the minimum required elevation of flood protection. When *required flood elevation* is used in this publication, it refers to the minimum elevation required for flood protection by the jurisdictional authority. At a minimum the *required flood elevation* is the BFE. In addition, *flood protection level* refers to the level selected to provide the desired protection when compliance with a code or regulation is not required and designers and owners elect to elevate or protect building utility systems.

In some situations, more than one flood protection level may be appropriate. For example, owners may elect to provide more protection for more critical or more expensive systems than they do for less critical or expensive systems that could more easily be repaired.

Table 4-1. Summary of utility mitigation measures for residential buildings.

System	NFIP Compliant New Construction or Substantial Improvement	System Repairs for Existing and Non-Substantial Improvement Construction
HVAC (Section 4.1)		
General recommendations	Minimize number of HVAC system components installed below the flood protection level. When placed below the flood protection level, install components that resist flood forces and prevent floodwater entry and accumulation.	Install system components as high as practical. When placed below the flood protection level, install components that can be readily restored or replaced and that are functionally isolated from the rest of the system.
Primary components (HVAC units, boilers, chillers, hot and chilled water pumps)	Install above the flood protection level unless components are designed to resist flood forces and prevent floodwater entry or accumulation. Dry floodproofing not allowed.	Install as high as practical. When placed below the flood protection level, protect with dry floodproofing or install components in a fashion that allows for rapid removal and restoration Dry floodproofing can be an option for interim flood mitigation.
Secondary components (duct, grills, registers, convectors, radiators, and zone control valves)	Install above the flood protection level when possible. When placed below the flood protection level, install components that resist flood forces and prevents floodwater entry and accumulation.	Install as high as practical. When placed below the flood protection level, install secondary components to reduce system impacts from flood damage.

System	NFIP Compliant New Construction or Substantial Improvement	System Repairs for Existing and Non-Substantial Improvement Construction
Electrical (Section 4.2)		
General recommendations	Minimize electrical system components installed below the flood protection level. When placed below the flood protection level, install components that resist flood forces and prevent floodwater from entry or accumulation.	Install electrical system components as high as practical. When placed below the flood protection level, install components that can be readily replaced and electrically isolated from rest of the system.
Primary components (service panel, meter, generator, portable generator connection, transfer switch)	Install above the flood protection level. Dry floodproofing not allowed.	Install as high as practical. When placed below the flood protection level, protect with dry floodproofing or install components in a fashion that allows rapid removal and restoration. Dry floodproofing can be an option for interim flood mitigation.
Secondary equipment (branch circuits and devices)	Install above flood protection level when possible. When placed below flood protection level, install components to resist flood forces and prevent floodwater entry and accumulation.	Install as high as practical. When placed below flood protection level, install secondary components that can be electrically isolated from rest of the system.
Miscellaneous equipment	See general recommendations.	See general recommendations.
Plumbing (Section 4.3)		
General recommendations	Minimize number of plumbing components installed below the flood protection level. When placed below the flood protection level, install components to resist flood loads and prevent floodwater entry and accumulation.	Install plumbing components as high as possible. When placed below the flood protection level, install components that can be readily restored or replaced and are functionally isolated from the rest of system.
Primary system components of the potable water system (booster pumps, domestic water heaters, meters, backflow prevention valves)	Install any non-submersible components above the flood protection level. Dry floodproofing not allowed.	Install any non-submersible components as high as practical. When placed below the flood protection level, protect with dry floodproofing or install components in a fashion that allows for rapid removal and restoration. Dry floodproofing can be an option for interim flood mitigation.
Wastewater systems – primary components	Place non-submersible lift and macerator pumps above flood protection level.	Install non-submersible components as high as practical. When placed below the flood protection level, protect with dry floodproofing or install components in a fashion that allows for rapid removal and restoration.
Fire sprinkler systems – primary components	Place sprinkler and jockey pumps above flood protection level.	Install as high as practical. When placed below the flood protection level, install components in a fashion that allows for rapid restoration.

System	NFIP Compliant New Construction or Substantial Improvement	System Repairs for Existing and Non-Substantial Improvement Construction
Secondary equipment of plumbing systems (domestic water, drain waste and vent piping, sprinkler piping)	Minimize number of plumbing components installed below the flood protection level. When placed below the flood protection level, install components to resist flood forces and prevent floodwater entry and accumulation.	Install as high as practical. When placed below the flood protection level, install components in a fashion that allows for rapid restoration.
Fuel Systems (Section 4.4)		
Primary components (pumps, meters, and tanks)	Minimize number of plumbing components installed below the flood protection level. When placed below the flood protection level, install components to resist flood forces and prevent floodwater entry and accumulation.	Install as high as practical. When placed below the flood protection level, protect with dry floodproofing or install components in a fashion that allows for rapid removal and restoration.
Secondary components (piping, valves)	Minimize number of plumbing components installed below the flood protection level. When placed below the flood protection level, install components to resist flood forces and prevent floodwater entry and accumulation.	Install as high as practical. When placed below the flood protection level, protect with dry floodproofing or install components in a fashion that allows for rapid removal and restoration.
Conveyances – Elevators and Lifts (Section 4.5)		
Primary and Secondary components (motors, pumps, controls)	Minimize number of conveyance components installed below the flood protection level. When placed below the flood protection level, select components that will resist flood forces and prevent floodwater entry and accumulation.	Install components high as practical. When placed below the flood protection level, protect with dry floodproofing or install components in a fashion that allows for rapid removal and restoration.

4.1 Heating, Ventilation and Air Conditioning (HVAC)

It is advantageous to describe HVAC systems as consisting of *primary* components and *secondary* components. Primary components are those that must function to provide heat, ventilation or air conditioning to any portion of the home. Secondary components are those that, if damaged or rendered inoperable, do not interrupt the entire HVAC system. Portions of the home can still be supplied by HVAC systems even after some secondary components are damaged or destroyed by floodwater.

Most residential HVAC systems provide both heating and air conditioning, usually through forced air ductwork. In forced air systems, air is conditioned (heated or cooled) in a primary unit (furnace or air handling unit) and then distributed throughout the conditioned portions of the home via a system of supply and return ducts, grills and registers. Furnaces are typically fuel-fired but can be electric. Conditioned air is then reheated (or re-cooled) and recirculated.

HVAC systems that provide only heat are not necessarily forced air systems. Other options include hydronic systems and hybrid systems. In hydronic systems, hot water is heated by a boiler and circulated throughout the home. With hybrid systems, the hot water provided by the boilers is circulated through hot water coils in air handling units where it heats the distributed air.

A residential HVAC system is shown in Figure 4-1 which depicts a home supplied with dual forced air HVAC units and associated ducts, grills and registers. One HVAC unit with its associated supply ducts and return ducts is located in the basement; the second unit is located in the attic. The basement unit serves the first floor; the attic unit serves the second floor. Table 4-2 lists the primary and secondary components and the subsections where mitigation options are discussed.



NOTE

In newer, more tightly constructed homes with limited leakage, fresh air may be provided by heat recovery ventilators (HRVs) or energy recovery ventilators (ERVs). These components constantly exhaust stale interior air and draw in fresh outside air. These systems generally consist of interior air handling units or furnaces and exterior compressor or condensing units. HRV and ERV systems can be stand-alone and have dedicated supplies and return (fresh air and exhaust) ducts or they can work in conjunction with the main HVAC system.

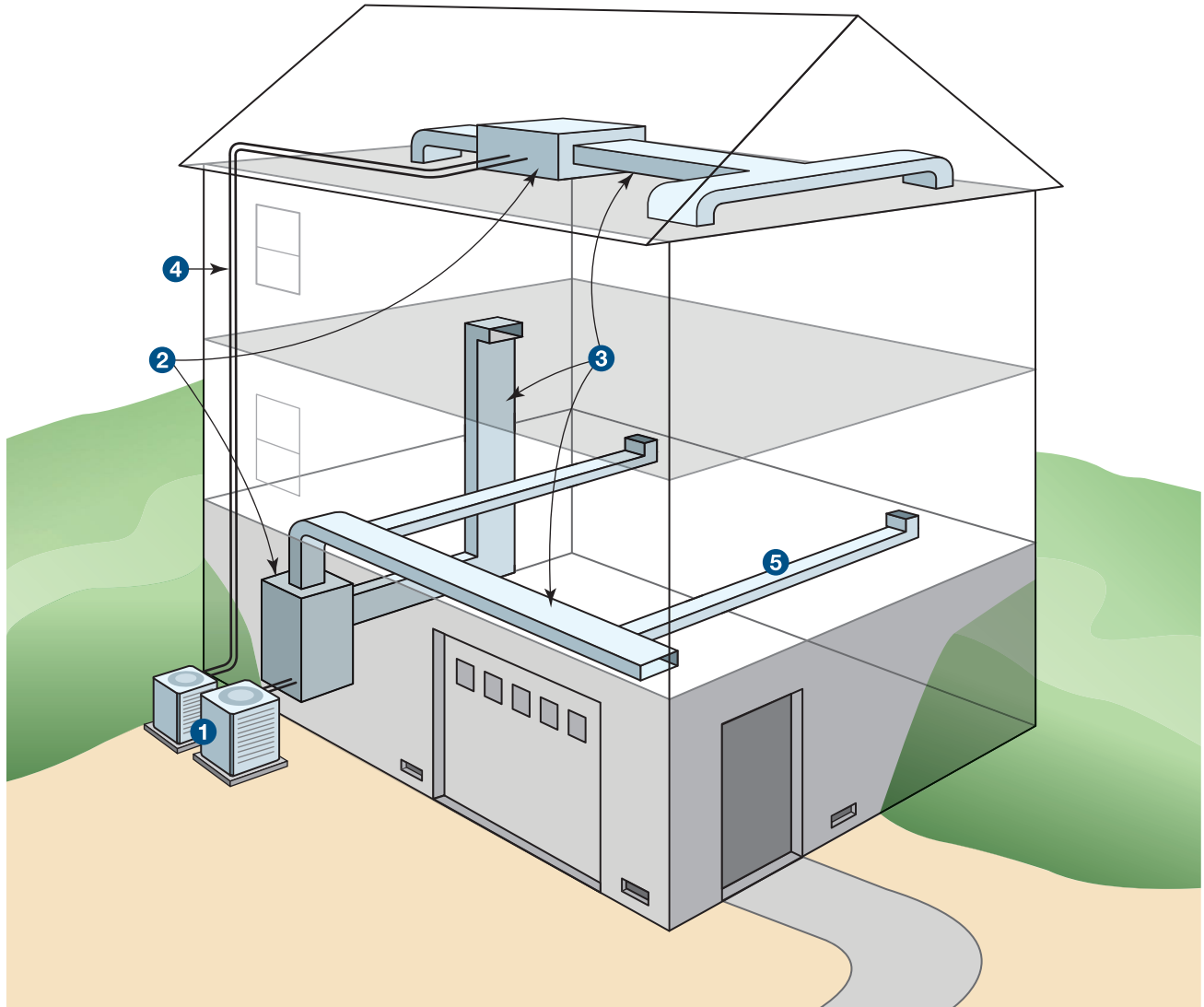

Component	Type
1 Exterior units	Primary
2 Interior units	Primary
3 Supply and return trunkline ducts	Primary
4 Interconnecting piping	Primary
5 Lateral supply ducts and registers (typical)	Secondary

Figure 4-1. Example of a residence supplied by two forced-air HVAC systems.

Table 4-2. Typical primary and secondary components of residential HVAC Systems.

HVAC equipment type (Subsection)	Components
Primary components (4.1.2.1)	Air handlers and air handling units (AHUs), trunk line supply, and return ducts
	Compressor and condensing units (AC units and heat pumps)
	Furnaces and boilers
	Circulator pumps
Secondary components (4.1.2.2)	Lateral supply and return ducts
	Piping (when present)
	Convectors, radiators, and zone control valves

The primary HVAC components include all equipment necessary to heat or cool the home. Primary components vary with the style of HVAC system, but typically include air handling units (AHUs), AC condensers or heat pumps, furnaces, boilers, and circulator pumps. In forced air systems, the sections of supply and return ducts that connect to the HVAC units are also primary components because they are required for a functional heating or cooling system. Often, the primary sections of ducts are called trunk line ducts. Components of other systems that supply the HVAC equipment, such as fuel supply and piping and electrical components needed for operation, are considered primary components. These components include the controls needed for the system to function, which may be one or multiple thermostats and motor-operated valves or dampers.

Regardless of the system type, most HVAC components are not flood resistant and are readily damaged if exposed to floodwater. Typically, primary components are completely destroyed when inundated by floodwater. Inundation short-circuits the unit’s electrical equipment, saturates insulation, and usually introduces silt and sediment into the unit. Mold can develop, especially in duct work. Also, due to the corrosive nature of floodwater, inundation typically causes rust and oxidation that can damage a unit after floodwater recedes.

Flood mitigation can reduce physical damage and loss of function from flooding. Primary components are often the most expensive components to replace, resulting in the longest period of system downtime. If a flood occurs in cold weather regions during the winter season, the resident may not get a Certificate of Occupancy to return to the home until the heating system is fully functional. In many homes, HVAC system components are one of the best candidates for mitigation. Due to the cost of primary components and their integral function in the home, mitigation measures that produce even moderate reductions of flood risk should be considered.

The following sections discuss techniques for elevation and protection of the main components of residential HVAC systems. Selection of mitigation measures may be dictated by code requirements. For example, for heat-producing devices like boilers, furnaces and fuel-fired water heaters, codes often limit clearances to combustibles. Those clearances could limit how much a boiler, furnace or water heater can be elevated. Local building code officials should be consulted to verify that actions taken to reduce flood risks satisfy all codes.

4.1.1 Flood Risks to HVAC Components

The risk of flood damage to HVAC components depends on their elevation and location in the residence and by how the home was built. The primary components of a home’s HVAC system are often located in the basement if one is present, where they are most vulnerable to flood damage. Primary HVAC components in slab-on-grade homes are located typically on the first floor, the attic, or in an attached garage. Often, the elevation of the garage is lower than the house itself (due to fire codes or site considerations); therefore, HVAC components located

in a garage may be at greater flood risk unless they are elevated. Homes built over crawlspaces often have HVAC components placed in the crawlspace, including ductwork and even the heating and air conditioning units. In multi-level homes with two or more HVAC systems, primary HVAC components are often located in attic areas with a much lower flood risk.

In air-conditioned homes, exterior compressor units are typically used. The compressor unit works with an interior HVAC coil unit to remove heat from the interior and exhaust it outside. Condenser units are usually placed outside at grade level except for new construction, for which the NFIP and building codes require placement of components at or above the required flood protection level. If placed at grade, condenser units might be located below this level, thus increasing the risk of flood damage.

Secondary HVAC components can be damaged without the entire system losing service. Secondary systems often provide heating, ventilation, or cooling to portions of the building, or they may be optional components, like humidifiers, that are not necessary for operation. For forced-air systems, secondary components include portions of the supply and return ductwork that serve individual rooms or spaces, as well as the supply registers and return grills in those rooms or spaces. As mentioned previously, the main supply and return ducts – often called trunk lines – are considered primary components because they are essential to provide heating, ventilation or cooling to homes. For hydronic systems, secondary components include piping and convectors, radiators, and zone control valves.

Like primary components of HVAC systems, most secondary components can be damaged or destroyed by floodwater. Air handling components are particularly vulnerable because of the common practice of installing ductwork below the living space and supplying conditioned air from floor grills and registers, which exposes ductwork to flood damage.

Ducts in residential systems typically operate at static pressures of approximately one inch of water column, which is about 0.04 pounds per square inch (psi), or about 5 pounds per square foot (psf). Floodwater can create much greater pressures on sealed ducts even when those ducts are only partially submerged. For example, the hydrostatic pressure on the bottom of a sealed HVAC duct submerged in 6 inches of floodwater is 0.22 psi, or about 30 psf. That pressure is six times the operating pressure of the duct. Because ducts are typically sealed to resist air leakage, they will collapse or be crushed even when only partially submerged.

When ducts are not sealed, floodwater entering the ducts will reduce the hydrostatic loads because they are a function of the amount of water displaced by the duct; if ducts fill with water, the net hydrostatic force is zero. Floodwater entering ducts will typically contaminate the system through an accumulation of grit, sand, mud, pathogens, petrochemicals, herbicides and pesticides, fertilizers, sewage, and other materials.

Fiberglass insulation commonly used for residential HVAC ducts readily absorbs water. Unless flood resistant closed-cell insulation is used, flooding contaminates and often destroys ductwork insulation and requires the insulation to be replaced. Other HVAC components can also be damaged if their insulation is saturated.

The corrosive nature of floodwater can cause long-term degradation of secondary components if they cannot be adequately cleaned after a flood event. Piping in HVAC systems offer some inherent resistance to floodwater (particularly from still water flooding), but piping insulation can still be destroyed when inundated. The corrosive effects of floodwater can damage some piping components like valve stems, threaded fittings, and piping supports.



NOTE

In SFHAs where flood elevations have been determined with delineated BFEs, the actual flood risk to the HVAC system can be determined by comparing the HVAC equipment elevation to the required flood elevation. In areas outside of SFHAs, or in SFHAs where flood elevations are undetermined, historical data and records often can be used to assess flood risk.

4.1.2 Mitigation for HVAC Components

The most effective method of mitigating flood risk for primary HVAC components is elevating them, preferably above the required flood protection level. In some situations, it may not be necessary to achieve this level to make mitigation effective. Sometimes, elevating HVAC components even a few inches can reduce flood risk significantly. While any amount of elevation reduces flood risk, components should be elevated as high as practical to achieve the greatest mitigation benefit.

Several considerations control the achievable elevation, including:

- size and height of components and ceiling clearance height where components are located;
- required clearance to equipment and combustibles that require maintenance;
- provisions for combustion air and vents;
- access for maintenance, routine servicing, and repairs;
- connections to other HVAC components, particularly duct connections and condensate lines; and
- ability to support and anchor elevated equipment.

Unit height and height of spaces containing equipment: When primary HVAC components are elevated in place (as opposed to being relocated), component height and available vertical clearance often determines how high they can be elevated. Some options to increase vertical clearances, like relocating ducts to run between framing members, may be available. Increasing vertical clearances using structural modifications, however, are often impractical.

Elevation of exterior components like condensing units may not be hindered by equipment height, but rendered impractical by restrictions to access for servicing the equipment. Maintenance access may influence the ways in which equipment can be elevated. For example, platforms that allow service technicians access may require stairs and safety railings.

Clearance to combustibles and working space: Most heat-generating HVAC equipment requires minimum clearance to combustible materials. Different clearances are often necessary for the top, bottom, sides, and back of a unit. Working space must be maintained for servicing, repairs, and component replacement. Specific clearances to combustible and working space are in manufacturers' installation manuals.

In some installations, non-combustible materials can be installed between the heat-generating HVAC equipment and combustible materials to allow for equipment elevation.

Combustion air and venting: Fuel-burning devices require combustion air-venting for gas exhaustion. When elevating equipment, those provisions need to be maintained. Combustion air provisions are usually satisfied if HVAC equipment elevation is in place, but proper venting can limit elevation height. For example, vents need to slope upward to maintain draft and to allow condensation (for condensing units) to drain properly. Thus, when HVAC equipment is elevated, exhaust equipment must be elevated as well.

Access for maintenance, servicing, and repairs: When elevating equipment in place, access is usually not significantly changed. However, if elevation involves moving the equipment to other areas of the residence, then access for maintenance, servicing, and repair must be accommodated.

Connections to the HVAC system: Primary HVAC components are connected to other system components. While these connections may be easily made with water heating systems, forced air systems feature connections to relatively large ducts that require significant space for installation. The space and configuration of system connections will often determine flood mitigation options to reduce flood exposure of the connections.

Ability to support and anchor equipment: All elevated equipment should be, and may be mandated by code to be adequately supported to carry the weight of equipment. In seismic areas, the supports must also resist earthquake forces. Those forces can include lateral and vertical loads that depend on the equipment's weight and center of gravity. Earthquake forces on equipment can increase with elevation; therefore, earthquake forces should be determined for the elevated location. Exterior equipment must also be supported and anchored to resist other environmental loads like wind, ice, and snow.

Exterior HVAC equipment: Outdoor HVAC equipment can be placed on elevated pedestals or platforms. In coastal areas, floodways, and areas subject to high velocity flooding where floodwater can undermine foundations supporting pedestals or platforms, outdoor HVAC equipment should be supported by piles that extend below the expected depths of erosion, scour, and frost. Alternatively, HVAC equipment can be placed on platforms that cantilever out from the structure. In both cases, the platforms should elevate equipment above the required flood protection elevation. Where possible, pedestals and platforms should be located on the landward side (in coastal areas) or downstream side (in riverine areas) of homes to minimize risk from flood-borne debris impact. In coastal areas, the lowest horizontal member supporting the equipment or platform should be above the required flood protection elevation to avoid damage from breaking waves.

Exterior equipment should be anchored or strapped to resist wind and other forces as specified by local building codes. In coastal areas, anchors and straps should be stainless steel or hot-dip galvanized to resist salt spray and corrosion.

Figures 4-2 and 4-3 show examples of elevated residential HVAC components supported by cantilevered platforms.

Mitigation Scheduling and System Downtime: Most mitigation requires some system downtime. Components must be taken out of service during elevation or relocation. It is often preferable to mitigate during system replacement when the system is shut down. When mitigating newer equipment that is still serviceable, scheduling the mitigation may reduce the impact of that downtime. For example, mitigation of heating or air conditioning equipment can be performed during temperate times of the year when the temporary interruption of heat or air conditioning may not be a significant inconvenience.



NOTE

The NFIP requires that all HVAC equipment that cannot be elevated above the BFE be designed to prevent water from entering and accumulating within the equipment. Nonetheless, this option is rarely practical because it is extremely difficult to prevent water intrusion.

4 MITIGATION MEASURES FOR RESIDENTIAL BUILDINGS

Figure 4-2. Elevated HVAC condenser units in a coastal zone with a protective railing installed (Galveston Island, Texas).



Figure 4-3. Elevated HVAC condenser unit on cantilevered platform (Port Bolivar, Texas).



Whether mitigating operational equipment or waiting until equipment needs to be replaced before mitigating the system, advanced planning and consultation with the building official is important. Planning allows for various options to be considered and the best selected, and the scope of work to be clearly defined, quantified and budgeted so that mitigation can be completed as efficiently as possible.

4.1.2.1 Mitigation for Primary Components

In-Place Elevation: As previously mentioned, the most effective flood mitigation for primary HVAC components is elevation, preferably above the required level. When vertical clearance exists and connections to the primary unit allow it, the unit can be elevated *in-place*; that is, the unit can be elevated without moving it to a higher floor. In-place mitigation is generally simpler, less expensive, and more practical than relocating equipment to a higher floor.

One of the more common approaches for in-place elevation is to construct platforms or frames to elevate, support and anchor primary components. This approach requires temporary removal of equipment, relocation while the platform or frame is constructed, and reinstallation at the new, higher elevation. Figure 4-4 shows a platform being used to elevate an interior HVAC unit in-place. Where possible, the exterior units should be elevated to provide equal flood protection.

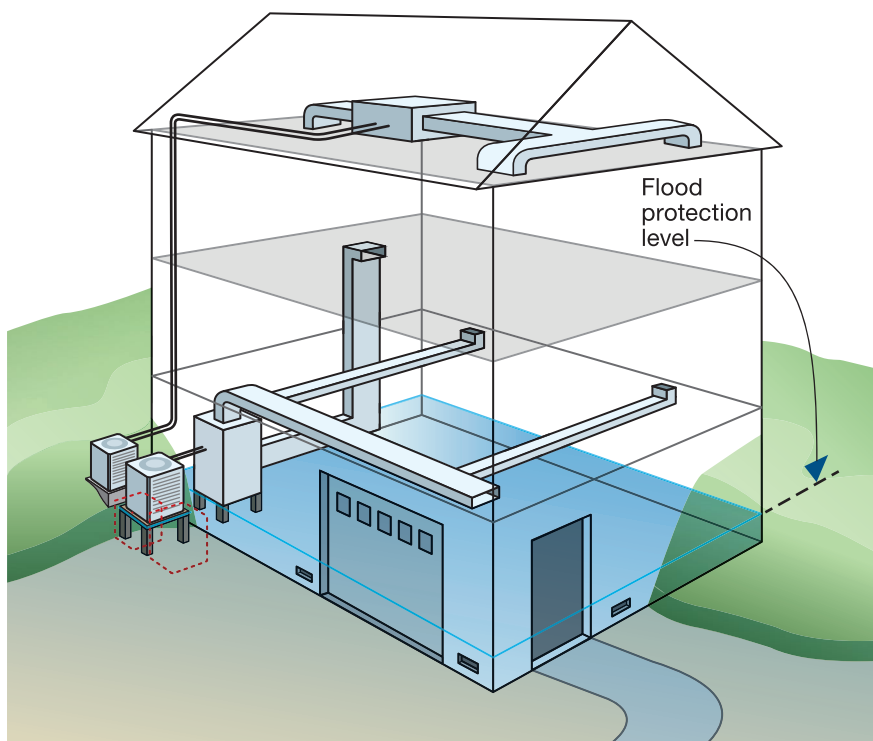
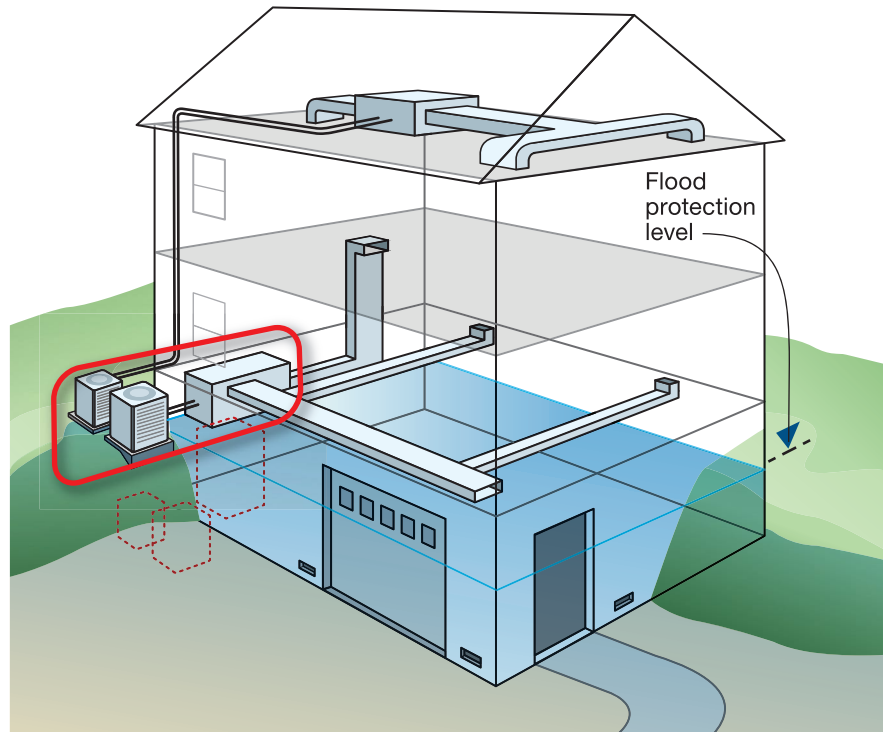

Figure 4-4. Placing the interior HVAC unit on an elevated platform and placing the exterior units at a higher grade provides greater protection from flooding.

Component reconfiguration: If ductwork is already sufficiently elevated (or can be elevated) but insufficient vertical clearance exists for installing an elevated frame or platform, component reconfiguration may be a viable option. With component reconfiguration, a vertical HVAC unit is replaced with a horizontal unit. This approach is often most feasible with heat pumps that do not produce exhaust gases that require venting, or condensing furnaces that require vents for exhaust gases but the vents can be installed close to combustible materials.

Figure 4-5 shows an HVAC system being reconfigured to a horizontal unit that can be placed at a higher elevation than a vertical unit. Figure 4-5 also shows the exterior condensing units placed at a higher elevation to reduce flood risk exposure.

Figure 4-5. Replacing a vertical style interior HVAC unit with an elevated horizontal style unit and placing exterior units at a higher grade provides greater protection from flooding.



Component relocation: If there is insufficient clearance to elevate equipment in-place and reconfiguration is not an option, component relocation may be a feasible mitigation option. Component relocation involves moving a component or piece of equipment from its original position to a higher location in the home, typically to a higher floor. Component relocation can be more effective than elevating in-place because it adds at least a story height (8 to 10 feet) of elevation as opposed to the 1 to 3 feet typically achievable with in-place elevation, or the 4 to 6 feet with component reconfiguration. However, component relocation generally involves more extensive work than either of the other methods discussed, and may be impractical in some cases.

Relocating primary HVAC components can require newly created space on an elevated floor to house the equipment. In residences, closets are often used. The space must be large enough to house the equipment while maintaining clearance to combustibles and access for repairs and maintenance. Forced air systems need to connect to existing supply and return ducts; fuel fired units need to exhaust combustion products. Also, electric power and control wiring, as well as fuel piping or hot water piping, need to be brought to the new location. For these reasons, component relocation is typically done only during major renovations that can meet Substantial Improvement requirements where all code and NFIP criteria must be met. Figure 4-6 shows a HVAC unit relocated from the basement to the first floor.

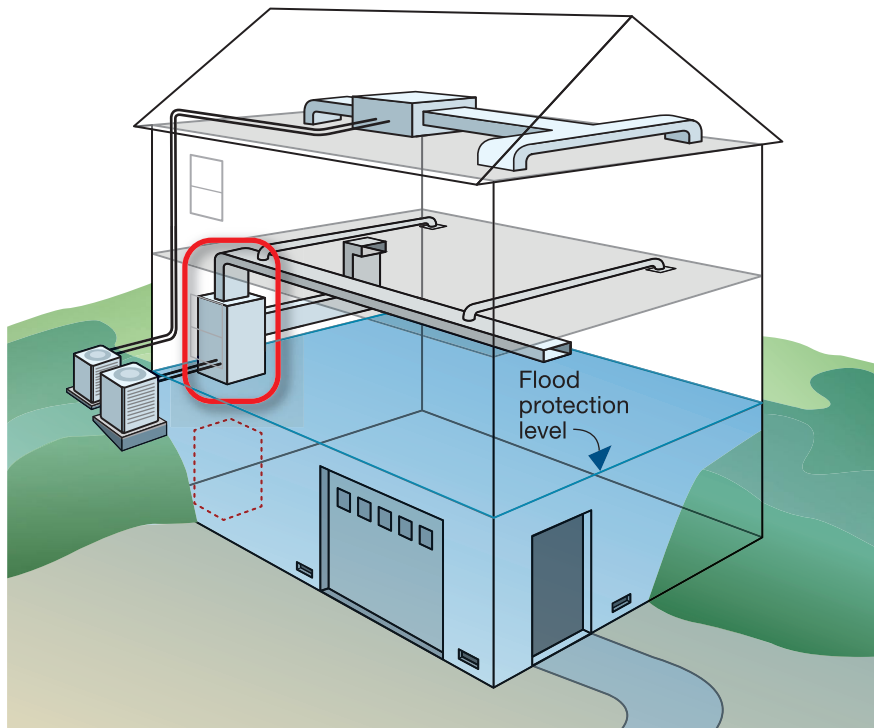

Figure 4-6. Relocating the basement HVAC unit to the first floor and placing exterior units at a higher grade provides greater flood protection than in-place elevation.

Component protection (dry floodproofing): When HVAC units cannot be elevated in place, reconfigured, or relocated to a higher floor, dry floodproofing may be an option if the residence is not new construction or undergoing Substantial Improvements.

Dry floodproofing involves enclosing components in watertight walls that extend up to the flood protection level. An example is shown in Figure 4-7. For dry floodproofing to be effective, the walls and floor of the protected area must be strong enough to withstand all applicable flood forces (including hydrostatic and buoyancy forces) and the equipment must be heavy enough – or sufficiently anchored – to resist buoyancy. If the flood protection level is relatively low (12 inches or less), a low wall or curb can be constructed without requiring a closure panel, so long as stepping over the top of the wall does not unduly limit access. For higher walls, the configuration shown in Figure 4-7 may be appropriate. Closure panels should be latched except when servicing the equipment (Figure 4-8).

Because it is usually difficult to create completely watertight enclosures, provisions should be made to address seepage. Sump pumps to remove water that seeps into dry floodproofed areas should be installed. Because electric power could be interrupted during a flood event, a standby power source is recommended. The type of standby power depends on seepage rates and the flood duration. When seepage rates are well controlled and flooding is of a short duration, stored energy devices like batteries may suffice. In regions with longer duration floods where seepage is not well controlled, an on-site standby generator may be needed. The generator, its fuel system, and all wiring needed to supply the sump pump would need to be protected from flooding.

Figure 4-7. Dry floodproofing with a watertight wall and access gate used to protect mechanical and plumbing equipment.

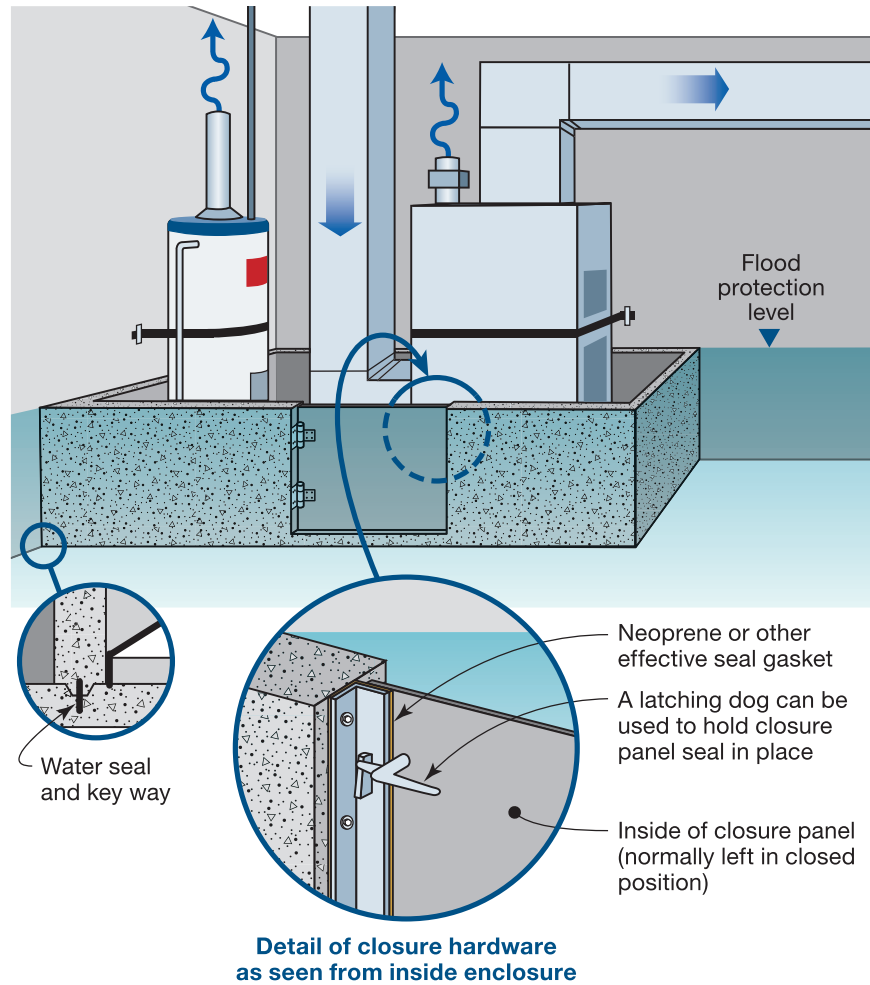

Connections: Most HVAC equipment requires several connections to components in the HVAC system and to other systems (i.e., electrical). Providing connections that facilitate removal and replacement of damaged equipment can minimize system downtime.

Connective unions like T-sections can be installed in piping to simplify new connections to existing piping. Junction boxes can be installed in the branch circuits that supply HVAC equipment. The junction boxes allow wiring between those boxes and the flood-damaged HVAC equipment to be replaced without disturbing the undamaged portions of the wiring routed above the floodwater. Flexible couplings or splices can be installed in ducts to facilitate replacing flood damaged ducts with ducts not exposed to floodwater. The flexible couplings should be placed as high as possible, preferably above the flood protection level.

Transitions such as unions and junction boxes should be located above the flood protection level. Also, codes require that these components be accessible and not located in concealed spaces.

For HVAC components that are relatively small and light, these connections may allow preemptive actions to prevent flood damage. Disconnection points may allow the unit to be temporarily removed before the flood and reinstalled after floodwater recedes. If mitigation allowing preemptive removal is planned, isolation valves should be installed upstream of the disconnection points.

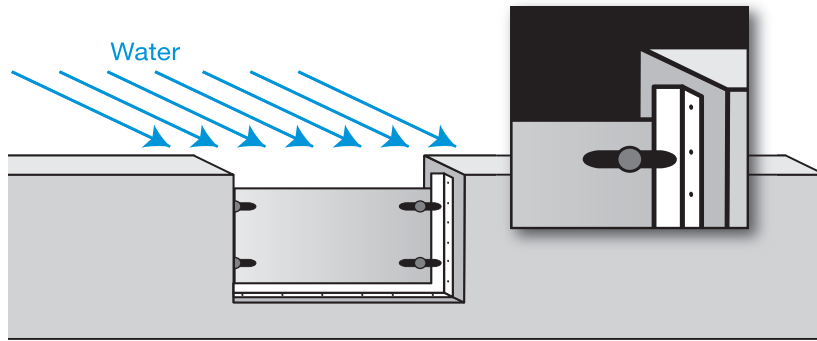

Latching dogs are commonly used to secure a closure panel

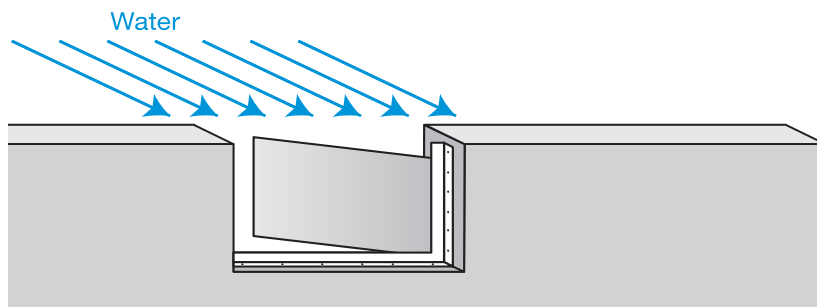

Side-hinged closure

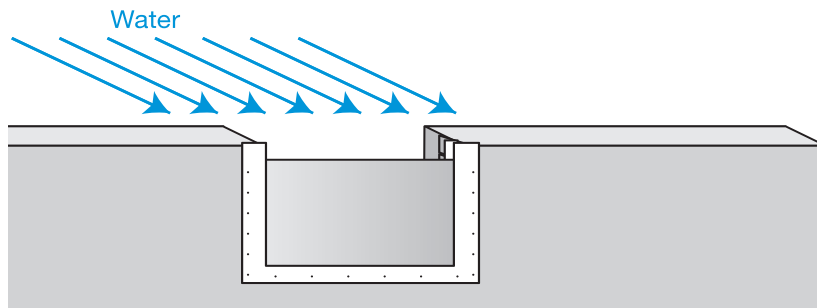

Drop-in closure

Figure 4-8. Alternate dry floodproofing methods for protecting equipment.

Other mitigation methods: In some residential construction, the options for in-place elevation, component re-configuration and dry floodproofing are limited and component relocation is cost-prohibitive or otherwise not practical. In those situations, unconventional methods that may require human intervention (active mitigation) or are not acknowledged by codes and standards may offer some benefits. Flood risk may not be reduced, but recovery from flooding could be accelerated.

4.1.2.2 Mitigation for Secondary Components

Secondary components are usually less expensive than primary components and, because they often extend throughout the home, can be difficult to mitigate entirely. For many residences, some secondary components can be damaged by flooding without causing a loss of system function for the entire home.

Elevation: Like mitigating primary components, the most effective strategy for mitigating secondary components is to elevate them, preferably above the flood protection level. Occasionally, some flood mitigation can be accomplished by in-place elevation, but often component relocation is needed. Component protection is generally not

feasible for secondary HVAC components. Wet floodproofing may be an alternative, but the ability to clean components thoroughly after a flood event must be considered.

Air handling ducts are generally the most significant secondary components in forced air HVAC systems. Elevating ducts can be done by:

- suspending ducts from floor framing if framing is sufficiently elevated;
- locating ducts above finished living spaces (i.e., in attics or knee wall areas) if those areas are sufficiently elevated;
- locating ducts above suspended ceilings; or
- locating ducts near the ceilings, concealing them in soffits.

In new and Substantially Improved construction, ducts below the required flood elevation are not allowed unless they are designed to resist flood forces and constructed so that floodwater will not enter or accumulate in them. Ducts that resist flood forces and prevent floodwater entry are not widely available items and, while allowed, they are likely impractical for residential construction. From a practical standpoint, elevation is likely the only option to protect ducts in new or Substantially Improved construction.

Elevating ducts can be straightforward in new construction and may be straightforward in some Substantially Improved homes. Repairs or improvements often involve removing interior finishes, exposing areas that are typically concealed or inaccessible and creating new routes for ducts that allow them to be placed above the required flood elevation. Ducts that run parallel to framing often can be installed between floor, ceiling, or roof framing, but fewer options are available where ducts need to run perpendicular to framing. Open-web, parallel-chord trusses used in some residential construction offer some spaces to route ducts (particularly for flexible ducts), but solid framing (dimensional lumber) or prefabricated wood I-joists typically used in residential construction do not allow the routing of ducts through framing members. When ducts need to be routed perpendicular to solid framing, they can only be run either above or below that framing.

The American Wood Council's *Wood Framed Construction Manual* (WFCM) contains criteria on boring and notching framing members. Those criteria generally allow small holes and notches to be made in wood framing for wiring and domestic water or gas piping to be routed through members, but do not allow holes or notches large enough to install any ducts. The WFCM is referenced by both the IRC and IBC and is often used for residential construction. Parallel chord trusses should never be cut or modified to allow duct installation unless modifications are designed by a licensed design professional.



NOTE

Locating ductwork between floor joists should be carefully considered. Only ductwork running parallel to the direction of the floor joists can be elevated in this manner. Ductwork running perpendicular to floor joists usually needs to be placed below except in new construction where open-web, parallel-chord floor trusses are used.



WARNING

Modifications to joists or other portions of the floor framing should be evaluated carefully to verify that the mitigation effort does not affect the structural integrity and load-carrying capacity of the framing.

In homes built over crawlspace foundations, HVAC ducts supplying the lowest floors are often located in the crawlspace and are more prone to flood damage due to their placement one to two feet below the first finished floor elevation. Some flood mitigation may be achievable while keeping the ducts in the crawlspace. For example, the lateral sections of duct can be elevated between floor framing members. It is usually necessary to relocate the duct system at or above the first-floor ceiling to achieve effective mitigation.

Relocating ducts from crawlspaces to living space requires removal of some interior finishes, relocation of the main trunks of the ducts above the first-floor ceiling, and placement of lateral duct sections between framing members of the second floor (if there is one). Relocated ducts can be enclosed in interior finishes to create a boxed-in soffit or may be placed above the first-floor ceiling. Rectangular trunk lines that are shorter and wider may need to be selected to provide the minimum ceiling height dictated by local codes.

Where possible, relocating ducts to an attic is often the most practical and feasible option. In most attics, roof framing creates sloped ceilings that enable ductwork to be run along the base of the rafters, minimizing intrusions into the attic space. Main duct trunk lines can run along the floor of the attic, and lateral taps off of those trunk lines can run between attic floor framing or vertically into the living space below. As mentioned previously, AHUs and furnaces occasionally can be relocated into attic areas to maximize flood protection. Figure 4-9 shows options for relocating ducts to reduce flood risks.

When considering duct relocation, the final configuration of the duct systems should be evaluated by the HVAC contractor with assistance from a designer. The duct system will need to be evaluated; new ducts may need to be longer, and larger ducts may be needed to account for the greater friction losses of the longer duct runs. These modifications may require changes to the supply and return duct systems. Supply and return grill styles may need to be changed. The supply grills located near the floor are often a different style than those placed closer to the ceiling and the optimum placement of supply grills and return louvers can change when reconfiguring an HVAC duct system for flood mitigation.

In homes that are not under repair or renovation or where flood mitigation retrofit is being considered, interior finishes are likely in place, complicating duct relocation. In those instances, some compromises may be necessary to balance costs and flood mitigation effectiveness. Because the cost of duct relocation would usually trigger neither Substantial Improvement requirements nor NFIP and building code flood provision compliance, homeowners can consider mitigation that does not fully comply with contemporary codes and standards but significantly reduces flood damage repair and replacement costs. While full compliance is desirable, partial compliance may be appropriate for reduction of potential flood damage and can be part of a long-range phased mitigation renovation that will eventually achieve full compliance.

All controls and electrical components are extremely susceptible to damage by floodwater. However, they can usually be inexpensively relocated above the flood protection elevation.



NOTE

When elevating a house or determining a lowest-floor elevation for a home, it is important to consider protection of all mechanical systems below the first floor. The cost to elevate to the additional height necessary to prevent HVAC components from being impacted by a design flood is often minimal.

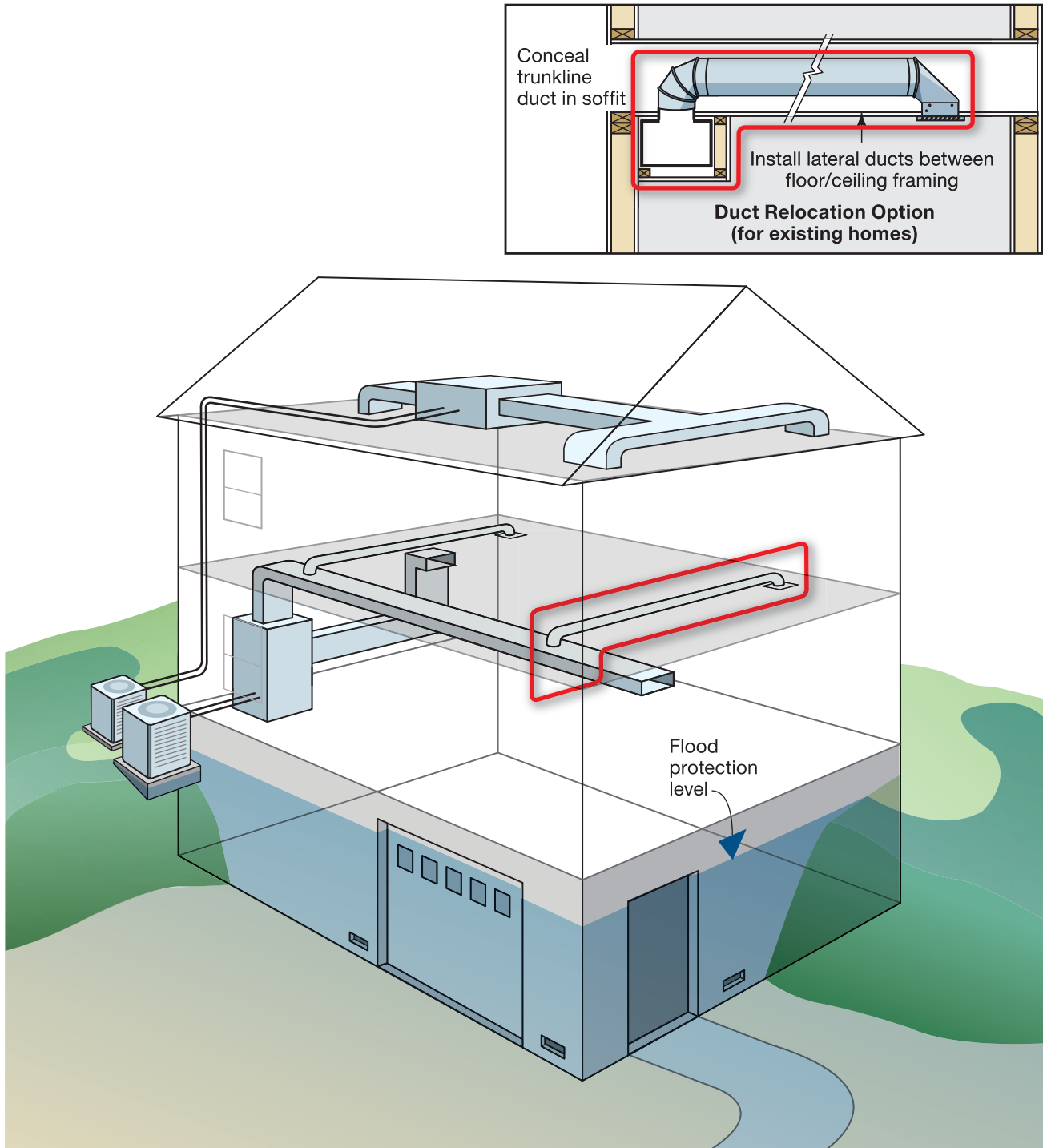
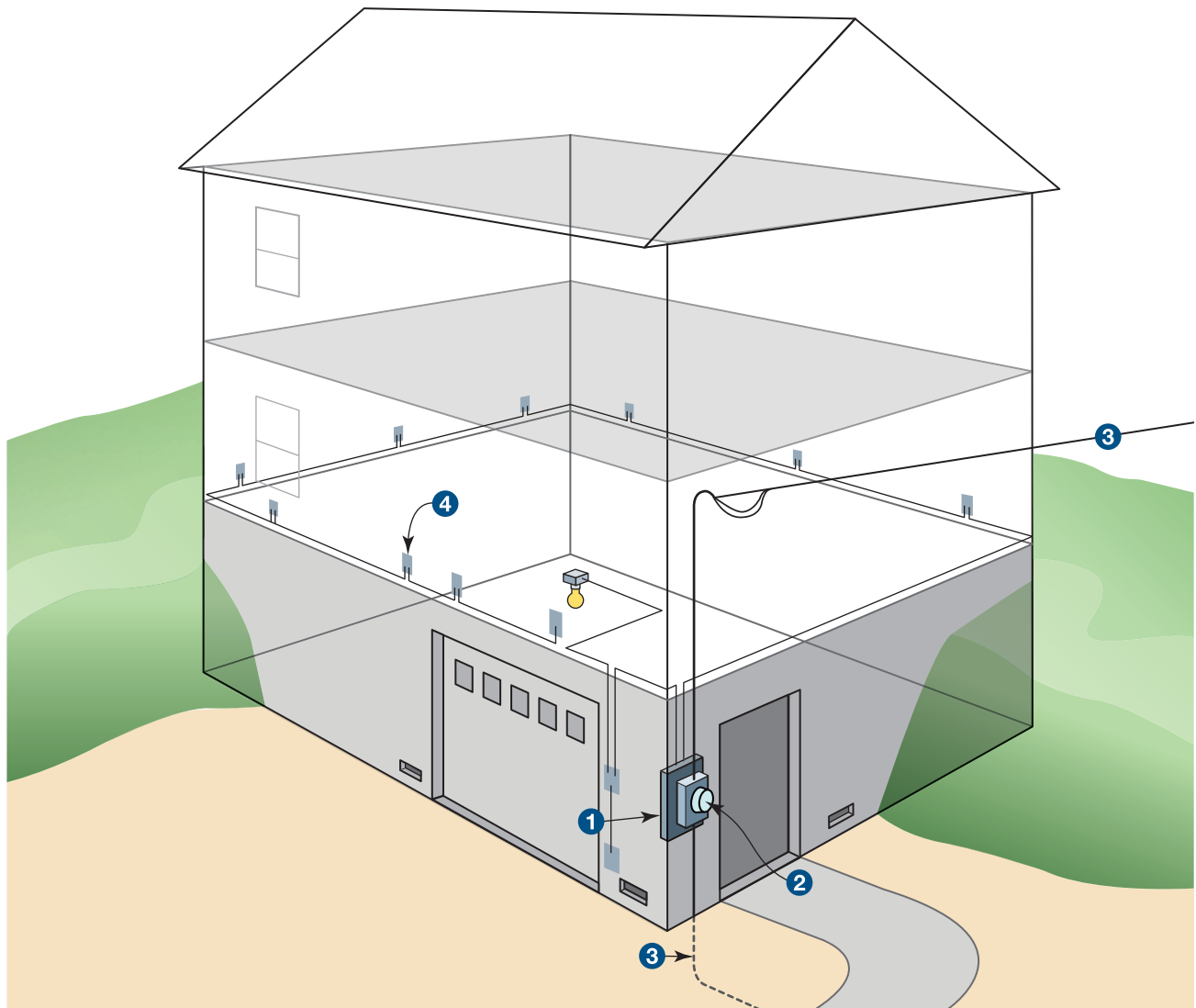

Figure 4-9. Creating a concealed soffit to allow a duct trunkline to be relocated.

4.2 Electrical Systems

A typical residential electrical system is shown in Figure 4-10. Power originates from a utility transformer that generally provides single phase 120/240 volt power for detached one- and two-family dwellings. The transformer may be pole- or pad-mounted. Larger multi-family residential buildings may receive single phase 120/208 volt power derived from a three-phase system, but flood recommendations are the same in either case. For clarity, only portions of the branch circuits and electrical devices are shown.



Component	Type
① Main service panel	Primary
② Utility meter	Primary
③ Service drop or service lateral	Primary
④ Branch circuits	Secondary

Figure 4-10. Typical residential electrical system.

From the transformer, power flows through an overhead service drop or an underground service lateral to a utility meter where power consumption is measured for billing purposes. Utility meters are typically centered about five feet above grade so that they may be read and easily removed when a customer's power needs to be shut off.

From the utility meter, power enters the building and feeds the main service disconnect, which may be a separate enclosed fuse or circuit breaker, or may be mounted in the home's main panel. Most homes have a single main panel; larger homes, homes with additions, and those that have a combination of new and legacy wiring may have two or more panels. When present, electrical feeders connect panels that are downstream of the main panel to the main panel.

Panels contain overcurrent devices such as circuit breakers or fuses that protect branch circuit wiring. The branch circuits are either 120 volt (lights and outlets) or 240 volt (appliances like ranges, ovens, electric water heaters and air conditioning units that draw significant power).

Homes that have standby generators or provisions to connect portable generators are enabled by transfer switches to draw power from the utility company, or from the generator if utility power is not available. Transfer switches are either automatic transfer switches (ATs) or manual transfer switches (MTs). ATs automatically sense a loss of utility power, send a signal to start the generator and operate to transfer loads from the utility to the generator. MTs require manual transfer of power from the utility to the generator. Homes with on-site generators may have ATs or MTs; homes with properly designed provisions to connect temporary generators typically have MTs.

Figure 4-11 shows a home supplied with an on-site standby generator. The home features two branch circuit panels. One of the panels (designated "N" for normal power) is the main service panel, which is supplied only from the utility. The other panel (designated "NE" for normal/emergency) is supplied from the transfer switch that receives power from the utility through the main service panel, or from the standby generator. Loads considered important such as the refrigerator, freezer, well pump, water heater, and selected lights and receptacles are typically supplied from the normal/emergency panel. Loads deemed less important – particularly those that draw significant power like electric ranges, air conditioning units, and clothes dryers – are often supplied by the normal power panel to allow a small standby generator to supply the home.

Electrical systems can be divided into primary and secondary components. Primary components are needed for any portion of the system to function; secondary components can be damaged or rendered inoperative without causing a total loss of function for the electrical system. Table 4-3 lists the typical components of a residential system and distinguishes them as primary or secondary components.



WARNING

Transfer switches are critical to protecting utility workers. Improperly connected generators can feed power back onto power lines. When the 120/240 volt power typically produced by a residential generator flows back through the utility's transformer, the voltage is increased to 12,000 volts or more. Utility line workers repairing damaged power lines can be injured or killed instantly from back-fed power.

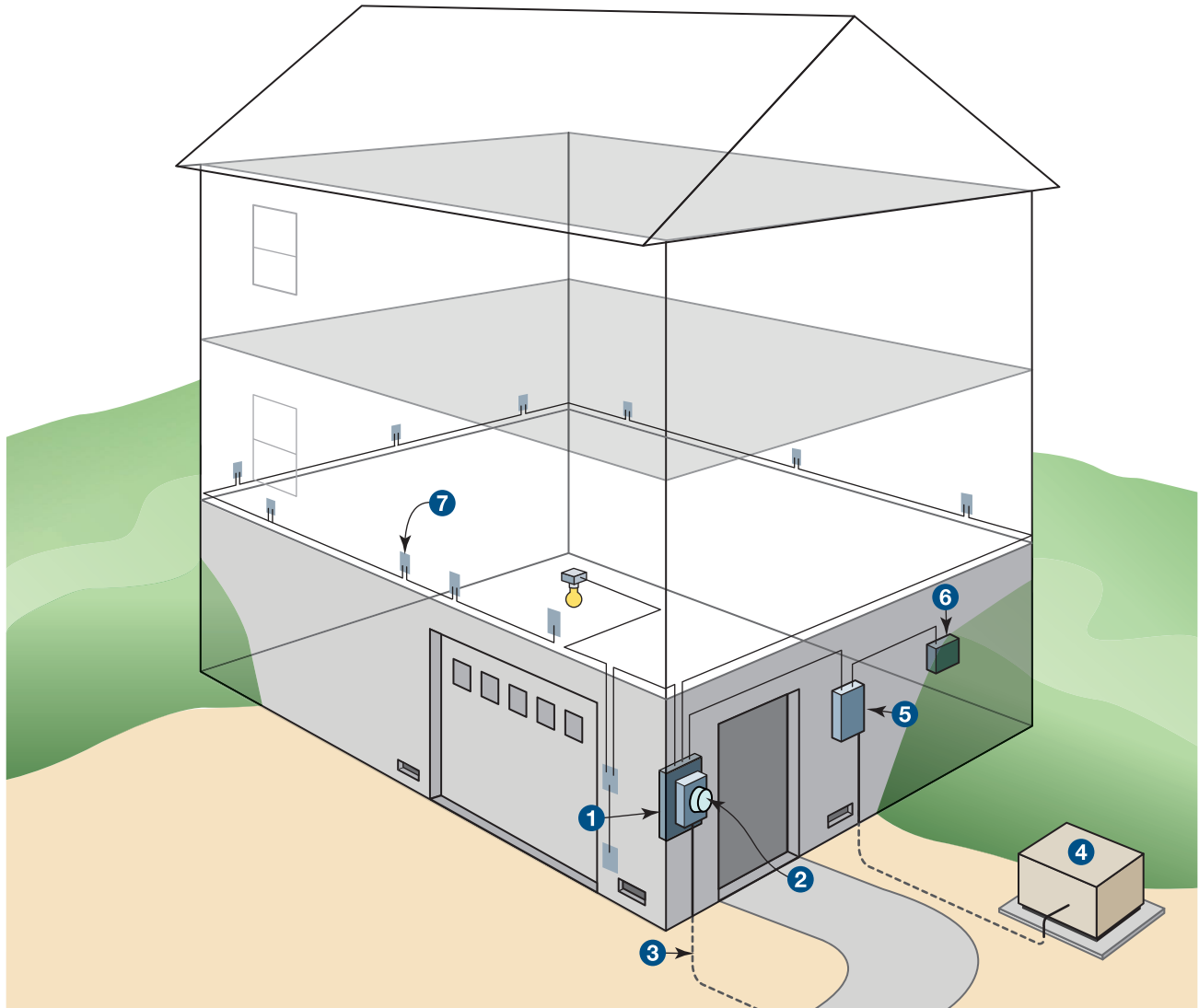

Component	Type
1 Main service panel (N)	Primary
2 Utility meter	Primary
3 Service drop or service lateral	Primary
4 Standby generator	Primary
5 Automatic/manual transfer switch	Primary
6 Normal/standby panel (NE)	Primary
7 Branch circuits	Secondary

Figure 4-11. Typical residential electrical system with an on-site standby generator.

Table 4-3. Typical primary and secondary components of a residential electrical system.

Electrical equipment type (Subsections)	Components
Primary components (4.2.2.1 and 4.2.2.4)	Utility transformer, electrical service drop or service lateral, electrical meter
	Service disconnect and service panel
	Downstream panels (when present)
	Standby generator and ATS or MTS
	Portable generator connection and MTS
	Service lateral and service drop
Secondary components (4.2.2.2 and 4.2.2.3)	Electrical feeders (when present)
	Branch circuits
	Switches, convenience outlets, and light fixtures
	Interconnecting branch-circuit wiring
Information technology (IT) and communications systems: phone, internet, and cable television (CATV)	

4.2.1 Flood Risks to Electrical Systems

Floodwater can damage nearly all electrical system components except those designed for submerged applications. Damage to electrical system components can create fire and electrocution hazards during a flood, extend power outages, and delay the reoccupation of a home after a flood event.

For new construction and Substantially Improved buildings, codes allow electrical devices to be installed below the regulatory flood protection elevation, but only require that electrical devices be suitable for wet locations. Electrical devices suitable for wet locations can still be damaged if submerged in floodwater; therefore, only equipment listed for at least temporary submersion is recommended for use below the flood protection level. The *National Electric Code* (NEC) Table 110.28, Enclosure Selection, lists the degree of protection for various electrical enclosures. Only National Electrical Manufacturers Association (NEMA) Type 6 and 6P enclosures are listed for protection from submersion.

The primary components of an electrical system that may be vulnerable to flood damage include pad-mounted utility transformers, underground electrical service laterals, electrical utility meters, service disconnect or service panels, and standby power equipment like an on-site generator, transfer switch and portable generator connectors. Electrical feeders that connect the primary components are considered primary components. Electrical service drops, which are typically placed more than 10 feet above ground level, are usually not at risk of flooding. Supply equipment placed at lower elevations can be vulnerable to floods.



NOTE

ASCE 24 contains performance criteria requiring that utilities and attendant equipment be elevated above the flood protection elevation but allows equipment to be placed below this elevation if:

- It is protected from flood exposure by component protection (dry floodproofing); or
- It is designed and installed to prevent water from entering or accumulating within the equipment and to resist flood forces.

In practice however, it is difficult to meet these performance criteria, particularly in residential construction. Most electrical components will be damaged when exposed to floodwater and component protection (dry floodproofing) allowed by ASCE 24 in non-residential buildings is not allowed in residential buildings.

Secondary components that are vulnerable to flood damage include all equipment and wiring that are not specifically designed for submerged installations. These include switches, convenience outlets, light fixtures, junction boxes, and interconnecting wiring not suitable for submerged installations.

4.2.2 Mitigation for Electrical Systems

Mitigation actions for electrical systems should focus on primary components; secondary components should be mitigated where practical. Primary and secondary components should be placed as high above the flood protection elevation as possible. Placing as many components as high as possible should be the design goal for all new construction and Substantially Improved residential buildings.

Component relocation is generally the most appropriate mitigation approach for residential electrical systems. This is an option when the residence is not undergoing Substantial Improvement. Component reconfiguration is generally not an option because most primary electrical components cannot be re-configured to allow installation at higher elevations. In-place elevation is an option but NFPA 70 *National Electrical Code* (NEC) contains specific requirements for access to electrical equipment that may limit in-place elevation. Those criteria apply to the service disconnect, service panel, and transfer switches. In-place elevation must satisfy NEC requirements.

If components must be located below the required flood elevation, they should be designed and installed to minimize effects on elements of the electrical system not damaged by floodwater. To accomplish this, wiring and devices installed below the flood protection elevation should be supplied from dedicated branch circuits separate from those that supply equipment above the flood level. Also, for equipment that is vulnerable to floodwater exposure, wiring suitable for submerged applications should be used. As an alternative, wiring that facilitates the replacement of flood-damaged components should be installed. Non-metallic conduit and boxes, installed in a way that allows them to be readily cleaned after a flood and facilitates removal and replacement of flood-damaged conductors, should be considered.

Mitigating secondary components of the electrical system is often most feasible for new construction, but it is also possible when repairing damaged homes. When homes are being renovated in which interior finishes are removed or otherwise exposed, normally concealed portions of the electrical system, including the utility meter, electrical panel, and other main components, can be installed above the required flood elevation. Electrical components that need to be located below the required flood elevation can be constructed using equipment suitable for submerged applications like ground-fault circuit interrupter (GFCI) receptacles, or can be installed in a manner that allows them to be electrically isolated and readily replaced if flooded.

4.2.2.1 Mitigation for Primary Components

Primary electrical system components are generally either the responsibility of the electrical utility or the property owner; therefore, the flood mitigation discussion is directed at whoever is responsible for components. Typically, the utility is responsible for the transformer, the electrical service drop or service lateral, and the electrical meter. The property owner is typically responsible for the service disconnect and service panel, downstream panels and electrical feeders, and all branch circuit wiring and devices. Standby generators or generator connections and ATSS or MTSs are also typically the responsibility of the property owner. The demarcation between utility and property owner responsibility varies between utilities so, the utility company should be contacted to discuss mitigation specifics.

The first primary component of a residential electrical system that is the responsibility of a property owner is the service disconnect, usually located in the home's main service panel. While a specific maximum distance between the meter and the service disconnect is not specified in the NEC, the service disconnect is typically located as close

as possible to the electric meter. This arrangement is intended to minimize the length of service conductors exposed to damage that are only protected from overcurrent devices in the utility system.

When the service disconnect is close to the utility meter and the meter is exposed to flooding, the service disconnect is also exposed to flooding. Preferably, the meter, service disconnect, and main service panel (if separate from the service disconnect) should all be placed above the required flood elevation. When the meter cannot be elevated, one option is to install a combination meter socket and service disconnect. This configuration allows the main service panel equipment to be elevated even if elevating the electric meter is not possible. Figure 4-12 shows an example of a combination meter socket and circuit breaker, which serves as the service disconnect, and depicts a combination meter socket and circuit breaker that allows the main panel to be elevated when the meter cannot be moved.

The service disconnect provides overcurrent protection for downstream equipment, alleviates the minimum distance requirement, and allows the main service panel to be elevated above the meter. Occasionally, the main service panel can be elevated above the meter without installing a combination meter and service disconnect. This can be done by routing the wiring between the meter and the main service panel outside of the home. However, this approach should be discussed with local electrical inspectors and the utility company to confirm if it is a viable option.

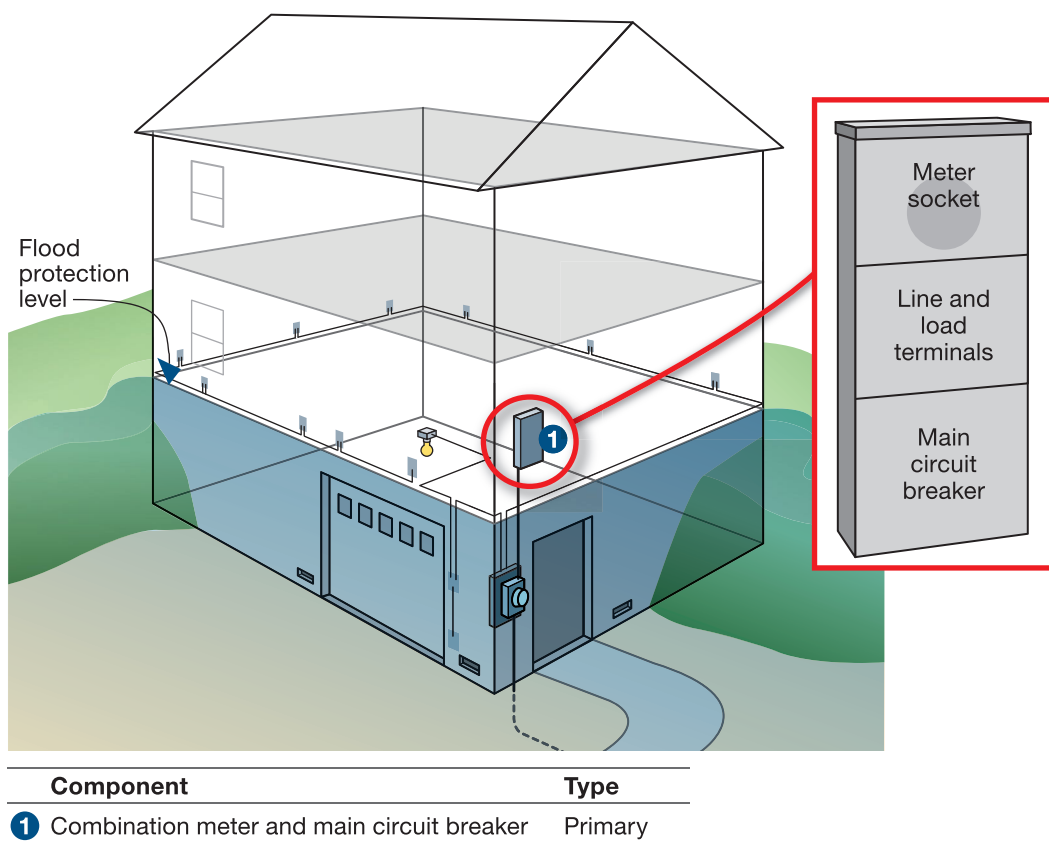

Figure 4-12. Combination meter socket and circuit breaker service disconnect used to allow a main panel to be elevated and protected from flooding when the electrical meter cannot be moved.

If the home has a standby generator, it, along with the transfer switch and normal/emergency panel, should be elevated above the flood protection elevation. The feeder that connects the generator to the electrical system and all control wiring should either be elevated or be suitable for submerged installations. Figure 4-13 shows a home served by an elevated standby generator with an elevated transfer switch and normal/emergency panel.

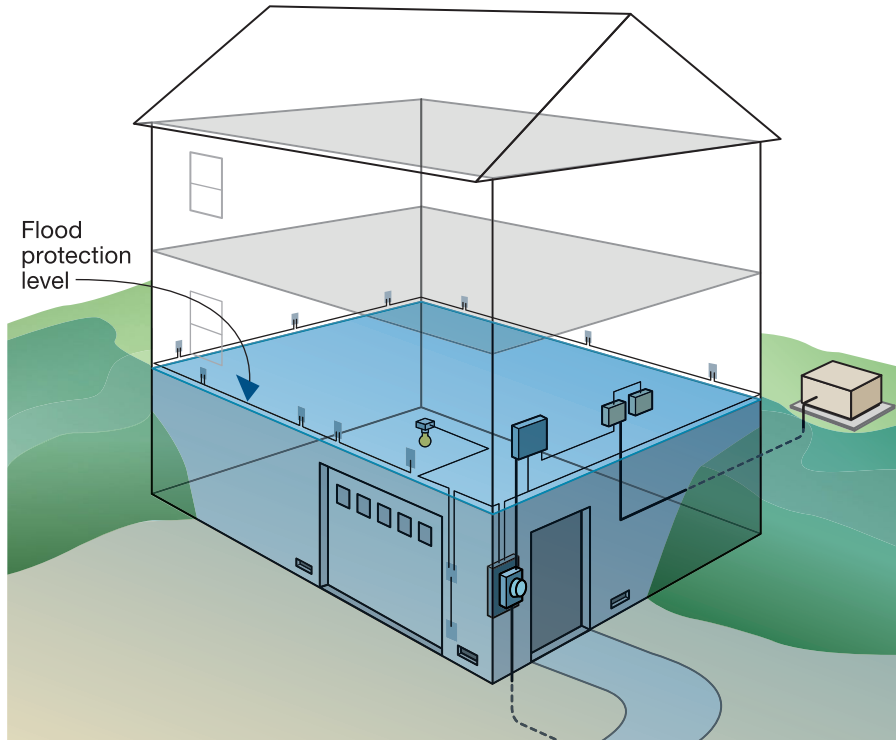

Figure 4-13. Home with elevated standby generator, transfer switch and normal/emergency panel. The utility meter and branch circuits below the flood protection level remain vulnerable to damage.

In homes provided with a flanged connection (often called a quick connect) to connect a temporary generator, the flanged connection should be placed above the required flood elevation in a place that allows the generator to be brought onto the site, quickly connected to the home, and safely refueled. Additionally, the generator should be located away from vents or windows to prevent exhaust gases from entering the home or otherwise pose a risk to occupants. Figure 4-14 shows a flanged connection often used to connect a temporary generator.

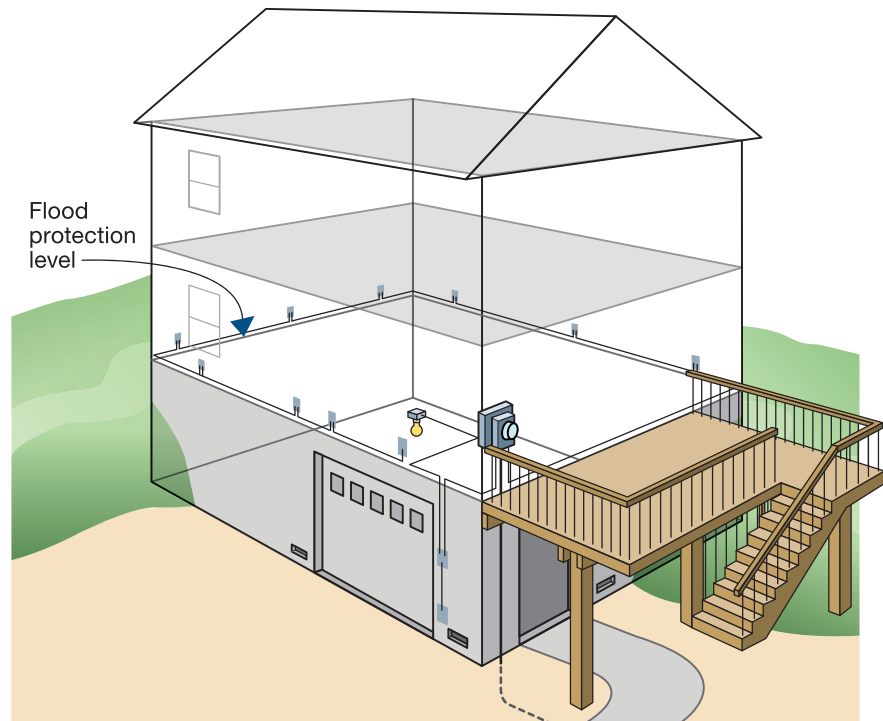

Figure 4-14. Flanged connection (quick connect) for connecting temporary generator (Milford, DE).

The ability to elevate electrical meters is often limited by dependence on the local utility company to enable access for reading the meter and removing it when electrical power needs to be interrupted. Typically meters need to be placed five feet above grade, which often exposes it to flood damage. One mitigation option is to mount electrical meters over elevated decks or platforms so that the meter is above the required flood elevation. Those decks or platforms typically cannot be used only for meter access because single use decks or platforms can fall into disrepair and become a hazard for personnel reading the meters. Owners who are considering elevating their electric meter should contact the local electrical utility to identify and coordinate meter relocation to meet the utility's criteria.

Figure 4-15 shows an example of an elevated deck that allows an electrical meter to be relocated above the required flood level. The dual nature of the deck is conducive to performing adequate maintenance.

Figure 4-15. Deck provides meter access and allows the meter and main service panel to be elevated and protected from flooding. Electrical components placed below the flood protection level remain vulnerable to flood damage.



Component Protection (Dry floodproofing): Dry floodproofing can be considered as an interim mitigation option for electrical system components in existing homes that are not Substantially Improved. Dry floodproofing will not lead to full compliance with building codes, standards or the NFIP.

4.2.2.2 Mitigation of Secondary Components

As with the primary components of an electrical system, the preferred approach to mitigate secondary components is to place as many as possible above the required flood elevation. For new construction and Substantial Improvement to residences where interior finishes are typically removed to create access for installing secondary components, this approach is almost always feasible. For existing homes that are not undergoing Substantial Improvement, many electrical components can be elevated or relocated.

Electrical devices and wiring should be located above the required flood elevation. In cases where they must be placed below this elevation and exposed to floodwater, they should be suitable for submerged locations. However,

ASCE 24 and the IRC allow wiring suitable for wet locations. Wiring suitable for wet locations is less restrictive and more prone to flood damage than wiring suitable for submerged locations.

The number of required devices (receptacles, switches, lights, and other components) placed below the required flood elevation should be minimized. Those components should be supplied from separate branch circuits protected by GFCI breakers. In addition, these breakers should be clearly marked so that they can be disconnected in the event of flooding. Installing wiring in a non-metallic conduit that can readily be cleaned after a flood event can facilitate recovery. Conductors that could sustain damage can be removed and replaced more readily if they are installed in a conduit. Alternatively, junction boxes can be installed in branch circuits that allow damaged wiring below the junction box to be readily removed and replaced. Junction boxes should be placed above the required flood elevation.

In addition, all wiring and components that could potentially be exposed to flooding should be designed and installed to accelerate repair or replacement after a flood event. When elements of branch circuits are located below the required flood elevation, they should be designed to be electrically isolated from the rest of the system. Such isolation will allow for power restoration before flood-related electrical repairs are completed.

Figure 4-16 shows a home where flood mitigation has been completed on several primary and secondary electrical system components. Electrical devices in the basement and wiring to those devices have been elevated as high as possible. If devices cannot be elevated (e.g., a sump pump to control leakage into the basement), they are supplied by separate branch circuits and a junction box has been installed to facilitate the replacement of damaged wiring.

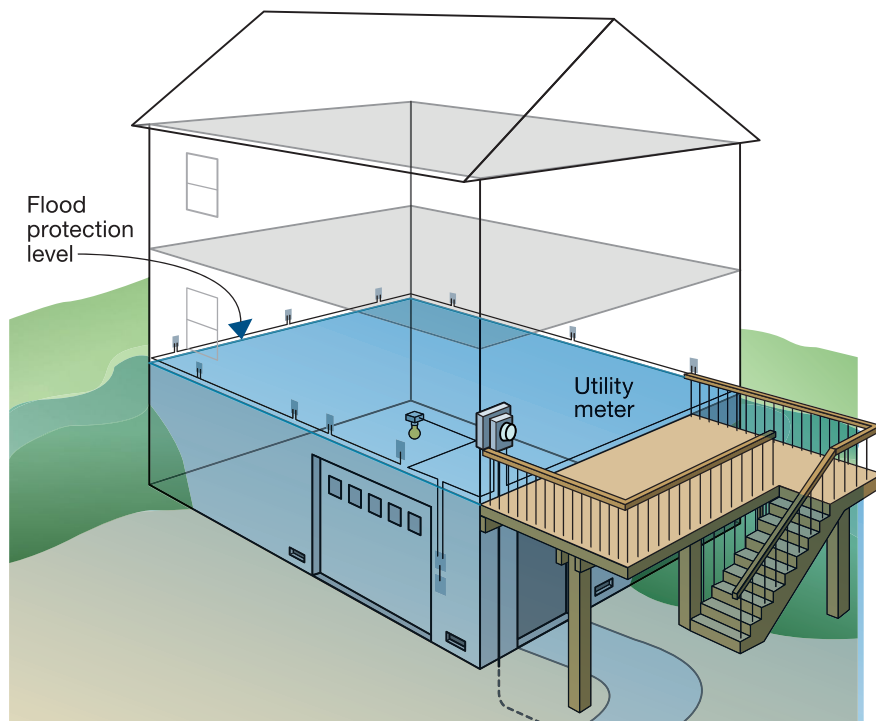

Figure 4-16. Elevating electrical components and routing wiring above the flood protection level protects several primary and secondary electrical components from flood damage.

4.2.2.3 Mitigation of Miscellaneous Electrical Systems

IT and communications systems such as phone, internet, and cable television (CATV) components should be protected from flooding using methods similar to those of other electrical system components. Primary components like modems, video switches, splitters, and routers should be elevated. Secondary components like outlets and wiring should also be elevated. If outlets must be placed in areas exposed to flooding, the number of outlets should be minimal. GFCIs should be used and electrically isolated from the rest of the system.

4.2.2.4 Other Mitigation Considerations for Electrical Systems

In areas where moving floodwater is anticipated, electrical equipment that cannot be elevated should be installed to reduce the potential for physical damage. In coastal areas, electrical equipment should not be installed on walls designed to break away when exposed to flood loads. Equipment installed below the flood elevation should be routed along the landward side of structural members in coastal areas or along the downstream side in riverine areas. Figure 4-17 depicts electrical equipment routed in that fashion.

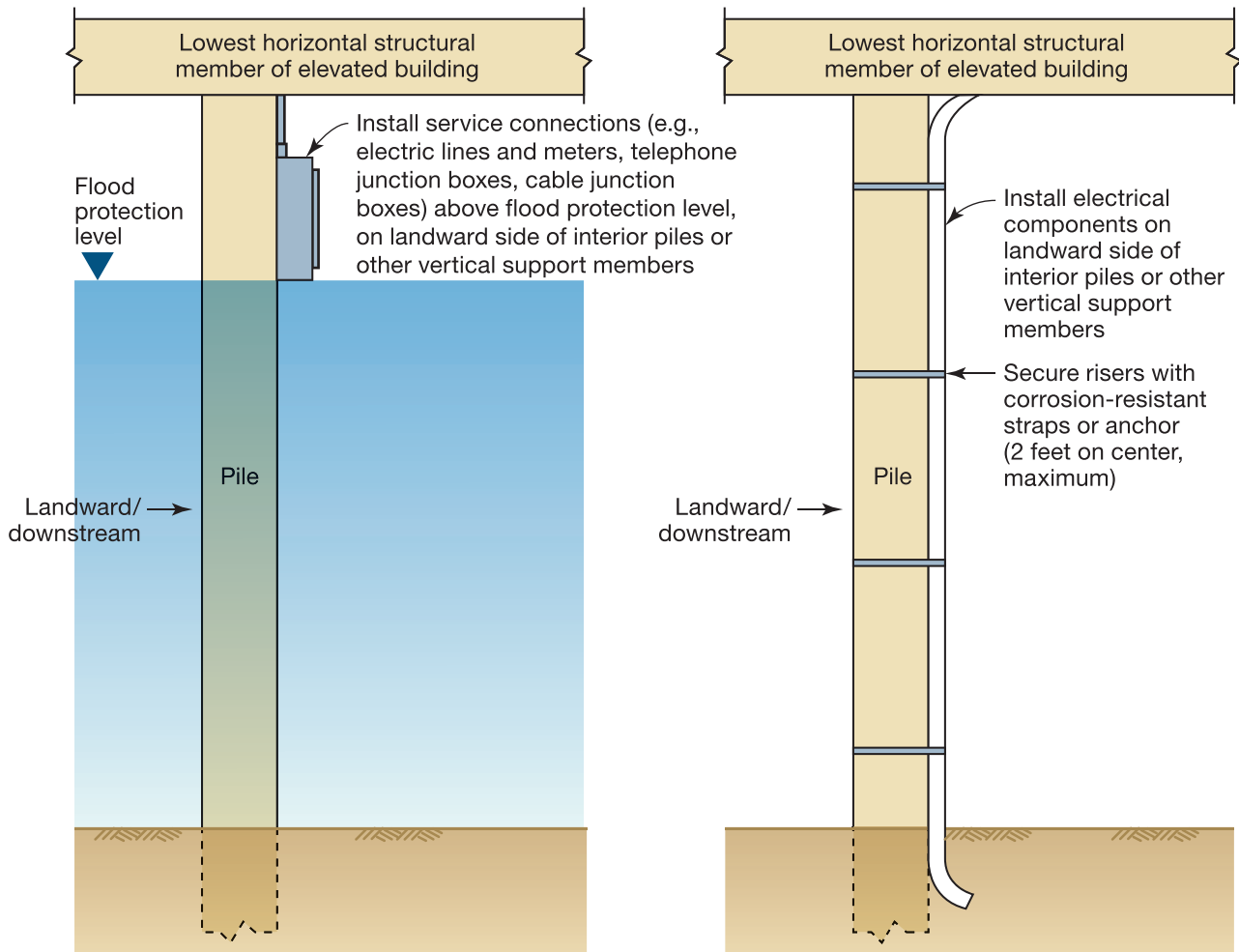

Figure 4-17. Placing electrical components to reduce risk from moving floodwater.

4.3 Plumbing Systems

Residential plumbing systems include domestic water and drain, waste, and vent (DWV) systems. They can also include sprinkler systems and fuel oil systems.

Domestic water systems distribute potable water to a residence from a private well or municipal water utility. DWV systems convey waste from a residence to a municipal wastewater utility or a private on-site waste system. These systems must be operable to allow occupation of residences so residential flood resiliency can be improved by flood mitigation. A typical residential plumbing system configuration for a home supplied from a municipal water system is shown in Figure 4-18, and for a home supplied from a private well in Figure 4-19.

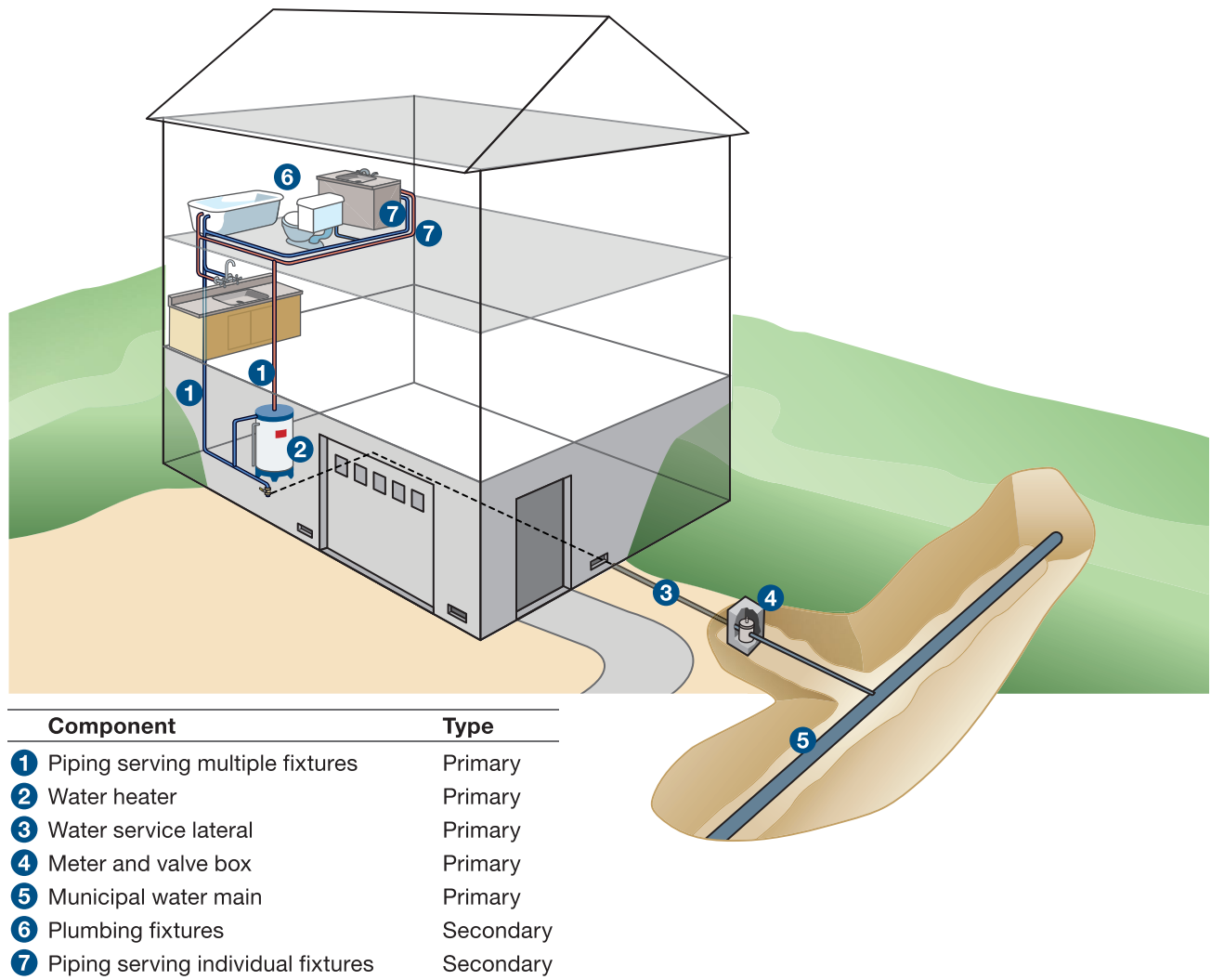
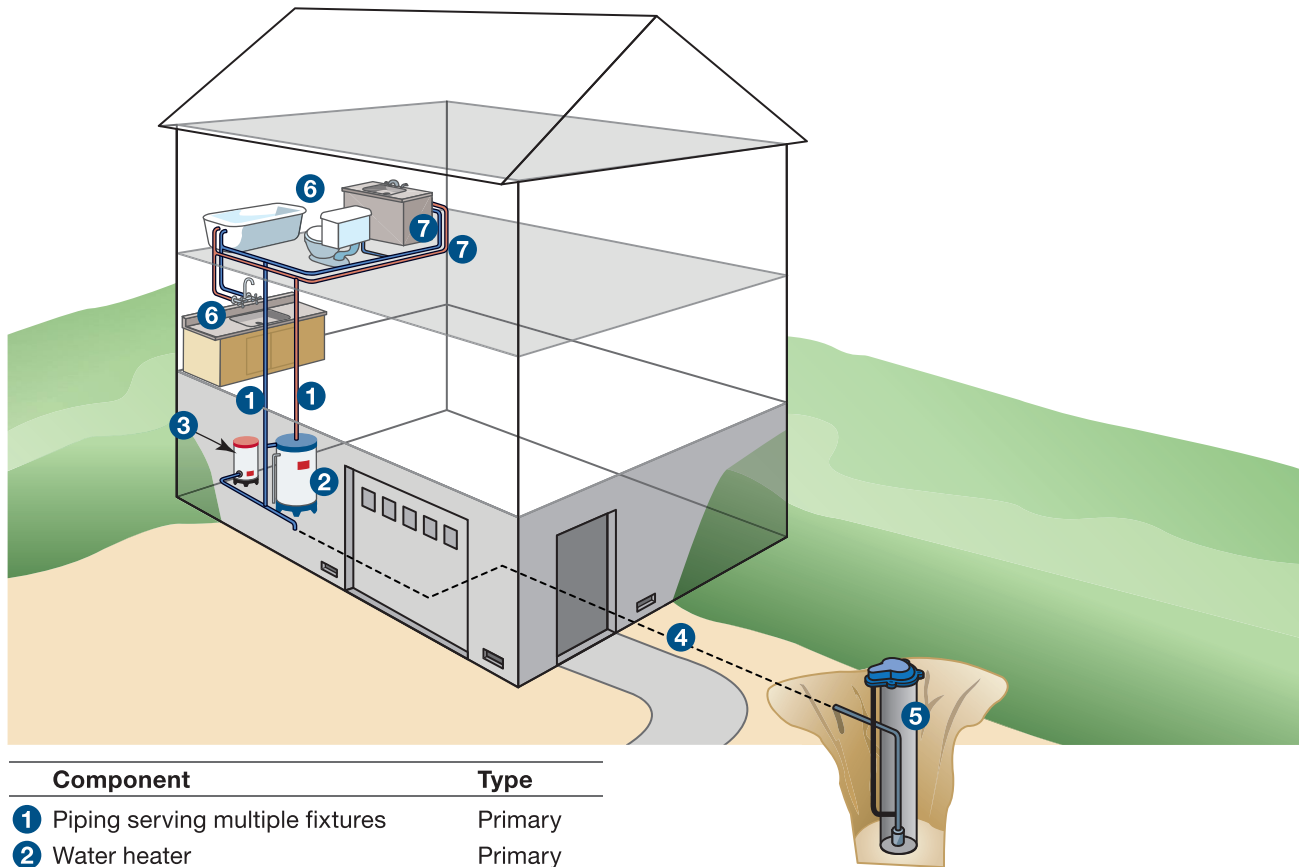

Figure 4-18. Typical residential plumbing system configuration for a home served by a municipal domestic water system.



Component	Type
1 Piping serving multiple fixtures	Primary
2 Water heater	Primary
3 Pressure tank	Primary
4 Well service pipe	Primary
5 On site water well	Primary
6 Plumbing fixtures	Secondary
7 Piping serving individual fixtures	Secondary

Figure 4-19. Components of an on-site potable water system supplied by a well.

For typical DWV systems, Figure 4-20 depicts a home that discharges waste to a municipal sanitary sewer line. Figure 4-21 shows a home that discharges waste to an onsite waste disposal (septic) system.

Residential plumbing systems are composed of primary and secondary components, but there are relatively few primary components. One primary component is the domestic water heater that exists in most residences. Water heaters may be either separate units or components of HVAC equipment. If the water heater is a component of the HVAC system, it is typically a heat exchanger in the boiler that heats a home. In tall residential buildings, domestic water booster pumps are often installed to provide sufficient water pressure on upper floors. Booster pumps are needed in these buildings because static water pressure drops approximately 4 psi for each story of building height. Sewer lift pumps are needed for DWV systems that discharge into forced sanitary sewer mains or sanitary sewer systems that are higher than the elevation of the sanitary sewer pipe exiting the building.

In homes supplied by private wells, pumps deliver water from the well to the home. Well pump types include submersible pumps and jet pumps. Submersible pumps are submersed in the well, typically a few feet above the bottom of a dug well (10 feet or more above the bottom of a deep, drilled well). Jet pumps are typically located

in the home or in an enclosure near grade. Submersible and jet pumps both feature pressure tanks that provide pressurized water storage. They also reduce the on- and off-cycling of well pumps, thus lengthening the life of the pump. Tanks contain a pressure switch that senses pressure in the water system and controls the pump to maintain pressure in a specified range, typically between 30 and 50 psi.

Water treatment systems are also present in many homes, particularly those supplied by private wells. Water treatments systems in homes supplied by municipal water systems are generally less prevalent because water quality is controlled at the water treatment plant. Domestic water treatment systems include filters, water softening equipment, aeration equipment, and reverse osmosis equipment.

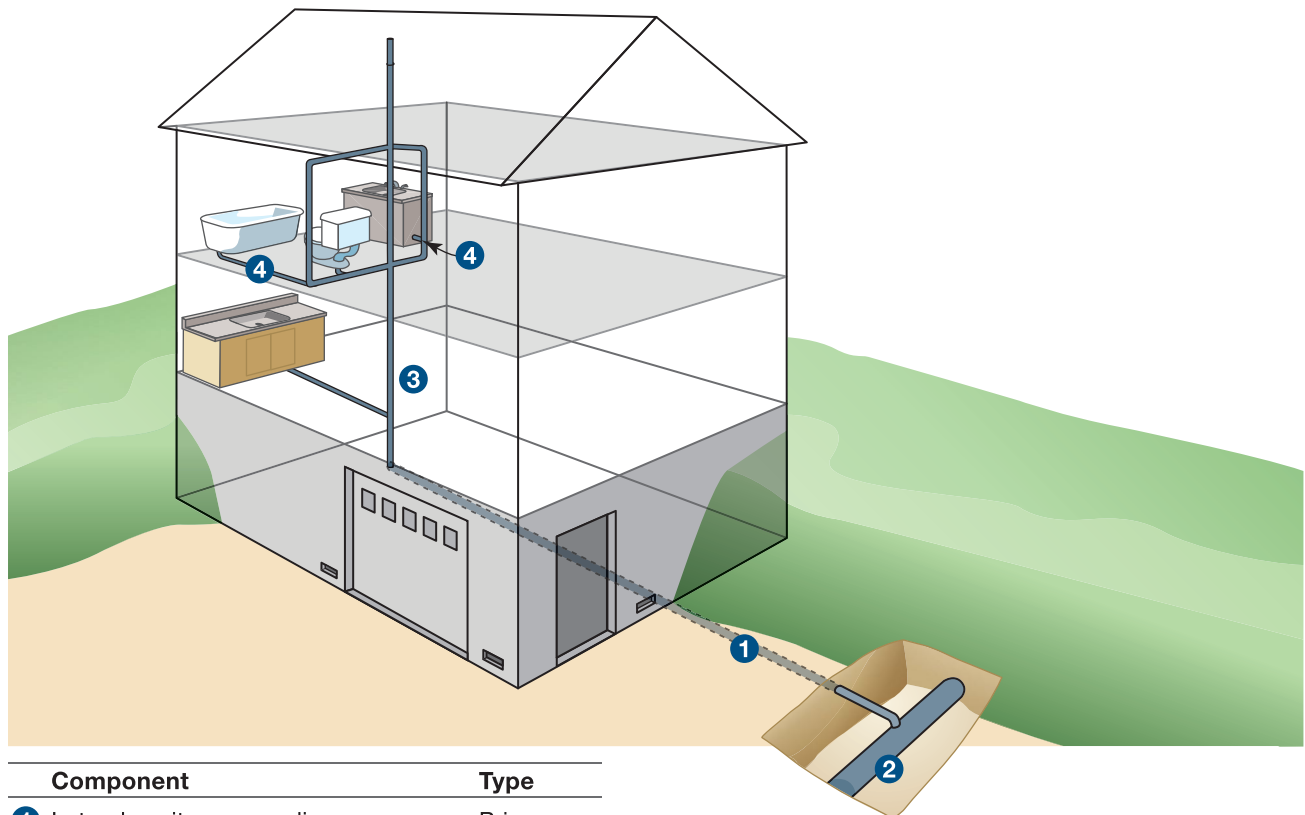

Component	Type
1 Lateral sanitary sewer line	Primary
2 Municipal sanitary sewer main	Primary
3 Drain/Waste/Vent piping serving multiple fixtures	Primary
4 Drain/Waste/Vent piping serving individual fixtures	Secondary

Figure 4-20. DWV system that discharges into a municipal sanitary sewer line.

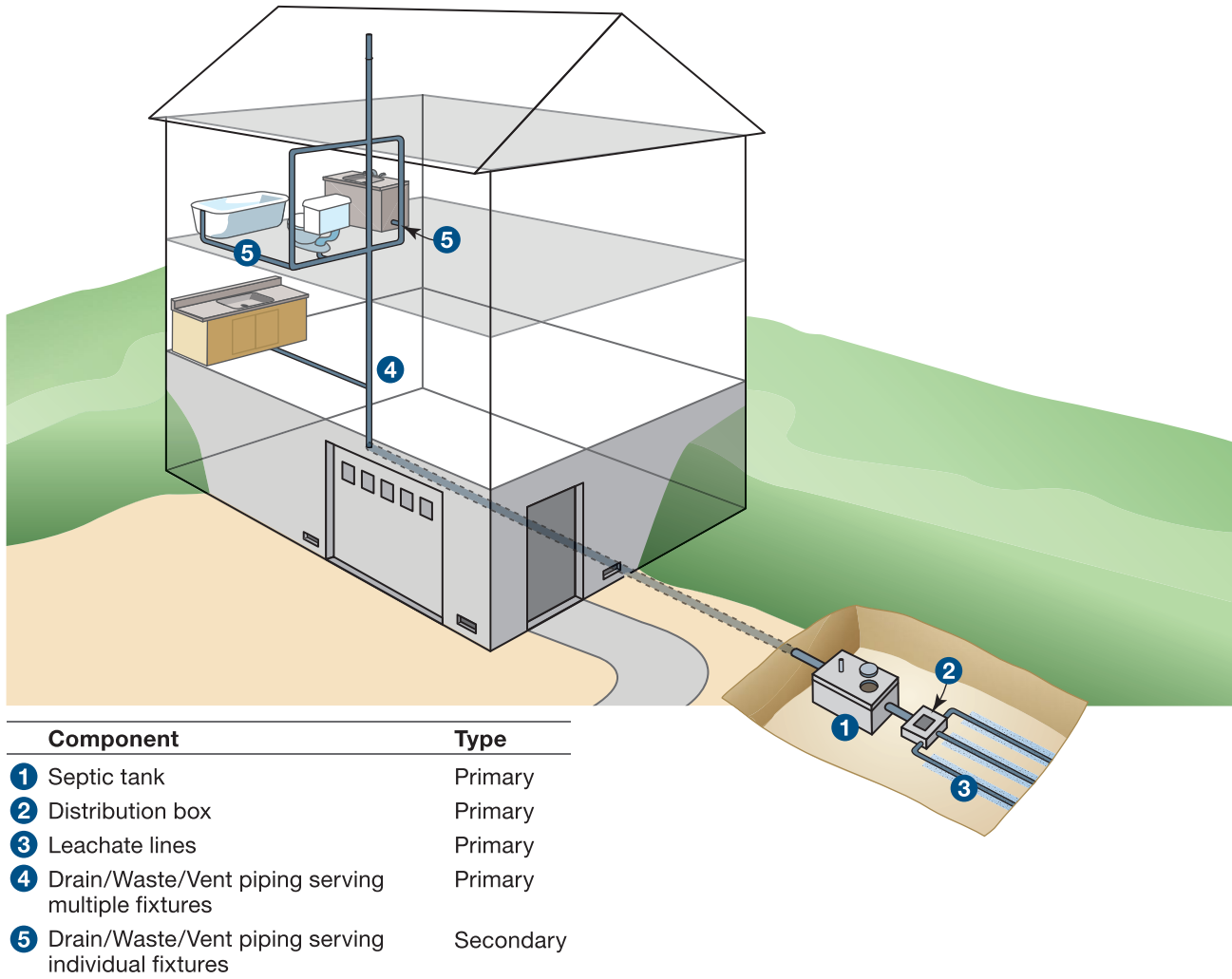

Figure 4-21. DWV system that discharges into an onsite waste disposal (septic) system.

Table 4-4 lists the typical elements in a residence and the subsections where mitigation options are discussed.

Table 4-4. Typical elements of residential plumbing systems.

Plumbing equipment type (Subsection)	Components
Primary plumbing components (4.3.2)	Water heaters, booster pumps, pressure tanks, well pumps, pressure switches
	Water treatment equipment
	DWV Lift pump (when present)
	Main sections of DWV piping and fittings
Secondary plumbing components (4.3.2)	Water piping, valves, and fittings
	Water fixtures
	Lateral sections of DWV piping and fittings
Primary components - Fire protection systems (4.3.3)	Residential sprinkler systems
Secondary components - Pools and spas (4.3.4)	Pumps and associated equipment

4.3.1 Flood Risks to Plumbing Systems

Floodwater affects domestic water and DWV systems differently. The greatest risk to domestic water systems is saturation of the pipe insulation often used in sections of a domestic water system. Corrosion is common in piping, components, and fittings exposed to floodwater. Flooding can also contaminate water in domestic piping systems, but that risk is greatest for the portion of piping outside of the home. Domestic water pipes inside the home are usually watertight, so contamination in the home is much less of a risk. Contamination risk is greatest when water pressure is lost and floodwater or groundwater seeps into piping from joints in the municipal water system that are not watertight. For that reason, water suppliers routinely issue “boil-water” orders following events where system pressure is lost. In the case of private wells, contamination can enter a domestic water system if floodwater extends above the well head or seeps into the well casing when watertight well caps are not used.

In areas of standing water flooding, the greatest risk associated with DWV piping occurs when the DWV piping acts as a conduit allowing floodwater to flow into a home. This risk is greatest to homes with basements that are below grade on all sides, where the DWV piping can be the lowest point of entry for floodwater.

Flood risks vary when those systems are exposed to moving floodwater, as is the case with elevated homes constructed on open foundations in coastal or riverine areas. In those instances, velocity flow, flood-borne debris impact, and breaking waves can physically damage vertical piping located between grade (below which they are protected by soils) and the point where pipes enter the home (where they are protected above the entry point by the building envelope). In addition, erosion and localized scour can uncover buried pipes, exposing them to damaging flood currents. Erosion and scour are common in coastal areas, but can also occur in riverine floodplains. Well heads that typically extend above grade one to two feet can also be damaged by moving floodwater.



NOTE

Because most wastewater systems rely on gravity flow, sewage backup can occur even if the building does not flood. Flooded sanitary systems may prevent wastewater from draining and cause backflow into buildings if proper mitigation techniques have not been applied.

Flood risks to primary components of residential plumbing systems are similar to the risks posed to primary components of HVAC equipment. Floodwater contact with domestic water heaters, non-submersible domestic water booster pumps, and water treatment equipment can damage electrical components, gas burners, and safety equipment in those devices and render them inoperative. Corrosion from contact with floodwater can damage equipment after floodwater recedes. Sanitary lift pumps are usually designed for submerged operation with the ability to handle chemically reactive fluids, so they offer some inherent resistance to flood damage. However, electrical controls for sanitary sewer lift pumps can be damaged or destroyed by floodwater unless they are located in enclosures suitable for submerged conditions.

4.3.2 Mitigation for Plumbing Systems

Flood mitigation approaches for residential plumbing systems are similar to those for HVAC and electrical systems. Plumbing components should be elevated as high as possible, preferably above the required flood elevation.

Primary components can be elevated in-place or, if space is available, moved to a higher floor. Component reconfiguration may facilitate the elevation of some primary plumbing system components. For example, replacing a standard-height water heater with a *lowboy* model, which can be 12 to 16 inches shorter, may allow a water heater to be elevated in place. Some primary components, like fuel-fired water heaters, are more difficult to relocate because they require venting for combustion gases, which may not be feasible on higher floors. Relocating an

electric water heater to a higher floor can be easier because venting is not necessary. Upper floors are usually finished for living space; therefore, when relocating primary components of a plumbing system, pans with suitable drain piping should be installed below the relocated units to collect and dispose of any water that may result from the operation of the plumbing system or failure of the relocated component. Figure 4-22 depicts an example of mitigation of primary plumbing components.

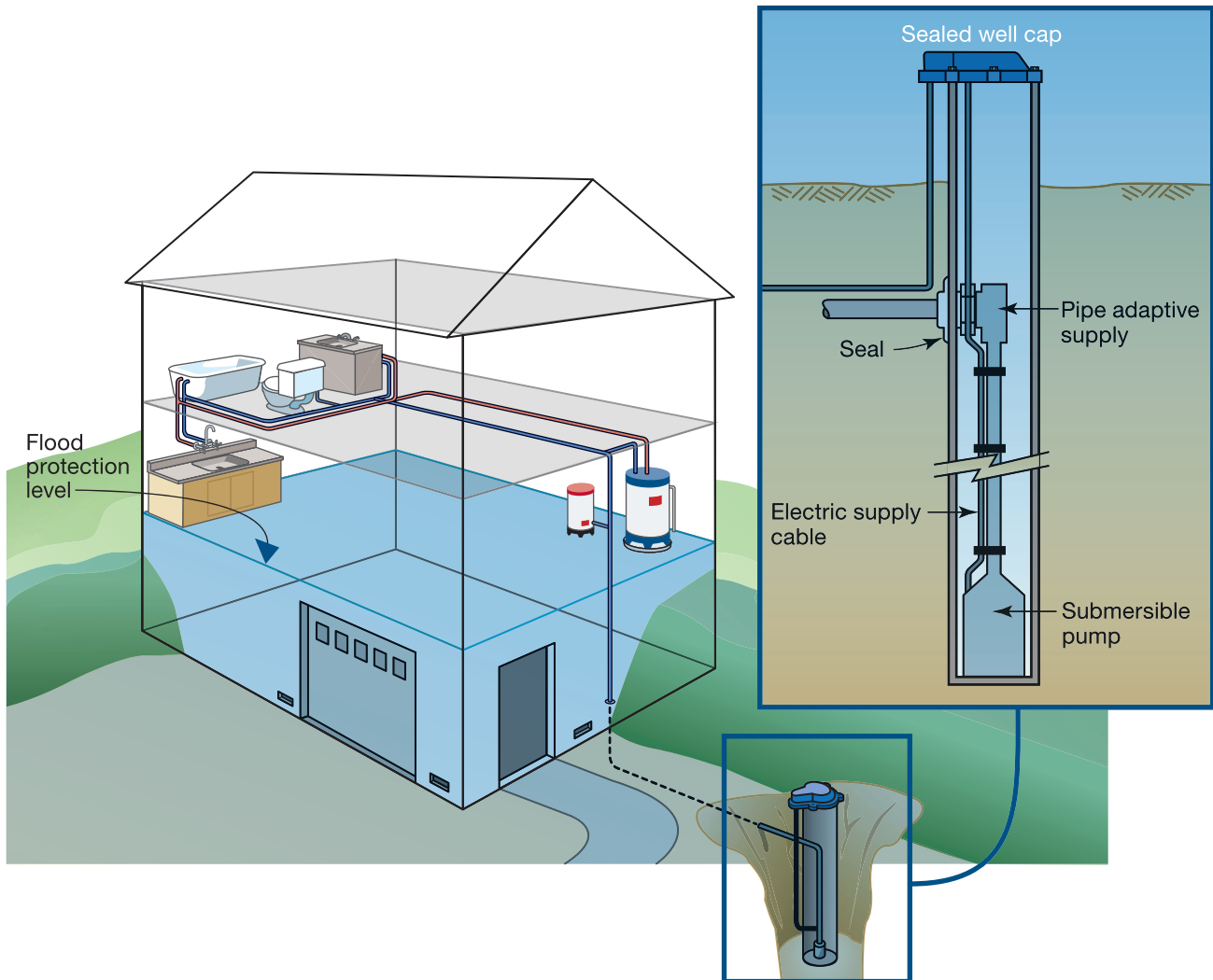

Figure 4-22. Relocation of a primary plumbing system components to an upper floor.

It may not be necessary to protect primary components like water treatment devices that improve water quality but whose operation is not essential to producing potable water. If these components are not protected, bypass valves should be installed to isolate them from the domestic water system in case they incur damage from floodwater.

For existing homes that are not Substantially Improved, primary components located in areas vulnerable to flooding can be mitigated by dry floodproofing. To maintain the effectiveness of dry floodproofing, sump pumps fed from reliable electrical supplies should be installed in the protected area, unless seepage through the flood barriers can be eliminated (for long-duration flooding) or controlled sufficiently (for short-duration flooding).

When plumbing components need to be placed below the required flood elevation, they should be (and, in newly constructed and Substantially Improved homes, must be) designed to resist flood forces and prevent floodwater entry and accumulation. They also must be designed and installed to resist flood loads.

In elevated homes constructed over open style foundations, vertical sections of domestic water and DWV piping can be exposed to moving floodwater, flood borne debris, and, in coastal areas, breaking waves. Installing this piping along vertical structural elements, preferably on the landward side in coastal areas or the downstream side in riverine areas, can help protect them from damage. Alternatively, piping can be placed in a vertical chase if the chase is designed to resist flood forces. In cold climates, chases are typically insulated to provide freeze protection. Well casings that extend above grade can also be exposed to damage from moving floodwater. Steel casings are less prone to damage than polyvinyl chloride (PVC) casing and should be used in areas exposed to moving floodwater.

Sewage can back up into a house in one or a combination of the following scenarios:

- Floodwater infiltrates the sewer system by entering through unsealed manholes, pipe connections, and line breaks, thus surcharging the sewer.
- Combined systems that collect both sewage and stormwater can be overloaded and surcharged following heavy or prolonged rains. Surcharged or overloaded lines can back up into houses connected to that combined system.
- Municipal sewage pump station failure can cause sewage to back up into a house.

The risk of floodwater entering a home through DWV piping can be reduced by installing backflow valves. These devices, referred to as *backwater valves* in the IPC and IRC, can help prevent wastewater backup in a house when the municipal sanitary sewer lines are surcharged or overwhelmed, or when floodwater flows into an onsite waste disposal system.

Backflow valves should be installed in the sanitary sewer lateral. Preferably, the backflow valves should be installed outside of the home before the lateral enters the basement or crawlspace. The backflow valve may be installed inside the home if the outside location prevents access for testing and maintenance, or when installing the device outside is impractical.

There are several types of backflow prevention valves, including check valves, gate valves, and ball float valves. Some are suitable for use in DWV piping, while others are suitable for other plumbing systems like foundation and floor drain systems.

- **Check Valves:** Check valves allow one-direction flow. Flow from the opposite direction automatically shuts the valve. A check valve in the sewer service connection pipe allows sewage to flow out of the collection system and into the public sewer or onsite treatment system during non-flood conditions while preventing it from flowing back into the house during flood conditions. The valve generally has corrosion-resistant internal parts and a cast-iron body with a removable cover for access. Valves are available in sizes from 2 to 8 inches in diameter. A disadvantage of check valves is that they are susceptible to debris blockage. Periodic maintenance and testing is required to maintain functionality.



NOTE

ASCE 24, Section 7.3, Sanitary Plumbing Systems states:

- Any openings below the required elevation should be protected with automatic backwater valves or backflow devices.
- Redundant backflow devices requiring human intervention are permitted.
- Sanitary system vent openings should be elevated.

The I-Codes contain criteria on the installation of backwater valves that may dictate where they can be used.

- **Gate Valves:** Gate valves allow flow in both directions. Gate valves must be operated manually or electronically, and are less susceptible to debris and blockage than check valves. When open, a gate valve allows flow in either direction; when closed, a gate valve prevents flow in both directions.
- **Shear Gate:** Some manufacturers add a shear gate mechanism that is manually operated to close the drain line when backflow conditions are anticipated. The valve remains open during normal use.
- **Ball Float Check Valve:** A ball float check valve can be installed on the bottom of outlet floor drains to prevent water from flowing up through the drain. This type of valve is often built into floor drains or traps in new construction (see Figure 4-23).

Figure 4-23. Floor drain with ball float check valve.

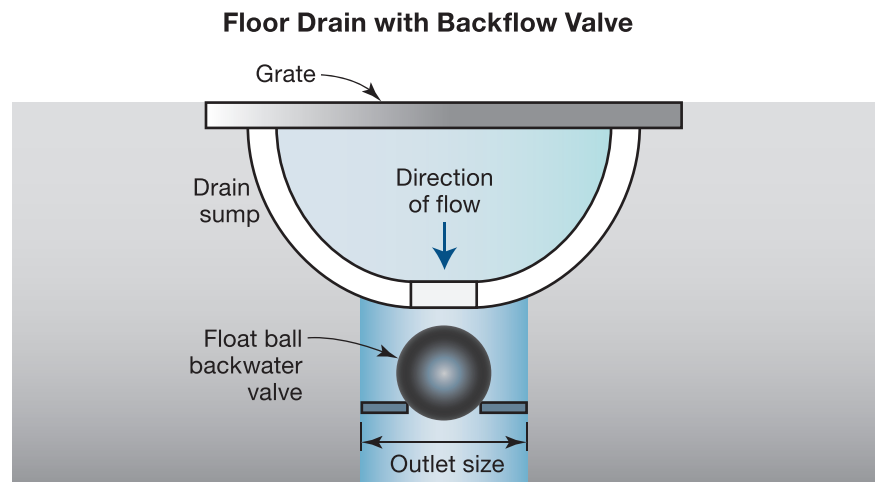

Although manually operated valves are available, it is recommended that homeowners consider automatic valves. Backflow through sewage pipes may result from a backup some distance away from the house and occur with little or no notice, so manual valves may not be as convenient. Manual valves can be installed to augment automatic valves, but if they are used, manually operated backflow valves should be closed well before flooding is expected.

For the best protection against sewage backup, a combination of a check valve and a gate valve should be installed, as shown in Figure 4-24. The operation of a check valve can be impaired by the accumulation of debris at the valve opening, while a gate valve is less likely to be affected by debris. With these two valves in use, backed-up sewage would shut the check valve automatically. Then, closing the gate valve either manually or electrically can seal the pipe.

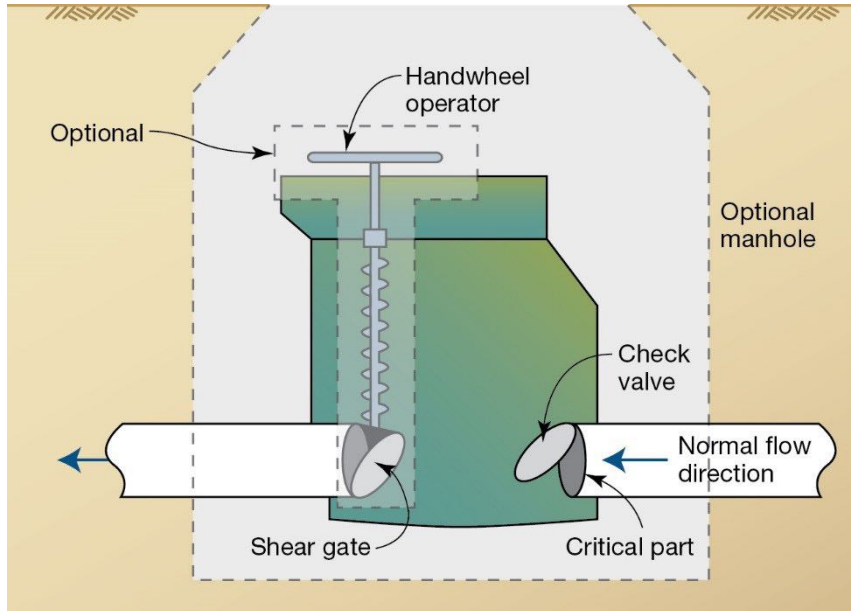

Figure 4-24. Combination gate and check valve.

4.3.2.1 Mitigation for Private Wells

The risk of private well water contamination can be reduced by sealing the portion of the well exposed to floodwater. For drilled wells sleeved with casings, pre-manufactured sanitary well caps can be used as shown in Figure 4-25.

For dug wells constructed with pre-cast concrete casings, gaskets may be available to help seal individual riser sections and to seal the concrete cap to the top riser. For existing wells, it is impractical to add seals for all casing sections. However, gaskets can usually be added to seal the cap to uppermost casing section (see Figure 4-26).

Sealing the portions of wells exposed to floodwater will help prevent floodwater from entering and contaminating drinking water wells. While they reduce the potential for contamination, however, gaskets will not fully eliminate contamination risk. After floodwater recedes, all lines from private wells should be flushed and the well water should be tested. If it is found to be contaminated with harmful bacteria, the well must be disinfected.

If wells are in areas that can experience moving floodwater, mitigation actions should be taken in conjunction with steps to prevent floodwater from contaminating well water. When new drilled wells are installed in areas that can be exposed to moving floodwater, steel casings should be used because they are less prone to damage from debris impact and hydrodynamic loads. For existing wells exposed to moving floodwater, other protective devices like flood- and impact-resistant devices constructed around exposed portions of the well should be considered.

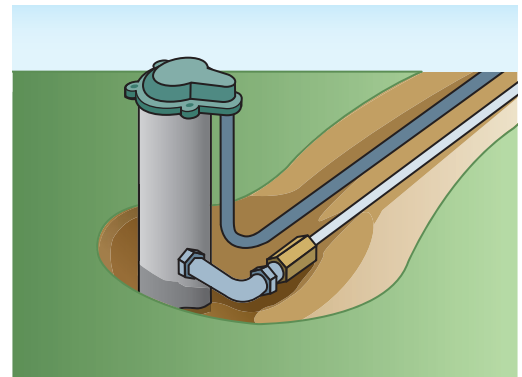

Figure 4-25. Sanitary well cap.

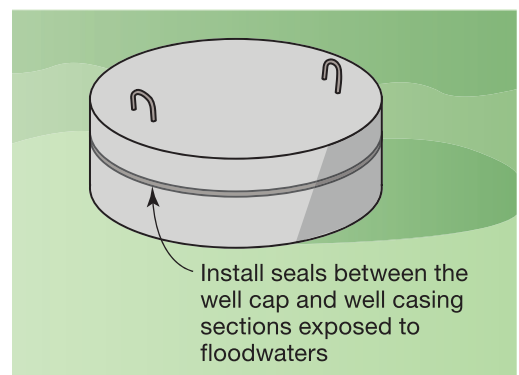

Figure 4-26. Concrete well cap and the uppermost section of concrete casing.

4.3.2.2 Mitigation for Onsite Waste Disposal Systems

Wastewater generated from a residence discharges either to a municipal waste disposal system or to an on-site waste disposal system. On-site private waste disposal systems, called septic systems, typically consist of one or more septic tanks that receive solid waste and effluent from the home. In a properly operating onsite waste disposal system, solids remain in the septic tank where aerobic bacteria break them down. Carbon dioxide and water are typical byproducts of this biological process. Effluent exits the tank where it flows into a drainage field, also called a leach field. The effluent seeps into the ground from the leach fields. Some effluent will evaporate from the leach field. Pumped systems are used when the relative elevation between the tank and the leach field does not allow gravity to convey the liquid effluent. Leach fields generally require layers of well-draining soils above the groundwater table to handle the anticipated volume of effluent.



NOTE

Property owners or contractors should contact local health departments for guidance on residential waste water treatment systems that meet NFIP and health department regulations.

During flood events, floodwater can enter septic tanks through drain field piping, which is perforated to allow leachate to exit the piping, and eventually flow into a home through the DWV piping. Floodwater can also enter septic tanks through piping connections and covers used to inspect and pump septic tanks. For gravity-fed systems where the leach field is lower than the tank, leach fields will be inundated before floodwater reaches the tank. Sealing the tanks may reduce intrusion from runoff, rainwater and perched water tables but is generally not an effective method for reducing floodwater intrusion. If the tank of a pumped effluent system is below the leach field, floodwater will reach the tank before the leach field. In those instances, sealing tank openings can be effective at reducing floodwater intrusion.

The following techniques can reduce floodwater entry by making septic tank penetrations more watertight:

- **Wall penetrations:** Pipe penetrations through an external wall can be sealed using an expansive sealant, a molded sleeve, an elastomeric seal, or a neoprene seal. Seals are typically manufactured with septic tanks.
- **Septic tank access covers:** Neoprene gaskets can be installed between the access covers and their seats in the tank (see Figure 4-27). This combination will reduce infiltration.
- **Access risers:** Access risers are often installed above septic tank access points to reduce the amount of soil needed to be removed to pump or inspect tanks. Because risers intentionally reduce soil cover over portions of the tank, they are not recommended in areas that are vulnerable to velocity-flow flooding, such as Zones V and Coastal A Zones and riverine areas near floodways. If the top of the riser is exposed by erosion, obstructions to flood flow can occur, causing localized scour. Scour and erosion can expose the tank and associated piping, leading to system damage and contamination.

While sealing a septic tank is a desirable method to reduce the potential entry of floodwater into the tank and eventually into a home, it can increase buoyant forces if the tank is submerged in floodwater. During flooding, sealed septic tanks will be exposed to greater buoyant forces than a tank that is allowed to flood. To resist buoyancy, septic tanks placed in SFHAs should be anchored to resist flood forces. ASCE 24 requires that tanks exposed to flooding be designed to resist 150 percent of the flood loads to which they are exposed. The weight of the fluids in a tank are not included in buoyancy resistance load calculations.

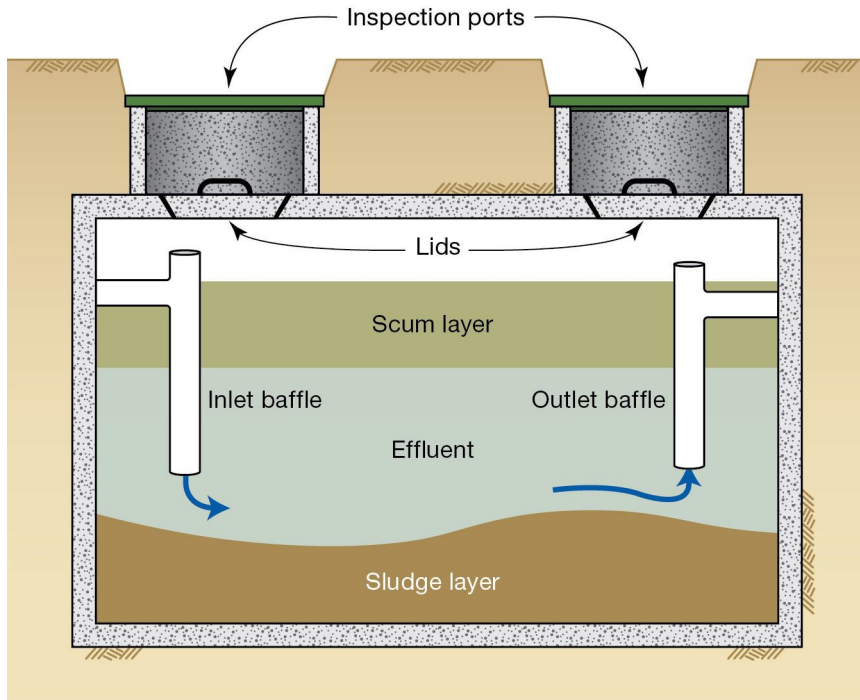

Figure 4-27. Septic tank with lids and gasketed access covers, concrete risers, and riser caps.

4.3.3 Mitigation for Fire Protection Systems

The 2009 IRC (and later editions) specify sprinkler systems for one- and two- family dwellings and townhouses. While not all states or jurisdictions may have adopted this requirement, many require fire protection systems in new residential construction. When considering new construction, property owners, designers, and contractors should check with local building code administrators to clarify local fire code protection requirements.

There are two categories of residential sprinkler systems: stand-alone systems that use an individual set of pipes independent of the normal water plumbing, and multi-use sprinkler systems that are integrated with the home plumbing system. Selection of a stand-alone or multi-use system may be influenced by whether the house has a well. For houses with well-supplied water systems, sprinkler systems often use larger storage tanks than those needed to supply typical plumbing fixtures.

Storage tanks exposed to flooding should be properly protected and anchored as described in Section 4.4. Otherwise, components for both stand-alone and multi-use sprinkler systems should be protected from flood damage in a similar fashion to other plumbing systems in the house. Components exposed to flooding should be minimized, and those components that must be placed below the required flood elevation should be designed to resist flood forces and prevent water intrusion and accumulation. Sprinkler heads installed below the required flood elevation may be subject to damage during a flood event. All sprinkler heads submerged during a flood should be replaced following the event.



NOTE

Refer to Section 5.3.4 of this guide for additional details on fire protection systems. Building codes usually require fire walls in non-residential and multi-family residential occupancy buildings.



WARNING

Sprinkler pumps should be provided with adequate backup power located above the required flood elevation.

4.3.4 Mitigation for Pools and Spas

The material presented in this section focuses on the equipment needed to operate pools and spas, not on the operation of pools and spas. Several codes and standards govern the construction of pools and spas, many of which contain additional criteria for pools and spas placed in Special Flood Hazard Areas. Codes, standards and guides that relate to pools and spas include: The ICC's 2015 *Swimming Pool and Spa Code*, ASCE 24 *Flood Resistant Design and Construction*, FEMA P-55 *Coastal Construction Manual*, and FEMA P-499 Section 8.2 *Decks, Pools and Accessory Structures*.

The I-Code's flood provisions include relevant excerpts from the International Swimming Pools and Spas Code:

- [BS] 304.4 Protection of equipment. Equipment shall be elevated to or above the design flood elevation or be anchored to prevent floatation and protected to prevent water from entering or accumulating within components during conditions of flooding.
- 304.5 GFCI protection. Electrical equipment installed below the design flood elevation shall be supplied by branch circuits that have ground-fault circuit interrupter protection for personnel.

Chapter 9.6 of ASCE 24-14 specifies that:

In-ground and aboveground pools shall be designed to withstand all flood-related loads and load combinations. Mechanical equipment for pools such as pumps, heating systems and filtering systems, and their associated electrical systems shall comply with Chapter 7.

Pools and spas require equipment to maintain water quality and, in heated pools and spas, water temperatures. Pool and spa equipment includes pumps that circulate water, filters that remove particulate materials, and equipment that eliminates coliform bacteria and prevents waterborne pathogens. The equipment also includes piping that connects pumps and filters to pools or spas, water supply piping for filling pools and spas, piping for drainage, discharge and backwashing, and electrical supplies for pumps and sanitation equipment.

Mitigation recommendations for pool and spa equipment are similar to those for other MEP systems (Sections 4.1, 4.2 and 4.3). Equipment should be elevated above the regulatory flood elevation where possible. Equipment placed below the regulatory flood elevation should be flood resistant to prevent water entry and accumulation. Equipment elevation may be limited by functional requirements. For example, circulator pumps typically need a net positive suction head (i.e., a minimum amount of pressure at the pump inlet) to prevent cavitation and facilitate priming. Elevation of in-ground pool and spa pumps may experience problems with pump function and performance. In those cases, the equipment should be elevated as high as possible. When the pump and filtration system is replaced, provisions for pump elevation should be included in the new system design.

4.4 Fuel Systems and Tanks

Residences can contain fuel systems that supply furnaces, boilers, and domestic water heaters. Fuel that serves residences can be liquid or flammable gas. Liquid fuels are generally No. 2 fuel oil, which is nearly identical to the diesel fuel used for vehicles; flammable gas is typically liquid propane (LP) or natural gas (NG). Flammable gas fuels can also supply gas-fired appliances like ranges, ovens, clothes dryers and gas-log fireplaces. Liquid fuels and flammable gases can also supply standby generators.

Like other MEP systems, fuel systems consist of primary components and secondary components. However, fuel systems usually contain relatively few secondary components because all components need to remain functional to supply fuel burning devices.

Table 4-5 lists the components of fuel systems typically found in residences. The components of a house with a liquid fuel system are shown in Figure 4-28. This includes a fuel tank that may be installed within the home or underground next to the home, fill and vent piping, and fuel oil piping that runs between the fuel tank and fuel-burning devices. Components of a residence supplied with a flammable gas (LP or NG) are shown in Figure 4-29. This includes pressure regulators for both LP and NG systems, meters for NG systems and flammable gas piping and valves that connect the flammable gas burning appliances to the flammable gas services. Note: While Figure 4-29 shows the components of LP and NG systems, a house would rarely be served by both propane and natural gas.

Table 4-5. Typical elements of residential fuel systems.

Fuel equipment type (Subsection)	Components
Primary components (4.4.1 and 4.4.2)	Above-ground storage tanks (fuel oil or propane)
	Underground storage tanks (fuel oil or propane)
	LP regulator or NG meter/pressure regulator
	Valves, unions and fittings
	Fuel piping or Flammable gas piping

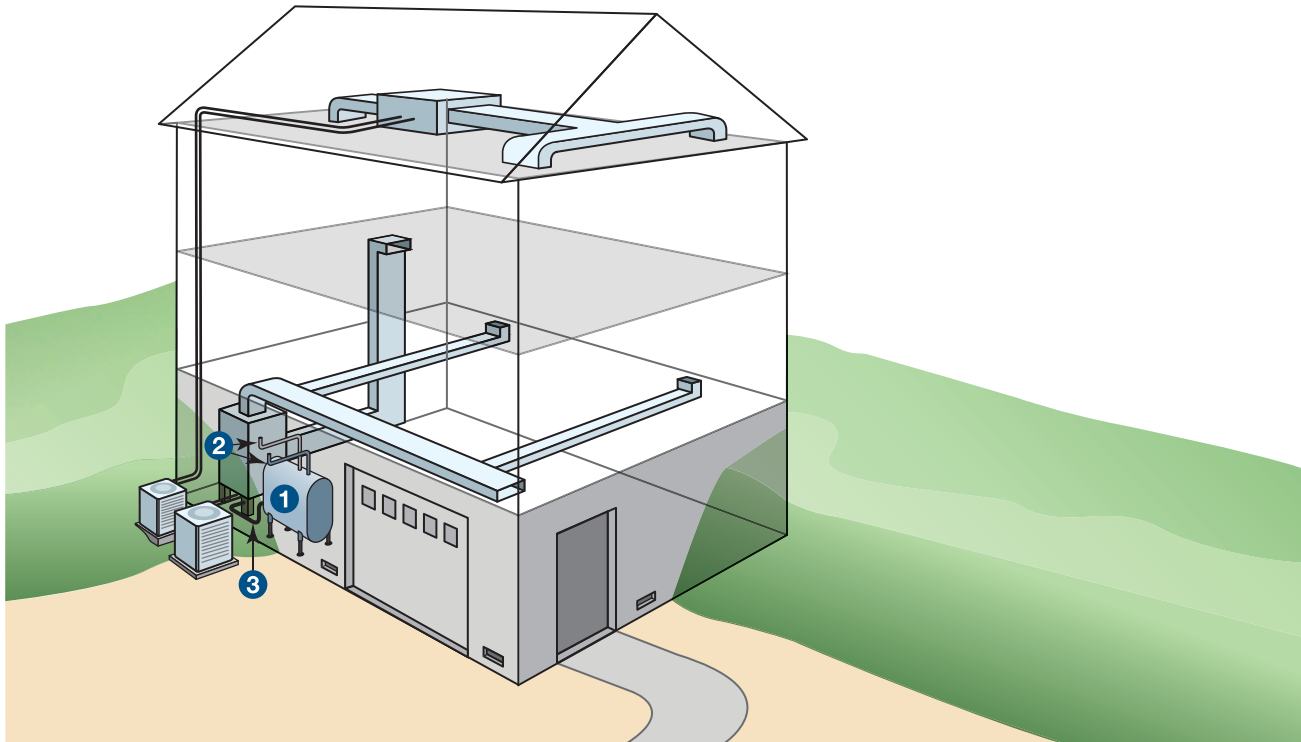

Component	Type
1 Fuel storage tank	Primary
2 Fill and Vent lines	Primary
3 Fuel piping	Primary

Figure 4-28. Typical elements of a residential fuel oil system.

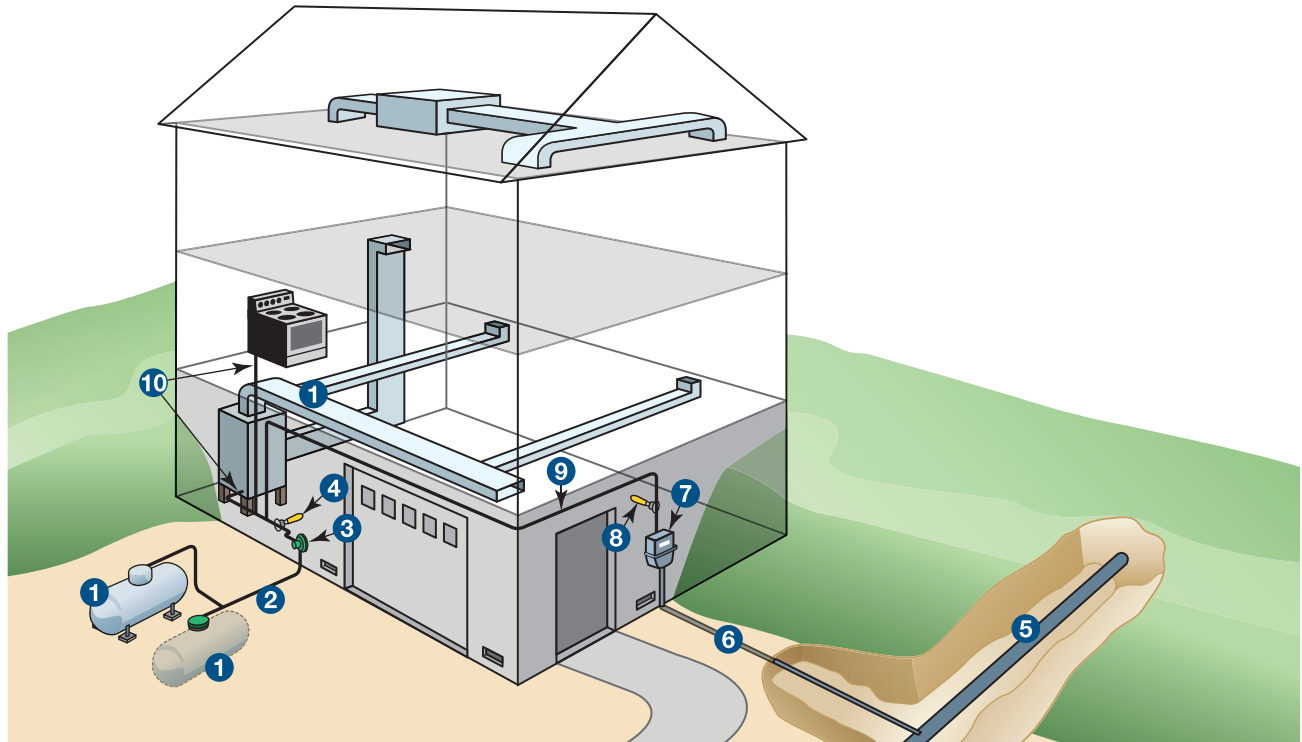

Component	Type
1 LP storage tank	Primary
2 LP service piping	Primary
3 LP pressure regulator	Primary
4 LP service valve	Primary
5 NG utility main	Primary
6 NG service piping	Primary
7 NG meter	Primary
8 NG service valve	Primary
9 NG piping supplying multiple fuel fired devices	Primary
10 LP/NG lines supplying individual fuel fired devices	Secondary

Figure 4-29. Typical elements of a residential flammable gas system – liquid propane (LP) with tank and pressure regulator (left side); natural gas (NG) with meter (right side).

4.4.1 Flood Risk to Fuel Systems and Tanks

Flood risks for fuel systems are similar to those for other plumbing systems. The risks include:

- Damage from hydrostatic forces when fuel system components are submerged;
- Damage from hydrodynamic forces and flood-borne debris impact when they are exposed to moving floodwater; and
- Oxidation of metallic components from the corrosive nature of most floodwater.

In addition, control devices like pressure regulators, solenoids, and meters can be destroyed if exposed to floodwater. With NG and LP systems, floodwater can extinguish standing pilot lights and create a potential fire risk.

The most significant impact of floodwater on a fuel system is damage to propane or fuel tanks. When inundated with floodwater, buoyant forces can crush or displace fuel tanks. The net buoyant forces are less on full tanks than on empty tanks, but full tanks can release their contents when floodwater reaches their fill or vent piping.

Propane and fuel oil tanks are common in residences where natural gas service is not available and may be above or below ground. Propane tanks are placed outside of the house; fuel oil tanks may be inside or outside.

Both underground and above-ground fuel tanks are vulnerable to floodwater damage. Propane and fuel oil tanks are exposed to the following flood risks:

- Submerged tanks are subject to buoyant forces. If the flood forces exceed the weight of an above-ground tank and the fuel within, then the tank is at risk of displacement. For underground tanks, if the flood forces exceed the combined weight of the tank, the fuel within, and any soils above the tank, the tank can be displaced. Tank displacement can damage fuel lines and cause fuels to be discharged. Buoyant forces are proportional to the volume of floodwater displaced. As more of the tank is submerged, the buoyant forces increase. Once a tank is fully submerged, buoyant forces are maximized because greater flood depths do not displace greater amounts of floodwater.
- Submerged tanks can be crushed by flood forces. For each foot of flood depth, freshwater flooding exerts compressive forces of 62.4 psf of tank surface while saltwater exerts compressive forces of 64.0 psf. Unlike buoyant forces that are maximized when a tank is fully submerged, compressive forces continue to increase as flood depths increase. Therefore, tanks exposed to deeper floodwater are much more prone to crushing failure. A fuel tank placed on a basement floor can be exposed to much larger compressive forces than a tank placed in a shallow crawlspace. Similarly, underground tanks can be exposed to greater compressive loads than those placed at grade.
- Above-ground tanks exposed to moving floodwater can be damaged by forces caused by hydrodynamic loads, wave action, and flood-borne debris impact.
- Underground tanks in a V Zone can be uncovered and exposed by erosion and scour, making them more vulnerable to buoyancy forces, velocity flows, wave action, and debris impact.
- Exposed portions of fuel lines can be damaged by moving floodwater. The corrosive effects of floodwater can damage metallic fuel lines.
- Vent lines connected to fuel oil tanks to prevent pressurization during filling operations can allow floodwater to enter the tanks and cause the release of their contents. Floodwater can also flow into fill pipes if they lack watertight caps.



NOTE

Refer to Section 5W.13 of FEMA P-259, *Engineering Principles and Practices for Retrofitting Flood-Prone Residential Structures*, for additional details on how to determine the net buoyant force on a tank and the volume of concrete required to offset buoyancy.

4.4.2 Mitigation for Fuel Systems and Tanks

Elevating fuel system components, preferably above the required flood elevation, is the most effective method to reduce flood risks to fuel systems (see Figure 4-30). ASCE 24, the IBC and the IFGC allow components below the required flood elevation, provided that they are installed to prevent water entry and accumulation and to resist flood forces. Exposure of fuel system components should still be avoided to reduce potential damage from corrosion.

When components cannot be elevated, they should be constructed in a way that allows them to be isolated from other portions of the fuel system, particularly when they are supplied from portions of the system that are protected from floodwater. For example, if fuel piping installed above the required flood elevation along first floor framing supplies a fuel burning appliance below the required flood elevation, a valve should be installed in the line that feeds that appliance. This valve will allow piping exposed to floodwater to be isolated from the rest of the fuel system. This measure will facilitate repairs and recovery after the flood and may allow other portions of the fuel system to remain functional while repairs are completed.



NOTE

While fuel lines should be anchored to prevent dislodging, some soil types can expand and contract depending on moisture levels. It is important to install lines allowing for some movement so that they are not damaged when soils expand. Similarly, wall penetrations should be sealed in a manner that will allow some movement.

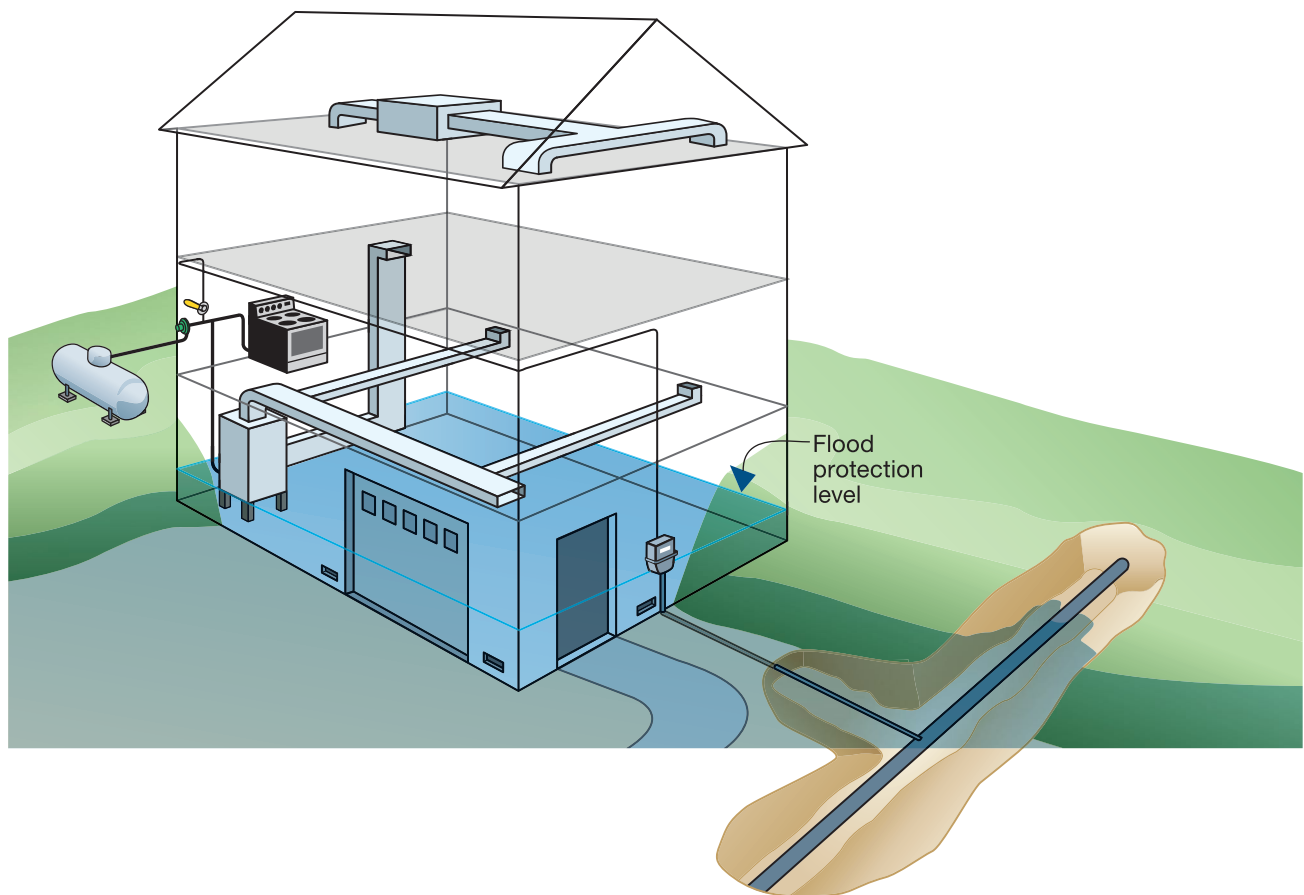

Figure 4-30. Elevation of fuel system components raises the flood protection level.

Fuel piping may need to pass through areas exposed to floodwater, which is typical when fuel piping originates underground. In these situations, non-corrosive piping materials and materials that will not be damaged by floodwater should be installed. If local codes or standards restrict the use of piping materials, fuel gas components that can be exposed to floodwater should be installed in a fashion that facilitates convenient post-event replacement of those components.

In elevated homes constructed over open foundations and in other instances where fuel piping can be exposed to moving floodwater, the piping should be installed on structural components designed not to breakaway during a flood event (see Figure 4-31). In coastal areas they should be installed on the landward side of the structural element; in riverine areas, they should be installed on the downstream side of structural elements. As is the case with domestic water and DWV piping, fuel system piping can be installed in vertical chases provided that those chases are designed to resist flood loads.

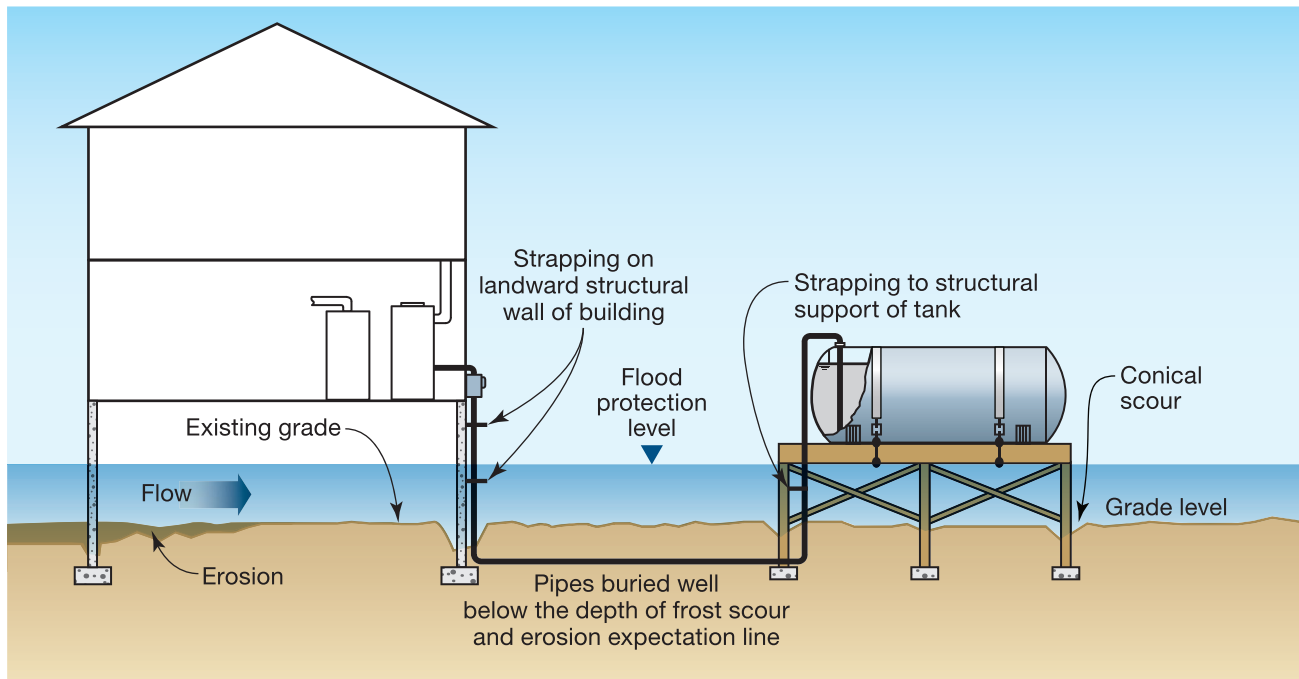

Figure 4-31. Protecting fuel piping from moving floodwater.

In areas where underground fuel piping is placed near obstructions to floodwater flow, localized scouring can occur as with piping installed near foundation elements. To reduce the risk of flood damage, piping should be placed below the predicted level of erosion and scour. Often it is more practical to route underground services away from these obstructions.

In flood-prone areas, the meter can be protected by pipes or bollards installed nearby to shield it from debris impacts. The gas line running from the meter into the house should be protected as much as possible, but ideally the gas would be turned off at the meter prior to a flood event in order to facilitate swift repair.



NOTE

Refer to Section 5.4 of this document for details on tank buoyancy and hydrostatic forces.

The most effective flood protection technique for fuel storage tanks is elevation of the tank above the required flood elevation. In A Zones, tanks can be elevated on platforms, frames, or on structural fill. In V Zones and Coastal A Zones, however, structural fill is not allowed for new construction or Substantially Improved homes. When elevated, the tanks themselves will not be exposed to flood forces during a design flood; however, they still require anchoring and support to resist wind loads and, in seismic areas, earthquake loads. Methods to elevate tanks are shown in Figure 4-32 and 4-33.

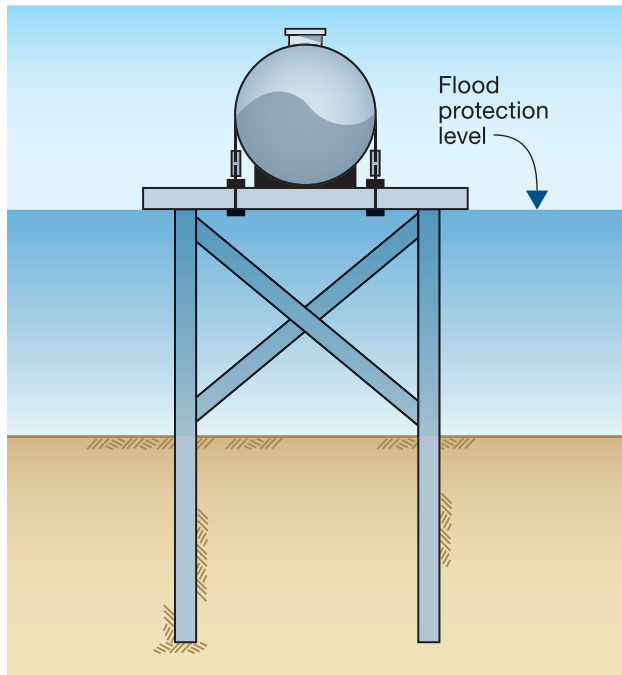

Figure 4-32. Fuel tank elevated on a supporting frame.

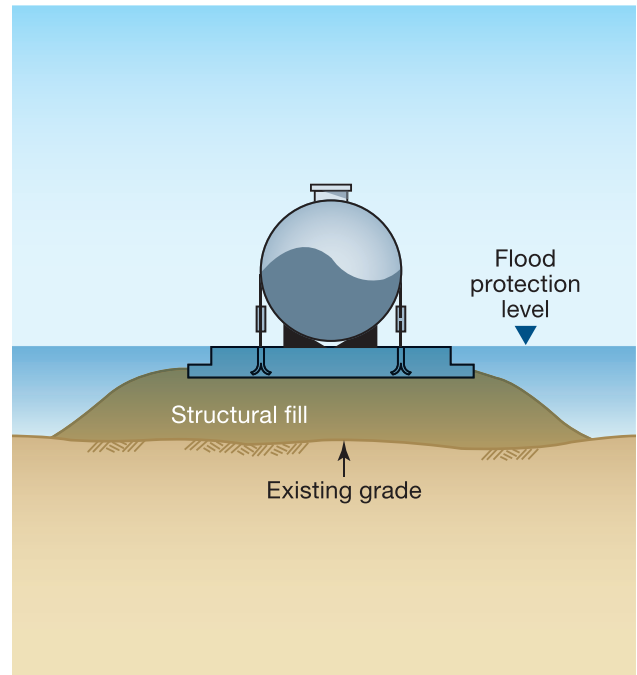

Figure 4-33. Fuel tank elevated on structural fill.

The fuel tank should be secured to the platform with straps or anchors to prevent movement caused by high winds or seismic events. In coastal zones, the anchors should be made of non-corrosive material to reduce potential damage from salt spray.

In V Zones and Coastal A Zones, the platform should be supported by posts or columns that are adequately designed for all loads including flood, wind, and earthquake. Bracing may be required to address loads from moving floodwater and structural redundancy may be appropriate to protect against debris impact. The lowest horizontal member of the supporting frame should be above the wave crest. The foundation should be deep enough to resist loads after being undermined by the predicted levels of erosion and scour. A braced pile or post platform may be necessary in riverine locations where moving water and debris pose a risk.

In SFHAs outside of V Zones and Coastal A Zones, compacted structural fill can raise the ground to a level above the required flood elevation so that the tank can be elevated and anchored to resist wind and seismic loads. Often, a concrete slab is placed on top of the fill material for anchorage. Figure 4-33 shows a tank elevated on fill.

When elevation above the required flood elevation is not feasible, new tanks and tanks for Substantially Improved homes must be designed to resist flood loads and prevent the release of their contents. Also, ASCE 24 requires that both above-ground and underground tanks be designed and installed to resist 1.5 times the flood loads acting on

an empty tank. Those loads are not just the buoyant forces that tend to dislodge tanks but also the compressive forces that could crush tanks exposed to floodwater.

When fuel tanks cannot be elevated or relocated, dry floodproofing may be an option if the residence is not newly constructed or Substantially Improved. For new construction and Substantially Improved residences, dry floodproofing is not allowed by the NFIP for residential occupancy.

Adding weight (dead load) to the foundations supporting the tanks helps resist buoyant forces. Concrete is commonly used to help anchor tanks. Because concrete placed below a flooded tank displaces floodwater and, like the tank, is exposed to buoyant forces, only the submerged weight of the concrete provides resistance to buoyant forces on the tank. Alternatively, the total weight of the concrete can be used, provided that the volume of the concrete is included in the volume of floodwater displaced for the buoyant force calculations. Figure 4-34 shows a tank installation where concrete is used to resist buoyant forces.

Helical earth anchors are occasionally used to resist buoyant forces (see Figure 4-35). The anchors should be designed to take into account the soil type and any reduction in capacity due to saturated soil conditions. All anchors and connecting hardware should be corrosion-resistant.

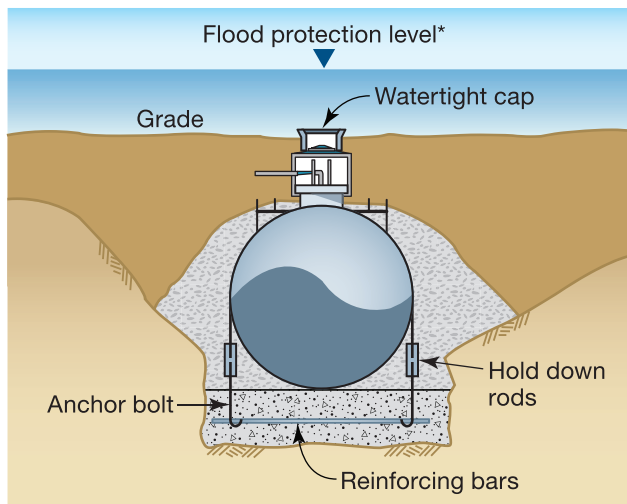

* The flood protection level will be dictated by the ability of the submerged tank to resist depth-dependant hydrostatic pressures

Figure 4-34. An underground fuel tank with sealed cover. Concrete used to resist buoyancy.

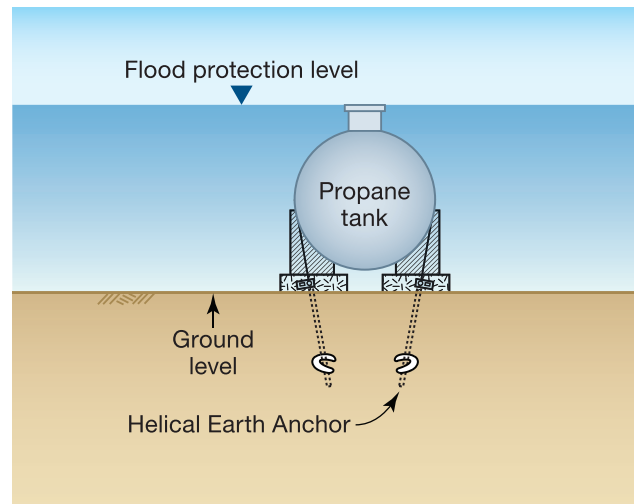

Figure 4-35. Above-ground tank secured with helical earth anchors.

4.5 Conveyances – Elevators and Lifts

While still relatively rare, conveyances are becoming more common in residences. The most common vertical conveyances found in one- and two-family dwellings, townhouses, and residential buildings not greater than three stories are elevators and lifts that move people or materials between the floors or levels of a structure.

Elevators include a cab or platform that moves along rails located in a shaft powered by one or more motors and other equipment. The two primary types of elevators in homes are hydraulic elevators that push the elevator cab using a piston, and traction elevators that hoist the cab using cables. Although hydraulic elevators are typically used in low-rise construction, traction elevators have recently become more common in low-rise residential construction. Typical elements of hydraulic and traction elevators are shown in Figure 4-36.



NOTE

For additional information on elevator systems and mitigation methods, refer to the current version of FEMA NFIP Technical Bulletin 4, *Elevator Installation for Buildings Located in Special Flood Hazard Areas in Accordance with the National Flood Insurance Program*. <https://www.fema.gov/de/media-library/assets/documents/3478>

Lifts are other vertical conveyance mechanisms used in residential construction. Lifts include a wide range of systems with different components and levels of complexity. A few of the most common systems:

- **Passenger lifts:** conveyance mechanisms typically installed on the exterior of the home to move people between floors over a vertical height of about 30 to 40 feet. These lifts usually consist of a hoist motor with cables connected to a platform cage that runs along two or more hoist beams. The hoist motor is controlled by a key-activated control box inside the platform cage. A typical passenger lift is shown in Figure 4-37. Passenger lifts offer many of the same safety features as elevators. The hoist motor is typically above the required flood elevation at the top of the hoist beams. There is no elevator shaft.
- **Chairlifts:** conveyance mechanisms installed over or along a staircase to transport wheelchair occupants between floors. Chairlifts are designed to operate inside structures. Chairlifts and associated equipment are usually located in the elevated part of the home above the required flood elevation, or are protected by other measures.
- **Vertical platform lifts (VPLs):** transport people in wheelchairs from one level to another. VPLs are usually designed so that a wheelchair user can enter the lift on one side and exit on another (i.e., the lift has two doors). VPLs are used indoors above the required flood elevation or outdoors below this elevation and can be open (bound by handrails) or fully enclosed.

Table 4-6 provides a list of the typical elements of elevators and lifts and where they are addressed in this chapter. Note that, unlike most other systems discussed in this chapter, all conveyance system components are considered primary components.

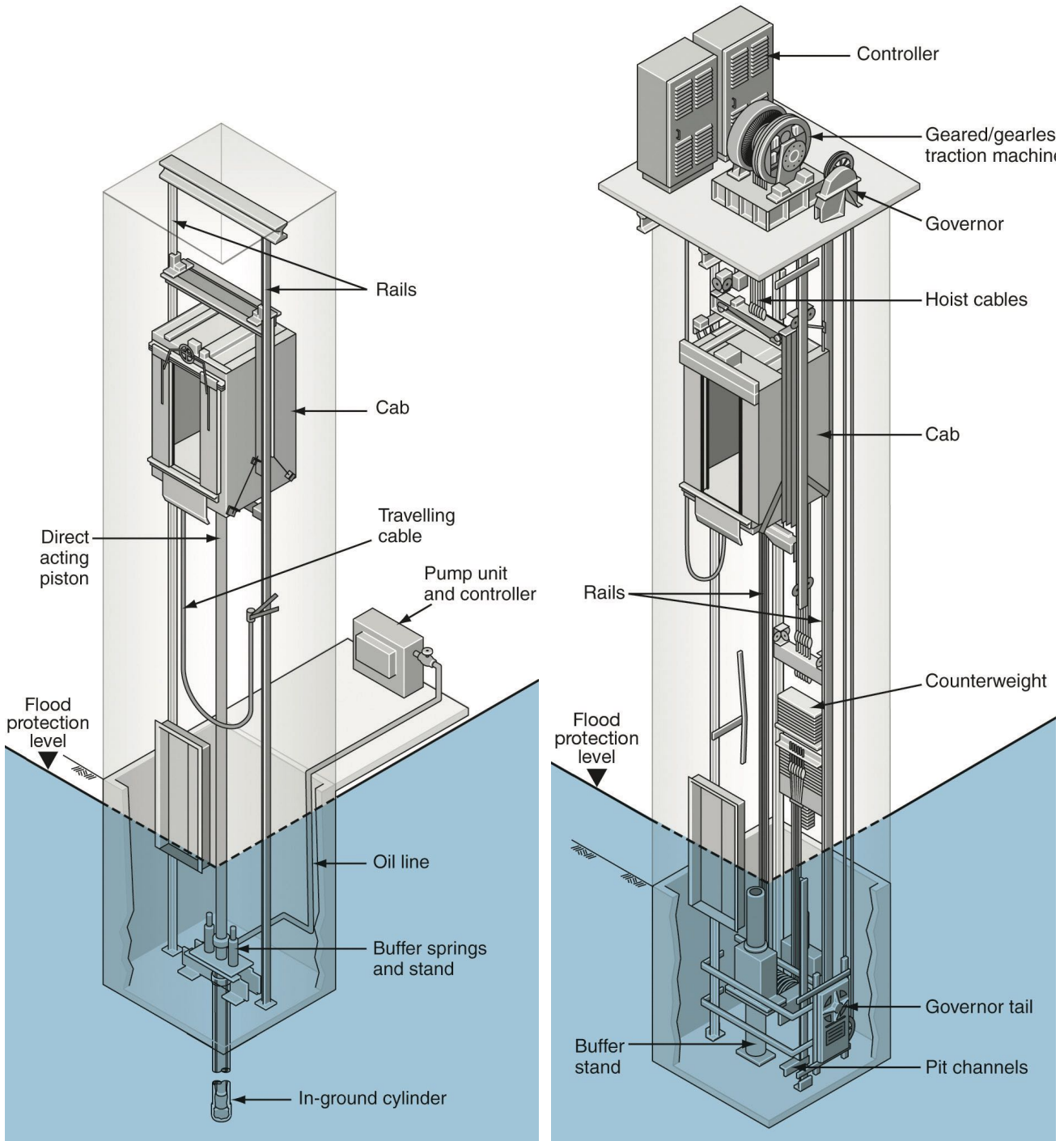

Figure 4-36. Typical elements of hydraulic elevators (left) and traction elevators (right). (Source: Otis Elevator Company).



Figure 4-37. Residential coastal building with passenger lift circled in red.

Table 4-6. Typical elements of conveyances.

Conveyance Equipment Type (Subsection)	Components
Primary components - Elevators (4.5.1)	Elevator shafts and enclosures
	Elevator cabs and equipment
Primary components - Lifts (4.5.2)	Passenger lifts
	Chair lifts
	Vertical platform lifts (VPLs)

4.5.1 Mitigation Measures for Elevators

Elevator shafts and enclosures: Low-rise residential elevators, particularly those added as post-construction retrofits, are usually installed independent of an outside wall. In some cases, shafts may be located inside the structure. Regardless of its location, the shaft must have a landing, usually at the ground level, with a pit at a lower level that is almost always below the required flood elevation. Because elevator shafts and enclosures below the required flood elevation are not required to include hydrostatic openings or breakaway walls, they may obstruct the flow of floodwater and are highly susceptible to damage from various flood forces including erosion and scour. Therefore, elevator enclosures must be designed to resist hydrodynamic and hydrostatic forces as well as erosion, scour, and waves, particularly in V Zones. Technical Bulletin 4 (TB 4) recommends that elevator shafts and enclosures extending below the required flood elevation be constructed of flood damage-resistant materials such as reinforced masonry, block, or reinforced concrete walls and located on the landward side of the building to provide increased protection from flood damage. Further, designs for nearby or adjacent structural elements of the building should account for obstructed flow impacts.

Elevator cabs and equipment: Some equipment common to all elevators will be damaged by floodwater unless protected. The most obvious example is the elevator cab. Depending on the size of the cab and the types of interior materials used, residential elevator cabs can be expensive to replace. Flood damage to elevator cabs can be avoided by installing a detection system with one or more float switches in the elevator shaft to prevent the cab from descending into floodwater (see Figure 4-38). Where possible, elevator equipment such as electrical controls and hydraulic pumps should be located above the required flood elevation. In some cases, it may be necessary

to locate elevator equipment such as switches and controls below the required flood elevation in the elevator pit. If equipment must be located below the required flood elevation, it should be protected using flood damage-resistant components. Any electrical equipment installed in the hoist-way below the required flood elevation should be a NEMA Type 4-rated enclosure for water resistance. Some elevator equipment manufacturers offer water-resistant components. Design professionals should contact suppliers to determine the availability of these components.

4.5.2 Mitigation Measures for Lifts

Passenger lifts: As previously stated, the hoist motor is typically located above the required flood elevation at the top of the hoist beams. The hoist cables and lift controls can be protected by installing the platform cage control box above the required flood elevation. Prior to a flood, it is recommended that the passenger cage be moved above the required flood elevation if possible, so as to reduce the potential damage from moving floodwater and flood-borne debris. Hoist beams and the passenger cage are typically constructed of flood damage-resistant materials such as aluminum or stainless steel; therefore, as long as the base of the hoist beams are anchored into a properly supported foundation that can resist erosion and scour, all key elements of passenger lifts will be well-protected from flood damage.

Chairlifts: Chairlifts are usually located inside buildings; therefore, components of these systems should be located above the flood protection level to protect them from damage.

Vertical platform lifts (VPLs): VPLs may be placed inside buildings above the flood protection level to protect them from flood damage. For outdoor VPLs below the flood protection level, all equipment that cannot be elevated above this elevation is susceptible to flood damage.

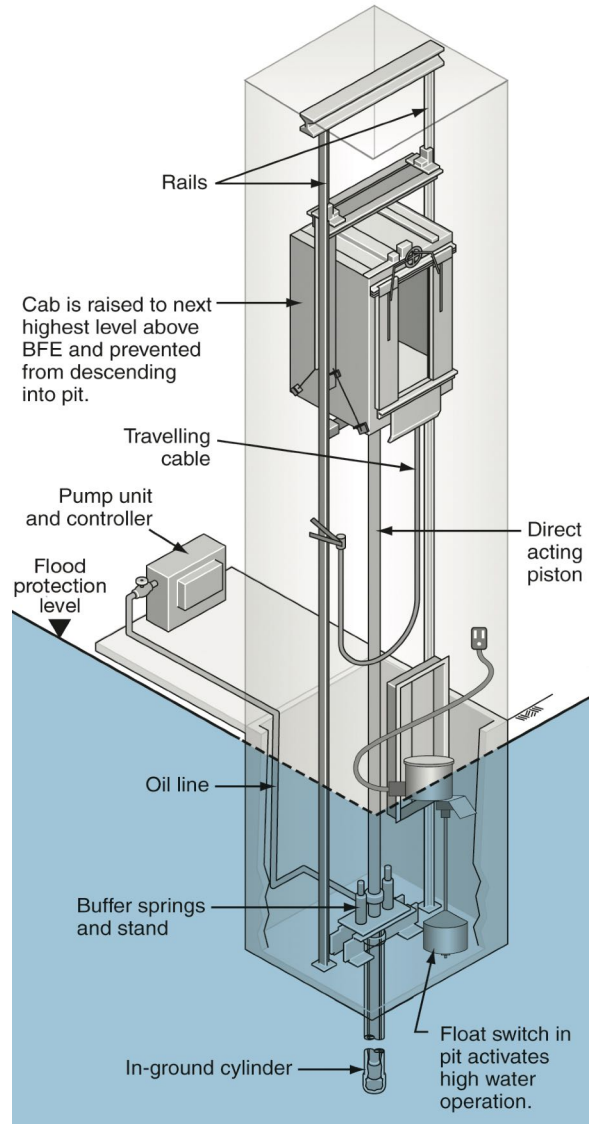

Figure 4-38. Float switch to control cab descent (Source: Otis Elevator Company).



5.0 Mitigation Measures for Non-Residential Buildings

Chapter 5 describes mitigation measures for non-residential buildings. While non-residential buildings are this chapter's primary focus, many of the proposed mitigation measures may be appropriate for larger residential and mixed-use buildings with mechanical, electrical and plumbing (MEP) systems similar to those found in commercial buildings.

The purpose of this chapter is to describe mitigation measures for MEP systems rather than detail specific construction techniques because there are often many ways to reduce exposure to flooding while meeting state and local codes, ordinances, referenced standards, and NFIP criteria.

The NFIP regulations [44 CFR §60.3(a)(3)] state that:

All new construction and Substantial Improvements shall be constructed with electrical, heating, ventilation, plumbing, and air conditioning equipment and other service facilities that are designed and/or located so as to prevent water from entering or accumulating within the components during conditions of flooding.

This requirement is reflected in the I-Codes, in which IBC Section 1612.4 requires that buildings and structures located in flood hazard areas be designed and constructed in accordance with Chapter 5 of ASCE 7 and ASCE 24. ASCE 24 requires that new construction and Substantial Improvements have their lowest floors elevated to or above the flood protection level. It provides allowances for the lowest floors to be below the flood protection level for non-residential buildings and non-residential portions of mixed-use buildings, provided they meet ASCE 24's dry floodproofing requirements. ASCE 24 also identifies requirements for MEP systems under sections on "Attendant Utilities and Equipment" and "Miscellaneous Construction." Note that, for the purposes of Chapter 5 discussion, all Substantial Improvement requirements also apply to structures that have suffered Substantial Damage.

Chapter 2 provides more information on NFIP requirements for building systems, as well as building codes and other regulations that may apply. Since building codes and regulations vary depending on location, one should always consult with local building officials to verify that any new construction or Substantial Improvement proceeds

in accordance with applicable regulations. The local building official will also determine the required permits for large utility system mitigation projects.

The following mitigation actions will be discussed in this chapter:

- **Elevation:** This measure involves elevating vulnerable components of the MEP systems by placing them on elevated platforms or frames, preferably above the flood protection level. For new construction and Substantially Improved buildings, elevation of equipment above this level is the preferred option for compliance with the I-Codes and the NFIP because elevation offers lower residual risks compared with other mitigation approaches. In this document, elevation refers to *in-place* elevation of equipment.
- **Relocation:** This measure involves moving vulnerable components of building utility systems to a higher level or higher floor within the building. Relocation is often the method that offers the least residual risk.
- **Component protection (Dry floodproofing):** This measure involves the installation of flood-resistant barriers and can be used to protect vulnerable components of MEP systems (see Note below). The NFIP does not recognize dry floodproofing for residential buildings as a mitigation measure, so it is not an option for new construction or Substantially Improved large residential buildings. However, dry floodproofing can reduce flood risks in non-residential buildings and non-Substantial Improvement instances. Nevertheless, dry floodproofing should not be chosen over elevation or relocation efforts that would provide the same level of flood protection because the residual risks of dry floodproofing can be significant. See the Note on the next page for additional details regarding residential risks.



NOTE: DRY FLOODPROOFING

If properly installed, all mitigation options presented in Chapter 5 will reduce exposure to flooding, but not all *non-residential* measures are compliant with large, multi-family residential building NFIP and building code requirements.



NOTE: SUBSTANTIALLY IMPERMEABLE

Since it is extremely difficult to make buildings and systems completely watertight, the intent of dry floodproofing is make all elements substantially impermeable to flooding. ASCE 24 defines substantially impermeable as “Use of flood damage-resistant materials and techniques for dry floodproofing portions of a structure, which result in a space free of through cracks, openings, or other channels that permit unobstructed passage of water and seepage during flooding, and which result in a maximum accumulation of 4 in. of water depth in such space during a period of 24 hours.”

- **Other Strategies (Wet floodproofing):** Partial system mitigation can reduce flood damage and service losses. System components that have some resistance to flood damage and can be readily cleaned, repaired and returned to service could be used instead of elevation or dry floodproofing. The NFIP, the I-Codes, and ASCE 24 allow components to be exposed to floodwater, provided that they can resist flood forces and are designed and installed to prevent floodwater entry. However, obtaining flood-resistant components is difficult for many systems, particularly those that prevent floodwater entry and can resist flood loads.

Another potential option is to combine wet floodproofing and dry floodproofing. Areas below the required flood elevation can be partially protected using flood damage-resistant materials, and the interior core areas can protect individual utility systems or key equipment that cannot be relocated above the flood protection level. When areas are below grade, it should be assumed that any wet floodproofed areas will be inundated and may need to be pumped out once floodwater has receded.

When addressing flood risk reduction, it is appropriate to think of building systems as consisting of primary components and secondary components. **Primary components** are those that must function for the system to operate. When primary components are damaged, the entire system ceases to function. **Secondary components** can sometimes be damaged or destroyed without preventing the entire building system from functioning, although the utility system may function at a reduced level of service or cause service interruptions to a portion of the building.



WARNING

While discussing large or complex residential buildings in conjunction with non-residential buildings is appropriate because some systems are similar, readers should remember that some mitigation methods allowed for non-residential occupancies, such as dry floodproofing, are not allowed for new residential construction or Substantially Improved residential buildings.



NOTE: DRY FLOODPROOFING RESIDUAL RISKS

Dry floodproofing is acknowledged by the NFIP for non-residential buildings and is allowed by ASCE 24. However, dry floodproofing is less effective than elevation because it inherently has greater residual risks, such as the following:

- **Active Mitigation:** Dry floodproofing is active mitigation that generally requires human intervention in order to be effective. Failure to install or maintain a flood enclosure or sump pump can render the entire dry-floodproofing system ineffective. By contrast, elevation and relocation are passive mitigation approaches that do not require human intervention.
- **Overtopping:** If flood levels exceed the elevation of the dry floodproofing design, floodwater will flow into the protected area. The time required to fill an area protected by dry floodproofing depends on the volume of the protected area and on the amount of overtopping. A 20-foot by 20-foot area protected by 3-foot flood barriers will fill in approximately 10 minutes if flood levels overtop the 3-foot tall walls by only 1/2 inch.
- **Seepage:** While it is theoretically possible to create watertight flood barriers with impermeable seals, in practice some seepage through the barriers or walls should be expected, particularly when piping, conduits, and other elements penetrate the barriers or walls. Like overtopping, seepage, if not removed, will eventually fill the floodproofed area and submerge protected equipment. Sump pumps, properly sized to accommodate anticipated seepage rates and powered from reliable electrical sources, can reduce flood risks from seepage. Because flooding often interrupts utility power, standby power sources are recommended for dry-floodproofed areas where seepage cannot be eliminated.
- **Structural Failure:** During flood conditions, dry-floodproofed areas are exposed to lateral hydrostatic loads that push against flood barriers and walls toward protected areas, and to buoyancy forces that cause uplift on the floor system of the floodproofed area. If the barriers are not strong enough to resist flood forces or heavy (or anchored) enough to resist buoyancy, the dry-floodproofing system will fail.

DRY FLOODPROOFING RESIDUAL RISKS (continued)

Due to its inherent residual risks, dry floodproofing should not be chosen over elevation or relocation efforts that would provide the same level of flood protection, as illustrated in the example below.

Residual Risk Example: Consider two identical equipment rooms protected to a flood depth of two feet – one using dry floodproofing and the other using elevation. Assuming dry floodproofing measures are substantially impermeable and address any seepage by including sump pumps with reliable back-up power, then dry floodproofing mitigation measures provide the same level of protection for floods less than two feet above floor level and will keep equipment dry and functional. However, if flood levels even slightly exceed the two-foot level of protection, flood barriers will be overtopped and the dry floodproofed equipment will be exposed to two feet of water, resulting in extensive damage and loss of function. By contrast, floodwater that rises to just over two feet will only reach the bottom of elevated equipment and will not likely cause significant damage or loss of function. Therefore, dry floodproofing measures have a significantly higher residual risk than elevation.

Designing building systems for flood resistance requires a holistic approach involving all members of the design team including architects, mechanical engineers, electrical engineers and structural engineers, particularly if massive equipment must be located on upper floors or if dry floodproofing is required.



NOTE: FLOOD PROTECTION LEVEL

This publication uses the term *flood protection level* to address the minimum elevation that the owner uses as a level of flood protection. For new construction, existing construction deemed to be Substantially Improved, or buildings otherwise directed by the authority having jurisdiction, the BFE or design flood elevation usually refers to the minimum required elevation of flood protection. When *required flood elevation* is used in this publication it refers to the minimum elevation required for flood protection by the jurisdictional authority. At a minimum, the *required flood elevation* will be the BFE. In addition, flood protection level refers to the level selected to provide the desired level of protection when compliance with a code or regulation is not required and designers and owners elect to elevate or protect building utility systems.

Table 5-1 summarizes mitigation measures for various MEP systems and where they are discussed in this chapter. General principles of these measures are discussed in Chapter 3, Compliance and Mitigation Measures.

Table 5-1. Summary of utility mitigation measures for non-residential buildings.

System	New Construction or Substantial Improvement, NFIP Compliant	System Repairs for Existing and Non-Substantial Improvement Construction
HVAC (Section 5.1)		
Primary HVAC system components (air handlers, chillers, boilers, furnaces, pumps, and control panels)	Elevate above the flood protection level. Alternatively, dry floodproof to the flood protection level.	Install as high as possible.
Secondary HVAC components (lateral ducts, grills and registers, piping)	Above the flood protection level. Allow secondary components to be exposed to floods only if they prevent water entry and resist flood forces. Components exposed to floods should be functionally isolatable from the rest of the system.	Install as high as possible.
Electrical (Section 5.2)		
Primary electrical system components (service equipment, distribution panels, electrical feeders, standby generators and equipment)	Elevate above the flood protection level. Alternatively, dry floodproof to the flood protection level.	Install as high as possible.
Secondary electrical system components (branch circuit wiring and devices)	Above the flood protection level. Allow secondary components to be exposed to floods only if they prevent water entry and resist flood forces. Components exposed to floods should be functionally isolatable from the rest of the system.	Install as high as possible or isolate to limit damages.
Plumbing (Section 5.3)		
Primary plumbing system components [main piping line, domestic booster pumps, primary domestic water heaters, treatment systems (when required for potability), waste lift pumps, fire pumps]	Above the flood protection level for all nonsubmersible components. Alternatively, dry floodproof to the flood protection level.	Elevate all nonsubmersible components as high as possible.
Secondary plumbing system components (lateral piping lines, plumbing fixtures)	Above the flood protection level for all nonsubmersible components. Allow secondary components to be exposed to floods only if they prevent water entry and resist flood forces. Components exposed to floods should be functionally isolatable from the rest of the system.	Elevate all nonsubmersible components as high as possible.
Fuel Systems (Section 5.4)		
Primary components of fuel systems (regulators, fuel oil pumps, main fuel and gas lines)	Above the flood protection level for all non-submersible components. Alternatively, dry floodproof to the flood protection level.	Protected below the flood protection level.
Secondary components of fuel systems	Above the flood protection for all non-submersible components. Allow secondary components to be exposed to floods only if they prevent water entry and resist flood forces. Components exposed to floods should be functionally isolatable from the rest of the system.	Above the flood protection level for all non-submersible components.

5 MITIGATION MEASURES FOR NON-RESIDENTIAL BUILDINGS

System	New Construction or Substantial Improvement, NFIP Compliant	System Repairs for Existing and Non-Substantial Improvement Construction
Fuel tanks exposed to flooding	Locate above the flood protection level or design tanks to prevent floodwater intrusion and resist flood forces. Alternatively, dry floodproof tanks to the flood protection level.	Protected below the flood protection level.
Conveyances – Escalators and Escalators (Section 5.5)		
Primary and secondary components of elevators and escalators	Above the flood protection level. Alternatively, dry floodproof to the flood protection level. Allow components consisting of flood damage resistant materials to be exposed to floodwaters provided they will resist damages during the design flood.	Protected below the flood protection level.

5.1 Heating, Ventilation and Air Conditioning (HVAC)

HVAC systems for non-residential and larger residential buildings can be significantly different from those found in one- and two-family dwellings. HVAC systems in non-residential and larger residential buildings often include multiple units, centralized chilled water and hot water systems, and active ventilation systems for controlling indoor temperatures, humidity levels and indoor air quality.

The typical elements of non-residential HVAC systems are shown in Figure 5-1. The graphic depicts a hydronic system where water – often containing glycol for freeze protection – is heated or cooled and distributed through the building through coils in air handling units (AHUs) that heat and cool the structure. In direct expansion (DX) systems, AHUs are still used, but the water is replaced with a refrigerant that undergoes liquid-to-vapor and vapor-to-liquid phase changes. The latent-heat transfer associated with those phase changes allows for heat to be removed from the building during air conditioning or added into the building during heating. While DX systems differ from hydronic systems, both consist of primary components like AHUs, condenser units and evaporative coils, and secondary components like ducts, supply grills and return louvers.

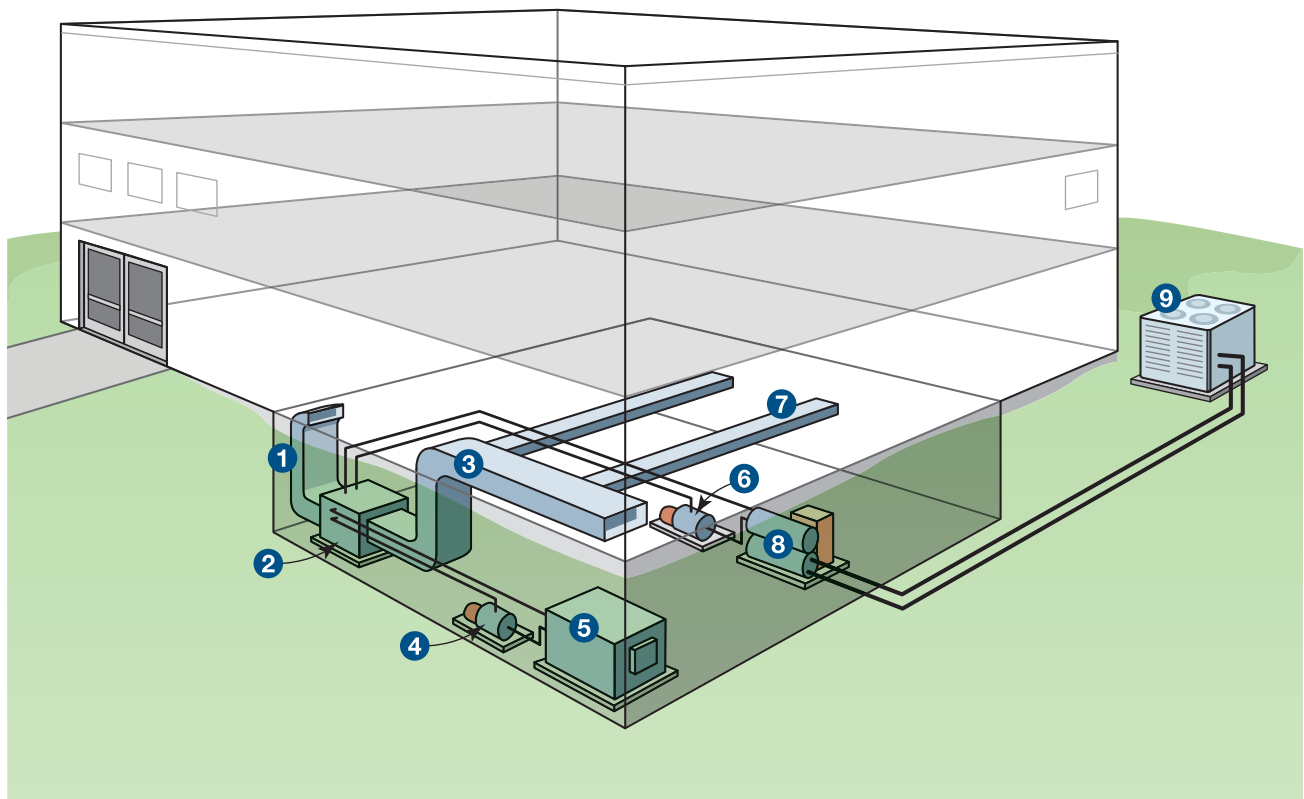

Component	Type	Component	Type
1 Return trunkline duct	Primary	6 Chilled water pump	Primary
2 AHU	Primary	7 Lateral supply ducts and registers (typical)	Secondary
3 Supply trunkline duct	Primary	8 Chiller	Primary
4 Hot water pump	Primary	9 Cooling tower	Primary
5 Boiler	Primary		

Figure 5-1. Primary components of a non-residential, hydronic HVAC system. Note that HVAC components on upper floors are not shown on this simplified graphic.

Table 5-2 provides a list of typical primary and secondary components of non-residential HVAC systems and describes where to find mitigation approaches for each component.

Table 5-2. Typical elements of non-residential HVAC systems.

HVAC equipment type (Subsection)	Components
Primary components (5.1.2.1)	AHUs, supply and exhaust fans, and furnaces when serving entire building
	Trunk line sections of ducts
	Chilled water system components (chillers, cooling towers, condensers, pumps, and piping)
	Hot water system components (boilers, pumps, and piping)
	Fuel tanks and main piping (for fuel-fired systems)
	Pumps and main chilled water and hot water piping
	Primary exhaust systems
	Energy management control panels
Secondary components (5.1.2.2)	AHUs, furnaces, and condenser units serving small, non-critical areas
	Lateral sections of ducts or ducts that serve individual rooms or minor areas
	Ductwork (supply ducts and registers, return ducts, and grills)
	Lateral piping lines
	Convectors and radiators
	Thermostats for individual rooms and areas

As indicated in Table 5-2, primary equipment includes components that heat or cool the entire building, such as those that produce chilled and hot water for hydronic systems and AHUs that serve most or all of the building. While the primary equipment in an HVAC system varies based on the style of the system, there are common features present in most HVAC systems. A description of the most common non-residential HVAC systems and components is provided on the pages that follow.



NOTE

All fresh air intake and exhaust vents should be elevated above the flood protection level, including all HVAC-related ducts and others such as bathroom, kitchen, and laundry room vents.

Hydronic HVAC Systems

Hydronic HVAC systems use water as the thermal transfer medium for heating and cooling a building. The following is a description of the key components of hydronic HVAC systems – chillers and chilled water pumps, boilers and hot water pumps, and air handling units.

Chillers and Chilled-Water Pumps: The HVAC systems in many large buildings use chilled water for mechanical cooling. Chilled water typically is created using water-cooled chillers in conjunction with evaporative cooling towers (see Figure 5-2), or air-cooled chillers that require no cooling towers (see Figure 5-3). Chilled water can also be produced by absorption chillers that produce chilled water from steam or other heat sources.

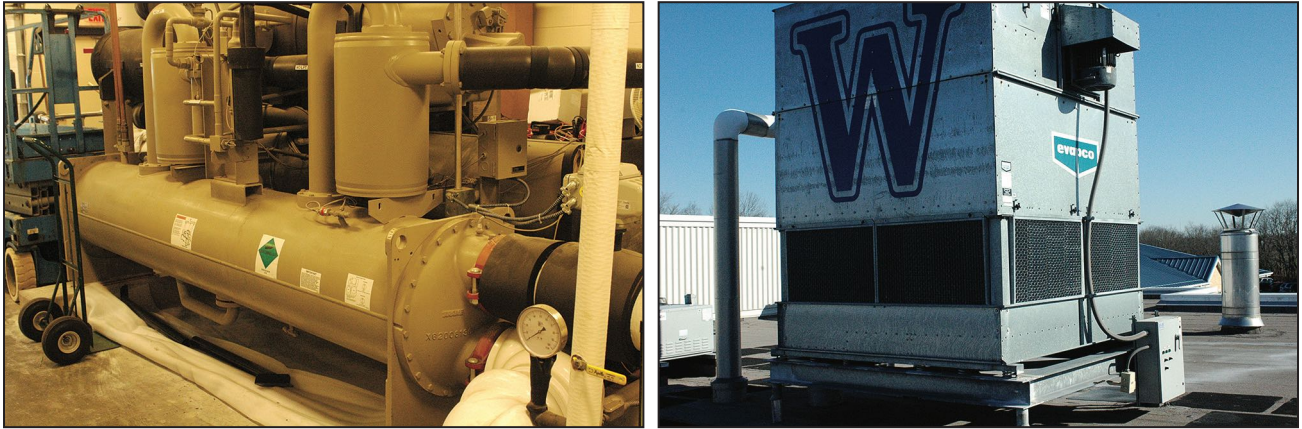

Figure 5-2. Indoor water-cooled chiller (left) with rooftop evaporative cooling tower (right) in Bridgeville, Delaware.



Figure 5-3. Air-Cooled rooftop chiller in Georgetown, Delaware.

Circulating pumps distribute the chilled water through the building. Air conditioning occurs within AHUs where the chilled water flows through cooling coils. Figure 5-4 shows a pump that distributes chilled water from a chiller unit to hydronic coils in AHUs.

Boilers and hot-water pumps: In hydronic systems, boilers produce hot water for heating a building. The hot water is circulated throughout the building by circulator pumps and the hot water supplies coils in AHUs. Heat is drawn from those coils and the water is recirculated back to the boilers for reheating. Figure 5-5 shows a typical boiler. Boilers can be fueled by oil, propane, natural gas, coal, or, occasionally, electricity. Circulator pumps are similar to those used for chilled water.

Air handling units (AHUs): AHUs heat and cool areas of the building using fans, water coils, sound attenuators, and dampers. Air handlers in four-pipe systems contain separate heating and cooling coils that can heat and cool simultaneously. Air handlers in two-pipe systems contain a single coil that can either heat or cool. AHUs also filter the distributed air, and many provide ventilation by introducing fresh outside air. Examples of air handlers include humidifiers, disinfection lamps and electrostatic precipitators. Figure 5-6 shows a four-pipe air handling unit that contains separate chilled- and hot-water coils.

AHUs can vary widely in size. Small AHUs with rated capacities of a few hundred cubic feet per minute (cfm) that serve individual rooms or small areas may be considered secondary components. Large AHUs rated 10,000 cfm or more that serve large areas, entire floors or entire buildings may be considered primary components. Small units can be floor-mounted or suspended from the structural deck above; large units are nearly always floor-mounted. AHUs connect to supply ducts that distribute conditioned air and return ducts that return air to the unit. Often, the spaces above finished ceilings are used as return air plenums. The air handling components of HVAC systems can be damaged or destroyed when exposed to flooding.



Figure 5-4. Chilled water pump, Georgetown, Delaware.

Figure 5-5. Dual fuel (fuel oil and propane) boiler, Dagsboro, Delaware.





Figure 5-6. AHU with a separate chilled water coil (green labels) and hot water coil (yellow labels). The coils are within the unit and are not visible (Dagsboro, Delaware).

Other Types of HVAC Systems

HVAC systems, particularly those in small buildings, often do not use water to transfer heat. Instead, they heat air in furnaces and distribute the heated air through ducts. The furnaces can be fuel-fired (fuel oil, liquid propane, or natural gas) or electric. Electric furnaces heat air through resistance heating coils. In those systems, cooling is often provided by DX units consisting of an evaporative coil and a compressor and condensing unit. The evaporative coil is located either in the AHU or the downstream duct, with the compressor and condensing unit almost being located outside. With DX units, refrigerant goes through a phase change (liquid to vapor or vapor to liquid) and the latent heat associated with those phase changes cools the building.

HVAC systems also can be hybrid systems that use DX for cooling and hot water from a boiler for heat. In hybrid systems, the hot water heating coil is separated from the evaporator coil using refrigerant.

Heat pumps are also frequently used. Heat pumps are DX-type air conditioning units that can mechanically cool building spaces and function in reverse to provide heat. Geothermal systems use heated groundwater to provide heating and cooling for a building. The earth functions as either a heat sink that absorbs heat rejected from the building during cooling or a heat source that provides heat for the building. Geothermal systems typically use heat pumps for the actual thermal exchange.

While the mechanics differ between types of HVAC systems, each consists of primary and secondary components and provides a near-identical overall approach to flood mitigation.

5.1.1 Flood Risks to HVAC Components

HVAC components are generally not flood-resistant, and most will be damaged or destroyed when exposed to floodwater. Chilled water and hot water piping in hydronic systems have some resistance to flood damage, but the insulation typically used on the piping can be damaged by floodwater unless closed-cell insulation is used. Valve stems, threaded fittings and piping supports can also be damaged unless constructed with corrosion-resistant materials. The air handling components of HVAC systems offer some flood resistance because they are usually constructed with corrosion-resistant materials like galvanized steel, but those components can be damaged or destroyed by flood forces that exceed operational design forces.



NOTE

In SFHAs where flood elevations have been determined with delineated BFEs, the actual flood risk to the HVAC system can be determined by comparing the HVAC equipment elevation to the required flood elevation. In areas outside of SFHAs or in SFHAs where flood elevations are undetermined, historical data and records can often be used to assess flood risk.

Flood risks to HVAC components depend on the location of the component within the building. Roof-mounted components and components placed on high floors have little or no flood risk, but equipment located on the lowest floor, below grade, and in a SFHA can be exposed to significant flood risks. Even if the building is located outside of a mapped SFHA, flood risks may still exist from events that exceed the base flood, storm runoff, failure of systems within the building (like potable water or sprinkler systems), and backflow or blockage in waste disposal systems. If a building located in a SFHA is exposed to moving floodwater (e.g., coastal areas and near floodways), HVAC equipment outside or underneath buildings can be damaged or destroyed by hydrodynamic forces, breaking waves, erosion and scour, and flood-borne debris impact.

Boilers and hot water pumps are often located on the lower floors of a building near the fuel source or to chimneys or stacks that exhaust combustion products. As a result, these components and associated equipment may be exposed to flood damage, particularly in buildings in SFHAs or with lower floors that extend below grade.

5.1.2 Mitigation for HVAC Components

Mitigation actions identified in the introduction to Chapter 5, including elevation, relocation, wet floodproofing and dry floodproofing will reduce risk to primary and secondary HVAC components. Most will reduce physical damages and functional loss. Other actions that allow buildings to be supplied by temporary utilities such as installing flanged connections for steam, hot water, chilled water and electrical services will reduce damages related to functional downtime.

5.1.2.1 Mitigation for Primary Components

Elevating equipment, preferably above the required flood elevation, is the preferred method of flood mitigation for primary HVAC components. Components can be elevated in place or, if space exists or can be created, relocated to higher floors in the building.

In-place elevation is generally more convenient because electrical, piping and duct connections are already in place and can be extended from below, or shortened from above, the elevated unit. The amount of flood protection available from in-place elevation is often limited, however, by the vertical height of HVAC components and restricted headroom. Since exterior equipment has fewer vertical obstructions than interior equipment, in-place elevation can provide greater protection.

Support and anchoring for HVAC components also needs to be considered. All HVAC system components must be supported to resist gravity loads, but equipment that could be exposed to high winds and earthquakes require additional support and anchoring. For gravity and seismic loads, relatively light primary HVAC components like AHUs, pumps, and some cooling towers can often be supported and anchored without major structural modification. However, large, heavy equipment like water-cooled chillers may require significant structural modification for adequate support. For equipment that is mounted on the exterior of a building and exposed to wind loads,

vulnerability to wind force is dictated by the equipment's dimensions. The weight of the equipment provides some assistance in resisting wind loads, but physically large units such as roof-mounted AHUs and fan units, though relatively light, can be difficult to anchor.

When exposed to wind and seismic forces, primary HVAC units can shift, causing stress to fixed electrical, piping and duct connections. Flexible piping, duct and electrical connections are recommended to reduce damages from those forces.

Water-cooled chillers are typically placed in mechanical rooms within a building. When mechanical rooms are below the required flood elevation or below grade, mechanical equipment within the rooms is vulnerable to flood damage. Cooling towers and air-cooled chillers may be placed on at-grade slabs or elevated on frames supported by at-grade slabs. Cooling towers may be roof-mounted or placed in mechanical penthouses. Figure 5-7 shows a cooling tower elevated above grade on a steel support frame.

Although equipment placed on at-grade slabs is less susceptible to flood damage than equipment placed below grade, the grade slab elevation may not be sufficient to protect equipment from flood damage. Roof-mounted equipment is usually free from significant flood risk. When the weight of HVAC components prevents relocation to upper floors, component reconfiguration may be an option. For example, it may be possible to replace a water-cooled chiller in a below-grade mechanical room with an air-cooled chiller on an elevated exterior platform.

Like chillers, boilers are often located on lower floors of buildings due to proximity to the fuel source or to chimneys or stacks that exhaust combustion products. Hot water pumps required for hydronic HVAC systems are typically located near the boilers they serve. When located on lower floors or below grade, boiler equipment, especially hot water pumps and associated equipment, may be exposed to flood damage. Ideally, like other primary HVAC equipment, they should be elevated, preferably above the flood protection level.

For non-residential buildings, AHUs may be considered as primary or secondary components of an HVAC system, depending on the number and size of the units. AHUs can be floor-mounted or suspended. Although smaller, suspended units are easier to elevate than larger, floor-mounted units, they should be considered for mitigation because even a few inches of elevation can provide increased protection from flooding.

Occasionally, vertical AHUs can be replaced with horizontal or in-line units. Horizontal units are generally shorter, require less headroom, and are often easier to elevate in place than vertical units. When in-place elevation is not



Figure 5-7. Cooling tower placed on an elevated frame (Hurricane Ike, Port Bolivar, Texas, October 18, 2008).

possible or practical, it may be possible to move AHUs to a higher floor if there is adequate space and if ductwork can be rerouted and extended to accommodate the new location. Relocating AHUs to higher floors may require penetration of smoke and fire separation barriers to accommodate new ductwork; therefore, be sure to consult a design professional to verify that fire risk is addressed and the necessary building permits are filed for local code compliance.

Figure 5-8 shows flood mitigation measures being taken when primary equipment is elevated in-place by placing components on elevated supports or frames.

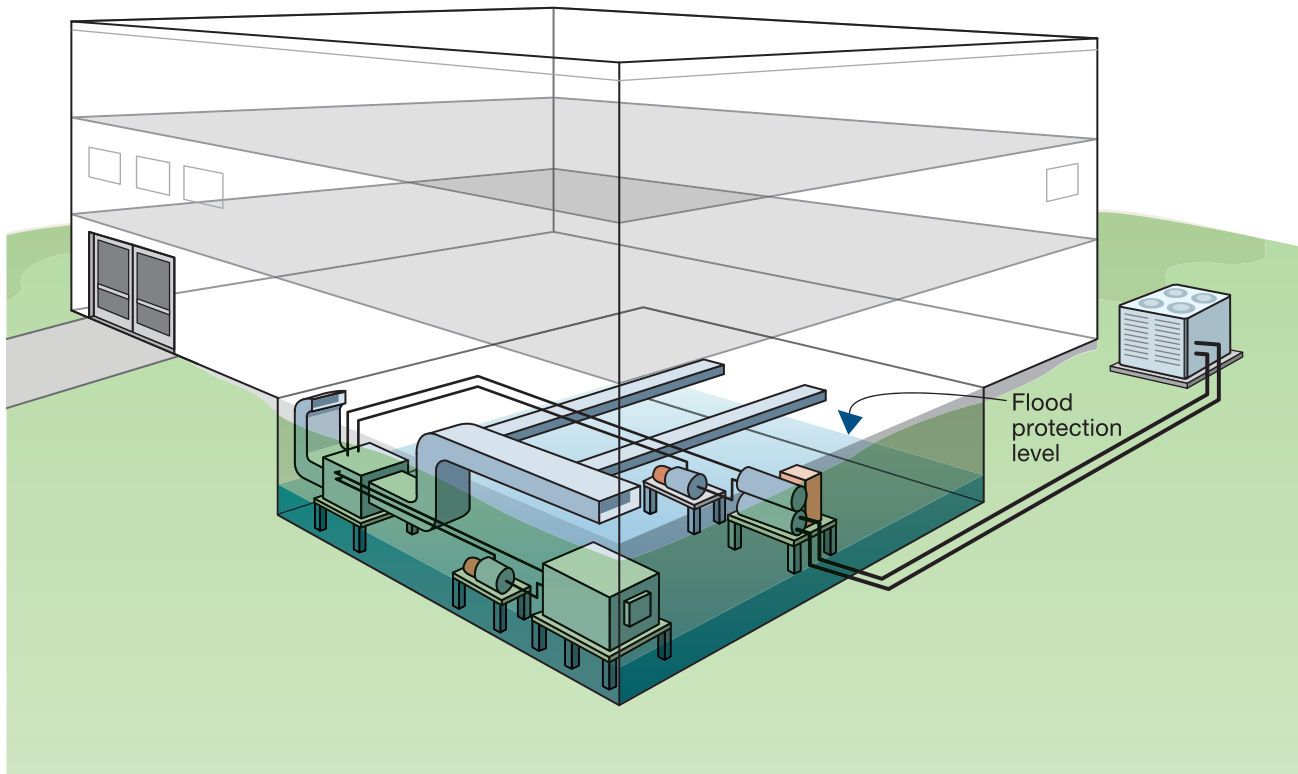

Figure 5-8. In-Place Equipment Elevation of primary HVAC components elevated on supports or frames. Note the source of the flooding in the basement areas can greatly impact the effectiveness of flood protection measures.

Relocating equipment to higher floors is an effective method of reducing flood risk, but it is usually more complex than in-place elevation, as space must be created on the higher floor to house the relocated equipment. However, upper (at-grade and above grade) floors are generally more desirable for owner and tenant businesses than lower floors – which is a primary reason why mechanical equipment is relegated to lower or below grade floors.

Figure 5-9 shows relocation of primary HVAC components from a subgrade basement level to the first floor. This approach is often feasible when less critical or easily replaceable equipment or services can be relocated to a lower floor to create space higher in the building for critical mechanical equipment. In some cases, provisions can be put in place that allow the facility to function without equipment that is normally needed for the operation of the facility. For example, consider a hospital in a SFHA where the mechanical room is in a basement below grade and the laundry area is on the first floor, two feet above the BFE. In its present location, the mechanical room is at high risk of flooding from a 10 year (10-percent-annual-chance) flood; while the laundry is at a much lower risk of

flooding since it is located above the 100-year (1-percent-annual-chance) flood. Both the mechanical equipment and the laundry are needed for the hospital to function, but, while HVAC must remain operational for the hospital to function, the hospital can function without on-site laundry services by using external service providers. Using temporary off-site laundry service providers will allow a hospital to remain in operation while recovering from a flood event, particularly if the HVAC system was protected. Thus switching locations of the mechanical room and laundry area will increase the flood resiliency of the hospital.

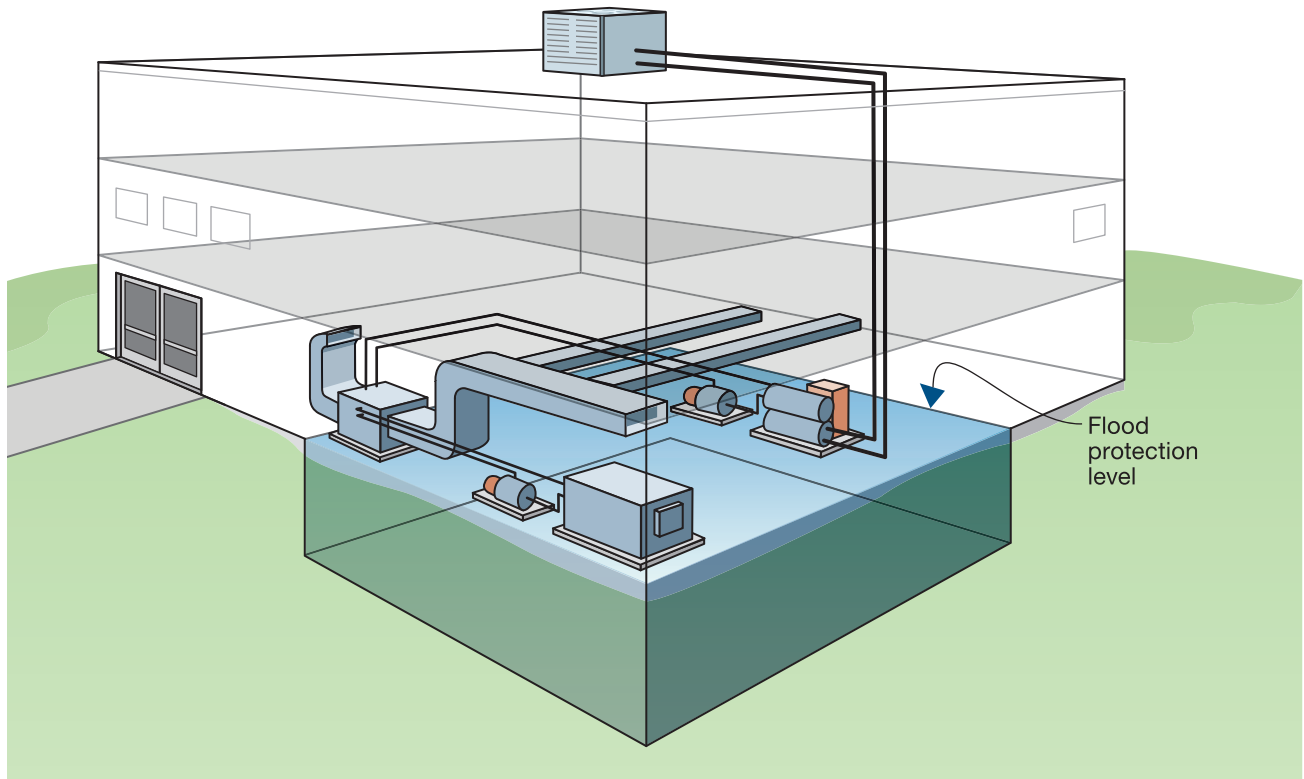

Figure 5-9. Flood risk reduced by relocating primary HVAC components from a subgrade basement level to a higher floor.

When elevation or relocation is not possible, dry floodproofing may allow in-place primary-component protection. Flood barriers can be constructed to protect primary HVAC components from shallow flooding, but for deeper floods it might be more practical to dry floodproof the entire mechanical space. Doing so can provide flood protection for all equipment located within that space. However, it should be emphasized that residual risks exist for all dry floodproofing measures. Those risks are discussed in Section 3.2, Component Protection.

5.1.2.2 Mitigation for Secondary Components

As stated previously in Section 5.0, secondary components include equipment that are necessary to provide heating, cooling, or ventilation to some areas within a building, but not required to provide those services to all portions of a building. Secondary equipment includes: lateral and non-trunk line ducts, supply grills and return registers, lateral portions of chilled- and hot-water piping, convectors and radiators, control equipment for localized control, and AHUs serving small or non-critical areas.

As with primary components, the preferred method of reducing flood risk is to elevate secondary components, preferably above the required flood elevation. Dry floodproofing is allowed in new construction and Substantially Improved non-residential buildings, but is less desirable due to the inherent residual risk of dry floodproofing.

Ductwork: NFIP and ASCE 24 both allow HVAC ducts below the required elevation, provided that they prevent water entry and accumulation and are capable of resisting flood forces. In practice, however, standard ducts are designed to move air, not to prevent water entry and accumulation or resist flood forces. Ducts are often sealed to limit air leakage, particularly in newer buildings that meet energy efficiency standards. However, sealed ducts prevent flood waters from entering them and equalizing flood forces. As a result, even partial submersion in a few inches of floodwater can create hydrostatic forces sufficient to crush sealed ducts or dislodge them from their supports. If ducts are not sealed and floodwater can enter them, flood forces are significantly reduced, but the ducts would violate NFIP regulations and ASCE 24 criteria designed to prevent water from entering or accumulating in equipment below the required flood elevation.

For new construction and Substantially Improved buildings, the most practical method of meeting NFIP regulations and ASCE 24 criteria without having to install specially designed flood-resistant ducts is to elevate them above the required flood elevation. Duct placement and routing above this elevation will need to be addressed during HVAC design and planning.

In existing buildings that are not Substantially Improved, ducts can be installed below the required flood elevation. However, to reduce flood risk, ducts should be placed as high as possible within the building, preferably above the required flood elevation. Even when it is not mandated, consideration should be given to using flood-resistant ducts when they are below the required flood elevation.

Ductwork that has been submerged during a flood event should be carefully inspected and evaluated to determine if it can be cleaned and salvaged. It is recommended that all duct insulation exposed to flooding be discarded and replaced with new insulation, and that all pre-insulated flexible ductwork exposed to flooding be discarded and replaced with new ductwork.

Piping: Since most piping systems associated with HVAC systems operate under pressure, they have some inherent resistance to flood damage. Piping system components like automatic vents, exposed valve stems and seats, and relief valves might be vulnerable to the corrosive effects of floodwater. This vulnerability should be considered in the design and placement of piping system components in new construction and Substantially Improved buildings located in SFHAs.

Some HVAC piping systems like chilled water and hot water systems use pipe insulation that may not be flood damage-resistant. Piping insulation for new construction and Substantially Improved buildings placed below the required flood elevation must be flood damage-resistant. For existing buildings, it may not be practical to relocate piping above the flood protection level, but flooded insulation should be replaced with flood damage-resistant insulation.



NOTE

Refer to National Institute for Occupational Safety & Health (NIOSH) *Recommendations for the Cleaning and Remediation of Flood-Contaminated HVAC Systems: A Guide for Building Owners and Managers*, 2010 for additional details on post-flood cleanup of ductwork and other HVAC components: <http://www.cdc.gov/niosh/topics/emres/cleaning-flood-hvac.html>

Piping in new construction and Substantially Improved buildings must be designed to resist flood loads. HVAC components under elevated buildings are frequently exposed to moving floodwater. Placement of components on the landward side of structural elements (in coastal areas) and on the downstream side of structural elements (in riverine areas) can reduce risks from moving floodwater when the components cannot be elevated. ASCE 7 contains criteria for determining flood forces; ASCE 24 contains criteria for resisting flood damage.

While elevation is the preferred mitigation approach for secondary HVAC components, dry floodproofing is allowed for non-residential buildings and may be used for interim flood mitigation in existing residential buildings that are not Substantially Improved.

The lack of readily available flood-resistant HVAC components that meet NFIP criteria (i.e., those that prevent water entry and accumulation and resist flood forces) will likely make other flood mitigation approaches necessary, particularly in existing construction. Those approaches should minimize damage and facilitate recovery from flood events. The following actions will help achieve those goals:

- **Transition Points:** Creating transition points between sections of the HVAC system above and below the flood protection level will facilitate repairs and recovery. Piping unions can be installed in chilled- and hot-water systems to allow for the removal and replacement of damaged components, while minimizing disruption to the undamaged portions of the system. The transition devices should be installed above the required flood elevation to reduce potential damage.
- **Isolation Devices:** Installing valves that control feed portions of HVAC piping exposed to floodwater will facilitate repair or replacement of damaged equipment. The valves allow damaged equipment to be isolated from undamaged sections, and may allow the undamaged sections to function during repairs. Isolation valves should be installed above the required flood elevation to reduce potential damage. Similarly to valves, dampers can be installed in lateral sections of exposed HVAC ducts that are fed from trunk-line ducts above the floodwater.

5.2 Electrical Systems

Nearly all building systems require electrical power to operate, and without it most buildings cannot function as intended. Buildings that rely on electrical power to supply life safety equipment cannot function as intended or be safely occupied when power is lost.

As with HVAC systems, electrical system components can be vulnerable to flooding and rendered inoperable by flood damage. Unlike HVAC systems, however, the loss of electrical power results in the interruption of all building systems that rely on it to operate. Those systems impacted by electrical power loss can include life safety and critical systems like fire detection, alarm systems and suppression systems, emergency lighting, exit signage and smoke control systems. Loss of electrical power can also impact other systems including HVAC, plumbing, lighting, and conveyances that are often essential to building function during and after a flood event.

Most large buildings contain some sort of emergency or standby power. For many building uses, emergency power is limited to those systems that satisfy requirements for life safety equipment. These systems typically need to be powered for only 90 minutes, which is considered the maximum time needed to safely evacuate a building. Batteries, for example, can provide 90 minutes of emergency power, after which the building would have been evacuated and critical loads would not be needed for life-safety operation because the building would be effectively “off-line.”

Other buildings may have more stringent criteria for emergency power systems. For example, emergency power requirements for many health care facilities are based on a shelter-in-place approach instead of evacuation. Some buildings require emergency power for fire suppression, smoke control systems, and, in high-rise buildings, conveyance systems like elevators. Those systems are referred to as *code-required standby systems*. Often, more stringent emergency or standby power requirements will necessitate the installation of on-site power generation, which is usually provided by standby generators. In some buildings, I-Code requirements (see Note) for emergency power and required standby systems are considered inadequate and optional stand-by systems are provided to supply equipment deemed necessary for building functionality.

All electrical systems, including normal power, emergency power, and standby power systems, are vulnerable to damage if exposed to floodwater and are treated equally by I-Codes and NFIP regulations. In this section, all electrical systems are discussed holistically; recommendations contained in this publication do not distinguish between the three classifications of electrical systems that are acknowledged by the I-Codes. However, readers might be advised to consider the three systems separately and provide additional flood protection for certain systems that are considered more critical than others.



NOTE

I-Codes and standards acknowledge three classifications of electrical systems: emergency systems, code-required standby systems, and optional standby systems. The same level of flood protection is specified for all three systems per the minimum protection in ASCE 24. For normal power systems, the minimum flood protection specified by ASCE 24 may be considered appropriate. However, from a best practices standpoint, it may be appropriate to provide additional freeboard protection for optional standby systems, code required standby systems and emergency systems; for example, elevating the equipment an additional one foot above the required flood elevation.

It may be convenient to consider electrical systems as being comprised of primary components and secondary components. The primary components of electrical systems are often 1) the most expensive to replace, 2) the most critical to system operation, and 3) the most readily mitigated.

Figures 5-10 and 5-11 depict the electrical system for a typical non-residential building. Figure 5-10 shows some of the significant components of the system; Figure 5-11 shows a schematic diagram of an electrical system, often called a “riser diagram.” Large residential buildings may have similar systems; large commercial buildings and industrial facilities may have more complex systems. Regardless of the size and complexity of the electrical system, similar flood mitigation approaches may be taken.

Figures 5-10 and 5-11 show the utility company transformer, which is typically pad-mounted but may be pole-mounted, and the building’s main electrical service, which consists of a free-standing switchboard with a utility metering compartment (lower left), main service section (upper left), and a feeder or distribution section (right). As the name implies, the metering section contains devices needed to measure energy consumption for billing purposes. The metering section is usually sealed so that only utility company workers have access.

The main section contains the main service disconnect that can shut off all utility power to the building. The main device is typically a circuit breaker (or, in older buildings, a collection of fuses) that provides overcurrent protection. The feeder section – also called the distribution section – contains circuit breakers that supply individual feeders, which in turn supply individual electrical loads. Figure 5-10 includes a feeder for a roof-mounted HVAC unit that represents a cooling tower; feeders for four branch circuit panel boards that are supplying receptacle circuits, small appliances or other devices; and a feeder supplying a basement HVAC unit featuring a water-cooled chiller.

Figure 5-10 also shows the feeder section that supplies one of two feeds needed to power an automatic transfer switch (ATS). The second feed is from an on-site standby generator. The ATS senses the loss of normal power and, if power is interrupted, signals the standby generator to start. After the generator starts and becomes operational, the ATS transfers downstream electrical loads from the utility to the generator. The transfer switch operates quickly in response to the loss of the primary power source – for I-Code-required emergency electrical loads, redundant power transfer must occur within 10 seconds.

Note that the riser diagram depicted in Figure 5-11 is simplified. A large building typically contains more branch circuit panel boards, one or more elevators, and dedicated feeders for computer and information technology (IT) systems. When a building’s utility system requires standby power for more than just emergency loads, additional ATSs are needed. Separate transfer switches are often installed for emergency systems, required standby systems and optional standby systems.



WARNING

Any electrical components that come in contact with salt water or contaminated floodwater should be replaced rather than repaired. Corrosion can, at a minimum, significantly reduce electrical components’ useful life, but more importantly, corroded components can cause electrical fires.

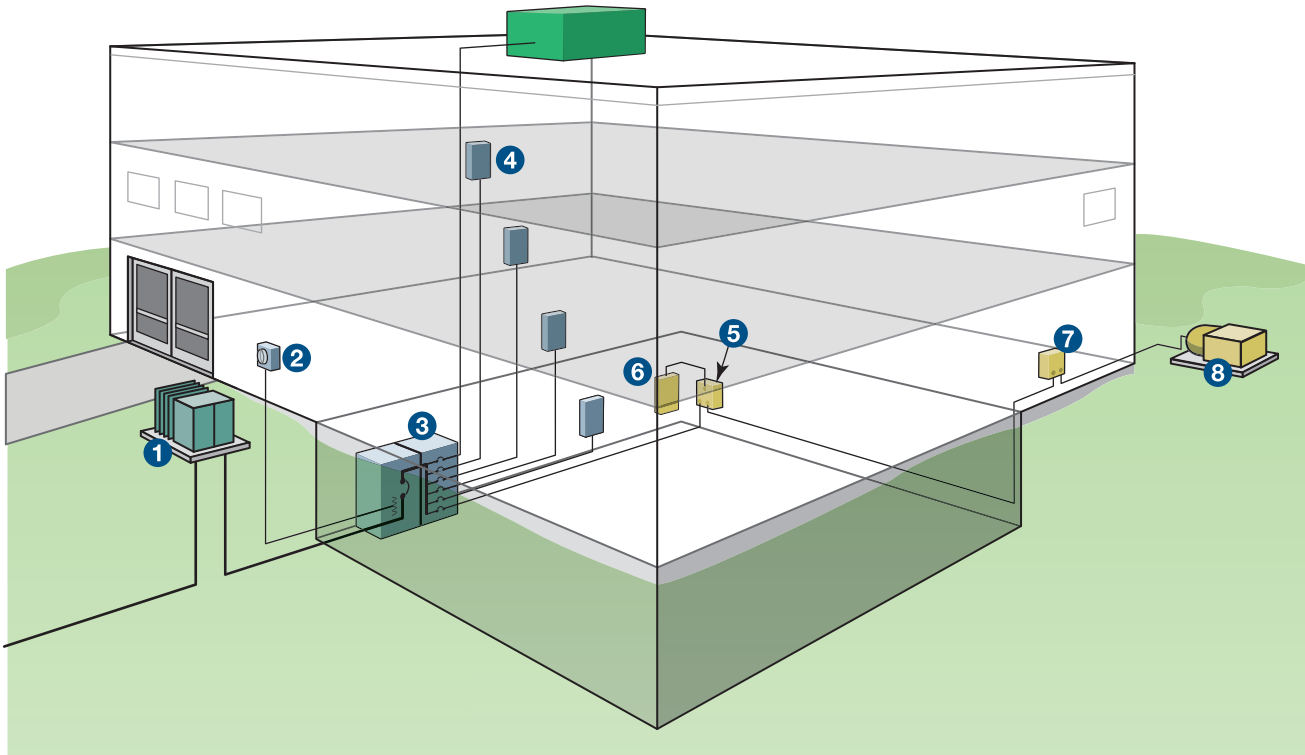

Component	Type
1 Padmount transformer	Primary
2 Electric meter	Primary
3 Service switchboard	Primary
4 Normal power panels	Primary
5 Transfer switch	Primary
6 Normal/standby power panel	Primary
7 Generator circuit breaker	Primary
8 Standby generator	Primary

Figure 5-10. Simplified diagram depicting primary components of a non-residential electrical system.

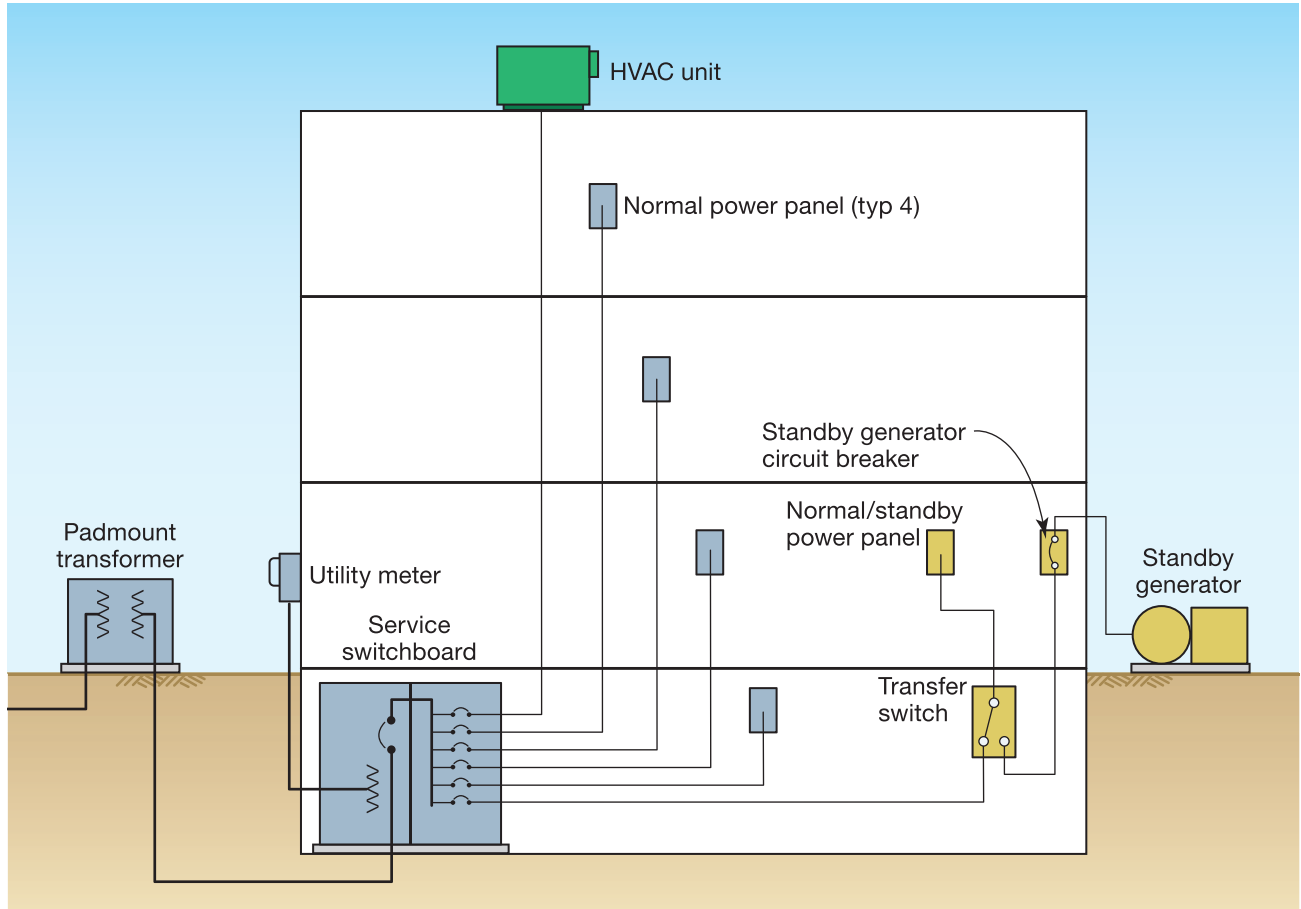

Figure 5-11. Electrical schematic/riser diagram for a typical non-residential building.

Table 5-3 provides a list of typical electrical system components and the subsections where mitigation options are addressed.

Table 5-3. Typical elements of a non-residential electrical system.

Electrical equipment type (Subsection)	Components
Primary components (5.2.2.1)	<p>Pole- or pad-mounted service transformer (typically the responsibility of the utility company) and service drop (overhead service) or service lateral (underground service); utility meter.</p> <p>Service equipment, distribution equipment (distribution panels or distribution sections of service equipment), electrical feeders, motor control centers and branch circuit panel boards (if they supply primary components of MEP or other systems).</p> <p>Emergency/standby power systems components (generators, transfer switches, paralleling and synchronizing equipment, controls); fuel oil pumps, cooling fans and pumps, starting equipment and battery-charging equipment.</p>
Secondary components (5.2.2.2)	Branch circuit devices: receptacles, switches, light fixtures.
Miscellaneous components (5.2.2.3 and 5.2.2.4)	IT and telecommunications: phone, fiber optic, CATV, closed circuit television.

5.2.1 Flood Risks to Electrical Systems

As with HVAC system components, floodwater can damage nearly all electrical system components except for those designed for submerged applications. Flood damage to electrical system components can create fire and electrocution hazards, disrupt operation of power-dependent building systems, and delay reoccupation of a building following a flood event. Salt water or mixed fresh and salt (brackish) water is especially damaging due to corrosion.

New construction and Substantially Improved buildings may feature installation of electrical devices below the regulatory flood protection elevation if the devices are suitable for wet locations per I-Code requirements. However, electrical devices suitable for wet locations can still be damaged if submerged in floodwater, so submergence of any equipment not listed for at least temporary submersion should be avoided. Primary components of electrical systems that can be damaged if exposed to floodwater include pad-mounted utility transformers, service equipment, electrical distribution equipment, panel boards, motor control centers and electrical feeders. When emergency or standby power systems are installed, on-site generators, transfer switches and feeders connecting those components are also vulnerable to floods. Pole-mounted transformers and overhead service drops are inherently at little risk to flood damage because they are generally located above the flood protection level.

Secondary components include switches, convenience outlets, light fixtures, junction boxes, and interconnecting wiring as well as any associated wiring, which is typically not designed for submerged installations.

5.2.2 Mitigation for Electrical Systems

For primary components, relocation is generally the most appropriate mitigation approach for electrical systems in non-residential buildings. In-place elevation is appropriate if elevation that sufficiently reduces flood risk can be achieved and access requirements of National Fire Protection Association (NFPA) 70 National Electrical Code® (NEC) can be met. Those requirements apply to operable electrical devices such as the service disconnect, circuit breakers, and transfer switches. Component protection through dry floodproofing is also an option.

For secondary components, elevation or relocation is also the most appropriate mitigation option, but replacing vulnerable secondary components with those suitable for submerged installation is also an option when cost allows. Unlike many primary components, some secondary components are available in models that are suitable for submerged use.

In existing buildings, it is often not practical to elevate or protect all electrical equipment simultaneously, but flood protection can often be provided in a phased approach. Flood mitigation can be incorporated as equipment needs to be replaced when it reaches its end-of-service life, becomes obsolete, or during building improvements and modifications.

5.2.2.1 Mitigation for Primary Components

Power Transformers: The power transformer is a primary component in an electrical system that serves the building by reducing the voltage of electricity delivered from the utility company's distribution voltage to the building's utilization voltage. Transformers typically reduce power from a nominal 5 or 15 kilovolts (kV) to 208 or 480 volts, and may be pole-mounted or pad-mounted. Pole-mounted transformers are usually mounted high enough to prevent accidental contact and are typically free from significant flood risks. Pad-mounted transformers are generally placed at grade on gravel bases or concrete pads, and thus can be damaged by flooding, particularly in a SFHA.

Flood protection for transformers can be challenging. Elevation is the preferred method to reduce flood risk. However, since transformers need to be physically located close to the building's electrical service equipment in order to reduce the voltage loss that occurs in service laterals, elevation may be difficult unless the service equipment is elevated as well. Dry floodproofing is an option when it protects a large portion of the building. Floodwalls or flood barriers that only protect the transformer generally limit access; several feet of working space is typically needed around transformers. Vehicle access is also required when transformers need to be replaced. Additionally, pump systems are required to remove seepage and address rainwater that accumulates inside the protected area. When transformers cannot be elevated or dry floodproofed and other portions of the electrical system can be protected from flood damage, actions that facilitate transformer replacement can reduce functional downtime. For example, preemptive coordination with the utility to verify that new transformers can be obtained and access can be provided for replacement will reduce service interruptions.

Service Equipment: Service equipment is generally not flood-resistant and cannot prevent floodwater from either entering or accumulating within. For new construction and Substantially Improved buildings, the most practical method to protect service equipment from flooding is to elevate above the required flood protection level or provide dry floodproofing that protects equipment to the required flood protection level. As previously discussed, elevation is the preferred option due to the inherent residual risks of dry floodproofing.

Service equipment can be elevated in place or relocated to a higher level in the building. Relocation achieves greater flood protection; therefore, it is generally more effective at reducing flood risk. However, relocating service equipment to a higher floor requires space to be created for the equipment, which often requires relocating existing equipment or functions on that floor to areas with greater flood risk. In-place elevation is usually easier, but the level of achievable flood protection is generally lower. When elevating in place, access to service equipment and working clearance around the equipment needs to be maintained. For free-standing switchboards and service panels, elevated walkways can be built to provide access to operable components of the service equipment. This access needs to be sized to provide the minimum working clearance required by the NEC.

Other Primary Components: Electrical distribution equipment separate from the service equipment, panel boards, and motor control centers should be treated similarly to electrical service equipment. Primary components should be relocated to higher floors when possible, but may be elevated in place if in-place elevation is sufficient. NEC-required access and working space must also be maintained.

Figure 5-12 shows primary equipment being mitigated by in-place elevation. Elevated platforms are created for access. Figure 5-13 depicts an electrical system in which primary components have been relocated to higher floors.

Electrical feeders should also be elevated, but can be routed below the required flood elevation if the feeders are constructed of flood damage-resistant materials, are able to prevent floodwater entry and accumulation, and can be secured and anchored to resist flood forces.

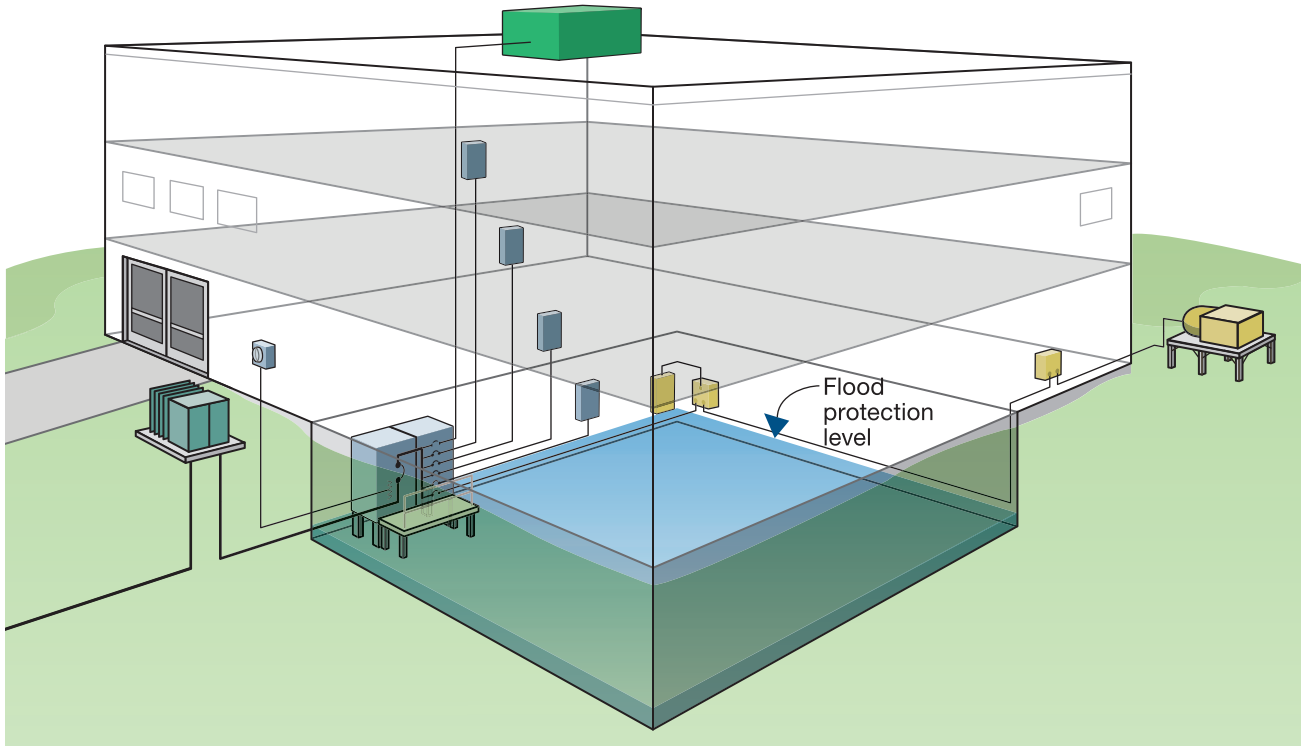
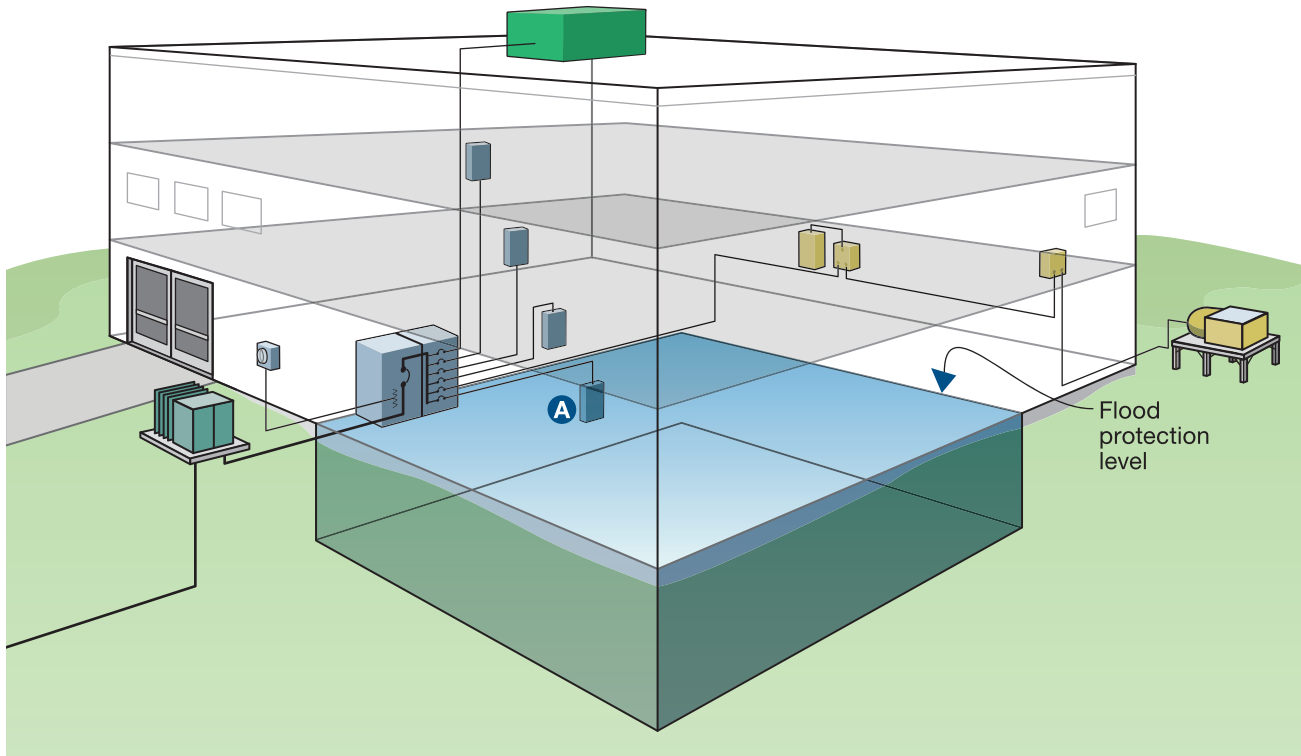

Figure 5-12. Simplified diagram showing primary components of a non-residential electrical system mitigated by in-place elevation. Note the source of flooding in basement areas can greatly impact the effectiveness of flood protection measures.



A Note: The basement panel will remain vulnerable to flooding. The panel should be electrically isolatable from the rest of the electrical system.

Figure 5-13. Simplified diagram showing primary electrical system components mitigated by relocation to higher floors.

5.2.2.2 Mitigation for Secondary Components

As with primary components of electrical systems, the preferred approach to mitigate secondary components is to place as many as possible above the flood protection level and use flood-resistant components below that elevation. For new construction and Substantially Improved buildings, as well as buildings undergoing tenant build-outs or modifications that remove interior finishes and create access to normally inaccessible areas, many secondary electrical system components can be elevated above the flood protection level.

Components that must be placed below the flood protection level should be suitable for submerged conditions. ASCE 24 and the I-Codes allow the use of wiring suitable for wet locations, but the wiring will more likely be exposed to flood conditions.

As few receptacles, switches, lights, and other devices as possible should be placed below the flood protection level. These components should be supplied from separate branch circuits protected by GFCIs. Installing wiring in non-metallic conduit that can readily be cleaned after a flood event can facilitate recovery. Alternatively, junction boxes can be installed above the flood protection level in branch circuits to facilitate removal and replacement of damaged wiring below the box.

In addition, all wiring and components vulnerable to flooding should be designed and installed to limit damage and service losses. When elements of branch circuits are located below the required flood elevation, they should be designed to be electrically isolated from the rest of the system. Such isolation will allow power to be restored before flood-related electrical repairs are completed.

5.2.2.3 Mitigation for Emergency and Standby Power Systems

Approaches for mitigating emergency and standby systems are similar to those recommended for other elements of the electrical system, with a few notable differences. Dry flood-proofing should not be used when elevation is feasible due to the inherent residual risk of this type of protection. Also, while the I-Codes and standards do not mandate additional flood protection for emergency, code-required standby, and optional standby equipment, additional flood protection such as free-board should be considered due to the importance of redundant electrical power systems. Figures 5-14 and 5-15 show examples of protection for emergency power system components.

Secondary components of emergency power systems are also critical and should be elevated, preferably to or above the flood protection level. In existing buildings where elevation above the flood protection level is not feasible, secondary components vulnerable to flood damage should be electrically isolated from the rest of the emergency or standby system.



WARNING

Electrical systems result in numerous penetrations through wall systems. Special attention should be placed on dry floodproofed areas or interior core areas. These penetrations should be properly sealed to prevent water from infiltrating around the conductor or conduit. Water can also travel through conductors or conduits; therefore, those elements should be specifically addressed if electrical systems are routed through wet floodproofed areas.



NOTE

For additional details on protecting emergency power from floods and other hazards, refer to FEMA P-1019, *Emergency Power Systems for Critical Facilities: A Best Practices Approach to Improving Reliability*, September 2014:

<https://www.fema.gov/media-library/assets/documents/101996>

Figure 5-14. Example of protected emergency power system components. The BFE (shown approximately in red) is below the second floor so primary components of the electrical system were elevated well above the required flood elevation.

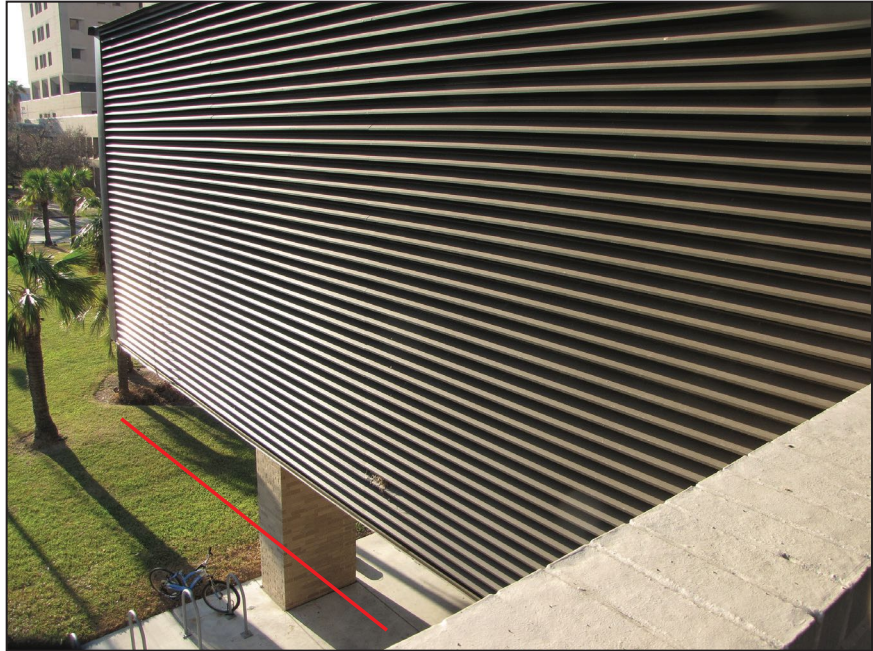

Figure 5-15. Exterior view (top left) and interior views (bottom right) of elevated emergency generator and switchgear at medical center in Galveston, TX. Figure 5-14 is an exterior view of the electric room.

5.2.2.4 Mitigation for Miscellaneous Electrical Systems

Mitigation of miscellaneous electrical systems can be achieved using the same approach presented for branch circuits. Primary components should be identified and elevated. Remote or ancillary components also should be elevated where possible; otherwise they should be retrofitted to allow for automatic isolation from the rest of the system during flood events.

IT and Communications

IT and communications systems include fiber optic, phone, and cable television (CATV). Equipment and wiring located below the flood protection level should be placed with consideration given to access for repair or replacement. Taps should be installed off CATV splitters that feed outlets below the flood protection level to allow isolation from the rest of the system in the event of a flood. Placement of wiring in conduits may facilitate replacement of damaged wires.

Rooms housing a large amount of IT equipment such as server rooms should be located above the flood protection level. These rooms typically need to be mechanically cooled, which should be addressed when mitigating the HVAC system (Section 5.1.2).

Closed Circuit Television (CCTV)

Similar to IT and communications systems, CCTV and security systems often have flexibility when it comes to locating the primary system within a building. These systems should have devices that allow for isolation of components and wiring installed below the flood protection level.

5.3 Plumbing Systems

Plumbing systems found in non-residential buildings include domestic water systems and drain, waste, and vent (DWV) systems. They can also include fire protection (sprinkler) systems, flammable gas piping (propane or natural gas) systems, roof drainage systems, pools and spas, compressed air systems and, in health care facilities, medical gas systems. Protecting plumbing and piping systems is important for maintaining the function of large residential and non-residential buildings.

Plumbing system components can be considered primary or secondary, and their flood risks may be considered accordingly. Table 5-4 lists the typical elements and the subsections where mitigation options are discussed.

Table 5-4. Typical elements of non-residential plumbing systems.

Potable water equipment type (Subsection)	Components
Primary components (5.3.2.1)	Water meter
	Domestic water booster pumps/domestic hot water circulator pumps
	Domestic water heaters
	Main piping lines/valves and fittings within main piping lines
Secondary components (5.3.2.2)	Lateral piping line/valves and fittings within lateral piping lines
	Plumbing fixtures
Wastewater equipment type (Subsection)	Components
Primary components (5.3.3)	Sanitary lift pumps
	Sanitary sewer lateral connection/drainage waste and vent (DWV) piping/backwater valves
Secondary components (5.3.3)	Fixtures, grease trap
Fire suppression and Pool and Spa equipment type (Subsection)	Components
Primary components – Fire Suppression (5.3.4)	Service riser (shut off valves, backflow prevention valves, check valves, test points and gauges)
	Fire pump and jockey pump
Secondary components - Pools and Spas (5.3.5)	Pumps and associated equipment

Figure 5-16 shows a simplified view of plumbing and piping system components in a non-residential building. The figure shows two water services, one for fire suppression and the other for domestic (potable) water, as well as a sanitary sewer service lateral. Both water services originate from a common service line. The figure shows a domestic water heater and various plumbing fixtures for a low-rise building in which domestic water booster pumps are not needed to provide adequate supply pressures on upper floors. The figure also shows a DWV system discharging into a gravity sanitary sewer line below the building. Buildings that discharge sewage to forced mains or sanitary sewer lines elevated higher than the building require a sewer lift pump.

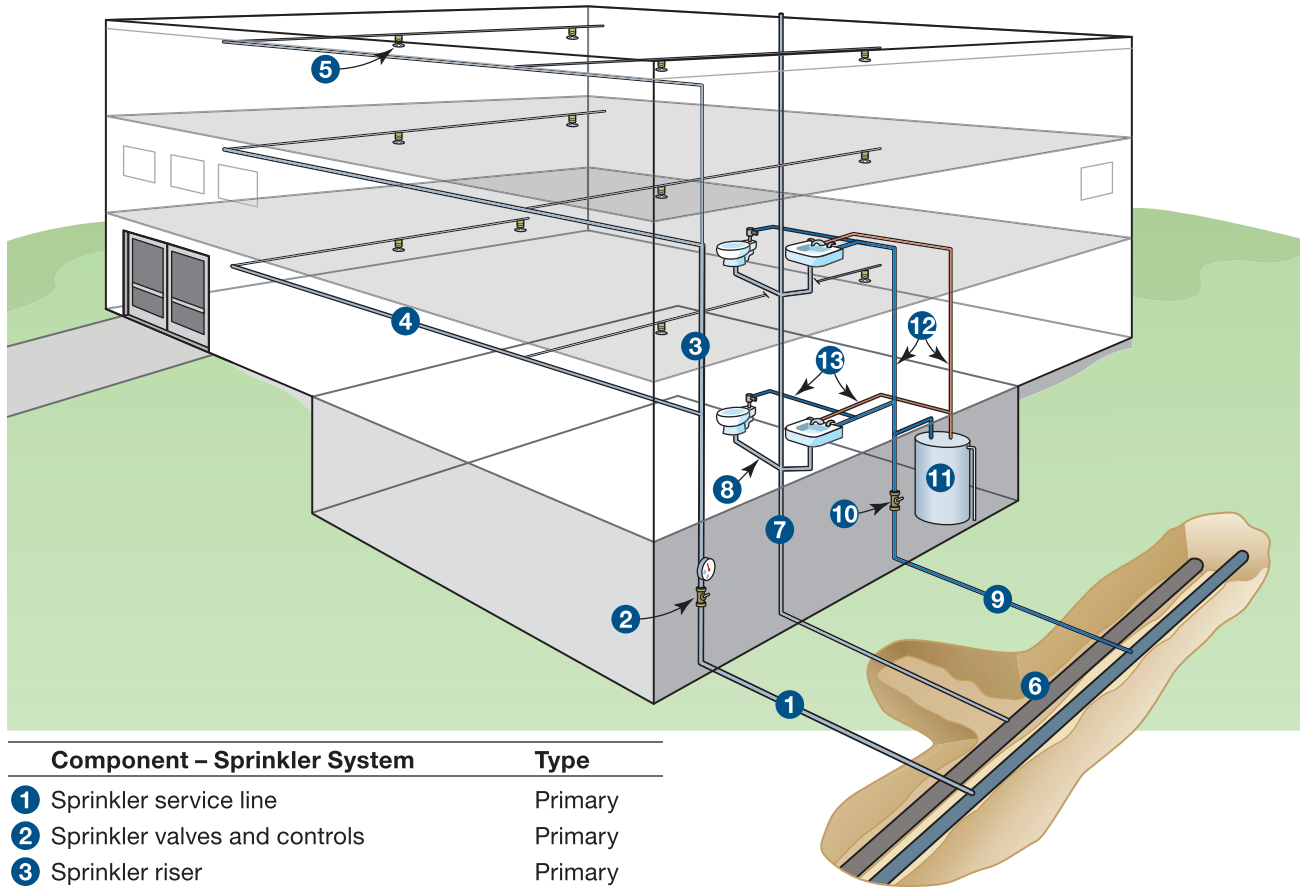

Component – Sprinkler System	Type
1 Sprinkler service line	Primary
2 Sprinkler valves and controls	Primary
3 Sprinkler riser	Primary
4 Sprinkler lateral piping	Secondary
5 Sprinkler head piping	Secondary
Component – DMV	Type
6 Building sewer line	Primary
7 Drain/Waste/Vent piping riser	Primary
8 Drain/Waste/Vent piping serving individual fixtures	Secondary
Component – Domestic Water	Type
9 Domestic water service line	Primary
10 Water service valve	Primary
11 Water heater	Primary
12 Hot and cold water piping mains	Primary
13 Hot and cold water piping serving individual fixtures	Secondary

Figure 5-16. Simplified plumbing systems in a non-residential building.

5.3.1 Flood Risks to Plumbing Systems

Floods can damage several components of a plumbing system including water heaters, booster pumps, lift pumps and some valves components and fittings. Unlike HVAC and electrical systems, some plumbing and piping system components are inherently flood-damage resistant such as non-metallic piping, corrosion-resistant hangers, supports and fittings, and uninsulated wet service piping.

One risk unique to potable water systems is contamination from floodwater when systems lose pressure. Because many portions of a municipal water system are not watertight, groundwater can infiltrate the system outside of the building when system pressure is lost. When municipal water systems become depressurized, “boil-water” orders are often issued. Conversely, plumbing systems within buildings are sealed and infiltration is less likely even if there is a loss in system pressure. Infiltration can occur, however, at openings or penetrations in the system, including plumbing fixtures, anti-siphon valves, and pressure relief valves.

Exposed portions of plumbing systems can be damaged by velocity flow, wave action, and debris impact associated with moving floodwater. Physical damage can occur where buried water and wastewater lines are exposed by erosion and scour and subjected to hydrodynamic forces. This risk is highest in coastal areas, but can also occur near floodways or wherever moving floodwater exists.

5.3.2 Mitigation for Potable Water Systems

Elevation, relocation, and component protection are all mitigation alternatives compliant with NFIP regulations that are permitted for use in buildings in the SFHA:

- **Elevation:** Elevation raises system components in place to reduce their exposure to floodwater. It is often the only practical option for plumbing systems in existing buildings.
- **Relocation:** Relocation mitigates vulnerable system components by moving them to a higher level or higher floors. Relocation is often the mitigation option that results in the lowest residual risk, but may require the displacement of other building equipment or functions in the building to create room for the relocated equipment.
- **Component protection:** Component protection involves the placement of equipment and components that are below the flood protection level in a substantially impermeable enclosure or vault designed and installed to protect against infiltration.

5.3.2.1 Mitigation for Primary Components

Water Meters: Water meter placement is determined by the service provider. Water meters are generally located below grade to prevent freeze damage and to allow access for service and meter monitoring. If possible, the meter should be located above the flood protection level to minimize service interruption. If the meter must be located below this level, below grade meters and associated fittings should be flood resistant. Meters placed above grade should be flood resistant and protected from flood forces and impact from flood-borne debris. Steel bollards are occasionally used to help reduce potential damage from flood-borne debris impact.

Elevated water meters mounted on the building should be located on a vertical structural member on the downstream side in riverine areas, or on the landward side in coastal areas, as shown in Figure 5-17. In coastal areas, meters and associated piping should not be mounted on breakaway walls.

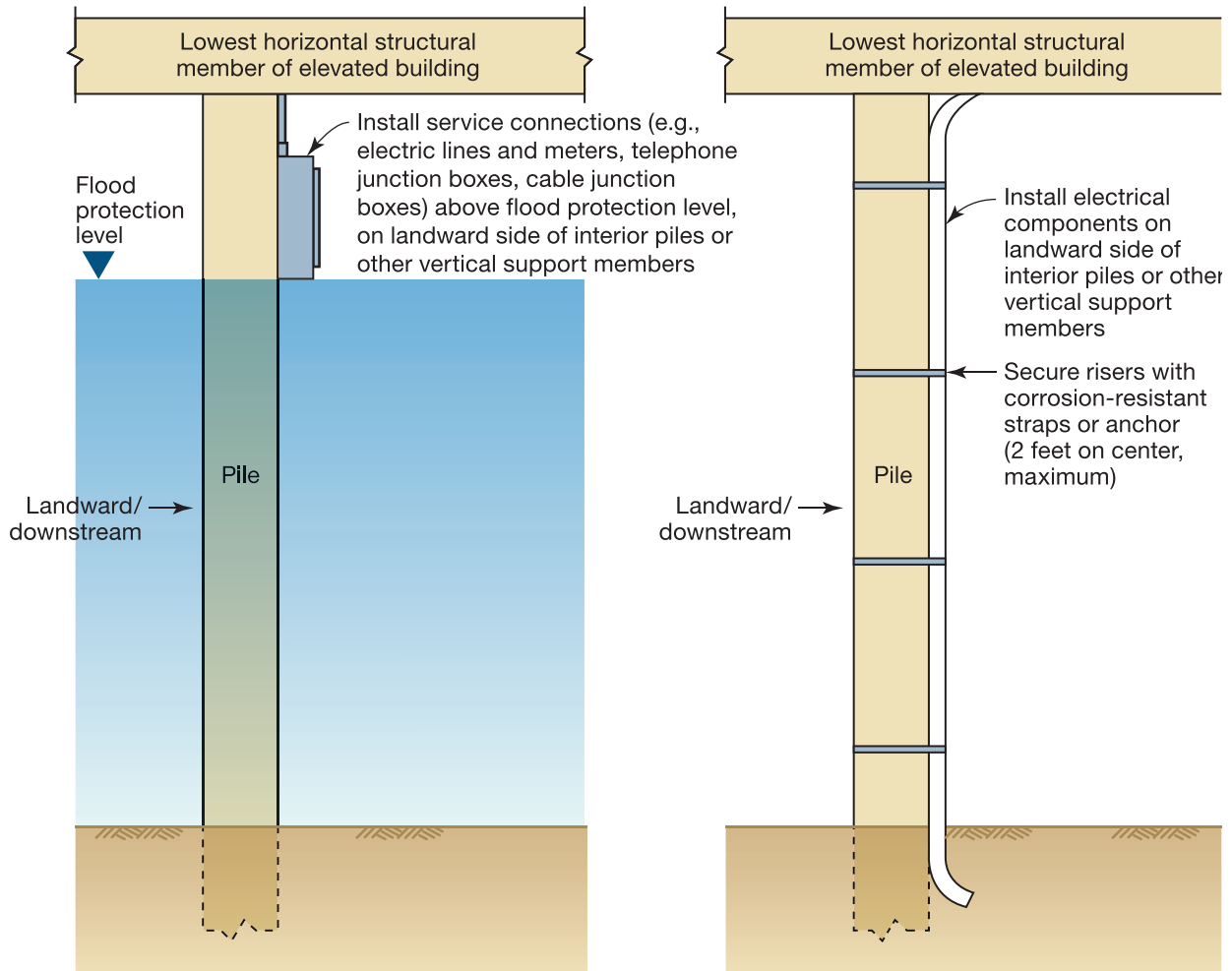

Figure 5-17. Placement recommendation for water meters exposed to moving floodwater.

Booster pumps: Booster pumps increase system pressure and overcome head loss in high-rise buildings. Unless they are suitable for submerged applications, they should be elevated above the required flood elevation along with their electrical supply and controls. When elevation is not possible, dry floodproofing may be used to protect components, but the inherent risks of dry floodproofing measures should be considered.

Water heaters: Vulnerable electric and gas-fired water heaters should be elevated above the flood protection level or located in a dry floodproofed area. Water heaters that create hot water from steam or hot water heat exchangers are somewhat flood-resistant, but can still be damaged by flooding if their controls are submerged. Additionally, unless flood-resistant insulation is used on those units, damage can result if the units are not elevated or protected.

Main piping lines: The portions of a building's water piping system that are considered primary components are those through which all water must flow to reach any portion of the building. Main sections include all portions between the point where the water line enters the building and the first lateral tap off of the main line. The piping, including elbows and tees, can be exposed to floodwater without creating significant flood risk, but may still be damaged by moving floodwater, which can limit where components are installed in coastal areas and near floodways. Other components that can be damaged by floodwater include threaded fittings, valve stems, and flanged couplings manufactured with materials that can corrode. While these components can meet the I-Code criteria for

preventing floodwater entry and accumulation, and may be installed in a way that resists flood forces, they should still be elevated above the required flood elevation to avoid damage from corrosion.

Floodwater can flow through gaps in the penetrations where water service piping enters the building. The risks of floodwater entering around piping can be great in buildings with basements below grade on all sides where the water service pipe penetration is the lowest point of entry.

In an elevated building – for example for buildings sited in a Zone V or a Coastal A Zone – the vertical section of water service piping between the elevated building and the buried water line lateral can be exposed to moving floodwaters, flood-borne debris, hydrodynamic forces and forces from breaking waves. Those vulnerable sections of piping can be protected by the following methods:

1. The water service pipe can be protected from flood damage by attaching it to the landward or downstream side of a vertical supporting structure (pillar, pile, or column) using straps. The vertical supporting structure provides support and protection from the direct impact of debris, wave action, and velocity flow. In coastal zones where salt water and salty air can accelerate corrosion, straps attaching the pipe to the vertical supporting structure should be stainless steel or hot-dip galvanized to resist corrosion.
2. The service connection pipes can be enclosed inside a utility chase extending from ground level to a point above the desired elevation, or to the bottom of the lowest floor. The chase should be designed to resist all flood forces specified by ASCE 7 and should not impede the failure of walls intended to breakaway when exposed to flood loads. Any utility chase should be designed to allow access for inspection and repairs.

5.3.2.2 Mitigation for Secondary Components

Most plumbing fixtures are considered secondary components because they are not required to operate for the entire plumbing system to function. The portions of domestic water piping tapped from main lines are also considered secondary components.

Wherever possible, secondary components should be installed above the flood protection level to avoid corrosive floodwater and reduce potential for contamination if system pressure is lost. Many secondary components can meet the I-Code requirement for preventing floodwater entry and accumulation when designed to resist flood forces.

5.3.3 Mitigation for Drain, Waste and Vent (DWV) Systems

This section will discuss the concepts involved in preventing sewage backup and flood damage to municipal and onsite sewage management systems so that buildings can be reoccupied as quickly as possible after floodwater has receded.

For most buildings, the location and routing of DWV piping is dictated by the location of plumbing fixtures and the sanitary sewer lateral, as well as the requirement that DWV piping be sloped to drain. As a result, there is less flexibility in placing DWV piping and components than in the placement of other MEP system components. Elevating all DWV piping and components above the required flood elevation is generally not feasible (mostly because of the location of the sanitary sewer lateral), but some flexibility for routing and placement to reduce flood risk is typically possible. Since many DWV system components are inherently flood damage-resistant, their location does not significantly impact the overall building flood risk.

In areas prone to inundation flooding, the greatest risk associated with DWV piping is that the piping can act as a conduit for floodwater flow into a building. Floodwater can flow through gaps in the DWV piping penetrations

or through the DWV piping itself. The risk of floodwater entering around piping can be high for buildings with basements in which the DWV piping penetration is often the lowest point of entry. The risk of floodwater entering through DWV can be significant when DWV piping discharges into sewer lines that can be surcharged with floodwater during a flood.

In areas where DWV piping may be exposed to moving floodwater, the piping can be physically damaged by hydrodynamic forces and flood-borne debris impact, and undermined by erosion and scour that exposes buried pipe sections.

The sewer service lateral connection pipe collects and discharges building wastewater to the public sewer system. The depth of a sanitary sewer lateral is typically dictated by the relative depth of the main sewer line. In areas with erodible soils, piping should be buried below the expected erosion and scour depth whenever possible.

Sanitary lift pumps are needed when municipal sanitary sewer lines are at a higher elevation than the building's sanitary sewer piping. Lift pumps are normally placed in sumps with limited storage capacity and are generally designed for submerged operation. However, the pump controls and power supply can be damaged if not placed in enclosures suitable for submerged installation. Control panels for pumps should be placed above the flood protection level. Wiring and components exposed to flooding should be installed in a junction box or similar casing which serves to enclose the components to protect them for a submerged application.

In elevated buildings like those sited in V Zones or Coastal A Zones, the vertical section of DWV piping between the elevated building and the buried sanitary lateral can be exposed to hydrodynamic forces, flood-borne debris, and breaking waves forces. Those vulnerable sections of piping can be protected using the following methods:

1. The sewage collection pipe can be protected from flood damage by attaching it to the landward or downstream side of a vertical support structure (wall, pillar, pile or column) using straps. The vertical support structure provides protection from the direct impact of velocity flow, debris, and wave action. In coastal zones, straps attaching the pipe to the vertical supporting structure should be stainless steel or hot-dip galvanized to resist corrosion from salt spray.
2. The service connection pipe can be enclosed inside a utility chase extending from ground level to a point above the flood protection level, or the bottom of the lowest floor. The chase should be designed to resist all flood forces specified by ASCE 7, should not impede the failure of breakaway walls, and should allow access for inspection and repairs.



NOTE

ASCE 24, Sec. 7.3 Sanitary Plumbing Systems

- Openings below the required elevation should be protected with automatic backwater valves or backflow devices
- Redundant backflow devices requiring human intervention are permitted
- Sanitary system vent openings should be elevated

The **I-Codes** contain criteria on the installation of backwater valves that may control where they can be used.

Check with the **local water authority** for potential restrictions on the use of backflow valves.

Backflow Valves: Installing backflow valves in DWV pipes in the sanitary sewer lateral can help prevent wastewater backup into a building when the sanitary sewer system is surcharged.

There are various types of backflow valves, including check valves, gate valves, and other valves.

Check Valves: Check valves allow for one-direction flow; flow from the opposite direction automatically shuts the valve. Installing a check valve in the sewer service connection pipe ensures that sewage can flow out of the collection system into the public sewer or on-site treatment system during non-flood conditions, but cannot flow back into the building during flood events. One disadvantage of check valves is that they can be susceptible to debris and blockage. Some manufacturers add a shear gate mechanism that can be manually operated to close the drain line when backflow conditions are anticipated, but remains open during normal use. When manually-operated backflow valves are used, the time necessary to close the valves should be factored into the emergency operations plan.

Gate Valves: Gate valves allow flow in both directions when open, but prevent flow in either direction when closed. Gate valves can be closed manually or electronically, but are less susceptible to debris and blockage than check valves. For the best protection against sewage backup, a combination of a check valve and a gate valve should be installed (see Figure 5-18). With a combination of these two types of valves in use, backed-up sewage would shut the check valve automatically. Then, closing the gate valve either manually or electrically would seal the pipe.

Other Valves: In older buildings, floor drains may discharge to piping that connects to sanitary sewer lines, allowing a surcharged sanitary main to backflow contaminated water into a basement through the drains. Ball float check valves, which sense the presence of water and “float” to cut off water flow, can be installed on the bottom of outlet floor drains to prevent backflow of floodwater through the drain. Figure 5-19 shows one style of ball float valve. The valve can also reduce flood risk when floor drains are connected to foundation drains and storm drains that can become surcharged under flood conditions.

Figure 5-18. Combination check valve and gate valve.

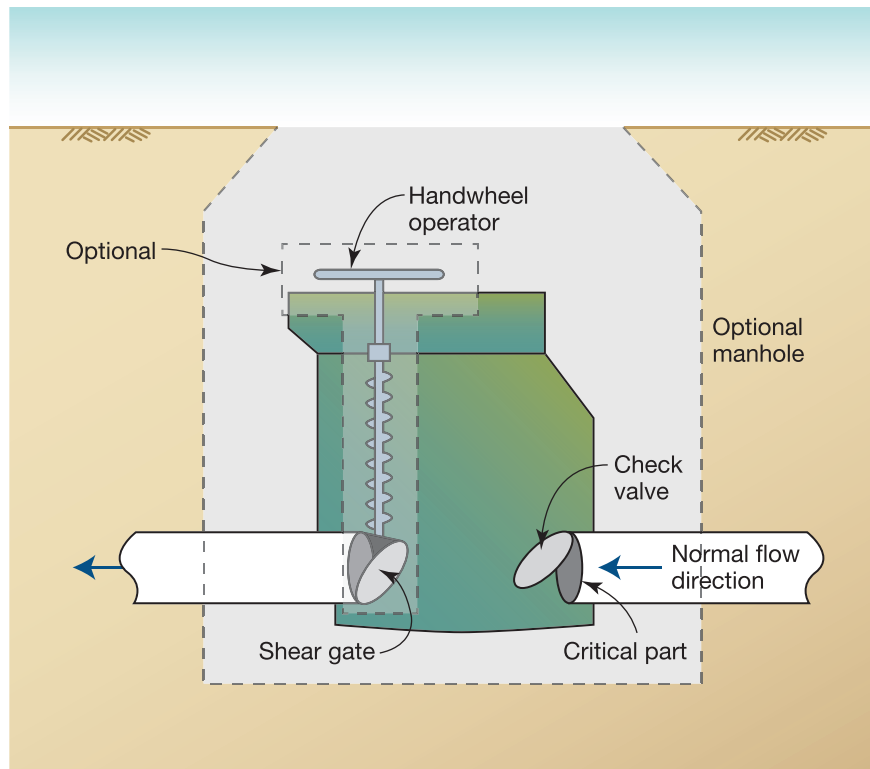

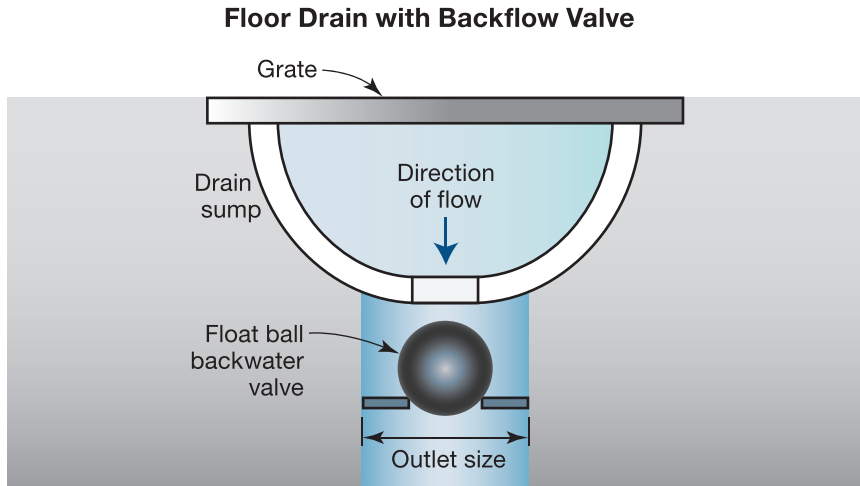

Figure 5-19. Floor drain with ball float check valve.

5.3.4 Mitigation for Fire Suppression Systems

Fire suppression systems consist of fire protection service piping; service valves; backflow valves; main sprinkler risers; lateral piping; sprinkler heads; flow, pressure and tamper switches; standpipes; and fire pumps and fire pump controls.

Many fire suppression components have some inherent resistance to flood damage because the piping is watertight (wet systems) or airtight (dry systems) and is installed along the ceilings of buildings (see Figure 5-20). However, floodwater can enter a building wherever fire suppression piping does, particularly when piping enters a subgrade basement. Therefore, fire suppression components should still be elevated when possible to prevent floodwater from coming in contact with fire suppression piping and reduce the risk of corrosion by floodwater. When piping must be installed in flood-prone areas, steps should be taken to facilitate the removal of floodwater and its corrosive contaminants. Fire suppression piping exposed to moving floodwater should be installed to prevent damage from flood effects. The steps described in Section 5.3.2 for domestic water piping and the steps discussed in Section 5.3.3 for DWV piping are appropriate for fire suppression piping.

Some components of fire suppression systems such as fire pumps and controls are inherently vulnerable to flood damage. Where possible, components of fire suppression systems vulnerable to flood damage should be elevated above the flood protection level or protected by dry floodproofing.



Figure 5-20. Fire protection piping and sprinkler heads installed along the building ceiling.

5.3.5 Mitigation for Pools and Spas

The material presented in this section focuses on protecting the equipment needed to operate pools and spas not on the actual operation of pools and spas. Several codes and standards govern the construction of pools and spas and many of them contain additional criteria for pools and spas placed in Special Flood Hazard Areas. Codes, standards and guides that relate to pools and spas include: The International Code Council's 2015 *Swimming Pool and Spa Code* (ISWPC), ASCE 24 *Flood Resistant Design and Construction*, FEMA P-55 *Coastal Construction Manual*, and FEMA P-499 Section 8.2 *Decks, Pools and Accessory Structures*.

The I-Code's flood provisions include relevant excerpts from the ISWPC:

- [BS] 304.4 Protection of equipment. Equipment shall be elevated to or above the design flood elevation or be anchored to prevent floatation and protected to prevent water from entering or accumulating within components during conditions of flooding.
- 304.5 GFCI protection. Electrical equipment installed below the design flood elevation shall be supplied by branch circuits that have ground-fault circuit interrupter protection for personnel.

Chapter 9.6 of ASCE 24-14 specifies that:

- In-ground and above-ground pools shall be designed to withstand all flood-related loads and load combinations. Mechanical equipment for pools such as pumps, heating systems and filtering systems, and their associated electrical systems shall comply with Chapter 7.
- Pools and spas require equipment that maintains water quality and, in heated pools and spas, water temperatures. Pool and spa equipment includes pumps that circulate water, filters that remove particulate materials, and equipment that eliminates coliform bacteria and prevents waterborne pathogens. The equipment also includes piping that connects pumps and filters to pools or spas; water supply piping for filling pools and spas; piping for drainage, discharge and backwashing; and electrical supplies for pumps and sanitation equipment.

Mitigation recommendations for pool and spa equipment are similar to those for other MEP systems (Sections 5.1, 5.2 and 5.3). Equipment should be elevated above the regulatory flood elevation where possible or should be flood-resistant to prevent water entry and accumulation when placed below the regulatory flood elevation. Equipment elevation may be limited by normal operation requirements. For example, circulator pumps typically need a net positive suction head (i.e., a minimum amount of pressure at the pump inlet) to prevent cavitation and facilitate priming. Elevation of in-ground pool and spa pumps may experience problems with pump function and proper operation. In those cases, the equipment should be elevated as high as possible. When the pump and filtration system is replaced, provisions for pump elevation should be included in the new system design. In some mixed-use apartments or non-residential buildings, pools and spas are located on the lowest level of the building, sometimes far below the flood protection level. In this case, dry floodproofing should be used to protect the filter and pump equipment; this is often accomplished by placing the equipment in a substantially impermeable vault.

5.4 Fuel Systems and Tanks

Non-residential and large residential buildings are often served by fuel systems that supply HVAC components like furnaces and boilers and plumbing system components like water heaters. Flammable gas supplies like liquid propane (LP) and natural gas (NG) can also supply appliances such as ranges, ovens and clothes dryers. Fuel systems can also supply standby generators.

Fuel systems can be considered as consisting primary components and secondary components. Unlike other MEP systems that may have several secondary components, fuel systems contain relatively few secondary components because nearly all components are needed to supply fuel-burning devices.

Table 5-5 lists the components of fuel systems typically found in non-residential buildings. Components of buildings with an on-site fuel system and a natural gas (NG) system are shown in Figure 5-21. Note that, unlike other systems discussed previously, all fuel system components are considered primary components. In buildings served by liquid propane (LP), the NG meter and service lateral would be replaced with an LP regulator and above ground or underground propane tank.

Table 5-5. Typical elements of non-residential fuel systems.

Fuel equipment type (Subsection)	Components
Primary components – Fuel system components (5.4.2)	Above ground storage tanks (fuel oil or propane)
	Underground storage tanks (fuel oil or propane)
	LP regulator NG meter and pressure regulator
	Fuel oil and gas piping, critical valves, unions and fittings

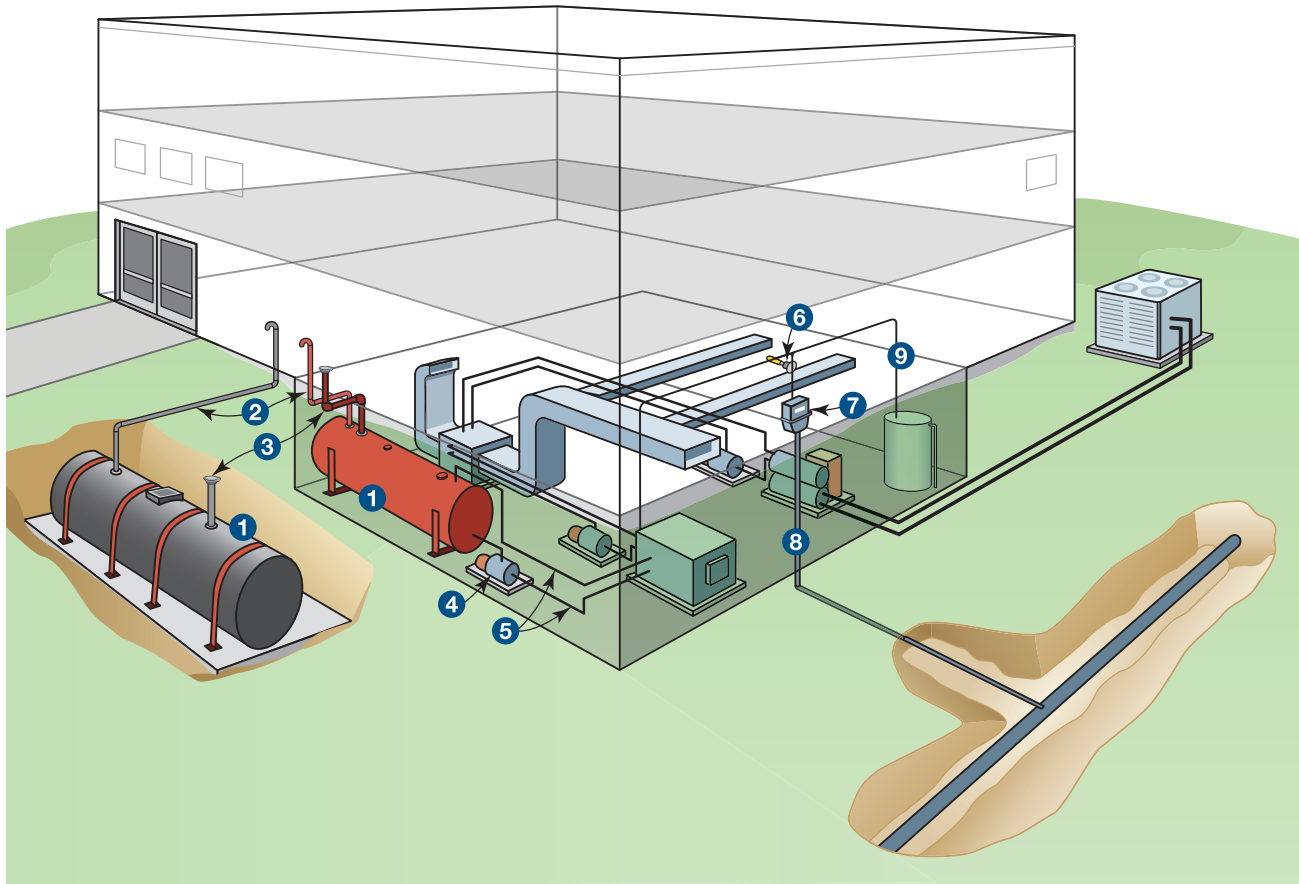

Component – Liquid Fuel Systems	Type
1 Fuel storage tanks	Primary
2 Vent lines	Primary
3 Fill lines	Primary
4 Fuel pumps, filters and conditioners	Primary
5 Fuel supply and return lines required for system operation	Primary
Component – Flammable Gas Systems	Type
6 NG service valve	Primary
7 NG meter/regulator	Primary
8 NG service piping	Primary
9 Flammable gas lines serving individual equipment	Secondary

Figure 5-21. Typical elements of a non-residential building supplied with liquid fuel or flammable gas.

5.4.1 Flood Risk to Fuel Systems

Flood risks for fuel systems include damage from hydrostatic forces when components are submerged, damage from hydrodynamic forces and flood-borne debris when components are exposed to moving floodwater, and corrosion from exposure to floodwater. Control devices like pressure regulators, solenoids, and meters can also be destroyed when exposed to floodwater. With NG and LP systems, floodwater can also extinguish pilot lights, creating a potential fire risk.

Propane and fuel oil tanks are common in buildings where natural gas service is not available and may be installed above or below ground. Propane tanks are placed outside of the building, while fuel oil tanks may be either inside or outside. Both underground and above-ground fuel tanks are vulnerable to flood damage as described below:

- Submerged tanks are subject to buoyant forces. Buoyant forces are proportional to the volume of floodwater displaced. For underground tanks, if the buoyant forces exceed the weight of the tank, the fuel within the tank, and soil above the tank, then the tank will float. Above-ground tanks can also be subject to buoyant forces if the force exceeds the weight of the tank and the fuel within the tank. Tank displacement can damage fuel lines and cause fuel to spill.
- Submerged tanks can be crushed by hydrostatic forces. For each foot of flood depth, freshwater flooding exerts compressive pressures of 62.4 psf of tank surface while saltwater exerts 64 psf. Tanks exposed to deep floodwater are more prone to crushing failure. Tanks placed on a basement floor can be exposed to larger compressive forces than tanks placed in a shallower crawl space. Underground fuel tanks will be exposed to greater compressive loads than fuel tanks placed at grade.
- Tank vents, which prevent tanks from being over-pressurized during filling, can become conduits for floodwater entry if they are not watertight and do not extend above predicted flood levels. Since water is denser than fuel oil, floodwater entry will displace fuels and spill the contents. Floodwater can also flow into fill pipes if the fill pipes lack watertight caps.



NOTE

For an example of how crushing pressures increase with flood depth, see RA2 (*Reducing Flood Effects in Critical Facilities*) of FEMA P-942, *Mitigation Assessment Team Report: Hurricane Sandy in New Jersey and New York*: <https://www.fema.gov/media-library/assets/documents/30966>.

In coastal areas and riverine areas near floodways, fuel system components can be exposed to the damaging effects of moving floodwaters that include hydrodynamic, breaking wave, and flood-borne debris impact forces. Above-ground tanks and fuel piping serving elevated buildings constructed over open foundations can be particularly vulnerable. When exposed to moving floodwaters, buried fuel system components may be exposed when soils are displaced by erosion and scour.

5.4.2 Mitigation for Fuel Systems and Tanks

Elevating fuel system components, preferably above the required flood elevation, is the most effective method of reducing flood risks to fuel systems. While ASCE 24, the I-Codes, and the International Fuel Gas Code (IFGC) allow components below the required flood elevation (provided they are installed to prevent water entry and accumulation and resist flood forces), exposing fuel system components to floodwater should be avoided to reduce potential equipment damage from corrosion and fuel discharge.

When elevation above the flood protection level is not feasible, fuel tank systems for new construction and Substantially Improved buildings must be designed to resist flood loads and prevent the release of their contents. ASCE 24 also requires that both above-ground and underground tanks be designed and installed to resist 1.5 times the flood loads acting on an empty tank. Those loads include buoyancy forces that can dislodge tanks as well as compressive forces that can crush tanks exposed to floodwater.

All fill lines, pipes, and connections should include appropriate valves or other components to prevent floodwater from contaminating the tanks and fuels from escaping during a flood. Even tanks in interior protected areas or dry floodproofed rooms may still have fuel lines that run through an area exposed to flooding. All fuel lines running from tanks to boilers, furnaces, or emergency power systems should be properly anchored to resist flood forces and sealed to prevent leakage that could cause further contamination of floodwater and the building. Wall penetrations should be properly sealed to prevent inundation. Installing fuel lines through a utility chase from lower building levels to equipment located above the flood protection level is recommended. Tank vents should extend above the flood protection level or be provided with check valves that prevent floodwater from entering through the vents when submerged. Utility chases should be floodproofed if it is not possible to protect them from hydrostatic pressures in the space below the flood protection level. Failure of a check valve can result in contaminated fuel; thus, extending vent lines above the required flood elevation is recommended by NFPA 30.



NOTE

Refer to Section 5W.13 of FEMA P-259, *Engineering Principles and Practices for Retrofitting Flood-Prone Residential Structures*, for additional details on how to determine the net buoyance force on a tank and the volume of concrete required to offset buoyancy: <https://www.fema.gov/media-library/assets/documents/3001>.

Fuel pumps and their controls should be protected from flooding. There are two general types of pumps: submersible pumps and external pumps. Submersible pumps, installed in the fuel tank, are typically used in underground tanks and sometimes in above-ground tanks. External fuel pumps are generally not resistant to floodwater and should only be used when located in dry floodproofed areas or vaults. The pump controls and motors for both types of pumps should be elevated, dry floodproofed, or designed for submerged operation and be connected to an emergency power system.

To reduce fire risk, codes may require large fuel tanks to be installed on the lowest floor of a building. When located in or near a SFHA, however, tanks placed on the lowest floor can be exposed to flooding. Tanks are available that can resist flood forces and prevent the discharge of fuel during a flood. Alternatively, tanks which are not flood-resistant can be installed in substantially impermeable areas that will prevent the tank, associated piping and equipment from floodwater exposure. Such areas are often referred to as vaults and are typically constructed of reinforced concrete because the concrete mass helps counteract buoyancy and resists hydrostatic pressures. Steel vaults, which are typically lighter than concrete, can also be used, but generally require additional mass or anchorage to resist buoyant forces. Rooms containing tanks require access and ventilation to avoid explosive concentrations of fumes, so they must be equipped with specially designed watertight submarine doors with substantially impermeable seals, as well as ventilation equipment that vents above the required flood elevation. Also, due to the difficulty of creating an impermeable barrier seal, provisions should be included to address floodwaters seeping into the vault. Figure 5-22 depicts a fuel tank and fuel pump placed in a below grade vault. Figure 5-23 shows a fuel tank placed in a below grade vault and its access door.

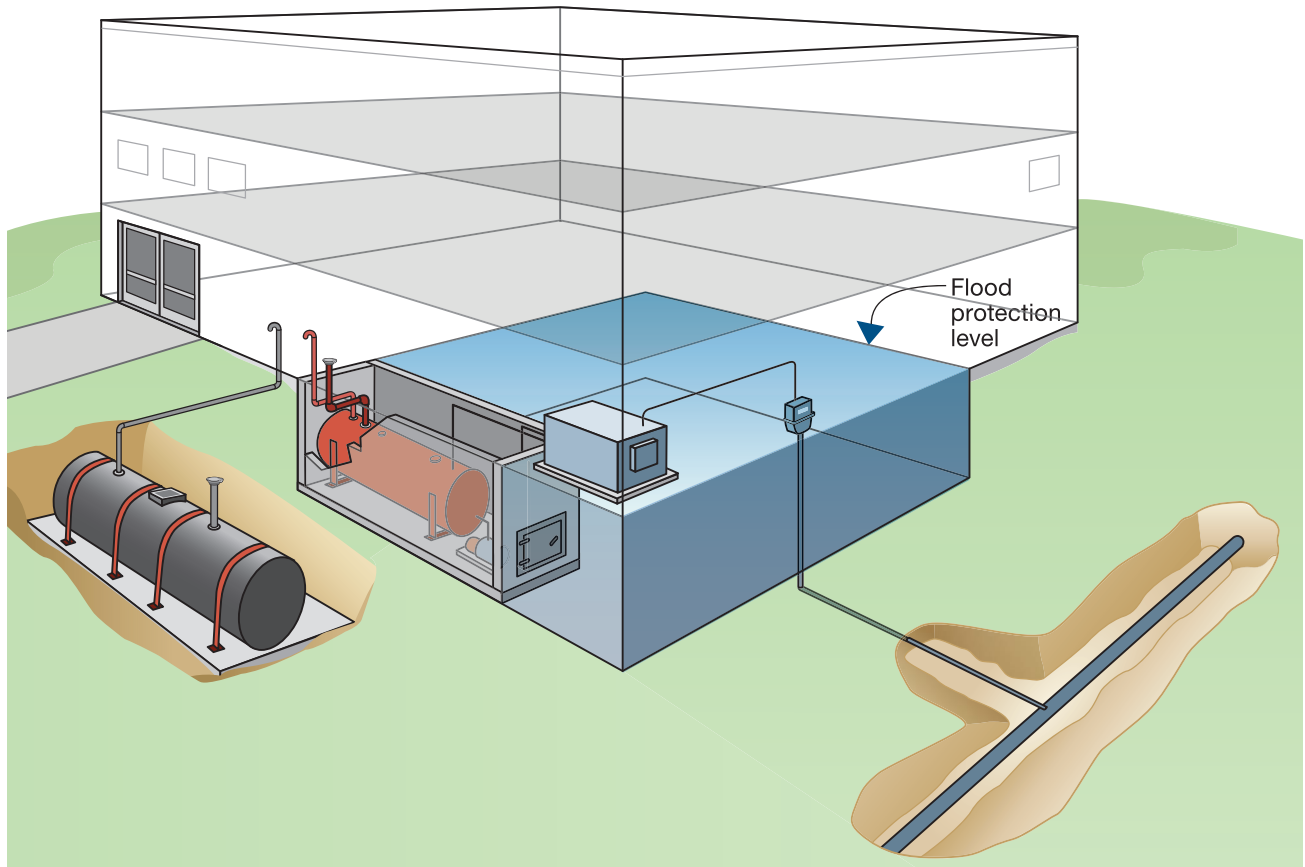

Figure 5-22. Fuel tank and fuel equipment protected within a flood-resistant vault.



Figure 5-23. Fuel tank placed in floodproof vault in basement of commercial high-rise (New York, NY).

Tanks and fuel system components exposed to moving floodwaters should, wherever possible, be elevated above the required flood protection level. When fuel system components must pass through areas exposed to moving floodwaters, they should be secured to resist flood forces, protected from flood-borne debris impact, and constructed with flood-resistant materials. Fuel system components should not be installed on breakaway walls.

5 MITIGATION MEASURES FOR NON-RESIDENTIAL BUILDINGS

In A Zones, tanks can be elevated on platforms, frames, or on structural fill. In V Zones and Coastal A Zones, structural fill is not allowed for tanks serving new construction or Substantially Improved non-residential buildings. When elevated, the tanks themselves will not be exposed to flood forces, but still need to be secured to the platform with straps or anchors to prevent movement from high winds or seismic events. In coastal zones, anchors should be made of corrosion-resistant materials to prevent damage from salt spray.

In V Zones and Coastal A Zones, the platform should be supported by posts or columns that are adequately designed for all loads including flood, wind and seismic. Bracing may be required to address loads from moving floodwater and structural redundancy may be appropriate to protect against debris impact. Figure 5-24 shows flood protection measures appropriate for components exposed to moving floodwater.

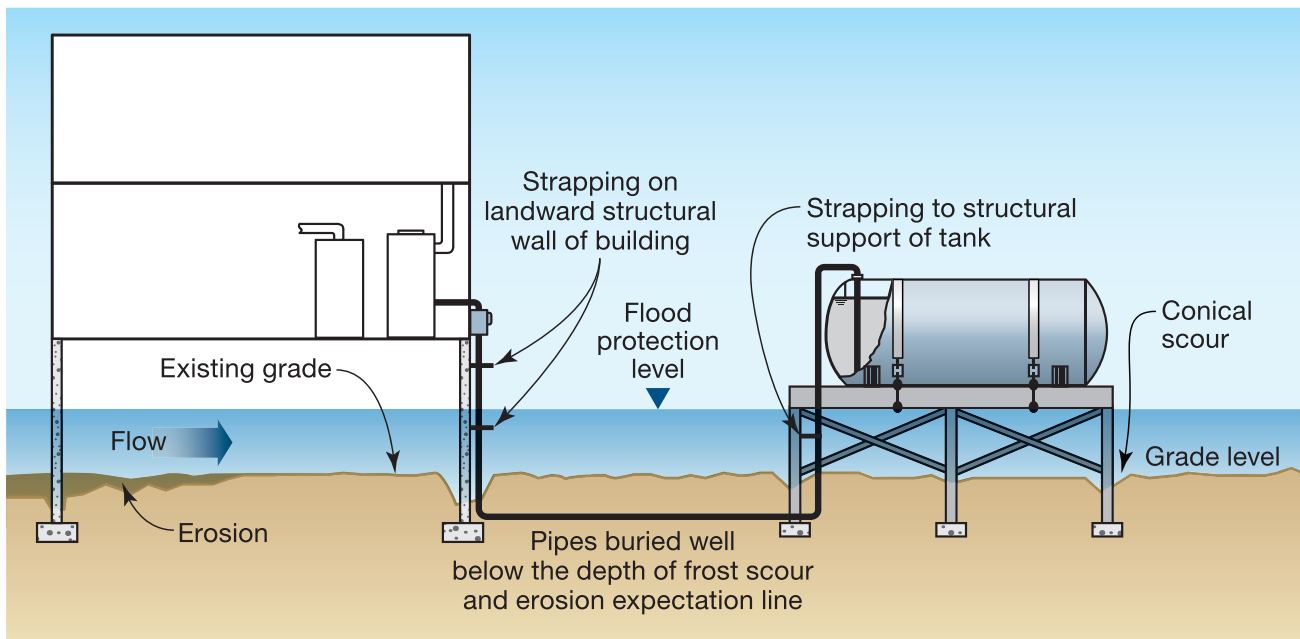

Figure 5-24. Protection of fuel system components exposed to moving floodwaters.

5.5 Conveyances – Elevators and Escalators

Elevators are the most common vertical conveyances found in non-residential and large residential buildings. All elevators include a cab or platform that moves along rails located within a shaft and are powered by one or more motors, as well as other equipment. The two primary types of elevators used for large residential and non-residential buildings are hydraulic elevators that push the elevator cab using a piston and traction elevators that hoist the cab using one or more cables. Hydraulic elevators are typically used in low-rise construction while traction elevators are most commonly installed in high-rise construction. The typical elements of non-residential hydraulic and traction elevators are shown in Figure 5-25.

In addition to elevators, non-residential buildings and public facilities may provide access between floors using escalators, which is a moving staircase consisting of a continuous chain of stairs on tracks connected in a loop. Escalators are powered by one or more motors and other equipment. Most escalators in non-residential buildings are located in the building's interior, and therefore can often be located above the flood protection level. However, many public facilities, such as transit stations, have indoor escalators located below the flood protection level, as well as outdoor escalators that can be directly exposed to flooding and other weather-related hazards. Typical elements of non-residential escalators are shown in Figure 5-26.

Table 5-6 provides a list of the typical elements of non-residential elevators and escalators and where they are addressed in this chapter. Note that, unlike most other systems discussed in this chapter, all conveyance system components are considered primary components.

Table 5-6. Typical elements of non-residential conveyances.

Conveyance Equipment Type (Subsection)	Components
Primary components - Elevators (5.5.1)	Elevator shafts and enclosures
	Elevator cabs and equipment
Primary components - Escalators (5.5.2)	Indoor escalators
	Outdoor escalators

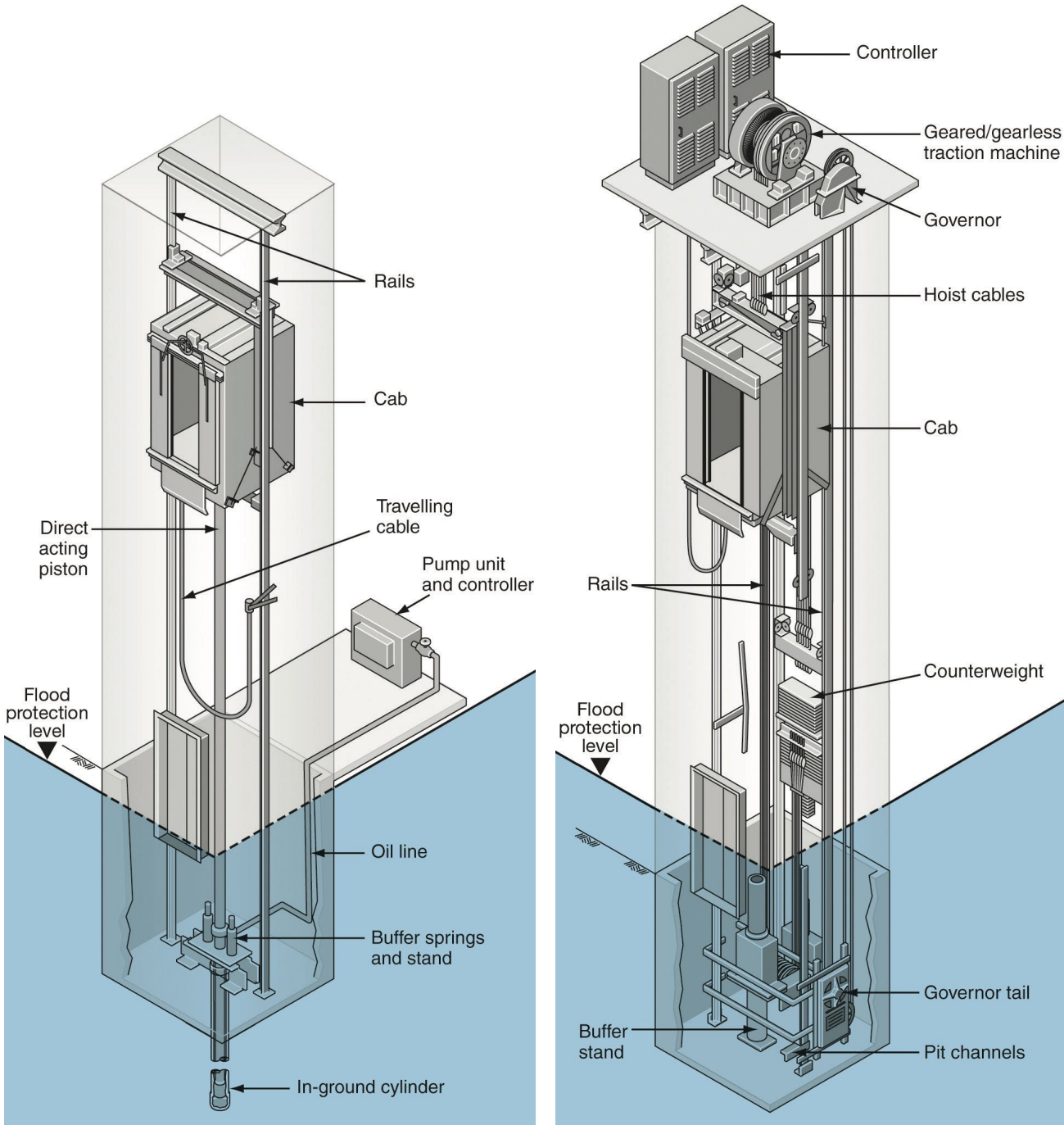

Figure 5-25. Typical elements of non-residential and large residential hydraulic elevators (left) and traction elevators (right) (Source: Otis Elevator Company).

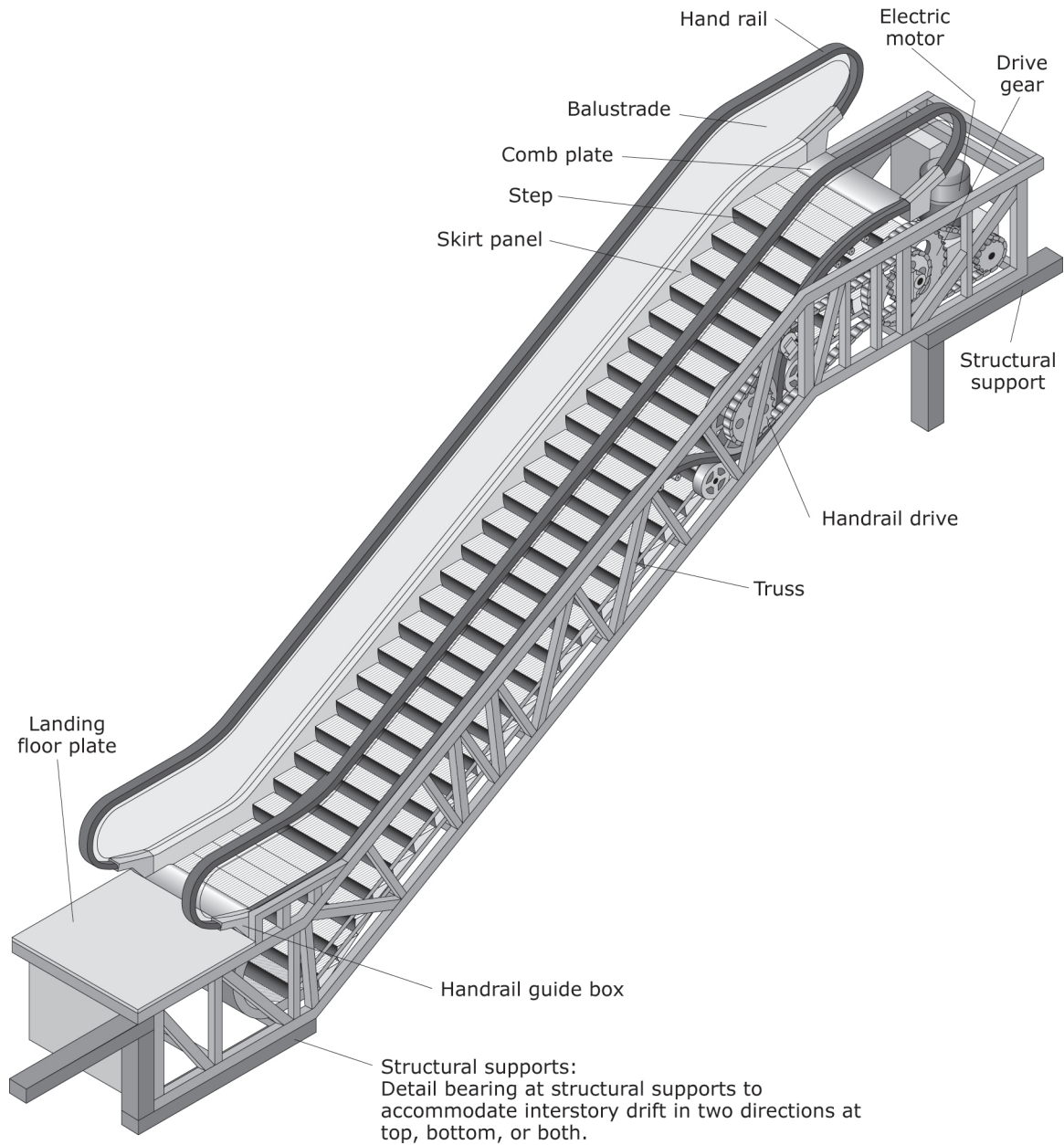

Figure 5-26. Typical elements of an escalator (Source: Otis Elevator Company).

5.5.1 Mitigation for Elevators

Flood mitigation strategies for protecting various components of elevator systems are described below.

Elevator shafts (enclosures): For low-rise elevators, particularly those added as a post-construction retrofit, shafts are usually installed independent of an outside wall. Most high-rise elevators are inside the structure. In either case, the shaft must have a landing, usually at the ground level, with a pit at a lower level that is almost always below the flood protection level. Since elevator shafts and enclosures below the flood protection level are not required to include hydrostatic openings or breakaway walls, they may obstruct the flow of floodwater, and are therefore highly susceptible to damage from various flood forces including erosion and scour below elevated buildings. Consequently, elevator enclosures must be designed to resist hydrodynamic and hydrostatic forces as well as erosion, scour, and waves, particularly in V Zones. TB 4 recommends that elevator shafts/enclosures extending below the flood protection level be constructed of flood damage-resistant materials such as reinforced masonry, block, or reinforced concrete walls, and be located on the landward side of the building to provide increased protection. Further, designs for nearby or adjacent structural elements of the building should take into account the impacts of obstructed flow in coastal and high-velocity riverine flood zones.

Elevator cabs and equipment: Some equipment common to all elevators will be damaged by floodwater unless protected. Perhaps most vulnerable is the elevator cab. Depending on the size of the cab and the interior materials used, elevator cabs can be expensive to replace. Flood damage to elevator cabs can be avoided by installing a detection system with one or more float switches in the elevator shaft to prevent the elevator cab from descending into floodwater (see Figure 5-27). Where possible, elevator equipment such as electrical controls and hydraulic pumps should be placed above the flood protection level. In some cases, it may be necessary to place elevator equipment such as switches and controls below the flood protection level in the elevator pit. If equipment must be located below the flood protection level, it should be protected using flood damage-resistant components. Any electrical equipment installed in the hoist way below the flood protection level should be in a NEMA Type 4-rated enclosure for water resistance. Some elevator equipment manufacturers offer water-resistant components; design professionals should contact suppliers to determine the availability of these components.



NOTE

For additional information on elevator systems and mitigation methods, refer to FEMA NFIP TB 4, *Elevator Installation for Buildings Located in Special Flood Hazard Areas in Accordance with the National Flood Insurance Program*, November 2010.

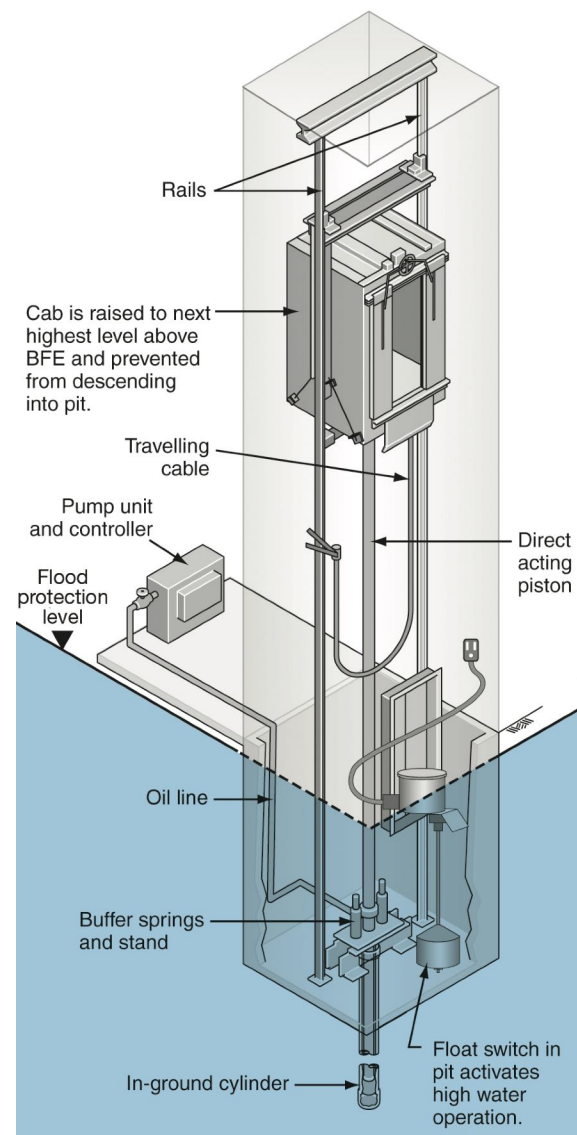

Figure 5-27. Float switch to control cab descent (Source: Otis Elevator Company).

Relocation for elevator systems: Relocation is another flood mitigation method to consider for elevator systems in large non-residential buildings and critical facilities such as hospitals, where vertical transportation is essential to support continued operations. Relocation involves raising one or more elevators in a building so that the shaft landing terminates on a higher floor that is above the flood protection level, with the elevator pit floor and equipment also raised above the flood protection level. When supported by an elevated emergency power system, relocated elevators can continue to provide service during a flood that disables other elevators in the building. Stairs or ramps may be used to access the newly elevated lowest floor. This mitigation method was adopted by some New York City hospitals after their elevator systems were inundated by Hurricane Sandy in 2012 (see Figure 5-28).



NOTE

For additional information on elevator system damage to high-rise residential buildings and critical facilities, refer to FEMA's Mitigation Assessment Team Report, FEMA P-942, *Hurricane Sandy in New Jersey and New York*, November 2013. <https://www.fema.gov/media-library/assets/documents/85922>.



Figure 5-28. Hydraulic elevator in New York City hospital flooded during Hurricane Sandy.

5.5.2 Mitigation for Escalators

Most components for indoor escalators located in non-residential buildings can be located above the flood protection level. Similarly, outdoor escalators and their components that are exposed to the elements, but are located above the flood protection level can be constructed of flood-resistant materials that are connected to pumps so as to limit the entry of runoff into escalator landings. However, facilities with indoor or outdoor escalators that are installed below the flood protection level will have equipment that cannot be elevated above this level, and thus will remain exposed to potential flood damage. In this case, placement of equipment below the flood protection level should be minimized. These escalators should be designed and constructed in a way that facilitates repair and component restoration after flooding.



Appendix A – FEMA Assistance

FEMA assistance is available to help property owners implement flood retrofitting projects. The sources of the assistance are the Increased Cost of Compliance (ICC) coverage in Standard Flood Insurance Policies from the National Flood Insurance Program (NFIP) (see Section A.1), FEMA’s Hazard Mitigation Assistance (HMA) Programs (see Section A.2), and Section 406 Hazard Mitigation funding under the Public Assistance (PA) Program (see Section A.3). Resources on FEMA funding are listed in Section A.4.

A.1 Increased Cost of Compliance Coverage

Property owners who have Standard Flood Insurance Policies for buildings in Special Flood Hazard Areas (SFHAs) are eligible to receive up to \$30,000 (as of April 2016) to bring the building into compliance with State or local floodplain laws or ordinances and building code requirements. The building must have substantial or repetitive flood damage to be eligible for ICC funds. ICC coverage can be used for elevating, relocating, and demolishing residential and non-residential buildings, or floodproofing a non-residential building.

ICC claims are adjusted separately from flood damage claims filed under the Standard Flood Insurance Policy. ICC coverage is provided in all new and renewed Standard Flood Insurance Policies in the NFIP.

An ICC claim may be paid if the property is determined to be Substantially Damaged by a State or local official or a repetitive loss property, which are defined as follows:

- **Substantially Damaged.** The cost of repairing flood damage equals or exceeds 50 percent of the building’s pre-damage market value.
- **A repetitive loss property.** At least two losses in 10 years have occurred in which the cost of repair, on average, equaled or exceeded 25 percent of the building’s market value at the time of each flood.



NOTE

For more information on ICC coverage, see FEMA P-301, *NFIP Increased Cost Compliance (ICC) Coverage* (FEMA 2003). <http://www.fema.gov/media-library/assets/documents/1973>

Additionally, the State or community must have a cumulative Substantial Damage provision or repetitive loss provision in its floodplain management law or ordinance being enforced against the structure to be eligible for an ICC claim payment.

A.2 FEMA’s Hazard Mitigation Assistance Programs

FEMA’s HMA Programs present a critical opportunity to reduce the risk to individuals and property from natural hazards while simultaneously reducing reliance on Federal disaster funds. The programs are authorized by Section 404 of the Robert T. Stafford Disaster Relief and Emergency Assistance Act of 1988, as amended (Title 42, United States Code [U.S.C.] 5170c), Section 203 of the Stafford Act, 42 U.S.C. 5133 and Section 1366 of the National Flood Insurance Act of 1968, as amended (42 U.S.C. 4104c). All programs are subject to changes in statutory requirements and amounts of authorized assistance.

All mitigation projects must be cost-effective, cost reasonable and technically feasible and meet Environmental Planning and Historic Preservation requirements in accordance with HMA Program requirements. States, territories, federally recognized Indian tribal governments, and communities are eligible and encouraged to take advantage of funding provided by the following HMA Programs in both the pre- and post-disaster time frames:

- **Hazard Mitigation Grant Program (HMGP).** Provides grants for long-term hazard mitigation measures after a major disaster declaration in a given State. The purpose of HMGP is to reduce the loss of life and property as a result of natural disasters and to enable the implementation of mitigation measures during the recovery from a disaster.
- **Pre-Disaster Mitigation (PDM) Program.** Provides nationally competitive grants for hazard mitigation planning and implementing mitigation projects before a disaster event. Funding the plans and projects reduces the risk to people and property and the reliance on funding that is authorized after a Presidential disaster declaration to rebuild.
- **Flood Mitigation Assistance (FMA) Program.** Provides grants for certain flood mitigation projects to reduce or eliminate flood risk to buildings, manufactured homes, and other buildings that are currently NFIP insured. The National Flood Insurance Fund (NFIF) provides the funding for the FMA program.



NOTE

For more information on FEMA Hazard Mitigation Assistance programs, see <http://www.fema.gov/hazard-mitigation-assistance>.

HMGP is available, when authorized under a Presidential major disaster declaration, in the areas of the State requested by the Governor. The PDM and FMA programs are subject to the availability of appropriation funding, as well as any program-specific directive or restriction made with respect to such funds. Table A-1 is a summary of the flood mitigation projects related to building utility systems that are eligible for funding under HMA Programs.

Figure A-1 shows the process for FEMA grant applications and approvals. The process is divided into five stages, starting with mitigation planning and ending with project closeout. The process requires coordination among FEMA, the State, and the local government. The coordination is represented by the three rings in the figure. Regardless of which HMA Program the funds will come from, the FEMA grants cycle process includes the five stages shown in Figure A-1 and described in Sections A.2.1 through A.2.5.

A.2.1 Stage 1: Mitigation Planning

All project grant applications require a State or tribal multi-hazard mitigation plan. The plan must describe the process for identifying the hazard risks in a community and the actions that will help reduce the risks. Non-residential flood mitigation projects that are proposed for FEMA funding under HMA Programs must be consistent with the State’s or tribe’s mitigation plan. The mitigation planning process requires public participation and the identification of measures to reduce risks and is therefore a good opportunity for property owners to address concerns about flood hazards. More information is available at <http://www.fema.gov/hazard-mitigation-planning-overview>.

Table A-1. Flood Mitigation Projects Eligible for Funding Under HMA Programs.

Eligible Activities	HMA Programs		
	HMGP	PDM	FMA
Dry Floodproofing of Historic Residential Structures	✓	✓	✓
Dry Floodproofing of Non-Residential Structures	✓	✓	✓
Generators	✓	✓	
Structural Retrofitting of Existing Buildings	✓	✓	✓
Non-structural Retrofitting of Existing Buildings and Facilities	✓	✓	✓

SOURCE: Unified Hazard Mitigation Assistance Guidance (FEMA, 2015). Refer to the current fiscal year’s HMA Guidance for current eligibility requirements when referencing this table.

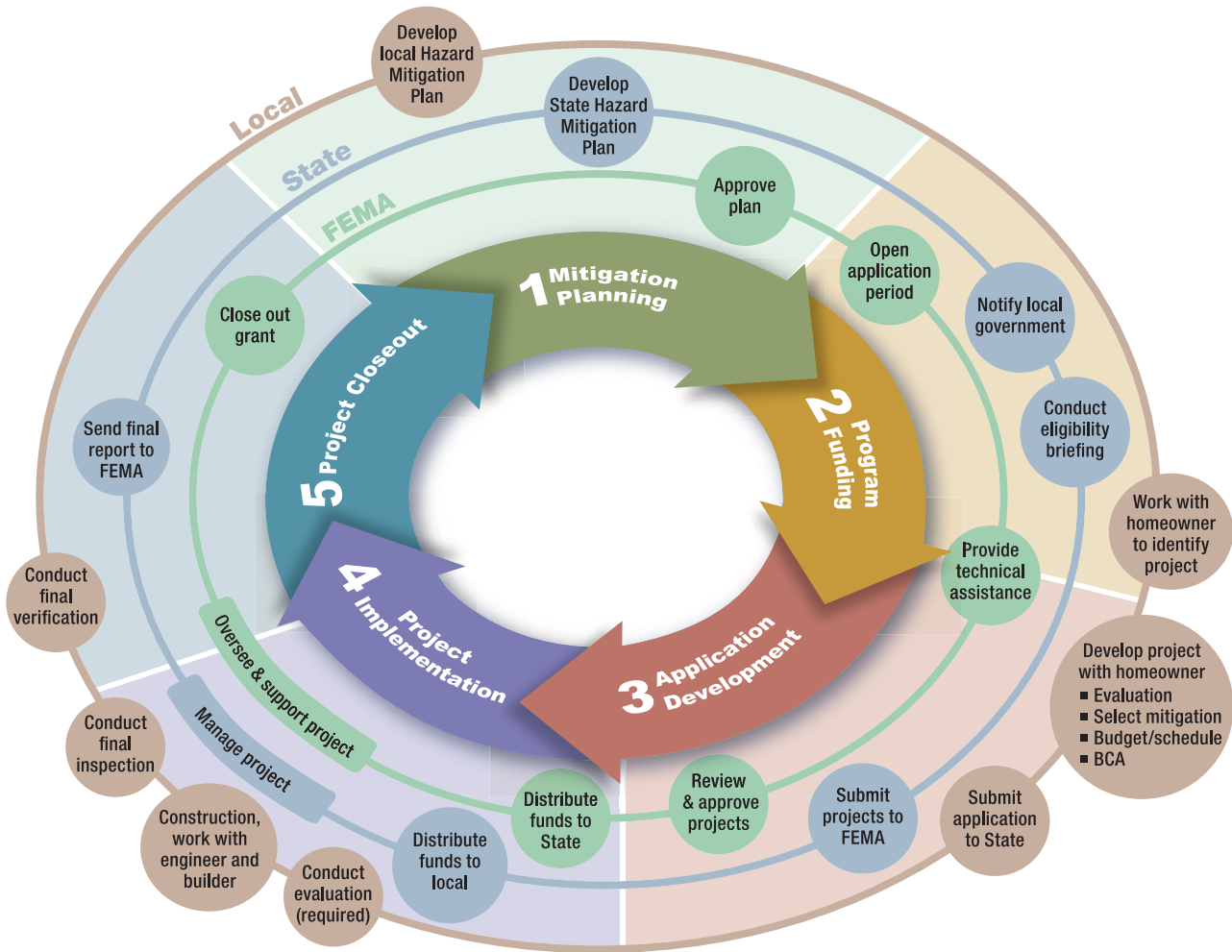

Figure A-1. HMA grants cycle process and the roles and responsibilities of FEMA and State and local governments.

A.2.2 Stage 2: Program Funding

HMA Programs enable hazard mitigation measures to be implemented before, during, and after disasters. Funding depends on the availability of appropriation funding or is based on disaster recovery expenditures, as well as any directive or restriction made with respect to such funds. HMGP funding depends on Federal assistance provided for disaster recovery following a Presidential disaster declaration in a State, and PDM and FMA funding may be authorized annually by Congress.

When the application period opens, the State notifies local governments of the availability of funds and relays information about the application process, project requirements, and eligibility criteria for the local government. Table A-2 shows the cost-share requirements for the HMA Programs. Property owners should work with their local governments to express interest in participating in a flood mitigation project; the local government can then submit a subapplication to the State and request HMA funding. In general, the community applying for the grant must participate in the NFIP. Eligible subapplicants include State agencies, Indian tribal governments, local governments and communities, and private non-profit organizations.

Table A-3 lists the eligibility of subapplicants for HMA Program grant funding.

Table A-2. Cost-Share Requirements for the HMA Program Grants.

HMA Program	Subcategory	Cost Share Requirements (% Federal/Non-Federal Share)		
		Mitigation Activity	Recipient Management Costs	Subrecipient Management Costs
HMGP	All subrecipients	75/25	100/0	-/. ¹
PDM	General subrecipients	75/25	75/25	75/25
	Subrecipient is small and impoverished community	90/10	75/25	90/10
	Tribal Recipient/subrecipient is small and impoverished	90/10	90/10	90/10
FMA	Insured properties and planning grants	75/25	75/25	75/25
	Repetitive loss property ²	90/10	90/10	90/10
	Severe repetitive loss property ²	100/0	100/10	100/10

SOURCE: Unified Hazard Mitigation Assistance Guidance (FEMA, 2015). Refer to the current fiscal year’s HMA Unified Guidance for current ratios when referencing this table.

1. Subapplicants should consult their State Hazard Mitigation Officer (SHMO) for the amount or percentage of **HMGP** subrecipient management cost funding their State has determined to be passed through to subrecipients.
2. To be eligible for an increased Federal cost share, a FEMA-approved State or Tribal (Standard or Enhanced) Mitigation Plan that addresses repetitive loss properties must be in effect at the time of award, and the property that is being submitted for consideration must be a repetitive loss property.

Table A-3. Eligibility of Subapplicants for HMA Program Grants.

Entity	HMA Programs		
	HMGP	PDM	FMA
State agencies	✓	✓	✓
Federally-recognized tribes	✓	✓	✓
Local governments/communities ¹	✓	✓	✓
Private nonprofit organizations (PNPs)	✓		

SOURCE: Unified Hazard Mitigation Assistance Guidance (FEMA, 2015). Refer to the current fiscal year’s HMA Unified Guidance for current eligibility of subapplicants when referencing this table.

1. Local governments/community may include non-federally recognized tribes, or consistent with definition of local government at 44 CFR 201.2, may include any Indian tribe or authorized tribal organization, or Alaska Native village or organization that is not federally recognized per 25 U.S.C. 479a et seq.

A.2.3 Stage 3: Application Development

Businesses cannot apply for HMA funds, so the non-residential property owner must work with the local government to develop a project subapplication on behalf of the owner. Local governments may submit a retrofit project for a property as an individual subapplication or combine it with other projects as part of an aggregate subapplication (subject to program restrictions). Aggregating benefit and cost values is allowed for multiple buildings if they are all vulnerable to damage from similar hazard conditions. See the current version of the *HMA Unified Guidance* (periodically updated) for information on aggregating projects in one subapplication.

Key elements for non-residential flood mitigation applications are:

- Identification of the property to be mitigated.
- Identification of key project personnel and roles, such as design professional and contractor.
- Selection of an eligible project (see Table A-1).
- Inspection of the building by a registered design professional to verify that the project can be implemented if possible; if not done at this stage; it must be done during Stage 4, Project Implementation (see Section A.2.4).
- Development of a project cost estimate and work schedule.
- Benefit-Cost Analysis (BCA) using FEMA's BCA software (see Appendix B for additional information); if the benefit-cost ratio (BCR) is 1.0 or more, the project is cost-effective. FEMA requires a BCR of 1.0 or greater for funding.
- Verification that properties in designated SFHAs will obtain flood insurance and that the insurance will be recorded on the property deed.

The local government submits the subapplication to the State. The State then selects projects based on its priorities and submits applications to FEMA for review. FEMA reviews the projects for eligibility, completeness, engineering feasibility, cost-effectiveness, cost reasonableness, and environmental and historic preservation documentation. The review process also confirms that all hazard mitigation activities adhere to all relevant statutes; regulations; program requirements, including other applicable Federal, State, tribal, and local laws; implementing regulations; and Executive Orders, all of which are detailed in the grant program guidance. The most current version of the guidance can be found at the FEMA HMA website (<http://www.fema.gov/hazard-mitigation-assistance>).

Once FEMA approves a project and awards the grant, the State distributes the funds to the local government, which distributes it to individuals as appropriate. No construction activities should begin until after the money has been awarded because HMA funding is not available for activities initiated or completed prior to award or final approval.

A.2.4 Stage 4: Project Implementation

After the State has awarded the funds to the local government, the next stage is project implementation. HMA projects must be completed within a specified period of time (the period of performance), which is normally not more than 36 months. During the period of performance, the local government must maintain a record of work and expenditures for the quarterly reports that the State submits to FEMA.

Because the final design may not be completed prior to award, once the project is awarded, the design must be finalized by a registered design professional with some exceptions. If the scope of work or cost estimate changes as a result of completing the final design, the HMA Unified Guidance should be consulted for direction on scope of work modifications. If there is already a final design when the grant is awarded, the subgrantee can proceed with the appropriate contracting procurement procedures to secure the services of a contractor to execute the requirements in the design and grant documents.

Some grant projects do not require the services of a design professional. In these circumstances, once the grant is awarded, the subgrantee can proceed with appropriate contracting procurement procedures to secure the services of a contractor to execute the requirements in the contract documents necessary to perform the work in the approved grant.

To summarize, the basic steps in implementing an approved HMA mitigation flood retrofit grant project are:

1. If a design was not developed before Stage 3, secure a registered design professional to design, inspect, and sign off on a mitigation retrofit solution within the bounds of the approved grant.
2. If a design solution was developed before Stage 3 or if a registered design professional is not needed because of the nature of the work, secure the services of a contractor to execute the work in the approved grant.
3. Monitor the work being performed to ensure that all grant requirements are being met.
4. Inspect the finished project and verify that all grant requirements have been met. Work with the designer /contractor to resolve any issues of concern and work with the State in closing out the grant after all requirements have been met.

A.2.5 Stage 5: Project Closeout

When the grant project has been completed, a registered design professional (preferably the same one as above) should conduct a final inspection and verify in writing that the project he or she designed/signed off on was implemented as intended in the approved grant. If a contractor was the only professional who performed the work, the contractor should verify in writing that he or she performed the work as outlined in the contract and the grant. It is crucial for the subgrantee to ensure that the grant requirements have been met through any contracts the subgrantee has with design professionals or contractors because the subgrantee is ultimately responsible for meeting the grant requirements. Poorly written contracts can result in work that complies with the contract but is noncompliant with the grant requirements. The written verification of the work performed along with other project documentation demonstrating grant compliance will help facilitate a smooth, efficient project closeout.

After obtaining project verification from the designer/contractor, the subgrantee then submits the grant project documentation to the State. The State verifies that the work was completed in accordance with the approved grant documentation, including the grant scope of work, and performs the closeout procedures. If the property is in a SFHA, the local government must provide documentation of flood insurance for the property and a copy of the recorded deed amendment. The HMA Unified Guidance contains a description of all closeout requirements that must be addressed.

A.3 The Public Assistance Program and Section 406 Hazard Mitigation Funding

The Public Assistance (PA) Program is a grant program authorized by the Robert T. Stafford Disaster and Emergency Assistance Act (the Stafford Act) to make funding available for response and recovery efforts after the President has declared a disaster or emergency.

After the declaration is made, FEMA determines which locations are eligible for assistance under which categories of work. Eligible disaster-related work, which is either emergency or permanent work, is divided into seven categories, as listed below. The first two categories are emergency work, and the other categories are permanent work.



NOTE

More information on the Stafford Act and Section 406 is available at: <https://www.fema.gov/95261-hazard-mitigation-funding-under-section-406-stafford-act>.

- Category A: Debris Removal (Emergency Work)
- Category B: Emergency Protective Measures (Emergency Work)
- Category C: Roads and Bridges (Permanent Work)
- Category D: Water Control Facilities (Permanent Work)
- Category E: Buildings and Equipment (Permanent Work)
- Category F: Utilities (Permanent Work)
- Category G: Parks, Recreational Facilities, and Other Items (Permanent Work)

Entities that are eligible to apply for PA funding are limited to State agencies, local governments, private nonprofit organizations (which must meet stringent requirements to be determined eligible), and federally recognized Indian tribes or authorized tribal organizations and Alaskan Native village organizations.

Under the PA Program, the FEMA/State cost share is usually 75 percent/25 percent, although the cost share is subject to change based on the severity of the disaster. Applicants are reimbursed for eligible costs under the categories of work that FEMA has determined eligible for reimbursement under that specific disaster declaration.

The PA Program has a required focus on restoring damaged infrastructure to its pre-disaster function and capacity. Section 406 of the Stafford Act allows funding of mitigation measures that go beyond restoring a facility to its pre-disaster condition and is applied only to the damaged element of the facility. Mitigation measures must be cost-effective, cost reasonable, technically feasible and meet Environmental Planning and Historic Preservation requirements in accordance with Federal laws, regulations, and Executive Orders and must reduce the risk of damage from future similar events to be eligible for Section 406 funding.

Only projects involving permanent work are eligible for Section 406 hazard mitigation funding. Hazard mitigation measures under Section 406 are considered part of the total eligible cost of the repair, restoration, reconstruction, or relocation of a facility. Funding under Section 406 is not applicable to alternate or improved projects if a new replacement facility is involved. Upgrades to meet applicable codes and standards are also not eligible under Section 406 funding because they are not mitigation measures and may be an eligible part of restoration work under the PA Program. Examples of eligible Section 406 mitigation measures related to building utility systems (Category E) and utility facilities (Category F) include:

- Elevation of utility equipment and controls including building utility system components
- Dry floodproofing of building utility system components in accordance with NFIP regulations
- Wet floodproofing of building utility system components in accordance with NFIP regulations where dry floodproofing is not feasible
- Anchoring fuel tanks
- Protection of utilities

Hazard mitigation measures submitted under Section 406 are reviewed by FEMA to ensure eligibility, technical feasibility, environmental and historical compliance, and cost effectiveness. When the project has passed all reviews, FEMA obligates the funds, and the State ensures that the funds are distributed to PA Program applicants in accordance with State laws.

A.4 FEMA Assistance Resources

Table A-4 provides a summary of FEMA assistance resources and links.

Table A-4. Summary of FEMA assistance resources.

FEMA Assistance Resources	Resource Links
Benefit-Cost Analysis Helpline	Telephone: (855) 540-6744 E-mail: bchelpline@fema.dhs.gov
Building Science Helpline	Telephone: (866) 927-2104 E-mail: FEMA-BuildingscienceHelp@fema.dhs.gov
Environmental Planning and Historic Preservation	http://www.fema.gov/environmental-planning-and-historic-preservation-program
Flood Mitigation Assistance Program	http://www.fema.gov/flood-mitigation-assistance-program
Hazard Mitigation Grant Program	http://www.fema.gov/hazard-mitigation-grant-program
Hazard Mitigation Assistance Policies	http://www.fema.gov/hazard-mitigation-assistance-grants-policy
Hazard Mitigation Assistance Helpline	Telephone: (866) 222-3580 E-mail: hmagrantshelpline@dhs.gov
HMA overview; includes link to the current HMA Unified Guidance	http://www.fema.gov/hazard-mitigation-assistance
Increased Cost of Compliance; includes a link to FEMA 301, NFIP Increased Cost Compliance Coverage (FEMA 2003)	http://www.fema.gov/increased-cost-compliance-coverage http://www.fema.gov/media-library/assets/documents/1973
Mitigation Planning	http://www.fema.gov/hazard-mitigation-planning-process
Pre-Disaster Mitigation	https://www.fema.gov/pre-disaster-mitigation-grant-program



Appendix B – References

ASCE (American Society of Civil Engineers). 2014. *Flood Resistant Design and Construction*. ASCE Standard 24-14.

ASCE. 2010. *Minimum Design Loads for Buildings and Other Structures*. ASCE/SEI Standard 7-10.

AWC (American Wood Council). 2015. *Wood Frame Construction Manual for One- and Two-Family Dwellings (WFCM)*. ANSI/AWC WFCM-2015.

FEMA. 2003. *NFIP Increased Cost Compliance (ICC) Coverage: Guidance for State and Local Officials*. FEMA P-301. Available at <http://www.fema.gov/media-library/assets/documents/1973>.

FEMA. 2006. *Hurricane Katrina in the Gulf Coast: Mitigation Assessment Team Report*. FEMA 549. Available at <https://www.fema.gov/media-library/assets/documents/4069>.

FEMA. 2008a. *Flood Damage-Resistant Materials Requirements for Buildings Located in Special Flood Hazard Areas in Accordance with the National Flood Insurance Program*. NFIP Technical Bulletin 2. Available at <http://www.fema.gov/media-library/assets/documents/2655>.

FEMA. 2009a. *Mitigation Assessment Team Report: Hurricane Ike in Texas and Louisiana*. FEMA P-757. Available at <https://www.fema.gov/media-library/assets/documents/15498>.

FEMA. 2009b. *National Flood Insurance Program Regulations*. FEMA F-775. Available at <http://www.fema.gov/media-library/assets/documents/18184>.

FEMA. 2010a. *Elevator Installation for Buildings Located in Special Flood Hazard Areas in Accordance with the National Flood Insurance Program*. NFIP Technical Bulletin 4. Available at <https://www.fema.gov/media-library/assets/documents/3478>.

FEMA. 2010b. *Home Builder's Guide to Coastal Construction: Technical fact Sheet Series*. FEMA P-499. Available at <https://www.fema.gov/media-library/assets/documents/6131>.

FEMA. 2010c. *Substantial Improvement/Substantial Damage Desk Reference*. FEMA P-758. Available at <http://www.fema.gov/media-library/assets/documents/18562>.

B REFERENCES

- FEMA. 2011c. *Coastal Construction Manual: Principles and Practices of Planning, Siting, Designing, Construction, and Maintaining Residential Buildings in Coastal Areas* (Fourth Edition). FEMA P-55. Available at <http://www.fema.gov/media-library/assets/documents/3293>.
- FEMA. 2012a. *Engineering Principles and Practices of Retrofitting Flood-Prone Residential Structures* (Third Edition). FEMA P-259. Available at <http://www.fema.gov/media-library/assets/documents/3001>.
- FEMA. 2012b. *Reducing the Risks of Nonstructural Earthquake Damage – A Practical Guide*. FEMA E-74. Available at <https://www.fema.gov/media-library/assets/documents/21405>.
- FEMA. 2013a. *Floodproofing Non-Residential Buildings*. FEMA P-936. Available at <https://www.fema.gov/media-library/assets/documents/34270>.
- FEMA. 2013b. *Mitigation Assessment Team Report: Hurricane Sandy in New Jersey and New York*. FEMA P-942. Available at <https://www.fema.gov/media-library/assets/documents/85922>.
- FEMA. 2014a. *Emergency Power Systems for Critical Facilities: A Best Practices Approach to Improving Reliability*. FEMA P-1019. Available at <https://www.fema.gov/media-library/assets/documents/101996>.
- FEMA. 2014b. *Reducing Flood Losses through the International Codes: Coordinating Building Codes and Floodplain Management Regulations* (Fourth Edition). Available at <https://www.fema.gov/media-library/assets/documents/96634>.
- FEMA. 2015. *Hazard Mitigation Assistance Guidance: Hazard Mitigation Grant Program, Pre-Disaster Mitigation Program, and Flood Mitigation Assistance Program*. Available at <http://www.fema.gov/hazard-mitigation-assistance-program-guidance>.
- FEMA. 2016a. *Flood Map Service Center (MSC)*. Available at <http://msc.fema.gov/portal>.
- FEMA. 2016b. *National Flood Insurance Program Flood Insurance Manual*. Available at <http://www.fema.gov/flood-insurance-manual>.
- IAMPO (International Association of Plumbing and Mechanical Officials). 2015. *Uniform Mechanical Code (UMC)*. Published by IAMPO.
- IAMPO. 2015. *Uniform Plumbing Code (UPC)*. Published by IAMPO.
- IAMPO. 2015. *Uniform Solar Energy Code (USEC)*. Published by IAMPO.
- IAMPO. 2015. *Uniform Swimming Pool, Spa and Hot Tub Code (USPSHTC)*. Published by IAMPO.
- IBC. 2015. *International Building Code*. Published by the International Code Council.
- IEBC. 2015. *International Existing Building Code*. Published by the International Code Council.
- IFGC. 2015. *International Fuel Gas Code*. Published by the International Code Council.
- IMC. 2015. *International Mechanical Code*. Published by the International Code Council.

- IPC. 2015. *International Plumbing Code*. Published by the International Code Council.
- IPSDC. 2015. *International Private Sewage Disposal Code*. Published by the International Code Council.
- IRC. 2015. *International Residential Code*. Published by the International Code Council.
- ISPSC. 2015. *International Swimming Pool and Spa Code*. Published by the International Code Council.
- NIOSH (National Institute for Occupational Safety & Health). 2010. *Recommendations for the Cleaning and Remediation of Flood-Contaminated HVAC Systems: A Guide for Building Owners and Managers*. Available at <http://www.cdc.gov/niosh/topics/emres/cleaning-flood-hvac.html>.
- NFPA (National Fire Protection Association). 2014. *National Electric Code (NEC)*. NFPA 70.
- NFPA. 2015c. *Building Construction and Safety Code*. NFPA 5000.
- NFPA. 2015b. *Flammable and Combustible Liquids Code*. NFPA 30.
- NWS (National Weather Service). 2015. *National Oceanic and Atmospheric Administration's Hydrologic Information – Flood Loss Data*. Available at <http://www.nws.noaa.gov/hic/>.
- U.S. Global Change Research Program. 2014. *Third National Climate Assessment: Climate Change Impacts in the United States*. Available at <http://nca2014.globalchange.gov/>.



Appendix C – Resources

FEMA Hazard Mitigation Assistance (HMA) Programs	
Benefit-Cost Analysis	http://www.fema.gov/benefit-cost-analysis
Environmental Planning and Historic Preservation	http://www.fema.gov/environmental-planning-and-historic-preservation-program
Flood Mitigation Assistance Program	http://www.fema.gov/flood-mitigation-assistance-program
Hazard Mitigation Assistance Overview	http://www.fema.gov/hazard-mitigation-assistance
Hazard Mitigation Assistance policies	http://www.fema.gov/hazard-mitigation-assistance-policy
Hazard Mitigation Grant Program	http://www.fema.gov/hazard-mitigation-grant-program
Increased Cost of Compliance coverage	http://www.fema.gov/national-flood-insurance-program-2/increased-cost-compliance-coverage
Pre-Disaster Mitigation Program	http://www.fema.gov/pre-disaster-mitigation-grant-program
FEMA Building Science Publications and Other Resources	
Community Rating System	http://www.fema.gov/national-flood-insurance-program/community-rating-system
Community Rating System Resource Center	http://training.fema.gov/EMIWeb/CRS/
FEMA Building Science Branch	http://www.fema.gov/building-science
FEMA Library	https://www.fema.gov/resource-document-library
FEMA P-787, Catalog of FEMA Flood and Wind Publications, and Training Courses	http://www.fema.gov/media-library/assets/documents/12909
Flood Insurance Studies	http://www.fema.gov/national-flood-insurance-program-2/flood-insurance-study-fis
Flood Insurance Rate Maps	http://www.fema.gov/national-flood-insurance-program-2/flood-insurance-rate-map-firm
Information and Guidance on Building Safer	http://www.fema.gov/safer-stronger-protected-homes-communities
Map Service Center	http://msc.fema.gov/
Mitigation	http://www.fema.gov/what-mitigation
Mitigation Assessment Team Reports	http://www.fema.gov/fema-mitigation-assessment-team-reports
National Flood Insurance Program	http://www.fema.gov/national-flood-insurance-program
National Flood Insurance Program Technical Bulletins	http://www.fema.gov/national-flood-insurance-program-2/nfip-technical-bulletins
National Preparedness Directorate National Training and Education	http://www.training.fema.gov/

Building Codes and Standards	
American Society of Civil Engineers Publications	http://www.asce.org/publications/
American Society for Testing and Materials	http://www.astm.org
American Wood Council	http://www.awc.org/codes-standards
International Association of Plumbing and Mechanical Officials	http://codes.iapmo.org/
International Code Council: Codes and Standards	http://www.iccsafe.org/
National Fire Protection Association	http://www.nfpa.org/codes-and-standards
National Institute for Occupational Safety & Health	http://www.cdc.gov/niosh/pubs/
Building Utility Industry Resources	
Air-Conditioning, Heating, and Refrigeration Institute	http://www.ahrinet.org/
American Society of Heating, Refrigerating and Air-Conditioning Engineers	https://ashrae.org/
National Electrical Manufacturers Association	http://www.nema.org/
Plumbing-Heating-Cooling Contractors Association	http://www.phccweb.org/
Other Resources	
Flood Mitigation News	http://www.floodmitigation.com/
National Oceanic and Atmospheric Administration's National Weather Service	http://www.nws.noaa.gov/
Natural Resource Conservation Service Soils website	http://soils.usda.gov/
Natural Resource Conservation Service Technical Resource Library	http://www.nrcs.usda.gov/technical/
National Weather Service Precipitation Frequency Studies	http://www.nws.noaa.gov/oh/hdsc/currentpf.htm
Susquehanna Flood Forecast and Warning System	http://www.susquehannafloodforecasting.org/current-conditions.html#river-forecasts
U.S. Army Corps of Engineers Library	http://www.publications.usace.army.mil/
U.S. Department of Housing and Urban Development	http://portal.hud.gov/portal/page/portal/HUD
State and Regional Contacts	
Association of State Floodplain Managers	http://www.floods.org/
Federal Emergency Management Agency	https://www.fema.gov/
National Flood Insurance Program	https://www.fema.gov/national-flood-insurance-program-bureau-statistical-agent-regional-support-offices
State Hazard Mitigation Officers	http://www.fema.gov/state-hazard-mitigation-officers
State Historic Preservation Offices	http://www.nps.gov/nr/shpolist.htm
U.S. Army Corps of Engineers	http://www.usace.army.mil/



Appendix D – FEMA Offices

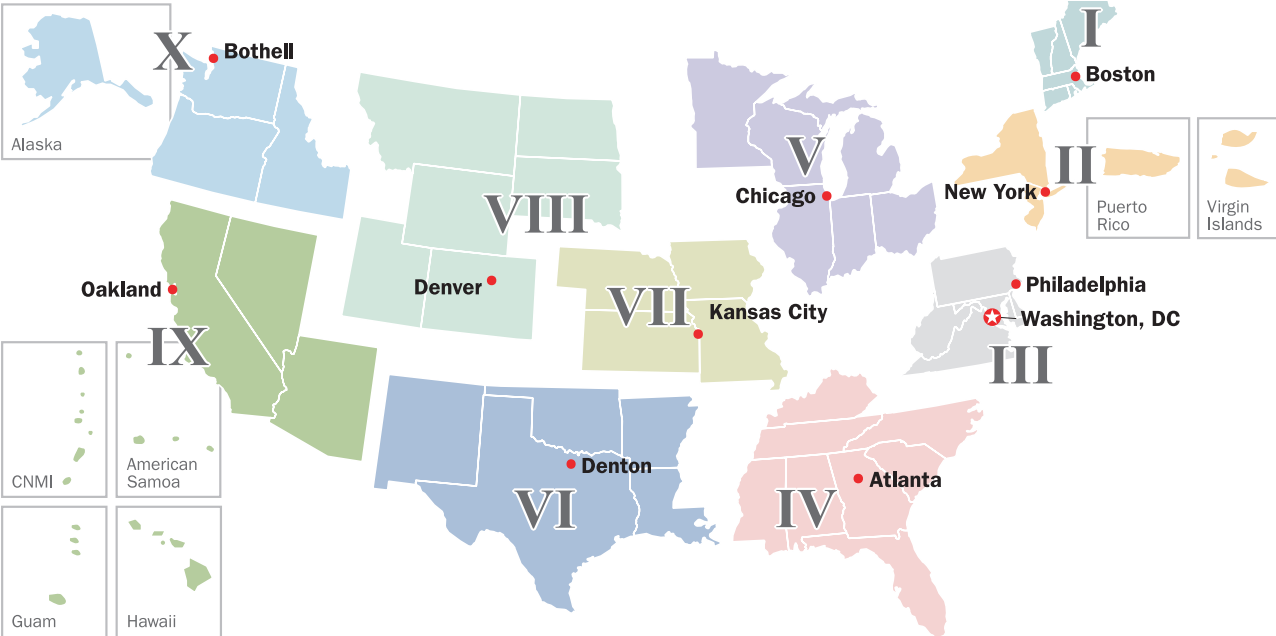

Figure D-1. FEMA Regions and Locations of Regional Offices.

Table D-1. FEMA Region Contact Information.

FEMA Region	States and Territories	Address	Telephone
Headquarters	Headquarters	Federal Emergency Management Agency 500 C Street SW Washington, DC 20472	800.621.3362
Region I	Connecticut, Maine, Massachusetts, New Hampshire, Rhode Island, Vermont	Federal Emergency Management Agency 99 High Street Boston, MA 02110	617.956.7506 Alternate: 877.336.2734
Region II	New Jersey, New York, Puerto Rico, U.S. Virgin Islands	Federal Emergency Management Agency 26 Federal Plaza New York, NY 10278 Region II Caribbean Address Federal Emergency Management Agency Caribbean Division PO. Box 70105 San Juan, PR 00936-0105	212.680.3600
Region III	Delaware, District of Columbia, Maryland, Pennsylvania, Virginia, West Virginia	Federal Emergency Management Agency 615 Chestnut Street Philadelphia, PA 19106-4404	215.931.5500
Region IV	Alabama, Florida, Georgia, Kentucky, Mississippi, North Carolina, South Carolina, Tennessee	Federal Emergency Management Agency 3003 Chamblee Tucker Road Atlanta, GA 30341	770.220.5200
Region V	Illinois, Indiana, Michigan, Minnesota, Ohio, Wisconsin	Federal Emergency Management Agency 536 South Clark Street, 6th Floor Chicago, IL 60605	312.408.5500
Region VI	Arkansas, Louisiana, New Mexico, Oklahoma, Texas	Federal Emergency Management Agency FRC 800 North Loop 288 Denton, TX 76209-3698	940.898.5399
Region VII	Iowa, Kansas, Missouri, Nebraska	Federal Emergency Management Agency 9221 Ward Parkway Kansas City, MO 64114	816.283.7061
Region VIII	Colorado, Montana, South Dakota, Utah, Wyoming	Federal Emergency Management Agency Denver Federal Center Building 710, Box 25267 Denver, CO 80225-0267	303.235.4800
Region IX	Arizona, California, Guam, Hawaii, Nevada, Commonwealth of Northern Mariana Islands, Republic of the Marshall Islands, Federated States of Micronesia, American Samoa	Federal Emergency Management Agency 1111 Broadway, Suite 1200 Oakland, CA 94607-4052	510.627.7100 Pacific Area Office: 808.851.7900
Region X	Alaska, Idaho, Oregon, Washington	Federal Emergency Management Agency Federal Regional Center 130 228th Street, Southwest Bothell, WA 98021-8627	425.487.4600 Alaska Area Office: 907.271.4300



FEMA

FEMA P-348
Catalog No. 09125-1