



CONNECTICUT PUBLIC HEALTH CODE

On-site Sewage Disposal Regulations and Technical Standards for Subsurface Sewage Disposal Systems

PHC Section 19-13-B100a (Building Conversions, Changes in Use, Building Additions)

Effective August 3, 1998

PHC Sections 19-13-B103a through 19-13-B103f (Design Flows 5,000 Gallons per Day or Less*)

Effective August 16, 1982

Technical Standards for Subsurface Sewage Disposal Systems

Effective August 16, 1982

Revised January 1, 2018

PHC Sections 19-13-B104a through 19-13-B104d (Design Flows Greater than 5,000 Gallons per Day*)

Effective August 16, 1982

*Note: The 5,000 gallons per day jurisdictional design flow was increased to 7,500 gallons per day by Public Act No. 17-146, Section 30 effective July 1, 2017.

State of Connecticut
Department of Public Health
Environmental Engineering Program
410 Capitol Avenue - MS #12SEW
P.O. Box 340308
Hartford, Connecticut 06134
(860) 509-7296

www.ct.gov/dph/subsurfacesewage

January 2018

TABLE OF CONTENTS

PUBLIC HEALTH CODE		<u>PAGE</u>
<u>SECTION</u>		
19-13-B100a	Building Conversions, Changes in Use, Additions.....	1
19-13-B103a	Scope.....	3
19-13-B103b	Definitions.....	3
19-13-B103c	General Provisions.....	4
19-13-B103d	Minimum Requirements.....	4
19-13-B103e	Procedures and Conditions for the Issuance of Permits and Approvals.....	6
19-13-B103f	Non-discharging Sewage Disposal Systems.....	9
 TECHNICAL STANDARDS		
<u>SECTION</u>		
	Glossary of Acronyms and Abbreviations.....	10
I	Definitions.....	11
II	Location of Sewage Systems.....	13
III	Piping.....	16
IV	Design Flows.....	22
V	Septic Tanks and Grease Interceptor Tanks.....	24
VI	Effluent Distribution, Pump Systems & Air Injection Processes.....	28
VII	Percolation Tests.....	33
VIII	Leaching Systems.....	34
IX	Groundwater and Surface Water Drainage.....	45
X	Water Treatment Wastewater.....	45
XI	Non-Discharging Toilet & Sewage Disposal Systems.....	47
<u>FORMS</u>		
FORM #1	Application for Approval to Construct a Subsurface Sewage Disposal System.....	48
FORM #2	Site Investigation for a Subsurface Sewage Disposal System...	49
FORM #2 ALTERNATE	Site Investigation for a Subsurface Sewage Disposal System...	51
FORM #3	Final Inspection Report.....	53
FORM #4	Permit to Discharge.....	55

<u>APPENDICES*</u>		<u>PAGE</u>
APPENDIX A	Minimum Leaching System Spread (MLSS).....	56
APPENDIX B	Approved Septic Tank Effluent Filters.....	61
APPENDIX C	Approved Filter Fabrics for Covering Stone Aggregate.....	61
APPENDIX D	Approved Non-Concrete Septic Tanks.....	62
APPENDIX E	Water Treatment Wastewater Authorized to Discharge to a Subsurface Sewage Disposal System.....	63

PUBLIC HEALTH CODE

SECTION

19-13-B104a	Scope.....	64
19-13-B104b	Definitions.....	64
19-13-B104c	General Provisions.....	64
19-13-B104d	Minimum Requirements.....	65

*Appendices may be updated prior to the publication of the next *Technical Standards for Subsurface Sewage Disposal Systems*. Updated appendices shall be posted on the Department of Public Health’s website.

Former revisions to the *Technical Standards for Subsurface Sewage Disposal Systems*:
January 1st 1986, 1989, 1992, 1994, 1997, 2000, 2004, 2007, 2009, 2011, and 2015.

PUBLIC HEALTH CODE B100a REGULATION

Sec. 19-13-B100a. Building Conversions/Changes in Use, Building Additions, Garages/Accessory Structures, Swimming Pools, Sewage Disposal Area Preservation

- (a) **Definitions.** As used in this section:
- (1) “Accessory structure” means a permanent non-habitable structure which is not served by a water supply and is used incidental to residential or non-residential buildings. Accessory structures include, but are not limited to, detached garages, open decks, tool and lawn equipment storage sheds, gazebos, and barns.
 - (2) “Building conversion” means the act of winterizing a seasonal use building into year round use by providing one or more of the following: (A) a positive heating supply to the converted area; or, (B) a potable water supply which is protected from freezing; or, (C) energy conservation in the form of insulation to protect from heat loss.
 - (3) “Change in use” means any structural, mechanical or physical change to a building which allows the occupancy to increase; or the activities within the building to expand or alter such that, when the building is fully utilized, the design flow or required effective leaching area will increase.
 - (4) “Code-complying area” means an area on a property where a subsurface sewage disposal system can be installed which meets all requirements of Section 19-13-B103 of the Regulations of Connecticut State Agencies, and the Technical Standards except for the one hundred percent reserve leaching area referred to in Section VIII A of the Technical Standards.
 - (5) “Design flow” means the anticipated daily discharge from a building as determined in accordance with Sections IV and VIII F of the Technical Standards.
 - (6) “Potential repair area” means an area on a property which could be utilized to repair or replace an existing or failed septic system and includes areas on the property where exceptions to Section 19-13-B103 of the Regulations of Connecticut State Agencies could be granted by the local director of health or the Commissioner of Public Health but does not include areas beyond those necessary for a system repair and areas of exposed ledge rock.
 - (7) “Technical Standards” means those standards established by the Commissioner of Public Health in the most recent revision of the publication entitled “Technical Standards for Subsurface Sewage Disposal Systems” prepared pursuant to Section 19-13-B103d (d) of the Regulations of Connecticut State Agencies. These standards can be obtained from the Department of Public Health, 410 Capitol Avenue, MS #51SEW, P.O. Box 340308, Hartford, CT 06134-0308, or by calling (860) 509-7296.
- (b) **Building conversion, change in use.** If public sewers are not available, no building or part thereof shall be altered so as to enable its continuous occupancy by performing any building conversion, nor shall there be a change in use unless the local director of health has determined that after the conversion or change in use, a code-complying area exists on the lot for installation of a subsurface sewage disposal system. The determination by the local director of health of whether a code-complying area exists on the property shall be based upon analysis of existing soil data. If soil data is not available, the property owner shall perform soil testing. The property owner or the owner’s authorized agent shall submit design plans or a sketch to demonstrate how the property contains a code-complying area that can accommodate a sewage disposal system. The local director of health may require expansion of the existing sewage disposal system or installation of a new sewage disposal system at the time of the change in use for those properties whenever the proposed change in use results in a more than 50% increase in the design flow.
- (c) **Building additions.** If public sewers are not available, no addition to any building shall be permitted unless the local director of health has determined that after the building addition a code-complying area exists on the lot for the installation of a subsurface sewage disposal system. Once a code-complying area is identified, portions of the property outside this designated area may be utilized for further development of the property. This determination by the local director of health shall be based upon analysis of existing soil data to determine if a code-complying area exists. If soil data is not available, the property owner shall perform soil testing. The property owner or the owner’s authorized agent shall submit design plans or a sketch to demonstrate how the property contains a code-complying area that can accommodate a sewage disposal system. If the applicant submits soil test data, design plans or a sketch and is unable to demonstrate a code-complying area, the building addition shall be permitted, provided:

- (1) The size of the replacement system shown on design plans or sketch provides a minimum of 50% of the required effective leaching area per the Technical Standards,
- (2) The replacement system shown on the plans or sketch provides a minimum of 50% of the required Minimum Leaching System Spread (MLSS) per the Technical Standards,
- (3) The proposed design does not require an exception to Section 19-13-B103d (a)(3) of the Regulations of Connecticut State Agencies, regarding separation distances to wells,
- (4) The addition does not reduce the potential repair area, and
- (5) The building addition does not increase the design flow of the building.

The local director of health may require expansion of the existing sewage disposal system or installation of a new sewage disposal system at the time of building addition whenever the proposed addition results in a more than 50% increase in the design flow. The separation distance from an addition to any part of the existing sewage disposal system shall comply with Table 1 in Section II of the Technical Standards.

- (d) **Attached or detached garages, accessory structures, below or above ground pools.** If public sewers are not available, no attached garage, detached garage, accessory structure, below or above ground pool shall be permitted unless the local director of health has determined that after construction of the attached garage, detached garage, accessory structure, below or above ground pool, a code-complying area exists on the lot for installation of a subsurface sewage disposal system. This determination by the local director of health shall be based upon analysis of existing soil data. If soil data is not available, the property owner shall perform soil testing. The property owner or the owner's authorized agent shall submit design plans or a sketch to demonstrate how the property contains a code-complying area that can accommodate a sewage disposal system. If the applicant submits soil test data, design plans or a sketch and is unable to demonstrate a code-complying area, the attached or detached garage, below or above ground pool, or accessory structure shall be permitted, provided the structure does not reduce the potential repair area. The separation distance from the attached or detached garage, below or above ground pool, or accessory structure to any part of the existing sewage disposal system shall comply with Table 1 in Section II of the Technical Standards.
- (e) **Sewage disposal area preservation.** If public sewers are not available, no lot line shall be relocated or any other activity performed that affects soil characteristics or hydraulic conditions so as to reduce the potential repair area, unless the local director of health has determined that after the lot line relocation or disturbance of soils on the lot a code-complying area exists for the installation of a subsurface sewage disposal system. This determination by the local director of health shall be based upon analysis of existing soil data. If soil data is not available, the property owner shall perform soil testing. The property owner or the owner's authorized agent shall submit design plans or a sketch to demonstrate how the property contains a code-complying area that can accommodate a sewage disposal system. In no case shall a relocated lot line violate Subsection (d) of Section 19-13-B103d of the Regulations of Connecticut State Agencies that requires that each subsurface sewage disposal system shall be located on the same lot as the building served.
- (f) **Decision by Director of Health.** Any final decision of the local director of health made in regard to this section shall be made in writing and sent to the applicant. Any decision adverse to the applicant or which limits the application shall set forth the facts and conclusions upon which the decision is based. Such written decision shall be deemed equivalent to an order, and may be appealed pursuant to Section 19a-229 of the Connecticut General Statutes.

STATEMENT OF PURPOSE

The regulations up-date and clarify existing requirements for maintaining subsurface sewage disposal areas on lots which are served by on-site subsurface sewage disposal systems. The purpose is to regulate building conversions; activities which would potentially increase the water usage discharged to a subsurface sewage disposal system; construction activities or lot line changes which would reduce the area available for sewage disposal purposes.

Effective August 3, 1998

PUBLIC HEALTH CODE B103 REGULATIONS*

On-Site Sewage Disposal Systems with Design Flows of 5,000 Gallons per Day or Less** and Non-Discharging Toilet Systems

*The reference to the Commissioner of Health Services was changed to the Commissioner of Public Health in the below printing of the B103 regulations (Sections 19-13-B103a through 19-13-B103f) to be consistent with the language in the *Technical Standards for Subsurface Sewage Disposal Systems*.

**Note: The 5,000 gallons per day jurisdictional design flow was increased to 7,500 gallons per day by Public Act No. 17-146, Section 30 effective July 1, 2017.

Sec. 19-13-B103a. Scope

These regulations establish minimum requirements for household and small commercial subsurface sewage disposal systems with a capacity of 5,000 gallons per day or less, non-discharging toilet systems and procedures for the issuance of permits or approvals of such systems by the director of health or registered sanitarian, as required by Section 25-54i(g) of the General Statutes.

(Effective August 16, 1982)

Sec. 19-13-B103b. Definitions

The following definitions shall apply for the purposes of Sections 19-13-B103c to 19-13-B103f, inclusive:

- (a) **Sewage** means domestic sewage consisting of water and human excretions or other waterborne wastes incidental to the occupancy of a residential building or a non-residential building, as may be detrimental to the public health or the environment, but not including manufacturing process water, cooling water, waste water from water softening equipment, blow down from heating or cooling equipment, water from cellar or floor drains or surface water from roofs, paved surface or yard drains.
- (b) **Septic tank** means a water-tight receptacle which is used for the treatment of sewage and is designed and constructed so as to permit the settling of solids, the digestion of organic matter by detention and the discharge of the liquid portion to a leaching system.
- (c) **Subsurface sewage disposal system** means a system consisting of a house sewer; a septic tank followed by a leaching system, any necessary pumps and siphons, and any groundwater control system on which the operation of the leaching system is dependent.
- (d) **Residential building** means any house, apartment, trailer or mobile home, or other structure occupied by individuals permanently or temporarily as a dwelling place but not including residential institutions.
- (e) **Residential institution** means any institutional or commercial building occupied by individuals permanently or temporarily as a dwelling, including dormitories, boarding houses, hospitals, nursing homes, jails, and residential hotels or motels.
- (f) **Nonresidential building** means any commercial, industrial, institutional, public or other building not occupied as a dwelling, including transient hotels and motels.
- (g) **Impervious soil** means soil that has a minimum percolation rate slower than one inch in sixty minutes when the groundwater level is at least eighteen inches below the bottom of the percolation test hole.
- (h) **Suitable soil** means soil having a minimum percolation rate of one inch in one to sixty minutes when the groundwater level is at least eighteen inches below the bottom of the percolation test hole.
- (i) **Maximum groundwater level** means the level to which groundwater rises for a duration of one month or longer during the wettest season of the year.
- (j) **Open watercourse** means a well defined surface channel, produced wholly or in part by a definite flow of water and through which water flows continuously or intermittently and includes any ditch, canal, aqueduct or other artificial channel for the conveyance of water to or away from a given place, but not including gutters for storm drainage formed as an integral part of a paved roadway; or any lake, pond, or other surface body of water, fresh or tidal; or other surface area intermittently or permanently covered with water.
- (k) **Local director of health** means the local director of health or his authorized agent.
- (l) **Technical Standards** means the standards established by the Commissioner of Public Health in the most recent revision of the publication entitled "Technical Standards for Subsurface Sewage Disposal Systems" available from the State Department of Public Health.
- (m) **Department** means the State Department of Public Health.
- (n) **Gray water** means domestic sewage containing no fecal material or toilet wastes.
- (o) **Drawdown area** means that area adjacent to a well in which the water table is lowered by withdrawal of water from the well by pumping at a rate not exceeding the recharge rate of the aquifer.

(Effective August 16, 1982)

Sec. 19-13-B103c. General Provisions

- (a) All sewage shall be disposed of by connection to public sewers, by subsurface sewage disposal systems, or by other methods approved by the Commissioner of Public Health, in accordance with the following requirements.
- (b) All sewers, subsurface sewage disposal systems, privies and toilet or sewage plumbing systems shall be kept in a sanitary condition at all times and be so constructed and maintained as to prevent the escape of odors and to exclude animals and insects.
- (c) The contents of a septic tank, subsurface sewage disposal system or privy vault shall only be disposed of in the following manner.
 - (1) If the contents are to be disposed of on the land of the owner, disposal shall be by burial or other method which does not present a health hazard or nuisance; or
 - (2) If the contents are to be disposed of on land of other than the owner;
 - (A) The contents shall be transferred and removed by a cleaner licensed pursuant to Connecticut General Statutes § 20-341, and
 - (B) Only on the application for and an issuance of a written permit from the local director of health in accordance with the provisions of this section;
 - (3) If the contents are to be dispersed on a public water supply watershed, only on the application and issuance of a written permit by the Commissioner of Public Health in accordance with the provisions of this section.

Each application for a permit under (c) (2) and (3) shall be in writing and designate where and in what manner the material shall be disposed of.

- (d) All material removed from any septic tank, privy, sewer, subsurface sewage disposal system, sewage holding tank, toilet or sewage plumbing system shall be transported in water-tight vehicles or containers in such a manner that no nuisance or public health hazard is presented. All vehicles used for the transportation of such material shall bear the name of the company or licensee and shall be maintained in a clean exterior condition at all times. No defective or leaking equipment shall be used in cleaning operations. All vehicles or equipment shall be stored in a clean condition when not in use. Water used for rinsing such vehicles or equipment shall be considered sewage and shall be disposed of in a sanitary manner approved by the local director of health.
- (e) Septic tanks shall be cleaned by first lowering the liquid level sufficiently below the outlet to prevent sludge or scum from overflowing to the leaching system where it could cause clogging and otherwise damage the system. Substantially all of the sludge and scum accumulation shall be removed whenever possible, and the inlet and outlet baffles shall be inspected for damage or clogging. Cleaners shall use all reasonable precaution to prevent damaging the sewage disposal system with their vehicle or equipment. Accidental spillage of sewage, sludge or scum shall be promptly removed or otherwise abated so as to prevent a nuisance or public health hazard.
- (f) No sewage shall be allowed to discharge or flow into any storm drain, gutter, street, roadway or public place, nor shall such material discharge onto any private property so as to create a nuisance or condition detrimental to health. Whenever it is brought to the attention of the local director of health that such a condition exists on any property, he shall investigate and cause the abatement of this condition.

(Effective August 16, 1982)

Sec. 19-13-B103d. Minimum Requirements

- (a) Each subsurface sewage disposal system shall be constructed, repaired, altered or extended pursuant to the requirements of this section unless an exception is granted in accordance with the following provisions:
 - (1) A local director of health may grant an exception, except with respect to the requirements of Section 19-13-B103d (d) and Technical Standard IIA, for the repair, alteration, or extension of an existing subsurface sewage disposal system where he determines the repair, alteration or extension cannot be effected in compliance with the requirements of this section and upon a finding that such an exception is unlikely to cause a nuisance or health hazard. All exceptions granted by the local director of health shall be submitted to the Commissioner of Public Health within thirty days after issuance on forms provided by the Department.
 - (2) The Commissioner of Public Health may grant an exception to the requirements of Section 19-13-B103d (d) upon written application and upon a finding that:
 - (A) A central subsurface sewage disposal system serving more than one building is technically preferable for reasons of site limitations, or to facilitate construction, maintenance or future connection to public sewers, or;
 - (B) A subsurface sewage disposal system not located on the same lot as the building served is located on an easement attached thereto. Such easement shall be properly recorded on the land records and

shall be revocable only by agreement of both property owners and the Commissioner of Public Health.

- (3) The Commissioner of Public Health may grant an exception to the requirements of Technical Standard IIA, upon written application and upon a finding that such an exception is unlikely to pollute the well in such a manner as to cause a health hazard.
- (b) **Technical Standards.**

Subsurface sewage disposal systems within the scope of this regulation shall be designed, installed and operated in accordance with the technical standards established in the "Technical Standards for Subsurface Sewage Disposal Systems" published by the Commissioner of Public Health. The Technical Standards shall be reviewed annually and changes to the Technical Standards shall be available on January 1st of each year.
- (c) **Large Subsurface Disposal Systems.**

The Commissioner of Public Health shall approve plans for subsurface sewage disposal systems serving a building with a designed sewage flow of two thousand gallons per day or greater, and no such systems shall be constructed, repaired, altered or extended unless the plans for such systems are approved by the Commissioner in accordance with the following:

 - (1) Plans for the system are submitted at least twenty days prior to approval to construct by the local director of health.
 - (2) The plans are designed by a professional engineer registered in the State of Connecticut.
 - (3) The plans submitted contain:
 - (A) The basis of design,
 - (B) Soil conditions and test pit locations,
 - (C) Maximum groundwater and ledge rock elevations,
 - (D) Original and finished surface contours and elevations,
 - (E) Property lines, and
 - (F) Locations of buildings, open watercourses, ground and surface water drains, nearby wells and water service lines.
- (d) **Location.**

Each building shall be served by a separate subsurface sewage disposal system. Each such system shall be located on the same lot as the building served.
- (e) **Disposal of Sewage in Areas of Special Concern.**
 - (1) Disposal systems for areas of special concern shall merit particular investigation and special design, and meet the special requirements of this subsection. The following are determined to be areas of special concern:
 - (A) A minimum soil percolation rate faster than one inch per minute, or
 - (B) Slower than one inch in thirty minutes, or
 - (C) Maximum groundwater less than three feet below ground surface, or
 - (D) Ledge rock less than five feet below ground surface, or
 - (E) Soils with slopes exceeding twenty-five per cent, or
 - (F) Consisting of soil types interpreted as having severe limitations for on-site sewage disposal by most recent edition of the National Cooperative Soil Survey of the Soil Conservation Service, or
 - (G) Designated as wetland under the provisions of Sections 22a-36 through 22a-45 of the Connecticut General Statutes, as amended, or
 - (H) Located within the drawdown area of an existing public water supply well with a withdrawal rate in excess of fifty gallons per minute, or within five hundred feet of land owned by a public water supply utility and approved for a future well site by the Commissioner of Public Health.
 - (2) In such areas of special concern, the local director of health may require investigation for maximum groundwater level to be made between February 1 and May 31, or such other times when the groundwater level is determined by the Commissioner of Public Health to be near its maximum level.
 - (3) (A) Plans for new subsurface systems in areas of special concern shall:
 - (i) Be prepared by a professional engineer registered in the State of Connecticut;
 - (ii) Include all pertinent information as to the basis of design, and soil conditions, test pit locations, groundwater and ledge rock elevations, both original and finished surface contours and elevation, property lines, building locations, open watercourses, ground and surface water drains, nearby wells and water service lines;
 - (iii) Demonstrate an ability to solve the particular difficulty or defect associated with the area of special concern and which caused its classification. The Commissioner or local director of health, as the case may be, may require a study of the capacity of the surrounding natural soil

absorb or disperse the expected volume of sewage effluent without overflow, breakout, or detrimental effect on ground or surface waters if in their opinion such may occur.

- (B) The plans for new subsurface disposal systems in areas of special concern shall be submitted to the local director of health and the Commissioner of Public Health for a determination as to whether the requirements of the subsection have been met, except that such submission need not be made to the Commissioner of Public Health if the local director or authorized agent has been approved to review such plans by the Commissioner of Public Health in accordance with Section B103e (b). All submissions to the Commissioner of Public Health shall be made at least 20 days prior to issuance of an approval to construct by the local director of health.
- (4) If application is made for the repair, alteration or extension of an existing subsurface disposal system in an area of special concern, the local director of health may require that the applicant comply with the requirement of Subdivision (3) if he determines that the contemplated repair, alteration or extension involves technical complexities which cannot reasonably be addressed by himself, his authorized agent or the system installer.
- (5) While a sewage disposal system in an area of special concern is under construction, the local director of health may require that the construction be supervised by a professional engineer registered in the State of Connecticut, if in the opinion of the local director of health it is necessary to insure conformance to the plans approved or because of the difficulties likely to be encountered. The engineer shall make a record drawing of the sewage disposal system, as installed, which he shall submit to the local director of health prior to issuance of a discharge permit.
- (6) In such areas of special concern, the Commissioner of Public Health or the local director of health who has been approved by the Commissioner to review engineering plans in areas of special concern pursuant to Section 19-13-B103e (b) may require a study of the capacity of the surrounding natural soil to absorb or disperse the expected volume of sewage effluent without overflow, breakout, or detrimental effect on ground or surface waters.
- (f) **Gray Water Systems.**
Disposal systems for sinks, tubs, showers, laundries and other gray water from residential buildings, where no water flush toilet fixtures are connected, shall be constructed with a septic tank and leaching system at least one-half the capacity specified for the required residential sewage disposal system.

(Effective August 16, 1982)

Sec. 19-13-B103e. Procedures and Conditions for the Issuance of Permits and Approvals

No subsurface sewage disposal system shall be constructed, altered, repaired or extended without an approval to construct issued in accordance with this section. No discharge shall be initiated to a subsurface sewage disposal system without a discharge permit issued in accordance with this section. Such permits and approvals shall be issued and administered by the local director of health.

(a) **No Permit or Approval Shall be Issued:**

- (1) For any subsurface sewage disposal system which is designed to discharge or overflow any sewage or treated effluent to any watercourse;
- (2) For any new subsurface sewage disposal system until it is demonstrated to the satisfaction of the local director of health that there is a public water supply available or a satisfactory location for a water supply well complying with Sections 19-13-B51a through 19-13-B51m of the Public Health Code;
- (3) For any new subsurface sewage disposal system where the soil conditions in the area of the leaching system are unsuitable for sewage disposal purposes at the time of the site investigation made pursuant to this section. Unsuitable conditions occur where the existing soil is impervious, or where there is less than four feet depth of suitable existing soil over ledge rock, two feet of which is naturally occurring soil, or where there is less than 18 inches depth of suitable existing soil over impervious soil, or where the groundwater level is less than 18 inches below the surface of the ground for a duration of one month or longer during the wettest season of the year;
- (4) For any new subsurface sewage disposal system where the surrounding naturally occurring soil cannot adequately absorb or disperse the expected volume of sewage effluent without overflow, breakout or detrimental effect on ground or surface water.

(b) **Approval of Agents by Commissioner of Public Health**

- (1) A local director of health shall authorize only persons approved by the Commissioner of Public Health to investigate, inspect and approve plans relating to subsurface sewage disposal systems.
- (2) The Commissioner of Public Health shall approve agents of the local director of health whose qualifications to investigate, inspect and approve plans relating to subsurface sewage disposal systems have been established by attending training courses and passing examinations given by the Department of Public Health, as follows:

- (A) Agents who have attended training courses and passed examinations relative to Sections 19-13-B100, 19-13-B103 and 19-13-B104 of the Public Health Code and the Technical Standards shall be approved to investigate, inspect and approve all plans for subsurface sewage disposal systems except those prepared by a professional engineer registered in the State of Connecticut pursuant to Section 19-13-B103d (c) or (e).
 - (B) Agents who have attended training courses and passed examinations relative to the engineering design of subsurface sewage disposal systems shall be approved to investigate, inspect and approve plans for such systems prepared by a professional engineer registered in the State of Connecticut pursuant to Section 19-13-B103d (e).
- (c) **Application for Permit or Approval.**
- (1) No investigation, inspection or approval of a subsurface sewage disposal system shall be made, or permit issued without an application by the owner in accordance with the following requirements.
 - (2) Applications for permits shall:
 - (A) Be on forms identical to Form #1 in the Technical Standards; or
 - (B) Be on forms prepared by the local director of health and deemed by the Commissioner of Public Health as equivalent to Form #1 in the Technical Standards; and
 - (C) Have attached a plot plan of the lot, which shall be a surveyor's plan if available or one prepared from information on the deed or land records.
 - (3) All the requested information shall be provided. If the information is not provided, it shall be indicated why it is not available or the application may be determined incomplete, and be rejected.
- (d) **Site Investigation.**
- (1) The local director of health or a professional engineer registered in the State of Connecticut representing the applicant shall make an investigation of the site proposed for the subsurface sewage disposal system and report the findings and recommendations of the investigations on a form identical to Form #2 in the Technical Standards to include:
 - (A) A record of soil test location, measures and observations.
 - (B) Soil percolation results.
 - (C) Observations of groundwater and ledge rock.
 - (D) A conclusion as to the suitability of the site for subsurface sewage disposal.
 - (E) Special requirements for design of the system, or further testing which shall be in accordance with the most recent edition of the Technical Standards.
 - (2) Prior to the site investigation, the applicant shall:
 - (A) Provide for the digging of a suitable number of percolation test holes and deep observation pits in the area of the proposed leaching system and extending at least four feet below the bottom of the proposed leaching system, at the direction of the local director of health;
 - (B) Provide water for performing the percolation tests;
 - (C) If required by the local director of health, locate by field stakes or markers the sewage disposal system, house, well or property lines.
 - (3) The site investigation shall be made within ten working days of application unless otherwise required by subsection 19-13-B103d (e).
 - (4) The local director of health shall:
 - (A) Assure the accuracy of the findings of soil tests and deep observation pits; and
 - (B) When the maximum groundwater level is in doubt the local director of health shall investigate pursuant to Section 19-13-B103d (e).
 - (5) The size of the leaching system shall be based on the results of soil percolation tests made in the area of the proposed leaching system or on other methods of determining the soil absorption capacity in accordance with the Technical Standards.
 - (6) In areas of special concern, or for leaching systems with a design sewage flow of 2,000 gallons per day or greater, the local director of health may require from the applicant whatever further testing or data necessary to assure that the sewage disposal system will function properly. Further testing may be required prior to or subsequent to issuance of the approval to construct. Such tests may include permeability tests, sieve analysis or compaction tests of natural soil or fill materials, and the installation of groundwater level monitoring wells, or pipes, as well as additional observation pits and soil percolation tests.
- (e) **Submission of Plan.**
- (1) Every plan for a subsurface sewage disposal system shall be submitted to the local director of health.
 - (2) Every plan for a subsurface sewage disposal system shall include all information necessary to assure compliance with the requirements of Section 19-13-B103d of these regulations, and contain as a

minimum the following information: the location of the house sewer, the location and size of the septic tank, the location and description of the leaching system, property lines, building locations, watercourses, ground and surface water drains, nearby wells and water service lines.

- (3) Where required by the local director of health under subsections 19-13-B103d (c) and (e) of these regulations, the plan shall be prepared by a professional engineer, registered in the State of Connecticut, and shall be forwarded by the local director to the Commissioner of Public Health, together with his comments and recommendations.
 - (4) No plan shall be submitted directly by the applicant or engineer to the Commissioner of Public Health, unless requested by the local director of health.
- (f) **Approval to Construct.**
- (1) Upon determination that the subsurface sewage disposal system has been designed in compliance with the requirements of Section 19-13-B103d of these regulations, the local director of health shall issue an approval to construct. Approvals to construct shall be valid for a period of one year from the date of their issuance and shall terminate and expire upon a failure to start construction within that period. Approvals to construct may be renewed for an additional one year period by the local director of health upon a demonstration of reasonable cause for the failure to start construction within the one year period.
 - (2) Each subsurface sewage disposal system shall be constructed by a person licensed pursuant to Chapter 393a of the General Statutes. Such person shall notify the local director of health at least twenty-four hours prior to commencement of construction.
 - (3) The Commissioner of Public Health shall approve in accordance with Subsection 19-13-B103d (c) plans for a subsurface sewage disposal system to serve a building, the design sewage flow from which is two thousand gallons a day or greater prior to issuance of an approval to construct by the local director of health.
 - (4) Approval to construct a subsurface sewage disposal system in an area of special concern shall not be issued until twenty days following submission of the plans to the Commissioner of Public Health in accordance with subsection 19-13-B103d (e), unless earlier approved by the Commissioner.
- (g) **Inspection.**
- (1) The local director of health shall inspect all subsurface sewage disposal systems for compliance with Subsection 19-13-B103d and the approved plans for construction prior to covering and at such other times as deemed necessary.
 - (2) After construction, and prior to covering, the subsurface sewage disposal system installer shall notify the local director of health the site is prepared for inspection. Such inspection shall take place as soon thereafter as feasible, but not later than two (2) working days after receipt of the request unless the owner agrees to an extension.
 - (3) A final inspection report shall be prepared by the local director of health on forms deemed by the Commissioner of Public Health as equivalent to Form #3 in the Technical Standards.
 - (4) A record plan of the sewage disposal system, as built, shall be required by the local director of health.
- (h) **Permit to Discharge.**
- (1) Upon determination that the subsurface sewage disposal system has been installed in compliance with the requirements of Section 19-13-B103d of these regulations and the approved plans, the local director of health shall issue a permit to discharge. A copy of such permit shall be sent to the local building official. No permit to discharge shall be issued until all required forms are completed and an approved as-built plan or record drawing is received.
 - (2) Any permit to discharge issued by the Commissioner of Public Health or a local director of health for a household or small commercial subsurface sewage disposal system with a capacity of five thousand gallons per day or less shall be deemed equivalent to a permit issued under Subsection 25-54i(b) of the Connecticut General Statutes. Such permits shall:
 - (A) Specify the manner, nature and volume of discharge;
 - (B) Require proper operation and maintenance of any pollution abatement facility required by such permit;
 - (C) Be subject to such other requirements and restrictions as the Commissioner deems necessary to comply fully with the purposes of this chapter and the Federal Water Pollution Control Act; and
 - (D) Be issued on forms approved by the Commissioner of Public Health.
 - (3) The local director of health shall record the granting of an exception from any requirement of Section 19-13-B103d on the permit to discharge.
- (i) **Enforcement.**
- (1) A permit to discharge to a subsurface sewage disposal system shall not be construed to permit any sewage overflow, nuisance, or similar condition or the maintenance thereof.

- (2) If such a condition is found to exist, the permit to discharge may be revoked, suspended, modified or otherwise limited and any such condition is subject to an order to abate the condition pursuant to Connecticut General Statutes Section 19-79.

(j) **Records.**

Copies of completed applications, investigation reports, review and inspection forms and as-built plans or record drawings of each sewage disposal system, certified as complying with this Section, shall be kept in the files of the town or health district for a minimum of ten years.

(k) **Rights of Applicant.**

- (1) All site investigations, inspections, review of plans and issuance of permits or approvals by the local director of health shall be made without unreasonable delay.
- (2) When requested in writing by the applicant, the local director of health shall designate in writing within 20 working days the requirement(s) of Section 19-13-B103d or 19-13-B103e of these regulations which prevents such investigation, inspection, review, permit or approval.
- (3) Any final decision of the local director of health made in regard to these sections shall be made in writing and sent to the applicant. Any decision adverse to the applicant or which limits the application shall set forth the facts and conclusions upon which the decision is based. Such written decision shall be deemed equivalent to an order, and may be appealed pursuant to Section 19-103 of the General Statutes.

(Effective August 16, 1982)

Sec. 19-13-B103f. Non-discharging Sewage Disposal Systems

- (a) All non-discharging sewage disposal systems shall be designed, installed and operated in accordance with the Technical Standards and the requirements of this section, unless an exception is granted by the Commissioner upon a determination that system shall provide for the proper and complete disposal and treatment of toilet wastes or gray water.

(b) **Composting Toilets.**

- (1) The local director of health may approve the use of a large capacity composting toilet or a heat-assisted composting toilet for replacing an existing privy or failing subsurface sewage disposal system, or for any single-family residential building where application is made by the owner and occupant, and the lot on which the building will be located is tested by the local director of health and found suitable for a subsurface sewage disposal system meeting all the requirements of Section 19-13-B103d of these regulations.
- (2) All wastes removed from composting toilets shall be disposed of by burial or other methods approved by the local director of health.

(c) **Incineration Toilets.**

The local director of health may approve the use of incineration toilets for non-residential buildings or for existing single-family residential dwellings for the purpose of abating existing sewage problems or replacing the existing non-water carriage toilets.

(d) **Chemical Flush Toilets and Chemical Privies.**

- (1) The local director of health may approve chemical flush toilets or chemical privies for nonresidential use where they are located outside of buildings used for human habitation. Chemical flush toilets or chemical privies located inside human habitations shall be approved by the Commissioner of Public Health and the local director of health.
- (2) Liquid waste from chemical flush toilets or chemical privies shall be disposed of in a location and manner approved by the local director of health. Such liquid shall not be disposed of on a public water supply watershed or within five hundred feet of any water supply well unless approved by the Commissioner of Public Health.

(e) **Dry Vault Privies.**

- (1) The local director of health may approve dry vault privies for nonresidential use where they are located outside of buildings used as human habitation.
- (2) Wastes removed from dry privy vaults shall be disposed of by burial or other methods approved by the local director of health.

STATEMENT OF PURPOSE:

These regulations up-date existing Public Health Code requirements for the design of subsurface sewage disposal with design flows of 5,000 gallons per day or less and non-discharge toilet systems. Sewage disposal systems conforming to this regulation and designed in compliance with published Technical Standards will provide for the preservation and improvement of public health.

GLOSSARY OF ACRONYMS AND ABBREVIATIONS

AASHTO	American Association of State Highway and Transportation Officials
ABS	Acrylonitrile butadiene styrene
AGRU	Automatic grease recovery unit
ANSI	American National Standards Institute
ASTM	American Society for Testing and Materials
AWWA	American Water Works Association
C to C	Center to center
D-box	Distribution box
DOH	Local Director of Health
ELA	Effective leaching area
FDM	Free draining material
FF	Flow factor
GIT	Grease interceptor tank
GPD	Gallons per day
GPM	Gallons per minute
HF	Hydraulic factor
Hg	Mercury
Large SSDS	Large subsurface sewage disposal system (2,000 to 7,500 gallons per day)
lbs	Pounds
LF	Linear feet
LPD	Low pressure distribution
MLSS	Minimum leaching system spread
NCR	Non-compliant repair
O & M	Operation and maintenance
OSHA	Occupational Safety and Health Administration
P.E.	Professional Engineer licensed in Connecticut
PE	Polyethylene
PF	Percolation factor
PHC	Public Health Code
PNR	Passive nitrogen reduction
PP	Polypropylene
PPD	Proprietary pressure-dosed dispersal
psi	Pounds per square inch
PVC	Polyvinyl chloride
QC/QA	Quality Control/Quality Assurance
RS Depth	Receiving soil depth
SDR	Standard Dimension Ratio
SF	Square feet
SSDS	Subsurface sewage disposal system
SWIS	Storm water infiltration system
UL	Underwriters Laboratories
WTW	Water treatment wastewater

Technical Standards for Subsurface Sewage Disposal Systems

**Effective August 16, 1982
Revised January 1, 2018**

Disclaimer: The listing of any proprietary product, technology or system in these Technical Standards shall not be considered an endorsement of the product, technology or system, nor does it convey intellectual property rights.

I. DEFINITIONS

- A. Accessory structure** means a permanent non-habitable structure that is not served by a water supply or sewage system, and is used incidental to residential or non-residential buildings. Accessory structures include, but are not limited to attached and detached garages, screened and enclosed 3-season (non-winterized) porches/sunrooms, open decks, tool and lawn equipment storage sheds, covered entryways, gazebos, barns, etc. Small (<200 square feet) portable structures (e.g., sheds) without permanent foundations (concrete slab, piers, footings) are not considered permanent structures, except for decks.
- B. Approved aggregate** means stone aggregate, or other product approved by the Commissioner of Public Health for use in leaching system construction.
- C. Bedroom** means those areas within a residential building that are, or have the potential to be, utilized as a sleeping area on a consistent basis. In order to be deemed a bedroom the room shall meet all of the following criterion:
1. Be habitable space, or planned habitable space that has “roughed- in” mechanicals (e.g., heating ducts, electrical wiring, water lines, plumbing waste lines), but is not currently “finished” for Building Code certificate of occupancy purposes. Small rooms with a floor area less than seventy (70) square feet (SF) are not considered bedrooms, unless the room has been historically designated a bedroom in an existing home. The Building Code stipulates that habitable rooms (except kitchens) shall have a floor area not less than 70 SF, therefore, bedrooms in new residential buildings are required to have a minimum floor area of 70 SF.
 2. Provides privacy to the occupants. Large (minimum 5 foot width) openings or archways may be utilized to eliminate room privacy.
 3. Full bathroom facilities (containing either a bathtub or shower) are conveniently located to the bedroom served. Convenience in this case means on the same floor as the bedroom, or directly accessed from a stairway.
 4. Entry is from a common area, not through a room already deemed a bedroom.
- D. Building served** means the physical structure that contains the habitable/interior portion of the building and the associated plumbing that discharges sewage to a sewage system. The building served includes any portion of the habitable structure permanently attached to the structure including, but not limited to, basements and 4-season (winterized) porches/sunrooms. The building served does not include attached accessory structures.
- E. Building sewer** (a.k.a., house sewer) means the pipe extending from the building served to the septic tank, grease interceptor tank, holding tank, or exterior raw sewage pump vault. Pipes approved for use under this classification are listed in Table 2.
- F. Commissioner** means Commissioner of Public Health.
- G. Effective leaching area (ELA)** means a measure in square feet of the relative size of a leaching system that takes into account the amount of infiltrative area and type of infiltrative interface. ELA does not apply to the dispersal component of a proprietary pressure-dosed dispersal system. ELA criterion, leaching system ratings and sizing requirements are included in Section VIII.
- H. Foundation drain** means a drainage system, consisting of stone or other free draining material, with or without piping, which is intended to collect and redirect groundwater in order to protect below grade portions of a building.
- I. Free draining material** (e.g., gravel, broken stone, rock fragments) means backfill that meets Connecticut Department of Transportation Form 817 Specification M.02.07 (or latest specification) and is more coarse than the surrounding excavation material.

- J. Leaching gallery** means a hollow structure with an open bottom (minimum 40-inch width) and with perforated walls surrounded by approved aggregate in a 6 foot wide level excavation.
- K. Leaching pit** means a hollow, covered structure with perforated sides and surrounded by approved aggregate.
- L. Leaching system** means a structure, excavation, or product designed to allow effluent to disperse into the receiving soil. Leaching systems include leaching trenches, leaching galleries, leaching pits, proprietary leaching systems, and dispersal components of proprietary pressure-dosed dispersal systems.
- M. Leaching trench** means a level excavation with vertical sides and flat bottoms filled with approved aggregate, and equipped with an effluent distribution pipe running the entire length of the excavation.
- N. Outbuilding** means an ancillary structure served by a water supply and sewage system that is located on a lot with an associated primary residential building, which cannot be split off and sold separately from the primary building. Outbuildings include, but are not limited to plumbed (water & sewage system plumbing) detached garages, workshops, barns, pool houses, game rooms, guest houses, and in-law apartments.
- O. Proprietary leaching system** means a manufactured product approved by the Commissioner of Public Health to be used as a leaching system, excluding the dispersal component of a proprietary pressure-dosed dispersal system.
- P. Proprietary pressure-dosed dispersal system** means a manufactured dosing and dispersal system that uniformly applies effluent into the receiving soil via small diameter holes in small diameter distribution piping, and has been approved by the Commissioner of Public Health to be used as a leaching system.
- Q. Receiving soil** means the soil in the leaching system area and surrounding soil that is available to disperse effluent. Receiving soil characteristics (e.g., depth, percolation rate) determine the configuration and sizing of a leaching system.
- R. Select fill** means clean bank run sand, clean bank run sand and gravel, or approved manufactured fill each having a gradation which conforms to the specifications stipulated in Section VIII A or ASTM C 33. Note: See Section VIII A for additional manufactured fill approval requirements.
- S. Solid pipe** means pipe that has no loose or open joints, perforations, slots or porous openings that would allow liquid to leak into or out of the pipe.
- T. Stone aggregate** means crushed or broken stone, or crushed and uncrushed gravel meeting the gradation requirements for No. 4 or No. 6 coarse aggregate (See Section VIII A) in Table M.01.02-2 and the coarse aggregate criteria by pit/quarry source in Table M.01.02.1 per Connecticut Department of Transportation Form 817 (or latest revision). The above noted criteria concerns Loss of Abrasion, Soundness by Magnesium Sulfate, and fines (material passing No. 200 sieve: 1% maximum).
- U. Tight pipe** means a solid pipe that exhibits both acceptable wall strength and watertight joints. Pipes approved for use under this designation are listed in Table 3.
- V. Watertight tank seal** means a pipe to tank connection (inlet & outlet pipe seal) that meets ASTM C 1644, ASTM C 923, or is accepted by the Commissioner of Public Health as an approved equal based on review of a company's submission of specifications and supporting documentation.
- W. Water Treatment Wastewater** is wastewater generated by a device used for the treatment of well water that enhances the quality of water and/or provides for the removal of iron, manganese, radionuclides or other substances.
- X. Water Treatment Wastewater Dispersal System** means a system of a solid conveyance pipe, followed by a structure designed to receive water treatment wastewater and allow it to percolate into the underlying soil. Such systems may include a filter or an intermediate settling structure. Receiving structures include stone filled excavations, drywells, galleries, pits, plastic chambers, or other structures approved by the Commissioner of Public Health.

II. LOCATION OF SEWAGE SYSTEMS

A. Separating Distances

Table 1 separating distances are the minimum distances for subsurface sewage disposal system (SSDS) installations, except for approved SSDS piping, unless an exception is granted in accordance with Public Health Code (PHC) Section 19-13-B103d (a). Exceptions to the distances for water supply wells (Item A) can only be granted by the Commissioner. The minimum separating distances shall be maintained for existing sewage systems (SSDSs, cesspools, holding tanks, privies), except for the replacement of a legally existing item at a distance no closer to the sewage system. Cesspools have the same separating distances as leaching systems for Table 1 purposes. Cesspools are antiquated sewage systems that do not have a septic tank. Cesspool abandonment is recommended and typically occurs at the time of a real estate transaction. The Federal Underground Injection Control program required large capacity cesspools that serve multi-family residential building(s) or non-residential buildings serving 20 or more persons per day to be abandoned by April 5, 2005.

Tables 2, 2-A, and 2-B list approved SSDS piping for building sewers, effluent distribution pipes, and force mains, and the tables specify minimum separation distances to water supply wells and other items. SSDS groundwater control systems need only to comply with the distances cited in Items E and G. Proposed relocation of lot lines governed by PHC Section 19-13-B100a (e) shall comply with the distances cited in Item J. Separating distance compliance shall be based on horizontal measurements except for non-vertical closed loop geothermal bore holes that utilize measurements taken from the closest point of the bore hole. References to sewage tanks in the special provision column in Table 1 include septic tanks, grease interceptor tanks, pump chambers, and holding tanks.

Item H specifies the minimum separating distances between a storm water infiltration system (SWIS) and a sewage system, however there are certain instances where increased separation may be warranted. SWISs that receive large quantities of water collected from impervious cover areas on sites that have hydraulic limitations may represent a concern for the proper operation of nearby SSDSs. SWISs shall not create localized groundwater mounding in the vicinity of SSDSs in order to maintain unsaturated soil conditions beneath the leaching systems for wastewater renovation purposes. SWISs may impact hydraulic conditions, and installation of these systems may be subject to a DOH review pursuant to PHC Section 19-13-B100a (e). DOHs may require an evaluation of a proposed SWIS on groundwater mounding to ensure the SWIS will not affect the operation of a nearby SSDS. Evaluations must demonstrate the receiving soil in the leaching system area is not hydraulically overloaded and that unsaturated soil conditions beneath the leaching system shall be maintained for 1-inch rain events. Municipal low impact development and storm water management programs should be coordinated with the DOH for new lot creation, new construction, and SWIS retrofits on developed sites in areas utilizing SSDSs.

B. Benchmarks and Plan Adherence

SSDS plans shall provide benchmarks with both vertical and horizontal controls, unless field staking is required and confirmed by the DOH. SSDS plans shall include information about the placement of the SSDS relative to restrictive layers and fixed reference points. Licensed installers are responsible to construct the SSDS in accordance with the plans approved by the DOH in accordance with PHC Section 19-13-B103e (f). Modifications to an approved plan shall be authorized by the plan designer and approved by the DOH.

C. Record Plans

Following a SSDS installation and final inspection, a record plan of the SSDS, as built, shall be submitted to the DOH in accordance with PHC Section 19-13-B103e (g) (4). The record plan shall identify the building sewer exit location from the building, sewage system access points (tank cleanouts, distribution boxes, etc.) and leaching system ends. The as-built drawing can be a plan to scale or a tie-plan from two or more permanent reference points. Tie-plans shall note the distance between reference points. A licensed installer shall prepare and submit the record plan, unless an engineered record drawing is required by the DOH in accordance with PHC Section 19-13-B103d (e) (5) or the DOH accepts a record plan from another individual (e.g., licensed land surveyor). Record plans shall be submitted in a timely manner to avoid delays in permit issuance by the DOH in accordance with PHC Section 19-13-B103e (k).

D. System Abandonment

Abandonment of any hollow SSDS component (e.g., septic tank, pump chamber, leaching chamber) or cesspool shall be performed in a manner to eliminate the danger of an inadvertent collapse. It is the property owner's responsibility to make arrangement for abandonment of any hollow SSDS component or cesspool. Hollow structures shall be emptied of all septage prior to abandonment. Structures shall be filled with sand or gravel, crushed in place, or removed from the site for disposal as approved by the DOH.

Table 1

Item	Separating Distance (Feet)	Special Provisions
A. Water supply well (potable, open loop geothermal, irrigation, spring) with a required withdrawal rate in gallons per minute (GPM) : < 10 GPM 10 to 50 GPM > 50 GPM	75 150 200	Distance from a water supply well to a leaching system shall be doubled if the receiving soil percolation rate is faster than 1.0 minute per inch and the bottom of the leaching system is less than 8 feet above ledge rock.
B. Building served	10	See Item G for buildings with groundwater control drains.
C. Open watercourse	50	For lots in existence prior to 8/16/82 that are not on a public water supply watershed, the distance shall be reduced to not less than 25 feet. In coastal areas, the Coastal Jurisdiction Line shall be considered the open watercourse limit, unless site specific information on high tide elevations on a property establishes the open watercourse limit.
D. Public water supply reservoir	100	
E. Solid piping for the conveyance of surface or groundwater drainage	25	Distance to tight pipe (See Table 3) shall be reduced to 5 feet as long as the pipe excavation is not backfilled with free draining material (FDM).
F. Storm water structure (e.g., catch basins, manholes)	25	Distance to sewage tank shall be reduced to 10 feet if storm water structure is watertight and constructed with rubber joint seals and watertight pipe connection seals (e.g., ASTM C 923). Storm water structures shall not be designed to collect groundwater (See Item G).
G. Groundwater drain (e.g., curtain, foundation, sumps) Up-gradient or on sides Down-gradient	25 50 ⁽¹⁾	No drain shall be constructed near a sewage system for the purpose of collecting partly treated sewage regardless of the distance. 1. Distance to sewage tank shall be reduced to 25 feet if tank is verified to be watertight.
H. Storm water infiltration system (SWIS) Single-family residential building lots Other lots (e.g., commercial, multi-family)	50 ⁽¹⁾ 75 ⁽²⁾⁽³⁾	Distance shall be reduced to 25 feet to sewage tank. 1. Distance shall be reduced to 25 feet to a leaching system if MLSS is not applicable or the SWIS is not up-gradient or down-gradient. Distances may be further reduced to 10 feet for minor SWIS (e.g., rain gardens) with the approval from the DOH if demonstrated that the leaching system or sewage tank shall not be adversely impacted. 2. Distance shall be reduced to 50 feet to a leaching system if MLSS is not applicable or the SWIS is not up-gradient or down-gradient, or with the approval from the DOH if demonstrated that the leaching system or sewage tank shall not be adversely impacted. 3. The DOH may require increased distances or an engineered assessment on the operation of the leaching system if localized groundwater mounding is a concern.
I. Top of embankment (i.e., fill package around perimeter of leaching system)	10	See Figure 13. Distance does not apply to sewage tank.

J. Property line			Distance to sewage tank and reserve leaching area shall be reduced to 10 feet. 1. Distance shall be reduced to 10 feet if the top of the leaching system is below original grade, grading rights from affected property owner are secured, or retaining walls are utilized (See Section VIII A for retaining wall provisions). 2. Separating distance between the leaching system and down-gradient property line shall be reduced to 15 feet if MLSS is not applicable or on flat groundwater table lots; further reduction may be allowed as cited in footnote 1 if either condition exists.
Up-gradient and on sides	15 ⁽¹⁾		
Down-gradient	25 ⁽²⁾		
K. Water Piping			
Pressure (e.g., potable, irrigation)	10 ⁽¹⁾		1. Water line trench excavations less than 25 feet from leaching system shall not be backfilled with FDM.
Water supply suction	75 ⁽²⁾		2. Distance between water suction pipe and sewage tank shall be reduced to 25 feet if tank is verified to be watertight.
L. Below ground swimming pool	25		See Item G for down-gradient pools with groundwater control drains.
M. Above ground swimming pool	10		Includes hot tubs (except on decks).
N. Accessory structure	10		Distance to structure without full-wall, frost protected footings shall be reduced to 5 feet. See Item G if drains provided.
O. Utility service trench (e.g., electric, gas)	5		Utility trench excavations less than 25 feet from leaching system shall not be backfilled with FDM.
P. Buried fuel tanks	25		Distance to sewage tank shall be reduced to 10 feet. Distance to leaching system shall be reduced to 10 feet if not down-gradient of leaching system. See Item G if drains provided.
Q. Water treatment wastewater (WTW) dispersal system			Distance to sewage tank shall be reduced to 10 feet.
Small discharge (<150 GPD)	25 ⁽¹⁾		Distance to WTW dispersal system non-discharging settling or filtration structures and solid piping shall be reduced to 10 feet; however solid piping excavations shall not be backfilled with FDM.
Med. discharge (150 – 500 GPD)	50 ⁽²⁾		1. Distance to leaching system shall be reduced to 10 feet if MLSS is not applicable or the WTW dispersal system does not discharge up-gradient or down-gradient of the leaching system.
Large discharge (>500 GPD)	75 ⁽³⁾		2. Distance to leaching system shall be reduced to 25 feet if MLSS is not applicable or the WTW dispersal system does not discharge up-gradient or down-gradient of the leaching system. 3. The DOH may require an increased distance or an engineered assessment on the impacts of localized groundwater mounding in the vicinity of a SSDS.
R. Closed loop geothermal system			
Bore hole, Trench	50		Distance to leaching system shall be reduced to 25 feet as long as geothermal system is not down-gradient of leaching system.
Geothermal piping to Borehole/Trench	10		Distance to sewage tank shall be reduced to 25 feet. Geothermal piping excavations less than 25 feet from leaching system shall not be backfilled with FDM.
S. Grade cuts or soil disturbance down-gradient of leaching system	50		A soil cut within 50 feet down-gradient of a leaching system shall not be allowed if bleed-out from cut is a concern. Distance may be reduced with the approval of the DOH if it is demonstrated the cut/soil disturbance preserves the leaching system's receiving soil (See MLSS Appendix A).

III. PIPING

A. Building Sewers

Building sewers shall be a minimum 4 inches in diameter, and shall be approved piping per Table 2. A minimum grade of 1/4-inch per foot (approximately 2.1 percent) shall be provided for 4-inch diameter building sewers, and 1/8-inch per foot for 6 and 8-inch diameter building sewers. The minimum grade requirement shall be provided for the entire building sewer. Building sewers shall have tight joints to the septic tank or grease interceptor tank, and be in a straight line with uniform grade wherever possible. Accessible manholes or surface cleanouts shall be provided at one or more cumulative changes of directions exceeding 45° (Figure 1), unless a 90° sweep pipe approved in Table 2 is utilized. Accessible manholes or surface cleanouts shall be provided for each 75-foot length of building sewer from the foundation wall to the septic tank or grease interceptor tank. Long building sewer lines shall be avoided to reduce the danger of groundwater infiltration and sewer blockages. Approved building sewer piping located within the sanitary radius of a water supply well shall provide the minimum separation distances specified in Table 2. Building sewer foundation penetrations shall comply with the plumbing code, which is under the purview of the local building official.

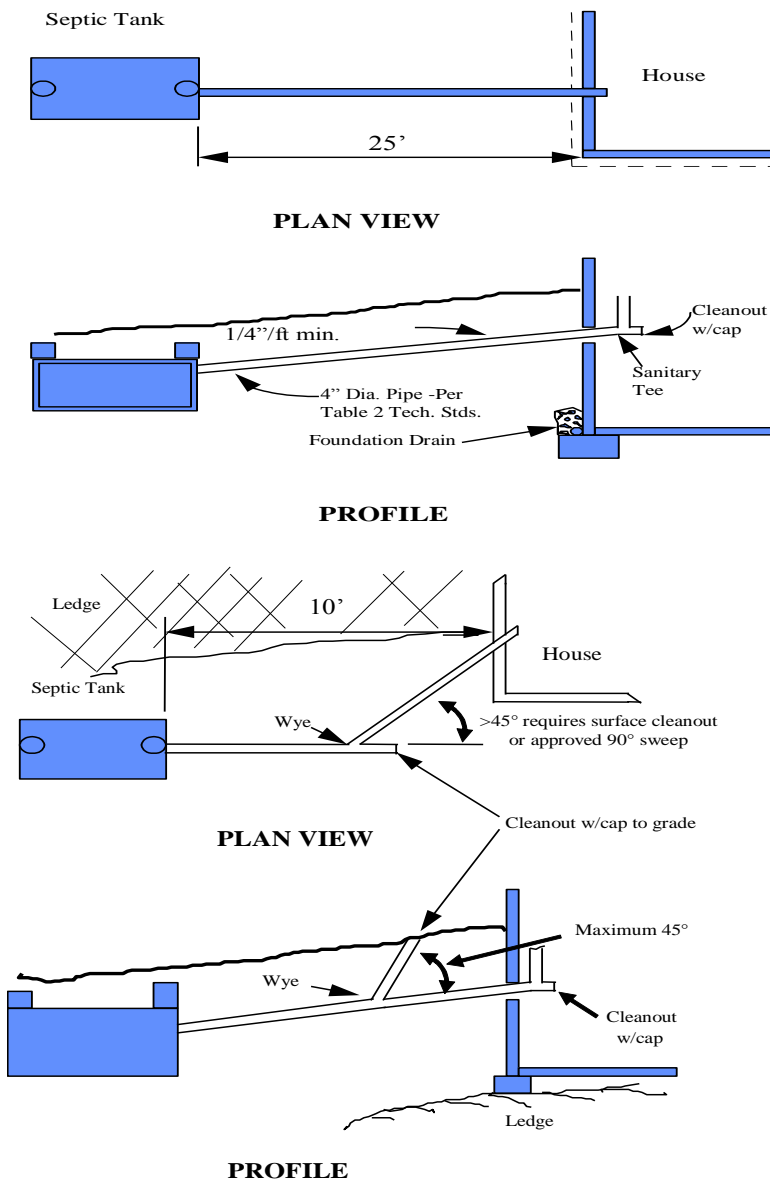

Figure 1 - Building Sewers

B. Effluent Distribution Piping

No cast iron or ductile iron piping shall be allowed following the septic tank or grease interceptor tank due to the corrosive nature of the effluent. Table 2-A lists approved effluent distribution piping. All solid effluent distribution piping located within 25 feet of a drain or open watercourse, or within the sanitary radius of a water supply well shall be higher grade piping (e.g., ASTM 3034, SDR 35) with tight joints (rubber gaskets or glued connections) per Table 2-A, and shall provide the minimum separation distances specified in Table 2-A. Solid effluent distribution piping between a septic tank and a leaching system shall not have negative pitch. Perforated distribution piping shall only be used within the footprint of the leaching system.

C. Force Main Piping

Force main piping subject to pressure from a pump or other dosing system shall have a pressure rating higher than the anticipated operating pressure for the particular application. Metal pipe (e.g., cast or ductile iron) shall not be used as a force main. Approved force main pipes are listed in Table 2-B. Approved force main piping located within the sanitary radius of a water supply well shall provide the minimum separation distances specified in Table 2-B.

D. Drainage & Water Supply Piping

Table 1 (Item E) specifies the minimum separating distances for groundwater and surface water drainage piping. As noted in the special provisions, approved tight pipes allowed within 25 feet of a sewage system are listed in Table 3; leakage testing may be requested to verify water tightness. ASTM standards specify leakage test procedures for various types of pipe. A low-pressure air test for plastic (PVC, PP, & PE) non-pressure piping is specified in ASTM F 1417, and concrete pipe testing is covered by ASTM C 924.

Table 1 (Item K) specifies the minimum separating distances for water piping. SSDS pipes shall be located a minimum of 25 feet from water supply suction pipes, and shall be approved piping (Tables 2, 2-A, & 2-B). Pressurized water lines and SSDS piping shall be located in separate trenches at least 10 feet apart whenever possible. When installed in the same trench, the water pipe shall be laid on a trench bench at least 18 inches above the top of the SSDS pipe and at least 12 inches (preferably 18 inches) from the side of the SSDS pipe trench (See Figure 2). When necessary to cross a pressurized water line with a solid effluent distribution pipe, the distribution pipe shall be approved piping (Table 2 or Table 2-A). Table 2 shall apply when the water line is located below the distribution pipe. Table 2-A shall apply when the water line is located above the distribution pipe. Building sewer pipes listed in Table 2, and force main pipes listed in Table 2-B may cross over or under pressurized water lines. Placement of pipe joints on pressurized water supply pipe and SSDS pipe at crossing points shall be avoided.

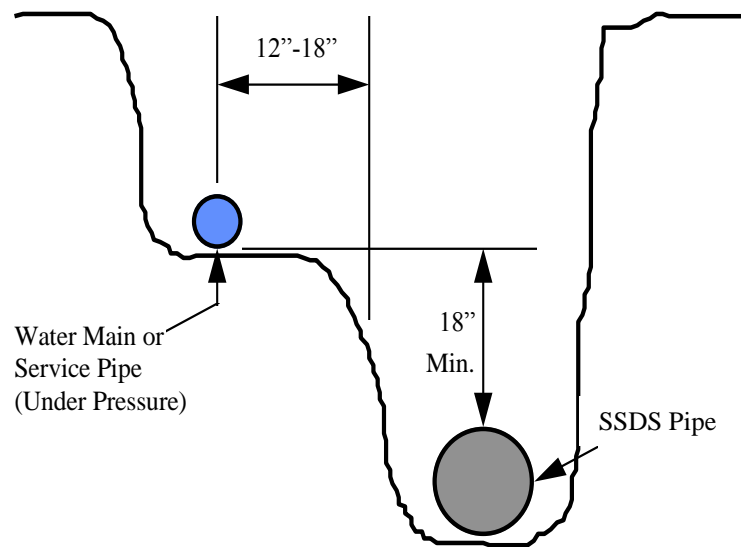

Figure 2 - Pressurized Water Pipe and SSDS Pipe Trenches

**Table 2
Approved Building Sewer Pipe from Building Served to Septic Tank or Grease Interceptor Tank**

NOTE: The DOH shall inspect all building sewer piping and joints prior to covering

USE	PIPE DESCRIPTION	ACCEPTABLE JOINT	REMARKS
<p>Building sewer from foundation wall to septic tank or grease interceptor tank.</p> <p>Building sewer within the sanitary radius of a water supply well, but no closer than the following minimum distances based on withdrawal rates: <10 gpm: 25 feet 10 – 50 gpm: 75 feet >50 gpm: 100 feet</p>	<p>Cast iron hubless ASTM A 888</p>	<p>Cast iron split sleeve bolted joint with rubber gasket, MG Coupling or equal OR 3”-wide, heavy -duty, stainless steel banded coupling with rubber gasket; Clamp-All, ANACO SD 4000 Coupling, or equal</p>	<p>Roll-on “donut type” gaskets not acceptable if connection is within 25 feet of foundation wall. Pipe shall be properly bedded, laid in straight line on uniform grade</p>
<p>Building sewers no less than 25 feet from a water suction pipe.</p>	<p>Cast iron bell and spigot ASTM A 74</p>	<p>Rubber compression gaskets</p>	<p>Stainless steel 3” wide shear band coupling required for connection of dissimilar piping materials</p>
<p>Building sewers and pressurized water lines shall be installed in accordance with Section III D.</p> <p>Building sewers shall be kept a minimum of 10 feet from closed loop geothermal bore holes and trenches.</p>	<p>PVC Schedule 40 or 80, ASTM D 1785 or ASTM D 2665</p>	<p>Rubber compression gasket couplings, Harco Mfg., ASTM D 3139 or equal* OR Solvent weld couplings/ fittings using proper two step PVC solvent solution procedure</p>	<p>*Use of 3”-wide approved stainless steel banded couplings on PVC, ASTM D 1785 or 2665 is acceptable UL (gray) Piping - Schedule 40 or 80- 36”min. radius sweep piping (90°) may be utilized without a cleanout. ABS Schedule 40 is not acceptable</p>
<p>There are no minimum distances between building sewers and other items listed in Table 1. However items placed near building sewers shall not damage or compromise the integrity of the pipe.</p>	<p>Ductile iron ANSI A 21.51</p>	<p>Rubber compression gaskets</p>	<p>Connection to cast iron building sewer shall be made with compression gaskets.</p>
	<p>PVC AWWA C900 (PC 100 psi min.)</p>	<p>Rubber compression gaskets</p>	<p>“O”-ring gasket is not acceptable</p>
	<p>PVC ASTM F 1760, Schedule 40</p>	<p>Rubber compression gaskets</p>	<p>Only 4” pipe approved Minimum 1’ cover in vehicular loaded traffic areas</p>

**Table 2-A
Approved Effluent Distribution Pipe**

USE	PIPE DESCRIPTION	TYPE OF JOINT	REMARKS
<p>Solid and perforated effluent distribution pipe used after the septic tank. Solid non-metal piping listed in Table 2 may also be utilized as effluent distribution piping, and shall be allowed at the below distances to wells, drains, etc.</p>	<p>*PVC ASTM D 3034, SDR 35 *PVC ASTM F 789, PS-46 *PVC ASTM F 891, PS-50 or PS-100 *PVC ASTM F1760, SDR35</p>	<p>*Rubber compression gasket, or solvent weld couplings/fittings w/ 2-step PVC solvent solution procedure. Bell and spigot with no gasket</p>	<p>Heavy duty plastic pipe for shallow pipe installation</p>
<p>*Solid distribution pipe within the sanitary radius of a water supply well, but no closer than the following minimum distances based on withdrawal rates: <10 gpm: 25 feet 10 – 50 gpm: 75 feet >50 gpm: 100 feet</p>	<p>PVC ASTM D 2729 - only 3" diameter pipe (see remarks for use of 4" pipe)</p>	<p>Bell and spigot, no gaskets</p>	<p>4" diameter pipes can be used but shall be bedded in 6" min. of approved aggregate and covered with 2" min. of aggregate or with other special bedding requirements to protect against crushing</p>
<p>*Solid distribution pipe no less than 25 feet from a water suction pipe.</p>	<p>PE ASTM F 810 (Perf. Spec.), SDR 38/ ASTM D 3350 - only 3" diameter pipe (see remarks for use of 4" pipe)</p>	<p>Bell and spigot, no gaskets</p>	<p>4" diameter corrugated smooth interior wall polyethylene leaching</p>
<p>*Solid distribution piping within 25 feet of an open watercourse, surface or groundwater drains (curtain/foundation). *Solid distribution pipe and pressurized water lines shall be installed in accordance with Section III D.</p>			
<p>*Solid distribution pipe should be kept a minimum of 10 feet from closed loop geothermal bore holes and trenches.</p>			
<p>There are no minimum distances between solid distribution pipe and other items listed in Table 1. However items placed near distribution piping shall not damage or compromise the integrity of the pipe.</p>	<p>PE corrugated rigid pipe: ASTM 1248 (coil pipe not acceptable) - only 3" diameter pipe (see remarks for use of 4" pipe)</p>	<p>Sleeve joints</p>	<p>pipe meeting ASTM D 3350 and performance specification ASTM F 405 may be used without bedding</p>
	<p>*PE ADS N-12, ASTM F 667, AASHTO M-294</p>	<p>*Series 35 ADS coupling, o-ring gasket or WT Pipe/joint (Gasketed bell/spigot) Snap on sleeve joint</p>	<p>*Coupling: ASTM D 3034/F 1336. Joints (Coupling and WT) meet ASTM D 3212</p>

**Table 2-B
Approved Force Main (Pressure) Piping for Specific Applications**

USE	PIPE DESCRIPTION	ACCEPTABLE JOINT	REMARKS
<p>Force main piping within the sanitary radius of a water supply well, but no closer than the following minimum distances based on withdrawal rates: <10 gpm: 25 feet 10 – 50 gpm: 75 feet >50 gpm: 100 feet</p> <p>Force main piping no less than 25 feet from a water suction pipe.</p>	<p>PVC pressure pipe ASTM D 2241: SDR 21, 17, or 13.5</p>	<p>Bell and spigot with compression rubber gaskets</p>	
<p>Force main piping within 25 feet of an open watercourse, surface or groundwater drains (curtain/foundation).</p>	<p>PVC pressure water pipe AWWA C900 (PC 200 psi minimum)</p>		
<p>Force mains and pressurized water lines shall be installed in accordance with Section III D.</p>	<p>PVC ASTM D 1785 / ASTM D 2665, Schedule 40 or Schedule 80</p>	<p>Solvent welded, threaded joints or gasketed couplings</p>	
<p>Force mains should be kept a minimum of 10 feet from closed loop geothermal bore holes and trenches.</p> <p>There are no minimum distances between force mains and other items listed in Table 1. However items placed near force mains shall not damage or compromise the integrity of the pipe.</p>	<p>PE ASTM D 2239 PE ASTM D 2737</p> <p>PE ASTM D 3035, SDR 11 or lower</p>	<p>No joints within 75 ft. of well or 25 ft. of open watercourse, ground or surface water drains</p> <p>No joints, Heat butt fused connections ok</p>	<p>Pipe available in 100-ft. and longer coiled lengths</p>

Table 3
Approved Tight Pipe for Groundwater or Surface Water Piping within 25 Feet of a Sewage System

USE	PIPE DESCRIPTION	ACCEPTABLE JOINT	REMARKS
Solid groundwater and surface water drainage pipes within 25 feet of a sewage system.	Cast iron hubless pipe ASTM A-888	Cast iron split sleeve bolted connector with rubber gasket MG Coupling or 3"-wide, heavy duty stainless steel banded coupling with rubber gasket; Clamp-All, ANACO SD 4000 Coupling or equal	Roll-on "donut type" gaskets not acceptable if used within 25 ft. of watercourse or drain. Pipe shall be properly bedded in accordance with manufacturer's specifications, laid in a straight line on a uniform grade
	Cast iron bell and spigot ASTM A-74	Rubber compression gaskets	
	Ductile iron ANSI A21.51	Rubber compression gaskets	
	Extra strength PVC pressure water pipe AWWA C900 (PC 100 psi min.)	Rubber compression gaskets	
	Reinforced Concrete Pipe ASTM C 76	Rubber compression gaskets, ASTM C 443	
	Reinforced concrete water pipe, steel cylinder type, AWWA C300/ C-301	Rubber compression gaskets	
	Schedule 40 or 80, PVC ASTM D 1785 or ASTM D 2665	Rubber compression gasketed couplings, Harco Mfg., ASTM D3139 or equal* or Solvent weld couplings/fittings using proper two step PVC solvent solution procedure	*Use of 3"-wide approved stainless steel banded couplings on PVC ASTM D 1785 is acceptable
	PVC ASTM D 2241: SDR 21, 17 or 13.5		ABS Schedule 40 is not acceptable
	PVC ASTM F1760, SDR 35	Rubber compression gaskets or Solvent weld couplings/fittings using proper two step PVC solvent solution procedure	Joint shall meet ASTM D 3212 specifications.
	PVC ASTM D 3034, SDR 35		
PVC ASTM F 789	Elastomeric gasket meets ASTM F 477	Joint meets ASTM D 3212	
PVC ASTM F 679	Gaskets meet ASTM F 477	Joint meets ASTM D 3212	
PVC, CONTECH A-2026, ASTM F 949	Series 35 ADS coupling, o-ring gasket or WT Pipe/joint (Gasketed bell/spigot)	Coupling: ASTM D 3034/F 1336 Joints (Coupling and WT) meet ASTM D 3212	
PVC, CONTECH A-2000, ASTM F 949	Blue Seal coupling/rubber compression gasket	Joint meets ASTM D 3212	
PE, ADS N-12, ASTM F 667, AASHTO M-294, 24-inch maximum diameter	Gasketed bell and spigot joint	Joint meets ASTM D 3212	
PE, Hancor Blue Seal, ASTM F 667, AASHTO M-294, 24-inch maximum diameter	Gasketed bell and spigot joint	Joint meets ASTM D 3212	
PP, ADS HP Storm Pipe, ASTM F2736, AASHTO M330, 12" - 30" diameters			
PP, ADS SaniTite HP Sanitary Pipe, AASHTO M330, ASTM F2736 (12" -30" diameters), ASTM F2764 (30" - 60" diameters)			

IV. DESIGN FLOWS

A. Residential buildings

Design flows for residential buildings shall be based on the number of bedrooms (refer to Section I). The design flow per bedroom is 150 GPD, except for bedrooms beyond three in single-family homes that have a design flow of 75 GPD for each additional bedroom.

B. Nonresidential buildings and residential institutions

Table 4 shall be used to determine design flows for nonresidential buildings and residential institutions unless specific water use data (minimum 1 year period) is available from the building or similar facilities. Whenever water use data is utilized to calculate the design flow, data shall be accompanied with additional information (e.g., building size, plumbing fixture information, hours of operation) in support of the design. Design flows based on metered flows shall use a minimum 1.5 safety factor applied to the average daily water use.

The required effective leaching area (ELA) for SSDSs serving restaurants, bakeries, food service establishments, residential institutions, laundromats, beauty salons, and other nonresidential buildings with problematic sewage is based on the design flow and the application rates in Table 7. Such buildings or discharges are designated in Table 4 with a notation that Table 7 application rates are to be utilized. Problematic sewage is wastewater that is a concern due to the nature or strength of the sewage. The required ELA for SSDSs serving nonresidential buildings with non-problematic sewage is based on the design flow and the application rates in Table 8.

For nonresidential buildings that are not specifically listed in Table 4, the strength and nature of the wastewater shall be used to determine the appropriate application rate. The strength of the wastewater can be correlated to the 5-day biochemical oxygen demand (BOD5). For reference purposes, a wastewater BOD5 concentration of 110 mg/l is weak, 220 mg/l is medium, and 400 mg/l is strong per Metcalf and Eddy, Inc. *Wastewater Engineering-Treatment, Disposal, and Reuse Third Edition* (McGraw-Hill, Inc., 1991), table 3-16, p. 109. Weak strength wastewater shall utilize Table 8 application rates whereas strong wastewater shall utilize Table 7 application rates. Medium strength wastewater shall utilize Table 7 for a conservative design unless otherwise approved by the Commissioner.

Table 4

Building Type	Design Flow (GPD)
Schools, per pupil	
Base Flow (Excludes Kitchen & Showers)	
High School	12
Junior High/Middle School	9
Kindergarten/Elementary School	8
Day Care Center	10
Additional Flows for Kitchen & Showers	
Kitchen (Table 7 App. Rate)	3
Showers	3
Residential	100
Commercial Buildings**	
Office (Average 200 SF gross area/person), per employee	20
Retail/Supermarket Building*, per SF gross area	0.1
*Supermarkets shall increase design flow to account for delis and bakeries Deli and bakery flow: (Table 7 App. Rate)	
Industrial Building, per SF of gross area	0.1
Factory (Average 200 SF gross area/person), per employee (Add 10 GPD for showers)	25
**Design flows may be reduced if documentation (building/floor plans, statement of use, etc.) supports the reduction	
Camps/Family Campgrounds	
Residential Camp (Semi permanent), per person	50
Campground with Central Sanitary Facilities, per person	35
Campground per Camp Space (Water and sewer hook-ups)	75
Day Camp, per person	15

Residential Institutions (Table 7 App. Rate)	
Hospital, per bed	250
Rest Home, per bed	150
Convalescent Home, per bed	150
Institution, per resident	100
Residential motels/hotels, per room	150
Group Home/Community Living Arrangement, per client*	100-150**
*Use maximum occupancy unless state license restricts occupancy & requires DOH approval per PHC Section 19-13-B100a for occupancy increases	
**Use higher flow for large tub/on-site laundry.	
Restaurants, Food Service Establishments and Bars (Table 7 App. Rate)	
Restaurant (Public toilets provided), per seat	30*
Restaurant (No public toilets), per seat	20*
*Design flow shall be increased by 50% if breakfast, lunch & dinner are provided	
Take-out Food Service, per meal served	5
Bar/Cocktail Lounge (No meals), per seat (Table 8 App. Rate)	15
Recreational Facilities	
Swimming pool, per bather	10
Tennis Court, per court: indoor/outdoor	400/150
Theater, Sport Complex, per seat	3.5
Church/Religious Building	
Worship Service, per seat	1
Sunday School, per pupil	2
Social Event (Meals served), per person (Table 7 App. Rate)	5
Miscellaneous	
Auto Service Station, per car serviced	5
Salon, (Table 7 App. Rate)	
Per styling chair/station (hair)	200
Per pedicure chair/spa (5 gallon maximum basin)	100
Per manicure chair/station	50
Barber Shop, per chair	50
Dental/Medical Office with Examination Rooms, per SF of gross area	0.2
Dog Kennel, per run (Roof shall be provided) (Table 7 App. Rate)	25
Pet Grooming, per station (Table 7 App. Rate)	250
Laundromat (Non-DEEP Regulated), per machine (Table 7 App. Rate)	400
Motel (Transient, No Food Service, Kitchenette or Laundry Facilities), per room	75
Motel (Transient, With Kitchenette but no Laundry Facilities), per room	100
Marina (Bath-house & Showers Provided), per boat slip	20

C. Water usage monitoring and Permits to Discharge

Plans for large SSDSs (2,000 to 7,500 GPD) shall include provisions to monitor domestic sewage generation via the use of water meters or other available means (e.g., pump cycling and dose volume documentation). Permits to discharge issued by the DOH shall be on approved forms (Form #4 or approved equal) as required by PHC Section 19-13-B103e (h). Permits to discharge for limited SSDS repairs (e.g., septic tank or leaching system replacement only) shall document which SSDS components were and were not replaced. The discharge permits shall specify the design flow and permitted flow. The design flow shall equal the permitted flow, except for leaching system repairs that do not provide the required ELA or MLSS. The permitted flow for these leaching systems shall be prorated by using the most limited percentage of the required ELA or MLSS provided. The discharge permit shall recommend the average daily discharge not exceed 2/3 of the permitted flow in order to allow the SSDS to operate with a sufficient factor of safety and to accommodate peak flow conditions.

D. Management programs

DOHs and municipalities implementing decentralized sewage system management programs (e.g., Sewer Avoidance and Pump-out Ordinances, Decentralized Wastewater Management Districts) shall submit proposed or revised ordinances and regulations to the Commissioner for review prior to adoption.

V. SEPTIC TANKS AND GREASE INTERCEPTOR TANKS

A. General

1. Septic Tank Standards

SSDSs shall be provided with a septic tank made of concrete or other durable material. Septic tanks and grease interceptor tanks, including the riser and cover assemblies, located under vehicular travel areas shall be rated for H-20 wheel loadings. It is recommended that any single compartment septic tank be replaced in conjunction with leaching system repairs. If they are to remain in use they shall be evaluated to confirm they are in satisfactory condition and properly baffled. Proprietary leaching system companies may not support use of their products with single compartment septic tanks. The company should be consulted if a repair plan includes their leaching system product with a single compartment septic tank.

a) Concrete Septic Tanks

Concrete septic tanks shall be produced with a minimum 4,000-psi concrete with 4 to 7 percent air entrainment. Concrete septic tanks shall not be shipped until the concrete has reached the 4,000-psi compressive strength. Concrete septic tanks shipped prior to 14 days from the date of manufacture shall include documentation that the tank reached minimum strength prior to shipping. Concrete septic tank construction shall conform to the most current ASTM C 1227 standard with the following exceptions:

- There shall be no maximum liquid depth.
- The air space above the liquid level shall be a minimum of 8 inches.
- Inspection ports over the compartment wall shall be optional.
- The mid-depth connection can utilize a minimum 4-inch diameter pipe or mid-depth T-baffle connection.
- Inlet & outlet pipe connections shall be watertight tank seals whenever the plan designer specifies use of such seals.
- Effluent filters do not have to meet the performance criteria of NSF/ANSI Standard 46.

Concrete septic tank pre-casters shall file tank specifications and drawings with the Commissioner along with certifications by a P.E. stating the tanks meet ASTM C 1227 specifications and the requirements of this section prior to distribution of tanks in Connecticut. The Commissioner shall maintain a list of approved concrete septic tank pre-casters that have met this requirement, which shall be posted on the Department of Public Health's website.

b) Non-Concrete Septic Tanks

Non-concrete septic tanks shall meet all of the applicable requirements set forth in subsections 2, 3, and 4 of Section V A regarding tank configuration, access, and cleaning. Non-concrete tanks shall be marked with the manufacturer's name, tank designation number, size, and a "dangerous gas warning". Non-concrete septic tanks shall be installed with strict adherence to the manufacturer's installation instructions in order to avoid tank damage or deformation. Proper bedding and backfilling shall be confirmed with each tank installation. Shallow groundwater conditions may prohibit installation of certain tanks due to tank design limitations or warranty restrictions. Tank bottoms located below maximum groundwater levels shall be provided with anti buoyancy/floatation provisions (check with manufacturer). Non-concrete septic tanks shall meet the IAPMO/ANSI (International Association of Plumbing and Mechanical Officials/American National Standards Institute) Prefabricated Septic Tank Standard, unless otherwise approved by the Commissioner. Manufacturers of non-concrete septic tanks shall file and keep up-to-date specifications, technical support documentation, and dated installation instructions with the Commissioner. The Commissioner shall maintain a list of approved non-concrete septic tanks (Appendix D) that may be updated prior to the next publication of these standards.

2. Septic Tank Configuration

Septic tanks shall have an inlet baffle submerged to a depth of 8 to 18 inches. Septic tanks shall have an outlet baffle submerged to a depth of at least 10 inches but no lower than 40 percent of the liquid depth, or an approved effluent filter. Connection of piping and baffles made out of dissimilar materials (e.g., PVC and PE) require use of multi-purpose 2-step solvent cement meeting ASTM D 3138. The inlet baffle shall encompass not more than 48 square inches of liquid surface area. All baffles shall extend a minimum of 5 inches above the tank's liquid level and provide a minimum 1/2-inch air gap above the baffle. Inlet and outlet piping entering and exiting the septic tank shall be as level as possible with a pitch no greater than 1/4-inch per foot. All newly installed tanks shall have an approved non-bypass effluent filter that is rated for the design flow of the SSDS. Effluent filters shall provide a minimum of 45 square inches of total opening area. The Commissioner shall maintain a list of approved effluent filters (Appendix B) that may be updated prior to the next publication of these standards.

The outlet invert of the septic tank shall be 3 inches lower than the inlet invert. Tanks shall be installed with the inlet invert between 2 and 4 inches above the outlet invert. Septic tanks (except tanks in series) shall have two compartments with

approximately 2/3 of the required capacity in the first compartment (Figure 4). No compartment wall shall extend to the interior roof without providing for venting. The transfer port shall be at mid-depth (opening in middle 25 percent of liquid depth). Mid-depth T-baffles similar to those shown in Figure 5 may be used as the mid-depth connection. Inlet and outlet piping shall be sealed with a sealed flexible joint connector. Inlet and outlet pipe seals shall be watertight tank seals when specified on the approved plan. The minimum liquid depth of septic tanks shall be 36 inches.

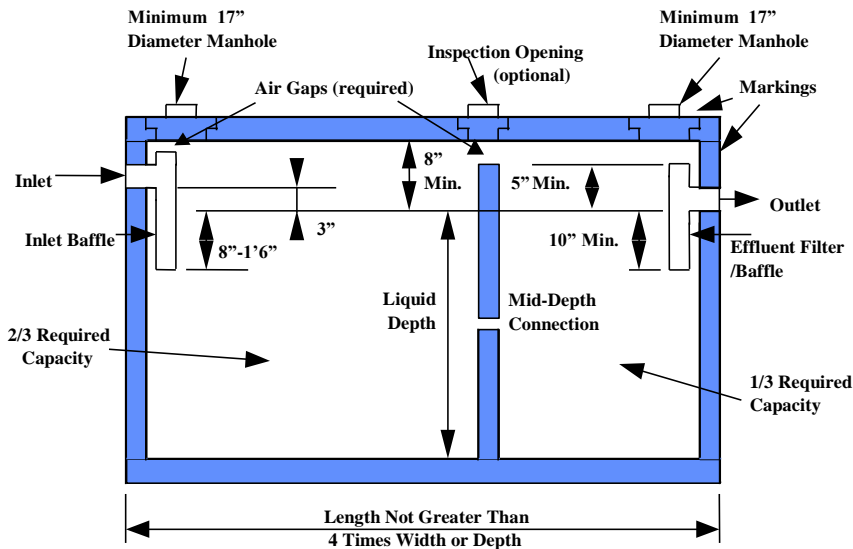

Figure 4 – Typical Septic Tank

Additional septic tank capacity may be obtained by utilizing a maximum of two tanks in series. When two septic tanks are placed in series, each tank shall be of single compartment design. The minimum volume of the first tank shall be twice the required minimum volume of the second. Mid-depth baffles shall be provided at the connection of the two tanks and an effluent filter shall be provided for the outlet of the second tank (Figure 5).

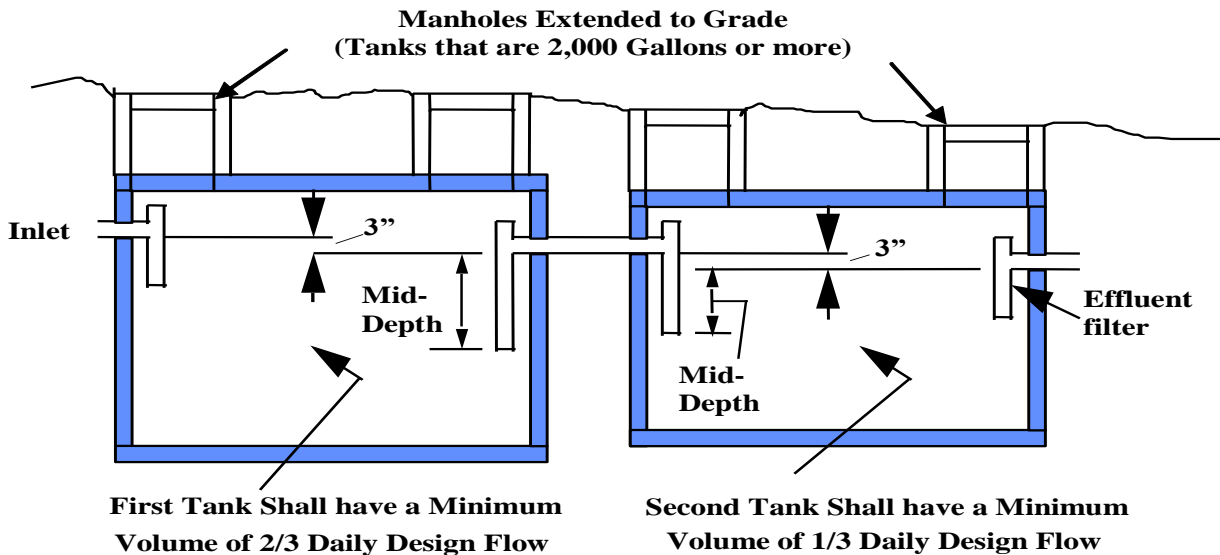

Figure 5 – Septic Tanks in Series

3. Septic Tank Access

Septic tanks shall have removable manhole covers to provide access for inspection and cleaning. Septic tanks shall have a minimum of 6 inches of cover. Cleanout manholes shall be located at a depth not greater than 12 inches below final grade. Existing septic tanks that exceed the 12-inch depth shall be retrofitted with a cleanout riser(s); riser retrofits are not required for non-cleanout openings (e.g., baffle openings) unless the opening provides access to an effluent filter. New tanks and existing tanks deeper than 24 inches below finish grade shall be provided with 24-inch minimum inside diameter access risers over each cleanout manhole opening. Riser cover assemblies shall be concrete or other durable material. Cleanouts

shall consist of a minimum 17-inch inside diameter opening and shall be located directly over the inlet baffle and effluent filter (Figure 6). If riser assemblies are utilized over cleanout openings, it is recommended that the covers be left on the tank for safety reasons, and to avoid potential odor problems. If a riser cover weighs less than 59 lbs then the tank cover shall remain in place or a secondary safety lid or device shall be provided. Secondary safety lids or devices are recommended to be utilized for safety reasons even if the riser cover weighs more than 59 lbs and the tank cover is removed.

If a tank provides side inlets, the maximum distance between the interior wall surface and the cleanout manhole shall be 15 inches unless heavy-duty piping (Schedule 40, ASTM D 1785/2665) is used or the pipe inside the tank is supported. Baffle extensions shall not have more than a 1/4-inch per foot pitch. Septic tank covers shall be stepped and provided with handles consisting of 3/8-inch coated rebar or approved plastic handles. Below ground plastic handles and plastic riser covers cannot be used unless provisions are made to allow for manhole location with a metal detector. Septic tanks in paved areas, and large (2,000 gallons or greater) septic tanks except for single-family residential buildings, shall have manholes extended to grade. Where covers are flush with or above grade, the lid shall weigh a minimum of 59 lbs or the cover shall be provided with a lock system to prevent unauthorized entrance. Riser and manhole extensions to grade shall be designed and constructed to prevent storm water infiltration. Positive drainage away from manhole covers in paved areas shall be provided. Tanks that exceed 15 feet in length shall provide a minimum of 3 manholes. The overall length shall not be greater than 4 times either the width or the depth.

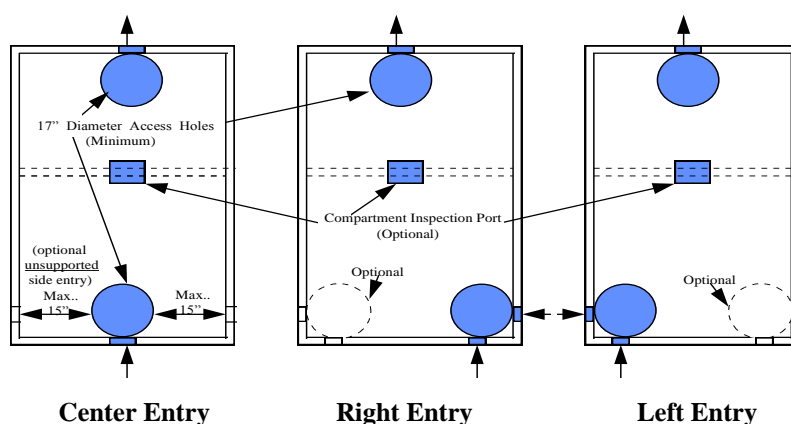

Figure 6 – Standard Septic Tank Configurations

4. Septic Tank Cleaning

Septic tanks shall be cleaned as often as necessary to prevent a buildup of sludge, grease and scum that will adversely affect the performance of the SSDS. In a properly functioning system, wastewater should not backflow from the leaching system into the septic tank at the time of pumping under normal use conditions (not as a result of large volume flood tests). Backflow indicates the leaching system is surcharged, and unless otherwise required by the DOH, tank pump-out reports shall note the backflow conditions and state the system was “malfunctioning” at the time of the septic tank pump-out. As with other malfunctioning system signs (e.g., effluent overflowing outlet baffle, back-up into building sewer or riser), a recommendation should be made for a more in-depth assessment of system operation by a licensed installer unless the condition is a result of a clogged effluent filter. SSDSs that discharge sewage onto the ground surface, into an open watercourse, or otherwise cause health hazards or nuisance conditions shall be identified as “failing”. The DOH shall investigate the failure and take necessary action pursuant to PHC Section 19-13-B103c (f) to abate the conditions.

Inlet and outlet baffles shall be inspected for damage or clogging at the time of tank pumping. If provided, effluent filters shall be properly cleaned by rinsing the filter off with water directed back into the septic tank, or if water is not available, exchanged with a new effluent filter with the property owner’s permission. Used effluent filters contain sewage and shall be handled in a sanitary manner during the cleaning or exchange process.

5. Septic Tank Markings

Tank information (size, date manufactured, name of manufacturer, and indication of limit of external loads/cover depths required by Section 13 of ASTM C 1227) shall be located on the top of the tank between the outlet access hole and outlet wall, or on the vertical outlet wall between the top of the tank and the top of the outlet opening. All septic tanks shall be manufactured with manhole covers or risers that have been placarded with notification of its two-compartment construction and a warning that “Entrance into the tank could be fatal”.

6. Performance Testing

Watertight tank seals shall be specified whenever tank water-tightness is critical such as when infiltration into a pump chamber is a concern, or when a replacement septic tank is within the sanitary radius of a water supply well. Plans or approvals requiring tank leakage testing shall utilize a vacuum test or water-pressure test in accordance with the following, unless otherwise specified by the design P.E.:

Vacuum Test: Assemble empty tank including temporary sealing of inlet and outlet pipes and all access openings. Attach a vacuum device that is capable of drawing a minimum vacuum pressure of 7 inches (175 mm) of mercury (Hg). To measure negative pressure drawn, the vacuum device shall utilize a calibrated gauge (range no greater than 0-10 inches/Hg), mercury manometer, or water manometer accurate to within 0.2 inches/Hg. Apply a vacuum to 4 inches (100 mm)/Hg. Tank passes leakage test once the tank holds the negative pressure for 5 minutes without loss of pressure. If the tank is unable to hold the required pressure for 5 minutes then the tank can be repaired per manufacturer's recommendations and retested.

Water-Pressure Test: Seal the tank. Fill with water and let stand for 24 hours. Refill the tank. The tank passes the leakage test if the water level is held for 1 hour.

B. Septic tank capacities

1. Residential Buildings

The minimum liquid capacities/volumes of septic tanks serving residential buildings shall be based on Table 5.

Table 5

	Single-family	Multi-family
1-3 bedrooms	1,000 gallons	1,250 gallons
For Each Bedroom Beyond 3	Add 125 gallons per bedroom	Add 250 gallons per bedroom

2. Non-residential Buildings & Residential Institutions

The liquid capacity of a septic tank serving a non-residential building or a residential institution shall be a minimum of 1,000 gallons or the 24-hour design flow (Section IV), whichever is greater. A building generating a high peak flow shall have a septic tank providing a minimum detention time of 2 hours under peak flow conditions. The detention time is the tank liquid volume divided by the flow rate through the tank. The required septic tank capacity shall be increased by a minimum of 50 percent at a food service establishment or restaurant for a repair of an existing SSDS where it is determined that it is not feasible to install a grease interceptor tank or internal automatic grease recovery unit (AGRU).

3. Raw Sewage Pumps

Whenever more than 25 percent of the building's design flow will be pumped into the septic tank, the size of the tank shall be increased 50 percent beyond the minimum capacity required per Section V B.

4. Garbage Grinders, Large Bathtubs, & Water Treatment Wastewater

Garbage grinders are not recommended for use with SSDSs. Only certain water treatment wastewater (WTW) is authorized to discharge to a SSDS (refer to Section X and Appendix E for WTW discharge requirements). The minimum liquid capacity of a septic tank shall be increased whenever a building contains a garbage grinder, large capacity bathtub, or WTW is discharged to the SSDS in accordance with the following:

Garbage grinder: Add 250 gallons.

Large bathtub: Add 250 gallons for 100 to 200 gallon bathtubs.
Add 500 gallons for bathtubs over 200 gallons.

WTW: Add 250 gallons for discharges of 50 to 150 gallons per cycle.
Add 500 gallons for discharges greater than 150 gallons per cycle.

C. Grease interceptor tanks

Grease interceptor tanks (GITs) shall be provided for restaurants and food service establishments with design flows of 500 GPD or greater for new construction and repairs of existing SSDSs where feasible. If it is not feasible to install a GIT for a food service/restaurant SSDS repair, an internal AGRU is recommended for the wastewater piping in the kitchen. If a GIT or an internal AGRU is not included in a food service/restaurant SSDS repair, then the required septic tank capacity shall be increased by 50 percent (Section V B).

GITs shall receive wastewater from the kitchen waste lines only. Effluent discharged from the GIT shall be directed to the inlet end of the septic tank. The liquid capacity of GITs shall be a minimum of 1,000 gallons or the 24-hour design flow, whichever is greater. For restaurants and food service establishments with design flows of 2,000 GPD or greater, two GITs in series shall be provided with a combined liquid volume meeting or surpassing the 24-hour design flow. GITs shall have inlet and outlet baffles that extend to a depth of 6 to 12 inches above the tank bottom (Figure 7) and extend at least five inches above the liquid level. Effluent filters are not required on GITs, but they can be used if the manufacturer of the filter specifies that it is suitable for such use. All manholes over GIT cleanouts shall be watertight and extended to grade to facilitate cleaning. Positive drainage away from manhole covers in paved areas shall be provided. Tanks deeper than 24 inches below finish grade shall be provided with large (24-inch minimum inside diameter) access risers over each cleanout manhole opening. GITs shall be provided with manhole covers that have been placarded with notification as to the danger of entering the tank due to noxious gases. Covers to grade shall weigh a minimum of 59 lbs or the cover shall be provided with a lock system to prevent unauthorized entrance. If riser assemblies are utilized over cleanout openings, it is recommended that the tank covers be left on the GIT for safety reasons, and to avoid potential odor problems. If a riser cover weighs less than 59 lbs then the tank cover shall remain in place or a secondary safety lid or device shall be provided. Secondary safety lids or devices are recommended to be utilized for safety reasons even if the riser cover weighs more than 59 lbs and the tank cover is removed.

GITs can be single or two compartment tanks and shall be constructed out of concrete or other durable material. Concrete GITs shall meet all structural and access requirements for concrete septic tanks. This includes applicable configuration (pipe seals, inlet/outlet differential, etc) and access requirements (riser sizes, stepped covers, etc.) consistent with the requirements for concrete septic tanks. Concrete GITs shall be marked with tank information (size, name of manufacturer, date manufactured, loading limits), and be subject to other applicable septic tank provisions (performance testing, cleaning, tank abandonment, etc). Non-concrete GITs shall also meet the requirements for concrete GITs excluding the structural and marking requirements. Non-concrete GITs shall be marked with the manufacturer's name, designation number, size, and a "dangerous gas warning". The Commissioner shall approve non-concrete GITs. Some manufacturers of plastic septic tanks do not authorize their tanks be used as GITs due to the high temperature of the wastewater.

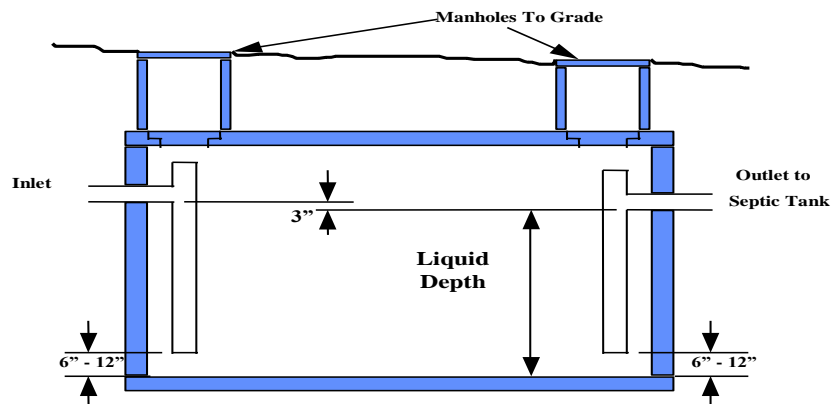

Figure 7 - Grease Interceptor Tank

VI. EFFLUENT DISTRIBUTION, PUMP SYSTEMS & AIR INJECTION PROCESSES

A. General

Distribution of septic tank effluent to a leaching system shall promote uniform distribution and full utilization of the system, and can be accomplished by gravity, pump, siphon, or dosing method approved by the Commissioner. Approved dosing methods include the Rissy Plastics Floating Outlet Distribution Chamber, Premier Plastics Flout Dosing Tanks, and the Geomatrix HyAir Pump System. Leaching systems shall be designed to prevent effluent backflow into the septic tank. The septic tank outlet invert shall be at a higher elevation than the top of all leaching structures (except in pump systems), or in the case of leaching systems utilizing serial distribution, higher than the high-level overflow elevation of the upper most leaching system row. It is recommended that SSDS be designed to allow for gas and air transfer from the leaching system back through the septic tank and building vents. Fully flooded distribution boxes should be avoided, and it is recommended that distribution piping/boxes be designed so that there is an air space in all pipes during normal leaching system operation. Leaching systems designed for serial distribution shall be designed so that the high-level overflow invert elevations are within the top 3 inches (0.25 feet) of the leaching structure. It is noted that gas and air transfer can be limited in serial distribution systems. Providing holes in the top portion of perforated effluent distribution pipe above the high-level overflow elevation can promote gas transfer.

Leaching systems shall include access points consisting of distribution boxes, cleanouts (galleries, pits), or capped sanitary tees. Leaching system access points on large and non-residential SSDs in paved areas shall be provided with H-20 load rated risers to grade. At least one access point shall be provided for each leaching system row. A single distribution box feeding row segments at the same elevation on either side of the distribution box shall constitute access points for both row segments. Leaching systems with rows at the same elevation shall have ends connected wherever feasible (Figure 8). Non-level leaching systems may apply effluent by dosing (pump, siphon, approved method), serial distribution with high-level overflow (Figures 9 and 10), or by approved effluent splitting devices (e.g., Polylok Dipper D-Box, Equalizer pipe inserts, Zoeller Tru Flow D-box).

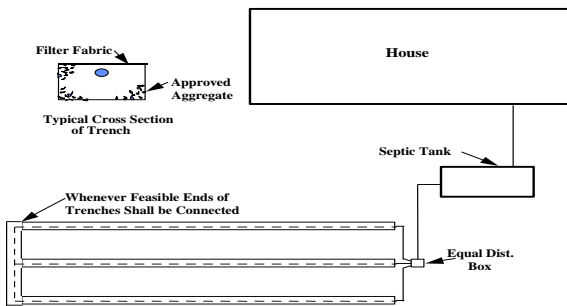

Figure 8 - Level Leaching Systems

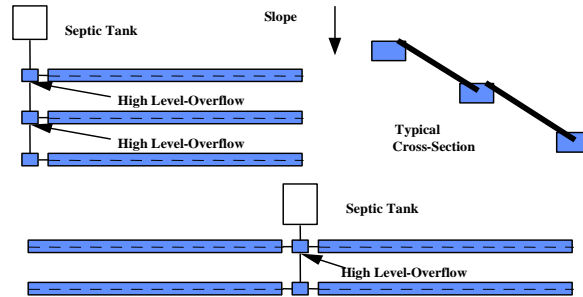
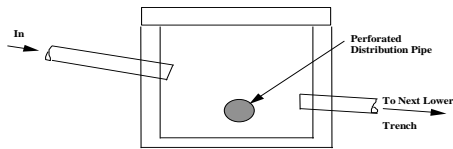
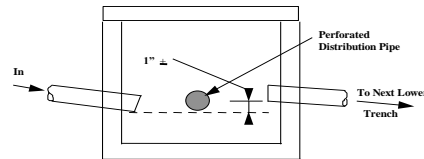

Figure 9 - Serial Distribution Systems



High - Level Overflow Dist. Box



Reversed Distribution Box

Note: The high-level overflow invert elevation shall be set within the top 3 inches of the upper leaching system row. The use of reversed distribution boxes should be avoided if gas venting is restricted.

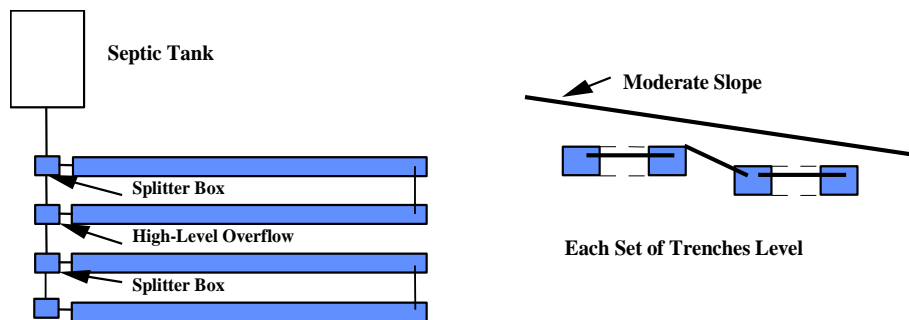

Figure 10 - Alternative Distribution Systems & D-Boxes

B. Mandatory Dosing

Large SSDs with more than 600 LF of leaching system shall utilize intermittent dosing arrangements. Dosing can be accomplished by pump, siphon, or other approved method. Dosing systems shall be designed to dose the leaching system at a frequency of 3 to 6 cycles per day unless timed dosing is utilized. Dosing chambers shall have access manholes to grade. Large SSDs utilizing pump systems shall be designed with duplicate alternating pumps. Alternating pump and siphon systems shall be designed to provide full leaching system utilization in the event one pump or siphon fails to operate.

C. Pump Systems

Effluent pump chambers shall be provided with watertight risers/manholes to grade and high-level alarms. The alarm shall be both audible and visual, unless otherwise approved by the DOH, and be located so that it readily alerts building occupants when activated. Existing pump chambers shall be retrofitted with risers to grade if not currently provided. Pump chambers shall provide 24-inch minimum inside diameter risers over access manholes. Covers to grade shall weigh a minimum of 59 lbs or the cover shall be provided with a lock system to prevent unauthorized entrance. When riser assemblies are utilized over an access opening, it is recommended that the tank cover be left on the chamber for safety reasons, and to avoid potential odor problems. If a riser cover weighs less than 59 lbs then the chamber cover shall remain in place or a secondary safety lid or device shall be provided. Secondary safety lids or devices are recommended to be utilized for safety reasons even if the riser cover weighs more than 59 lbs and the chamber cover is removed.

Effluent pumps shall be approved by the manufacturer for use in SSDSs. Force mains shall be freeze protected by burying the pipe below the frost line, allowing back drainage into the pump chamber through a weep hole, or other acceptable means (e.g., insulation). Back siphonage from the leaching system and/or excessive pump cycling shall be avoided when a weep hole is provided. Pump chambers in shallow groundwater areas shall utilize watertight tank seals and should be tested for leakage to ensure water tightness.

When a pump chamber is utilized for a small SSDS (< 2,000 GPD), it shall be provided with either duplicate alternating pumps, or a single pump and have a minimum emergency storage volume equal to the daily design flow. Emergency storage volume is measured from the alarm level to the inlet pipe invert (Figure 11).

Specifications shall be provided for all the internal components of the pump chamber (e.g., pumps, piping, floats, transducers, alarms, disconnect chain, valves). Pump on/off levels and alarm level shall be specified along with the dose volume and emergency storage provided. Pump systems can utilize pressure transducers, mechanical float switches, or other acceptable controls. The sale of mercury float switches is banned in Connecticut. The pump shall be rated to handle the design flow rate at the total dynamic head for the installation. A check valve shall be provided on the pump discharge line unless the pump manufacturer does not require one. Check valve and weep hole locations shown in Figure 11 are for illustrative purposes only; actual locations shall be established by the SSDS designer. Pipe unions, lift chain and manhole location shall allow for convenient pump removal for routine maintenance, and electrical and pump connections shall be readily accessible from the ground surface. Piping attached to the pump shall be set close enough to the top of the chamber under the manhole to allow for servicing, and a quick-disconnect device shall be utilized to allow for easy removal of the pump for maintenance. Internal pump chamber appurtenances shall be non-corrosive and suitable for the corrosive effluent environment. Electrical work for pump systems and alarms requires a permit from the local building official.

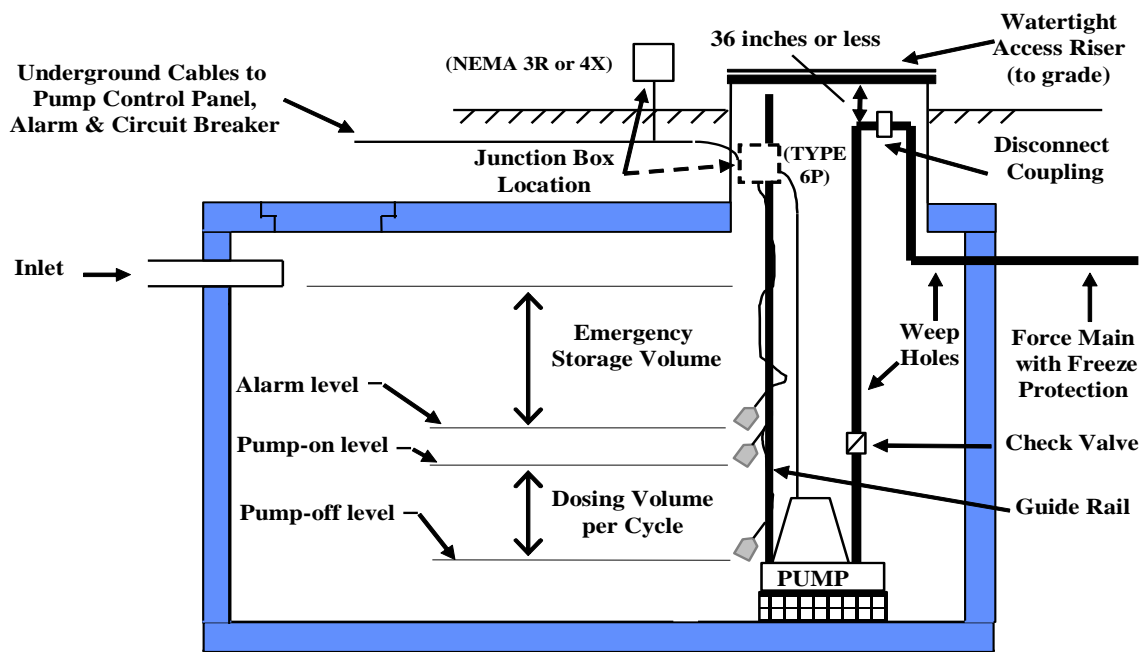

Figure 11 - Pump Chamber

Pump systems can utilize timed-dosed or volume-dosed systems. Pump systems shall avoid dosing large volumes of effluent into proprietary leaching systems with limited storage capacities. It is recommended that the dosed volume not exceed 20 percent of the internal storage volume unless otherwise approved by the proprietary leaching system company.

Pump chambers shall be made out of concrete or other durable material. The Commissioner shall approve non-concrete pump chambers. The inlet of the pump chamber shall be no higher than the septic tank outlet. Pump chambers, including the riser and cover assemblies, located under vehicular travel areas shall be rated for H-20 wheel loadings. Non-concrete pump chambers shall be installed in accordance with the manufacturers' instructions (refer to Section V A 1 b for other requirements). Concrete pump chambers shall meet all structural requirements for concrete septic tanks, marked with tank information (size, manufacturer, date made, loading limits), and are subject to other applicable concrete septic tank provisions (e.g., performance testing).

Low-pressure distribution (LPD) used in conjunction with leaching trenches, leaching galleries, and proprietary leaching systems require a design by a P.E., unless the leaching system manufacturer applies for and receives approval from the Commissioner for non-P.E. designed LPD arrangements that can be used with their systems. Leaching system manufacturers requesting such approval shall file supporting documentation with the Commissioner that details their standardized LPD design, and approval for a leaching system manufacturer's non-P.E. LPD design can be granted if a determination is made that the dosing system is sufficiently detailed and designed so that a P.E. design is not warranted. P.E. designs of LPD systems shall include access and flushing provisions for the purpose of routine maintenance and checking pressure in the lines, and provisions shall be provided for flow adjustment to the distribution lines. LPD designs shall provide system details on pressure filters, orifice shields, manifold access and pipe (size, specifications, diameter & spacing of piping holes) and pump information. The LPD designer shall specify O & M requirements for the system (e.g., flushing of the lines, checking pressure heads).

Passive nitrogen reduction (PNR) technology may be utilized in conjunction with a SSDS installation that utilizes LPD or a proprietary pressure-dosed dispersal (PPD) system. PNR technology does not aerate the contents of the septic tank and only uses a single pump or dual alternating pumps for LPD or the PPD system. PNR technology uses a clean subsurface wood product (e.g., sawdust, wood chips, mulch) through which partly treated sewage effluent flows. The wood product may be installed within a saturated or unsaturated soil treatment environment. The wood product provides a carbon source for denitrification of nitrified wastewater below or downgradient of a leaching system.

Successful use of PNR technology requires strict design and installation controls to ensure it doesn't interfere with the proper operation of the SSDS. PNR technology is relatively new and its use should be limited until such time that standardized design criterion is established. PNR technology use shall be limited to areas where nitrogen pollution from on-site sewage systems is a concern, such as high density residential development areas under community pollution abatement orders. PNR technology should only be permitted if the DOH has determined that its usage is appropriate, and the DOH has sufficient resources to ensure the systems are properly designed and installed.

SSDS designs that include PNR technology must have detailed plans that include information and specifications on the dosing system, wood product, and soil treatment horizons. Typically PNR technology mixes wood product with a specified category of clean soil (e.g., sand, loamy sand). Plans must provide a plan view and cross sections detailing the leaching system, wood product, added soil, restrictive layers, and all pertinent depths and elevations. Plans must include media placement and construction requirements, and information on any monitoring mechanisms. The DOH shall require the plan designer of a SSDS that includes PNR technology to supervise installation of the system and provide a written certification that the system was installed in conformance with the approved plan.

The use of PNR technology requires that the DOH provide the Commissioner notice of proposed installations on small SSDSs prior to issuance of an approval to construct. This will allow for a determination to be made if the system may be classified as an alternative treatment system, which can only be permitted by the Department of Energy and Environmental Protection. Notice is not required for large SSDSs as plans for these systems require approval from the Commissioner.

Raw sewage pumps are not recommended for use with SSDSs; however when they are necessary, solids handling pumps (ejector) are preferred over grinder pumps. If raw sewage pumps are needed for basement fixtures, upper floor flows should be directed to the septic tank by gravity where feasible. In the event more than 25 percent of the design flow is pumped to the septic tank, the required septic tank capacity shall be increased by 50 percent (Section V B 3). Force main foundation penetrations shall comply with the plumbing code, which is under the purview of the local building official. A raw sewage pump located outside a building is considered part of the SSDS, and shall be installed in compliance with the separation distances in Table 1. Raw sewage pumps/vaults below a building's slab elevation are considered outside the building unless they are installed in a sealed pit or otherwise designed to contain potential leakage inside the building. Exterior raw sewage pump vaults shall have an access opening to grade and be equipped with a malfunction alarm. Exterior raw sewage pump vaults that serve buildings, other than outbuildings, shall have dual alternating pumps or provide

24-hour emergency storage for the design flow they handle if the building's occupants only have access to bathroom facilities that rely on the raw sewage pump vault for its operation.

Combination septic tank/pump systems may be utilized in instances where space constraints, site limitations or other technical justification make it advantageous to install a single tank/pump unit. Combination septic tank/pump systems shall utilize a screened pump vault designed for that application, which is installed in the second compartment of an oversized two-compartment septic tank. The combination tank shall be sized to provide 24-hour emergency storage if a single pump is utilized. The tank liquid level should only draw down in the second compartment; however limited draw down in both chambers may be included in the SSDS design if the pump manufacturer authorizes such practice. Use of mid-liquid depth tee baffles with a compartment connection pipe at the liquid level shall be utilized to draw down effluent in second compartment only (Figure 12). The required septic tank capacity shall be provided below the "pump-off" level.

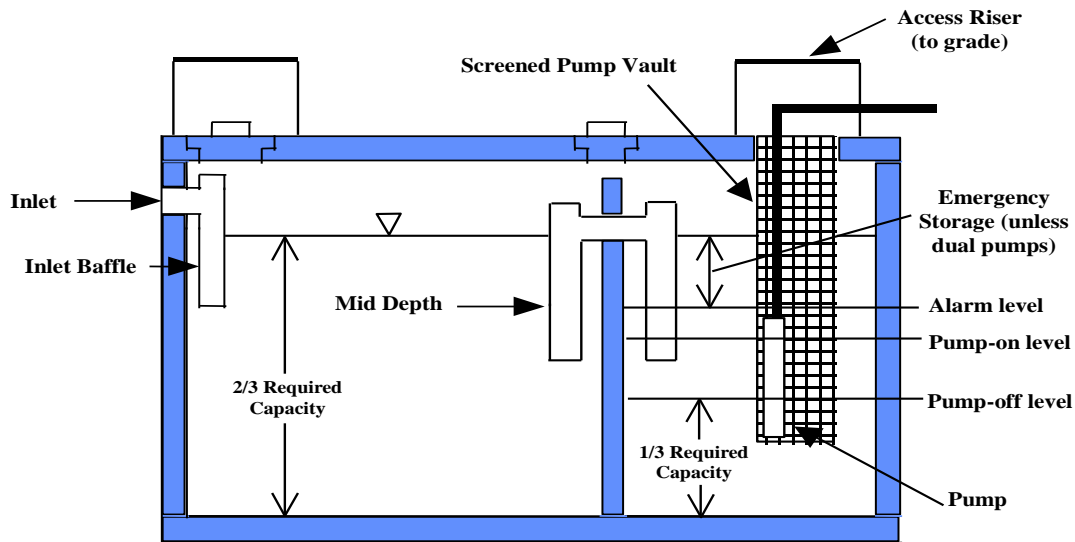

Figure 12 - Combination Septic Tank/Pump System with Tee Baffle Connection

D. Leaching System Enhancement/Rejuvenation

The patented Soil Air System provided by Geomatrix, LLC may be utilized on new SSDSs, or on existing SSDSs that are not at risk of hydraulically overloading the receiving soil and provide the required minimum separation distance above ledge rock and maximum groundwater. Utilization of the Soil Air System requires a permit from the DOH. A site investigation shall be required to gather soil test information if the data is not available.

Existing SSDSs that are determined to be candidates for the Soil Air System shall be evaluated to determine the extent of current code compliance. A repair plan shall be prepared identifying the location of the existing system and a code-complying area. Sites that cannot support a code-complying area shall have a potential repair area identified. Large SSDSs require engineered plans that shall be approved by the Commissioner as required by PHC Section 19-13-B103d (c). The DOH may require a P.E. plan for small (< 2,000 GPD) SSDSs in areas of special concern in accordance with PHC Section 19-13-B103d (e)(4).

The Soil Air System shall not be utilized on cesspools, or excessively undersized leaching systems unless determined that it is not feasible to expand the leaching system. Leaching systems are considered to be excessively undersized if they provide less than 50 percent of the required ELA. The DOH may require further upgrades to existing SSDSs in conjunction with implementation of the Soil Air System. Upgrades may include leaching system expansion or the installation of additional tanks (septic, grease interceptor). Soil Air Systems may be installed with the placement of a plastic membrane over the leaching system. Placement of such a membrane over a proprietary leaching system requires authorization from the proprietary leaching system company.

Soil Air Systems shall be periodically evaluated and monitored to verify satisfactory system operation. The permit to discharge shall stipulate that the DOH be notified in writing in the event the Soil Air System is removed. A standard tee baffle can only be utilized in place of an effluent filter on the septic tank outlet if Geomatrix, LLC and the system designer are in agreement that it is acceptable. The effluent filter shall be re-installed if the Soil Air System is removed.

E. Leaching System Clogging Break-up

EarthBuster and Terra-lift are separate patented processes each utilizing air injection into the soil as a method intended to help rejuvenate an existing leaching system's soil interface. These processes may be used on leaching systems that provide the required minimum separation distance above ledge rock and maximum groundwater, and that have historically operated satisfactorily but have experienced declining capacity due to infiltrative surface clogging. The depth of air injection shall not exceed the depth of the leaching system bottom and locations shall be no closer than 2 feet horizontally to the leaching system sidewall. Use of either process requires a permit from the DOH. A site investigation shall be required to gather soil test information if the data is not available.

Existing SSDSs that are determined to be candidates for either process shall be evaluated to determine the extent of current code compliance. A repair plan shall be prepared identifying the location of the existing system and a code-complying area. Sites that cannot support a code-complying area shall have a potential repair area identified. Large SSDSs require engineered plans that shall be approved by the Commissioner as required by PHC Section 19-13-B103d (c). The DOH may require a P.E. plan for small (< 2,000 GPD) SSDSs in areas of special concern in accordance with PHC Section 19-13-B103d (e)(4).

EarthBuster and Terra-lift shall not be utilized on cesspools, or excessively undersized leaching systems unless it is determined that it is not feasible to expand the leaching system. Leaching systems are considered to be excessively undersized if they provide less than 50 percent of the required ELA. The DOH may require further upgrade of existing SSDSs in conjunction with implementation of either process. Upgrades may include leaching system expansion or the installation of additional tanks (septic, grease interceptor).

VII. PERCOLATION TESTS

A percolation test consists of three steps: 1) presoaking the percolation hole, 2) refilling and allowing the hole to saturate under certain conditions, and 3) determining the minimum uniform percolation rate after saturation. The purpose of the presoak is to allow sufficient soil-water contact time. During the presoak, swelling clays that may be present in the soil will expand thereby reducing the void space. Sufficient presoaking allows the advancing capillary wetting front, which controls the water flow rate in unsaturated soils, to move away from the test hole so that a uniform flow rate is reached. Percolation tests should be avoided when the ground is saturated from heavy rain/flooding or a frost layer exists.

Percolation tests shall be performed in 6 to 12 inch diameter holes dug into the receiving soil in order to establish the percolation factor for MLSS purposes (Appendix A). Percolation holes should be at the depth of the proposed leaching system to establish the percolation rate for sizing purposes. If fill material or disturbed naturally occurring soil is the receiving soil, numerous percolation tests must be conducted to establish the percolation rate as the rate may vary widely, and to determine whether soil replacement is necessary. Leaching systems that are to be elevated in select fill require additional percolation tests after select fill placement to confirm the percolation rate of the select fill is not slower than the design rate. When receiving soil contains distinct soil strata of different texture or structure, each stratum shall be tested separately with holes at relative depths. In calculating the required leaching area (primary and reserve), only representative test results in the area and at the depth of the proposed leaching system shall be used, but all tests shall be reported.

Presoaking shall be started by filling the hole with a 12-inch depth of water. If the water seeps away in less than 2 hours, the hole may be refilled to a 12-inch depth and the percolation test begun. If water remains after 2 hours, the hole shall be refilled to a 12-inch depth and allowed to presoak for 2 additional hours before starting the percolation test, unless the soil contains little clay. Holes that contained water for at least 4 hours shall be considered adequately presoaked. Tests performed immediately after the presoak period yield more accurate results. If more than 30 hours have elapsed following the initial presoak, the test hole shall be presoaked once again. Following the presoak, the hole shall be refilled with 12-inch depth of water to begin percolation test. Water level readings shall be recorded at regular intervals and shall continue until there is 2 to 3 inches of water remaining in the hole. Additional readings may not accurately reflect the percolation rate as fine soil particles may accumulate at the bottom portion of the hole. The minimum uniform percolation rate following saturation shall be used to calculate the size of the leaching system.

If a leaching system is constructed entirely in select fill and the bottom of the system is above existing grade, then the required ELA can be determined based on the percolation rate of the select fill. Using a percolation rate faster than 10.1 minutes per inch may be problematic if the percolation rate in the select fill is determined to be slower; it is suggested to use a conservative design percolation rate of 10.1 to 20.0 minutes per inch. Although the required ELA can be determined by the percolation rate of the select fill, the MLSS shall be based on the percolation rate of the receiving soil that may be considerably slower.

VIII. LEACHING SYSTEMS

A. General

Leaching systems shall not be constructed in areas where high groundwater, surface flooding or ledge rock will interfere with its operation. Leaching systems should be installed as shallow as possible and preferably not under parking or vehicular travel areas. The maximum depth of the bottom of a leaching system below finished grade shall be 8 feet. The maximum width of leaching products (e.g., trenches, galleries, proprietary systems) is 6.5 feet, except for leaching pits. Entering deep test pits above the waist can result in bodily harm or death in the event of cave in. Use of shallow shelves is recommended to allow for assessment of the soil in the upper profile of the pit. Refer to OSHA standards for pit safety measures and restrictions. Site investigation documentation shall be recorded on Form #2 or Form #2 Alternate.

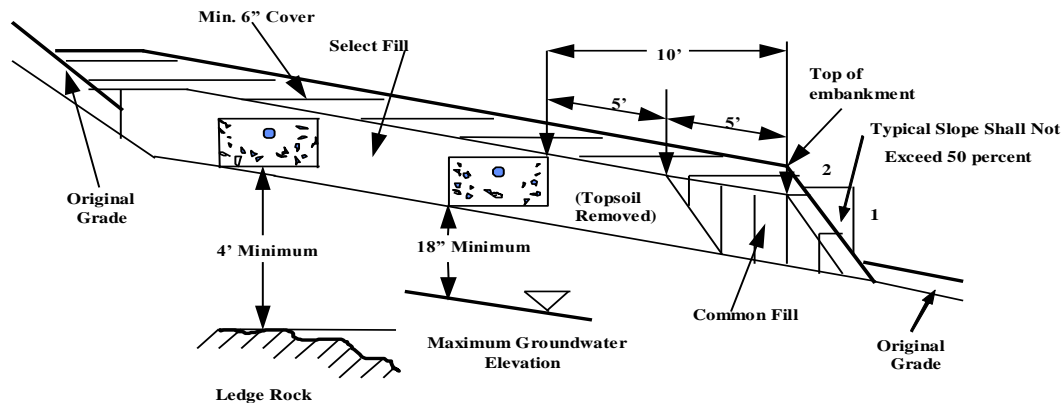

Figure 13 - Minimum Separating Distances above Ledge Rock and Maximum Groundwater

The bottom of a leaching system shall be a minimum 18 inches above maximum groundwater and 4 feet above ledge rock. Additional separation shall be provided as follows:

- If the receiving soil percolation rate is faster than 5.0 minutes per inch, the minimum separation to maximum groundwater shall be increased to 24 inches.
- If the receiving soil percolation rate is faster than 1.0 minute per inch, the minimum separation above ledge rock shall be increased to 8 feet or the distances shall be doubled from any water supply well in accordance with the special provisions in Table 1 (Item A).
- Large SSDSs shall provide a minimum 24 inch separation above maximum groundwater.
- SSDSs in coastal areas on sites with tidally impacted groundwater tables shall provide a minimum 24 inch separation above maximum groundwater. Maximum groundwater determinations in coastal areas shall take into account water level rise associated with tide changes.

The ground surface over the entire SSDS shall be graded and maintained to lead surface water away from the system. SSDSs shall be protected from siltation and erosion during and after construction. Leaching systems (including distribution pipes on top of system) shall be covered with a minimum of 6 inches of soil, and finished in a condition that will prevent erosion. Proprietary leaching systems shall be covered with additional soil in conformance with the manufacturer's installation instructions. Licensed installers shall properly cover leaching systems within 2 working days following the DOH's final inspection and approval, and prior to heavy precipitation events.

Plans for new SSDSs, code-complying areas, designated leaching system areas for proposed lots, and repairs of existing leaching systems shall demonstrate compliance with the Minimum Leaching System Spread (MLSS) requirements in Appendix A. Exceptions to MLSS compliance can only be granted for SSDS repairs, and a reduced flow per Section IV C shall be cited on the Permit to Discharge for non-compliant repairs. MLSS is not applicable on sites with more than 60 inches of receiving soil, or when a P.E. has conducted an assessment of the hydraulic capacity of the receiving soil, or for reserve leaching areas. It is recommended that reserve leaching areas comply with MLSS. SSDSs on sites with a receiving soil depth (RS Depth) of less than 18 inches shall require a P.E. hydraulic analysis of the receiving soil.

New SSDSs require naturally occurring receiving soil native to a site. Naturally occurring soil is formed from natural processes independent of human actions, and does not include fill placed by humans or deposited as a result of human actions. Repairs of existing SSDSs may use fill material as receiving soil if sufficient naturally occurring soil is not available. Plans for a new SSDS shall not be denied upon MLSS non-compliance, but shall be denied if compliance with PHC Section 19-13-B103e (a) (4) is not demonstrated. This regulation prohibits approval of a new SSDS when the surrounding naturally occurring soil cannot adequately absorb or disperse the expected volume of sewage effluent without

overflow, breakout, or detrimental effect on ground or surface water. Approval of new SSDSs on sites with less than 18 inches of naturally occurring soil cannot be considered unless a P.E. satisfactorily demonstrates through a hydraulic analysis or loading test that the naturally occurring soil can disperse the design flow. Sites without any unsaturated naturally occurring soil are not candidates for a hydraulic assessment since the naturally occurring soil is already in an overflowed/saturated condition.

DOHs should advise against the creation of new lots that have unsuitable soil conditions pursuant to PHC Section 19-13-B103e (a) in the primary or reserve leaching system area. Leaching system areas for new SSDSs and code-complying area designations shall not contain unsuitable soil conditions. Leaching system areas includes soil within 10 feet in all directions around the perimeter of the leaching system. Unsuitable soil conditions include areas with less than 18 inches of soil above maximum groundwater or less than 4 feet of soil above ledge rock.

New SSDSs constructed in areas where there is no definite schedule for the extension of public sewers within 5 years shall be laid out in such a manner to provide an acceptable reserve leaching area of suitable soil, or in the case of existing single-family residential building lots created prior to January 1, 2007, potentially suitable soil. An area with potentially suitable soil contains less than 4 feet of existing soil above ledge rock but at least 2 feet of which is naturally occurring soil. Reserve areas shall be sized based on its percolation rate and have the feasibility to be constructed in conformance with all aspects of the PHC and Technical Standards, except MLSS, for the purpose of expansion or replacement of the primary leaching system. Reserve areas are not required for repairs of existing leaching systems, or for outbuildings with a design flow of 150 GPD or less on single-family residential building lots. Single-family residential building lots are not required to prepare a reserve area with any select fill at the time of installation of the primary system. Reserve areas for multi-family dwellings and commercial buildings do not have to be prepared with select fill unless the designated reserve area is located under asphalt pavement or poured concrete (parking or vehicular travel areas).

Non-linear level leaching systems (e.g., interconnecting end sections, L-shaped, U-shaped, Box shaped) may be credited in certain instances. However, the length of the main row(s) shall only be measured to the center of the interconnecting segment or extension. Leaching systems shall not receive credit for such configurations unless MLSS is not applicable, or the groundwater hydraulic gradient is level (essentially 0 percent slope). Non-linear leaching system configurations may present a concern for non-uniform effluent loading on MLSS applicable sites with sloped hydraulic gradients.

Leaching systems located in vehicular travel areas shall be capable of handling H-20 wheel loads as follows:

- Precast concrete structures (galleries, pits) shall be H-20 load rated.
- Leaching trenches shall have a minimum 1-foot cover.
- Proprietary leaching systems shall only be used in vehicular travel areas if authorized by the manufacturer, and shall be H-20 load rated. Proprietary leaching system companies authorizing placement of their systems in vehicular travel areas shall file supporting documentation with the Commissioner.

SSDS designs that include retaining walls shall provide information and specifications for the retaining wall including its foundation, and any associated groundwater control mechanisms (drains, weep holes). A cross-section of the wall showing existing and proposed grades should be provided. Retaining wall groundwater drains shall comply with the minimum separating distances listed in Table 1 (Item G). Retaining walls within 50 feet down-gradient of a leaching system shall not act as a hydraulic barrier to groundwater and wastewater movement in the receiving soil. The inner edge of the retaining wall shall be at least 10 feet from the leaching system. Retaining walls shall be designed to prevent seepage from occurring through the above grade portions of the wall.

Whenever two different types of leaching products are utilized side-by-side, the average of the required minimum center to center (C to C) spacing shall be maintained. The specified C to C spacing is also applicable for the primary system relative to the reserve system. Leaching system products with ELA of 7.4 SF/LF and higher shall not be utilized where the receiving soil has a percolation rate slower than 30 minutes per inch. The length of leaching trench, gallery or proprietary leaching system row segments shall not exceed 75 feet measured from the inlet. In installations where intermittent dosing (e.g., pumping) exceeding 25 gallons/cycle is used a maximum length of 100 feet may be utilized.

A layer of non-woven filter fabric shall be placed over leaching system approved aggregate, and over exposed leaching gallery section joints prior to backfilling. Minimum average roll values for fabric used for covering stone aggregate shall have a unit weight of 1.5 oz./yd² (per ASTM D 5261), a permittivity of 1.0 sec⁻¹ (per ASTM D 4491) and a trapezoid tear strength of 15 lbs. (per ASTM D 4533). Filter fabric covering approved aggregate, except fabric with a P.E. certification, shall bear the appropriate manufacturer's label specifying the product's name and identification number. Labeling shall be affixed in such a manner to be readily visible to facilitate inspection. The Commissioner shall maintain a list of approved filter fabrics (Appendix C) that may be updated prior to the next publication of these standards. P.E. certification of unlabeled fabric shall be made only by the plan designer, and fabric information and specifications shall be included on the

design plan. The P.E. shall certify the fabric meets the above noted minimum average roll values, and shall inspect the leaching system before covering and confirm in a written statement to the DOH that the specified fabric was utilized.

Stone aggregate must be of uniform consistency and only contain clean, hard, tough, durable fragments that meet the specifications cited in the stone aggregate definition (Section I), which includes a fines standard of a maximum of 1% passing the No. 200 sieve at the pit/quarry source. This standard should also be met at the SSDS installation site; however in no case shall the fines exceed 1.5%. Stone aggregate utilized in leaching system installations shall meet the following gradations for either No. 4 stone aggregate or No. 6 stone aggregate, respectively:

	No. 4 Stone Aggregate (A.K.A., 1 & 1/4" Stone)	No. 6 Stone Aggregate (A.K.A., 3/4" Stone)
SIEVE SIZE	PERCENT PASSING (by weight)	PERCENT PASSING (by weight)
2-inch	100	N/A
1.5-inch	90 - 100	N/A
1-inch	20 - 55	100
3/4-inch	0 - 15	90 - 100
1/2-inch	N/A	20 - 55
3/8-inch	0 - 5	0 - 15
#4	N/A	0 - 5

Select fill placed within and adjacent to leaching system areas shall be a clean material comprised of sand, or sand and gravel, free from organic matter and foreign substances. The select fill shall meet the following requirements unless otherwise approved by the design P.E. Select fill exceeding 6 percent passing the #200 sieve based on a wet sieve analysis cannot be approved by the design P.E.

1. The select fill shall not contain any material larger than the three (3) inch sieve.
2. Up to 45% of the dry weight of the representative sample may be retained (gravel portion) on the #4 sieve.
3. The material that passes the #4 sieve is then reweighed and the sieve analysis started.
4. The remaining sample shall meet the following gradation criteria:

SIEVE SIZE	PERCENT PASSING	
	WET SIEVE	DRY SIEVE
#4	100	100
#10	70 - 100	70 - 100
#40	10 - 50 *	10 - 75
#100	0 - 20	0 - 5
#200	0 - 5	0 - 2.5

* Percent passing the #40 sieve can be increased to no greater than 75 if the percent passing the #100 sieve does not exceed 10 and the #200 sieve does not exceed 5.

Select fill that does not meet the dry sieve gradation criteria but meets the wet sieve gradation criteria is acceptable. Sieve testing of select fill is required for large SSDSs whenever the leaching system is located entirely in select fill. The DOH may require sieve testing of select fill on small SSDSs in accordance with PHC Section 19-13-B103e (d) (6).

The licensed installer is responsible for preparing the leaching area with acceptable select fill. Topsoil in the leaching system area shall be removed and the subsoil scarified prior to select fill placement, unless otherwise directed by the design P.E. The installer shall take the necessary steps to protect the underlying receiving soil from over compaction/damage. The installer is responsible for properly compacting select fill to facilitate construction and to prevent settling. Select fill shall extend a minimum of 5 feet laterally in all directions beyond the outer perimeter of the leaching system.

The Commissioner shall approve manufactured fill. Rock or other product used to produce manufactured fill shall have a loss of abrasion of not more than 50 percent using AASHTO Method T-96, and when tested for soundness using AASHTO Method T 104 not have a loss of more than 15 percent at the end of 5 cycles. The suggested minimum permeability of manufactured fill is 15 feet per day; however the minimum average permeability must be at least 10 feet per day. The Commissioner may require additional testing and documentation on manufactured fill with an average permeability between 10 and 15 feet per day. Suppliers of manufactured fill shall make application for approval to the Commissioner. Documentation shall be submitted on the manufactured fill operation and production process. Fill specifications/test results (e.g., loss of abrasion, soundness, gradation, permeability) and a narrative of the supplier's quality control/quality assurance (QC/QA) program shall be included for all active production sites. Approved manufactured fill producers shall provide an annual registration to the Commissioner by July 1st of each year, which includes updated test results and QC/QA narratives. Manufactured fill approval applications and annual registrations shall include a signed statement attesting that the test results submitted to the Commissioner are typical of routine QC/QA test results.

B. Leaching Trenches

Leaching trench rows shall be installed level and follow ground contours. Leaching trenches shall be filled with approved aggregate. Stone aggregate shall meet the No. 4 or No. 6 stone aggregate gradation in Section VIII A. Perforated effluent distribution pipe of acceptable material (Table 2-A) with perforations in a downward direction shall be laid the entire length of the trench near the top layer of aggregate with a minimum 6 inches (for 48-inch wide trenches) or 12 inches (for 36-inch or less wide trenches) of aggregate under the pipe. Perforated distribution pipes shall be laid level or on a grade not exceeding 3 inches per 100 feet. Additional ELA credit of 0.6 SF/LF shall be given to the leaching trench credits below if the distribution pipe is installed on top of the leaching trench aggregate. Perforated distribution pipe placed on top of approved aggregate shall be 4-inch heavy duty pipe (Table 2-A). Filter fabric must cover the aggregate and distribution pipe, and aggregate must be cradled around the bottom portion of the pipe to prevent the filter fabric from obstructing the perforated pipe openings.

For the purposes of Section VIII F & G, the ELA of leaching trenches and corresponding minimum C to C spacing between trench rows shall be as follows:

Trench Depth (inches)	Trench Width (inches)	Effective Leaching Area (SF/LF)	Center to Center Spacing (feet)
18	18	2.1	7
18	24	2.4	7
18	30	2.7	7
18	36	3.0	7
12	48	3.0	8

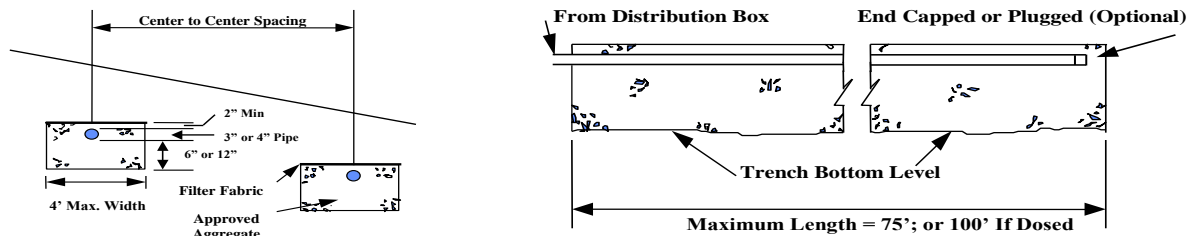

Figure 14 - Leaching Trenches

C. Leaching Pits

Leaching pits shall be hollow structures with perforated walls and solid covers. The side walls shall be surrounded by 12 to 24 inches of approved aggregate, and the hollow structure shall be 5 to 10 feet in diameter. Stone aggregate shall meet the No. 4 stone aggregate gradation in Section VIII A. Covers shall be equipped with a cleanout manhole. Center to center spacing of leaching pits shall be at least 4 times the diameter of the hollow structure. No more than 2 leaching pits shall be connected in series. The bottom of leaching pits shall not be more than 8 feet below grade. Leaching pits shall not be used where the percolation rate is slower than 20 minutes per inch.

For the purposes of Section VIII F & G, the ELA of leaching pits shall consist of only the side area of the usable aggregate-filled excavation. The maximum utilization of a leaching pit cannot be higher than the septic tank outlet elevation or the high-level overflow elevation of the serial distribution box.

$$ELA = \text{Excavation Diameter} \times \pi \times \text{Pit Depth} \text{ (Note: } \pi \text{ equals approximately 3.14)}$$

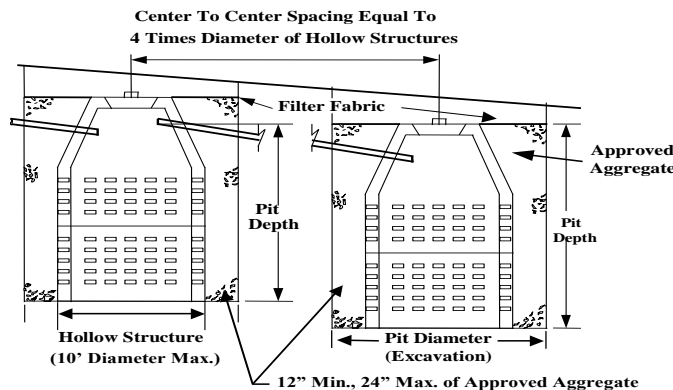

**Figure 15
Leaching Pits**

D. Leaching Galleries

Leaching gallery rows shall be installed level and follow ground contours. Leaching galleries shall be hollow structures with perforated or open joint sides and solid covers. Leaching galleries shall provide a minimum 40 inches of open bottom width. The sidewalls shall have a minimum depth of 12 inches and a maximum depth of 4 feet, including up to 6 inches of approved aggregate above the top of the structure. If approved aggregate is placed on top of the structure for additional credit, then perforated distribution pipe should be located above the top of the gallery if feasible. Twelve inches of approved aggregate shall be placed on the sides of concrete galleries and ends of the gallery rows. Stone aggregate backfill for concrete galleries shall meet the No. 4 stone aggregate gradation in Section VIII A. The width of the trench excavation shall not be less than 6 feet and the width of the hollow structure(s) shall be not less than 4 feet. The total length of excavated gallery row shall be utilized to calculate ELA. Four-inch heavy duty perforated distribution pipe (Table 2-A) may be installed on top of the gallery aggregate to receive an additional ELA credit of 0.6 SF/LF for 12-inch high galleries, and 0.8 SF/LF for all other galleries. Filter fabric must cover the aggregate and distribution pipe, and aggregate must be cradled around the bottom portion of the pipe to prevent the filter fabric from obstructing the perforated pipe openings.

For the purposes of Section VIII F & G, the ELA of leaching galleries rows and corresponding minimum C to C spacing between gallery rows shall be as follows:

Gallery Height (inches)	Effective Leaching Area (SF/LF)	Center to Center Spacing (feet)
48	9.2	12
36	8.0	12
30	7.4	12
27	7.1	12
24	6.8	12
18	6.2	12
12	5.9	12

Single plastic chambers (e.g., Infiltrator ISI 3050, Cultec Recharger 330XL HD) or multiple plastic chambers (e.g., Infiltrator Quick4 Plus Standard) can be utilized in a gallery configuration (Figure 16) as long as the minimum open bottom width of 40 inches is provided, and the proprietary leaching system company authorizes such installation practice. Stone aggregate backfill for plastic chambers shall meet the No. 4 or No. 6 stone aggregate gradation in Section VIII A.

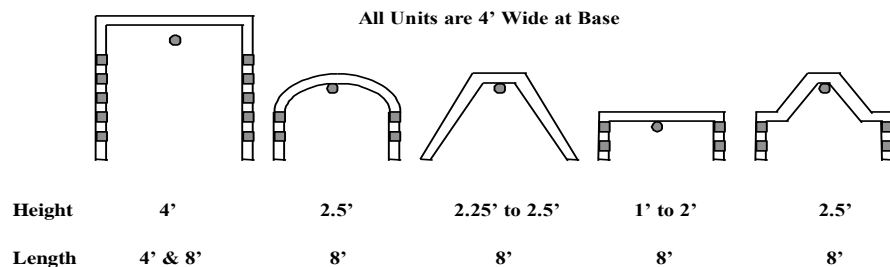
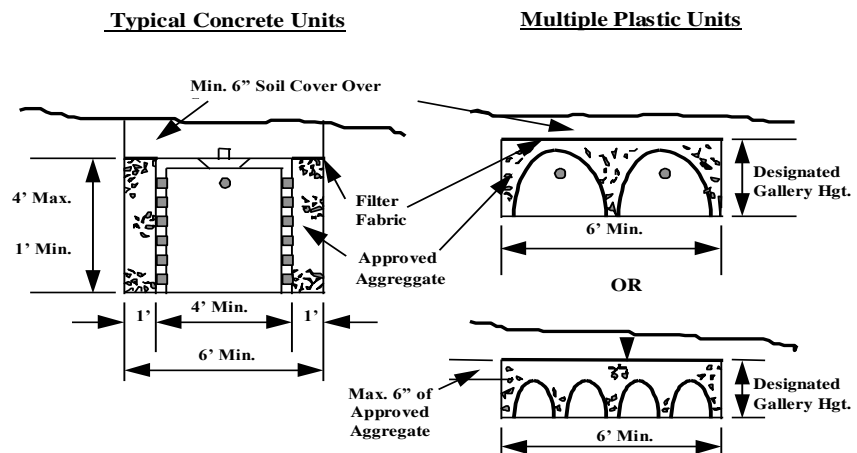

Figure 16 - Typical Leaching Gallery Structures



E. Proprietary Leaching Systems & Proprietary Pressure-Dosed Dispersal Systems

1. Proprietary Leaching Systems

Installation procedures, including the minimum depth of cover, shall be per manufacturer's specifications. It is the responsibility of proprietary leaching system companies to ensure that installers are properly trained on installation protocols and procedures. Proprietary leaching system rows shall be installed level and follow ground contours. Proprietary leaching systems that require placement of soil at the infiltrative interface shall be backfilled with select fill unless otherwise noted. Several proprietary leaching products require use of ASTM C 33 sand or washed sand meeting Department of Transportation (DOT) Form 817 Table M.01.03-01 for fine aggregate. ASTM C 33 sand and DOT washed sand contains no medium and large (3/8" to 3") gravel, and limited (less than 5 percent) small (#4 sieve to 3/8") gravel. Sand specified for the infiltrative interface shall meet select fill gradation specifications for the #100 and #200 sieves. Stone aggregate utilized in proprietary leaching systems shall meet stone aggregate requirements, and the No. 4 or No. 6 stone aggregate gradation in Section VIII A.

Plastic Leaching Chambers

Plastic Leaching Chambers Backfilled with Select Fill or Approved Aggregate: For the purpose of Section VIII F & G, the ELA of the products listed below and corresponding minimum C to C spacing between product rows shall be as follows; however a 0.4 SF/LF ELA reduction shall be assessed if the chambers are not backfilled with select fill:

Product Name	Dimensions (W x H)	Effective Leaching Area (SF/LF)	Center to Center Spacing (feet)
Infiltrator - Equalizer 24	15" x 11"	2.3	7
Infiltrator - Equalizer 36	22" x 13.5"	2.7	7

Plastic Leaching Chambers Backfilled with Approved Aggregate: For the purpose of Section VIII F & G, the ELA of the products listed below and corresponding minimum C to C spacing between product rows shall be as follows:

Product Name	Dimensions (W x H)	Effective Leaching Area (SF/LF)	Center to Center Spacing (feet)
Cultec - Contactor EZ-24	16" x 12"	1.9	7
Cultec - Contactor EZ-24 (PDS)	16" x 12"	2.5	7
Cultec - Contactor 100	36" x 12.5"	3.7	7
Cultec - Contactor 100 (PDS)	36" x 12.5"	4.3	7
Cultec - Recharger 180	36" x 20.5"	4.4	7
Cultec - Recharger 180 (PDS)	36" x 20.5"	5.1	9
Cultec - Recharger 280	46" x 26.5"	6.5	10
Cultec - Recharger 280 (PDS)	46" x 26.5"	7.1	10
Cultec - Recharger 330XLHD	52" x 30"	5.6	11
Infiltrator Quick4 Equalizer 24	16" x 11"	2.0	7
Infiltrator Quick4 Equalizer 36	22" x 12"	2.6	7
Infiltrator Quick4 Standard	34" x 12"	3.6	7
Infiltrator Quick4 High Capacity	34" x 16"	4.1	7
Infiltrator Arc 36	34.5" x 13"	3.7	7
Infiltrator Arc 36HC	34.5" x 16"	4.1	7
Infiltrator Quick4 Plus Equalizer 36 Low Profile	22" x 8"	2.4	7
Infiltrator Quick4 Plus Standard Low Profile	34" x 8"	3.4	7
Infiltrator Quick4 Plus Standard	34" x 12"	3.8	7
Infiltrator Quick4 Plus High Capacity	34" x 14"	3.9	7
Infiltrator Arc 24	22" x 12"	2.6	7
Infiltrator Arc 36 LP	34" x 8"	3.4	7

Corrugated Leaching Systems Lined/Covered with Filter Fabric: Filter fabric lined products shall be backfilled with select fill. Lined products backfilled with non-select fill may be approved by the Commissioner at reduced ELA credits upon application by the proprietary leaching system company. For the purpose of Section VIII F & G, the ELA of the products listed below and corresponding minimum C to C spacing between rows shall be as follows:

Product Name	Dimensions (Diameter / W x H)	Effective Leaching Area (SF/LF)	Center to Center Spacing (feet)
GEO-FLOW	12" Diameter	2.3	7
Presby Env. - ENVIRO-SEPTIC	12" Diameter	2.3	7
Presby Env. - SIMPLE-SEPTIC	12" Diameter	1.5	7

ADS - SB2	10" Diameter	0.9	7
Cultec - Contactor EZ-24	16" x 12"	1.9	7
Cultec - Contactor EZ-24 (PDS)	16" x 12"	2.5	7
Cultec - Contactor 100	36" x 12.5"	3.7	7
Cultec - Contactor 100 (PDS)	36" x 12.5"	4.3	7
Cultec - Recharger 180	36" x 20.5"	4.4	7
Cultec - Recharger 180 (PDS)	36" x 20.5"	5.1	9
Cultec - Recharger 280	46" x 26.5 "	6.5	10
Cultec - Recharger 280 (PDS)	46" x 26.5 "	7.1	10
Cultec - Recharger 330XLHD	52" x 30"	5.6	11
Infiltrator Quick4 Equalizer 24	16" x 11"	2.0	7
Infiltrator Quick4 Equalizer 36	22" x 12"	2.4	7
Infiltrator Quick4 Standard	34" x 12"	3.3	7
Infiltrator Quick4 High Capacity	34" x 16"	3.7	7
Infiltrator Arc 36	34.5" x 13"	3.9	7
Infiltrator Arc 36HC	34.5" x 16"	4.5	7
Infiltrator Quick4 Plus Equalizer 36 Low Profile	22" x 8"	2.3	7
Infiltrator Quick4 Plus Standard Low Profile	34" x 8"	3.4	7
Infiltrator Quick4 Plus Standard	34" x 12"	3.9	7
Infiltrator Quick4 Plus High Capacity	34" x 14"	4.1	7
Infiltrator Arc 24	22" x 12"	2.4	7
Infiltrator Arc 36 LP	34" x 8"	3.3	7

GreenLeach Filter: GreenLeach Filter (GLF) units shall be bedded on the bottom and sides with sand fill meeting both the manufacturer's specifications and select fill specifications. The standard GLF units include a filter fabric/cardboard interface. An alternative non-filter fabric option (GLF-NF) that includes a cardboard interface without a fabric lining has been approved for all GLF products with the same ELA ratings. For the purpose of Section VIII F & G, the ELA of the listed products and corresponding minimum C to C spacing between rows shall be as follows:

Product Name	Dimensions (W x H)	Effective Leaching Area (SF/LF)	Center to Center Spacing (feet)
GLF 12.62	62" x 12"	7.9	12
GLF 15.62	62" x 15"	9.4	12
GLF 18.62	62" x 18"	11.0	14
GLF 21.62	62" x 21"	12.5	14
GLF 24.62	62" x 24"	14.0	14
GLF 27.62	62" x 27"	15.5	14
GLF 30.62	62" x 30"	17.0	14
GLF 33.62	62" x 33"	18.5	14
GLF 36.62	62" x 36"	20.0	14
GLF 12.37	37" x 12"	4.7	9
GLF 15.37	37" x 15"	5.6	9
GLF 18.37	37" x 18"	6.5	9
GLF 21.37	37" x 21"	7.3	9
GLF 24.37	37" x 24"	8.2	9
GLF 27.37	37" x 27"	9.1	9
GLF 30.37	37" x 30"	9.9	9
GLF 33.37	37" x 33"	10.8	12
GLF 36.37	37" x 36"	11.7	12

Cur-Tech Systems: Cur-Tech units shall be backfilled on the sides with sand fill meeting both the manufacturer's specifications and select fill specifications. For the purpose of Section VIII F & G, the ELA of the products listed below and the corresponding minimum C to C spacing between product rows shall be as follows:

Product Name	Dimensions (W x H)	Effective Leaching Area (SF/LF)	Center to Center Spacing (feet)
CTL-12	72" x 14"	8.3	12
CTL-18	72" x 20"	10.7	14
CTL-24	72" x 26"	13.0	14
CTL-48	72" x 50"	21.9	14

Ruck A Fins: Ruck A Fins units shall be bedded on the bottom and sides with sand fill meeting both the manufacturer's specifications and select fill specifications. For the purpose of Section VIII F & G, the ELA of the product listed below and corresponding minimum C to C spacing between product rows shall be as follows:

Product Name	Dimensions (W x H)	Effective Leaching Area (SF/LF)	Center to Center Spacing (feet)
Ruck A Fins - R1032C	32" x 7"	7.0	9

FORM CELL Living Filter: Living Filter units shall be bedded on the bottom and sides with sand fill meeting both the manufacturer's specifications and select fill specifications. For the purpose of Section VIII F & G, the ELA of the products listed below and the corresponding minimum C to C spacing between rows shall be as follows:

Product Name	Dimensions (W x H)	Effective Leaching Area (SF/LF)	Center to Center Spacing (feet)
Living Filter- LF1210	29" x 18"	3.9	7
Living Filter- LF1810	29" x 24"	5.5	9
Living Filter- LF2410	29" x 30"	7.0	9
Living Filter- LF3010	29" x 36"	8.6	9
Living Filter- LF3610	29" x 42"	10.1	12
Living Filter- LF1224	60" x 18"	7.4	11
Living Filter- LF1826	64" x 24"	11.0	12
Living Filter- LF2426	64" x 30"	14.2	14
Living Filter- LF3026	64" x 36"	17.3	14
Living Filter- LF3626	64" x 42"	20.4	14

Eljen: Eljen products shall be bedded on the bottom and sides with sand fill meeting both the manufacturer's specifications and select fill specifications. For the purpose of Section VIII F & G, the ELA of the products listed below and the corresponding minimum C to C spacing between rows shall be as follows:

Product Name	Dimensions (W x H)	Effective Leaching Area (SF/LF)	Center to Center Spacing (feet)
Eljen B43	36" x 7"	4.7	7
Mantis 536-8	36" x 18"	11.0	12
Mantis 536-8 LowPro	36" x 12"	6.5	9
Mantis Double-Wide 58	72" x 12"	11.6	14
Mantis Double-Wide 100	72" x 18"	20.0	14

Geomatrix: For the purpose of Section VIII F & G, the ELA of the products listed below and the corresponding minimum C to C spacing between product rows shall be as follows:

Product Name	Dimensions (W x H)	Effective Leaching Area (SF/LF)	Center to Center Spacing (feet)
GeoMat 1200	12" x 1"	1.0	7
GeoMat 3900	39" x 1"	3.0	8
GeoMat 7800	78" x 1"	5.9	13
LowPro WE 1200	72" x 1"	5.2	12
LowPro WE 3900	72" x 1"	5.6	12
GeoMat Edge ST 600	72" x 6"	14.0	14
GeoMat Edge ST 1200	72" x 14"	27.2	14
GeoMat Edge WE 1200	72" x 13"	27.2	14
GST 6206	62" x 6"	5.9	12
GST 6212	62" x 12"	10.0	12
GST 6218	62" x 18"	14.0	13
GST 6224	62" x 24"	18.1	13
GST 6230	62" x 30"	22.1	13
GST 6236	62" x 36"	26.2	13
GST 3706	37" x 6"	3.6	8
GST 3712	37" x 12"	5.9	10
GST 3718	37" x 18"	8.2	10
GST 3724	37" x 24"	10.5	12
GST 3730	37" x 30"	12.9	12
GST 3736	37" x 36"	15.2	12
GeoU636	36" x 6.5"	8.0	9

GeoU672	72" x 6.5"	15.5	14
GeoU1236	36" x 12.5"	14.8	12
GeoU1272	72" x 12.5"	28.8	14
GeoU1836	36" x 18.5"	21.7	12
GeoU1846	46" x 18.5"	27.4	12
GeoU1851	51" x 18.5"	29.9 (max. allowed)	13
GeoU3921	21" x 39"	27.4	12
GeoU3926	26" x 39"	29.9 (max. allowed)	12
SB1-3.5-36	36" x 3.5"	4.4	7
SB1-7-36	36" x 7"	8.2	9
SB1-13-36	36" x 13"	14.7	13
SB1-26-36	36" x 26"	28.7	13
SB1-3.5-72	72" x 3.5"	8.5	12
SB1-7-72	72" x 7"	15.9	14
SB1-13-72	72" x 13"	28.5	14
GCS848	48" x 8"	6.2	10
GCS872	72" x 8"	9.8	12
GCS1248	48" x 12"	10.8	12
GCS1272	72" x 12"	17.1	14
GCS1848	48" x 18"	17.6	12
GCS1872	72" x 18"	28.2	14

In accordance with the stipulations of Geomatrix Systems, LLC, unless otherwise authorized by Geomatrix Systems, LLC, all GeoMat Edge and GeoU leaching systems shall be installed in conjunction with a Soil Air System approved for use by Geomatrix Systems, LLC, and S-Box (SB1 series) leaching systems shall be configured for use with a Soil Air System that entails installing an air supply line for possible future use. See Section VI D for additional information on use of the Soil Air System.

2. Proprietary Pressure-Dosed Dispersal Systems

The Commissioner may approve proprietary pressure-dosed dispersal (PPD) systems, and system sizing shall be correlated to an equivalent area needed for a conventional 3-foot wide leaching trench system. New SSDS plans specifying a PPD system shall identify an area that can accommodate a conventional 3-foot wide leaching trench system including any fill and extensions necessary to construct the system. PPD systems are not required to be installed within the designated conventional leaching trench system area.

Companies requesting approval of their PPD system shall submit detailed specifications and installation requirements for their package systems, which includes dosing and dispersal system components, as well as operation and monitoring information. Dispersal system sizing requirements and tubing/piping spacing of laterals shall be approved by the Commissioner based on a review of supporting documentation from the company.

Installation procedures, including the minimum depth of cover, shall be per manufacturer's specifications. It is the responsibility of the PPD system company to ensure that installers are properly trained on installation protocols and procedures. Operation and maintenance (O & M) requirements for PPD systems shall be specified by the company, and shall be listed on the permit to discharge. Property owners that receive approval for a PPD system shall be required to have O & M on the system by a vendor-trained and authorized individual. Service contracts for routine O & M is typically a requirement for these systems.

Perc Rite Drip Dispersal System

The Perc Rite Drip Dispersal System (Vendor: American Manufacturing Company, Inc., New England Distributor: Oakson Inc.) has three models (ASD-15, ASD-25, & ASD-40) that are approved for use. The ASD-15 model is typically utilized for single-family applications, and the ASD-25 model is typically used for design flows exceeding 1,000 GPD. The ASD-40 model would normally not be utilized for systems governed by these standards as it is for flows exceeding the 5,000 GPD. The total linear footage of the Perc Rite Drip Dispersal System shall be at least 4 times the calculated linear footage of a standard conventional 3-foot wide leaching trench system that would be required for the particular building served. The drip dispersal tubing shall have a minimum C to C spacing of 1.5 feet, although minor deviations to the C to C spacing is allowed for small portions of the system if warranted (e.g., drip lines around trees).

F. Leaching System Sizing

1. Residential Buildings

The required effective leaching area (ELA) for a SSDS serving a residential building shall be based on the number of bedrooms and the percolation rate in accordance with Table 6, except for the following:

- A separate SSDS for a one bedroom residential outbuilding on a single-family residential building lot shall have a required ELA equal to 50 percent of that required for a 2-bedroom building.
- The required ELA for a multi-family residential building shall be based on a minimum of 4-bedrooms.
- A central SSDS serving a residential outbuilding and a single-family residential building shall base the outbuilding’s required ELA on a multi-family classification unless the outbuilding doesn’t have additional plumbing fixtures (e.g., kitchen sink, dishwasher, washing machine) beyond a full bathroom.

Table 6

Percolation Rate (Minutes to Drop One Inch)	Square Feet of Required Effective Leaching Area (ELA)			
	2-Bedroom Building	3-Bedroom Building	For Each Bedroom Above 3	
			Single Family	Multi-family
LESS THAN 10.1	375	495	82.5	165
10.1-20.0	500	675	112.5	225
20.1-30.0	565	750	125	250
30.1-45.0	675	900	150	300
45.1-60.0	745	990	165	330

2. Restaurants, Residential Institutions, and Nonresidential Buildings with Problematic Sewage

The required ELA for a SSDS serving a restaurant, bakery, food service establishment, residential institution, laundromat, beauty salon, or other nonresidential building with problematic sewage shall be determined by dividing the design flow by the application rate listed in Table 7. See Section IV for design flow and problematic sewage information.

Table 7

Percolation Rate (Minutes to Drop One Inch)	Application Rate (GPD per square foot of ELA)
LESS THAN 10.1	0.8
10.1 to 20.0	0.7
20.1 to 30.0	0.6
30.1 to 45.0	0.5
45.1 to 60.0	0.4

3. Nonresidential Buildings with Non-problematic Sewage

The required ELA for a SSDS for a nonresidential building, other than those covered by Table 7, shall be sized on the design flow and application rates listed in Table 8. See Section IV for design flow and problematic sewage information.

Table 8

Percolation Rate (Minutes to Drop One Inch)	Application Rate (GPD per square foot of ELA)
LESS THAN 10.1	1.5
10.1 to 20.0	1.2
20.1 to 30.0	0.9
30.1 to 45.0	0.7
45.1 to 60.0	0.6

FOR TABLES 7 & 8: REQUIRED ELA = $\frac{\text{DESIGN FLOW}}{\text{APPLICATION RATE}}$

G. Leaching System Product Approvals, ELA Ratings, Center to Center (C to C) Spacing

Approved leaching systems are assigned an ELA rating in square feet per linear foot (SF/LF) except for leaching pits (Section VIII C) and the dispersal system component of PPD systems (Section VIII E 2). Approved leaching systems with assigned ELA ratings are listed in Section VIII, or in a leaching system approval issued by the Commissioner. Proprietary leaching system companies shall submit new product approval requests to the Commissioner along with product specifications, drawings, cross-sections, and dated installation instructions. The Commissioner may require third party/independent test data in conjunction with proprietary leaching system reviews/approvals that are deemed substantially different than those currently approved.

Approved leaching systems (except for the dispersal system component of PPD systems) are assigned an ELA rating that is calculated based on the amount and type of leaching system interface that the biologically active layer (bio-mat) forms upon the routine application of septic tank effluent. Interface factors for various leaching system interfaces are as follows:

Open:	2.0	
Filter Fabric (No Stone):	1.5	Note: Factor reduced by percent obstructed.
Stone:	1.0	
Filter Fabric & Stone:	0.75	

For the purpose of the ELA ratings, the factors noted for stone are used also for other approved aggregate, and the filter fabric interface factors also apply to cardboard and cardboard/filter fabric interfaces. Three types of leaching system interfaces are credited: sidewall interfaces, bottom interfaces, and internal interfaces. Sidewall interfaces discharge wastewater that does not pass through the product footprint area, which is the horizontal area within a rectangular boundary around the outermost perimeter of the leaching system interface. Bottom interfaces discharge wastewater from the bottom of the product. Internal interfaces are non-bottom leaching surfaces that discharge wastewater from within and through the product footprint area. No credit is given for bottom interfaces that include cardboard. Horizontal measurements are used for bottom interfaces, except for corrugated pipes. Vertical measurements are utilized for sidewall and internal leaching interfaces, except for corrugated pipes. Corrugated pipes have measurements taken along the perimeter of the pipe. Sidewall and internal interfaces are credited up to the leaching system's pipe invert unless otherwise established by the Commissioner. No ELA rating shall exceed 29.9 SF/LF.

The Commissioner may establish crediting limitations that are applicable to competing bio-mats (overlapping bio-mats of specified thickness), and internal interfaces. Proprietary leaching systems approved after January 1, 2015 shall receive no credit for competing bio-mats less than ½ inch apart and 50 percent credit for competing bio-mats ½ to 2 inches apart, and internal interfaces less than 4 inches apart shall not be credited unless the proprietary leaching system company satisfactorily demonstrates there is sufficient bottom sand area available to transmit the partly treated septic tank effluent while maintaining low soil moisture content in the sand column, and such assessments shall discount the sand area within 1-inch of internal interfaces. The Commissioner may require a re-evaluation of ELA credits for currently approved leaching systems relative to the credit given for competing bio-mats and internal interfaces following the adoption of criterion for crediting limitations. As part of any re-evaluation of ELA credits, the Commissioner may require proprietary leaching system companies that have products approved prior to January 1, 2015 to submit product information (e.g., specifications, drawings, cross-sections) in order for the systems to remain approved.

Leaching system C to C minimum spacing, except for leaching pits (Section VIII C) and the dispersal system utilized in PPD systems (Section VIII E 2), is determined based on the following:

- ELA rating of 5.0 SF/LF or less: 7 feet minimum and at least 4 feet leaching row edge to edge.
- ELA rating from 5.1 to 10.0 SF/LF: 9 feet minimum and at least 6 feet leaching row edge to edge.
- ELA rating exceeding 10.0 SF/LF: 12 feet minimum and at least 8 feet leaching row edge to edge.

The Commissioner may approve reduced C to C spacing reductions for shallow leaching systems in LPD applications. No consideration for reduced spacing shall be given to leaching systems receiving internal interface credits until criterion for crediting limitations for internal interfaces are established by the Commissioner. Approvals for reduced leaching system spacing shall provide a minimum of six inches leaching row edge to edge for each 1 SF, or part thereof, per linear foot ELA credit. Reduced spacing will only be considered if it is satisfactorily demonstrated that a licensed installer can reasonably install the particular leaching product without compromising the installation of the leaching system.

IX. GROUNDWATER AND SURFACE WATER DRAINAGE

Storm water swales shall be constructed to lead storm water away from SSDSs. Minimum separating distances between storm water collection/drainage/infiltration systems and SSDSs are stipulated in Table 1 (Item E, F & H). See Section II A for SSDS separating distance considerations for SWISs. Refer to Section III D and Table 3 for storm water drainage piping requirements.

Impervious cover storm water that discharges via sheet flow or through minor leak-offs is not considered a drainage system. Pervious pavement material is not considered a SWIS. SWISs should not concentrate large quantities of water in close proximity of SSDSs as they can create localized groundwater mounding that can interfere with the operation of the SSDS and diminish wastewater renovation. See Section II for additional storm water system separation distance requirements.

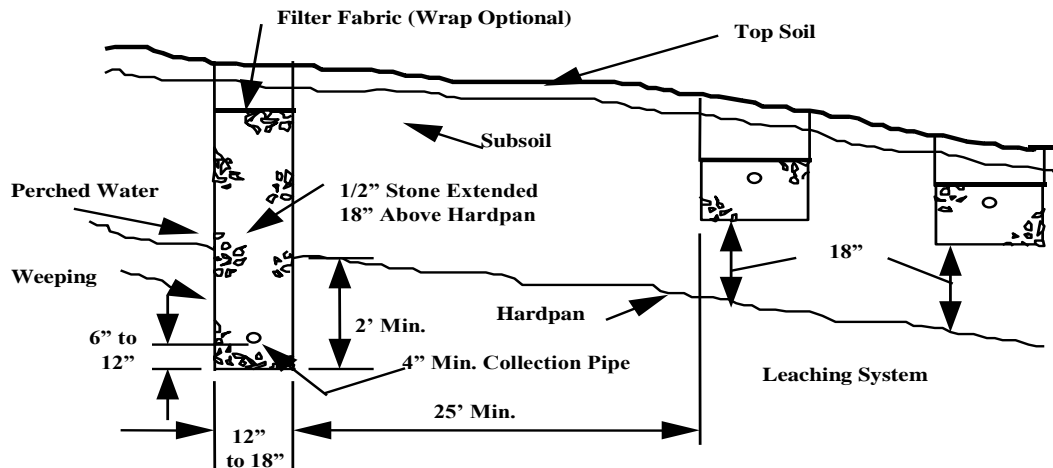

Figure 17 - Typical Curtain Drain Construction

Groundwater control drains (when utilized) shall be located up-gradient of the leaching system, and on the sides if necessary. The depth of these drains shall be designed to lower the groundwater at least 2 feet below the bottom of the entire leaching system (Figure 17). Drains shall be equipped with a collection pipe located 6 to 12 inches above the bottom of the trench to collect and discharge groundwater away from the leaching system area. This collection pipe shall have a minimum diameter of 4 inches and shall consist of open-joint tile, porous or perforated pipe. Perforated collection pipes are typically installed with holes on the bottom of the pipe and surrounded by clean stone or gravel to a depth necessary to control groundwater. Groundwater control drains shall be designed similar to Figure 17, or as otherwise designed by a P.E.

Minimum separation distances for all groundwater drainage systems (e.g., curtain, foundation) are stipulated in Table 1 (Items E & G). Groundwater drainage shall not discharge into or within 25 feet of a SSDS, and increased separation distance may be needed if the discharge location may impact the operation of the leaching system.

X. WATER TREATMENT WASTEWATER

The Commissioners of the Department of Energy and Environmental Protection and the Department of Public Health entered into a delegation agreement in July 2017 that provides the authority for the DOH to approve and permit discharges of water treatment wastewater (WTW) on properties governed by PHC Sections 19-13-B103a through f. The agreement authorizes WTW discharges to approved WTW disposal systems which include (1) WTW dispersal systems, (2) SSDSs, and (3) holding tanks. All WTW disposal systems shall prevent the discharge of WTW to the ground surface, wetlands, or open watercourse, and shall comply with the following requirements and any future regulations promulgated by the Department of Public Health:

1. The applicant (property owner or duly authorized agent) shall submit to the DOH a design plan/sketch of the proposed WTW dispersal system, WTW holding tank, or connection to the SSDS. The submittal shall also include the name and contact information of the installer.
2. If warranted, the applicant shall demonstrate compliance with PHC Section 19-13-B100a (e).
3. The applicant shall specify the type of water treatment device, name and model number, and its anticipated WTW discharge volume per cycle and frequency.

4. WTW solid conveyance piping shall have a minimum separating distance of 25 feet, 75 feet, and 100 feet, respectively, to public and private water supply wells with required withdrawal rates of <10 GPM, 10 to 50 GPM, and >50 GPM. The DOH may further reduce the distance to no less than 10 feet to private wells on existing developed properties if compliance cannot be met due to site limitations. WTW solid conveyance pipe shall be approved by the DOH and protected from freezing. Solid pipe listed in Table 2-A is acceptable for gravity WTW conveyance pipe, and pipe listed in Table 2-B is acceptable for pressure WTW conveyance pipe.
5. Non-discharging WTW disposal system components (e.g., WTW holding tanks, WTW dispersal system settling or filtration structures) shall meet the minimum separation distances cited in Table 9, unless otherwise authorized by the Commissioner.
6. WTW dispersal systems shall meet the separation distances cited in Table 1 (Item Q), and WTW dispersal system receiving structures shall meet the minimum separation distances cited in Table 9. Air gaps/breaks in WTW conveyance pipes that are outside of the building foundation shall meet the minimum separation distances cited in Table 9, unless otherwise authorized by the Commissioner.
7. WTW holding tanks, including piping, shall be located at least 10 feet from SSDSs.
8. WTW dispersal systems and WTW holding tanks shall be H-20 load rated in vehicular travel areas.
9. The bottom of the WTW dispersal system shall be located a minimum 12 inches above maximum groundwater and 24 inches above ledge rock.
10. WTW dispersal systems shall have a minimum storage volume of 1.5 times of either the anticipated discharge per cycle or daily average, whichever is greater.
11. Stone aggregate used shall be free of silt, dirt and debris and covered with approved filter fabric.
12. WTW holding tanks shall provide an access cleanout to grade and be equipped with a high-level alarm.
13. The DOH or registered sanitarian licensed pursuant to Chapter 395 shall approve the design of a WTW dispersal system or WTW holding tank prior to installation. Approval is not required from the Commissioner for WTW holding tanks; however approval from the Commissioner is required for WTW discharges directed to sewage holding tanks (See Section XI).
14. The installer shall provide twenty-four (24) hour minimum notice to the DOH prior to commencement of installation, unless otherwise agreed upon.
15. All applicable permits (electrical, plumbing, etc.) shall be obtained from the local building official.
16. An as-built drawing shall be submitted to the DOH that includes distances from two or more permanent reference points to the WTW disposal system.

The DOH may require an inspection of the WTW disposal system. In areas where well water treatment is anticipated, plans for new SSDSs should designate an area where a WTW dispersal system can be installed in accordance with Table 9. The Commissioner may authorize WTW discharge to a SSDS if it is determined that the nature and volume is unlikely to cause problems with the SSDS. WTW cannot be discharged to a cesspool. WTW from ion exchange systems, either cationic (e.g., water softener) or anionic (e.g., radionuclide treatment), cannot be discharged to a SSDS. WTWs approved to discharge to a SSDS are listed in Appendix E, which may be updated prior to the next publication of these standards.

Table 9

Item	Separation Distance (feet)	Special Provisions
Public or private water supply well with required withdrawal rate of:		The DOH may allow certain separation distance reductions on existing developed properties if compliance cannot be met due to site limitations. ⁽¹⁾⁽²⁾⁽³⁾
< 10 GPM	75	
10 to 50 GPM	150	
> 50 GPM	200	
Open watercourse	25	
Public water supply reservoir	100	
Property line	10	
Subsurface sewage disposal system	See Table 1 (Item Q)	

- (1) Reductions cannot be granted to public water supply reservoirs or public water supply wells.
- (2) Reductions to private wells shall not be reduced to less than 25 feet. WTW discharges less than 75 feet up-gradient of a private well shall be avoided, whenever possible.
- (3) The DOH may not allow reduced setback distances if there is a concern that the WTW may negatively impact the quality of the groundwater.

XI. NON-DISCHARGING TOILET & SEWAGE DISPOSAL SYSTEMS

A. Large Capacity Composting Toilets

Large capacity composting toilets shall have separate receiving, composting and storage compartments, arranged so that the contents are moved from one compartment to another without spillage, or escape of odors within the building. No large capacity composting toilets shall have an interior volume of less than 64 cubic feet. All toilet wastes shall be deposited in the receiving chamber, which shall be furnished with a tight self-closing toilet lid. Food waste or other materials necessary to the composting action shall be deposited in the composting compartment through a separate opening with a tight fitting lid. The final composting material shall be removed from the storage compartment through a cleanout opening fitted with a tight door or lid. The cleanout shall not be located in a food storage or preparation area. The receiving and composting compartments shall be connected to the outside atmosphere by a screened vent. The vent diameter shall be a minimum of 6 inches and extend at least 20 feet above the openings in the receiving and composting compartments, unless mechanical ventilation is provided. Air inlets shall be connected to the storage compartment only, and shall be screened.

B. Heat Assisted Composting Toilets

Heat assisted composting toilets shall have a single compartment furnished with a tight, self-closing toilet lid. The compartment shall be connected to the outside atmosphere by a screened vent. There shall be a mechanical ventilation fan arranged to control the humidity in the compartment and provide positive venting of odors to the outside at all times. A heating unit shall be provided to maintain temperature in the optimum range for composting.

C. Incineration Toilets

Gas or oil fired or electrical incineration toilets shall meet applicable fire and building codes. No ignition or incineration shall occur unless the toilet lid is closed, and the blower shall operate continuously during incineration. A combustion temperature of 1,400°F or higher shall be maintained during incineration.

D. Chemical Flush Toilets

Chemical flush toilets shall have toilet bowls that may be flushed when required by chemicals or chemical solutions. The liquid shall be discharged to a holding tank for removal of solids by settlement or other means prior to re-circulation. The toilet bowl shall be trapped or otherwise constructed to exclude odors, and the toilet's holding tank shall be vented to the outside atmosphere. The toilet's holding tank shall be emptied or additional chemicals added when odors or other objectionable conditions occur.

E. Dry Vault Privies (a.k.a., outhouses)

Dry vault privies shall be constructed with adequate storage space for excreta, and a fly-tight vault with a screened vent to the outside atmosphere. Self-closing, fly tight doors shall be provided. Dry vault privies shall be constructed so as to permit ready cleaning. Separating distances shall comply with Table 1, and the bottom of earthen vaults shall be at least 18 inches above maximum groundwater and 48 inches above ledge rock.

F. Chemical Privies (a.k.a., porta-potties)

Chemical privies shall be constructed with a watertight vault with a screened vent to the outside atmosphere. Self-closing, fly tight doors shall be provided. Separating distances shall comply with Table 1. The vault shall be emptied, or additional chemicals added, when odors or other objectionable conditions occur.

G. Sewage Holding Tanks

Pursuant to PHC Section 19-13-B103c (a), the Commissioner shall approve sewage holding tanks for buildings governed by PHC Sections 19-13-B103a through 19-13-B103f. Sewage holding tank proposals shall be submitted through the DOH to the Commissioner. Sewage holding tanks must comply with the separating distances cited in Table 1, unless an exception is granted pursuant to PHC Section 19-13-B103d. Sewage holding tanks shall include cleanout manholes to grade to facilitate routine pumping, and be provided with a high-level indicator alarm. The alarm shall be both audible and visual, unless otherwise approved by the DOH, and be located so that it readily alerts building occupants when activated.

Cleanout manhole covers shall weigh a minimum of 59 lbs or the cover shall be provided with a lock system to prevent unauthorized entrance. It is recommended that tank covers be left on the tank for safety reasons and to avoid potential odor problems when manhole riser assemblies are utilized over cleanout openings. However, in no case shall a cover be left off a holding tank cleanout opening when a riser cover weighs less than 59 lbs unless a secondary safety lid or device is provided below the riser cover. Secondary safety lids or devices are recommended to be utilized for safety reasons even if the riser cover weighs more than 59 lbs and the tank cover is removed.

Form #1 Technical Standards for Subsurface Sewage Disposal Systems

APPLICATION FOR APPROVAL TO CONSTRUCT A SUBSURFACE SEWAGE DISPOSAL SYSTEM

Application/Permit #: _____

To the Director of Health, Town of: _____ Date: _____

Application is hereby made for an approval to construct a subsurface sewage disposal system for a:

_____ (Residential Building, Restaurant, Retail Building, etc.)

located at: _____ (Street Address, Lot Number, Subdivision Name, Map, Block, Lot, etc.)

New System _____ Addition _____ Repair _____ Other _____

Owner _____ Address _____ Tel.No. _____

Installer _____ Address _____ Tel.No. _____

Installer License No. _____

In accordance with detailed information stated below:

Application fee paid _____ Signed _____ (Owner or duly authorized representative)

GENERAL INFORMATION

Soil Tests Conducted (Date): _____ Lot size _____ sq.ft.

Area of Special Concern (Y/N): _____ If yes, Reason(s): _____

Basis of Design (# of Bedrooms, Restaurant Seats, Building Size, etc): _____

Professional Engineer (P.E.) Plan Required (Y/N): _____

If yes, Name of P.E.: _____

Address of P.E.: _____

Design Plan Approved (Y/N): _____ Date of Approved Plan: _____ Revision Date: _____

Type of Water Supply _____ If well, has location been approved (Y/N): _____

Well Driller's Name: _____ Address: _____

OFFICE USE ONLY

Approval to Construct is hereby issued by: _____ Date: _____

(Print Name)

Signature: _____ Title: _____

Note: Approvals to Construct shall be issued by the DOH or Registered Sanitarian

Form #2

Technical Standards for Subsurface Sewage Disposal Systems

SITE INVESTIGATION FOR A SUBSURFACE SEWAGE DISPOSAL SYSTEM

Application/Permit #: _____

Property Owner _____ Location _____

DEEP TEST PIT DATA/SOIL DESCRIPTIONS

DATE: _____ (Record all Test Pits)

TEST PIT:	TEST PIT:	TEST PIT:	TEST PIT:
Mottles:	Mottles:	Mottles:	Mottles:
GW:	GW:	GW:	GW:
Ledge:	Ledge:	Ledge:	Ledge:
Roots:	Roots:	Roots:	Roots:
Restrictive:	Restrictive:	Restrictive:	Restrictive:

COMMENTS: _____

GROUNDWATER TABLE (Near max., below max., etc.) _____

SOIL MOISTURE (High, medium, low, etc): _____

PERCOLATION TEST DATA

DATE: _____ (Record all Perc Tests)

PERC:		PERC:		PERC:		PERC:	
DEPTH:		DEPTH:		DEPTH:		DEPTH:	
PRESOAK:		PRESOAK:		PRESOAK:		PRESOAK:	
TIME	READING	TIME	READING	TIME	READING	TIME	READING
PERC RATE:		PERC RATE:		PERC RATE:		PERC RATE:	

COMMENTS: _____

SITE INVESTIGATION FOR A SUBSURFACE SEWAGE DISPOSAL SYSTEM

LOCATION DRAWING INCLUDING ALL TEST PITS AND PERCOLATION HOLES

SPECIAL CONDITIONS		CONCLUSIONS	
Design Flow > 2000 GPD		Suitable for Sewage Disposal	
Public Water Supply Watershed		Unsuitable for Sewage Disposal	
Probable High Groundwater		Additional Investigation Req'd	
Slope > 25 percent		Wet Season Monitoring Req'd	
Perc Rate < 1 min/inch		Retest During Wet Season	
Perc Rate > 30 min/inch		Professional Engineer Plan Required	
Ledge < 5 feet below grade		Other:	
Limited Suitable Area			
Open Watercourse or Wetlands			
Flood Plain / Seasonal Flooding			
Max. G.W. < 36 inches below grade			

DESIGN RECOMMENDATIONS/COMMENTS

Form completed by: _____
 (Local Health Agent or Professional Engineer)

Accuracy assured by (If Professional Engineer completed form): _____
 (Local Health Agent)

Others present for site investigation (e.g., engineer, soil scientist, installer): _____

SITE INVESTIGATION FOR A SUBSURFACE SEWAGE DISPOSAL SYSTEM

Location: _____ Weather: _____

Percent Slope: _____ Parent Material: _____ Date: _____ Time: _____

Completed by: _____ P.E. or Certified Local Health Agent
 Accuracy Assured by (if P.E. completed form): _____ Certified Local Health Agent

Others Present for Site Investigation: _____

Test Pit #:	Depth to Observed Ground-Water (inches):				Weeping:			Standing:				Observed Ledge:		
	Soil Horizon	Depth (inches)	Matrix Color (moist)		Redoximorphic Features		Soil Texture (USDA)	Gravel Percent	Soil Consistence	Roots	Other	Soil Consistence	Roots	Other
			Depth	Color	Depth	Color								

Test Pit #:	Depth to Observed Ground-Water (inches):				Weeping:			Standing:				Observed Ledge:		
	Soil Horizon	Depth (inches)	Matrix Color (moist)		Redoximorphic Features		Soil Texture (USDA)	Gravel Percent	Soil Consistence	Roots	Other	Soil Consistence	Roots	Other
			Depth	Color	Depth	Color								

Special Conditions		Location Drawing	
Design Flow > 2000 GPD			
Public Water Supply Watershed			
Probable High Ground Water			
Slope > 25 Percent			
Perc Rate < 1 min/inch			
Perc Rate > 30 min/inch			
Ledge < 5 feet Below Grade			
Limited Suitable Area			
Open Watercourse or Wetland			
Flood Plain/Seasonal Flooding			
G.W. < 36 inches Below Grade			
Conclusions			
Suitable for Sewage Disposal			
Unsuitable for Sewage Disposal			
Additional Investigation Required			
Wet Season Monitoring Required			
Retest During Wet Season			
Licensed Engineer Plan Required			
Other:			
Percolation Test Data			
PERC:	PERC:	PERC:	PERC:
DEPTH:	DEPTH:	DEPTH:	DEPTH:
PRESOAK:	PRESOAK:	PRESOAK:	PRESOAK:
TIME	READING	TIME	READING
PERC RATE:	PERC RATE:	PERC RATE:	PERC RATE:

Application/Permit #: _____

Subsurface Sewage Disposal System Final Inspection Report

Local Health Department: _____

Property Owner: _____

Property Address: _____ Town: _____

Licensed Installer: _____ License #: _____ Expiration Date: _____

Check one: New System Repair/Replacement System

Residential Building: _____ bedrooms _____ Large Bathtub (Y/N): _____ Garbage Disposal (Y/N): _____

Non residential Building/Residential Institution: _____ GPD _____ Type of Use: _____

Water Treatment Wastewater (WTW) Generated (Y/N): _____ WTW Dispersal System (Y/N): _____

Inspection Information

Type	Date	Licensed Installer Present? Yes/No	Pass or Fail	Additional Comments
Field Stake Inspection (house, well, property lines, system, benchmark, etc.)				Benchmark:
Strip/Scarification				Dimensions:
Select Fill Placement				Sieve required (Y/N)
Other:				
Final Inspection				Completed by:

Building Sewer Information

Pipe Type and ASTM Specification: _____ Pipe Size: _____ in.

Pipe Invert Elevations at: Foundation Wall: _____ Pipe Length: _____ ft.

Septic Tank In: _____ Pitch Required: _____

Septic Tank Out: _____ Pitch Provided: _____

Final Inspection Report (cont'd)
Sewage Tank Information

Septic Tank Size : _____ Gallons Risers Needed (Y/N): _____

Tank Manufacturer: _____ Secondary Safety Device (Y/N): _____

Date Manufactured: _____ Effluent Filter
Manufacturer: _____

Pump Chamber Size: _____ Gallons Pump Alarm Checked (Y/N): _____

Pump Chamber
Manufacturer: _____ Float Control Elevation Verified (Y/N): _____

Grease Interceptor
Tank Size: _____ Gallons Grease Interceptor
Tank Manufacturer: _____

Leaching System Information

Stone Aggregate: Free of silt, dirt and debris (Y/N): _____ Sieve Required (Y/N): _____

Filter Fabric Present (Y/N): _____ Type: _____ Stone Meets Specifications (Y/N): _____

Select Fill (Y/N): _____ Sieve Required (Y/N): _____ Sieve Information on File (Y/N): _____

Leaching System Description (product, size, length, number of rows, level or serial, etc.): _____

Effective Leaching Area Required: _____ sq. ft. Reserve Area Provided (Y/N): _____

Effective Leaching Area Provided: _____ sq. ft. Center to Center Spacing: _____ ft.

System Installed Per Approved Plan Elevations (Y/N): _____ Elevations Field Verified (Y/N): _____

Elevations	Row 1	Row 2	Row 3		Row 1	Row 2	Row 3
D-box in				Top of system			
D-box out				Bottom of system			
High Level Overflow				Other			

Separation Distances

Separation Distances Conform with Approved Plan (Y/N): _____ Field Verified (Y/N): _____

PERMIT TO DISCHARGE

Approval is hereby given to _____, in accordance with Public
(Property Owner)

Health Code Section 19-13-B103e (h) to discharge to a subsurface sewage disposal system located at

(Street Address)

in the town of _____, CT that will receive domestic sewage from a:

Residential building containing _____ bedrooms. Single family (Y/N): _____

Restaurant containing _____ seats.

Commercial/Office building providing _____ square feet.

Other structure as described: _____

Design Flow = _____ gallons per day. **Permitted Flow** = _____ gallons per day.

The design flow shall equal the permitted flow, except for non-compliant repairs (See Section IV D).

In order to provide a sufficient factor of safety it is recommended that the average daily discharge not exceed 2/3 of the permitted flow or _____ gallons per day.

Operation and Maintenance: Septic tank shall be inspected regularly and pumped as needed but not less frequently than every five years. The septic tank has an effluent filter (Y/N) _____. Effluent filters require periodic cleaning. Failure to clean filters can result in sewage backup into the building or effluent breakout. Restaurants serviced by external grease interceptor tank(s) require quarterly inspections and cleaning as necessary. Tank pump-outs tracked by local health department (Y/N) _____. If yes, stipulate pump-out requirements: _____

Special Requirements and Restrictions: _____

Exceptions (Repairs Only): _____

File Information: Construction Permit No. _____. Approved as-built on file (Y/N) _____

Date of Final Inspection: _____ Inspected By: _____

Permit Issuance: Issued by: _____ Title: _____
(Director of Health or Registered Sanitarian)

Signature: _____ Date: _____

Permit expiration date (5 years from issuance date): _____

APPENDIX A: MINIMUM LEACHING SYSTEM SPREAD (MLSS)

Section VIII A includes stipulations for leaching system compliance with MLSS for new and repair SSDSs, and the necessity for new SSDSs to have sufficient naturally occurring soil (a.k.a., natural soil) to disperse effluent from the leaching system. Code-complying areas identified pursuant to PHC Section 19-13-B100a (B100a) are also required to be laid out in an area with sufficient naturally occurring soil to accommodate MLSS compliant leaching systems. Receiving soil utilized for a leaching system repair can consider fill material if sufficient naturally occurring soil is not available.

Separate leaching systems that rely on the same receiving soil for the dispersal of effluent shall be evaluated collectively as a single leaching system. This applies to leaching systems on sloped lots less than 50 feet apart within the same hydraulic window, and leaching systems less than 25 feet apart on radial flow lots. A single leaching system row shall contain leaching units with similar ELA ratings (within 10 percent) or shall be analyzed to ensure no portion of the receiving soil is overloaded, unless MLSS is not applicable.

MLSS Formula

$$\text{MLSS (feet)} = \text{HF} \times \text{FF} \times \text{PF}$$

HYDRAULIC FACTOR (HF) = Factor based on the hydraulic gradient and receiving soil depth.

FLOW FACTOR (FF) = Factor based on the design flow of the building served.

PERCOLATION FACTOR (PF) = Factor based on the percolation rate of the receiving soil.

Definitions & Factor Information

Hydraulic gradient means the percent slope of the naturally occurring grade, or when demonstrated, the percent slope of the restrictive layer. The hydraulic gradient on a lot with radial flow over a flat groundwater table shall be confirmed to be level (essentially 0 percent) by evaluating groundwater elevations in the leaching system area and surrounding soil. The hydraulic gradient on a lot that utilizes the slope of the naturally occurring soil as the gradient shall evaluate the naturally occurring grade within and at least 25 feet down-gradient of the leaching system.

Leaching system spread means the leaching system length of effluent application to the receiving soil. The leaching system spread for a leaching system that disperses effluent via radial flow over a flat groundwater table shall be measured around the perimeter of the leaching system. The leaching system spread for a leaching system that disperses effluent along a hydraulic gradient shall be measured perpendicular to the hydraulic gradient, and shall take into account converging and diverging contours at least 25 feet down-gradient of the leaching system.

Restrictive layer means the first layer beneath the receiving soil that impedes downward movement of effluent. Restrictive layers include ledge rock, maximum groundwater, and impervious soil (percolation rate slower than 60 minutes per inch). The depth to maximum groundwater shall be determined by field verification of redoximorphic features or groundwater monitoring. Standpipe readings used for groundwater monitoring shall utilize the average of at least 5 consecutive weekly readings taken during the most restrictive 30-day period of the wet season.

Receiving soil (per Section I) means the soil in the leaching system area and surrounding soil that is available to disperse effluent. Surrounding soil for a leaching system that disperses effluent via radial flow over a flat groundwater table includes the soil within 25 feet around the perimeter of the leaching system. Surrounding soil for a leaching system that disperses effluent along a hydraulic gradient includes the soil within 50 feet down-gradient of a large (2,000 to 7,500 GPD) system, and at least 25 feet down-gradient of a small system.

Receiving soil depth (RS Depth) means the average depth of receiving soil (soil in a leaching system area and surrounding soil) measured down to the restrictive layer.

RS Depth Calculations and Factor Tables

RS Depth shall be determined based on criteria in the applicable category (1, 2, or 3).

$$RS\ Depth = \frac{A + B}{2}$$

A = Receiving soil in the leaching system (LS) area.

B = Receiving soil surrounding the LS. Surrounding soil is soil down-gradient of the LS on lots with sloped restrictive layers, and soil around the perimeter of the LS on lots with flat groundwater tables.

Category 1 - Conceptual B100a Areas (Code-Complying & Potential Repair), and SSDS Layouts for New Lots: Leaching system spreads shall equal or surpass the MLSS. The RS Depth shall only include naturally occurring soil in both the leaching system area and the surrounding soil area (e.g., down-gradient of leaching system, around perimeter of leaching system).

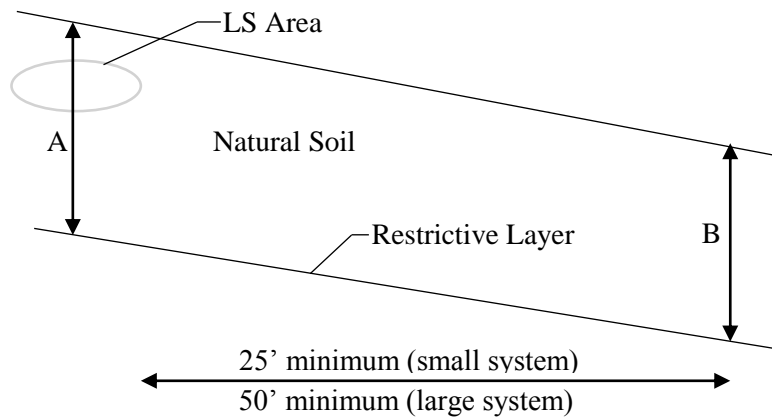

Diagram 1 - Sloped Restrictive Layer

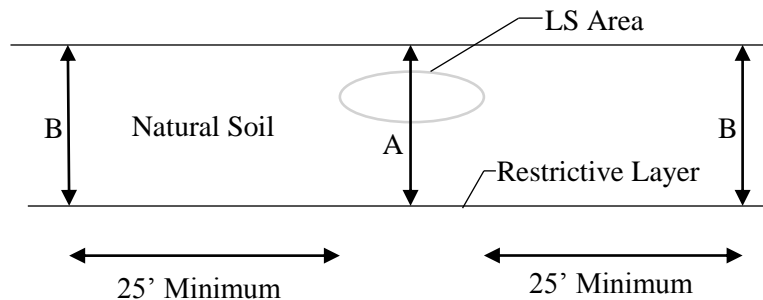
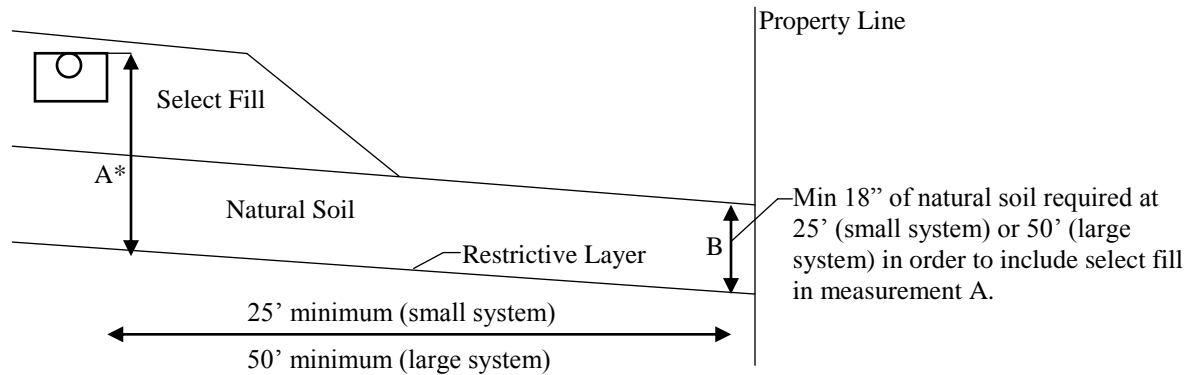

Diagram 2 - Flat Groundwater Table

Category 2 - New SSDS and MLSS Compliant Repairs: Leaching system spreads shall equal or surpass the MLSS. A leaching system that is designed with the top of the system more than 12 inches below natural grade shall have receiving soil in the leaching system area measured from the top of the system to the restrictive layer (see Diagram 4). Receiving soil may include select fill (maximum of 24 inches) measured to the top of the system in the leaching system area if all the receiving soil is on the property and there is at least 18 inches of naturally occurring receiving soil (see Diagram 3); a maximum RS depth of 60 inches is allowed when select fill is included in receiving soil measurement in leaching system area.



*Receiving soil in LS area may include up to 24” of select fill measured from top of system if all receiving soil is on property and there is at least 18” of natural soil throughout the receiving soil.

Diagram 3 – LS in Select Fill (Sloped Restrictive Layer)

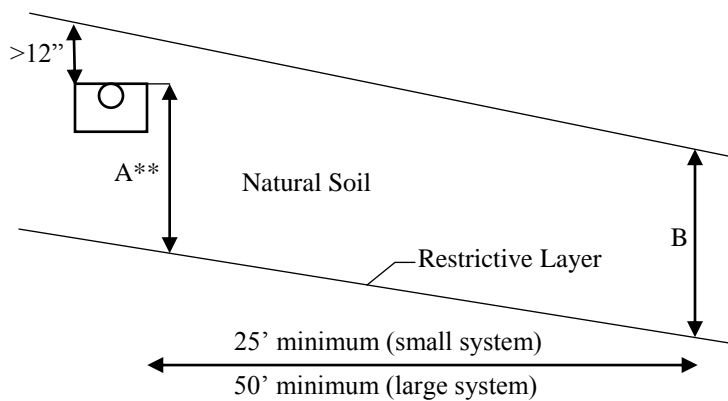

**Receiving soil in the LS area is measured from natural grade; if the top of system is more than 12” below natural grade then it is measured from the top of the system.

Diagram 4 – LS in Natural Soil (Sloped Restrictive Layer)

Category 3 - MLSS Non-compliant Repairs and B100a MLSS Non-compliant Potential Repair Areas: If there is less than 18 inches of naturally occurring receiving soil, or when the leaching system cannot meet the MLSS or hydraulic analysis, an exception from the DOH shall be required, and a non-compliant repair (NCR) MLSS assessment shall be conducted. The NCR MLSS takes into account the hydraulic capacity of existing receiving soil, both fill and naturally occurring, and additional fill included in the SSDS design. The following criterion shall be utilized in calculating the NCR MLSS:

1. Receiving soil fill shall have a percolation rate of 30 minutes per inch or faster, and shall be clean material relatively free of debris and foreign objects.
2. Receiving soil in the leaching system area shall be measured from the top of the system to the restrictive layer (see Diagram 5).
3. Receiving soil on a flat groundwater table lot shall have a minimum depth of 6 inches. Receiving soil on a sloped lot shall have a minimum depth of 12 inches. (See Diagrams 5 & 6).
4. RS Depth may include both naturally occurring soil and fill, and shall have a minimum depth of 18 inches and a maximum of depth 60 inches.
5. Select fill used as receiving soil shall require percolation tests after placement to confirm the basis of design. Percolation rates of different receiving soil layers shall be applied proportionately.

Leaching systems shall provide the maximum percent possible of the NCR MLSS calculated based on a RS Depth of 18.0 - 22.0 inches, or based on the depth of existing receiving soil if greater. Additional fill shall be considered to reduce the calculated NCR MLSS when compliance cannot be achieved. Leaching systems that provide less than 25 percent of the NCR MLSS, or do not comply with items 3 or 4 above, shall require a SSDS designed by a P.E. and a study of the receiving soil's ability to absorb or disperse the permitted flow in accordance with PHC Section 19-13-B103d (e) (4).

For the purposes of PHC Section 19-13-B100a (c) (2) and Section IV C, the required MLSS shall be equivalent to the NCR MLSS. The permitted flow noted on the Permit to Discharge shall be based on the most limited percentage of the required ELA or NCR MLSS provided. The Permit to Discharge shall clearly state that the system is non-compliant relative to MLSS, and that an exception has been granted.

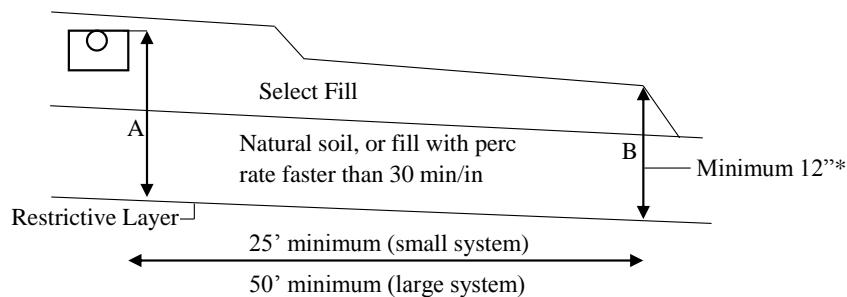

Diagram 5 – Select Fill, and Natural Soil or Fill as Receiving Soil (Sloped Restrictive Layer)

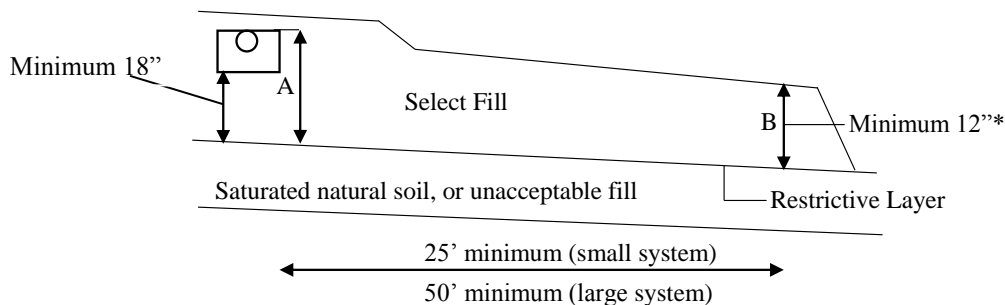

Diagram 6 – Select Fill Receiving Soil (Sloped Restrictive Layer)

*On flat groundwater table lots there shall be a minimum of 6" of receiving soil 25' around the perimeter of the leaching system.

HYDRAULIC FACTORS (HF)

Hydraulic Gradient (% Slope)

	<1.0	1.0-2.0	2.1-3.0	3.1-4.0	4.1-6.0	6.1-8.0	8.1-10.0	10.1-15.0	>15.0
0.1 - 17.9	See Comments in Section VIII A								
18.0 - 22.0	72	62	54	48	42	34	30	28	26
22.1 - 26.0	66	56	48	42	34	30	28	26	24
26.1 - 30.0	56	49	42	34	30	28	26	24	20
30.1 - 36.0	48	42	34	30	28	26	24	20	18
36.1 - 42.0	42	36	30	28	26	24	20	18	16
42.1 - 48.0	36	32	28	26	24	20	18	16	14
48.1 - 60.0	30	28	24	22	20	18	16	14	10
>60.0	MLSS Need Not be Considered								

Receiving
Soil Depth
(Inches)

FLOW FACTORS (FF)

Flow Factor = Design Flow/300	
Residential: Design Flow for each bedroom is 150 GPD except for bedrooms beyond 3 in single-family residential buildings, which have a 75 GPD per bedroom design flow.	
Single-family lots:	FF
1 Bedroom = 150/300	0.5
2 Bedroom = 300/300	1.0
3 Bedroom = 450/300	1.5
4 Bedroom = 525/300	1.75 Increase FF by 0.25 for each additional bedroom
Multi-family buildings:	
Minimum FF is 2.0 (4 bedrooms) and each additional bedroom increases FF by 0.5.	
Non-Residential:	Design Flow (GPD) / 300

PERCOLATION FACTORS (PF)

Percolation Rate	Percolation Factor (PF)
Up to 10.0 Minutes/Inch	1.0
10.1 to 20.0 Minutes/Inch	1.25
20.1 to 30.0 Minutes/Inch	1.5
30.1 to 45.0 Minutes/Inch	3.0, or 2.0*
45.1 to 60.0 Minutes/Inch	5.0, or 3.0*

*If leaching system is entirely in select fill and the bottom of system is above existing grade and at least 24 inches above maximum groundwater.

APPENDIX B: APPROVED SEPTIC TANK EFFLUENT FILTERS

MANUFACTURER	MODEL
BEAR ONSITE	ML2-416, ML2-920, ML3-910, ML3-916, ML3-925, ML3-932,
BIO-MICROBICS	SANITEE Series: ST 416, ST 418, ST 818, ST 838, ST 1618, ST 1638
BOWCO INDUSTRIES	EF-235
GAG-SIMTECH	STF-110, STF-110-7R, STF-110-6W, STF-110-8B
NORWECO	BIO-KINETIC BK2000
ORENCO SYSTEMS	FT0444-36, FT0854-36, FT1254-36, FT1554-36, FTJ0418
POLYLOK	PL-68, PL-122, PL-250, PL-525, PL-625, GF10-8, GF10-16
PREMIER TECH	EFT-080
RISSY PLASTICS	45 – CLIK N' STICK
TUF-TITE	EF-4, EF-6
ZABEL	A100, A300, A1800, A1801, A100-HIP, A300-HIP A1800-HIP, A1801-HIP, A600-12, A600-8
ZOELLER/CLARUS	WW1 (170-0078), WW4 (5000-0007)

APPENDIX C: APPROVED FILTER FABRICS FOR COVERING STONE AGGREGATE

MANUFACTURER/ DISTRIBUTOR	DESIGNATION NUMBER
AMERICAN ENGINEERING FABRICS	AEF-480
BRADLEY INDUSTRIAL TEXTILE	PHOENIX LIJOMA
CARTHAGE MILLS	M35
CULTEC	410
DUPONT	SF20
ENGINEERED SYNTHETIC PRODUCTS	TNS R020
GEO FABRICS	GF 150
L&M SUPPLY COMPANY	L&M 231
MIRAFI	65304 (4' WIDE) 65303 (3' WIDE)
SKAPS INDUSTRIES	SKAPS GT 120
SRW PRODUCTS	SRW PRODUCTS DF1 SRW PRODUCTS DF2
TERRA TEX	S01.5, P01.5
TYPAR	3151, 3201
US FABRIC INC	US 1.5 CT

APPENDIX D: APPROVED NON-CONCRETE SEPTIC TANKS

MANUFACTURER	DESIGNATION/ID NUMBER	GALLONS
NORWESCO Note: STD (Standard Tank) BSR (Bruiser Tank)	STD 1000 STD 1250 STD 1500 BSR 1000 BSR 1250 BSR 1500	1000 1250 1500 1000 1250 1500
SNYDER INDUSTRIES Plumbed tanks are provided with inlet & outlet piping whereas unplumbed tanks are not.	Dominator Tanks (Plumbed) 1001010W95314 1001411W95304 1001511W95303 Dominator Tanks (Unplumbed) 1001010W95306 1001411W95306 1001511W95307	1000 1250 1500 1000 1250 1500
NORWESCO/SNYDER (Dual Marked Tanks)	CT 1000 LP CT 1250 LP CT 1500 LP	1000 1250 1500
DEN HARTOG INDUSTRIES (Ace Roto-Mold)	AST 1000-2 AST 1250-2 AST 1500-2	1000 1250 1500
ROTH GLOBAL PLASTICS RMT = Roth Multi-Tank Model	RMT-1000E RMT-1060 RMT-1250 RMT-1500	1000 1060 1250 1500
INFILTRATOR WATER TECHNOLOGIES	IM-1060 IM-1530	1070 1512

APPENDIX E: WATER TREATMENT WASTEWATER DISCHARGES TO SSDSs**Authorized WTW Sources**

WTW shall only be from a calcite filter, granular activated carbon filter, or a Point of Use (POU) reverse osmosis unit.

WTW Discharge Limits

Single-family residential buildings: WTW discharge is less than 150 gallons per backwash cycle, and cannot exceed a daily average of 50 GPD.

Other buildings: WTW discharge is less than 150 gallons per backwash cycle or less than 10 percent of the building's SSDS daily design flow, whichever is greater. Additionally, discharges cannot exceed a daily average of 50 GPD or 2 percent of the buildings SSDS daily design flow, whichever is greater.

Existing SSDS Requirements

Septic tanks must have two compartments, an effluent filter, and be properly sized for the daily design flow of the building. Single compartment tanks can remain only if receiving WTW from a POU reverse osmosis unit that discharges less than 50 GPD. Septic tanks must have been cleaned and inspected within three years with no reported signs of malfunctioning.

Leaching systems must provide at least 50 percent of the required ELA and be in good operating condition with no signs of malfunction or at risk of hydraulically overloading the receiving soil.

Proprietary Leaching Systems

Proprietary leaching system companies may not support the discharge of WTW into their SSDS products. Therefore the applicant should consult with the proprietary company to determine if use of their leaching system product is suitable with WTW discharge.

PUBLIC HEALTH CODE B104 REGULATIONS*

On-Site Sewage Disposal Systems with Design Flows Greater than 5,000 Gallons per Day**

*The reference to the Commissioner of Health Services was changed to the Commissioner of Public Health in the below printing of the B104 regulations (Sections 19-13-B104a through 19-13-B104d) to be consistent with the language in the *Technical Standards for Subsurface Sewage Disposal Systems*.

**Note: The 5,000 gallons per day jurisdictional design flow was raised to 7,500 gallons per day by Public Act No. 17-146, Section 30 effective July 1, 2017.

Sec. 19-13-B104a. Scope

These regulations set standards for domestic sewage disposal systems receiving flows greater than 5,000 gallons per day; community sewage systems as defined in Section 7-245, Connecticut General Statutes, which utilize land treatment and disposal, alternative on-site sewage treatment systems; and septage disposal systems which utilize land treatment and disposal.

(Effective August 16, 1982)

Sec. 19-13-B104b. Definitions

- (a) **Alternative on-site sewage treatment systems** means a system serving one or more buildings on one property which utilizes a method of treatment other than a subsurface sewage disposal system and which involves a discharge to the waters of the state.
- (b) **Domestic sewage** means sewage that consists of water and human excretions or other waterborne wastes incidental to the occupancy of the residential buildings or a nonresidential building but not including manufacturing process water, cooling water, wastewater from water softening equipment, commercial laundry wastewater, blowdown from heating or cooling equipment, water from cellars or floor drains or surface water from roofs, paved surfaces or yard drains.
- (c) **House sewer** means a tight sewer pipe extending from the building served by a subsurface sewage disposal system.
- (d) **Land treatment and disposal** means a system which utilizes soil materials for the treatment of domestic sewage and disposes of the treated effluent by percolation into underlying soil and mixing with the groundwater.
- (e) **Local Director of Health** means the local director of health or his authorized agent.
- (f) **Person** means any individual, partnership, association, firm, corporation or other entity, except a municipality, and includes the federal government, the state or any instrumentality of the state and any officer or governing or managing body of any partnership, association, firm or corporation.
- (g) **Septage** means any water of material withdrawn from a septic tank used to treat domestic sewage.
- (h) **Subsurface sewage disposal system** means a system consisting of a house or collection sewer, a septic tank followed by a leaching system, any necessary pumps or siphons, and any groundwater control system on which the operation of the leaching system is dependent.

(Effective August 16, 1982)

Sec. 19-13-B104c. General Provisions

- (a) All sewers, sewage disposal systems, toilets, or sewage plumbing systems shall be kept in a sanitary condition at all times and be so constructed and maintained as to prevent the escape of odors and to exclude animals and insects. All such systems shall adhere to the requirements set forth in Section 25-54i of the Connecticut General Statutes.
- (b) The contents of the septic tank, subsurface sewage disposal system or privy vault shall only be disposed of in the following manner.
 - (1) If the contents are to be disposed of on the land of the owner, disposal shall be by burial or other method which does not present a health hazard or nuisance; or
 - (2) If the contents are to be disposed of on land of other than the owner;
 - (A) The contents shall be transferred and removed by a cleaner licensed pursuant to Connecticut General Statutes § 20-341, and
 - (B) Only on the application for and an issuance of a written permit from the local director of health in accordance with the provisions of this section;

- (3) If the contents are to be disposed of on a public water supply watershed, only on the application and issuance of a written permit by the Commissioner of Public Health in accordance with the provisions of this section.

Each application for a permit under subdivisions (2) and (3) of subsection (b) shall be in writing and designate where and in what manner the material shall be disposed of.

- (c) All material removed from any septic tank, privy, sewer, subsurface sewage disposal system, sewage holding tank, toilet or sewage plumbing system shall be transported in watertight vehicles or containers in such a manner that no nuisance or public health hazard is presented. All vehicles used for transportation of such material shall bear the name of the company or licensee and shall be maintained and clean exterior conditions at all times. No defective or leaking equipment shall be used in cleaning operations. All vehicles or equipment shall be stored in a clean condition when not in use. Water used for rinsing such vehicles or equipment shall be considered sewage and shall be disposed of in a sanitary manner approved by the local director of health.
- (d) Septic tanks shall be cleaned by first lowering the liquid level sufficiently below the outlet to prevent sludge or scum from overflowing to the leaching system where it could cause clogging or otherwise damage the system. Substantially all of the sludge or scum accumulation shall be removed whenever possible, and the inlet and outlet baffles shall be inspected for damage or clogging. Cleaners shall use all reasonable precautions to prevent damaging the sewage disposal system with vehicles or equipment. Accidental spillage of sewage, sludge, or scum be promptly removed or otherwise abated so as to prevent a nuisance or public health hazard.
- (e) No sewage shall be allowed to discharge or flow into any storm drain, gutter, street, roadway or public place, nor shall such material discharge onto any private property so as to create a nuisance or condition detrimental to health. Whenever it is brought to the attention of the local director of health that such a condition exists on any property, he shall investigate and cause the abatement of this condition.
- (f) Persons who intend to conduct site investigations for the purpose of designing or constructing any septage or sewage disposal system within the scope of these regulations shall notify the local director of health of the time and place of such site investigations. Notice shall be provided to the local director of health in a timely manner to allow attendance at such site investigations by the director of health.
- (g) Persons who propose sewage or septage disposal systems within the scope of this regulation shall submit plans for such systems to the Commissioner of Public Health and the local director of health. Plans shall be submitted in a timely manner to allow review and comment on such plans to be directed to the Commissioner of Environmental Protection. Such plans shall be prepared by a professional engineer registered in the State of Connecticut and shall include a report of the findings of all site investigations, the basis of design, a preliminary or final design and other information necessary for the preservation and improvement of public health.
- (h) Persons who intend to construct sewage or septage disposal systems within the scope of these regulations shall file final construction plans with the local director of health at least two working days prior to the start of construction. All such systems shall be inspected during construction by the local director of health. Persons constructing such systems shall give prior notification to the local director of health of any changes which are proposed or required during construction. Persons constructing such systems shall provide the local director of health with a record drawing of the system, as-built, prior to utilizing the system.

(Effective August 16, 1982)

Sec. 19-13-B104d. Minimum Requirements

- (a) All sewage or septage disposal systems under the scope of these regulations shall meet the following minimum requirements necessary for the preservation and improvement of public health, unless an exception is granted by the Commissioner of Public Health upon his determination that public health shall not be impaired by such exception.
- (b) All structures or facilities for the treatment or disposal of sewage or septage shall be located at least 50 feet from any open water source and 100 feet from any public supply reservoir, unless designed and constructed to prevent the leakage or overflow of raw or treated sewage to the ground or surface water.
- (c) All structures, facilities or locations containing sewage or septage which is exposed to the atmosphere shall be located at least 150 feet from any school, residential building or institution, and shall be fenced or otherwise made inaccessible to the public.
- (d) The following minimum separating distances shall be maintained between any discharge or overflow of raw or treated sewage or septage to the ground waters and any drinking water supply well or spring.

Required Withdrawal Rate	Minimum Separation Distance
Under 10 gallons per minute	75 feet
10 to 50 gallons per minute	150 feet
Over 50 gallons per minute	200 feet

- (e) The following minimum separating distances shall be maintained between any sewer, structure or facility for the conveyance or treatment of sewage or septage and any drinking water supply well or spring.

Required Withdrawal Rate	Minimum Separation Distance
Under 10 gallons per minute	25 feet
10 to 50 gallons per minute	75 feet
Over 50 gallons per minute	100 feet

(Effective August 16, 1982)

Statement of Purpose

The regulations update existing Public Health Code requirements for the design and installation of large subsurface sewage disposal systems, the design flow of which exceed 5,000 gallons per day. Sewage disposal systems conforming to this regulation and designed to include the latest state-of-the-art technology will provide for the preservation and improvement of public health.

