



YOUR ENVIRONMENT IS OUR BUSINESS.

EcoDWT plus 3

Installation Instructions

For single and Multiple Tank Applications



Listed under SU2258

Meets the requirements of NFPA 31 (2001) and CSA B-139-04

Roth Industries

268 Bellew Ave South
Watertown, NY 13601

USA Contact Info:

Phone: 315-755-1011
Toll Free: 888.266.7684
Fax: 866-462-2914
E-mail: info@roth-usa.com
Web Site: www.roth-usa.com

Canadian Contact Info:

Toll Free: 800.969.7684
Fax: 866-462-2914
E-mail: service@roth-canada.com
Web Site: www.roth-canada.com

Table of Contents

1	General Warnings	3
2	Technical Installation Instructions	4
	General Information and approximate dimensions	4
	Inspection of Tank Contents	4
	<u>Unpacking and Damage Evaluation</u>	4
	Fig 1 – Tank & Contents	5
	General Installation Instructions	6
	<u>Location Selection</u>	6
	<u>Piping Connections</u>	6
	<u>Outside Installation (Single Tank)</u>	6
	<u>Testing & Approval for Commissioning</u>	6
	<u>Flood & Earthquake Considerations</u>	7
3	Single Tank Installation Instructions	7
	Beginning Installation	7
	Fig 2 – Single Tank Installation	7
	Piping Connections	8
	Fill Piping	8
	Vent Piping	8
	Fuel Supply Piping	8
	<u>“Hard Pipe”</u>	9
	Fuel Level Gauge	9
	Outside Installation of a Single Tank	9
4	Roth Tank Installation Accessory Parts	10
	Figure 3– Fuel Gauge	10
	Figure 4– Tie Down Kits	10
	Figure 5– Roth Vent Alarm Figure	10
	Figure 6– Roth Tank Wrench	10
	Figure 7– 2” NPT Die Cast Adapter	10
	Figure 8- Outdoor Tank Covers	10
	Figure 9– Fuel Oil De-Aerator	11
5	Multiple Tank Installation Instructions (2-5 Tanks)	12
	Initial Considerations	12
	Indoor Installations	12
	Roth Expansion Kits	12
	<u>Parts Number</u>	12
	Fig 10 - Side by Side Multiple Tanks	13
	Fig 11 – Fill Piping Assembly (Side by Side)	14
	<u>Vent Piping</u>	14
	Fig 12 – Vent Piping Assembly (Side-by-Side)	15
	Fuel Supply Piping	15
	<u>“Hard Piping” the Fuel Supply Lines</u>	15
	Fig 13– Fuel Supply Piping Using Duplex Tank Bushings and Equal Manifold Configuration for 2-5 Tanks	16
	End to End Installation - Applies to (2) 1000L Tanks Only!	17
	Figure 14– Fill Piping End to End Installation	17
	Figure 14– Vent Piping End to End Installation	17
	Outdoor Installation of Multiple Tanks	17
6	Final Completion	18
7	Warranty Certificate	19
8	Notes	20
9	Installation Check List	21

1. General Warnings

Please read and observe these warnings! Failure to comply may void the tank warranty!

- Roth EcoDWT plus 3 Oil Storage Tanks must be installed by a person who has successfully completed Roth-certified EcoDWT plus 3 installation training and the tank(s) must be installed according to these instructions.
- All Roth tanks (both inner and outer) are pressure tested at the factory according to UL® standards and do not require additional field-testing. If local codes require pressure testing of the piping, it should be done with the pipes disconnected from the tank. Further information is available in this manual.
- Do not stand on or store heavy objects on the top of these tanks.
- Do not install this tank if there is physical damage, which may affect the integrity of either the inner tank or outer containment tank. Further information is available in this manual.
- Do not remove the Leak Detector from the tank.
- All tanks must be installed with an approved vent alarm (Roth Vent Alarm #2350000999), or equivalent sized UL listed whistle vent) in order to maintain warranty requirements.
- All tanks installed outside must have a Roth approved cover as specified in this manual.
- All multiple tanks must be installed with the Roth Expansion Kits or with separate fill lines for each tank as described in this manual. A field-constructed manifold for the vent piping may be used on multiple tanks with separate fill lines if permitted by local codes.
- Multiple tank installations using the Roth Expansion Kits must have a tight-fitting connection for the delivery truck hose. These tanks must be “pressure filled” at 40-85 gpm (150-325 lpm) and 85 psi (586 kPa) maximum pressure. “Cascade” filling of multiple tanks is not permitted under any circumstances. If “pressure filling” systems are not available on either the delivery truck or the fill connection point all tanks must have separate fill lines.
- The warranty for the steel containment tank is reduced from ten (10) years to five (5) years for tanks installed outdoors within 300’ (92 m) of the high water level of a salt-water body.
- The tank warranty is only valid if one copy of the warranty card is completed and returned to the manufacturer within ten (10) days of installation. The second copy must be left with the customer. If the warranty card is not registered as above, the warranty period will begin on the date of manufacture.
- The tank warranty applies to the original installation address only. Reinstallation of the tank at a new location will void the warranty.
- All Roth Eco DWT plus 3 tanks should be inspected by the homeowner, a qualified service technician or the fuel oil supplier at the beginning and end of the heating season to verify that the entire system is free of leaks. This is a minimum requirement. Some locations may require the fuel delivery driver to check the system before and after each delivery. Check local codes for requirements.

2. Technical Installation Instructions

General Information

The Roth EcoDWT plus 3 Oil Storage Tanks are UL® listed in the United States and Canada under SU2258 and approved under NFPA 31 (2001) and CSA B-139-04 as non-metallic fuel oil storage tanks. Other codes may be in effect in your area and may impose additional restrictions. If you have any questions regarding these requirements, please contact your local building or fire official for more information.

The Roth EcoDWT plus 3 are available in five (5) sizes. Approximate dimensions and capacities are:

Tank Model	DWT 400L	DWT 620L	DWT 1000L	DWT 1000LH	DWT 1500L
Nom. Capacity US gal (liters)	110 (400)	165 (620)	275 (1000)	275 (1000)	400 (1500)
Length inches (cm)	29 (74)	29 (74)	43 (110)	51 (130)	64 (163)
Width inches (cm)	28 (72)	28 (72)	28 (72)	30 (76)	30 (77)
Height Inches (cm)	44 (112)	61 (155)	61 (155)	54 (137)	68 (173)
Min Height Req'd inches (cm)	49 (125)	66 (168)	66 (168)	60 (152)	76 (193)
Tank Weight lbs. (kg)	106 (48)	132 (60)	167 (76)	208 (94)	333 (151)
Shipping Weight lbs. (kg)	115 (52)	143 (65)	185 (84)	230 (104)	358 (162)

Approx. Footprint for Multiple DWT Installations

Tank Model	DWT 400L	DWT 620L	DWT 1000L	DWT 1000LH	DWT 1500L
2 Tanks (Side by Side)	29 x 60 (74 x 152)	29 x 60 (74 x 152)	43 x 60 (110 x 152)	51 x 63 (130 x 160)	64 x 63 (163 x 160)
3 Tanks (Side by Side)	29 x 92 (74 x 234)	29 x 92 (74 x 234)	43 x 92 (110 x 234)	51 x 96 (130 x 244)	64 x 96 (163 x 244)
4 Tanks (Side by Side)	29 x 124 (74 x 315)	29 x 124 (74 x 315)	43 x 124 (110 x 315)	51 x 129 (130 x 328)	N/A
5 Tanks (Side by Side)	29 x 156 (74 x 397)	29 x 156 (74 x 397)	43 x 156 (110 x 397)	51 x 162 (130 x 411)	N/A
2 Tanks (End to End)	N/A	N/A	28 x 90 (72 x 229)	N/A	N/A

Only technicians who have successfully completed an installation-training course given by Roth representatives are permitted to install these tanks using the installation tools and guidelines described in this manual. Roth will maintain records of individuals who have successfully completed this training. Proper installation of each tank shall be acknowledged when one copy of the Warranty Certificate is completed and signed by the installing technician.

Inspection of Tank and Contents

Unpacking and Damage Evaluation

Do not remove any protective packaging until the EcoDWT plus 3 have been delivered to the installation location. After unpacking, each tank should be visually inspected for “unacceptable” damage of the base support, the containment tank, the primary (inner) tank, rolled metal seams, fittings and accessories. Unacceptable damage is defined as any material, component or product defects such as holes, cuts or permanent deformation of the structural or fluid confining parts, which could cause leakage, excessive corrosion or other mechanical and fire safety hazards. Minor deformations and dents are acceptable except at the bottom of the dike.

Be sure to use care when you cut the shrink-wrap and remove the base and Styrofoam. Properly dispose of all packing materials.

Supplied With All Tanks

All Roth UL Listed tanks are supplied with:

- 4 - # 2350000024 Cap Nut
- 3 - # 2350000025 2" Plastic Adapters
- 4 - # 2350000031 #3 Gaskets
- 4 - Threaded Dust Plugs (Discard when ready to start installation if all connections are used)
- 4 - # 2350005738 Bulkhead Nuts (Do not remove)
- 1 - Leak Indicator (Do not remove)
- 1 - #2350006801 2" Metal Adapter (installed in one of the tank connections)
- Warranty Forms (2), Installation Instructions & Check List (under packing on top of the tank)

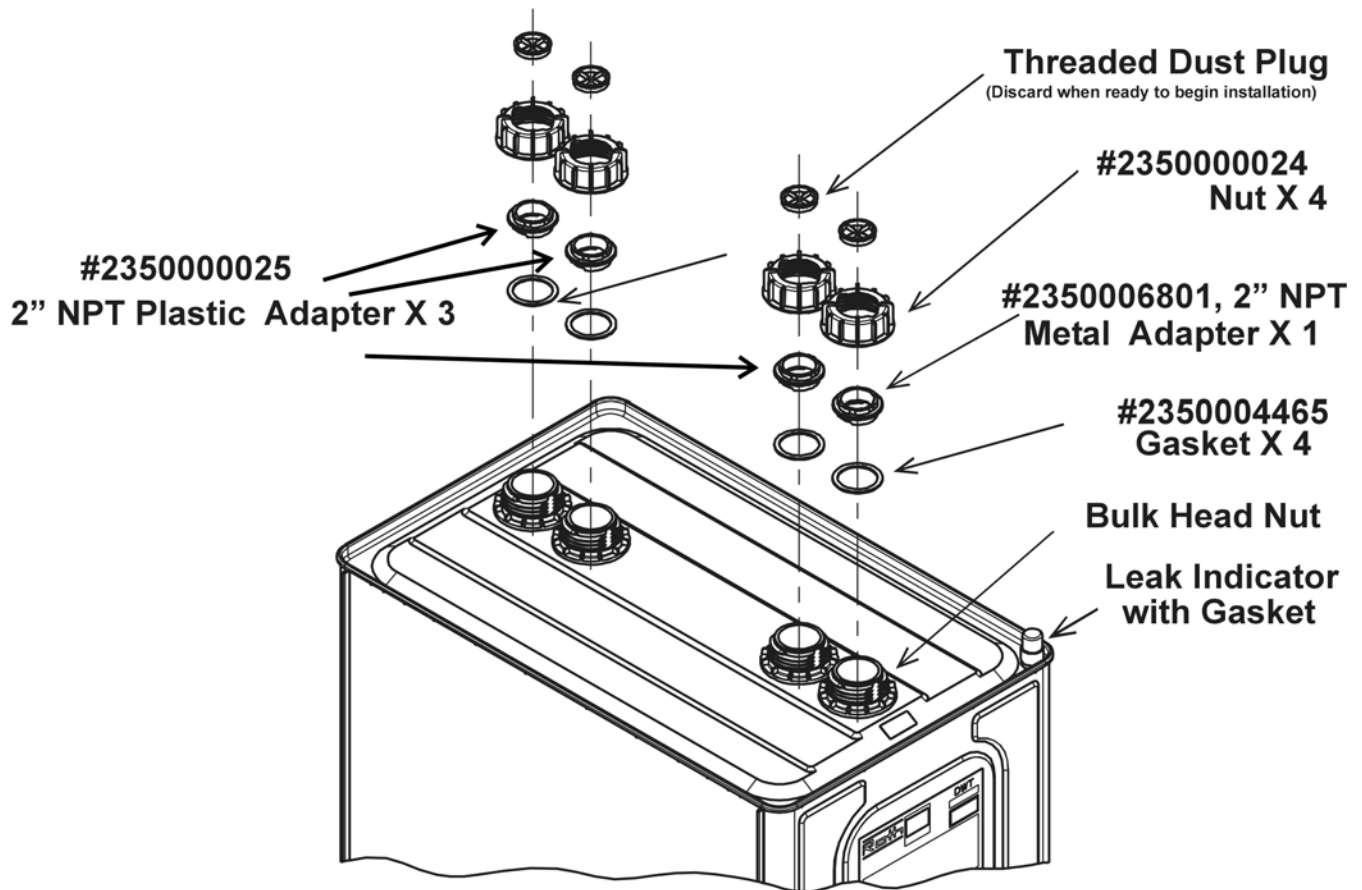

Figure 1

All parts shown in Figure 1 are preinstalled to prevent dirt from entering the tank during shipment. Be sure to inspect for damage and count all parts that come with the Roth EcoDWT plus 3 prior to installation.

General Installation Instructions

Location Selection

The tank shall be placed into service in accordance with local codes and the listed use (indoor or outdoor) on a flat, level and stable surface, away from heat sources, corrosive atmospheres or fluids, potential mechanical damage or rapid temperature changes. Tank label must be visible after installation.

A minimum of 2" (50 mm) from all walls or obstructions is recommended for normal tank expansion and visual inspection. The integral base support shall not be removed and raising the tank height is not allowed except on a continuous concrete platform at least 6" (150 mm) wider than the tank base at all sides. All local fire code setbacks for fuel oil storage tanks must be observed.

Tanks installed indoors shall not be exposed to direct sunlight on any plastic parts. Tanks installed outdoors shall be assembled with the required cover (Roth #2335100749 for the 400L and 620L, Roth #2335100757 for the 1000L, #2335003721 for the 1000LH and Roth #2335002054 for the 1500L). These covers are purchased separately and are not included with the basic tank.

Piping Connections

Connect the fill, vent, burner fuel supply piping and other accessories in accordance with local codes using only the provided transition or blank fittings and accessories. Only vent alarms specified by the manufacturer (Roth Vent Alarm #2350000999, or equivalent sized UL[®] listed vent whistle) shall be used in the tank before connection with the vent pipe. Care should be taken to ensure proper position of all gaskets and threaded connections to avoid damage or leakage. All pipe and fittings should be hand tightened and inspected for proper alignment prior to final tightening. Tighten the plastic fittings with the Roth Tank Fitting Wrench (#2350002223). Plastic fittings should be tightened to approximately 18 ft-lb (2.5 kg-m) initially. **Pipe sealants or Teflon tape are not allowed on any of the threaded plastic connections.** Bending of the pipes beyond 15° during assembly, placing stress on the transition fittings or other distortion of fittings is not allowed. Metal threaded connections should be installed in the normal manner with thread sealant, pipe wrenches, etc. All fill, vent and fuel supply piping shall be secured and supported by fire resistant hangers to prevent stress loading of the tank or fittings. The vent and fill piping shall be inspected to verify there are no blockages and are terminated outside the building with acceptable fittings and in a location allowed by local codes.

Outside Installation (Single Tank)

Tanks used in outdoor locations shall be assembled only with the required covers (#2335100749 for the 400L and 620L, #2335100757 for the 1000L, #2335003721 for the 1000LH and 2335002054 for the 1500L) with the fill, vent and fuel gauge located inside the cover. For connection to the burner fuel piping, open a knockout for the tubing to exit the cover and replace it only with a UL[®] listed outdoor rated bushing matching that tubing size to ensure a liquid-tight fit.

Testing & Approval for Commissioning

Both inner and outer tanks are pressure tested at the factory during assembly according to UL[®] standards and do not require further field-testing. If local codes require a pressure test for the piping, this test should be performed with the piping disconnected from the tank(s). After the assembly is completed, the final connections at the tank may be tested using one of the following methods: 1^o air tested at 0.5 psi (3.5 kPa) using a leak detection solution on the fittings. It is not necessary to use pressures in excess of 0.5 psi (3.5 kPa) for this purpose. 2^o hydrostatic test consisting of a thorough inspection of all connection during the first complete filling. If leaks are found at the plastic connections, check alignment and correct to seal the leak. If the fitting does not seal or is defective, it should be replaced. Following the check of the final connections, verify that the Leak Indicator is properly seated. A final visual inspection shall be done at this time including verification that all of the required labels are visible and instructions are available for the user. If all required installation items described above are accepted, the technician shall provide contact information (installing company's name and phone number) on the owner's copy of the Warranty Certificate, sign and date the manufacturer's copy of the Warranty Certificate and then send the manufacturer's copy to the office of the manufacturer. The manufacturer shall keep this copy on file as proof of proper installation.

Flood, Wind & Earthquake Protection

If tanks are installed in areas subject to earthquakes, high winds or floods, good engineering practices should be observed for tank location, piping support and connections. Local codes may require the installation of particular restraint devices, limit the placement of tanks or impose other installation requirements. You should contact your local building department for further information. We suggest the use of the Roth Tie Down Kit (#2335000222 for the 400L, #2335100222 for the 620L and 1000L, #2335200222 for the 1000LH and #2335400222 for the 1500L) in these areas. Earthquake bands may also be available from your local supply house. These bands secure the tank to a structural wall to limit movement during earthquakes or high winds. When using these bands it is important not to screw the band to the outer containment tank as this will destroy the containment tank integrity and possibly damage the inner tank and void the warranty!

3. Single Tank Installation Instructions (see Figure 2)

Beginning Installation

Insure that all of the General Installation Instructions have been followed.

Set the base on the floor in the desired location. The location should provide a stable, level area capable of supporting the weight of the tank you will be using. Local codes may impose restrictions on the material and construction methods of the base material. Observe all clearances for building and fire code requirements for your area.

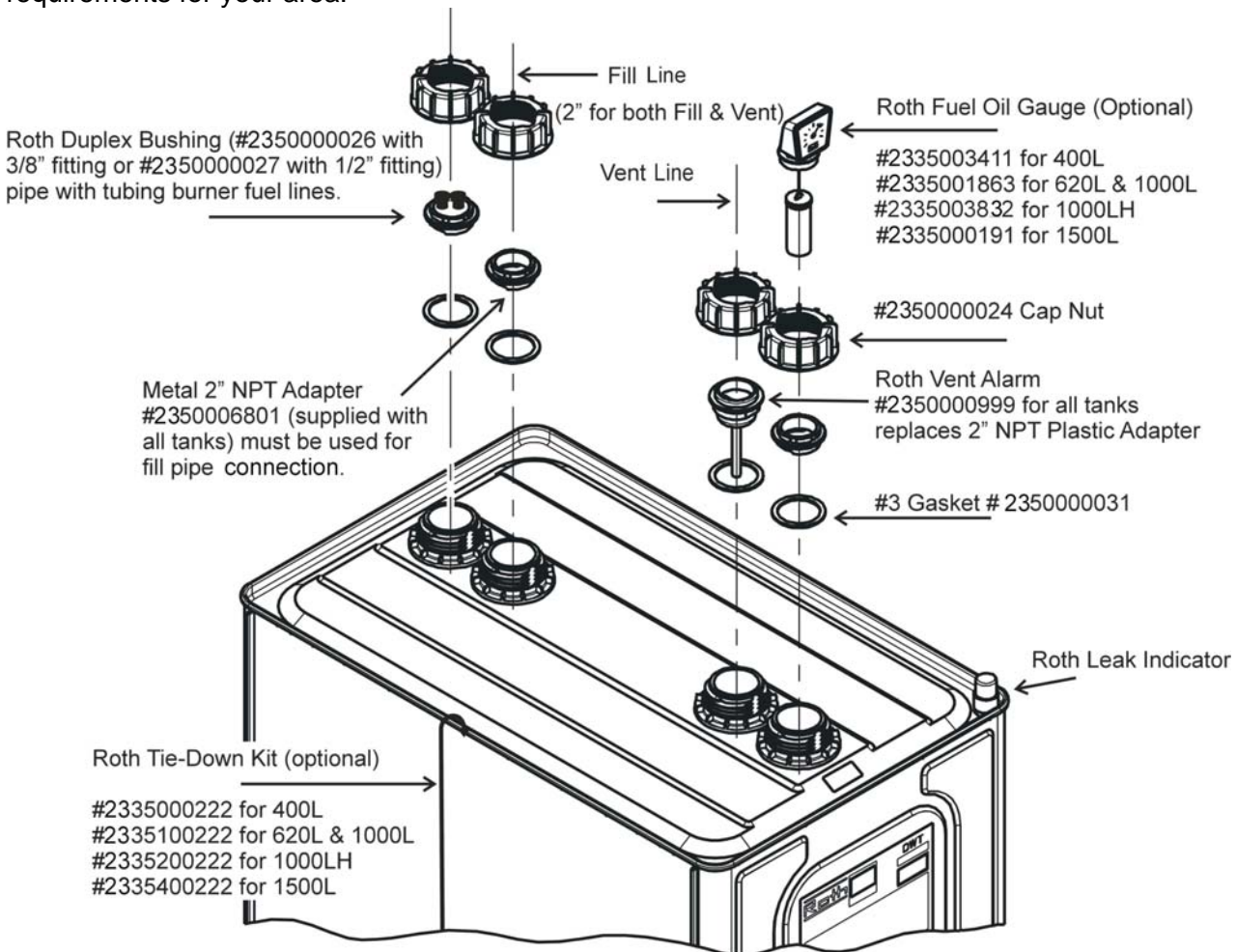

Note: All outdoor installations must use the Roth Tank Cover
#2335100749 for the 400L & 620L
#2335100757 for the 1000L
#2335003721 for the 1000LH
#2335002054 for the 1500L

Fig. 2

Determine which of the tank openings will be used for the fill, vent, fuel supply and gauge (if used) based on your installation requirements. Figure 2 is a suggested connection diagram only and other connection patterns may better suit your installation requirements. It is strongly suggested that if you use the optional fuel gauge that you install it at the opposite end of the tank from the fuel supply suction. This will ensure that the gauge float does not get tangled in the suction line.

Piping Connections

Remove dust plugs from the tank only when you are ready to use that connection. It is recommended that you assemble all fill and vent lines prior to connecting them to the tank. All piping must be properly supported and aligned with its connection point to the tank. Do not try to straighten the pipe by tightening the plastic cap nut. **DO NOT USE THE TANK TO SUPPORT THE PIPE.** The tank is not designed to support the weight of the piping and will not tolerate the torque of misaligned pipe.

All piping should be air pressure tested prior to final connection with the tank. Every tank is factory tested. Do not air test the Roth EcoDWT plus 3 in the field at pressures in excess of 0.5 psi (3.4 kPa) as this will void the tank warranty. If local codes require a piping pressure test higher than 0.5 psi (3.4 kPa), the test must be performed with the piping disconnected from the tank. After a successful piping pressure test make the final connections and perform a final air test on all the connections at no more than 0.5 psi (3.4 kPa) using a leak detection solution on all of the fittings. Do not use any pipe thread sealant or Teflon tape on any plastic threaded connections.

Fill Piping

Each fitting on the top of the tank is a swivel connection. **Do not use Teflon tape or pipe joint compound on any plastic threaded connection or on the gaskets.** Slide the large cap nut over the fill pipe connection and then tighten the 2" die cast adapter onto the end of the pipe. Place the #3 gasket on the sealing face of the adapter and place the adapter on the tank connection. Check the piping for proper alignment and length and adjust, as needed prior to the final tightening. Be sure that the gasket is properly seated between the adapter and the tank and tighten the cap nut onto the tank. Firm hand tightening is all that should be needed for a good seal. The Roth wrench (#2350002223) is for final torque. 18ft-lbs (2.5 kg-m) is the maximum required torque for this fitting.

Vent Piping

ALL TANKS MUST BE VENTED. Unless another UL[®] approved system for fill level detection is used, all tanks must have a vent alarm (whistle) installed. We require the use of our proprietary vent alarm (#2350000999) in each tank. This vent alarm also provides a 2" NPT adapter for easy connection of your vent piping to the tank. The Roth Vent Alarm is installed in place of one of the plastic adapters in the top of the tank. Use the cap nut and a #3 gasket to secure the vent alarm in the manner described above.

Vent lines must not be trapped in any way that could reduce the venting capacity of the line. Roth strongly recommends the use of a 2" vent line in all applications; however, local codes may allow some variation. You should contact your local building department or refer to the current edition adopted in your area of NFPA 31 (US) or CSA B-139 (Canada) if you have any questions.

Fuel Supply Piping

When replacing an existing fuel oil storage tank it is the installer's responsibility to check the condition of the existing fuel lines to the burner and determine if they are serviceable or need to be replaced. Consult your local codes to determine the requirements for your area if the lines need to be replaced. Follow the normal piping practices for supplying oil from top feed storage tanks.

The fuel supply piping to the burner should be done with the Roth duplex bushing with copper tubing (# 2350000026 with 3/8" fitting or # 2350000027 with 1/2" fitting).

“Hard Pipe” Fuel Supply

Fabricating your own fuel supply line of copper tubing and duplex/simplex tank bushings is always an option with the Roth EcoDWT plus 3. This is done in a similar manner to piping any standard top connection fuel tank. Install the Roth duplex bushing with the appropriate fittings for the copper tubing (# 235000026 with 3/8" fitting or # 235000027 with 1/2" fitting). The Roth duplex bushings are supplied with slip-trough compression fittings. Flare fittings are always recommended for all joints in fuel oil lines to ensure proper vacuum seal. Install the suction line to a level that is a minimum of 1" (2.5 cm) above the bottom of the tank to prevent drawing dirt into the fuel line. If a return line is used in your application, it should be terminated as customary. If the return line is terminated above the lowest expected fuel level in the tank a check valve will be required on supply line to maintain prime during burner off cycles.

Local regulations and good piping practices may require the installation of accessory items in the supply line, such as fire valves, check valves filters, etc. It is the installer's responsibility to know of and comply with these regulations and practices.

Fuel Level Gauge

Roth has an optional fuel level gauge that can be installed in the EcoDWT plus 3. These are sealed gauges and have 2" threaded connections with "O" ring seals and cord style floats. Part #2335000191 fits the 1500L (400 gal), #2335003822 fits the 1000LH (275 gal), #2335001863 fits both the 1000L (275 gal) and 620L (165 gal) and #2335003411 fits the 400L (110 gal). They are installed into one of the plastic adapters included with the tank. Remove the dust plug from one of the 2" plastic adapters and install the fuel gauge into the adapter. Hand tightening is all that is required because the gauge has an "O" ring seal for the threaded connection. Install a #3 gasket on the seating surface and place the unit into one of the tank connections. The cap nut is used to secure the unit to the tank and is tightened in the same manner as mentioned above. We recommend that the fuel gauge not be installed in a port adjacent to the fuel suction line to avoid tangling the float with the suction line.

Outside Installation (Single Tank)

All conditions of the General Installations and Single Tank Installation Instructions apply. Be sure to comply with all local building and fire codes concerning location, clearances and setbacks. A proper cement pad must be provided for the tank base. This base should meet the requirements of the current edition adopted in your area of NFPA 31 (US) or CSA B-139 (Canada) and any other local codes. At a minimum, it should extend 6" (15 cm) beyond the edge of the tank, as described earlier. Consult your local building department if you have any questions regarding these requirements.

All tanks installed outside must use a Roth Approved Tank Cover. Part #2335002054 fits the 1500L (400 gal), #2335100757 fits the 1000L (275 gal), # 2335003721 fits the 1000LH (275 gal) and #2335100749 fits both the 620L (165 gal) and 400L (110 gal) tanks. The fill pipe, vent pipe and fuel level gauge (if used) are to be located inside the cover. We recommend that outdoor installations should pipe with just a supply line and the use of a de-aerator at the burner instead of a return line. The fuel supply line (and return line, if used) must exit the cover through one of the knockouts provided in the cover and a UL[®] approved, outdoor rated bushing installed to ensure a liquid-tight seal. All fuel piping to the burner must be properly supported and protected. Some areas also require the use of jacketed containment tubing for both above and below ground fuel lines. Be sure to comply with all local codes and observe good piping practices. Tank assembly shall be protected from physical damage incident to outdoor use. Snow, ice, or rain falling from a roof can damage the tank, tank's cover and pipe. High snow load on cover will need to be shoveled out.

No tank cover is needed if the EcoDWT plus 3 is installed in a garage or shed. A shed must provide protection from rain and snow and prevent water from standing on the top of the tank. Improper protection may allow water to enter the containment tank and freeze. This will damage the inner polyethylene tank and void the warranty.

4. Installation Accessories

Fuel Level Gauge

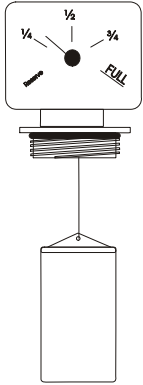

- #2335003411 for the 400L
- #2335001863 for the 620L & 1000L
- #2335003832 for the 1000LH
- #2335000191 for the 1500L

- 2" NPT connection has an O-ring seal and only requires hand tightening
- 30 psi pressure rating

Fig 3

Tie Down Kit

- #2335000222 for the 400L
- #2335100222 for the 620L & 1000L
- #2335200222 for the 1000LH
- #2335400222 for the 1500L

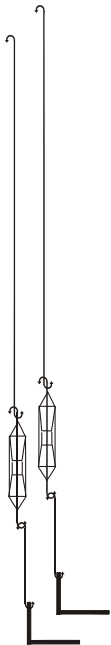

- Clips over top rim of tank
- Base bolts to floor/concrete
- Turnbuckles adjust tension
- 2 tie downs per kit
- Anchor/lag bolts supplied by installer
- Use one kit in low risk areas
- Use multiple kits in high risk areas

Note: Tighten each side evenly in an alternating pattern. Do not over tighten. Make sure that the tank remains level while tightening the tie downs

Fig 4

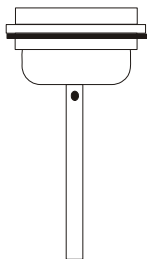

Vent Alarm

- #2350000999 (all tank models)
- Specific for Roth EcoDWT plus 3
- All metal construction
- 2" FPT adapter is built in for easy connection of the vent piping.

Fig 5



Tank Fitting Wrench

2350002223 (all tank models)

Tool for tightening the Large Plastic Cap Nut on all Roth EcoDWT plus 3.

Fig 6

Metal 2" NPT Tank Adapter

#2350006801 (all tank models)

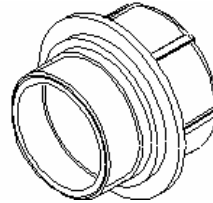

- Provides 2" female NPT connection point
- One (1) adapter included with each tank
- For connecting the fill pipe to the tank in single tank or "separate fill & vent" multiple tank applications
- For connecting a duplex tank bushing when "hard piping" fuel supply lines (*this requires the purchase of a second adapter in many cases*)

Fig 7

Roth Tank Covers

- #2335100749 for the 400L & 620L
- #2335100757 for the 1000L
- #2335003721 for the 1000LH
- #2335002054 for the 1500L

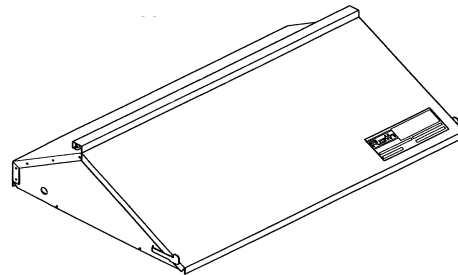

- Assembles and installs quickly with stainless steel screws provided
- Fastens to tank lip with self-tapping screws provided
- Knock-outs on both ends and back (total of 4) for fuel oil supply lines
- Required for outdoor tank installations
- May be used for multiple tank installations with separate fill and vent lines when fuel oil supply lines are manifolded outside the covers.

Fig 8

Roth Fuel Oil De-Aerator

#2335100191 (In USA only)



Fig 9

5. Multiple Tank Installations

Initial Considerations

The same considerations for location, setbacks, clearances, etc. that apply to single tank installations also apply to multiple tank installations. In general, the maximum number of tanks that can be installed in a location is five (5) 400L, 620L or 1000L, 1000LH and three (3) 1500L tanks. Be sure to check your local codes to determine what is allowed in your area.

When installing multiple tanks in tandem, all tanks must be the same model, at the same height, level and plumb. You cannot manifold different models without a risk of unequal draining or filling.

Indoor Installations (see Fig 10)

Roth offers easy to install Expansion Kits to manifold multiple indoor tanks. All tanks can be installed in a side by side configuration as shown in Fig 10. Additionally, the 1000L EcoDWT plus 3 can be installed two (2) tanks end to end. *The end to end configuration is only available for two (2) 1000L tanks.* These kits provide a common vent, fill and fuel oil supply connection.

Note: When using the Roth Expansion Kits, the tanks must be pressure filled! A tight seal connection is required between the delivery truck hose and the fill fitting. The fill rate must be 40 to 85 gpm (150 to 325 lpm) at a pressure not to exceed 85 psi (586 kPa). Failure to fill the tanks within these parameters may result in an overflow of one or more tanks. If a pressure fill connection is not available the tanks must be piped with separate fill lines.

The Roth Expansion Kits are available in the following configurations:

- Kit #1 #2315107012 For the first two 400L, 620L or 1000L tanks side by side ¹
- Kit #2 #2315107013 For the 3rd, 4th and 5th 400L, 620L or 1000L tanks side by side
- Kit #3 #2315105343 For two (2) 1000L tanks in end to end configuration ¹
- Kit #4 #2315106910 For the first two 1000LH and 1500L tanks side by side ²
- Kit #5 #2315106911 For the 3rd 1000LH and 1500L tank in side by side configuration ²

(Important! Do not install tanks without reading this section!)

As noted above, when the Roth Expansion Kits are used to manifold the tanks with a single fill connection, the tanks must be pressure filled at between 40-85 gpm (150-325 lpm) and at no more than 85 psi (586 kPa). This requires a tight fitting connection between the delivery truck nozzle and the fill fitting. *If the proper fill connection or delivery truck hose connection is not available in your area you must use individual fill pipes.* Please see the note above. *Failure to pressure fill tanks using the Roth Expansion Kit fill piping will result in possible over-pressurization or overflow of one or more tanks. This condition will void the warranty.* Some areas do not allow common fill pipes and require individual fill pipes for each tank. Please check your local codes to determine the requirements for your area.

Multiple Tank Side by Side Installation

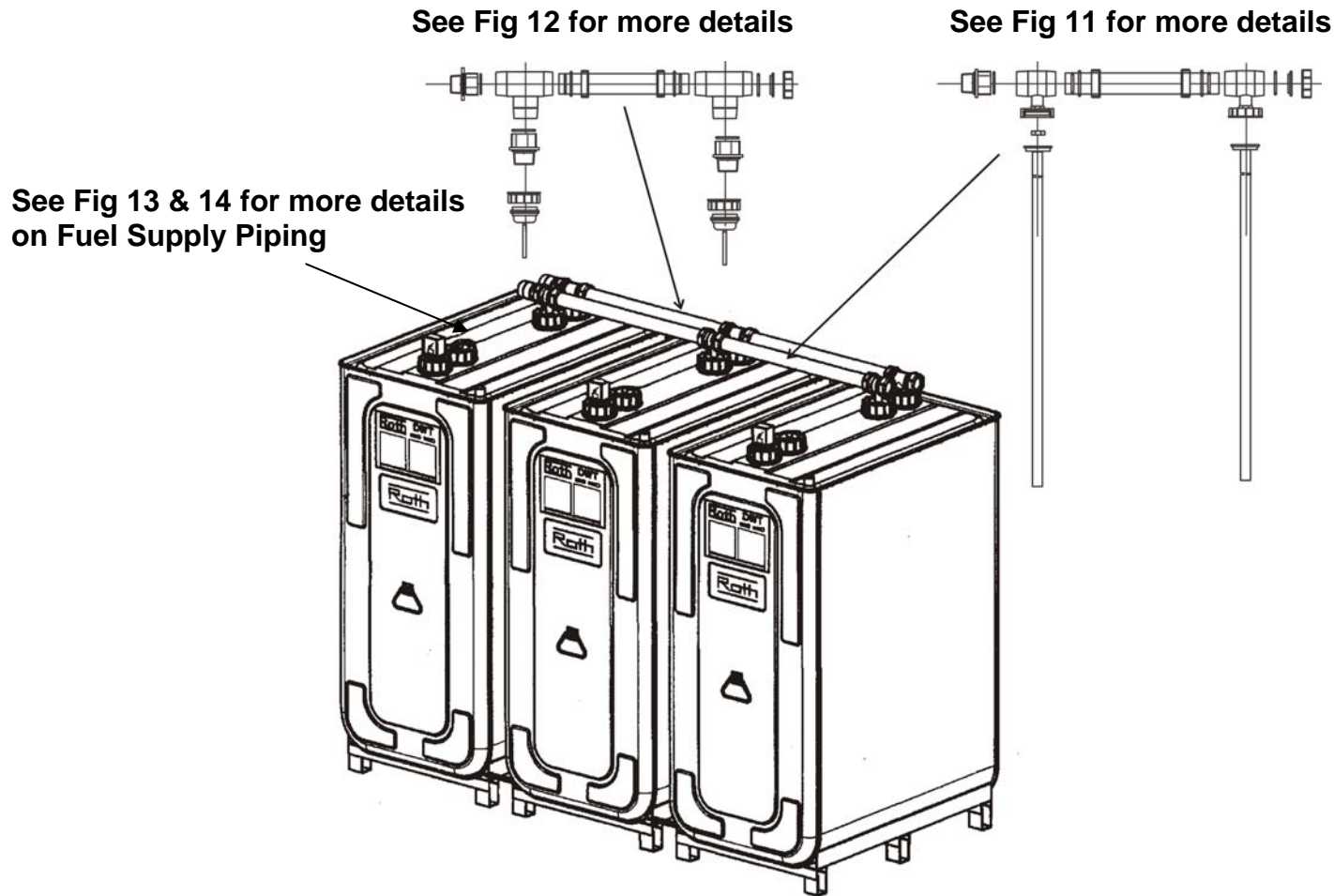

***All multiple tanks must be the size and at the same height.
All tanks must be level and plumb for proper function.
All tanks using the Roth Expansion Kits must be filled at
40-85 gpm (150-325 lpm) at no more than 85 psi (586 kPa).***

Fig 10

The fill piping for the Roth Expansion Kits (side by side configuration) #1, #2, #4 and #5 are installed according to Fig 11 (see below).

Multiple Tank Installation - Fill Pipe

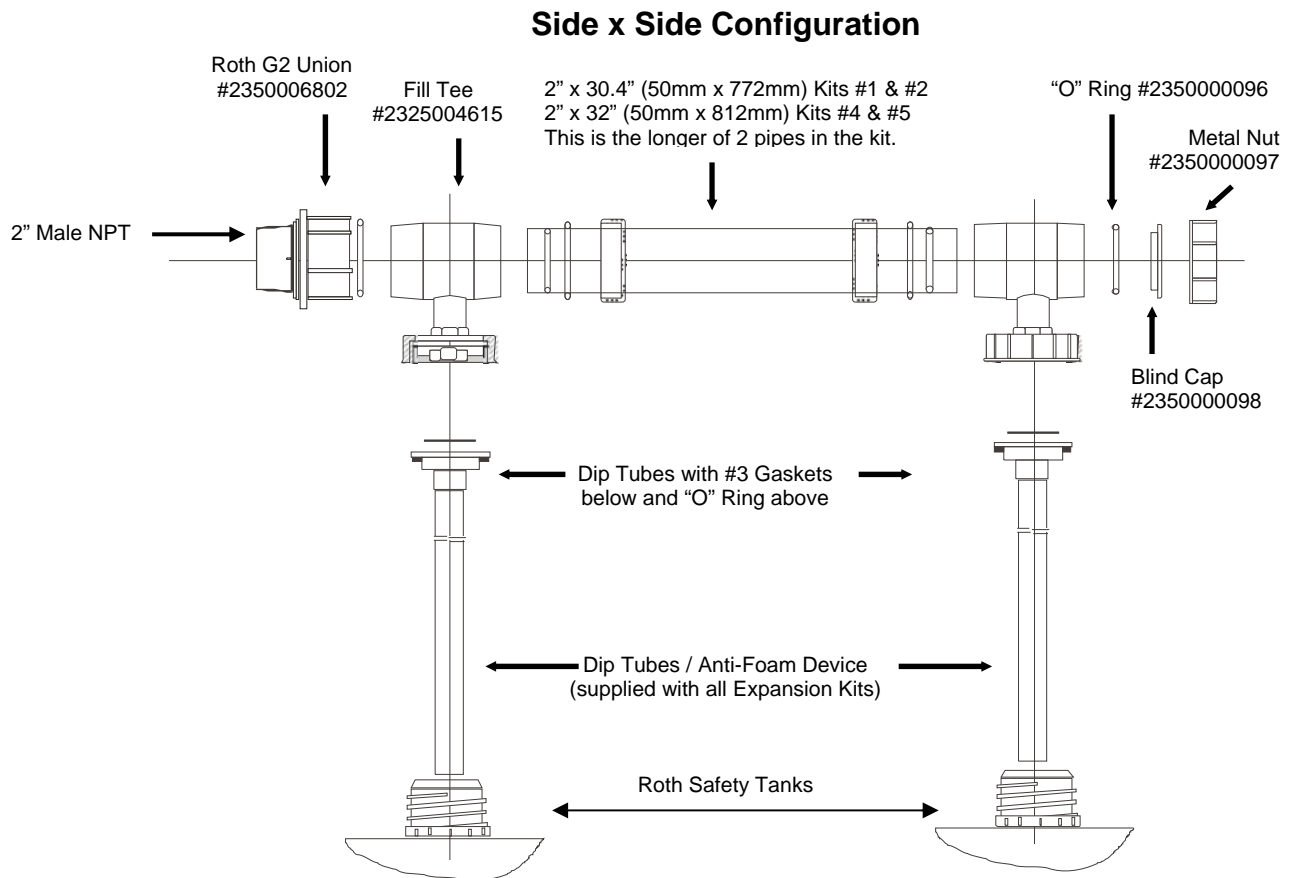

Fig 11

WARNING: TANKS MUST BE FILLED BY A TRUCK AT A RATE NO LOWER THE 40 GPM.

if you are using separate fill pipes for each tank they are piped in the same manner as a single tank installation.

Vent Piping

Each tank in a multiple tank installation must have a separate Vent Alarm (#235000999) or an equivalent sized UL[®] listed vent whistle/device to detect the proper fill level of each tank. The Roth Vent Alarm has a built-in 2" NPT female adapter. You must use the G2 union included with the Expansion Kits to connect the Vent Alarm to the Vent Tee. *Do not connect the Vent Tee directly to the Vent Alarm.* This combination will not seal correctly and will result in nuisance oil odors or possible leaks. Most areas will allow a common vent pipe for multiple tanks even if they require separate fill pipes. Be sure to check your local codes to verify. The Roth Expansion Kit vent piping for side by side tanks is installed as shown in Fig 12 below.

Multiple Tank Installation - Vent Pipe

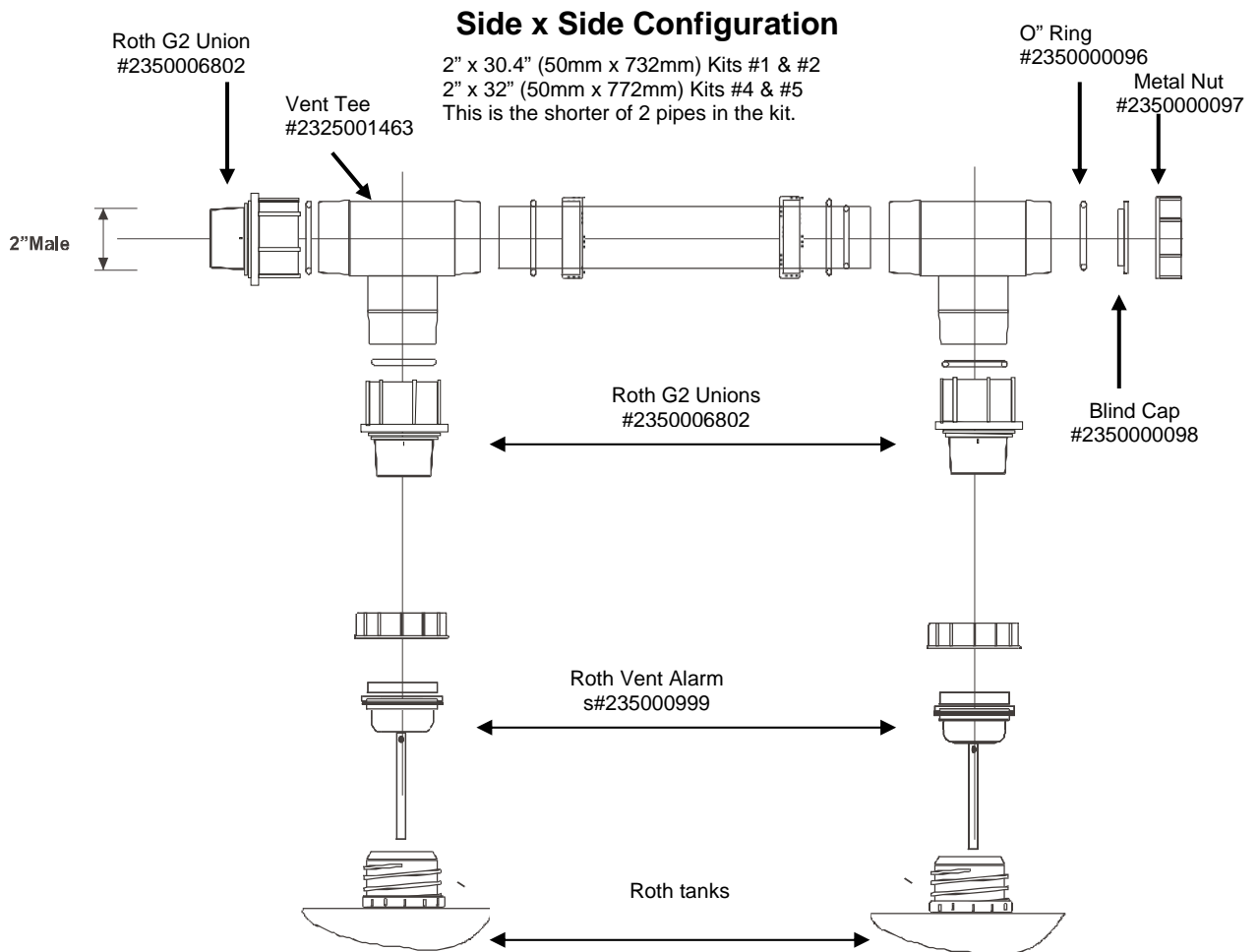

Fig 12

Fuel Supply Piping

“Hard pipe” the fuel supply lines using tank bushings and copper tubing.

“Hard Pipe” Fuel Supply Piping

“Hard Piping” the fuel supply line(s) is allowed in all applications and configurations of any size Roth EcoDWT plus 3. Fuel supply piping is field fabricated using standard duplex/simplex 2” tank bushings with copper tubing (sized for the application) in an “Equal Manifold” configuration. This method applies to a 1-pipe or 2-pipe fuel system.

The tanks return piping, if used, must also be an “equal manifold” configuration the same as the supply. It is important to make the manifold parts as close to equal as possible to ensure equal draw from all tanks (1-pipe systems) and equal return to all tanks (2-pipe systems). When connecting the fuel supply piping with a duplex bushing and copper tubing and using the Roth Expansion Kits, use the Roth Duplex Bushing (# 2350000026 with 3/8” fitting or # 2350000027 with 1/2” fitting). The Metal 2” NPT Adapter (#2350006801) included with each tank is not needed to connect the fill pipe because the fill tee included with the kit connects directly to the tank. Fig 13 shows the basic assembly of the tank bushing and fuel supply piping with two tanks and the manifold construction with up to five tanks.

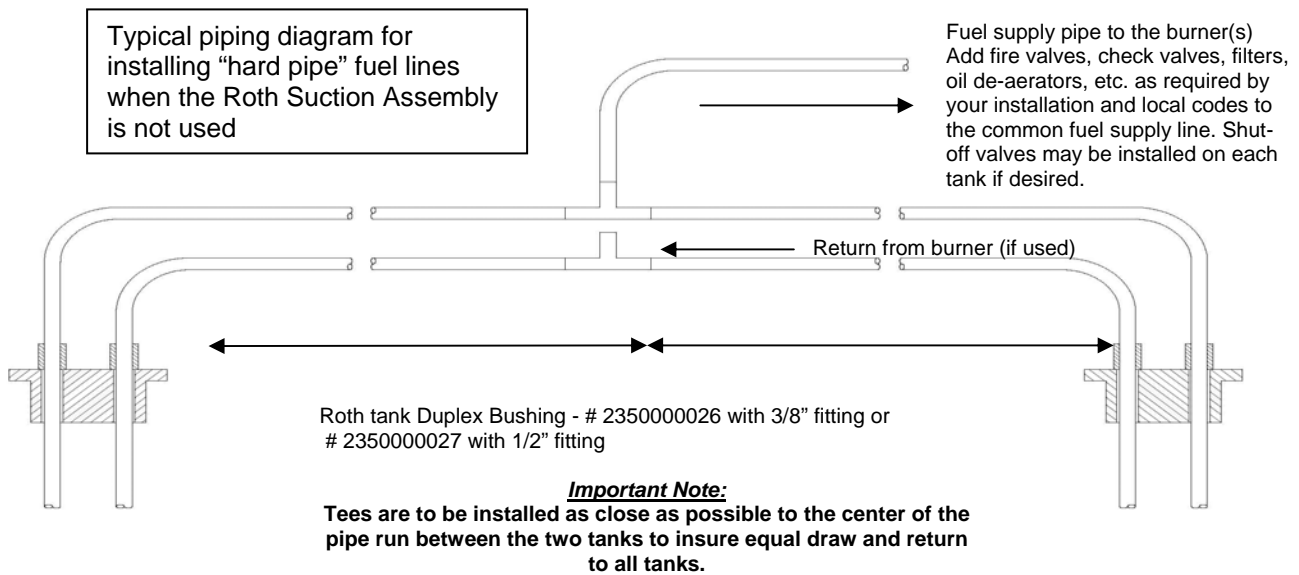
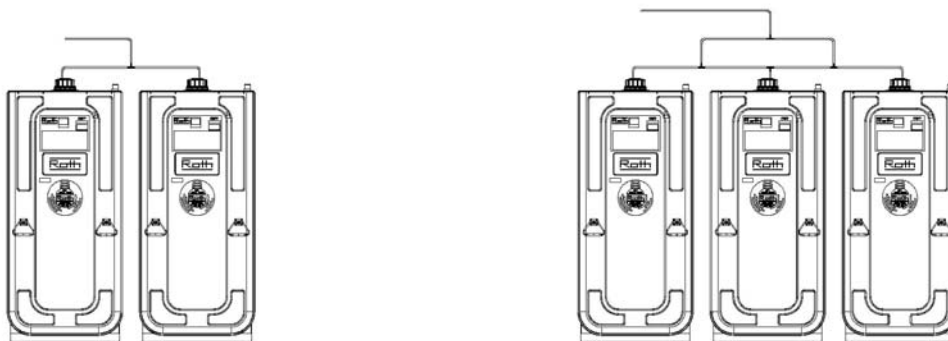

Fig 13



The maximum lift available from the bottom of the tank to the highest point of the piping is determined by the performance of the burner fuel pump. Please refer to the pump manufacturer's instructions for maximum available lift. *In most cases a 1-pipe system has 8' (2.4m) max lift regardless of whether there is single stage or two-stage fuel pump.*

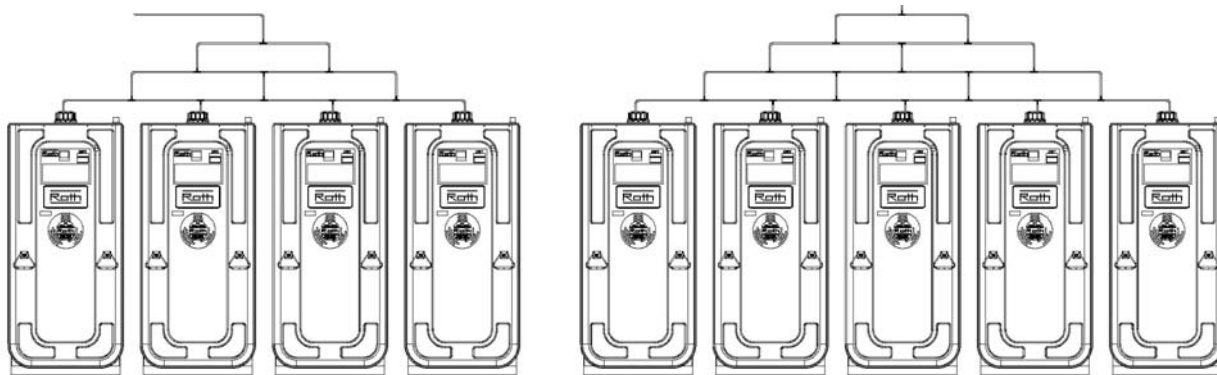
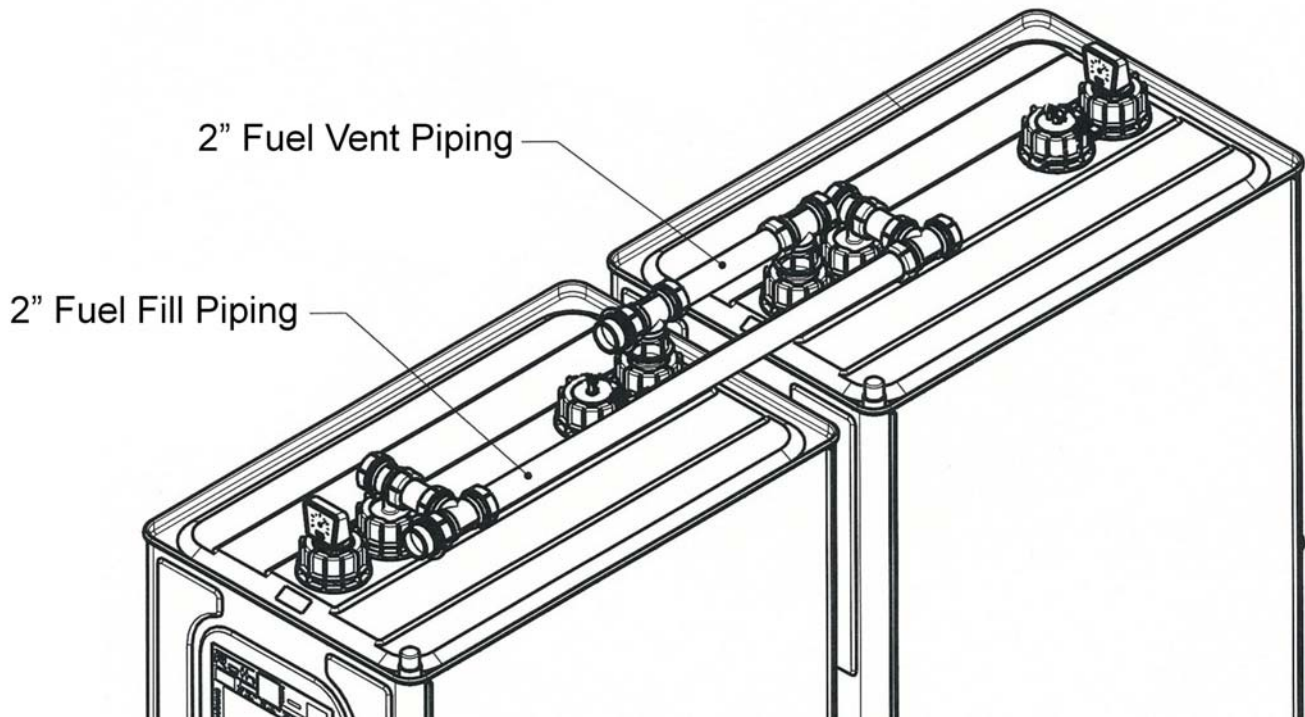

Fig 14

End to End Installations

Roth offers an Expansion Kit #3 (#2315105343) for indoor installation of two (2) 1000L tanks. End to end kits are not available for any other model tank or for more than two (2) 1000L tanks. Installation is similar to the side by side kits. The following illustrations show the assembly of this kit.

End to End Multiple Tank Installation



Note: All multiple tank installations using the Roth Expansion Kits must be filled at a rate of 40-85 gpm (150-325 lpm) at no more than 85 psi (586 kPa) with a tight fitting connection between the truck nozzle and fill fitting!

Fig 15

All conditions for multiple tank side-by-side installations must be observed for end to end multiple tanks installations. These include the requirement for a Vent Alarm for each tank, the use of the 2" NPT Transition Adapter between any NPT connection and the compression connection at the vent and fill tees, following the piping instructions for field assembled "hard pipe" fuel supply lines, etc.

Outdoor Installations of Multiple Tanks

The Roth Expansion Kits cannot be used with outdoor tank installations. The tanks are to be installed in the same manner as single tank outdoor installations. Each tank requires a separate fill pipe, vent pipe and Roth Vent Alarm (#2350000999) or equivalent sized UL[®] listed vent whistle for accurate indication of the fill level.

All outdoor tank installations require the use of the Roth Tank Cover for each tank (purchased separately). Roth Tank Cover #2335100749 fits the 400L & 620L, #2335100757 fits the 1000L, #2335003721 fits the 1000LH and #2335002054 fits the 1500L. The fill pipe, vent pipe and fuel gauge (if used) must be located under the cover. The fuel supply piping must exit the cover at one of the knock-outs and be sealed with a UL[®] listed outdoor rated bushing to provide a water-tight seal. Tanks located in a garage of fully-enclosed shed are not required to use the Tank Cover.

The tanks will need to be hard piped as in Fig 14 with the manifold assembled on the outside of the cover. All conditions listed for multiple tank indoor installations using hard pipe fuel supply lines also apply to outdoor installations.

If you have any questions regarding any installation please contact the Roth office for your area at the numbers listed on the cover of these instructions.

6. Final Completion

Upon completion of any installation the tank installer shall verify that all conditions of the project are in compliance with these instructions and any local code requirements. The installer shall then complete one of the Warranty Certificates for each installed tank and leave this copy with the owner. Contact information for the installer is to be included on this form. The second copy of the Warranty Certificate is to be completed with date and location of the tank installation, customer contact information, name & address of the installing contractor and installer's signature. Where local authorities are requiring it (perhaps in the Province of Quebec) a copy of the Installation Check List is to be complete and signed. The installer's signature is verification that the installation conforms to all Roth instructions and meets the requirements of local codes. Both forms, one Warranty Certificate and one Installation Check List are then to be returned to the Roth office in your area for warranty registration. Upon receipt of the completed Warranty Certificate Roth will enter this information into its records for future reference. *This information is for warranty purposes only and will not be shared with any other company for reasons other than warranty maintenance.*

**Roth Industries, Inc. ("Roth")
Limited Warranty Certificate
ROTH DOUBLE WALL TANK (DWT)**

Serial Number: _____

Warranty:

The Roth Double Wall Tank ("Roth Eco DWT plus 3" or "Product") is constructed with an inner tank, which is the primary oil storage tank and an outer containment tank, which is the secondary containment basin. The inner tank is made of corrosion proof polyethylene. The outer containment tank is made of corrosion resistant galvanized steel.

Provided that:

the Roth Eco DWT plus 3 is installed in accordance with the applicable installation instructions and specifications by a Roth Certified Installer, and

the Roth Eco DWT plus 3 is used for its intended purpose, in particular operated with adequate and approved storage mediums and in strict accordance with the Roth Eco DWT plus 3 manuals, instructions and specifications furnished by Roth,

ROTH WARRANTS THE PRODUCT AGAINST DEFECTS IN MATERIALS AND WORKMANSHIP FOR A PERIOD OF FIFTEEN (15) YEARS FROM THE DATE OF INSTALLATION OR DATE OF MANUFACTURE IF WARRANTY CERTIFICATE IS NOT REGISTERED PROPERLY, SET FORTH BELOW ("Warranty Period"), SUBJECT TO ORDINARY WEAR AND TEAR AND NORMAL USE FROM THE DATE OF MANUFACTURE, AND SUBJECT TO THE TERMS OF THIS LIMITED WARRANTY.

Provided, it is expressly acknowledged that Roth shall have no liability or responsibility for repairs or replacement of the Product arising from any failures of the fill-, vent- and/or collection-system (including the seals) connected with the Roth Eco DWT plus 3.

Purchaser's exclusive remedies, and Roth's sole and exclusive obligations, arising from, as a result of or in connection with this Limited Warranty or the Product shall be limited to the following:

1. Commencing on the date of manufacture of the Product set forth below through year ten (10) of the Warranty Period, Roth shall (i) at its discretion, either repair the Product or provide a replacement product (or 100% credit towards the purchase price of a replacement product) of similar size, design and quality, and (ii) pay all labor costs associated with such repair and/or replacement, all of which shall be at Roth's expense. Purchaser shall be responsible for payment of the costs of shipping, freight and insurance on any replacement product, all of which shall be at Purchaser's expense. In addition, during this ten (10) year period ONLY, in the event that all conditions contained in this Limited Warranty are otherwise satisfied, Roth shall also reimburse Purchaser, up to a maximum amount of US \$1 million, for the costs and expenses incurred by Purchaser for damage to Purchaser's property directly and proximately caused by a leakage of oil from a defective Product.

2. During years eleven (11) through year fifteen (15) of the Warranty Period, Roth shall, at its discretion, either repair the Product or provide a replacement product (or 100% credit towards the purchase price of a replacement product) of similar size, design and quality. Purchaser shall be responsible for payment of all labor costs associated with such repair and/or replacement, as well as the costs of shipping, freight and insurance on any replacement product, all of which shall be at Purchaser's expense.

EXCEPT AS SPECIFICALLY SET FORTH IN THIS LIMITED WARRANTY, ROTH HEREBY EXPRESSLY DISCLAIMS ANY AND ALL WARRANTIES, EXPRESS, IMPLIED AND STATUTORY, WITH RESPECT TO THE PRODUCT, INCLUDING WITHOUT LIMITATION, ANY IMPLIED WARRANTIES OF MERCHANTABILITY OR FITNESS FOR A PARTICULAR PURPOSE.

The obligations of Roth under this Limited Warranty shall not apply in the event that the Product (i) has been installed or repaired by anyone other than Roth or an authorized Roth installer, representative or dealer; (ii) has been altered in any manner whatsoever; (iii) has been subject to misuse, neglect, abuse, improper storage, alteration, improper or insufficient maintenance, unauthorized repairs, an accident or accidents, fire, flood, other casualty or acts of God, (iv) has had its serial number altered, effaced or removed; or (v) has been assembled other than in accordance with the Product instructions and specifications furnished by Roth.

This Limited Warranty is subject to the following additional conditions:

The warranty period begins at the date of installation of the Product as recorded on the warranty card and submitted to Roth after installation. If the warranty card is not submitted, the warranty period begins at the date of manufacture of the Product. **THIS LIMITED WARRANTY SHALL BE VOID IF THE PRODUCT IS NOT INSTALLED WITHIN TWELVE (12) MONTHS AFTER THE DATE OF SALE BY THE PURCHASER TO THE INSTALLER.**

The installation, assembly and use of component parts in connection with the Product from sources other than Roth or its authorized installers, representatives or dealers shall void the obligations of Roth under this Limited Warranty. Roth expressly disclaims any liability arising out of any combination of the Product with the products of third-parties.

Purchaser must notify Roth in writing at the address below of the defect in materials or workmanship within ten (10) days after the defective materials or workmanship are discovered or reasonably should have been discovered ("Purchaser's Notice").

At the same time as the Purchaser's Notice, Purchaser must also submit proof of purchase in the form of a receipted invoice for the Product as proof that the Product is within the Warranty Period.

At the same time as the Purchaser's Notice, Purchaser must also submit to Roth a valid Limited Warranty Certificate with all information completed below.

THE FAILURE TO TIMELY SUBMIT THE PURCHASER'S NOTICE, RECEIPT AND COMPLETED LIMITED WARRANTY CERTIFICATE WILL VOID THIS LIMITED WARRANTY.

Limitation of Liability

Roth's sole and exclusive liability for any claim arising from, as a result of or in connection with this Limited Warranty or the Product shall be limited to the exclusive terms of this Limited Warranty, whether such claim is based on breach of warranty, tort, negligence, strict liability, product liability or otherwise. **Roth shall in no event be liable for any incidental, special, consequential or punitive damages arising from, as a result of or in connection with this Limited Warranty or the Product, whether or not foreseeable, and even if Roth has been advised of the possibility of such damages.**

No cause of action, regardless of form, arising from or in any manner connected with this Limited Warranty or the Product may be brought against Roth more than one (1) year after the date such cause of action accrued.

This is a Limited Warranty which gives you specific legal rights, and you may have other rights which vary from state to state. This Limited Warranty is valid only in the United States. This Limited Warranty is governed by the laws of the State of Delaware.

In the event of an alleged defect in the Product, please call customer assistance at 888-266-7684 to obtain a Service Order Number, and to arrange for an inspection of the Product by Roth or its authorized installer, representative or dealer.

The following information must be completed as the time of purchase and installation.

Product Serial #: _____

Purchaser Name: _____

Purchaser Signature: _____

Vendor Name: _____

Date of Manufacture: _____

Date of Purchase: _____

Date of Installation: _____

Name, Address and Telephone Number of Installation: _____

Roth Eco DWT plus 3 Certified Installer: _____

Warranty Mailing Address:

Roth Industries, Inc.
268 Bellevue Avenue South
Watertown, NY 13601
Ph: 888-266-7684
Attn: Warranty Claims Dept.

8. Notes

Roth EcoDWT plus 3 Installation Check List

DETAILS	Customer Name :	
	Address :	
	Date of installation : (dd / mm / yy)	Tank Serial No :
	<div style="display: flex; justify-content: space-between;"> _____ (Name of Installer in block letters) _____ (Signature) </div>	

- Tank installed on a level, rigid, stable and noncombustible foundation, with proper loading capacity to support weight of tank full and complying with the local codes requirement.
- Tank is secure with one or more Roth Tie Down Kits because of potential flooding or earthquake.
- A minimum clearance of 2" from all walls, or obstructions and tank was inspected for normal tank expansion.
- Top of the tank is totally free of any storage and was not submitted to any heavy weight during installation.
- Tank had no un-acceptable damage that could affect the integrity of the internal tank or the external collecting dike. See supplemental instructions in the Installation Instructions Manual at page 4.
- The leak detector and the gasket are properly in place.
- The Roth Vent Alarm is properly installed and is functional.
- The fill pipe is a brand new 2" black iron pipe or is the existing one but clear of any obstruction.
- The fill pipe opening terminates outside the building with a vapor- and liquid-tight cover.
- The vent pipe is a brand new 2" black iron pipe or is the existing one but clear of any obstruction.
- End of vent pipe terminate outside building with a vent cap having a free open area at least equal to the cross-sectional open area of vent pipe and equipped with a screen preventing ingress of insect.
- Vent and fill pipe are properly supported independently from tank and are not exerting any pressure or undue weight on tank or any of his connections.
- Only Roth's accessories, like: metal adaptors, vent alarm and oil level gauge, have been used.
- All tank's connections and gaskets are well aligned and are leak proof.
- Every large black plastic cap nut on tank's connections has been tightened with the Roth's plastic Wrench at 18 ft-pd of torque and no Pipe Wrench was used.
- Pipe sealants or Teflon tape was not used on any of the threaded plastic connections, like the Roth Oil Level gauge, which was only hand tight.
- Oil supply and return was done using the Roth Duplex bushing.
- Both copies of the warranty certificates were completed, one of them was left with customer, second one was returned to manufacturer along with a copy of this checklist.
- All large black plastic cap nuts were installed on tank's connections at last after having assembled all fill and vent pipes.
- Tightness and solidity of the installation was tested with a pressure test of 0.5 psi was inspected thoroughly during the first complete filling.

Outside Installation

Beside all above-mentioned points, the proper Roth Approved Tank Cover was used. The end of fill pipe, vent pipes and fuel level gauge are located inside the cover. The fuel supply line (and return line, if used) exits the cover through one of the knockouts provided in the cover. A UL[®] approved outdoor rated bushing ensures a liquid-tight seal around the pipes.