

CLICK ANYWHERE on THIS PAGE to RETURN TO WELL CLEARANCE DISTANCES & WELL INFORMATION at [InspectApedia.com](http://InspectApedia.com)



# Protecting Your Private Well

Colorado  
State  
University

Extension

Bulletin #XCM-179



# Protecting Your Private Well

XCM-179

Principle Authors:

Reagan M. Waskom  
Director, Colorado Water Institute  
Colorado State University

Troy A. Bauder  
Extension Water Quality Specialist  
Colorado State University



Special Acknowledgements  
to the following reviewers:

Rob Wawrzynski  
Colorado Department of Agriculture

Dick Wolfe  
Colorado Division of Water Resources

Layout and Design by:

Debbie Fields



Colorado State University, U.S. Department of Agriculture, and Colorado counties cooperating. Extension programs are available to all without discrimination. The information given herein is supplied with the understanding that no discrimination is intended and no endorsement by Colorado State University Extension is implied.

6/2009

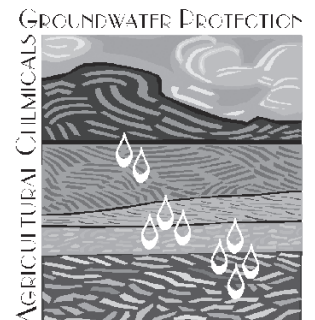



Groundwater is an important resource in Colorado, supplying approximately 18 percent of the total water used in the state. Nineteen of Colorado's 64 counties rely solely on groundwater for drinking water and domestic uses, and private wells are the primary source of water for many Colorado families, farms and ranches. Protecting these private water supplies is essential to the welfare of those who depend upon groundwater; good quality water is an invaluable resource.

Since wells are directly linked to groundwater, they can become contaminated if agricultural chemicals, runoff from animal enclosures, fuels, household wastes or other contaminants accidentally enter them. Because of this, all rural residents should view their well as a vital asset that needs to be protected.

This publication is intended to help you understand more about your water system and help you evaluate activities around the home, farm, or ranch that may contaminate wells and groundwater. If you own a private well, it is

your responsibility to ensure the water is safe for your family and animals to drink.

## Groundwater Resources in Colorado

Aquifers are underground layers of porous and permeable sediment or fractured rock. Water naturally collects in the small spaces within these porous layers and moves slowly through interconnected pore spaces. Groundwater can also accumulate and move through interconnected fractures found in some rocks like granite. The water in aquifers is replenished through a process called recharge. Surface water from rain, snowmelt and even irrigation water all soak into the ground and slowly accumulate to saturate pore spaces.

Shallow river valley aquifers can be recharged quickly, but it may take many years for recharge water to reach deep bedrock aquifers. Sand and gravel aquifers can hold significant amounts of water because pore spaces are large and well connected. Sandstone has smaller pores that are less connected, so it often yields

### Sand and gravel (alluvial)

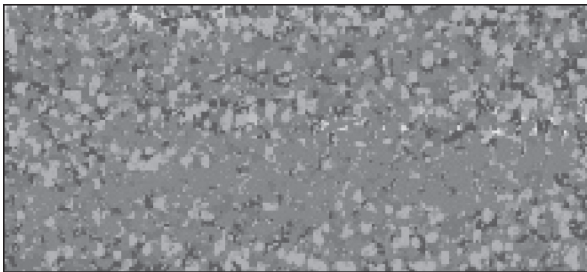

### Sandstone

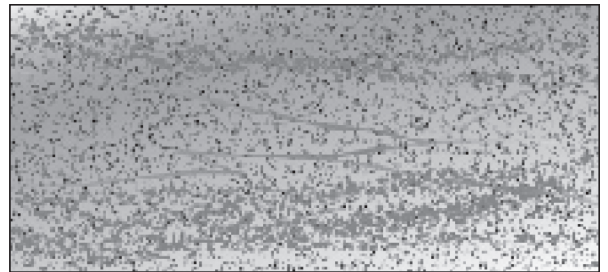

### Shale



### Crystalline rock



**Figure 1. Example aquifer types.**

(Source: "How Well do you Know Your Water Well?" M. Matheson and J. Bowden, CDS Environmental Services)

less water. (See Figure 1 for Sand and gravel and Sandstone formations.) Shale has very small, interconnected pores and normally yields very little water. Crystalline rock has no pores and water must be drawn from interconnected fractures that naturally occur within the rock. (See Figure 1 for Shale and Crystalline rock aquifer formations.)

Colorado’s geology is complex due to repeated mountain-building episodes that have divided the state into mountain ranges of fractured crystalline rock, deep basins, and relatively flat areas of sedimentary deposits. Vast quantities of groundwater occur in deep basins such as the Denver Basin, the San Luis Valley, and in the High Plains Ogallala Aquifer. The alluvial aquifers in major river valleys also yield large quantities of groundwater. However, much of the state has limited groundwater resources due to fractured crystalline rock or massive clay and shale deposits that yield limited quantities of water.

## Groundwater Quality and Potential Contaminants

Groundwater quality varies significantly across the state due to climatological conditions, topography, geology, and human induced contamination. As water drains from the upper watersheds of the mountains into the valleys and basins, water quality begins to degrade as it comes into contact with naturally occurring soluble minerals and as the water is used and reused. Groundwater quality has also been impacted in areas of the state by mining, agriculture, industry, and urban growth.

While new private wells must be permitted by the Colorado Division of Water Resources, the quality of water used by private well owners is not regulated. As a result, many well owners have never had their water tested to determine its quality or suitability for drinking. Colorado has groundwater standards for contaminants such as nitrate, but the State does not exercise

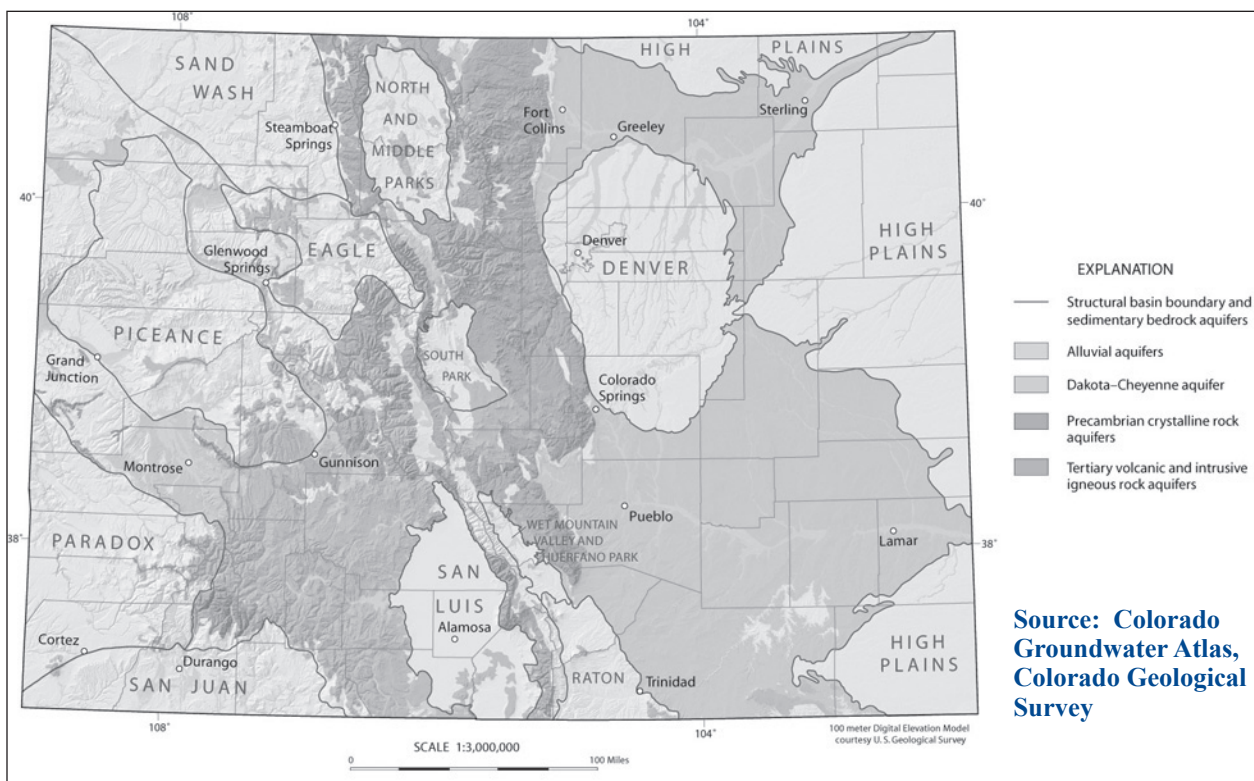

Source: Colorado Groundwater Atlas, Colorado Geological Survey

Figure 2. Principle aquifers and basins of Colorado.



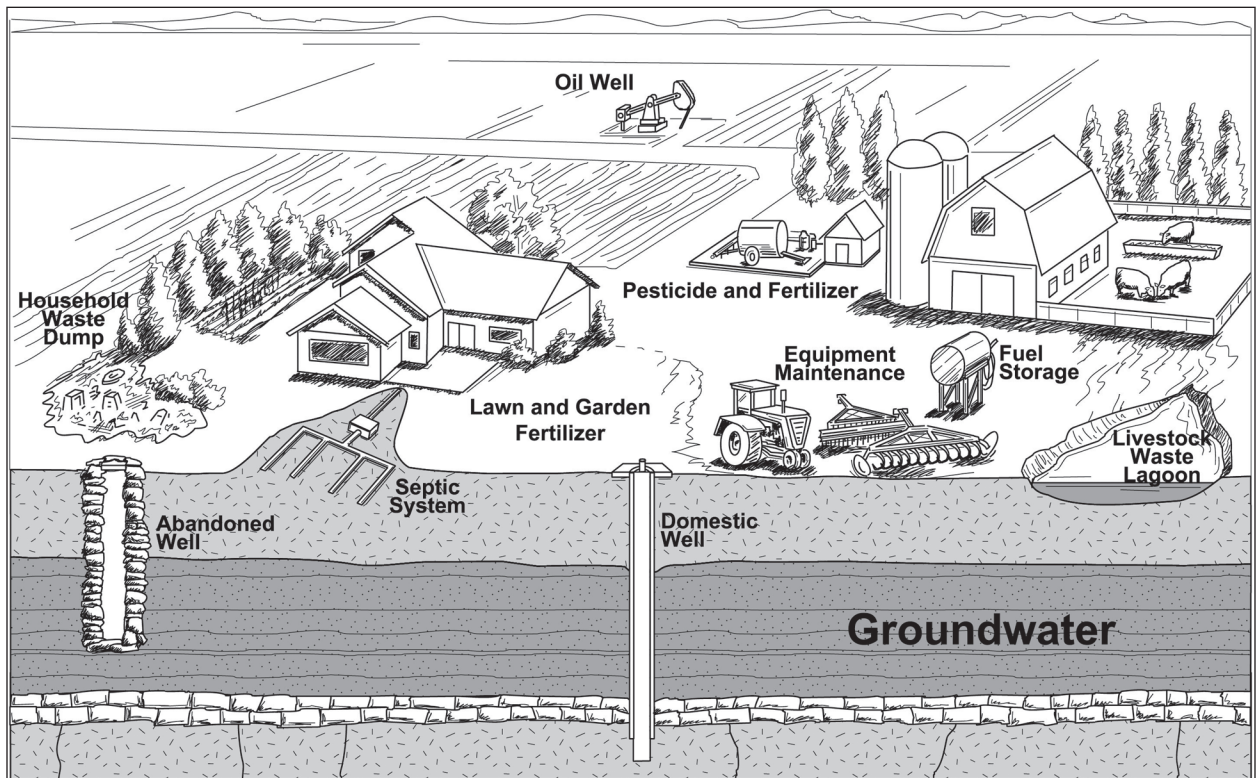

**Figure 3. The typical rural well must be protected against a variety of potential sources of contamination.**

jurisdiction over the quality of the water consumed from private domestic wells. This puts the responsibility for protecting private wells squarely on the well owner.

septic systems are the most common human source of well-water contamination, but chemicals, fuels, and animal wastes are also important concerns.

The typical rural home often has a number of potential sources of groundwater contamination in close proximity to the wellhead. Faulty

While many farms and rural homes have similar features, well water quality can vary greatly due to the inherent variability and vulnerabil-

### **Potential Sources of Private Well Contamination**

- Septic systems
- Improper waste disposal - paints, lubricants, dead animals, cleaning products, etc.
- Pesticide and fertilizer storage, mixing and loading
- Livestock pens, corrals, manure stockpiles and lagoons
- Leaky silos or underground silage pits
- Lawn and garden chemicals
- Abandoned or poorly sealed wells
- Old waste dumps
- Underground storage tanks
- Equipment and vehicle cleanup and maintenance
- Fuel storage

ity of groundwater at certain locations. Older wells in shallow aquifers are more likely to be contaminated. The soil and geologic material that overlies the aquifer greatly influences the relationship between surface activities and groundwater quality. Deeper wells often pass through more restrictive or impermeable layers that decrease the rate at which surface water reaches the aquifer. Well owners should talk to the driller who installed their well about the hydrogeology of their site and ask for a copy of the well log (a record of well construction and geologic formations encountered). While all wells need protection, it is especially important to observe good management in the vicinity of a shallow or vulnerable well.

## Installing a New Well

In the early stage of planning a new or replacement water well, there are several important steps to consider. These include selecting a licensed drilling and pump contractor, selecting a well location that avoids contamination hazards, and obtaining a well permit. The Colorado Division of Water Resources (DWR) requires that every new or replacement well be permitted before it is drilled, and that water wells must be drilled and constructed pursuant to Colorado Water Well Construction Rules (2 CCR 402-2). In general, the well permit application asks for ownership and proposed well location information, proposed construction details, water use and septic system information and the well driller's license number. Well permit applications can be obtained on the internet at: <http://water.state.co.us/>.

The DWR has several different types of well permits that can be issued. DWR form GWS-44 is the application used for most residential and livestock water wells. Based on certain local criteria, the DWR may limit water to indoor use for parcels of less than 35 acres,

and to include outdoor use of no more than one irrigated acre for parcels larger than 35 acres. In water-critical areas (where water demand exceeds available water supplies) the DWR may deny a new well permit altogether unless a landowner obtains appropriate replacement or augmentation water. People interested in purchasing undeveloped land can contact DWR before purchasing the property to determine the potential availability of a well permit for that particular parcel.

As part of the well-drilling process, the driller must record certain data that will be reported to DWR. This includes the well log, an as-built well construction record, and well yield test. The driller must provide you with a copy of the report that is submitted to DWR. Keep these records in a safe place. You will need to refer to these documents in the future when performing well maintenance or while evaluating well problems. If you have an existing well with no records, DWR may be able to provide you with copies of the reports that were submitted by the driller when the well was drilled.

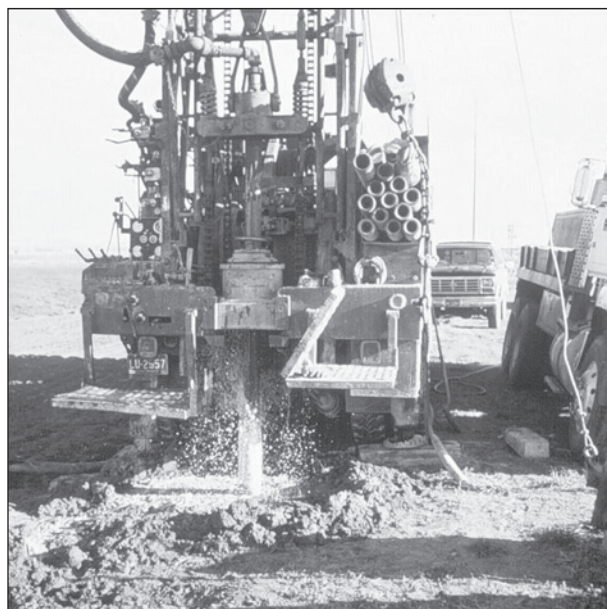

**Drilling a well requires a permit from the Colorado Division of Water Resources.**



## Well Location and Setbacks

Before installing a new well or evaluating management practices around your property, it is important to scrutinize the location of the well in relation to potential sources of contamination. Contaminants will enter groundwater by either leaching through the soil or by direct flow down the well bore. In most cases where private wells have been seriously contaminated, the groundwater has been reached directly due to spills at the wellhead, back siphoning, poor well construction and maintenance, or improper storage of hazardous products. Direct groundwater contamination can also occur through old or improperly abandoned wells, including irrigation and oil wells.

Wells must be properly located to ensure a clean water supply. Unless otherwise protected, locate the well on the highest ground practical, uphill from septic systems, corrals, fuel tanks, and chemical storage and mixing sites. In some cases, changing well location is more

cost effective than moving existing hazards. If you are installing a new well, especially in a shallow alluvial aquifer, determine the groundwater flow path and make sure there are no hidden hazards up gradient, such as old-dump sites or underground storage tanks. Be aware that wells create a cone of depression in the water table that can draw down-gradient water. Additionally, if the aquifer supplying water to your well is deep, the groundwater may flow in a direction different than the surface gradient, possibly creating additional sources of contamination from other locations. Finally, make sure that the well casing extends above the flood level of any nearby surface water.

State regulations encourage good well location by requiring a minimum separation distance of 100 horizontal feet between newly constructed wells and any source of contamination. For septic tanks, sewer lines, and other excreta infrastructure, 50 feet is the required setback. Some counties have greater setback requirements. Many agricultural practices and struc-

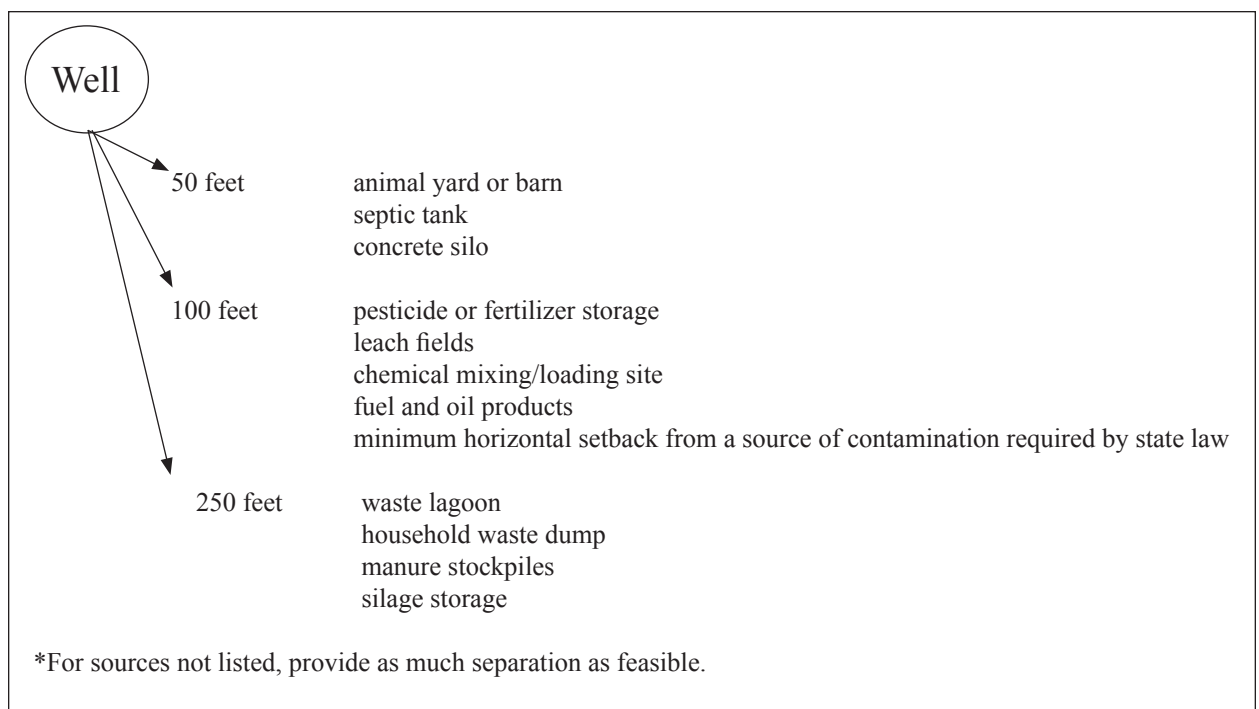

**Figure 4. Suggested minimum separation distances between wells and potential sources of contamination**

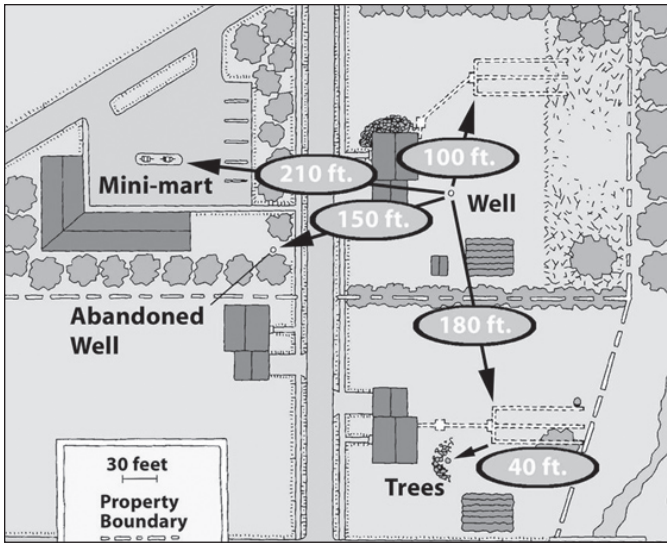

**Wells must be located a safe distance from septic systems and other potential sources of contamination.**

tures are commonly overlooked in establishing setbacks, but this is an important issue when constructing your drinking water well and should not be overlooked.

In theory, safe setback distances will depend upon soil type and the hydrogeology of the site. The difficulty of assessing the vulnerability of groundwater at a specific site has led to the adoption of uniform separation distances. Well owners are encouraged to observe greater setback distances between their wells and potential contamination sources. Keep in mind that the suggested setbacks in Figure 5 are only guidelines. If your site has shallow groundwater or coarse soils, it is in your best interest to protect the well by increasing these setback distances.

## Well Construction and Maintenance

The quality of a well's construction affects its ability to keep out contaminants. New wells should be constructed with no unsealed openings around the well and only durable, high quality materials should be used. Some well problems, such as a cracked casing, are obvi-

ous upon visual inspection; other problems are not so obvious. If you suspect a contamination problem due to well integrity, it is best to have an inspection by a licensed driller or well service technician. Information about the construction of your well is often available from the previous owner or the well driller. Older wells are more likely to have thinner casing, which may be corroded through, or have faulty pumps that can leak lubricating oils. Three types of wells have historically been used in Colorado: drilled wells, sand-point wells, and dug wells. Drilled wells are by far the most common, and if properly constructed, are least prone to contamination problems.

Whether you are inspecting a new well or an existing one, there are four primary features that need to be evaluated: the casing, the grout, the seals, and the graded slope around the base of the well. The steel casing installed during construction is designed to prevent collapse of the borehole and provides the primary defense against contaminants. State regulations specify that steel casing must extend at least 12 inches above the soil surface and 19 feet below. If the area is susceptible to flooding, extend the casing 2 feet above the flood level. Wells that extend through a shallow aquifer to tap a deeper formation should be cased to a level below the shallow aquifer. You can visually inspect casing for holes and cracks at the surface from the outside. Inspect the interior of the casing for cracks by shining a flashlight down the inside. Ask your well driller for a copy of the well log to determine the depth of casing and grout. Your local health department may be able to help you determine if the well meets current safety standards.

The gap between the well casing and the bored hole must be grouted with cement, cement-bentonite mixture, or other acceptable materi-

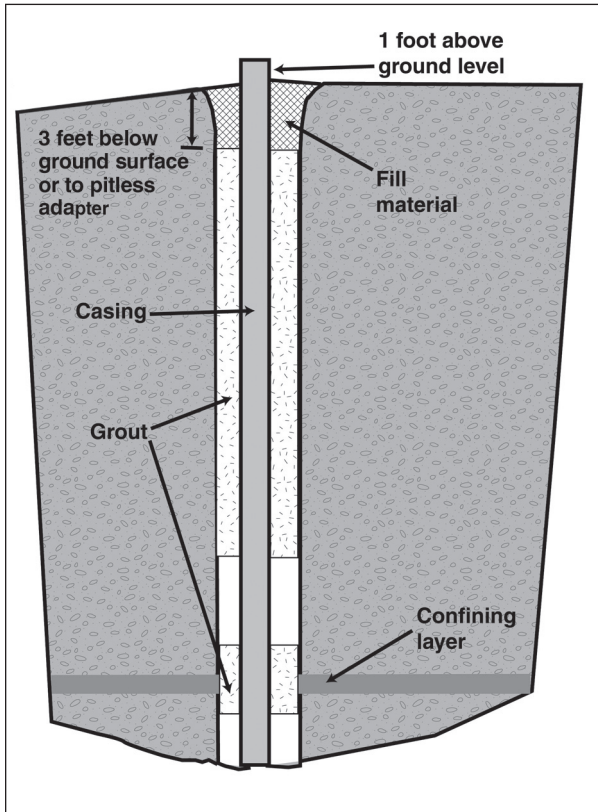

**Cross section of a properly constructed well.**

als according to the well construction rules (2 CCR 402-2) to prevent surface water from directly entering the aquifer. If you can move the well casing around by pushing against it, you may have a problem with the grouting near the surface.

The well should be capped with a tight-fitting well cap to prevent contamination or vermin from entering through the top of the well. The cap on existing wells should be in place and tightly secured. All points where electrical wiring, pipe, or observation equipment enters the well should be tightly

sealed. Be sure to disinfect your well with a 100 ppm bleach solution (1 cup household bleach in 31.2 gallons of water) any time the system is opened for maintenance or repair. See Colorado State University Extension fact-sheet 6.703, *Bacteria in Water Wells* for more information on chlorination.

## Frequently Asked Questions about Well Water Systems

**How do I get a well permit for my property?** Contact the Colorado Division of Water Resources to apply for a permit. Forms are available online at <http://water.state.co.us/>. In most cases, a licensed water well driller will help you fill out and submit the required paperwork. Once the permit is issued and construction reports are filed with the Colorado Division of Water Resources, well permits are good for the life of the well and do not need to be renewed.

**Why does water not come from my well anymore?** There may be several reasons why water is not delivered from a well. First check your breaker box to see if the breaker is tripped. If that is the case, check if there is

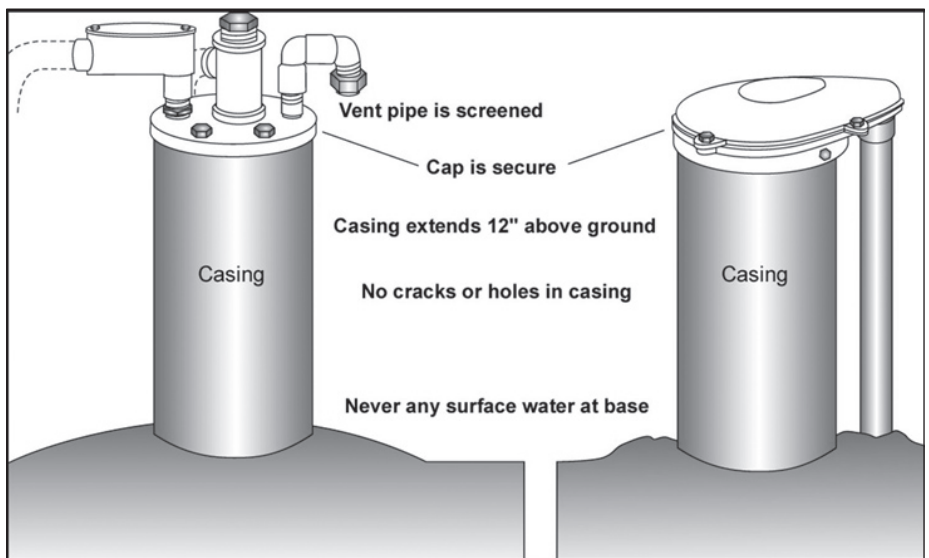

**Figure 5. Properly capped and sealed wells protect water quality.**

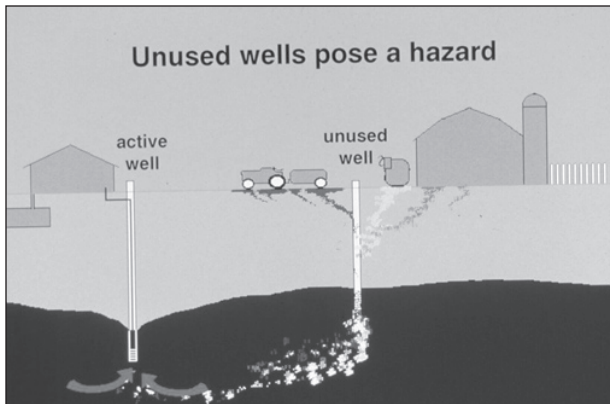

**Unused wells provide an easy contamination pathway.**

a pump reset button on the pump control box near the breaker box. If this does not work, call a licensed pump installer to check the pump and pump control equipment, which may have failed. The pump installer can also check the water level in the well.

**Why does my well seem to pump less water than it used to?** Over time, minerals and/or bacteria can restrict your water system pump or piping. Overuse and/or lack of seasonal recharge of the aquifer can also cause the groundwater level to drop and decrease the amount of water entering the well. A licensed well driller or pump installer can clean your well screen, check your pump, piping and water level. They can also measure the yield of your well and compare it to the yield when the well was originally drilled.

**Why does my pump seem to run every time I turn on the tap?** The pressure in your water system is regulated by a pressure tank so that the pump does not have to run every time there is demand for water. Additionally, the tank has an air bladder in it that can rupture. Have a licensed pump installer check the pressure tank.

## Abandoned Wells

Many older wells are no longer necessary as smaller farms and homestead sites are consolidated into larger farms and as municipal water supplies reach rural areas. Consequently, these unused wells are often neglected or forgotten and present safety hazards as well as groundwater hazards.

Old wells can allow polluted runoff water to flow directly down to the aquifer, bypassing the natural filtering that normally takes place in the soil. Additionally, poor quality groundwater can degrade higher quality groundwater if the two are allowed to mix via an old, poorly constructed well.

Property owners may not even be aware that unused wells exist on their land. This can be dangerous for small children and pets. The most obvious sign of an old well is a pipe sticking out of the ground. An unexplained depression in the ground at an old home site or an old pump house may be an indicator of an unused well. In some cases, landowners can

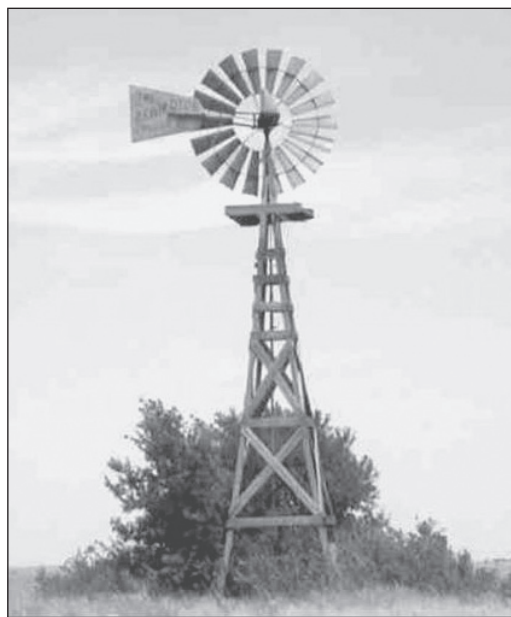

**Windmills often sit over unused, abandoned wells.**



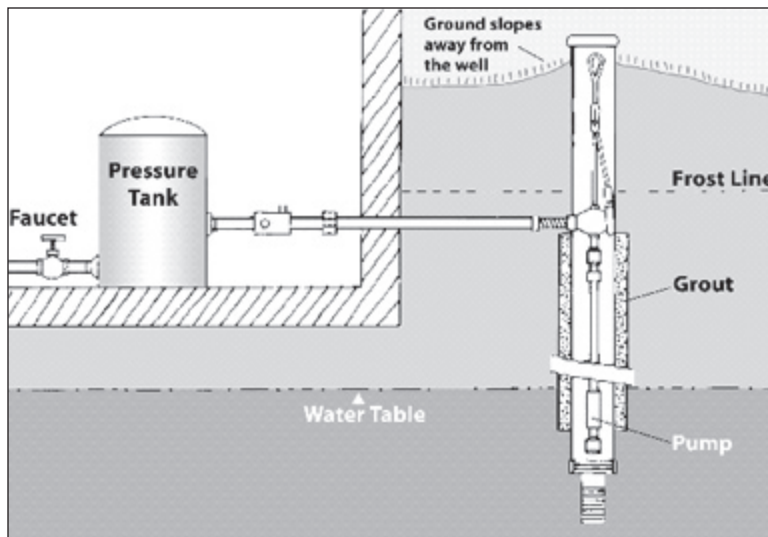

**Figure 6. New wells should not have any unsealed openings around the wellhead. Only durable, high quality materials should be used.**

ascertain the location of unused wells from old photos or records. Windmills are sometimes located over old wells.

The best solution for these unwanted wells is a permanent seal. Proper sealing of a well restores the relationship of the aquifer to the surrounding material that existed before the well was drilled. Achieving this result is not always a simple procedure. Check with the DWR to determine exact specifications for abandonment and sealing of old wells or go to <http://water.state.co.us/> to view the Water Well Construction Rules under Rules and Regulations.

## Water Testing

People who get their water from a public supply have the benefit of strict federal and state regulations governing water quality and testing. If you have a private water system, you are the regulatory agency. It is your responsibility to make sure your family's water is safe. Contaminated water does not always taste, look or smell different from safe drinking water. Laboratory analysis is the only sure method to determine the quality of your water.

If you are buying a new property or if you do not have a copy of a recent water quality report, you need to have your water analyzed by a certified laboratory for bacteria, nitrate, sulfate, chloride, pH, total dissolved solids (TDS), hardness, and conductivity to get baseline information on your well. Tests for pesticides, other organic contaminants, and radon are expensive and not usually recommended unless you have reason to suspect a problem.

Annual water testing for bacteria and nitrate is suggested to help monitor the quality of your private water supply. If you see a decline in quality, more thorough investigation is warranted. These records will be valuable if your water is ever contaminated due to some off-site activity, such as oil and gas drilling in the vicinity of your well.

In addition to routine water quality testing, special circumstances may warrant more detailed analyses.

When you take a water quality sample, be sure to follow your lab's sampling protocol. Many labs provide clean containers with detailed instructions on how to take the sample. If a container is not provided, use a clean glass or plastic container that is rinsed three times with the well water before you collect the actual sample. Be sure to wash your hands prior to sampling and do not touch the inside of the container or lid. It is best to let the water flow for about 5 minutes before sampling and do not draw from a threaded faucet or swing faucet. Keep the sample cool and take it to the lab as soon as possible. If you have to mail the sample to the lab, draw the sample on Monday morning so it can be analyzed the same week.



For best results, water samples should be analyzed within 30 hours of the initial collection.

Keep a record of each water test as a reference for future testing. If you need help interpreting the results of your sample, the lab manager where the sample was analyzed or your county Extension agent can assist you. See Colorado State University Extension factsheet 0.520, *Selecting an Analytical Laboratory* for more information on sampling and laboratories, or use the Water Quality Interpretation Tool to help you evaluate your drinking, livestock, or irrigation water. This is offered at: [www.csuwater.info](http://www.csuwater.info)

## Interpreting Your Water Test Report

Obtaining a water analysis from a reputable testing laboratory is a necessary first step toward understanding your well water quality. The testing laboratory will provide a report that lists the measured concentrations of each

chemical and physical constituent that was analyzed. The concentration is the amount (mass) of a given substance in a specific amount (volume) of water. The most common concentration unit used is milligrams per liter (mg/L), which is equal to one part per million (ppm), or one part measured constituent to one million parts water.



**Correct sampling procedure is essential in obtaining a quality analysis.**

Determining acceptable water quality and understanding the nature of problems resulting from poor water quality are basic considerations in interpreting a household water analysis report. Acceptable limits for evaluating the suitability and safety of your well water are

### **You should consider having your well tested if:**

- *Family members or guests suffer gastrointestinal illness.*  
Test for bacteria, nitrate, and sulfate.
- *You live near a dump, landfill, factory, or cleaning operation.*  
Test for volatile organic compounds (VOCs), TDS, and heavy metals.
- *You live near a mining operation.*  
Test for pH and metals.
- *There is oil and gas drilling activity nearby.*  
Test for chloride, sodium, strontium, and barium.
- *You live near an old underground storage tank.*  
Test for hydrocarbons and VOCs.
- *Someone in your family is expecting a baby or has respiratory disease.*  
Test for nitrate.
- *Your plumbing contains lead pipe, fittings or solder joints.*  
Test for lead.
- *Water leaves a scaly residue or soap scum and decreases cleaning action of detergents.*  
Test for hardness.
- *You have a spill of agricultural chemicals or petroleum products on or near your property.*  
Test for the appropriate chemical.

established for many physical, chemical and biological constituents. Some established standards are set by nuisance considerations (taste, odor, staining, etc.), while many are based on health implications.

The acceptable limits for public water systems should be used as guidelines for your own water supply when evaluating your well water test results.

Whether you have the results of specific tests, or you simply instructed the laboratory to conduct a general or routine household water quality test, you can use the following tables as a

general guideline for the most common household water quality parameters. These are divided into three categories: general indicators, nuisance impurities, and health contaminants. Or you can receive a customized interpretation by using an online Water Quality Interpretation Tool available at [www.csuwater.info](http://www.csuwater.info).

#### General Indicators

These indicators are parameters that provide a basic understanding of the quality of a water source. Testing for general indicators can guide the need for subsequent testing. Generally, if an indicator is excessive, the water supply may

<b>EXAMPLE DOMESTIC WATER ANALYSIS</b>					
<b>“Routine Package”</b>			<b>Metals and Individual Elements Analysis</b>		
	<b>Results</b>	<b>Limit</b>		<b>Results</b>	<b>Limit</b>
Conductivity dS/m	3.58	N/A		mg/L	mg/L
pH	7.3	6.5 to 8.5	Boron	0.26	N/A
	mg/L	mg/L	Phosphorus	0.03	N/A
			Aluminum	<0.01	0.05 to 0.2
Calcium	188	N/A	Iron	0.01	0.3
Magnesium	139.5	N/A	Manganese	<0.01	0.05
Sodium	620	20	Copper	0.02	1.3
Potassium	5.4	N/A	Zinc	0.04	5
Carbonate	<0.1	N/A	Nickel	<0.01	0.1
Bicarbonate	998	N/A	Molybdenum	<0.01	N/A
Chloride	150	250	Cadmium	<0.005	0.005
Sulfate	1230	250	Chromium	<0.01	0.1
Nitrate	118	45	Barium	<0.01	2
Nitrate-Nitrogen	26.6	10	Ammonium	*	N/A
Total Alkalinity			Fluoride	*	4
as CaCO <sub>3</sub>	818	400	Arsenic	<0.001	0.01
Total Hardness			Selenium	*	0.05
as CaCO <sub>3</sub>	1,043	300	Mercury	*	0.002
Total Dissolved Solids	3,476	500	Lead	*	0.015

COMMENTS: Sodium, sulfate, nitrate, alkalinity, hardness and total dissolved solids exceed the EPA suggested limits for domestic use.

contain other contaminants as well, and further testing is recommended. For example, a positive total coliform bacteria test result may be followed by tests for fecal coliform or E. coli bacteria which, if present, would confirm that sewage or animal waste is contaminating the water.

Total dissolved solids (TDS) and pH may vary slightly over time depending on well recharge characteristics. These are inexpensive parameters to track that may indicate the possibility of other problems. The tests listed in Table 1, along with a test for nitrate, provide a good routine analysis (as often as once a year) for most rural water supplies, unless there is a reason to suspect other problems.

Nuisance Impurities

Nuisance impurities are another category of water quality problems. While these have no known adverse health effects at low levels, they often make water unsuitable for many household purposes. Acceptable limits for nuisance impurities come from the EPA Secondary Drinking Water Standards (Table 2).

Hardness is one contaminant you will commonly see on water test reports. Hard water

causes white, scaly deposits on plumbing fixtures and cooking appliances and decreased cleaning action of soaps and detergents. Hardness is the sum of the calcium and magnesium levels found in your water. Hard water can also cause buildup in hot water heaters and reduce their effective lifetime. Hardness may be expressed in either milligrams per liter (mg/L) or sometimes in grains per gallon (gpg). Water supplies falling in the hard to very hard categories may need to be softened (Table 2).

Advantages of softening your water include increased effectiveness of detergents and soaps, increased life of hot water heater elements, and the reduction of scaly deposits on plumbing fixtures, etc. The disadvantages of softening your water include increased levels of sodium in softened water, and increased potential for pipe corrosion. Since the level of sodium can affect your health, consult your health professional about any impacts that softening your water may have on your health.

Health Contaminants

The parameters outlined in Table 4 are some common contaminants that have known health effects. In public water systems, these contaminants are regulated under the EPA Primary

**Table 1. General water quality indicators**

Indicator	Desirable Level	Consequences of Elevated Level
Bacteria	zero	Possible bacterial, protozoan, or viral contamination from human sewage or animal waste.
pH	6.5 to 8.5	An important overall measure of water quality, pH can alter corrosivity and solubility of contaminants. Low pH will cause pitting of pipes and fixtures and or metallic taste. This may indicate that metals are being dissolved. At a high pH, the water will have a slippery feel or soda taste.
Total Dissolved Solids (TDS)	<500 mg/L	Dissolved minerals, like iron or manganese. High TDS also may indicate hardness (scaly deposits) and cause staining, or a salty, bitter taste.

Drinking Water Standards. Except for nitrate and bacteria, tests for these contaminants in private water wells are usually done only when a specific contamination is suspected.

or well seals may have failed. Have a licensed well driller inspect the well and determine the source of the sediment.

## Frequently Asked Questions about Well Water Quality

**Why does my water leave stains on fixtures and clothes?** Your water likely has a high dissolved minerals content. Have the water tested by a laboratory to determine its chemical composition. You can then decide if water treatment equipment is appropriate for your well and water.

**Why is there a lot of sediment in my water?** Your well may have been improperly developed to remove excess drilling fluids and sediment when it was installed. Or, the well casing

**Why does my water smell like sulfur or have sewer-like smell?** Your well probably has bacteria in it. Have the water tested for bacteria immediately and discontinue drinking. The local health department or a licensed pump installer can help disinfect the well and find the source of the bacteria.

**Why does my water smell or taste like chemicals?** Your well may be polluted with chemicals. Stop using the water immediately. Call the local health department to help you find out where the source of the chemical contamination may be and what analysis should be done. Have the water tested by a laboratory for likely chemical pollutants.

**Table 2. Common nuisance impurities in groundwater**

Contaminant	Acceptable Limit	Effects
Chloride (Cl)	250 mg/L	Salty or brackish taste; corrosive; blackens and pits stainless steel
Copper (Cu)	1.0 mg/L	Blue-green stains on plumbing fixtures; bitter, metallic taste
Iron (Fe)	0.3 mg/L	Metallic taste; discolored beverages; yellowish stains on laundry; reddish brown stains on fixtures
Manganese (Mn)	0.05 mg/L	Black specks on fixtures; bitter taste
Sulfate (SO <sub>4</sub> )	250 mg/L	Bitter, medicinal taste; corrosive
Iron Bacteria	----	Orange to brown-colored slime in water

**Table 3. Hardness classifications (concentration of hardness)**

Hardness in milligrams per Liter (mg/L)	Hardness in Grains per Gallon (gpg)	Relative Hardness Level
Below 60	Below 3.5	Soft
60 to 120	3.5 to 7.0	Moderately Hard
120 to 180	7.0 to 10.5	Hard
180 and above	10.5 and above	Very Hard

**Table 4. Standards, sources, and potential health effects of common contaminants regulated in public water supplies.**

<b>Contaminant</b>	<b>Acceptable Limit</b>	<b>Sources</b>	<b>Potential Health Effects at High Concentration</b>
Fecal Coliform Bacteria	0	Human sewage and animal wastes leaking into well or groundwater.	Gastrointestinal distress. Infants, elderly and the sick are especially susceptible.
Fluoride (F)	4.0 mg/L	Fluoride is naturally leached from bedrock in certain areas of CO.	Mottling of teeth and bones. If less than 0.7 mg/L contact your doctor or dentist for recommendations about the need for additional fluoride for small children and the elderly.
Selenium (Se)	0.05 mg/L	Selenium is naturally leached from shale formations in certain areas of CO.	Required for proper health in very low amounts. At higher levels, it's dangerous to humans and animals. Horses are especially susceptible exhibiting hoof damage, hair loss, still born foals, weight loss, and even death with long term exposure. Humans and other animals share many of the same symptoms.
Lead (Pb)	0.015 mg/L	May be leached from faucets, lead pipes and lead soldered joints.	Nervous disorders and mental impairment, especially in fetuses, infants, and young children. Also, kidney damage; blood disorders, hypertension; low birth weights.
Arsenic (As)	0.01 mg/L (as of January 26, 2006)	Arsenic is naturally leached from bedrock in certain parts of CO.	Dangerous to humans and animals. May cause skin damage, circulatory system problems and an increased risk of cancer.
Nitrate-N (NO <sub>3</sub> -N)	10.0 mg/L	By-product of agricultural fertilization; human and animal waste leaching to groundwater.	Blue baby disease in infants (birth - 6 months); low health threat to children and adults, though there is evidence of increased risk of soft tissue cancer.
Radon (Rn)	300-4000 pCi/L (a guideline, depending on indoor concentration)	Naturally-occurring radioactive gas formed from uranium decay, can seep into well water from surrounding rocks and be released in the air as it leaves the faucet.	Breathing gas increases chances of lung cancer; may increase risk of stomach, colon, and bladder cancers.



**Why does my water fizz?** Your well water has gas dissolved in it. This gas may be harmless air or carbon dioxide. It may also be methane. Have the water tested by a laboratory to determine what the gas is and whether or not a treatment system is necessary.

**Where can I get additional information?**

Further assistance with interpretation of your household water quality is available from the testing laboratory, your local health department or environmental professional. If you wish to obtain more information about the occurrence of contaminants and their effects on household water quality, particularly as it pertains to established drinking water standards, call the EPA Safe Drinking Water Hotline at (800) 426-4791. Water quality guidelines for Colorado are also available at [www.csuwater.info](http://www.csuwater.info).

**Management Strategies to Minimize Contamination Risks**

Properly located, constructed, and maintained wells are the first line of defense against contaminants. However, good management around the well is essential to keep your drinking water clean.

Septic Systems

Rural homes with domestic wells will usually have individual wastewater treatment systems.

These systems typically consist of a buried concrete septic tank and an absorption or leach field. A system that is adequately sized and located according to state and county codes and have a suitable soil absorption field will usually provide good service if you maintain the system regularly. Well owners in mountainous terrain should be aware that septic systems located on thin soils over fractured rock are more likely to impact water quality. These systems require regular maintenance and well water should be regularly tested for microbial contamination.

Contaminated wells or a wet, smelly spot in the yard with lush grass growth are both signs of septic system failure. A system failure occurs when the existing system cannot be repaired adequately to bring it back into compliance. In this difficult situation, a property owner will have to install a new system. Unfortunately, many home lots do not have a suitable site to construct a new system and the property owner has limited options. Therefore, it is important to properly maintain your system.

Homeowner maintenance of septic systems will help prevent contamination of groundwater, the spread of disease, and costly system failures. If you have an old septic system that you suspect is not functioning adequately, or

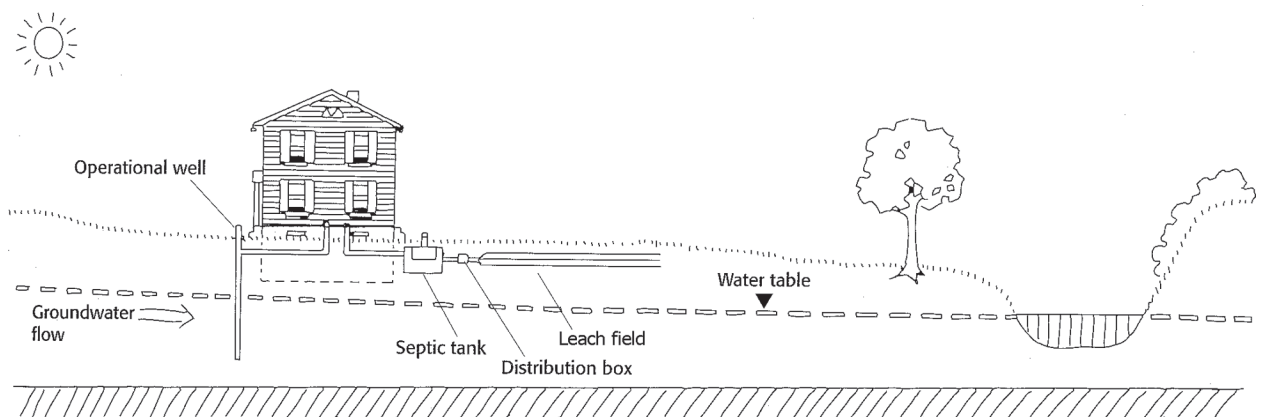

**Figure 7. Proper siting of wells and septic systems is essential to protecting water quality.**

## Septic System Care

### DO

- Inspect the entire system and monitor the tank volume annually.
- Pump out the septic tank at least every 3 to 4 years.
- Keep records of pumping, inspections and other maintenance.
- Reduce wastewater when possible and avoid overloading the system on any particular day.
- Install a lint trap on your washing machine to reduce lint that can clog the septic system.
- Know the location of your septic tank and leach field.
- Divert roof drains and surface water away from the leach field.
- Call a licensed professional when you have questions or problems.

### DON'T

- Dispose of any caustic or hazardous chemicals in your drains or toilet.
- Dispose of cigarette butts, egg shells, bones, diapers, sanitary napkins or tampons, facial tissues, paper towels, or other questionable items in the drains, toilets, or disposal.
- Drive or park on any part of the septic system.
- Plant trees or large shrubs near drain lines or leach field.
- Dig or build anything on top of the system.

if the system backs up or emits odors, have a plumber or engineer inspect the system to determine if it is properly designed and functioning. To keep your system operating correctly, observe the following maintenance practices.

Normal amounts of water and household products such as soap, detergents and bleaches will

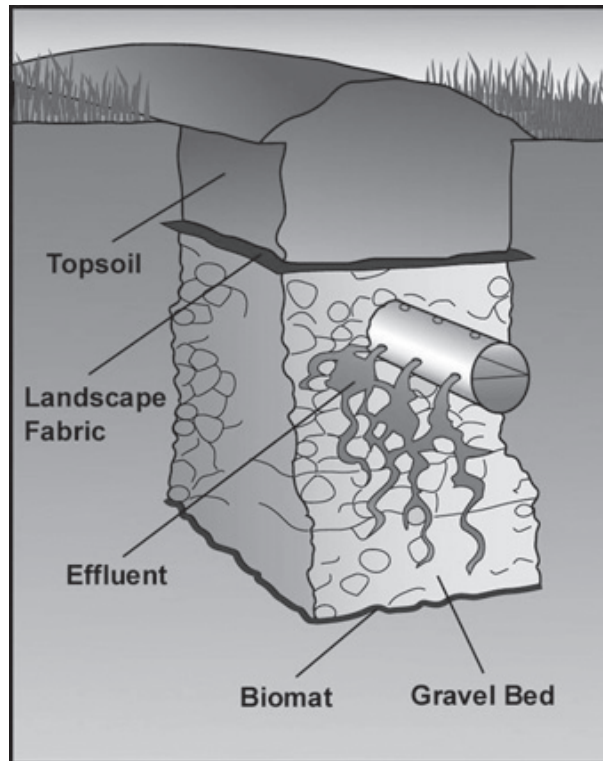
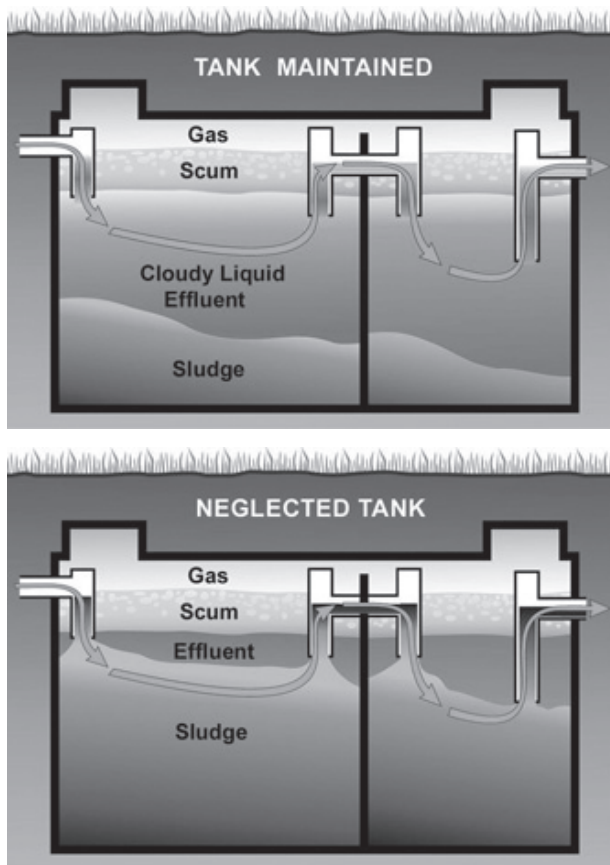

**Figure 8. Leachfields function best with adequate soil. It is important that you consult with a professional when planning a septic system.**

not harm a septic system. But excessive water use, garbage disposals, and some water treatment systems put additional demands upon household septic systems. Consider ways to minimize these loads on your system or be prepared to pump the tank out more frequently. Letting the tank overload reduces the time wastewater remains in the tank, resulting in premature failure of the absorption field and possible well water contamination.

### Livestock Waste

On-site storage of livestock waste is an important management technique that allows producers to dispose of manure in an environmentally sound way. However, waste storage facilities must be properly designed and managed to avoid contaminating water supplies. Animal wastes can be a source of microbial pathogens, as well as nitrate. Keeping these contaminants



**Figure 9. Septic tanks perform the first level of waste water treatment, and must be regularly pumped to properly function.**

out of drinking water supplies is essential for your family's health.

If you store animal wastes on or near a corral or feedlot, locate the lot at least 250 feet downhill of the well. Sandy soils, shallow groundwater, or sink holes increase the vulnerability of your well to contamination by animal wastes. Make provisions to collect or divert runoff water from the feedlot and the manure stockpile away from all water sources. In addition, apply the wastes at agronomic rates, or rates matching crops need, to cropland frequently enough to avoid excessive accumulation on the farmstead.

Liquid waste storage structures must also be located a safe distance away from wells and

## Radon Gas

Radon is an invisible, scentless and dangerous naturally-occurring element. Radon gas from soil, weathered rock, and groundwater volatilizes and decays into radioactive particles. These particles can be transported to the earth's surface in water wells and rising air. If consumed/inhaled, the particles become trapped in your lungs or other body tissue. Radioactive energy released from these particles damages cell tissue, increasing the risk of cancer. Lung cancer caused by radon exposure is second only to lung cancer caused by smoking, and radon exposure has been linked to other types of cancer as well.

Because potential radon exposure can come from two sources – water and air – it is important to test your water if your house has high radon or you live in an area known to have radon in groundwater.

Radon from well water can be taken out via a point-of-entry system (before the water reaches any outlet in your home) or a point of use system (at faucets inside your home). Point-of-entry systems are best for radon control, as these will control radon exposure from inhalation of volatilized particles (in showering, etc.).

A selection of home tests for the presence of radon and more information on the subject can be found at [www.radonzone.com](http://www.radonzone.com).

surface water. Liquid-tight storage structures should be at least 100 feet from wells; earthen structures should be at least 250 feet away. Construct anaerobic lagoons, runoff storage ponds, and earthen storage basins on clay soils or seal with bentonite or plastic liners to minimize seepage. Structures older than 10



**Do not locate animal confinement or feeding areas close to your wellhead.**

years should be inspected each time they are dewatered to determine if cracks, erosion, or worm channels are allowing leakage. If a pit designed to hold the wastes accumulated over a specific time (for example 90 days) continues to accommodate waste loads for a much longer period, the operator should suspect leakage and take immediate steps to correct the problem. Water tests for bacterial contamination are inexpensive and available from your county health department. These tests are highly recommended on all farmsteads that have corals or livestock. Positive results on a routine bacterial test often are an indication that more serious pathogens have compromised your drinking water.

#### Petroleum products and household hazardous wastes

It is important to locate all fuel tanks as far as practical from your well. Fuel leaks and spills migrate rapidly through soil to groundwater. Therefore, landowners with sites having highly permeable soils and shallow groundwater should consider installing above-ground tanks on impermeable pads with secondary containment. If you have a fuel spill or leak, contain the spill immediately and contact your county's hazardous waste division.

If you have underground storage tanks on your property, the best policy is to have them re-

moved now - before they cause groundwater contamination. Above-ground gasoline and diesel storage tanks are less likely to cause groundwater contamination because you can easily monitor their integrity.

Farmers and ranchers often use large amounts of lubricants, solvents and cleaning products. These chemicals are an unavoidable part of agricultural businesses, but they are also potentially hazardous to your health if they contaminate the domestic well. The area where vehicle maintenance is performed should be as far from the well as feasible. Solvents and waste oil should be taken to a recycling facility. Do not dispose of these chemicals on-site or use them for dust or weed suppression. Purchase these products only as needed to reduce the amount stored at the farm.

Paints, lead acid batteries, household cleaning products, and lawn care chemicals often are overlooked as potential sources of contamination. Store these products on impervious surfaces, a safe distance from the well. Never store any potential contaminants within a well house or well pit, if you have one. Try to buy only the amount of these products needed to avoid problems associated with storage and disposal.



**Fuel storage presents a potential risk to groundwater. Containment can reduce the risk of groundwater contamination in the event of a spill.**





**This wellhead is in serious need of a clean-up.**

As a general practice, minimize or eliminate the disposal of all wastes and trash on the farm or homestead, except those organic wastes (household garbage, lawn clippings, etc.) that can be composted. Do not burn empty pesticide or other chemical containers. Dispose of containers according to the label or at an approved solid waste facility. Careless storage and disposal of potentially hazardous wastes can seriously compromise the quality and value of your property.

### Fertilizers

Nitrate contamination of rural domestic wells can come from nearby crop fields, animal wastes, and wastewater systems. Fertilizers can cause nitrate contamination of rural water systems if they are handled or stored too close to the well. Nitrate is very soluble and will leach to groundwater much more rapidly than pesticides. Crop producers should observe the same precautions for fertilizer handling near the well as for pesticides.

Water tests for nitrate are an inexpensive way to routinely check your water supply. If you handle large amounts of fertilizer at your farmstead, or if you have confined animals nearby, it is recommended that you have a water sample analyzed for nitrate every year. Inexpensive test kits are available on the internet for those who wish to test their own water.

### Pesticides

Pesticide contamination of drinking water is not common in Colorado, but it is a serious problem when it does occur. Once a well is contaminated by pesticides it may take many years, or an expensive cleanup procedure, before the water is potable. In the past, farmers commonly handled pesticides near their well for convenience. That was before it became widely known that these chemicals could reach groundwater before they were decomposed. Today, pesticides should not be stored or handled near the farmstead wellhead unless they are kept on an impervious surface.

Routine pesticide spills that occur during mixing can add up over time if you continually mix in the same place. Rather than mix and load these chemicals at the farmstead, a better practice is to mix chemicals at the site of application using a nurse tank. If you must use the farmstead well to fill spray tanks, be sure to equip faucets with backflow check valves. Finally, clean your spray equipment in the field, if possible. Do not routinely wash down sprayers near the well.

### **If Your Water Is Contaminated**

If you suspect that your well is contaminated, use an alternative source of drinking and cooking water until your well water is tested. Try to determine the source of contamination and remove it if it is on your property. If you need help locating the source of contamination, contact your county health department, your CSU Extension agent, or your Natural Resources Conservation Service office. Isolate the source of contamination and drink bottled or treated water until well water quality returns to normal.

In some cases of well-water contamination, the only viable option is to find an alternate source of household drinking water. Drilling a new



**Private Well Protection Checklist**

**Yes**      **No**

- Have you had your well water tested within the last two years?
- Is your well less than 20 years old?
- Is the water table around your well deeper than 30 feet?
- Is your well securely capped and does it have intact casing that extends 1 foot above ground level?
- Is your well properly grouted to prevent entry of surface water?
- Do you mix, load, or store pesticides or fertilizer at least 100 feet from the well?
- Do you have backflow prevention devices installed on all faucets used to fill spray tanks?
- Are animal corrals and lagoons located at least 100 feet downhill from the well?
- Is your septic tank at least 50 feet from the well?
- Have you had your septic system pumped within the last four years?
- Are unused wells on your property properly plugged, sealed and abandoned according to the Construction Rules (2 CCR 402-2)?
- Are underground storage tanks removed or less than 10 years old?
- Are all fuel tanks at least 100 feet from the well?
- Do you dispose of pesticide containers, solvents, lubricants, paints, household cleaning products, and old batteries properly off-site?

If you answer **no** to any of these questions, your well may be vulnerable to contamination. Consider having your water tested and evaluate how you can improve the safety of your water supply.

well is expensive, but may be the best solution if the source of contamination is localized or there is a deeper aquifer that is uncontaminated. Connecting to municipal water supplies is becoming a feasible option for many rural homes in Colorado. In other situations, the best option may be to permanently use bottled water for drinking and cooking.

## Water Treatment

Many contamination problems can be corrected with a household water treatment system. Have your water tested by someone who is not selling treatment devices prior to buying one. Make sure you know what contaminants you want to treat and keep in mind that no single system can correct all water quality problems. All of these systems have limited life expectancies and require routine maintenance.

The purchase of water treatment equipment is a decision that must be carefully considered. Whether the purchase is made to improve the aesthetic characteristics of the water or to address health considerations, many factors must be determined.

The following are some key steps to use in selecting equipment:

1. Correctly identify the problem to be addressed using appropriate tests.
2. Identify options for correcting the problem.
3. Decide whether whole house or single-tap treatment is needed.
4. Select a reputable dealer.
5. Obtain second opinions.
6. Check to see if proposed equipment has been tested or validated by independent organizations such as the National Sanitation Foundation or Water Quality Association.
7. Talk with others who have the same equipment you may purchase.

8. Be sure to know all the costs of the equipment: purchase price, installation, operating, and routine required maintenance.
9. Understand what maintenance will be required.
10. Understand how to determine if the equipment is operating satisfactorily.
11. Determine if the system has adequate capacity for your needs.
12. Determine the expected life of the equipment and components.
13. Understand any warranty provided with the equipment.

## Frequently Asked Questions About Water Treatment

**What should treatment equipment remove from water?** Be specific about what you want to accomplish with water treatment equipment. Rely on independent water tests to identify and evaluate specific contaminants. There is no single device or method that removes everything or solves every water problem, regardless of the claims. In any case, it is generally not necessary to remove all contaminants.

**What water tests should be done to evaluate the need for treatment?** For private water supplies, a routine drinking water analysis is recommended when the property is purchased and should be repeated every four to five years. Keep your lab reports so you can observe any changes over time. If there are animal feeding operations or septic systems nearby, or if visitors complain of stomach problems, have the well tested annually for bacteria and nitrate.

**Are the free water tests provided by equipment dealers accurate?** The free tests are okay for selecting treatment of many nuisance problems, but they don't provide all the information needed to tell if the water is safe to drink. Even in the case of nuisance problems

you may want to have a second verifying test conducted by a certified laboratory.

**Do water quality problems require whole-house or only single-tap treatment?** Most nuisance problems such as iron, manganese, hardness, pH, odor, suggest whole-house or point-of-entry (treatment of the water as it enters the house) solutions. Some contaminants that affect health, such as nitrate and lead, are a concern only for water used for drinking or cooking. With these concerns, point-of-use (inside at taps and faucets only) equipment at a separate tap that treats a few gallons daily is adequate. Other contaminants such as bacteria and some organic contaminants will require point-of-entry equipment to prevent exposure during bathing or other water uses.

**What should I look for in a manufacturer or dealer?** Always try to purchase water treatment equipment from a reputable local company that will be available to provide service and repair or replacement parts. Avoid the high-pressure salesperson. Local merchants who expect to be around do not mind consumers taking time to decide. They intend to be there when you need help, so whether you buy today, next week or next month, makes little difference.

**Is bottled water a preferable option?** Bottled water from the store or from a known safe source offers the benefits of no equipment to buy, operate and maintain, and no lengthy commitment for improved quality. It is an excellent temporary option when guests come, when an infant needs water that meets the nitrate standard, or other situations. It may be more cost-effective than owning and maintaining equipment.

**What is involved in operating and maintaining treatment equipment?** Virtually all water treatment equipment requires maintenance and

service. The more treatment equipment you have, the greater the responsibility. Regardless of whether you or your dealer provides the service, there is a cost. Filters must be changed, materials added as needed, and the water checked regularly to be sure things are working. Poorly designed equipment may contribute to increased levels of some contaminants. Find out what supplies and equipment are needed, along with the expected costs.

**Will the unit produce enough treated water for your daily needs?** Carefully consider manufacturer and dealer claims for capacity. If one brand seems to offer unusually high capacity for the size and price, it may be overstated. If the units do not function as claimed, is there a refund or exchange policy? If the dealer makes a promise, ask for it in writing! Ask others who are using the equipment about their satisfaction with it. Be certain you understand the warranty and what components it covers.

**Where can I get additional help for water treatment?** Sources for water treatment assistance can be found in most Yellow Pages under the headings of “Water Treatment Equipment, Service and Supplies” or “Water Softening & Conditioning.” As with the use of any technical service, care should be taken to assure yourself that the professional you have chosen has specific experience in the treatment of your water’s problems. Ask for references, certifications, training credentials, the names of others who have used their services, and how long the professional has been performing his or her services. It is a good idea to obtain recommendations and price quotes from more than one professional.

#### **Management Strategies to Minimize Contamination Risks**

Select the appropriate practices to protect your private water supply based upon cost, feasibility, and overall benefits of the protective

**Table 5. Water treatment methods for private water systems**

Treatment method	Contaminants Removed	How it Works	Limitations
Cation or Anion Exchange (Water Softeners)	Barium, radium, iron, magnesium, calcium	Sodium exchanged for calcium and magnesium	Sodium may cause health problems
Activated Carbon Filters	Volatile Organic Compounds (VOCs), some pesticides, radon, mercury, odors	Water filtered through carbon granules	Must replace filters regularly
Chlorination	Bacteria and other microbial contaminants	Chlorine metered into water	Chlorine by-products may be harmful or affect taste of water
Distillation	Radium, odors, heavy metals, salt, nitrate, off-tastes	Evaporation/Condensation	Slow, energy intensive, expensive
Reverse osmosis	Radium, sulfate, nitrate, calcium, magnesium, salts, some pesticides and VOCs	Membrane filters dissolved impurities	Expensive, slow, wastes water
Mechanical filtration	Dirt, sediments, scale, insoluble iron and magnesium	Sand or other filtering material strains impurities	Does not remove dissolved contaminants
Ultraviolet radiation	Bacteria and other microbial contaminants	Water passes under a special UV light	No residual effect. May not work in cloudy water
Ozonation	Bacteria and other microbes	Water exposed to ozone gas	Equipment is expensive. No residual effect
Oxidizing filters	Iron, manganese, hydrogen sulfide	Contaminants removed through filtering and chemical reactions	Potassium permanganate is caustic

\*For more information, see “Private Water Systems Handbook”. MidWest Plan Service #14. Ames, Iowa.

### **Management Strategy Checklist to Minimize Contamination Risks**

- √ Conduct a site audit to determine what potential water quality hazards lie within the capture zone of your well and take appropriate steps to remove or reduce these hazards.
- √ Inspect the condition of the well cap, casing, and pad at least annually.
- √ Repair cracked well casings and failed grout or seals immediately to prevent groundwater contamination.
- √ Install backflow prevention devices on all hydrants used as a water source for pesticide or fertilizer mixing.
- √ Mix pesticides and fertilizers in the field where they will be applied, away from the well head, or on an impervious pad.
- √ Store all hazardous chemicals on an impervious surface, a safe distance downhill of the well.
- √ Implement setbacks of at least 100 feet between wells and areas where fuels and agricultural chemicals are handled.
- √ Keep animal waste at least 100 feet down-gradient from wells.
- √ Dispose of agricultural chemicals, lubricants, cleaning products, and empty pesticide containers at an approved collection facility. Do not dispose of any potentially hazardous waste in an on-site dump.
- √ Sample well water periodically and have water analyzed for nitrate, bacteria, and other pertinent water quality constituents by reputable laboratory.
- √ Plug and seal unused wells according to state abandonment standards (2 CCR 402-2).
- √ Avoid applying pesticides or fertilizers near the well head.
- √ Minimize activity around the well head, such as gardening, pets, livestock, etc.
- √ Ensure that the well head is visible, cleared of weeds and other vegetation. Mow, do not spray, weeds near well heads.



measure. Remember, it is your responsibility to make sure that your family's drinking water is safe.

## Well Water System Terminology

**Aquifer** – A water-bearing layer of sediment or rock with interconnected pore spaces or fractures where water accumulates.

**Borehole** – The cylindrical hole drilled into the aquifer when drilling a well.

**Casing** – Steel or PVC tubing placed in the borehole to keep the borehole open and to allow a void to store water and install a pump.

**Coliform Bacteria** – A type of bacteria that is found in the intestinal tract of all animals, including humans. Levels of these bacteria are used as an indicator of well cleanliness.

**Control Box** – Electrical switch box that turns the well pump on and off.

**Corrosivity Index** – One of the methods for assessing the scale dissolving (corrosive) or scale forming potential of water. A positive number indicates a tendency to deposit calcium carbonate. If the result is negative, it is an indication that the water will dissolve calcium carbonate and enhance corrosion. Please also see Langelier Index.

**Disinfection** – The destruction of all pathogenic organisms, with chlorine, ozone, ultraviolet "UV" light or heating

**Drop Pipe** – Pipe placed in the casing to connect the pump to the surface.

**Electrical Cable** – Wiring from the pump control box to the pump that supplies power for the pump and sends command signals.

**End Cap** – Cap placed on the bottom of the casing to prevent sediment from flowing into the casing.

**Gravel Pack** – Gravel or sand placed between the borehole wall and the well screen to keep the borehole open and filter water before it enters the well.

**Groundwater** – Water stored beneath the

surface of the earth that is transmitted through small, interconnected pores and fractures between sediment and rock.

**Hardness** – Hardness is a relative term that describes the content of the dissolved minerals, specifically calcium and magnesium.

**Iron Bacteria** – Microorganisms that feed on iron in the water or on the pipe. They may appear as a slimy rust colored coating on the interior surface of a toilet flush tank or as a glob of gelatinous material in the water.

**Langelier Index** – a measure of balance in the water of the pH with presence of calcium carbonate ( $\text{CaCO}_3$ ). A negative L.I. value (undersaturation of  $\text{CaCO}_3$ ) will result in greater corrosivity; a positive L.I. value (oversaturation of  $\text{CaCO}_3$ ) will result in precipitation of the element, accumulating calcium on water fixtures, shower walls, etc.

**Pitless Adapter** – A device attached to the well casing that allows water to be diverted from the drop pipe to piping on the exterior of the well below the frost line. Replaces well pits.

**Pressure Tank** – A water holding tank equipped with an air bladder that regulates water pressure into the home and demand to the pump.

**Pumping Water Level** – The depth below the surface of the groundwater level in the well when the pump is operating. This is always deeper than the static water level.

**Sanitary Well Seal** – A sealed cap on the top of the well casing that prevents surface contaminants from entering the inside of the well.

**Submersible Pump** – The most common type of water well pump includes the pump and pump motor placed at the bottom of the drop pipe below the pumping water level.

**Static Water Level** – The depth below the surface of groundwater when the pump is not operating.

**Surface Casing** – Steel casing that extends at least 19 feet (see page 8) deep to at least 1 foot above the ground surface that prevents surface

contaminants from entering the well. This is the last casing installed.

**Total Dissolved Solids (TDS)** – A good general indicator of water quality, which measures the total amount of dissolved minerals, metals, and salts. Water with more than 500 milligrams per liter TDS is of marginal quality and may contain undesirable amounts of calcium, magnesium, sulfate, chloride, or other salts.

**Treatment Equipment** – Can include a variety of equipment designed to remove various

water contaminants and improve groundwater before use.

**Wellhead** – The physical structure, facility, or device at the land surface from or through which groundwater flows or is pumped from subsurface, water bearing formations.

**Well Screen** – Steel or PVC perforated pipe that water flows through to enter the well and pump.

## WATER AGENCIES AND CONTACTS

For more information about private well protection or specific inquiries about BMPs, contact Colorado State University Extension or one of the following agencies. They have publications, programs, and specialists that can help you protect our water resources.

**Colorado State University Extension:** This arm of the University has water quality projects, educational programs, and water quality specialists. You will find the contact number for your county office in your local phone book or visit [www.ext.colostate.edu](http://www.ext.colostate.edu).

**Colorado Department of Public Health and Environment - Water Quality Control Division:** This state agency has the primary responsibility for managing water quality in Colorado. They conduct monitoring programs and enforce health and drinking water standards – (303) 692-3500.

**Colorado Division of Water Resources (DWR):** Contact Groundwater Information at the Colorado Division of Water Resources at (303) 866-3587. The general number for DWR is (303) 866-3581.

Other Extension fact sheets that may be helpful include:

6.700 - *Private Wells for Home Use*

9.307 - *Drinking Water Quality and Health*

4.717 - *Glossary of Water Terminology*

0.520 - *Selecting an Analytical Laboratory*

0.517 - *Nitrates in Drinking Water*

6.703 - *Bacteria in Wells*

9.952 - *Water Conservation In and Around the Home.*

*Water Quality Interpretation Tool: [www.csuwater.info](http://www.csuwater.info), click on “Water Quality Tool”*



