

CLICK ANYWHERE on THIS PAGE to RETURN to BATHROOM VENT FAN INFORMATION at InspectApedia.com

NuTone®

VENTILATION FANS



WHEREVER YOU DWELL,
LIVE MORE COMFORTABLY

A preferred choice of electrical pros since 1936.

NUTONE. HOME COMFORT AND CONV

What started with the world's first door chime eight decades ago is now the NuTone you know and trust for products that contribute to more comfortable lifestyles.

You'll find America's leading brand of convenience products in homes across the country, including ventilation fans, door chimes, central vacuum systems and home automation systems. We clear the air in any room, greet your guests when they arrive at your door, make floors and carpets spotless, and enable you to confirm your garage door is closed, and close it, from anywhere in the world.

We're continually refining our comprehensive product line that homeowners interact with every day. And when a product is installed, our award-winning technical support team is ready to answer any question. At NuTone, we bring peace of mind to contractors and homeowners. Consider this; 86 percent of contractors would recommend NuTone products. That can only happen when customers are satisfied. And that's why we proudly say, **NuTone is the preferred choice of electrical pros since 1936.**



OVER 80 YEARS OF INNOVATING LIFE AT HOME



Doorbells



Door Chimes

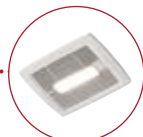

Ventilation Fan/Lights



Ventilation Fans



Ceiling Fans

ENIENCE SOLUTIONS.

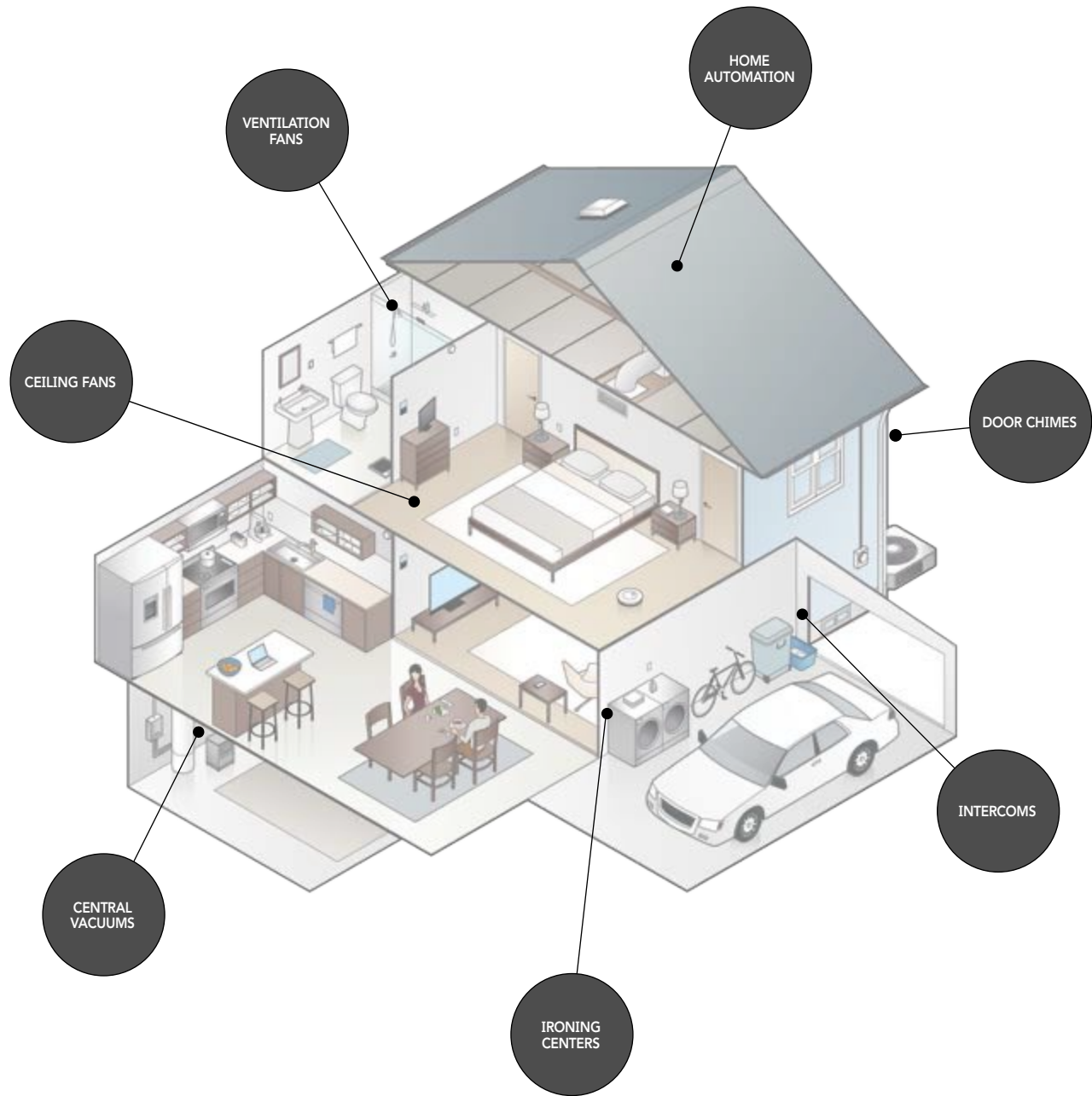

Central Vacuums

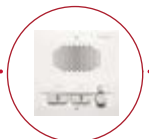

Intercoms



Ironing Centers



Home Automation



Backyard Lighting & Mosquito Repellency

CLEAN AIR, COMFORT AND CONVENIENCE IS IMPORTANT IN EVERY ROOM OF THE HOME, NOT JUST THE BATHROOM.

- 2-3 INTRODUCTION
- 6-7 CODES
- 8-13 ULTRA™ SERIES
- 14-19 QTXE SERIES
- 20-23 INVENT™ SERIES
- 24-25 LOPROFILE™
- 26-29 CLASSIC VENTILATION
- 30-35 ARCHITECTURAL LIGHTING
- 36-39 SPECIALTY
- 40-45 HEATER-FAN-LIGHTS
- 46-49 WALL CONTROLS
- 50-51 ACCESSORIES
- 52-53 FAQs
- 54-55 INSTALLATION NOTES
- 56-57 SPECIFICATIONS





NUTONE KNOWS TODAY'S STRINGENT VENTILATION CODES AND STANDARDS.

Because today's homes are built tighter than ever before, what gets in stays in, unless mechanically ventilated out. Premium ventilation solutions from NuTone dramatically reduce moisture as well as airborne pollutants from off-gassing building materials, adhesives and household cleaners. They also help eliminate allergens, dust, pet dander and cooking effluents—everything that contributes to poor indoor air quality.

Both spot and whole house ventilation are important. Spot ventilation products remove pollutants at the source when they occur—think bathroom fans and kitchen range hoods—quickly eliminating humidity, odor and cooking effluents.

Whole-house ventilation, also known as continuous or dwelling unit ventilation (DUV), continually removes what's not captured by spot ventilation for a more healthy and comfortable home.

Understanding today's ventilation requirements.

The American Society of Heating, Refrigeration and Air Conditioning Engineers (ASHRAE) set the industry standard for ventilation and acceptable indoor air quality for low-rise residential buildings with ASHRAE 62.2. It sets the minimum standard for spot or local ventilation of individual bathrooms of 50 Cubic Feet per Minute (CFM) delivered airflow at 3.0 sones or less. It also specifies the requirements for whole house ventilation of an entire dwelling at the maximum sound rating of 1.0 sone for ventilation fans.

Code Adoption Growing Rapidly.

California was a leader in this area with their Title 24 Code. Other state and city governments are quickly adopting similar codes such as the International Energy Conservation Codes (IECC 2012) to improve energy efficiency as well as indoor air quality.

Above-code green building programs such as ENERGY STAR® for Homes, ENERGY STAR® Indoor Air Plus, the Leadership in Energy and Environment Design (LEED) Certification Building Program and the National Association of Home Builders (NAHB) Green Building Standard are certified green building programs that promote human health and conserve natural resources. Let NuTone help you meet the goals of these programs.

You've come to the right place for product solutions.

With NuTone's extensive product line-up, including exhaust and balanced ventilation options such as Heat Recovery Ventilators (HRVs) and Energy Recovery Ventilators (ERVs), you're sure to find the ideal solution to meet your needs.

SELECTING THE PROPER WHOLE HOUSE RESIDENTIAL VENTILATION SOLUTION.

Sizing your solution is a factor of square footage and the number of bedrooms in the dwelling to meet requirements. These charts are based on ASHRAE 62.2. Note that the 2010 and 2013 versions are different. Most states still operate under 62.2-2010 rates. Before specifying, check local building codes to ensure it meets requirements.

2010 Required Continuous Ventilation Rate (CFM)

| Floor Area Sq. Ft. | 0-1 BR | 2-3 BR | 4-5 BR | 6-7 BR | >7 BR |
|--------------------|--------|--------|--------|--------|-------|
| <1500 | 30 | 45 | 60 | 75 | 90 |
| 1501-3000 | 45 | 60 | 75 | 90 | 105 |
| 3001-4500 | 60 | 75 | 90 | 105 | 120 |
| 4501-6000 | 75 | 90 | 105 | 120 | 135 |
| 6001-7500 | 90 | 105 | 120 | 135 | 150 |
| >7500 | 105 | 120 | 135 | 150 | 165 |

2013 Required Continuous Ventilation Rate (CFM)

| Floor Area Sq. Ft. | 0-1 BR | 2-3 BR | 4-5 BR | 6-7 BR | >7 BR |
|--------------------|--------|--------|--------|--------|-------|
| <500 | 30 | 40 | 45 | 55 | 60 |
| 500-1000 | 45 | 55 | 60 | 70 | 75 |
| 1001-1500 | 60 | 70 | 70 | 85 | 90 |
| 1501-2000 | 75 | 85 | 90 | 100 | 105 |
| 2001-2500 | 90 | 100 | 105 | 115 | 120 |
| 2501-3000 | 105 | 115 | 120 | 130 | 135 |
| 3001-3500 | 120 | 130 | 135 | 145 | 150 |
| >3501 | 135 | 145 | 150 | 160 | 165 |

AN ALTERNATIVE FORMULA APPROACH TO THE TABLES GIVEN ABOVE

An alternative formula approach to the tables given above also exists which typically results in a lower, more precise CFM requirement. Under the more common 62.2-2010 version, continuous CFM requirements can be calculated using a formula as follows.
 $CFM = .01 \times \text{floor area (in square feet) plus } 7.5 \times (\text{number of bedrooms} + 1).$

Example: A 3,500 square foot home with 4 bedrooms would require 73 CFM
 $.01 \times 3,500 = 35$
 $7.5 \times (4+1) = 38$
 Add together for a total of 73 CFM (as compared to the 90 from the table)

The 62.2-2013 version increases the multiplier for floor area from .01 to .03. Note however that infiltration credits can be taken if blower door testing is conducted.

Whole House Ventilation Options

| Fan Series | Model | CFM | 0.25" CFM | Sones | Motor Type | Sensing | Duct Size | Page No. |
|-------------------------|-----------------|-----|-----------|-------|------------|----------|-----------|----------|
| UltraGreen Multi Speed | ZN80 | 80 | 80 | <0.3 | DC | — | 6" or 4" | 11 |
| | ZN80M | 80 | 80 | <0.3 | DC | Motion | 6" or 4" | 11 |
| | ZN110 | 110 | 110 | <0.3 | DC | — | 6" | 11 |
| | ZN110H | 110 | 110 | <0.3 | DC | Humidity | 6" | 11 |
| | ZN110M | 110 | 110 | <0.3 | DC | Motion | 6" | 11 |
| UltraGreen Single Speed | XN50 | 50 | 50 | <0.3 | DC | — | 6" or 4" | 11 |
| | XN80 | 80 | 80 | <0.3 | DC | — | 6" or 4" | 11 |
| | XN110 | 110 | 110 | <0.3 | DC | — | 6" | 11 |
| | XN110H | 110 | 110 | <0.3 | DC | Humidity | 6" | 11 |
| UltraPro | RN80 | 80 | | <0.3 | PSC | — | 4" | 13 |
| | RN110 | 110 | | 0.6 | PSC | — | 4" | 13 |
| QTXEN | QTXEN080 | 80 | | 0.3 | PSC | — | 6" | 16 |
| | QTXEN110 | 110 | | 0.7 | PSC | — | 6" | 16 |
| LoPro | LPN80 | 80 | | 1.0 | PSC | — | 4" or 3" | 25 |
| InVent | AEN80 | 80 | | 0.8 | PSC | — | 4" | 22 |
| | AEN50 | 50 | | 0.5 | PSC | — | 4" | 22 |

| Fan/Light Series | Model | CFM | 0.25" CFM | Sones | Motor Type | Sensing | Duct Size | Page No. |
|-------------------------|---------------------|-----|-----------|-------|------------|----------|-----------|----------|
| UltraGreen Multi Speed | ZN80L | 80 | 80 | <0.3 | DC | — | 6" or 4" | 11 |
| | ZN80ML | 80 | 80 | <0.3 | DC | Motion | 6" or 4" | 11 |
| | ZN110L | 110 | 110 | <0.3 | DC | — | 6" | 11 |
| | ZN110HL | 110 | 110 | <0.3 | DC | Humidity | 6" | 11 |
| | ZN110ML | 110 | 110 | <0.3 | DC | Motion | 6" | 11 |
| UltraGreen Single Speed | XN50L | 50 | 50 | <0.3 | DC | — | 6" or 4" | 11 |
| | XN80L | 80 | 80 | <0.3 | DC | — | 6" or 4" | 11 |
| | XN110L | 110 | 110 | <0.3 | DC | — | 6" | 11 |
| | XN110HL | 110 | 110 | <0.3 | DC | Humidity | 6" | 11 |
| UltraPro | RN80L | 80 | | <0.3 | PSC | — | 4" | 13 |
| | RN110L | 110 | | 0.8 | PSC | — | 4" | 13 |
| QTXE | QTXEN110SFLT | 110 | | 0.7 | PSC | — | 6" | 18 |
| | QTXEN150FLT | 150 | | 1.4 | PSC | — | 6" | 17 |
| InVent | AEN80L | 80 | | 0.8 | PSC | — | 4" | 22 |
| | AN80L | 80 | | 1.0 | PSC | — | 4" | 22 |

NUTONE CODE KEY

The exclusive online tool that ensures compliant ventilation selection.

Specifying a dwelling unit ventilation (DUV) system for residences is complicated. Code Key from NuTone is the only online resource that helps you select the right product in minutes. Choose the dwelling's state, home size facts and user preferences and receive a list of recommended ventilation products. Change parameters to instantly see a range of options. Code Key requires no software and works on mobile devices. It's another way NuTone—the pioneer in ventilation for more than 80 years—leads the ventilation industry with forward-thinking products and customer service.

nutone.com/tools-landing-page/codekey



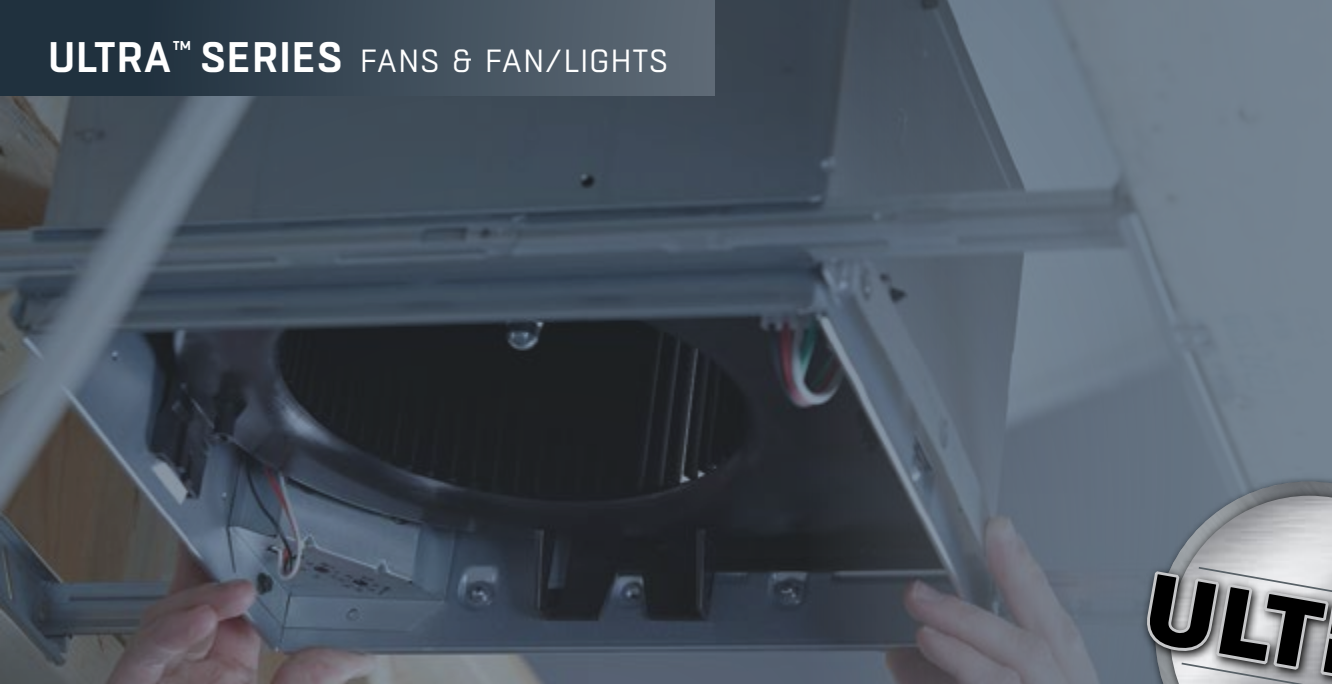

A REVOLUTION IN
VENTILATION FAN TECHNOLOGY
**ENGINEERED TO SIMPLIFY
INSTALLATION.**

WE DIDN'T JUST CHANGE ONE THING TO MAKE INSTALLATIONS FASTER, WE CHANGED EVERYTHING. From a unique telescoping mounting frame that installs room-side on retrofits to an easy-to-insert housing and blower that snap into place, we designed the ULTRA™ Series to be the fastest, easiest, most universal installation in new construction or retrofit. No matter what's behind the drywall on your next retrofit job, you'll never have another difficult installation. And just as important, the ULTRA™ Series meets whole-house mechanical ventilation codes and green building program requirements. It's a revolutionary way to install and a revolutionary way to ventilate.





SOUND TECHNOLOGY

Reduce sound levels and improve sound quality in real-world installations. The innovative, patent-pending QStream™ technology utilizes airflow-smoothing baffles that reduce turbulence which means the blower can turn more slowly and quietly—without airflow loss.*

*Not available on 110 CFM UltraGreen Models

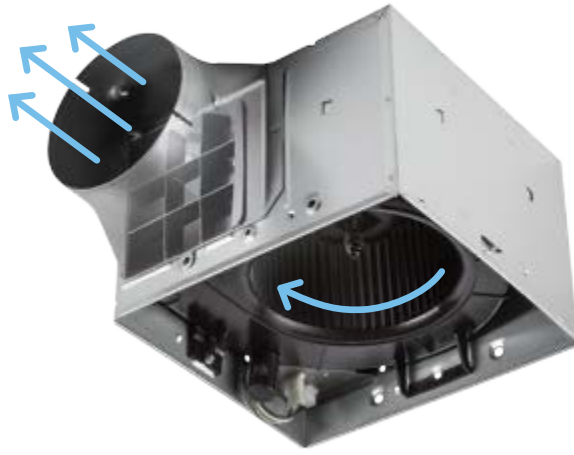

Inside/outside wiring capability provides flexible new or retrofit installation

Pre-installed screws in the mounting frame enable quick installation

Vertical positioning tabs ensure the housing is in the right place

The expandable mounting frame adjusts from 14"–24" and fits any type of joist, I-joist or truss construction

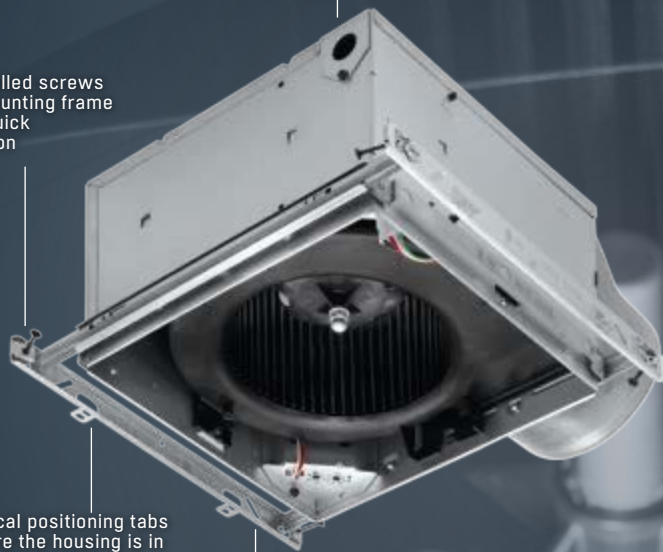

ULTRAQUICK™ INSTALLATION TECHNOLOGY

ULTRA™ Series Ventilation Fans are engineered to be the fastest, easiest, most universal installation in remodel, retrofit and new construction—in any type of joist or truss system. Exclusive features simplify room-side installation to save valuable time and money.

For energy saving options see ULTRA GREEN on page 10

RDFU PREMIUM RADIATION DAMPER FOR ULTRA GREEN™ AND ULTRA PRO™ FANS.

When the air temperature passing through the damper exceeds 165°F the fusible link melts, triggering the thermal fabric to automatically close across the damper. Airflow is interrupted by a flame and heat barrier, preventing the rapid spread of fire to other areas.

- Motor serviceable without disturbing drywall
- Galvanized steel frame
- High temperature, non-asbestos, reinforced fiber thermal fabric
- Stainless steel closure springs
- 165°F fusible link
- Use the same grille provided with the ULTRA™ Series fan
- Use Model RDFU with RDJUMPU for ULTRA Green™ and ULTRA Pro™ models with lighting and/or sensing
- UL Standard 555C Classified



THE PERFECT SOLUTION TO MEET TODAY'S CONTINUOUS VENTILATION REQUIREMENTS.

Built for easy installation in either new construction or retrofit applications, the ULTRA Green™ Series makes it simple to ventilate any room in the house. In today's tightly built homes, unhealthy pollutants and excess humidity stay trapped inside unless they are mechanically vented away. Exclusive ULTRA Smart™ DC Motor and Control Technology enables fans to maintain their powerful operation—even at high static pressures—and provide required air movement levels for whole-house ventilation, all while meeting spot ventilation needs on demand. Continuous CFM levels can be precisely adjusted to meet the specific needs of each home.

- HVI certified at <0.3 Sones, ULTRA Silent™ Sound Technology provides the quietest sound rating obtainable
- 50, 80 or 110 CFM
- Intermittent and continuous ventilation
- ULTRA Smart™ DC Motor and Control Technology monitors performance and adjusts motor speed to ensure rated air movement
- ENERGY STAR® qualified
- ULTRA Quick™ Installation Technology saves time with the fastest, easiest, most universal installation
- XN and ZN models feature 6" ducting—50 and 80 CFM models include an optional 6" to 4" duct reducer
- Bright, energy efficient 36 watt fluorescent lighting
- UL Listed for use over bathtub or shower when connected to a GFCI protected branch circuit
- Type IC
- Fits 2" x 8" ceiling construction
- Optional RDFU Premium Radiation Damper Kit available for all XN and ZN models



XN50 | XN80 | XN110 | ZN80 | ZN110 FANS

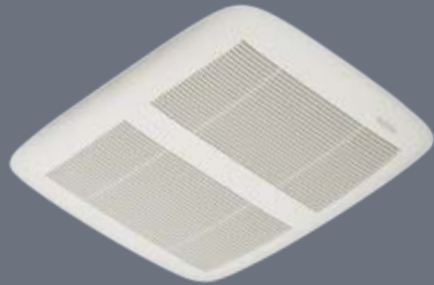

XN110H | ZN110H HUMIDITY SENSING FANS



ZN80M | ZN110M MOTION SENSING FANS



XN50L | XN80L | XN110L | ZN80L | ZN110L FAN/LIGHTS

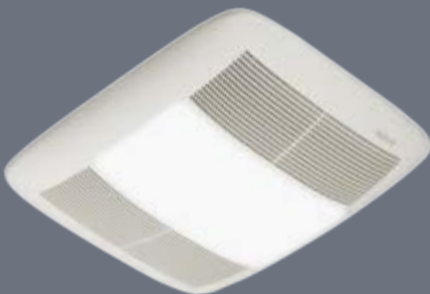

XN110HL | ZN110HL HUMIDITY SENSING FAN/LIGHTS



ZN80ML | ZN110ML MOTION SENSING FAN/LIGHTS



Humidity Sensing



Motion Sensing

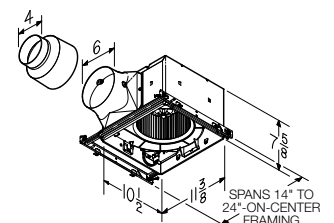



ULTRASMART™ DC MOTOR AND CONTROL TECHNOLOGY

To virtually ensure full-rated performance—regardless of the ducting situation—ULTRA™ Green Series fans automatically monitor and adjust CFM output. For continuous ventilation needs, multi-speed models may be precisely set as low as 30 CFM to avoid costly over-ventilating. A second dial controls runtime at maximum CFM. Our DC motor is the most efficient in our line—80 CFM models use only 5.8 watts.

ULTRASILENT™ SOUND TECHNOLOGY

ULTRA™ Green Series Ventilation Fans are HVI certified at a remarkable <0.3 Sones; the quietest sound rating obtainable. A dynamically balanced DC motor mounted behind the wheel, a state-of-the-art blower that reduces turbulence, and a free-flowing 6" duct outlet opening that won't inhibit airflow make it possible. There's no quieter fan available.

POWERFUL MOTION & SENSING TECHNOLOGIES

ULTRA Fans with SensAire humidity sensing technology detect the rapid rise in humidity at the ceiling level. This means that they will react to shower humidity much faster than competitive fans or wall controls. Multi-speed models turn the fan speed up from the lower continuous CFM level. Single-speed models turn the fan on automatically.

ULTRA Fans with motion sensing and multi-speed capability automatically turn the fan up to maximum speed from the lower continuous setting when motion is detected which is ideal for family members who forget to turn the fan on.

**ULTRA™ GREEN SERIES FANS
SAVE UP TO 10 HERS POINTS
AND UP TO \$200 PER YEAR IN
OPERATING COST.***

| Model | CFM | Sones | Light/Night Light | Humidity Sensing | Motion Sensing | Ducting | Grill Dims (in) L W | ENERGY STAR® |
|--------------------------------|-----|-------|-------------------|------------------|----------------|------------------|------------------------|--------------|
| Single-speed Fans | | | | | | | | |
| XN50 | 50 | <0.3 | — | — | — | 6" | 13 14 | Yes |
| | 50 | <0.3 | — | — | — | 6" to 4" reducer | | |
| XN80 | 80 | <0.3 | — | — | — | 6" | 13 14 | Yes |
| | 80 | 0.3 | — | — | — | 6" to 4" reducer | | |
| XN110 | 110 | <0.3 | — | — | — | 6" | 13 14 | Yes |
| XN110H | 110 | <0.3 | — | Yes | — | 6" | 13½ ₈ 14 | Yes |
| Single-speed Fan/Lights | | | | | | | | |
| XN50L | 50 | <0.3 | 2- 18W GU24 / 4W | — | — | 6" | 13 14 | Yes |
| | 50 | <0.3 | | | | | | |
| XN80L | 80 | <0.3 | 2- 18W GU24 / 4W | — | — | 6" | 13 14 | Yes |
| | 80 | 0.3 | | | | | | |
| XN110L | 110 | <0.3 | 2- 18W GU24 / 4W | — | — | 6" | 13 14 | Yes |
| XN110HL | 110 | <0.3 | 2- 18W GU24 / 4W | Yes | — | 6" | 13½ ₈ 14 | Yes |
| Multi-speed Fans | | | | | | | | |
| ZN80 | 80 | <0.3 | — | — | — | 6" | 13 14 | Yes |
| | 80 | 0.3 | | | | | | |
| ZN80M | 80 | <0.3 | — | — | Yes | 6" | 13½ ₈ 14 | Yes |
| | 80 | 0.3 | | | | | | |
| ZN110 | 110 | <0.3 | — | — | — | 6" | 13 14 | Yes |
| ZN110H | 110 | <0.3 | — | Yes | — | 6" | 13½ ₈ 14 | Yes |
| ZN110M | 110 | <0.3 | — | — | Yes | 6" | 13½ ₈ 14 | Yes |
| Multi-speed Fan/Lights | | | | | | | | |
| ZN80L | 80 | <0.3 | 2- 18W GU24 / 4W | — | — | 6" | 13 14 | Yes |
| | 80 | 0.3 | | | | | | |
| ZN80ML | 80 | <0.3 | 2- 18W GU24 / 4W | — | Yes | 6" | 13½ ₈ 14 | Yes |
| | 80 | 0.3 | | | | | | |
| ZN110L | 110 | <0.3 | 2- 18W GU24 / 4W | — | — | 6" | 13 14 | Yes |
| ZN110HL | 110 | <0.3 | 2- 18W GU24 / 4W | Yes | — | 6" | 13½ ₈ 14 | Yes |
| ZN110ML | 110 | <0.3 | 2- 18W GU24 / 4W | — | Yes | 6" | 13½ ₈ 14 | Yes |

ENERGY STAR® fans use 70% less energy, on average, than standard models and may qualify for local utility rebates



* Compared to a central fan-integrated system when used for continuous ventilation; based on software calculations and analysis conducted by Broan-NuTone

QFLOW™ TECHNOLOGY MEANS SMOOTHER AIRFLOW **AND OPTIMAL BACKDRAFT SEALING.**

QFlow™ Damper Technology Patent-pending QFlow technology helps achieve desired building airtightness scores when the fan is off. It also removes the duct damper flap from the airstream path, reducing static pressure and noise when the fan is on.

FAN OFF



Without QFlow, outdoor air can intrude past the damper edges.

With QFlow, outdoor air intrusion is blocked with its edge-to-edge design.

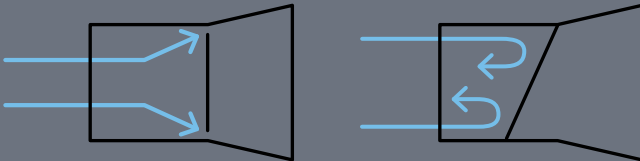

FAN ON



Pre-installed screws in the mounting frame enable quick installation

Without QFlow, the flap impedes airflow which increases static pressure, turbulence and noise.

With QFlow, the flap lifts out of the way, minimizing turbulence for more quiet operation.

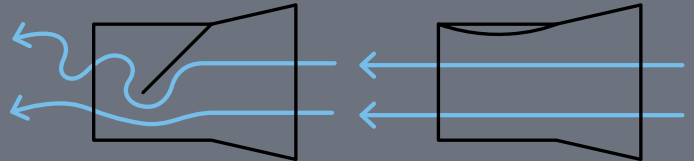

REDUCE SOUND LEVELS AND IMPROVE SOUND QUALITY IN REAL-WORLD INSTALLATIONS.



SOUND TECHNOLOGY

The innovative, patent-pending QStream™ technology utilizes airflow-smoothing baffles that reduce turbulence which means the blower can turn more slowly and quietly—without airflow loss.

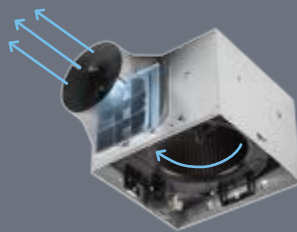

With QStream™ Technology

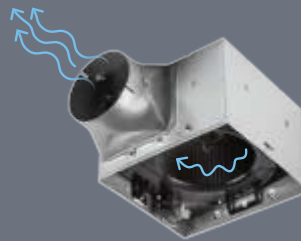

Without QStream™ Technology

ULTRAQUICK™ INSTALLATION TECHNOLOGY

ULTRA™ Series Ventilation Fans are engineered to be the fastest, easiest, most universal installation in remodel, retrofit and new construction—in any type of joist or truss system. Exclusive features simplify room-side installation to save valuable time and money.

Inside/outside wiring capability provides flexible new or retrofit installation

Pre-installed screws in the mounting frame enable quick installation

Vertical positioning tabs ensure the housing is in the right place

The expandable mounting frame adjusts from 14"–24" and fits any type of joist, I-joist or truss construction



ULTRA PRO FEATURES

- Provide your customers extremely quiet operation with innovative sound reduction technologies
- QStream™ technology features airflow-smoothing baffles to reduce turbulence
- Optional RDFU Premium Radiation Damper Kit available for all XN and ZN models

The preferred install choice for professionals to deliver quiet performance



Ultra Pro Series

| Model | Duct Size | CFM | Sones | Light/Night Light | ENERGY STAR® | Housing Dims (in) | | | Grille Dims (in) | | Grille Finish | UL Listed for Tub/Shower use |
|--------------------------------|-----------|-----|-------|-------------------|--------------|--------------------------------|--------------------------------|-------------------------------|------------------|----|-----------------|------------------------------|
| | | | | | | W | L | H | L | W | | |
| Single-Speed Fans | | | | | | | | | | | | |
| RN80 | 4" | 80 | <0.3 | — | Yes | 11 ³ / ₈ | 10 ¹ / ₂ | 7 ⁵ / ₈ | 13 | 14 | White Polymeric | Yes |
| RN110 | 4" | 110 | 0.6 | — | Yes | 11 ³ / ₈ | 10 ¹ / ₂ | 7 ⁵ / ₈ | 13 | 14 | White Polymeric | Yes |
| Single-Speed Fan/Lights | | | | | | | | | | | | |
| RN80L | 4" | 80 | <0.3 | 2- 18W GU24 / 4W | Yes | 11 ³ / ₈ | 10 ¹ / ₂ | 7 ⁵ / ₈ | 13 | 14 | White Polymeric | Yes |
| RN110L | 4" | 110 | 0.8 | 2- 18W GU24 / 4W | Yes | 11 ³ / ₈ | 10 ¹ / ₂ | 7 ⁵ / ₈ | 13 | 14 | White Polymeric | Yes |

ENERGY STAR® fans use 70% less energy, on average, than standard models and may qualify for local utility rebates



A woman with her hair in a bun is relaxing in a white bathtub. She is looking out a window with sheer curtains. Her right arm is resting on the edge of the tub. A small bottle of bath product is visible on the tub's edge near the window.

NUTONE QT SERIES.

SO QUIET, YOU MIGHT EASILY FORGET





IT'S ON.

PEACEFUL MOMENTS CAN BE ENJOYED EVEN MORE WITH VENTILATION FROM A QUIET, QT SERIES FAN.

The very quiet NuTone QT Series is the ideal solution for any room that benefits from ventilation. Most QT models operate at less than one sone—the sound of a quiet running refrigerator. But quiet operation doesn't mean less power. Installed properly, the QT Series maintains full-rated airflow in real-world installations. So choose a QT Series bath fan, fan/light or heater/fan/light for your application. NuTone has the perfect solution for every room.

QTXEN FAN FEATURES

- Very quiet operation 0.3 to 1.4 sones
- 80 CFM to 150 CFM
- 6" ducting for superior performance
- ENERGY STAR® qualified
- HVI Certified
- UL Listed for use over tub or shower when installed in a GFCI protected branch circuit
- Housing Packs include hanger bar system for fast and flexible installation for all types of construction
- Fits 2" x 8" ceiling construction
- Motor engineered for continuous operation
- Radiation damper Model RDFQF available separately

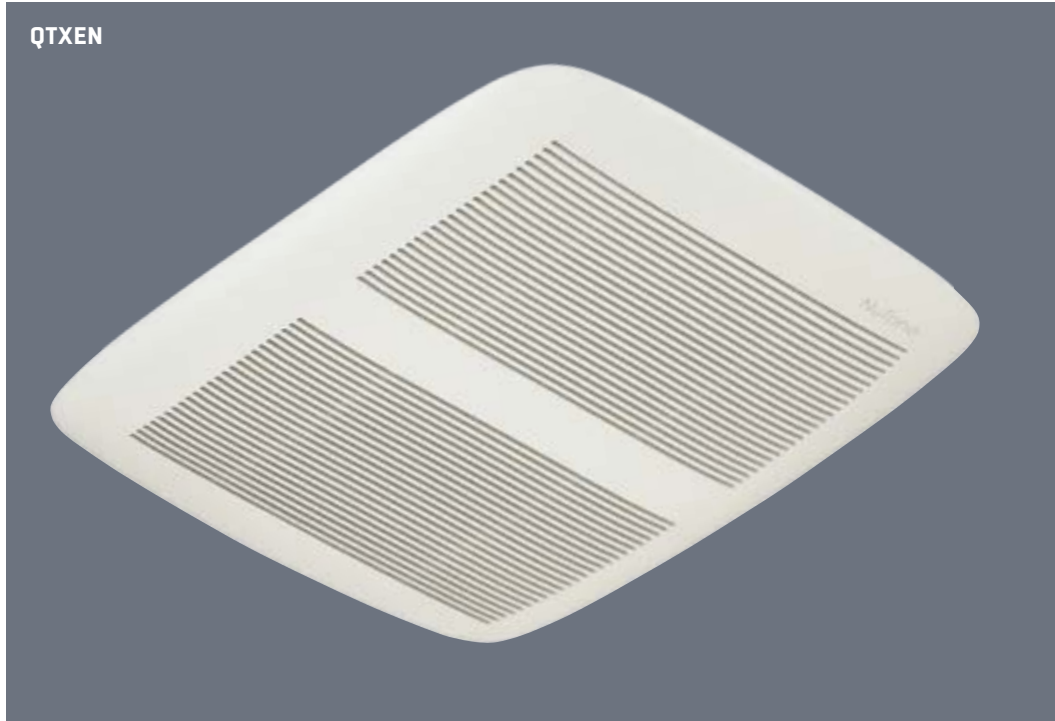

Models QTXEN080, QTXEN110

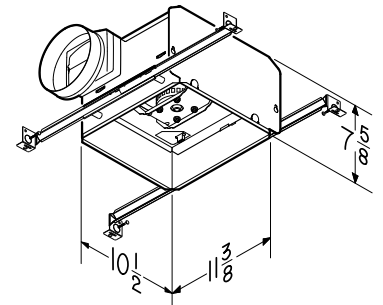

Models QTXEN150

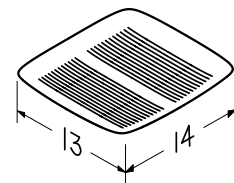
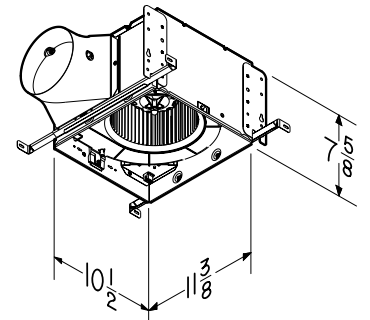

NuTone QT Series™ Bath Fans. A bath fan needn't call attention to itself, especially when you don't want it to overpower the design of your bath or powder room. More important, it shouldn't call attention to itself when it's working. So we developed the QT Series to provide our quietest bath fans yet. With an energy efficient option, it simply does its job quietly, in every sense of the word.

| Model | CFM | Sones | Bath Sq. Ft. | Ducting [▲] | ENERGY STAR® |
|-----------------|-----|-------|--------------|----------------------|--------------|
| QTXEN080 | 80 | 0.3 | 75 | 6" | Yes |
| QTXEN110 | 110 | 0.7 | 100 | 6" | Yes |
| QTXEN150 | 150 | 1.4 | 140 | 6" | Yes |

ENERGY STAR® fans use 70% less energy, on average, than standard models and may qualify for local utility rebates



▲See page 50 for ducting product specifications

QTXEN FAN LIGHT FEATURES

- Nearly silent operation 0.3 to 1.4 sones
- 80 CFM to 150 CFM
- 6" ducting for superior performance
- ENERGY STAR® qualified
- Bright, energy efficient 36 watt fluorescent lighting (2- 18 watt GU24 based bulbs) included
- 4 watt night light on all models
- Housing Packs include hanger bar system for fast and flexible installation for all types of construction
- UL Listed for use over tub or shower when installed in a GFCI protected branch circuit
- HVI Certified
- Motor engineered for continuous operation
- Type IC
- Fits 2" x 8" ceiling construction
- Models RDFQL (radiation damper) and RDJUMPQ (jumper kit) available separately



Models QTXEN080FLT, QTXEN110FLT

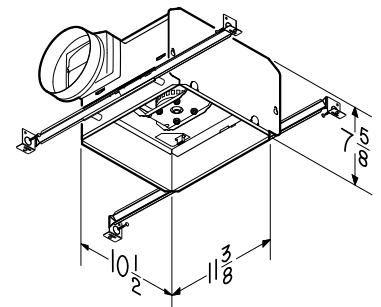

Models QTXEN150FLT

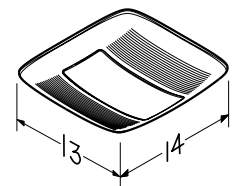
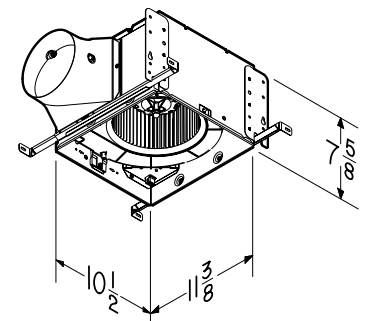

NuTone QT Series™ Fan/Lights. The QT Series is the ultimate bath fan solution for today's homes. Select a QT Series fan/light to bring simple elegance to any bath or powder room. By sight or by sound, you'll barely notice a QT Series fan. Except, of course, when you need just the right amount of ventilation and light at the touch of a switch.

| Model | CFM | Sones | Light/Night Light | Ducting [▲] | ENERGY STAR® |
|-------------|-----|-------|-------------------|----------------------|--------------|
| QTXEN080FLT | 80 | 0.3 | 36W♦ / 4W | 6" | Yes |
| QTXEN110FLT | 110 | 0.7 | 36W♦ / 4W | 6" | Yes |
| QTXEN150FLT | 150 | 1.4 | 36W♦ / 4W | 6" | Yes |

ENERGY STAR® fans use 70% less energy, on average, than standard models and may qualify for local utility rebates

♦ 2- 18 watt GU24 based fluorescent bulbs included

▲See page 50 for ducting product specifications



QTXEN AND QTXN SENSING FAN AND FAN/LIGHT FEATURES

- Detects a rapid rise in humidity
- Humidity is sensed at the ceiling level
- Easily accessible sensitivity adjustment
- Easy-to-set shut-off timer: 5–60 minutes
- Fits 2" x 8" ceiling construction
- UL Listed for use over bathtub and shower when connected to a GFCI protected branch circuit
- Includes hanger bar system for fast and flexible installation for all types of construction
- ENERGY STAR® qualified
- HVI Certified
- Radiation dampers available (see below)

QTXEN110S

QTXN110SL | QTXEN110SFL

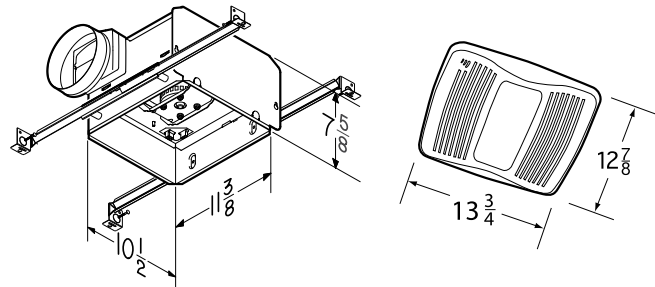
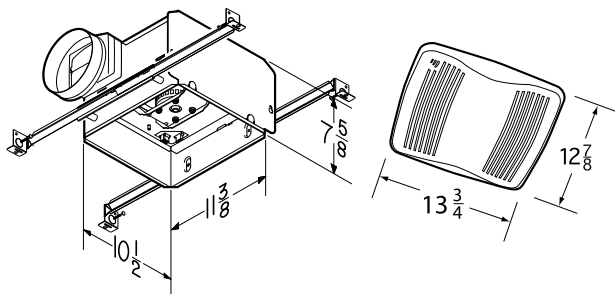

QT Series™ Humidity Sensing Fans with SensAire® Technology. NuTone SensAire® technology is a hands-free solution to fighting excess humidity and possible mold problems. Unlike competitive fans or wall controls that wait for a relative humidity set-point to be reached, SensAire® technology detects rapid increases in moisture levels at the ceiling, where steam and humidity naturally rise, and automatically turns the fan on. This means the fan reacts more quickly and clears the mirrors more quickly. With a fan this quiet, we included automatic shutoff to save worry, and money. NuTone SensAire® technology is a perfect solution for high traffic bathrooms, the kids' bathroom, or for anyone who leaves the house before humidity is properly vented.

| Model | CFM | Sones | Light/ Night Light | Bath Sq. Ft. | Ducting [▲] | ENERGY STAR® |
|---------------------|-----|-------|-----------------------|-----------------|----------------------|-----------------|
| QTXEN110S | 110 | 0.7 | — | 100 | 6" | Yes |
| QTXEN110SFLT | 110 | 0.7 | (2) 18W / 4W | | 6" | Yes |
| QTXN110SL* | 110 | 0.9 | 100W / 4W | | 6" | — |

ENERGY STAR® fans use 70% less energy, on average, than standard models and may qualify for local utility rebates.



*Does not work with Radiation Dampers

▲ See page 50 for 6" ducting (DT6W) product specifications.

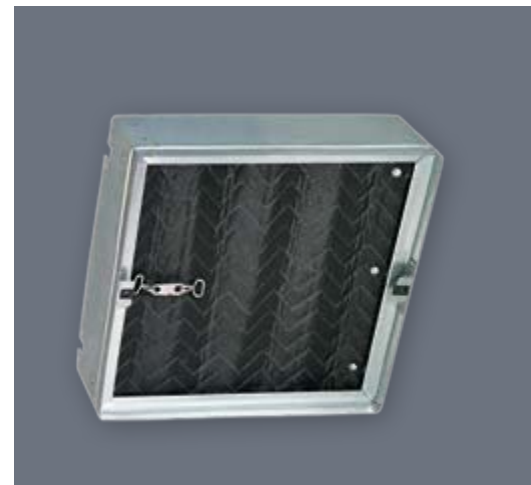

Premium Radiation Dampers

When the air temperature passing through the damper exceeds 165°F the fusible link melts, triggering the thermal fabric to automatically close across the damper. Airflow is interrupted by a flame and heat barrier, preventing the rapid spread of fire to other areas.

- Motor serviceable without disturbing drywall
- Galvanized steel frame
- High temperature, non-asbestos, reinforced fiber thermal fabric
- Stainless steel closure springs
- 165°F fusible link
- Use the same grille provided with the QT Series™ fan
- UL Standard 555C Classified

| Radiation Dampers | Description |
|---------------------------|-------------------------------|
| RDFQF | For QTXEN080 & QTXEN110 |
| RDFQL | For QTXEN080FLT & QTXEN110FLT |
| RDFQF plus RDJUMPQ | For QTXEN110S |
| RDFQL plus RDJUMPQ | For QTXEN110SFLT |

FLEXIBILITY FOR NEW CONSTRUCTION AND



INVENT SERIES FANS WITH TRUESEAL™ DAMPER TECHNOLOGY CAN SAVE UP TO 1 HERS POINT AND UP TO \$9 PER YEAR IN OPERATING COSTS*.

FoldAway™ Mounting Ears are precisely positioned for new construction and fold flat for room-side retrofits. Every installation can be handled more efficiently.



With our TrueSeal™ Damper Technology, InVent fans reduce air leakage by up to 50% compared to competitive models; resulting in better home performance via blower door tests.



EzDuct™ Connector enables room-side installation without attic access. Attach the housing, pull the duct through, attach the EzDuct™ Connector and reset it with one screw.



*Compared to competitive fans; based on software calculations and analysis conducted by Broan-NuTone Testing reflects total fan housing air tightness. †See NuTone.com/InVent for details



ROOM-SIDE RETROFIT FROM **ONE FAN.**

VERSATILE INSTALLATION. AIRTIGHT PERFORMANCE. LED LIGHTING.

InVent Series gives professionals smart options for new construction or room-side retrofits in one, hard-working product line. InVent is about innovations such as FoldAway™ mounting ears and TrueSeal™ Damper Technology that improves building airtightness like never before. With fresh grille designs and a full range of operating points, there's an InVent Series solution for every installation.

InVent™ SERIES

LED Lighting offers greater energy efficiency and longevity, and adds a unique design detail to this hard-working fan. 11 watt, 800 Lumens integrated LED module lasts up to 25,000 hours.



INVENT FAN/LIGHT FEATURES

AEN50, AEN80, AEN110, AEN80B, AN110

- Foldable mounting ears allow for easy installation in both new construction and room-side replacement
- EZDuct™ Connector allows room-side installation with no attic access required
- New damper technology forms a tighter seal to reduce backdrafts

- Effective ventilation clears humidity and odors
- Attractive grille styling
- ENERGY STAR® qualified

AEN80L, AEN80BL, AEN110L

- LED Fan/Light with 11 watt, 800 Lumens, 3000K, 80 CRI integrated module
- LED lasts up to 25,000 hours for maintenance-free convenience

AN70L, AN80L, AN110L

- Incandescent Fan/Light with A19 Base (bulb not included)

AEN50 | AEN80 | AEN110 | AEN80B | AN110

AEN80L | AEN80BL | AEN110L

AN70L | AN80L | AN110L

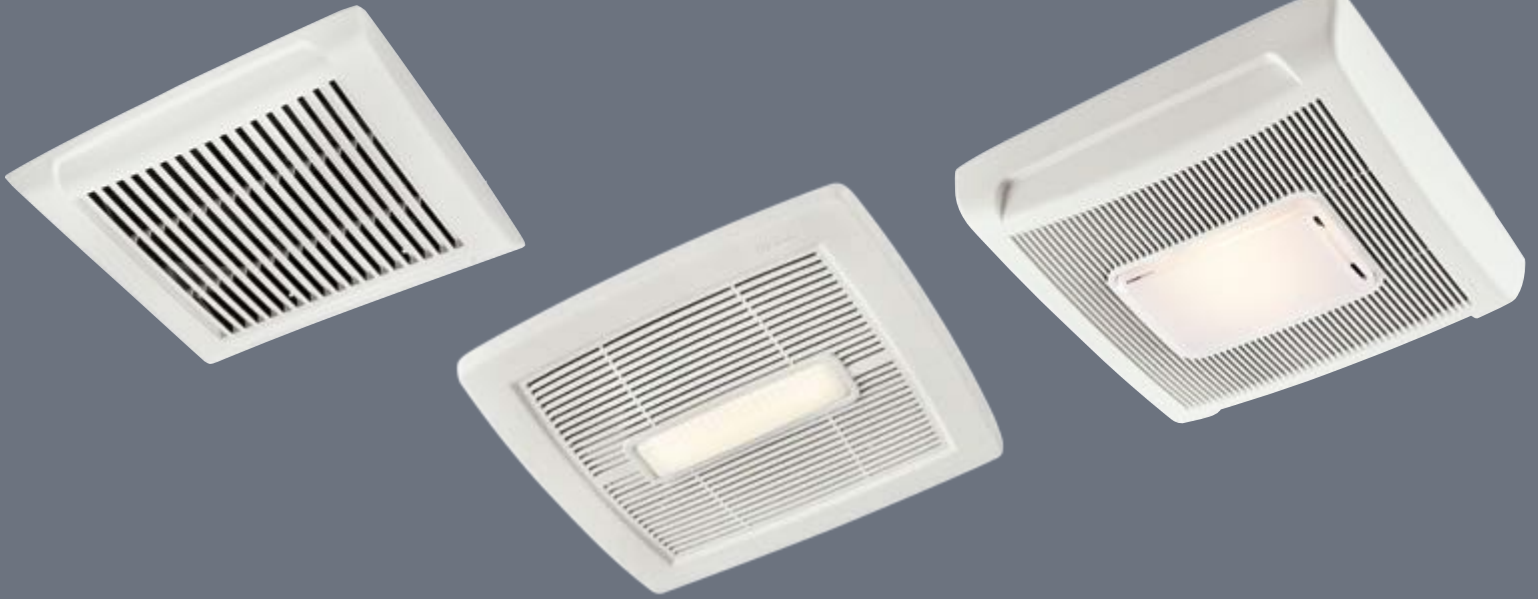

INVENT Fan Models

| Model | CFM | Sones | ENERGY STAR® |
|---------------|-----|-------|--------------|
| AEN50 | 50 | 0.5 | Yes |
| AEN80 | 80 | 0.8 | Yes |
| AEN110 | 110 | 1.3 | Yes |
| AEN80B | 80 | 1.5 | Yes |
| AN110 | 110 | 3.0 | No |

ENERGY STAR® fans use 70% less energy, on average, than standard models and may qualify for local utility rebates



INVENT Fan/Light Models

| Model | CFM | Sones | Lighting | ENERGY STAR® |
|----------------|-----|-------|------------|--------------|
| AN70L | 70 | 2.0 | A19 Base** | No |
| AN80L | 80 | 1.0 | A19 Base** | No |
| AN110L | 110 | 1.3 | A19 Base** | No |
| AEN80BL | 80 | 1.5 | LED | Yes |
| AEN80L | 80 | 0.8 | LED | Yes |
| AEN110L | 110 | 1.3 | LED | Yes |

ENERGY STAR® fans use 70% less energy, on average, than standard models and may qualify for local utility rebates



**Bulb Not Included

INVENT™ SERIES ACCESSORIES

A range of accessories ensures a custom fit in any application. Choose optional duct connectors, a radiation damper and a metal grille for commercial installations, and hanger bars for exact positioning.

MQF4

With our QFlow™ Duct Connector, InVent fans reduce air leakage by up to 65% compared to competitive models¹, offering an extremely tight seal when closed and completely open airflow when open. See NuTone.com/InVent for details.

RDM1 RADIATION DAMPER

For fans and ENERGY STAR® fan/lights only. InVent incandescent models are not compatible with radiation dampers.



MQF4 DUCT CONNECTOR



MMG METAL GRILL

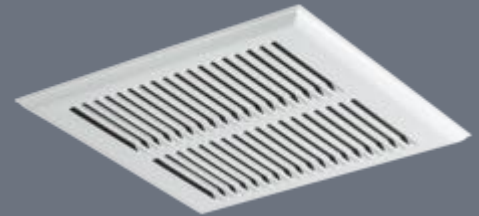

MHB4 HANGER BARS

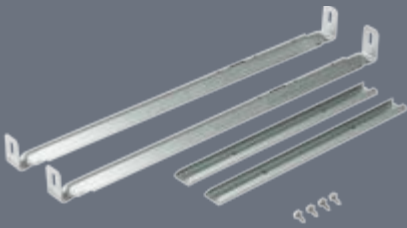

MMD4 METAL DUCT CONNECTOR



NuTone InVent™ Series Project Packs.

Keep your job on schedule and your inventory safe. Even if the final fan or fan/light product has not been selected, a project pack enables you to install a fan or fan/light housing now and choose the right-sized finish pack later. You won't have an open box on the job site with a motor and grille that could be lost or damaged.

INVENT Fan Finish Packs

| Model | CFM | Sones | ENERGY STAR® |
|----------|-----|-------|--------------|
| AN110F | 110 | 3.0 | No |
| AN80HDF* | 80 | 2.0 | No |
| AEN50F | 50 | 0.5 | Yes |
| AEN80F | 80 | 0.8 | Yes |
| AEN110F | 110 | 1.3 | Yes |
| AEN80BF | 80 | 1.5 | Yes |

ENERGY STAR® fans use 70% less energy, on average, than standard models and may qualify for local utility rebates



*Metal Grille

INVENT Fan/Light Finish Packs

| Model | CFM | Sones | Lighting | ENERGY STAR® |
|----------|-----|-------|------------|--------------|
| AN70LF | 70 | 2.0 | A19 Base** | No |
| AEN80LF | 80 | 0.8 | LED | Yes |
| AEN80BLF | 80 | 1.5 | LED | Yes |

ENERGY STAR® fans use 70% less energy, on average, than standard models and may qualify for local utility rebates



**Bulb Not Included

INVENT Housing Packs

| Model | CFM | Description |
|--------|-------|-------------------|
| A000HF | 50/80 | Fan Housing |
| A000HL | — | Fan/Light Housing |

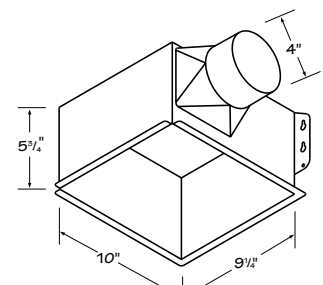

¹Testing reflects total fan housing air tightness. See NuTone.com/InVent for details.



A WELL VENTILATED ROOM IS A

HEALTHIER



LOOK TO NUTONE, THE VENTILATION EXPERTS, TO KEEP EVERY ROOM OF YOUR HOUSE FRESH.

NuTone engineers the right product to fit every application, room size and need. Select from a variety of features that best meet your spot ventilation needs. Begin by assessing how powerful the fan should be or whether you could use additional lighting in your space. Think about what product style, finish or shape would look best. Rest assured, if you're concerned about saving money and energy, NuTone bath fans that feature the ENERGY STAR® logo can reduce energy consumption by as much as 65%. NuTone has the perfect product designed around your needs.



Wall or ceiling mount, LoProfile is the right fan for a tight fit. The new NuTone LoProfile™ Fan is our latest solution for installations where conventional ventilation simply won't fit. Where multi-family applications require it, the LoProfile™ fan is narrow enough to be installed in a wall between 2x4 studs. When plumbing or electrical obstructions are found behind the drywall in ceiling remodel applications our LoProfile™ fan can still fit without having to move anything. And that means most any room with space constraints can have powerful, quiet, efficient ventilation.

ROOM.



The oval connector accepts standard 4" duct, or 3" duct with the supplied adapter.

Electrical connections can be made through the top or the side of the housing.

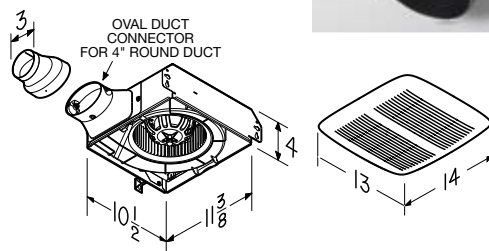

| Model | CFM | Sones | ENERGY STAR® |
|-------|-----|-------|--------------|
| LPN80 | 80 | 1.0 | Yes |

ENERGY STAR® fans use 70% less energy, on average, than standard models and may qualify for local utility rebates



FEATURES

- Fits in 2x4 ceiling or wall construction
- 80 CFM with 4" duct ensures ample air movement; 70 CFM with 3" duct reducer
- >50 CFM at 0.25" static pressure meets ASHRAE 62.2 local ventilation requirements (with 4" oval duct or 3" round duct)
- Only 1.0 sones for quiet operation (4" duct)
- 4" oval or 3" round duct connection for installation flexibility
- Efficient operation lowers utility bills

- Ideal for multi-family applications
- Compatible with RDF1 Premium Radiation Damper
- Project Packs available

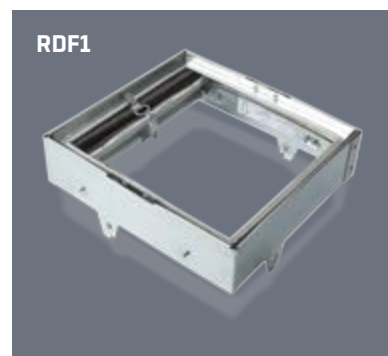

FAN/LIGHT FEATURES

668RP

- White polymeric grille
- Rectangular fan light
- Fits in 2" x 6" ceiling construction
- 24" adjustable hanger bars
- Mounting brackets that adjust for ceiling thickness up to 3/4"

FAN/LIGHT FEATURES

8663RP, 8664RP

- Round design eliminates squaring with bathroom walls
- Fits 2" x 6" ceiling construction
- 8663RP features bright 100W incandescent lighting with 7W night light for security and safety (bulbs not included)
- 8664RP features bright 100W incandescent lighting (bulb not included)
- 24" adjustable hanger bars

668RP



8663RP | 8664RP

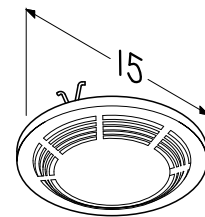
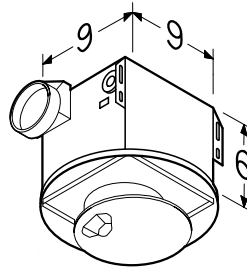
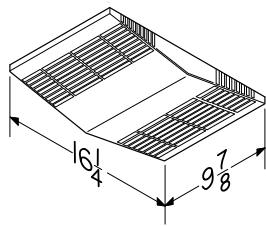
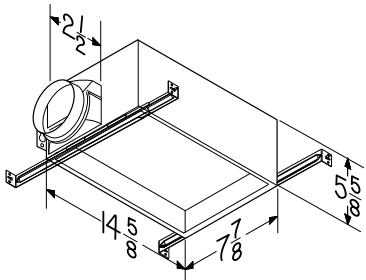

| Model | CFM | Sones | Lighting | Finish |
|---------------|-----|-------|----------|--------|
| 668RP | 70 | 4.0 | 100W | White |
| 8663RP | 100 | 3.5 | 100 / 7W | White |
| 8664RP | 100 | 3.5 | 100W | White |

FAN/LIGHT FEATURES

763

- White polymeric grille
- Fits in 2" x 6" ceiling construction
- All models available in Project Packs

FAN/LIGHT FEATURES

695, 696N

- 50 to 70 CFM centrifugal blower wheel
- Double-strength steel mounting flanges with keyhole slots for fast installation
- Metal grille kits for 695, 696N and Service Part Number S97011308
- UL Listed for use over tub or shower when installed in a GFCI protected branch circuit
- All models available in Project Packs

763



695 | 696N

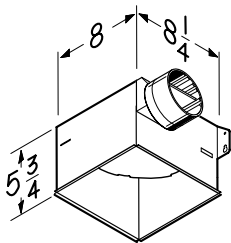

Model 763 only

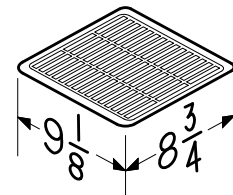
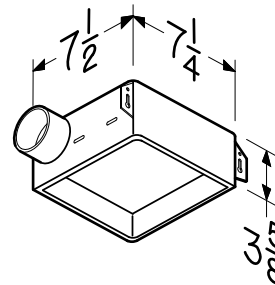
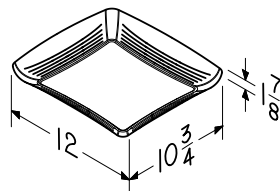

| Model | CFM | Sones | Notes | Finish |
|-------------|-----|-------|--------------------|--------|
| 763 | 50 | 2.5 | 100W | White |
| 695 | 70 | 6.0 | Wall/Ceiling mount | White |
| 696N | 50 | 4.0 | Wall/Ceiling mount | White |

Available in single packs or project packs

690NT BATH FAN UPGRADE KIT

The NuTone bath fan upgrade kit lets you convert your old bath fan to a brand new unit in just 10 minutes. Improve performance, reduce the sound level, and upgrade the appearance of your economy fan in minutes.

- Cut sound levels up to 50%
- Boost air movement up to 20%
- 10 minute installation
- 60 CFM, 3.0 Sones
- Modern white grille
- No special tools

690NT



Included: Grille; two motor plates, depending on your fan model; wrench; quieter plug-in fan motor



1. Remove old grille



3. Attach new fan and new motor plate. Install into existing housing





2. Remove old fan assembly





4. Install new grille

Measure your existing fan housing to ensure proper fit

| For use only with these bath fan models.* | Measurements | Yes | No |
|--|-----------------------|-----|----|
|  NuTone 693, 695, 696N | 7½" x 7¼" 8" x 7¼" | • | |
|  Broan 670, 671, 688, 689 | 7½" x 7¼" 8" x 8¼" | • | • |
|  Nautilus N671, N688 | 7½" x 7¼" 8" x 8¼" | • | • |

*No other usage has been tested or authorized by Broan-NuTone LLC.

NuTone 690NT Upgrade Kit replaces the models below

| If your grille looks like this: | The fan is very likely one of these models: | Housing dimensions: |
|---|---|---|
|  | NuTone 693, 695, 696N | 7½" x 7¼" or 8" x 7¼" |
|  | Broan 670, 671, 688, 689 Nautilus N671, N688 | 7½" x 7¼" Not compatible with 8" x 8¼" |



682NT DUCT FREE FAN

- Patented, fast snap-in metal housing installation
- Fan circulates air past replaceable activated charcoal filter
- Fits 2" x 4" ceiling or wall construction

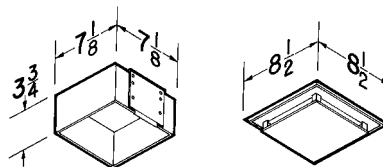

| Model | CFM | Sones | Lighting | Notes |
|------------------|-----|-------|----------|-----------------------|
| 682NT | — | — | — | Duct-free Circulation |
| S97009563 | — | — | — | Replacement filter |

Duct-free. This easy-to-install solution is ideal where air circulation is needed but ducting is impossible or impractical. Use it as a solution for half baths or rooms where humidity isn't a concern.

QUALITY VENTILATION THAT COMPLEMENTS YOUR DÉCOR.

Every room needs ventilation, from closets to bedrooms to baths. But adding a fan/light combination that complements or enhances the room décor has been challenging. That's why the NuTone Architectural products are perfect. Imagine a fan/light combination fixture that unobtrusively blends into the ceiling. Or a statement fan/light with a stunning LED perimeter glow that showcases your unique décor. The Architectural series helps you meet your decorating challenges without compromising your style.

VENTILATION THAT MOVES IN RATHER



THE AIR MOVING WAYS.

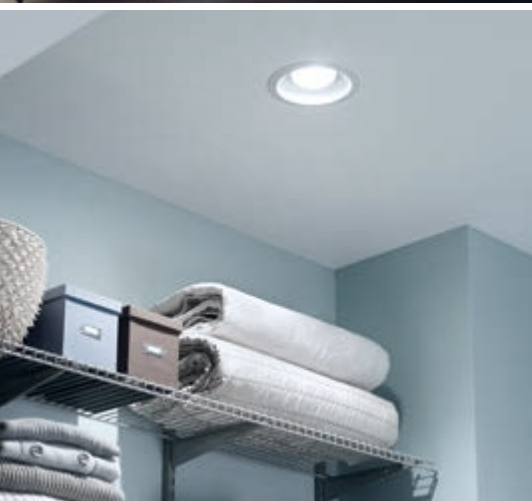
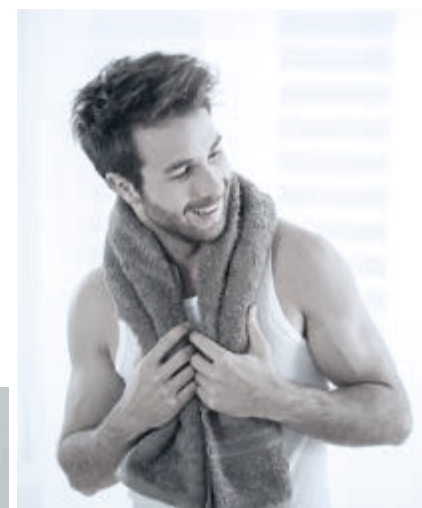
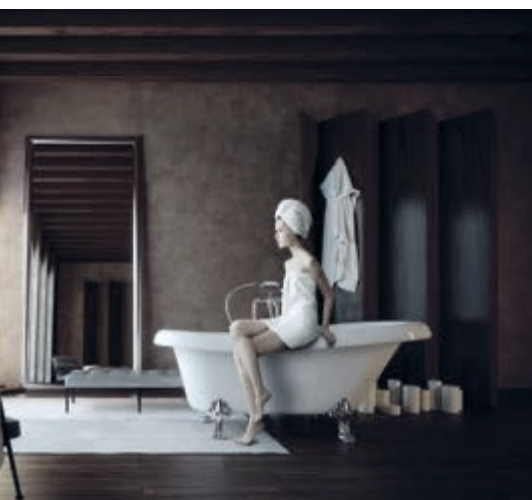

744 SERIES RECESSED FAN/LIGHT FEATURES

- High efficiency centrifugal fan
- 70 CFM at 1.5 sones
- Trim matched to designs of major recessed light manufacturers
- Put multiple units in larger rooms
- Model 744 uses a standard A19 base (R30 or BR30 for standard applications)
- Models 744FL and 744SFL include a 16 watt, GU24 based, R30 shaped CFL bulb (included)
- Model 744LED includes a 14 watt, GU24 based LED bulb (included)
- All models UL Listed for use over bathtub or shower when connected to a GFCI protected branch circuit. Model 744 requires a PAR30L or PAR30LN type bulb (not included)
- 6 $\frac{7}{8}$ " high housing appropriate for new construction and 2" x 8" ceiling joists
- 4" round duct connector
- Optional wall control switches available
- Type IC, sealed housing
- Not for use over cooking surfaces

Humidity Sensing Model 744SFL Features

- SensAire[®] technology detects the rapid rise in humidity and automatically turns the fan on and off
- Humidity is sensed at the ceiling level
- Easily accessible sensitivity adjustment
- Easy-to-set 5-60 minute shut-off timer

744 SERIES

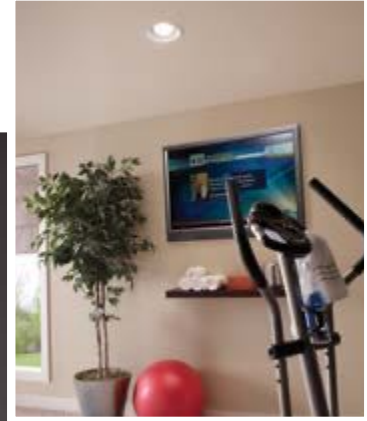

**YOU'D NEVER KNOW
IT'S A FAN, AND THAT'S THE POINT**

SensAire[®] technology behind the trim detects changes in humidity and automatically turns the fan on and off.

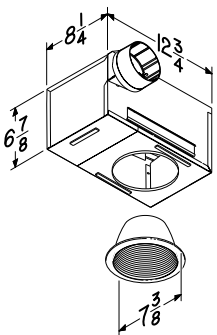

| Model | CFM | Sones | Lighting | Humidity Sensing | Ducting | ENERGY STAR [®] |
|-----------------|-----|-------|------------|------------------|---------|--------------------------|
| 744NT | 70 | 1.5 | 75W MAX | — | 4" | — |
| 744FLNT | 70 | 1.5 | 16W Fluor. | — | 4" | Yes |
| 744LEDNT | 70 | 1.5 | 14W LED | — | 4" | Yes |
| 744SFLNT | 70 | 1.5 | 16W Fluor. | Yes | 4" | Yes |

ENERGY STAR[®] fans use 70% less energy, on average, than standard models and may qualify for local utility rebates



FAN WITH SOFT SURROUND™ TECHNOLOGY FEATURES

- LED lasts up to 25,000 hours, nearly eliminating the hassle of bulb replacement
- 9 watt lighting for extreme energy efficiency
- Bright 800 lumen integrated LED light engine for energy efficiency
- 3000K color temperature provides bright, soft light ideal for bathrooms
- Minimum 80 Color Rendering Index (CRI) which meets ENERGY STAR® requirements
- Fits in 2"x 6" ceiling construction
- 110 CFM for strong air movement
- 1.5 sones for quiet operation
- ENERGY STAR® qualified
- 4" duct connector balances powerful, quiet operation with easy installation
- UL listed for use over bathtubs and showers when connected to a GFCI protected branch circuit
- Type IC for use in direct contact with thermal insulation

791LEDNTM

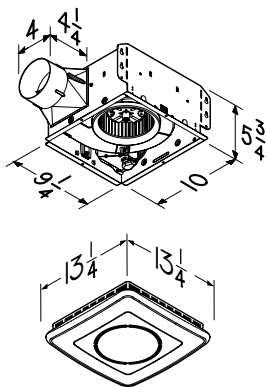

| Model | CFM | Sones | Lighting | HVI | Ducting | ENERGY STAR® |
|-----------|-----|-------|----------|-----|---------|--------------|
| 791LEDNTM | 110 | 1.5 | 9W LED | Yes | 4" | Yes |

ENERGY STAR® fans use 70% less energy, on average, than standard models and may qualify for local utility rebates



A unique design that's attractive and efficient.

The new NuTone® ventilation fan with Soft Surround™ LED lighting technology is our latest innovation in lighting technology. Soft lighting is a result of high quality lens diffusion, eliminating typical LED hotspots for even, consistent and bright illumination. The unique perimeter lens surrounds the grille to provide broader light coverage, better illuminating the entire room. The LEDs last up to 25,000 hours, nearly eliminating the hassle of bulb replacement. Additionally, the grille's distinctly low-profile design installs close to the ceiling for an unobtrusive look that is perfect for an upgrade to your current fan light. Interested? Contact NuTone at 800-558-1711 for a distributor near you or visit NuTone.com.

NuTone LunAura™ Collection. Transform any room into a unique, calming space.

The transitional design of the NuTone LunAura™ Collection is apparent the moment you see it with a green-tinted light panel suspended below the ventilation fan. When the LED night light is activated, the plate turns blue with a stunning glowing edge. Blue was selected for its calming effect, and with Ultra Silent™ ventilation, NuTone LunAura™ Collection is a perfect way to create a spa-like environment. It also provides safety and navigation for nighttime tasks while still allowing you to return to restful sleep. For stunning ventilation in any room, nothing's quite as flexible as the NuTone LunAura™ Collection, because there's never been anything like it.



Transform any room into a unique, calming space.

Long-life, energy-efficient blue LED.



Two fluorescent bulbs provide the output of two 75 watt incandescent bulbs.

NUTONE LUNAURA COLLECTION FAN/LIGHT FEATURES

- 110 CFM at 0.7 Sones
- ENERGY STAR® qualified
- Bright 36 watt fluorescent main lighting (2- 18 watt GU24 bulbs included)
- 6" or 4" ducting connections
- Blue LED night light
- HVI certified
- Motor engineered for continuous operation
- UL listed for use over bathtub or shower when connected to a GFCI protected branch circuit
- Fits 2" x 8" ceiling construction
- Use with 78V or 78W switch

QTNLEDB FAN/LIGHT



QTNLEDA FAN/LIGHT

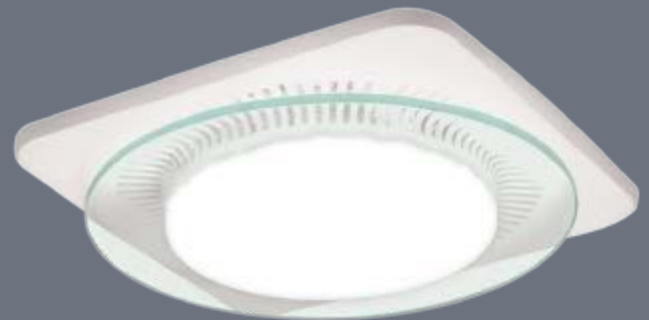

Rotate the green-tinted plate 45° to create a jewel-like diamond appearance.

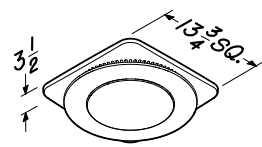
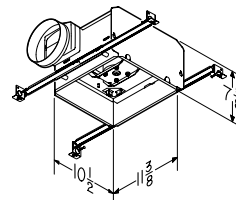
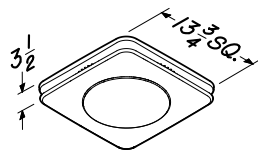
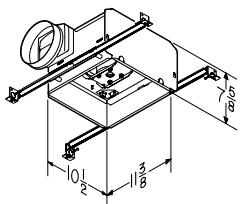

| Model | CFM 0.1" | Sones | Lighting | Ducting |
|----------|----------|-------|-------------------------------------|----------|
| QTNLEDA* | 110 | 0.7 | Two 18 watt, GU24 fluorescent bulbs | 6" or 4" |
| QTNLEDB* | 110 | 0.7 | Two 18 watt, GU24 fluorescent bulbs | 6" or 4" |

ENERGY STAR® fans use 70% less energy, on average, than standard models and may qualify for local utility rebates

*0.9 sones with 4" ducting





EVERY ROOM CAN BE MORE COMFORTABLE WITH A LITTLE VENTILATION.

THERE'S A NUTONE VENTILATION SOLUTION FOR EVERY ROOM IN YOUR HOME. Without doubt, every room needs ventilation. That's why our specialty lines deliver clean, fresh air where you need it most—including your bathrooms, laundry room, recreation room, workshop or nursery. Look to our room-to-room, wall/ceiling mount, through-wall or vertical discharge utility fans for powerful spot ventilation. Or, install our remote mounted in-line ventilation system for a quiet whole-house solution. Our recessed fan/lights perfectly match other recessed fixtures, including humidity sensing options that start automatically when a rapid rise in humidity is detected. Elegant, simple, practical and powerful. Exactly what you've come to expect from NuTone.

Wall/Ceiling Mount—Vertical/Horizontal Discharge Eliminate humidity or tobacco smoke from recreation rooms or workshops with these powerful utility ventilators. All feature powerful, permanently lubricated motors and rugged steel housings.

WALL/CEILING MOUNT—VERTICAL/HORIZONTAL DISCHARGE FEATURES

8210 Ceiling Mount, Vertical Discharge

- Ventilates directly through the roof with round ducting
- Paintable engineered resin grille installs with a single screw
- Adjustable hanger bars for 16" or 24" O.C. joists
- Motor mounting bracket has two slots that slide over two mounting screws on sleeve for faster installation
- Specially designed transition-type housing reduces diameter of discharge opening to fit 7" round duct; no reducer is needed
- UL Listed for use in cooking areas

8310 Wall/Ceiling Mount, Side discharge only

- 3¼" x 10" duct, side discharge
- Paintable engineered resin grille installs easily
- Motor assembly offers fast easy "twist-lock" installation
- Specially designed fan blade stays in balance—will not distort
- Installs easily in walls or ceiling
- Built-in backdraft damper
- Adjustable mounting brackets span from 14" to 24" O.C. joist
- UL Listed for use in cooking areas

QT200 & QT300 Ceiling Mount

- Sturdy galvanized steel housing is lined with sound-deadening foam for quiet operation
- Low RPM motor plugs into prewired junction box
- Motor and twin blowers dynamically balanced for smooth, quiet operation
- Vents horizontally or vertically with 3¼" x 10" duct
- Duct collar with quiet backdraft damper included
- Installs easily between 16" O.C. joist with slotted mounting bracket. Slots on housing sides provide alternative mounting
- Wiring knockouts located on top and back of housing

8210 CEILING MOUNT, VERTICAL DISCHARGE



8310 WALL/CEILING MOUNT, SIDE DISCHARGE ONLY



QT200 | QT300 CEILING MOUNT

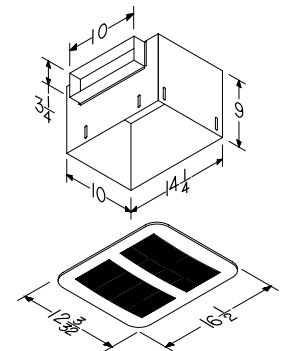
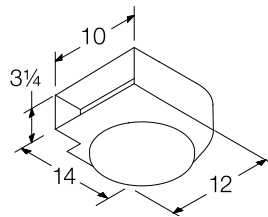
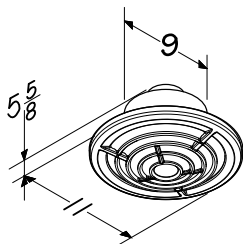

| Wall/Ceiling | CFM | Sones | Ducting | Notes |
|--------------|-----|-------|-----------|-------------------------|
| 8210 | 210 | 6.5 | 7" | Vertical Discharge Only |
| 8310 | 160 | 5.0 | 3¼" x 10" | Rectangular Duct |
| QT200 | 200 | 2.0 | 3¼" x 10" | Rectangular Duct |
| QT300 | 300 | 4.5 | 3¼" x 10" | Rectangular Duct |

IN-LINE VENTILATORS FEATURES

- Energy-efficient, permanently lubricated motors
- High pressure centrifugal blowers easily accommodate long duct runs
- Designed for quick, easy installation
- HVI certified
- Suitable for intermittent or continuous ventilation applications
- Removable panel offers easy access to the electrical connections

ILF120, ILRF In-Line Fans / Radon Mitigation

- Great solution for large, open spaces
- Install in virtually any orientation
- Radon Mitigation
- UL Listed for commercial applications



With an In-line ventilation solution, the blower is mounted away from the living area for virtually silent operation. These fans are ideal for ventilating larger rooms with multiple inlet ports.

ILF120



ILRF



| Model | CFM | Ducting | ENERGY STAR® |
|--------|-----|----------|--------------|
| ILF120 | 110 | 4" | Yes |
| ILF130 | 120 | 5" | Yes |
| ILF250 | 230 | 6" | Yes |
| ILF360 | 360 | 8" | — |
| ILF530 | 530 | 10" | — |
| ILRF* | 140 | 4" or 5" | — |

ENERGY STAR® fans use 70% less energy, on average, than standard models and may qualify for local utility rebates



*ILRF rated 140 CFM at 0.2" WG, 43 CFM at 1.5" WG

Remote Mounted In-Line Ventilation Fans are quiet and efficient residential solutions. The concept is simple: mount a high-performance ventilator in an out-of-the-way spot and you get the power with virtually no sound. Install the housing in the attic or the basement, wherever it's most convenient and discrete.

| Model | A: Duct Collar | B: Height | C: Fan Diameter |
|--------|----------------|-----------|-----------------|
| ILF120 | 37/8" | 10" | 10" |
| ILF130 | 47/8" | 73/4" | 10" |
| ILF250 | 57/8" | 93/8" | 12" |
| ILF360 | 77/8" | 135/8" | 131/2" |
| ILF530 | 97/8" | 111/4" | 131/2" |
| ILRF | 37/8"/47/8" | 10" | 10" |

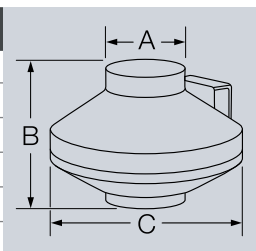

IN-LINE FAN KITS FEATURES

- Kits include all components to install a single exhaust system (except wall control, wire and ducting)
- Each kit includes fan, grille, sleeve with damper and duct clamps
- Model ILFK2502 contains 2 grilles (model CVG6) and a 3-way 6" Y adapter (model FY6)

ILFK2502



In-Line Fan Kits

| Model | CFM | Ducting | ENERGY STAR® |
|----------|-----|---------|--------------|
| ILFK120 | 110 | 4" | Yes |
| ILFK130 | 120 | 5" | Yes |
| ILFK250 | 230 | 6" | Yes |
| ILFK2502 | 230 | 6" | Yes |

ENERGY STAR® fans use 70% less energy, on average, than standard models and may qualify for local utility rebates



| Model | A: Duct Collar | B: Height | C: Fan Diameter |
|----------|---------------------------------|---------------------------------|-----------------|
| ILFK120 | 3 ⁷ / ₈ " | 10" | 10" |
| ILFK130 | 4 ⁷ / ₈ " | 7 ³ / ₄ " | 10" |
| ILFK250 | 5 ⁷ / ₈ " | 9 ³ / ₈ " | 12" |
| ILFK2502 | 5 ⁷ / ₈ " | 9 ³ / ₈ " | 12" |

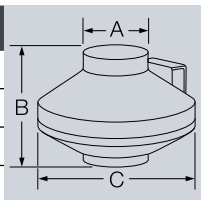

ACCESSORIES

ILFK2502



Accessories

| | Ducting | Size | Notes |
|------------------------|---------|-------------------------------------|-----------------------|
| Y Adapter | | | |
| FY6 | | 6" x 6" x 6" | — |
| Grilles/Intakes | | | |
| CVG4* | 4" | 6" Dia. | Round Grille |
| CVG6* | 6" | 7 ³ / ₄ " Dia | Round Grille |
| Sleeves | | | |
| CVLD4 | 4" | — | Sleeve with Damper |
| CVLD6 | 6" | — | Sleeve with Damper |
| CVL4 | 4" | — | Sleeve without Damper |
| CVL6 | 6" | — | Sleeve without Damper |

*Available in six packs only



INSTANT HEAT, RIGHT WHEN YOU AND ONLY WHERE YOU WANT IT.

POWERFUL HEATING, LIGHT AND VENTILATION AT THE TOUCH OF A SWITCH.

No matter where you live your house can become chilled. Maybe it's early fall before the furnace is on, or maybe the cool desert nights mean colder rooms. And there's certainly one room you never want to be chilly—the bathroom. Whether it's taking a morning shower, or relaxing in a whirlpool at the end of a long day, your family appreciates a warm, comfortable bathroom. NuTone heater/fan/lights are the perfect solution. You have instant heat to quickly warm up the room, a quiet ventilation fan to remove excess humidity and a convenient light—all in one fixture. Each one can be operated separately, or they can be used simultaneously when needed, no furnace required.



NEED IT.

QT SERIES FEATURES

- Efficient PowerHeat™ heater design
- Choice of standard A19 base lighting (bulb not included) or energy-efficient 36 watt GU24 fluorescent (bulbs included)—see chart below
- Fan motor is engineered for continuous operation
- HVI Certified
- Type IC
- Requires a dedicated 20 amp circuit
- Switches sold separately

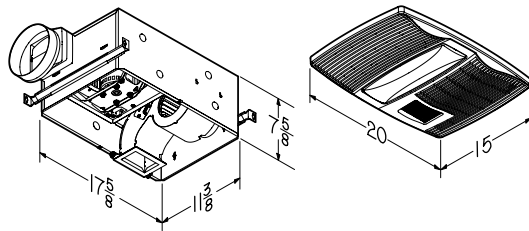

PowerHeat™ is a NuTone design that maximizes heat output per watt. With the heater element close to the forced air exit grille, the internal components are not heated. Heat is delivered into the room and does not escape into the ceiling or attic space.

Heater/Fan/Light

| Model | CFM | Sones | Bath Sq Ft. | Lighting/ Night Light | Heater Watts | Ducting |
|--------------------|-----|-------|-------------|---|--------------|---------|
| QTXN110HL | 110 | 0.9 | 100 | 2- 60 watt max Std. A19 Base**/ 7W** | 1500 | 6" |
| QTXN110HFLT | 110 | 0.9 | 100 | 36W Fluorescent (2- 18W)* / 7W | 1500 | 6" |

*Bulbs included

**Bulbs not included



DIRECTIONALLY ADJUSTABLE HEATER/FAN LIGHT FEATURES:

- Heater/Fan/Light brings convenient, comforting warmth to your bathroom
- Quiet, high-output heater with exclusive directionally adjustable design (see below)
- 4" ducting for new construction or retrofit
- Multi-function wall switches sold separately
- Choice of standard A19 base or energy-efficient 27 watt GU24 (bulb included) fluorescent lighting
- Fan motor is engineered for continuous operation
- HVI Certified
- Type IC
- Requires a dedicated 20 amp circuit
- Fits 2" x 6" ceiling construction

765HL | 765HFL

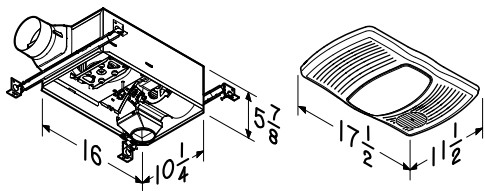

Heater/Fan/Lights

| Model | CFM | Sones | Bath Sq. Ft. | Lighting/Night Light | Heater Watts | Ducting |
|----------------|-----|-------|--------------|-----------------------|--------------|---------|
| 765HL* | 100 | 2.0 | 90 | 100W Incandescent | 1500 | 4" |
| 765HFL* | 100 | 2.0 | 90 | 27W, GU24 Fluorescent | 1500 | 4" |

*Switch not included. See selection guide on pages 46-49



HEATER/FAN LIGHT FEATURES:

- Fits in 2" x 6" ceiling construction
- 1300W heating element provides optimum performance in smaller spaces
- Bright 100W incandescent light capacity
- Designer white polymeric grilles complement virtually any décor
- Fan, light and heater function independently or together

665RP

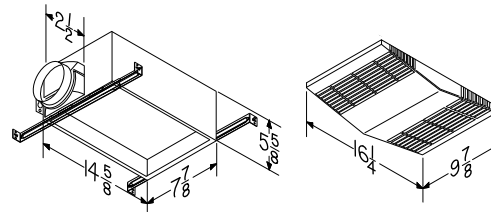

HEATER/FAN FEATURES:

- Fits in 2" x 6" ceiling construction
- 1300W heating element provides optimum performance in smaller space
- Improved hanger bar locks position after securing unit to rafters

605RP

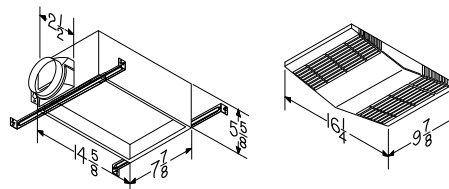

| Model | CFM | Sones | Lighting | Heat | Finish |
|--------------|-----|-------|----------|-------|-----------------|
| 665RP | 70 | 4.0 | 100 | 1300W | White Polymeric |
| 605RP | 70 | 4.0 | — | 1300W | White Polymeric |

COMBINATION HEATER FANS FEATURES:

9905

- Fan-forced heat and exhaust fan only
- Includes two-function switch
- 1500 watts

9960

- Fan-forced heat, ceiling and night light
- Includes one multi-function control and one single-function control
- 1500 watts

9965

- Fan-forced heat, exhaust fan, ceiling and night light
- Includes two multi-function controls
- 1500 watts

9905



9960



9965

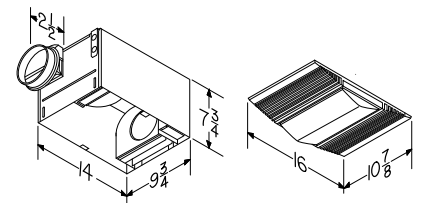
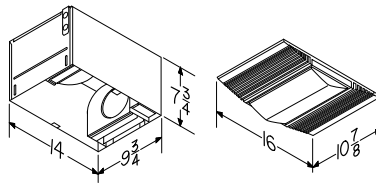
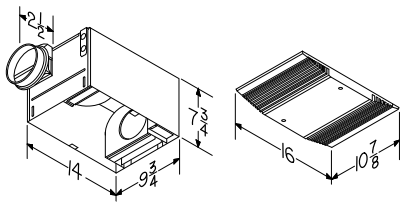

| Model | CFM | Sones | Lighting | Heat | Wall Switch |
|-------|-----|-------|----------|-------|-------------|
| 9905 | 70 | 4.0 | — | 1500W | 2-function |
| 9960 | — | — | 100 / 7 | 1500W | 3-function |
| 9965 | 70 | 4.0 | 100 / 7 | 1500W | 4-function |

9093 SERIES FEATURES

- Powerful ventilation
- Extra-quiet operation
- Bright ceiling light
- Convenient night light
- White enamel grille
- 1500 watts of powerful heat
- Includes a four-function wall switch
- Fits 2" x 8" ceiling construction

QT9093WH



9093WH

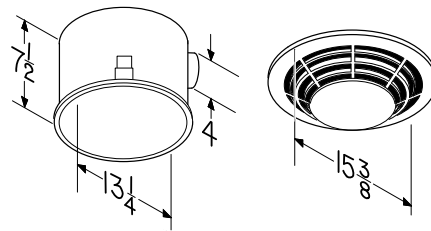
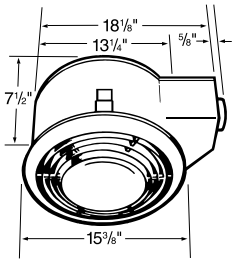

| Model | CFM | Sones | Lighting | Heat |
|-----------------|-----|-------|----------|-------|
| QT9093WH | 110 | 3.0 | 100/7 | 1500W |
| 9093WH | 70 | 3.5 | 100/7 | 1500W |

BULB HEATER/FAN FEATURES

- Quiet, highly efficient polymeric blower wheels
- Polymeric dampers prevent backdrafts and eliminate mechanical noise
- Polymeric 4" round duct connectors with tapered sleeves simplify ducting
- Operate fan and heater independently or together
- Attractive white polymeric grilles
- Compact steel housings with adjustable mounting brackets with keyhole slots that span up to 24"
- 250 watt R40 or BR40 size infrared bulbs (not included)
- Type IC, UL Listed for 60°C wiring (retrofits)
- **9417DN:** One-Bulb Heater/Fan
- **9427P:** Two-Bulb Heater/Fan, Two-function control (available separately)

ONE OR TWO-BULB HEATERS—NO FAN

- Infrared bulbs deliver energy-saving warmth
- Get instant comfort in the bathroom without turning up the central thermostat
- 250 watt R40/BR40 size infrared bulbs (not included)
- Attractive, white polymeric grilles
- Compact steel housings
- Adjustable mounting brackets with keyhole slots span up to 24"
- **9412D:** One-Bulb Heater, UL Listed for 75°C wiring
- **9422P:** Two-Bulb Heater, Type IC

9417DN



9427P



9412D



9422P

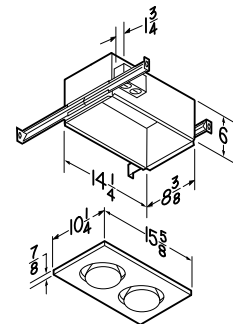
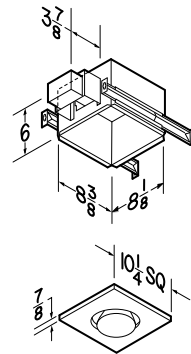
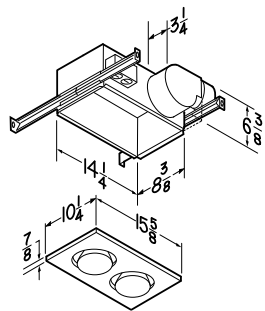
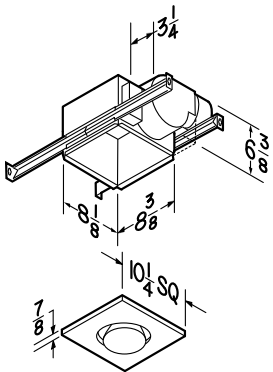

Bulb Heater Fans. Silent warmth and superior ventilation.

Trust NuTone Bulb Heater/Fans and Bulb Heaters for energy-saving warmth and instant comfort without ever having to touch your central thermostat. These units deliver superior performance and excellent ventilation in a compact package.

Bulb Heater/Fan & Bulb Heaters

| Model | CFM | Sones | Bulb Watts |
|----------------|-----|-------|------------|
| 9417DN | 70 | 3.5 | 250 |
| 9427P | 70 | 3.5 | 500 |
| 9412D** | — | — | 250 |
| 9422P | — | — | 500 |

Bulbs not included. **Not IC rated

THE PERFECT CONTROL SOLUTION FOR EVERY ROOM AND NEED.



INDICATOR LIGHT CONTROL FOR CONVENIENCE

INDICATOR LIGHT CONTROLS

Model 269WL, 269VL

- Two-Function Controls
- For use especially with quiet models and an auxiliary light source
- Lighted fan control 120V, 20 amps; unlighted 120/240/277V, 15 amps
- Fits two-gang box
- Controls available in White (W) or Ivory (V)



Model 685WL

- Three-Function Controls
- For use especially with quiet models
- Lighted fan control 120V, 20 amps; two additional on/off rocker switches 120V, 15 amps each (20 amps total)
- Fits two-gang box
- Blister packs available P685WL
- Available in White (W)



THERMOSTAT AND HUMIDITY CONTROLS

NEW Model 82W

- SensAire® technology responds to humidity up to 70% faster than competitive models; setpoint mode satisfies CA requirements
- Continuous ventilation mode helps to meet ASHRAE 62.2
- Compatible with any existing fan within electrical ratings
- Available in white; faceplate not included
- 120V, 4 amp



Model 70TW

- Thermostat for any fan
- 120, 250, 277 VAC,
- 22 amp capacity
- Fits single-gang box only



Model DH100W

- Dehumidistat
- Dual voltage (24V/120V)
- Variable setting from 20-80% relative humidity
- Usage guide included
- Fits single-gang box only



MULTI-FUNCTION / LIGHTED CONTROLS

Model 66W, 66V, 67W, 67V

- Three-Function Controls
- Three independent, 120V, 15 amp rocker switches (20 amps total)
- Fits single-gang opening
- Controls available in White (W) or Ivory (V)
- Blister pack available, P66W, 66V



Model 68W, 68V

- Two-Function Controls
- Two independent, 120V, 15 amp rocker switches (20 amps total)
- Fits single-gang box
- Controls available in White (W) or Ivory (V)
- Blister pack available, P68W



Model 77DW, 77DV

- Four-Function Controls
- Single switch provides three settings for fan sensor (On-Auto-Off) on Sensing models
- Remaining switches for light/night light
- Works with QTXN110HL heater/fan/light/night light
- Controls available in White (W) or Ivory (V)
- Fits single-gang opening
- Blister pack available, P77DW





MULTI-FUNCTION CONTROL TO SUIT EVERY NEED



SPEED CONTROL FOR QUIETER OPERATION OR FULL POWER



HUMIDITY SENSING TO HELP PREVENT FOGGY MIRRORS

SPEED CONTROLS

Model 57W, 57V

- 120V, 3 amps
- Fits single-gang box
- Positive on/off action—dial for variable selection of air speeds and sound levels
- Built-in radio noise suppressor
- Controls available in White (W) or Ivory (V)
- Blister pack available (P57W)



Model 78W, 78V

- 4-speed "no-hum" ceiling fan speed control
- Decorator wall plate
- Screws included
- 120V AC 1.5 amp
- Controls available in White (W) or Ivory (V)



Model 72W, 72V

- 120V, 6 amps
- Fits single-gang box
- Positive on/off action—dial for variable selection of air speeds and sound levels
- Built-in radio noise suppressor
- Controls available in White (W) or Ivory (V)



TIMER AND OFF-DELAY CONTROLS

Model VS63WH

- 15-minute timer
- For all NuTone heaters and fans except Pull-Chain type
- 20 amps



TIMER AND OFF-DELAY CONTROLS

Model 64W, 64V

- Fan/Light Control with Off-Delay
- Fan and light operate together when control is turned on
- Fan continues to operate for a user adjustable time period 5–60 minutes after light is turned off
- Center position bypasses timer and turns fan and light off immediately
- Fits single-gang box
- 120V, 4 amps (fan), 4 amps (light)
- Requires hot and neutral wires in the switch box
- Controls available in White (W) or Ivory (V)



Model CFT12WH

- 12-hour time switch
- Rotary dial
- 20 amps



Model 59W, 59V, 71V*

- Model 59W, 59V—up to 60 minutes
- Model 71V—up to 12 hours
- Fits single-gang box
- 120V, 20 amps; 240V, 10 amps
- Operate continuously or for any set period
- Controls available in White (W) or Ivory (V)
- Blister packs available (P59W, P59V)



Model VS66WH

- 60-minute timer
- Separate on/off control
- For two-gang outlet box
- Timer controls any NuTone heater or Ventilator
- On/Off section can be used for a separate light, vent or heater



Model VS67WH

- 60-minute timer
- Separate on/off controls
- For two-gang outlet box
- Timer section may control any NuTone heater or Ventilator
- On/Off section can be used for a separate light, vent or heater



Model VS68WH

- 15-minute timer
- Separate on/off control
- For two-gang outlet box
- Timer controls any NuTone heater or Ventilator
- On/Off section can be used for a separate light, vent or heater



Model VS69WH

- 15-minute timer
- Separate on/off controls
- For two-gang outlet box
- Timer controls any heater or Ventilator
- On/Off section can be used for a separate light, vent or heater



SELECTION GUIDE

| | | 57W, 57V | 59W | 64W, 64V | 66W, 66V | 68W, 68V | 69WL, 69VL | 70TW | 72W, 72V | 77DW, 77DV | 78W, 78V | 269WL, 269VL | 685WL | CFT12WH | 82W, DH100W | VS63WH | VS66WH | VS67WH | VS68WH | VS69WH | |
|------------------------|----------------------------|-------------|-----|-------------|-------------|-------------|---------------|------|-------------|---------------|-------------|-----------------|-------|---------|----------------|--------|--------|--------|--------|--------|---|
| Ventilation Fans | 682NT | | • | • | | | | | | | | | | • | | • | | | | | |
| | 695, 696N | • | • | • | | | | | • | | | | | | • | • | • | | | | |
| | LPN80 | • | | • | | | • | | • | | | | | | • | | | | | | |
| | QT Fans* | • | • | • | | | • | | • | | • | • | | | • | • | • | | | | |
| | QTXEN110S | | | | | | • | | | | • | | | | | | | | | | |
| | RN80, RN110 | • | • | • | | | • | | • | | • | • | | | • | • | • | | | | |
| | XN110H | | | | | • | • | | | | | | | | | | | | | | |
| | XN50, XN80, XN110 | | | • | | | • | | | | | | • | | • | | | | | | |
| | ZN110H | | | | | | • | | | | | | | | | | | | | | |
| | ZN80, ZN110 | | | | | • | | | | | | | • | • | | | | | | | |
| | ZN80M, ZN110M | | | | | • | • | | | | | | | | | | | | | | |
| Ventilation Fan/Lights | 668RP | • | • | • | | • | | | • | | | | | | • | • | • | | | • | |
| | 744NT, 744FLNT | | • | | | • | | | | | | | | | • | • | | • | | • | |
| | 744SFLNT | | • | | | • | | | | | | | | | | • | | • | | • | |
| | 763 | | • | • | | • | | | | | | • | | | • | • | | • | | • | |
| | 791LEDNT | • | • | • | | • | | | • | | | • | | | • | • | | • | | • | |
| | 8663RP | • | | • | • | | | | • | | | • | | | • | • | | | • | | • |
| | 8664RP | • | • | • | | • | | | • | | | • | | | • | • | | • | | • | |
| | QT Fan/Lights | • | | • | • | | | | • | | | • | • | | • | • | | | • | | • |
| | QTNLEDA, QTNLEDB | • | | • | • | | | | • | | • | | | | • | • | | | • | | • |
| | QTXEN110SFLT, QTXN110SL | | • | | | | | | | • | | | | | | | | | | | |
| | RN80L, RN110L | • | | • | • | | | | • | | | • | • | | • | • | | | • | | • |
| | XN110HL | | | | • | | | | | • | | | | | | | | | | | |
| | XN50L, XN80L, XN110L | | | | • | | | | | | | • | • | | • | | | | | | |
| | ZN110HL | | | | • | | | | | | | | | | | | | | | | |
| | ZN80L, ZN110L | | | | | | | | • | | | • | | | | | | | | | |
| | ZN80ML, ZN110ML | | | | | | | | • | | | | | | | | | | | | |

*Does not include models QT200 and QT300

| | | 57W, 57V | 59W | 64W, 64V | 66W, 66V | 68W, 68V | 69WL, 69VL | 70TW | 72W, 72V | 77DW, 77DV | 78W, 78V | 269WL, 269VL | 685WL | CFT12WH | 82W, DH100W | VS63WH | VS66WH | VS67WH | VS68WH | VS69WH |
|-------------------------------|----------------------|-------------|-----|-------------|-------------|-------------|---------------|------|-------------|---------------|-------------|-----------------|-------|---------|----------------|--------|--------|--------|--------|--------|
| InVent Ventilation Fans | AEN80 | • | • | • | | | • | | • | | | • | | | • | • | • | | • | |
| | AEN110 | • | • | • | | | • | | • | | | • | | | • | • | • | | • | |
| | AEN80B | • | • | • | | | • | | • | | | • | | | • | • | • | | • | |
| | AEN50 | • | • | • | | | • | | • | | | • | | | • | • | • | | • | |
| | AN110 | • | • | • | | | • | | • | | | • | | | • | • | • | | • | |
| | AN80L | • | | • | | • | | | • | | | • | | | • | | • | | • | • |
| | AN110L | • | | • | | • | | | • | | | • | | | • | | • | | • | • |
| | AN70L | • | | • | | • | | | • | | | • | | | • | | • | | • | • |
| | AEN80BL | • | | • | | • | | | • | | | • | | | • | | • | | • | • |
| | AEN80L | • | | • | | • | | | • | | | • | | | • | | • | | • | • |
| | AEN110L | • | | • | | • | | | • | | | • | | | • | | • | | • | • |
| Heater/ Fan/Lights | 605RP | • | • | | | • | | • | • | | | | | | | • | • | | • | |
| | 665RP | | • | | • | | | • | | | | | • | | | • | | • | | • |
| | 765HL, 765HFL | • | • | | • | | | • | • | | | | | | • | | | | | |
| | 9412D | | | | | | | | | | | | | | | • | | | | |
| | 9417DN | | • | | | • | | • | | | | | | | | • | • | | • | |
| | 9422P | | • | | • | • | | | | | | | | | | • | • | | • | |
| | 9427P | | • | | • | | | • | | | | | | | | • | • | • | • | • |
| | 9905 | • | • | | | | | • | • | | | | | | | • | • | | • | |
| | 9960 | | | | | | | | | | | | | | | • | | • | | • |
| | 9965 | | | | | | | • | | • | | | | | | | | | | |
| | QT9093WH, 9093WH | | | | | | | • | | • | | | | | | | | | | |
| QTXN110HL, QTXN110HFL | • | • | | • | | | • | • | • | | | | | | | | | | | |
| Utility Fans | 8210, 8310, QT200 | • | • | | | | | • | • | | | | | | • | • | | | | |
| | QT300 | | • | | | | | • | • | | | | | | • | • | | | | |

ADAPTERS

Model FY6

- 6" x 6" x 6" Y adapter

Model FY86

- 8" x 6" x 6" Y adapter

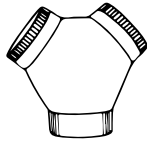

DAMPERS

Model 97 Damper*

- 7" spring-loaded, in-line damper

Model BP87 Damper*

- 7" vertical discharge damper

DUCTING

Model 406 Round Duct

- 6" round duct
- 2' galvanized section



Model 407 Round Duct*

- 7" round duct
- 2' galvanized section

Model 410 Round Duct*

- 10" round duct
- 2' galvanized section

Model 889 Duct

- 3 3/4" x 10" duct
- 2' galvanized sections



Models DT4C & DT6C Non-Insulated Flexible Duct

- 4" (DT4C) or 6" (DT6C) round
- DT4C is a 4-pack
- 25' standard length

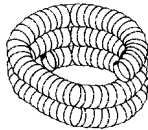

Models DT4W, DT6W & 804DU Insulated Flexible Duct

- 4" (DT4W & 804DU) or 6" (DT6W) round
- 25' standard length



DUCTING KITS

Model RVK1A*

Flexible Roof Ducting Kit

- Includes Model 636 Roof Cap
- 4" diameter metal duct connector
- 2 duct clamps
- 4" to 3" reducer
- 8' of 4" flexible aluminum ducting



Model WVK2A*

Flexible Wall Ducting Kit

- Includes white polymeric wall cap
- 4" diameter metal duct connector
- 2 duct clamps
- 4" to 3" reducer
- 5' of 4" flexible aluminum ducting



ELBOWS

Model 415 Adjustable Elbow

- Fits 7" round duct



Model 418 Adjustable Elbow

- Fits 10" round duct

Model 419 Adjustable Elbow

- Fits 6" round duct

Model 428 Vertical Elbow

- Fits 3 3/4" x 10" duct



Model 429 Horizontal Elbow

- Fits 3 3/4" x 10" duct

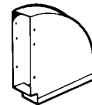

Model 430 Short Eave Elbow

- For 3 3/4" x 10" duct
- Includes backdraft damper and grille (black)
- Only recommended for fans with more than 160 CFM

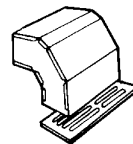

Model 431 Long Eave Elbow

- For 3 3/4" x 10" duct
- Includes backdraft damper and grille (black)
- Only recommended for fans with more than 160 CFM

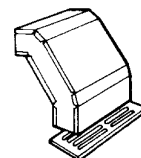

Model 839 Elbow

- 90° turn
- For use with 3 3/4" x 10" duct

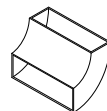

ROOF CAPS

Model 437 10" Round*

- High-capacity design up to 1200 CFM
- Built-in bird screen
- Steel housing, black electrically bonded epoxy finish

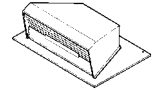

Model 611 Roof Cap*

- For flat roof installation
- Aluminum natural finish
- For up to 8" round duct

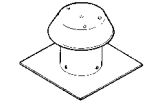

Model 611CM Roof Cap*

- For curb mount installation
- Other features same as Model 611

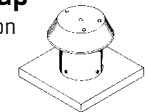

Model 612 Roof Cap*

- For flat roof installation
- Aluminum natural finish
- For up to 12" round duct

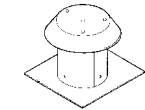

Model 612CM Roof Cap*

- For curb mount installation
- Other features same as Model 612

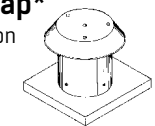

Model 634 Roof Cap*

- For 3 3/4" x 10" or up to 8" round duct
- Black
- Backdraft damper and birdscreen

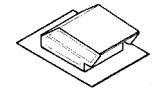

Model 634M Roof Cap*

- Same as Model 634 except for 6" round duct

Model 636 Roof Cap*

- For 3" or 4" round duct
- Built-in backdraft damper and bird screen
- Steel baked black enamel finish

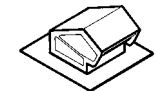

Model 636AL Roof Cap*

- Same as Model 636, except aluminum natural finish

Model 644 Roof Cap*

- Same as Model 634, except for aluminum natural finish

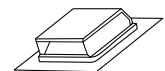

*Not for use with dryers

WALL CAPS

Model 613 Wall Cap*

- For 12" round duct
- Built-in backdraft damper and bird screen
- Aluminum natural finish

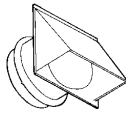

Model 639 Wall Cap*

- For 3 1/4" x 10" duct
- Spring-loaded backdraft damper
- Built-in bird screen
- Steel baked black enamel finish

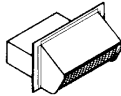

Model 649 Wall Cap*

- Same as Model 639, except aluminum natural finish

Model 641 Wall Cap*

- For 6" round duct
- Built-in backdraft damper and bird screen
- Aluminum natural finish
- Model 647 for 7" Round duct

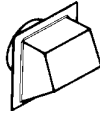

Model 647 Wall Cap*

- For 7" round duct
- Other features same as Model 641



Model 649 Wall Cap*

- Same as Model 639, except aluminum natural finish

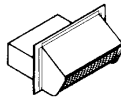

Model 843BL Wall Cap*

- For 6" round duct
- Built-in backdraft damper and bird screen
- Black finish

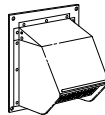

Models 885AL and 885BL Wall Cap*

- For 3" or 4" round duct
- 4" to 3" transition included
- Aluminum natural finish (885AL) and steel black enamel finish (885BL)
- Standard package—6 to a carton
- Built-in bird screen and damper

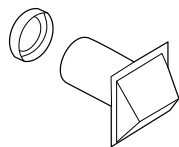

WALL CAPS CONTINUED

Model 643 Wall Cap*

- For 8" round duct
- Aluminum natural finish
- Backdraft damper, no birdscreen

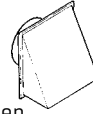

Model 646 Louvered Wall* Cap for 6" Round Duct

- Single pack
- White polymeric

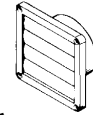

Model WC650 Wall Cap*

- For 4" round duct
- White polymeric
- 4 to a carton



SLEEVES

Model CVLD4

- 4" sleeve with damper

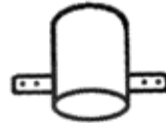

Model CVLD6

- 6" sleeve with damper

TRANSITIONS

Model 886 Transition

- Converts 7" round to 3 1/4" x 10" duct



Model 475 Transition

- Converts 6" round duct to 4" round duct reducer
- Available in 6 Pack (475B)

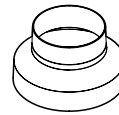

Model 413 Transition*

- Converts 3 1/4" x 10" duct to 8" round duct



*Not for use with dryers

TECHNICAL

What is a sone, and how is it measured? A sone is a measurement of sound—how sound is sensed. The lower the sone value, the quieter the listening environment. One sone is the equivalent of a quiet refrigerator. NuTone fans feature the quietest rating possible at <0.3 sones as tested for HVI certification.

What does “HVI certified” mean? The Home Ventilating Institute (HVI) is an independent organization that certifies the airflow and sound performance of NuTone products. For more information visit www.hvi.org.

What is ENERGY STAR®? Refer to the product matrix for specific NuTone fans that meet ENERGY STAR® requirements. Many of these NuTone products use high efficiency motors and lighting to reduce energy consumption by as much as 70%. Learn more about ENERGY STAR® at www.energystar.gov.

What does CFM mean? Cubic Feet per Minute (CFM) is the measure of air volume moved by the fan blower. Choose a fan with a CFM rating appropriate for your room size to ensure adequate ventilation.

What does “static pressure” mean? Static pressure is the measurement of airflow resistance as it is pushed through ductwork which reduces the effectiveness of the fan. Learn more on the Home Ventilating Institute website www.hvi.org.

What is whole-house ventilation? Whole-house ventilation provides today’s airtight homes with a relatively constant and controlled lower level of ventilation. NuTone offers many virtually silent continuous ventilation solutions for ASHRAE 62.2 and programs such as LEED, ENERGY STAR® for Homes and CA Title 24.

OPERATION

How do I size a fan properly for my room size and the duct run? See the sizing guidelines on page 55 for details on proper sizing. This section provides an explanation and examples to help you make the right decision.

How long should a bath fan run after a shower is used? The Home Ventilating Institute recommends that a fan should be left on for 20 minutes more to clear humidity adequately and to ensure moisture and condensation is minimized.

How does Sensing Technology operate? NuTone has unique sensing technology that detects humidity or motion. Multi-speed models automatically turn the fan speed up when someone enters the room or there is a rapid rise in the humidity level from the lower continuous CFM level. Single-speed models turn the fan on automatically.

How does the delay-off timer operate? Delay-off timers automatically shut the fan off after a time interval set by the user.

Why do the windows and mirrors fog even when the fan is running? If windows and mirrors are very cold, condensation can still form on these surfaces. And if your bathroom is sealed tightly, replacement air may not be entering the room fast enough to displace the moist air. Fan placement can also be a factor. Your fan should be located far from the replacement air source to ensure the moist air is drawn out first. Finally, make sure your ductwork is as short and straight as it can be in order to ensure proper air outflow.

Why is water dripping from the grille of the fan? Dripping water is either condensation (usually due to cold ductwork or improper duct installation), or a problem with the seal on a wall or roof vent. Insulated ductwork can help solve condensation problems, and running the fan longer will ensure moisture is completely removed from the duct.

Will NuTone fans work in wall-mount applications? Refer to the product matrix for specific NuTone bath and utility fans that may be wall mounted.

What type of exhaust fan is best for a sauna or hot tub area? High CFM-rated devices are normally recommended for this type of application.

Can I use a fan in a steam shower? No. Since these are normally sealed chambers, a vacuum will be created.

INSTALLATION

Can I mount NuTone fans above my tub and shower? Most NuTone fans are rated for use over a shower or bathtub with a GFCI (Ground Fault Circuit Interrupter).

Can my bath fan be surrounded by insulation? Yes. NuTone bath fans are designed to provide adequate cooling for motors and lighting, as well as products with integral heaters.

Can I vent more than one bath fan out of a roof or wall cap? No. Always follow the manufacturer's recommended ventilation requirements.

What is the NuTone Ventilation fan warranty? Go to www.NuTone.com/warranty for this information.

Do I need attic access to install a fan in a retrofit situation? Refer to the product matrix for specific NuTone fans that may be installed without access from above with features such as telescoping mounting frames, snap-in housings, bendable mounting ears, drywall-mounting tabs and inside-out mounting duct connectors. Room-side retrofit installations are now a reality.

Can I install a heater over the bathtub or in a shower? No. Heaters are not UL Listed (Underwriter's Laboratory) for installation over a bathtub or in a shower.

Can I use an inline or multi-port fan in one large bathroom? Yes, this works the best for large rooms because you can install the ports over the areas where the ventilation is needed the most (source control). The size of the multi-port would be determined by the size of the room.

Can larger diameter ducting be used with my bath fan? Yes, larger diameters will result in improved performance.

Can I use a smaller diameter duct than what the fan is designed for? This is not recommended. It will cause the fan to run harder, greatly reducing the CFM performance of the fan and create excess noise.

What type of duct is recommended, rigid or flexible? It is recommended, where possible, to use rigid duct. It has less resistance to air flow and allows the fan to operate much more efficiently. If flexible duct is used, be sure the duct is as straight as possible.

Can I exhaust my fan into my attic instead of out the roof or wall? Never exhaust air into spaces within walls, ceilings, attics, crawl spaces or garages. Humidity may damage the structure and insulation.

Where should the exhaust fan be located? Exhaust fans should be located in or near the shower or tub, and in an enclosed water closet. Keep exhaust points opposite the supply air source to ensure that the fresh air is drawn through the room. Bathroom doors should not be sealed too tightly at the bottom in order to allow "makeup air" to enter the room when the door is closed.

In what direction should I orient the exhaust outlet? The exhaust outlet is the point where air is discharged through the body of the fan housing into the ductwork. During installation, orient your fan with the exhaust outlet pointing toward the exit vent on your roof or wall to minimize turns in ductwork that impede airflow.

Will a bath fan or wall-mount utility fan serve as a range hood? No. Range hoods are specifically designed to handle grease and high temperature environments. NuTone bath fans supplement odor and moisture removal in the kitchen, but are not intended for use as a range hood.

Can I use CFL or LED bulbs in fan/lights with A19 screw-base sockets? Yes, if key guidelines are followed. Go to NuTone.com FAQs for details.

PROPER INSTALLATION MAKES ALL THE DIFFERENCE.

Tape or caulk around the seam where the fan housing meets the sheetrock on the ceiling

If possible, use smooth, rigid ductwork as large as the exit opening on the body of the fan housing

Whenever possible, ductwork should slope down and away from the fan housing to direct any condensation toward the vent

Whether rigid or flexduct, the turning radius for the duct should be as large as possible

Pre-installed screws, keyhole slots and alignment tabs facilitate installation, taking the guesswork out of proper mounting.

Elbows, turns, long ducts and ductwork smaller than the fan's exitoutlet will reduce performance.

Use wide aluminum foil or duct tape to join smooth metal ductwork seams.

Do not let flexible ductwork sag as this impedes airflow.

During installation, orient the bath fan outlet in the direction of the home's exit point to minimize duct turns.

Before adding an elbow or bend, allow 24" to 36" of straight run from the fan outlet point.

Duct-wrap insulation (R-5 or above) will help minimize condensation in cold climates, especially on long duct runs.

Quick guideline: For bathrooms up to 100 square feet, the HVI recommends ventilation of at least 1 CFM per square foot (about eight air changes per hour). For bathrooms over 100 square feet, add up the needs of each fixture to determine the total ventilation rate:

- Toilet 50 CFM
- Shower 50 CFM
- Bathtub 50 CFM
- Jetted tub 100 CFM

Exit vents should have backdraft flaps to help keep cold air from entering the duct

EASY STEPS FOR CHOOSING AND SIZING THE RIGHT VENTILATION FAN FOR YOUR HOME.

Determine which rooms could use ventilation, and how much is needed. **Spot ventilation** is used in localized areas to remove moisture, odor and airborne pollutants quickly. Most commonly used in the bath or powder room, spot ventilation can also be used in a laundry room, exercise area, closet, or bedroom, wherever air should be changed frequently. Decorative and recessed models can be ideal solutions for these situations. According to the Home Ventilating Institute (HVI), Air Changes per Hour (ACH) for comfortable and healthy living should be as follows: Bathrooms: 8 changes, Kitchens: 15 changes, Living/Bedrooms: 6 changes. NuTone bath fans, utility fans and high capacity fans can meet these needs.

Calculate the air movement necessary for proper ventilation. Air movement is measured in Cubic Feet per Minute (CFM). To determine CFM requirements, first determine the size of your room. Measure and multiply the length, width and ceiling height of your room to determine cubic footage. Then use the multiplication factor of .13 and round up to the next "ten." See the three examples that follow.

Example 1:

Bathroom with 8' ceiling:
7' wide x 9' long x 8' high x .13 = 66. Select a bath fan with at least 70 CFM

Example 2:

Bathroom with 9' ceiling: 10' wide x 9' long x 9' high x .13 = 105. Select a bath fan with at least 110 CFM

Example 3:

For a bathroom with a vaulted ceiling, use the average ceiling height at the wall and the peak: 8' wide x 12' long x $\left(\frac{8' \text{ at wall} + 12' \text{ at peak}}{2} = 10'\right)$ average height x .13 = 125. Select a fan(s) with at least 130 CFM

Account for long duct runs and ductwork that turns before it reaches the exterior vent. When airflow is restricted in any way it slows down. Just as a car must slow down for a sharp corner, air decelerates when going through a turn in a duct run. Whenever possible, create a straight duct run with large radius turns, if they're necessary at all. Rigid ductwork is optimal because airflow restriction is minimized. Flexible tubing may be convenient to install, but resistance is created as air is moved over the spiral metal frame of the tubing. With long duct runs or ducts with multiple turns the fan works harder, noise increases and fan performance (CFM) is compromised. Select a fan model with an even greater CFM rating to compensate.

6" ducting overcomes most performance-related installation issues. NuTone's ULTRA and QTX Green Series fans deliver high performance in virtually any real-world installation. They are engineered with a 6" duct connector for peak air movement and extremely quiet operation, even when the duct run is not short and straight.

SPECIFICATIONS

Fans

| | Page | CFM | Sones HVI-Certified | Baths up to () Sq Ft | ENERGY STAR® | Duct Size" | Housing Dimensions | | | Grille Dimensions | | | Amps |
|------------------|------|-----|---------------------|-----------------------|--------------|------------|-----------------------------------|--------------------------------|-------------------------------|--------------------------------|---------------------------------|-----------------|------|
| | | | | | | | L" | W" | H" | L" | W" | Grille finish | |
| 682NT | 29 | — | — | — | No | — | 7 ¹ / ₈ | 7 ¹ / ₈ | 3 ³ / ₄ | 8 ¹ / ₂ | 8 ¹ / ₂ | White Polymeric | 1.0 |
| 690NT | 29 | 60 | 3.0 | 55 | No | 3 | See page 29 for compatible models | | | 9 ¹ / ₂ | 8 ¹¹ / ₁₆ | White Polymeric | 1.2 |
| 695 | 27 | 70 | 6.0 | 65 | No | 3 | 7 ¹ / ₂ | 7 ¹ / ₄ | 3 ⁵ / ₈ | 9 ³ / ₈ | 8 ³ / ₄ | White Polymeric | 1.2 |
| 696N | 27 | 50 | 4.0 | 45 | No | 3 | 7 ¹ / ₂ | 7 ¹ / ₄ | 3 ⁵ / ₈ | 9 ³ / ₈ | 8 ³ / ₄ | White Polymeric | 0.75 |
| AEN80 | 22 | 80 | 0.8 | 75 | Yes | 4 | 9 ¹ / ₄ | 10 | 5 ³ / ₄ | 11 ¹ / ₄ | 12 | White Polymeric | 0.3 |
| AEN110 | 22 | 110 | 1.3 | 105 | Yes | 4 | 9 ¹ / ₄ | 10 | 5 ³ / ₄ | 11 ¹ / ₄ | 12 | White Polymeric | 0.3 |
| AEN80B | 22 | 80 | 1.5 | 75 | Yes | 4 | 9 ¹ / ₄ | 10 | 5 ³ / ₄ | 11 ¹ / ₄ | 12 | White Polymeric | 0.3 |
| AEN50 | 22 | 50 | 0.5 | 45 | Yes | 4 | 9 ¹ / ₄ | 10 | 5 ³ / ₄ | 11 ¹ / ₄ | 12 | White Polymeric | 0.2 |
| AN110 | 22 | 110 | 3.0 | 105 | No | 4 | 9 ¹ / ₄ | 10 | 5 ³ / ₄ | 11 ¹ / ₄ | 12 | White Polymeric | 0.4 |
| LPN80 | 25 | 80 | 1.0 | 75 | Yes | 3-4 | 8 | 8 ³ / ₄ | 5 ³ / ₄ | 13 | 14 | White Polymeric | 0.3 |
| QTXEN080 | 16 | 80 | 0.3 | 75 | Yes | 6 | 11 ³ / ₈ | 10 ¹ / ₂ | 7 ⁵ / ₈ | 13 | 14 | White Polymeric | 0.4 |
| QTXEN110 | 16 | 110 | 0.7 | 105 | Yes | 6 | 11 ³ / ₈ | 10 ¹ / ₂ | 7 ⁵ / ₈ | 13 | 14 | White Polymeric | 0.3 |
| QTXEN110S | 18 | 110 | 0.7 | 100 | Yes | 6 | 11 ³ / ₄ | 10 ¹ / ₂ | 7 ⁵ / ₈ | 12 ⁷ / ₈ | 13 ³ / ₄ | White Polymeric | 0.3 |
| QTXEN150 | 16 | 150 | 1.4 | 140 | Yes | 6 | 11 ³ / ₈ | 10 ¹ / ₂ | 7 ⁵ / ₈ | 13 | 14 | White Polymeric | 0.5 |
| RN80 | 13 | 80 | <0.3 | — | Yes | 4 | 11 ³ / ₈ | 10 ¹ / ₂ | 7 ⁵ / ₈ | 13 | 14 | White Polymeric | 0.3 |
| RN110 | 13 | 110 | 0.6 | — | Yes | 4 | 11 ³ / ₈ | 10 ¹ / ₂ | 7 ⁵ / ₈ | 13 | 14 | White Polymeric | 0.3 |
| XN50 | 11 | 50 | <0.3 | 45 | Yes | 4-6 | 10 ¹ / ₂ | 11 ³ / ₈ | 7 ⁵ / ₈ | 13 | 14 | White Polymeric | 0.1 |
| XN80 | 11 | 80 | <0.3 | 75 | Yes | 4-6 | 10 ¹ / ₂ | 11 ³ / ₈ | 7 ⁵ / ₈ | 13 | 14 | White Polymeric | 0.1 |
| XN110 | 11 | 110 | <0.3 | 100 | Yes | 6 | 10 ¹ / ₂ | 11 ³ / ₈ | 7 ⁵ / ₈ | 13 | 14 | White Polymeric | 0.2 |
| XN110H | 11 | 110 | <0.3 | 100 | Yes | 6 | 10 ¹ / ₂ | 11 ³ / ₈ | 7 ⁵ / ₈ | 13 ¹ / ₈ | 14 | White Polymeric | 0.3 |
| ZN80 | 11 | 80 | <0.3 | 75 | Yes | 4-6 | 10 ¹ / ₂ | 11 ³ / ₈ | 7 ⁵ / ₈ | 13 | 14 | White Polymeric | 0.1 |
| ZN80M | 11 | 80 | <0.3 | 75 | Yes | 4-6 | 10 ¹ / ₂ | 11 ³ / ₈ | 7 ⁵ / ₈ | 13 ¹ / ₈ | 14 | White Polymeric | 0.1 |
| ZN110 | 11 | 110 | <0.3 | 100 | Yes | 6 | 10 ¹ / ₂ | 11 ³ / ₈ | 7 ⁵ / ₈ | 13 | 14 | White Polymeric | 0.2 |
| ZN110H | 11 | 110 | <0.3 | 100 | Yes | 6 | 10 ¹ / ₂ | 11 ³ / ₈ | 7 ⁵ / ₈ | 13 ¹ / ₈ | 14 | White Polymeric | 0.3 |
| ZN110M | 11 | 110 | <0.3 | 100 | Yes | 6 | 10 ¹ / ₂ | 11 ³ / ₈ | 7 ⁵ / ₈ | 13 ¹ / ₈ | 14 | White Polymeric | 0.3 |

Fan/Lights

| | Page | CFM | Sones HVI-Certified | Baths up to () Sq Ft | Rooms up to () Sq Ft | Lighting Watts Main/Night Light | ENERGY STAR® | Duct Size" | Housing Dimensions | | | Grille Dimensions | | | Amps |
|---------------------|------|-----|---------------------|-----------------------|-----------------------|---------------------------------|--------------|------------|--------------------------------|--------------------------------|-------------------------------|-----------------------------------|--------------------------------|-----------------|------|
| | | | | | | | | | L" | W" | H" | L" | W" | Grille finish | |
| 668RP | 26 | 70 | 4.0 | 65 | 85 | 100W | No | 4 | 14 ⁹ / ₈ | 7 ⁷ / ₈ | 5 ⁵ / ₈ | 16 ¹ / ₄ | 9 ⁷ / ₈ | White Polymeric | 2.0 |
| 744FLNT | 32 | 70 | 1.5 | 65 | 85 | 16W floor. | Yes | 4 | 8 ³ / ₄ | 12 ³ / ₄ | 6 ³ / ₄ | 7 ³ / ₈ Dia | | White Polymeric | 1.2 |
| 744LEDNT | 32 | 70 | 1.5 | 65 | 85 | 14W LED | Yes | 4 | 8 ³ / ₄ | 12 ³ / ₄ | 6 ³ / ₄ | 7 ³ / ₈ Dia | | White Polymeric | 0.55 |
| 744NT | 32 | 70 | 1.5 | 65 | 85 | 75W | No | 4 | 8 ³ / ₄ | 12 ³ / ₄ | 6 ³ / ₄ | 7 ³ / ₈ Dia | | White Polymeric | 1.2 |
| 744SFLNT | 32 | 70 | 1.5 | 65 | 85 | 16W floor. | Yes | 4 | 8 ³ / ₄ | 12 ³ / ₄ | 6 ³ / ₄ | 7 ³ / ₈ Dia | | Matte White | 0.7 |
| 763 | 27 | 50 | 2.5 | 45 | 60 | 100W | No | 4 | 8 | 8 ³ / ₄ | 5 ³ / ₄ | 12 | 10 ⁹ / ₄ | White Polymeric | 1.6 |
| 791LEDNTM | 33 | 110 | 1.5 | 95 | 125 | 9W LED | Yes | 4 | 9 ¹ / ₄ | 10 | 5 ³ / ₄ | 10 ³ / ₈ | 10 ³ / ₈ | White | 0.5 |
| 8663RP | 26 | 100 | 3.5 | 95 | 125 | 100W/7W | No | 4 | 9 | 9 | 6 | 15 Dia | | White Polymeric | 1.7 |
| 8664RP | 26 | 100 | 3.5 | 95 | 125 | 100W | No | 4 | 9 | 9 | 6 | 15 Dia | | White Polymeric | 1.7 |
| AN80L | 22 | 80 | 1.0 | 75 | — | A19 Base | No | 4 | 9 ¹ / ₄ | 10 | 5 ³ / ₄ | 11 ¹ / ₂ | 12 ¹ / ₈ | White Polymeric | 1.2 |
| AN110L | 22 | 110 | 1.3 | 105 | — | A19 Base | No | 4 | 9 ¹ / ₄ | 10 | 5 ³ / ₄ | 11 ¹ / ₂ | 12 ¹ / ₈ | White Polymeric | 1.2 |
| AN70L | 22 | 70 | 2.0 | 65 | — | A19 Base | No | 4 | 9 ¹ / ₄ | 10 | 5 ³ / ₄ | 11 ¹ / ₂ | 12 ¹ / ₈ | White Polymeric | 1.2 |
| AEN80BL | 22 | 80 | 1.5 | 75 | — | LED | Yes | 4 | 9 ¹ / ₄ | 10 | 5 ³ / ₄ | 11 ³ / ₄ | 12 ¹ / ₂ | White Polymeric | 0.3 |
| AEN80L | 22 | 80 | 0.8 | 75 | — | LED | Yes | 4 | 9 ¹ / ₄ | 10 | 5 ³ / ₄ | 11 ³ / ₄ | 12 ¹ / ₂ | White Polymeric | 0.3 |
| AEN110L | 22 | 110 | 1.3 | 105 | — | LED | Yes | 4 | 9 ¹ / ₄ | 10 | 5 ³ / ₄ | 11 ³ / ₄ | 12 ¹ / ₂ | White Polymeric | 0.3 |
| QTNLEDA | 35 | 110 | 0.7 | 100 | — | 2- 18W GU24 | Yes | 6 or 4 | 11 ³ / ₈ | 10 ¹ / ₂ | 7 ⁵ / ₈ | 13 ³ / ₄ SQ | 3 ¹ / ₂ | White Polymeric | 1.0 |
| QTNLEDB | 35 | 110 | 0.7 | 100 | — | 2- 18W GU24 | Yes | 6 or 4 | 11 ³ / ₈ | 10 ¹ / ₂ | 7 ⁵ / ₈ | 13 ³ / ₄ SQ | 3 ¹ / ₂ | White Polymeric | 1.0 |
| QTXEN080FLT | 17 | 80 | 0.3 | 75 | — | 2- 18W GU24/4W | Yes | 6 | 11 ³ / ₈ | 10 ¹ / ₂ | 7 ⁵ / ₈ | 13 | 14 | White Polymeric | 1.0 |
| QTXEN110FLT | 17 | 110 | 0.7 | 100 | — | 2- 18W GU24/4W | Yes | 6 | 11 ³ / ₈ | 10 ¹ / ₂ | 7 ⁵ / ₈ | 13 | 14 | White Polymeric | 1.0 |
| QTXEN110SFLT | 18 | 110 | 0.7 | 100 | — | 2- 18W flour./4W | Yes | 6 | 11 ³ / ₈ | 10 ¹ / ₂ | 7 ⁵ / ₈ | 12 ⁷ / ₈ | 13 ³ / ₄ | White Polymeric | 1.0 |
| QTXEN150FLT | 17 | 150 | 1.4 | 140 | — | 2- 18W GU24/4W | Yes | 6 | 11 ³ / ₈ | 10 ¹ / ₂ | 7 ⁵ / ₈ | 13 | 14 | White Polymeric | 1.2 |
| QTXN110SL | 18 | 110 | 0.9 | 100 | — | 100W/4W | No | 6 | 11 ³ / ₈ | 10 ¹ / ₂ | 7 ⁵ / ₈ | 12 ⁷ / ₈ | 13 ³ / ₄ | White Polymeric | 1.0 |
| RN90L | 13 | 80 | <0.3 | — | Yes | 2- 18W GU24 | Yes | 4 | 11 ³ / ₈ | 10 ¹ / ₂ | 7 ⁵ / ₈ | 13 | 14 | White Polymeric | 1.0 |
| RN110L | 13 | 110 | 0.8 | — | Yes | 2- 18W GU24 | Yes | 4 | 11 ³ / ₈ | 10 ¹ / ₂ | 7 ⁵ / ₈ | 13 | 14 | White Polymeric | 1.0 |
| XN110HL | 11 | 110 | <0.3 | 100 | — | 2- 18W GU24/4W | Yes | 6 | 10 ¹ / ₂ | 11 ³ / ₈ | 7 ⁵ / ₈ | 13 ³ / ₈ | 14 | White Polymeric | 1.0 |
| XN110L | 11 | 110 | <0.3 | 100 | — | 2- 18W GU24/4W | Yes | 6 | 10 ¹ / ₂ | 11 ³ / ₈ | 7 ⁵ / ₈ | 13 | 14 | White Polymeric | 0.9 |
| XN50L | 11 | 50 | <0.3 | 45 | — | 2- 18W GU24/4W | Yes | 6 or 4 | 10 ¹ / ₂ | 11 ³ / ₈ | 7 ⁵ / ₈ | 13 | 14 | White Polymeric | 0.7 |
| XN80L | 11 | 80 | <0.3 | 75 | — | 2- 18W GU24/4W | Yes | 6 or 4 | 10 ¹ / ₂ | 11 ³ / ₈ | 7 ⁵ / ₈ | 13 | 14 | White Polymeric | 0.7 |
| ZN110HL | 11 | 110 | <0.3 | 100 | — | 2- 18W GU24/4W | Yes | 6 | 10 ¹ / ₂ | 11 ³ / ₈ | 7 ⁵ / ₈ | 13 ³ / ₈ | 14 | White Polymeric | 1.0 |
| ZN110L | 11 | 110 | <0.3 | 100 | — | 2- 18W GU24/4W | Yes | 6 | 10 ¹ / ₂ | 11 ³ / ₈ | 7 ⁵ / ₈ | 13 | 14 | White Polymeric | 0.9 |
| ZN110ML | 11 | 110 | <0.3 | 100 | — | 2- 18W GU24/4W | Yes | 6 | 10 ¹ / ₂ | 11 ³ / ₈ | 7 ⁵ / ₈ | 13 ³ / ₈ | 14 | White Polymeric | 1.0 |
| ZN80L | 11 | 80 | <0.3 | 75 | — | 2- 18W GU24/4W | Yes | 6 or 4 | 10 ¹ / ₂ | 11 ³ / ₈ | 7 ⁵ / ₈ | 13 | 14 | White Polymeric | 0.8 |
| ZN80ML | 11 | 80 | <0.3 | 75 | — | 2- 18W GU24/4W | Yes | 6 or 4 | 10 ¹ / ₂ | 11 ³ / ₈ | 7 ⁵ / ₈ | 13 ³ / ₈ | 14 | White Polymeric | 0.9 |

Utility Fans

| | Page | CFM | Sones | Housing Dimensions | | | Grille Dimensions | | Amps* | Duct" |
|--------------|------|-----|-------|--|----|-------------------------------|--------------------------------|---------------------------------|-------|------------------------------------|
| | | | | L" | W" | H" | L" | W" | | |
| 8210 | 37 | 210 | 6.5 | 9 Dia. x 5 ⁵ / ₈ | | | 11 Diameter | | 0.8 | 7 |
| 8310 | 37 | 160 | 5.0 | 14 | 12 | 3 ¹ / ₄ | 11 Diameter | | 1.5 | 3 ¹ / ₄ x 10 |
| QT200 | 37 | 200 | 2.0 | 14 ¹ / ₄ | 10 | 9 | 16 ¹ / ₂ | 12 ³ / ₃₂ | 1.0 | 3 ¹ / ₄ x 10 |
| QT300 | 37 | 300 | 4.5 | 14 ¹ / ₄ | 10 | 9 | 16 ¹ / ₂ | 12 ³ / ₃₂ | 2.5 | 3 ¹ / ₄ x 10 |

In-Line Ventilators

| | Page | 0.2" Ps CFM | Sones | Housing Dimensions | | | Duct | Amps | ENERGY STAR® |
|-----------------|------|----------------|-------|--------------------------------|---|--------------------------------|--------|------|--------------|
| | | | | Height | Duct Collar | Fan Diameter | | | |
| ILF120 | 38 | 110 | — | 10 | 3 ⁷ / ₈ | 10 | 4 | 0.37 | Yes |
| ILF130 | 38 | 130 | — | 7 ³ / ₄ | 4 ⁷ / ₈ | 10 | 5 | 0.37 | Yes |
| ILF250 | 38 | 230 | — | 9 ³ / ₈ | 5 ⁷ / ₈ | 12 | 6 | 0.8 | Yes |
| ILF360 | 38 | 360 | — | 13 ⁵ / ₈ | 7 ⁷ / ₈ | 13 ¹ / ₂ | 8 | 0.87 | |
| ILF530 | 38 | 530 | — | 11 ¹ / ₄ | 9 ⁷ / ₈ | 13 ¹ / ₂ | 10 | 2.0 | |
| ILFK120 | 39 | 110 | — | 10 | 3 ⁷ / ₈ | 10 | 4 | 0.37 | Yes |
| ILFK130 | 39 | 120 | — | 7 ³ / ₄ | 4 ⁷ / ₈ | 10 | 5 | 0.37 | Yes |
| ILFK250 | 39 | 230 | — | 9 ³ / ₈ | 5 ⁷ / ₈ | 12 | 6 | 0.8 | Yes |
| ILFK2502 | 39 | 230 | — | 9 ³ / ₈ | 5 ⁷ / ₈ | 12 | 6 | 0.8 | Yes |
| ILRF | 38 | 140 | — | 10 | 3 ⁷ / ₈ / 4 ⁷ / ₈ | 10 | 4 or 5 | 0.8 | |

Heater/Fan/Lights

| | Page | CFM | Sones HVI- Certified | Lighting Watts Main/ Night Light | Housing Dimensions | | | Grille Dimensions | | Grille finish | Duct Size" | Amps | Total Connected Load In Watts | Element Watts | Exhaust Motor Watts | Heating Motor Watts | BTU |
|--------------------|------|-----|----------------------------|--|--|--------------------------------|------------------------------------|------------------------------------|--------------------------------|------------------|---------------|------|--|------------------|---------------------------|---------------------------|------|
| | | | | | L" | W" | H" | L" | W" | | | | | | | | |
| 605RP | 42 | 70 | 4.0 | — | 14 ⁵ / ₈ | 7 ⁷ / ₈ | 5 ⁵ / ₈ | 16 ¹ / ₄ | 9 ⁷ / ₈ | White Polymeric | 4 | 13.5 | 1620 | 1300 | 60 | 60 | 5118 |
| 665RP | 42 | 70 | 4.0 | 100W | 14 ⁵ / ₈ | 7 ⁷ / ₈ | 5 ⁵ / ₈ | 16 ¹ / ₄ | 9 ⁷ / ₈ | White Polymeric | 4 | 14.2 | 1720 | 1300 | 60 | 60 | 5118 |
| 765HL | 42 | 100 | 2.0 | 100W | 16 | 10 ³ / ₄ | 5 ⁷ / ₈ | 17 ¹ / ₂ | 11 ¹ / ₂ | White Polymeric | 4 | 14.5 | 1830 | 1500 | 55 | 55 | 5120 |
| 765HFL | 42 | 100 | 2.0 | 27W Fluor. (Incl.) | 16 | 10 ³ / ₄ | 5 ⁷ / ₈ | 17 ¹ / ₂ | 11 ¹ / ₂ | White Polymeric | 4 | 14.0 | 1760 | 1500 | 55 | 55 | 5120 |
| 9093WH | 44 | 70 | 3.5 | 100W/7W | 13 ¹ / ₄ Dia x 7 ¹ / ₂ | | 15 ³ / ₈ Dia | | | White Enamel | 4 | 14.2 | 1717 | 1500 | 55 | 55 | 5118 |
| 9417DN* | 45 | 70 | 3.5 | 250W | 8 ¹ / ₈ | 8 ³ / ₈ | 6 ³ / ₈ | 10 ¹ / ₄ | 10 ¹ / ₄ | White Polymeric | 4 | 2.5 | 300 | — | 60 | — | 853 |
| 9427P* | 45 | 70 | 3.5 | 2- 250W | 14 ¹ / ₄ | 8 ³ / ₈ | 6 ³ / ₈ | 15 ⁵ / ₈ | 10 ¹ / ₄ | White Polymeric | 4 | 4.5 | 545 | — | 60 | — | 1707 |
| 9905 | 43 | 70 | 4.0 | — | 14 | 9 ³ / ₄ | 7 ³ / ₄ | 16 | 10 ⁷ / ₈ | White Polymeric | 4 | 13.5 | 1620 | 1500 | 60 | 60 | 5118 |
| 9960 | 43 | — | — | 100W/7W | 14 | 9 ³ / ₄ | 7 ³ / ₄ | 16 | 10 ⁷ / ₈ | White Polymeric | — | 13.9 | 1667 | 1500 | — | 60 | 5118 |
| 9965 | 43 | 70 | 4.0 | 100W/7W | 14 | 9 ³ / ₄ | 7 ³ / ₄ | 16 | 10 ⁷ / ₈ | White Polymeric | 4 | 14.2 | 1727 | 1500 | 60 | 60 | 5118 |
| QT9093WH | 44 | 110 | 3.0 | 100W/7W | 18 ³ / ₈ | 13 ³ / ₄ | 7 ¹ / ₂ | 15 ³ / ₈ Dia | | White Enamel | 4 | 14.2 | 1717 | 1500 | 55 | 55 | 5118 |
| QTXN110HL | 41 | 110 | 0.9 | 2- 60W/7W | 17 ⁵ / ₈ | 11 ³ / ₈ | 7 ⁵ / ₈ | 20 | 15 | White Polymeric | 6 | 14.6 | 1710 | 1500 | 55 | 55 | 5120 |
| QTXN110HFLT | 41 | 110 | 0.9 | 36W Fluor. (GU24 Incl.)/7W | 17 ⁵ / ₈ | 11 ³ / ₈ | 7 ⁵ / ₈ | 20 | 15 | White Polymeric | 6 | 13.9 | 1626 | 1500 | 55 | 55 | 5120 |

*Ventilation Fan/Bulb Heater versions

Bulb Heaters (No Fan)

| | Page | Watts | Volts | Heating Motor | | | Housing Dimensions | | | Grille Dimensions | | Grille finish |
|--------------|------|-------|-------|---------------|--------|--|--------------------------------|-------------------------------|-------------------------------|--------------------------------|--------------------------------|-----------------|
| | | | | Amps | BTU/hr | | L" | W" | H" | L" | W" | |
| 9412D | 45 | 250 | 120 | 2.1 | 853 | | 8 ¹ / ₈ | 8 ³ / ₈ | 6 ³ / ₈ | 10 ¹ / ₄ | 10 ¹ / ₄ | White Polymeric |
| 9422P | 45 | 500 | 120 | 4.3 | 1707 | | 14 ¹ / ₄ | 8 ³ / ₈ | 6 | 15 ⁵ / ₈ | 10 ¹ / ₄ | White Polymeric |

See models 9427P and 9417DN above for Ventilation Fan/Bulb Heater versions

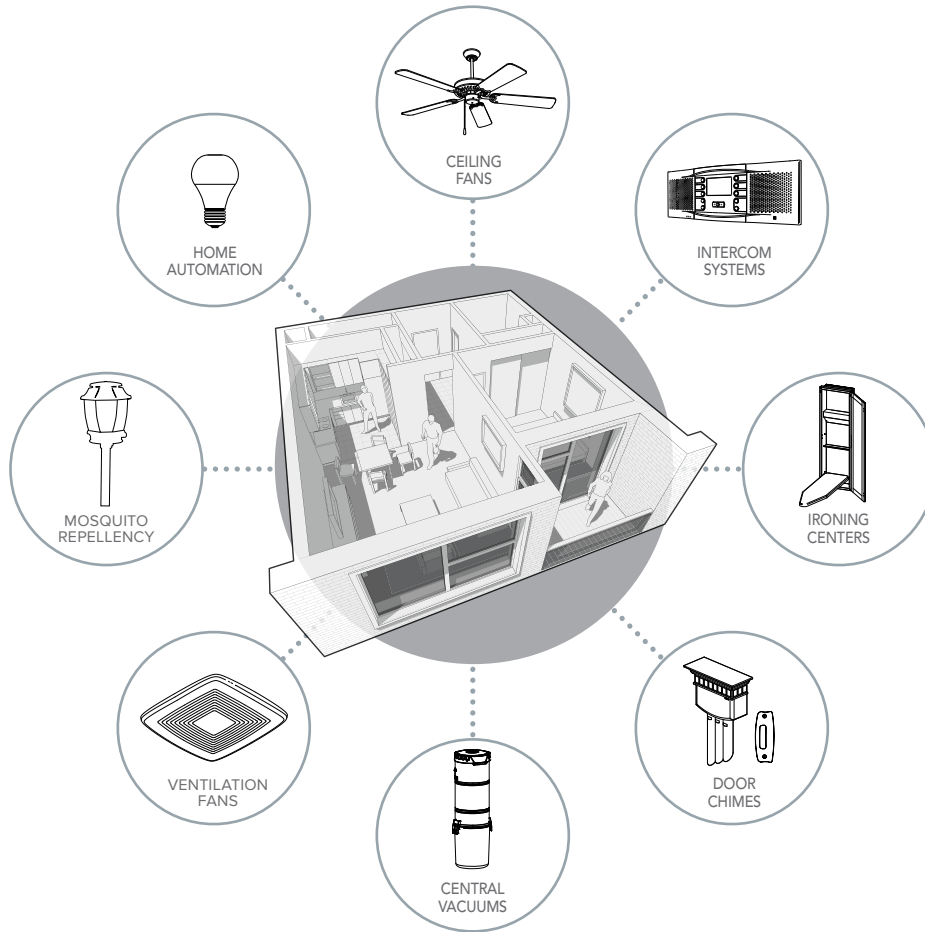

COMFORT. CONVENIENCE. EFFICIENCY.
WELCOME TO A NUTONE HOME.

NuTone® is America's leading brand of residential built-in convenience products including door chimes, central vacuum systems, intercom systems, ceiling fans, ironing centers, backyard lighting and mosquito repellent systems, and ventilation fans.

NuTone®

NuTone.com

Broan-NuTone LLC, 926 W. State Street

Hartford, WI 53027 **888-336-3948**

In Canada call **877-896-1119**

 A Nortek Company

America's Choice For Green Builders® Proud to be ENERGY STAR® partners.

