

THIS IS A COURTESY COPY OF THIS RULE. ALL OF THE DEPARTMENT'S RULES ARE COMPILED IN TITLE 7 OF THE NEW JERSEY ADMINISTRATIVE CODE.

N.J.A.C. 7:9A

STANDARDS FOR INDIVIDUAL SUBSURFACE SEWAGE DISPOSAL SYSTEMS

Statutory authority: N.J.S.A. 13:1D-1 et seq.; 26:3A2-21 et seq.; 58:10A-1 et seq., including 58:10A-16 ; 58:11-23 et seq.

Date last amended: April 2, 2012

For regulatory history and effective dates see the New Jersey Administrative Code

THIS IS A COURTESY COPY OF THIS RULE. ALL OF THE DEPARTMENT'S RULES ARE COMPILED IN TITLE 7 OF THE NEW JERSEY ADMINISTRATIVE CODE.

N.J.A.C. 7:9A STANDARDS FOR INDIVIDUAL SUBSURFACE SEWAGE DISPOSAL SYSTEMS

Table of Contents

SUBCHAPTER 1. GENERAL PROVISIONS.....	6
7:9A-1.1 PURPOSE.....	6
7:9A-1.2 SCOPE.....	6
7:9A-1.3 CONSTRUCTION OF RULES.....	6
7:9A-1.4 PRACTICE WHERE RULES DO NOT GOVERN.....	6
7:9A-1.5 SEVERABILITY.....	6
7:9A-1.6 GENERAL PROHIBITIONS.....	6
7:9A-1.7 PENALTIES.....	8
7:9A-1.8 LIMITATIONS.....	8
SUBCHAPTER 2. DEFINITIONS.....	8
7:9A-2.1 DEFINITIONS.....	8
SUBCHAPTER 3. ADMINISTRATION.....	21
7:9A-3.1 ORDINANCES.....	21
7:9A-3.2 NEW SYSTEM DESIGN APPROVALS.....	22
7:9A-3.3 EXISTING SYSTEMS.....	22
7:9A-3.4 NONCOMPLIANT SYSTEMS.....	23
7:9A-3.5 PERMIT TO CONSTRUCT OR ALTER.....	25
7:9A-3.6 WITNESSING OF SOIL EVALUATION AND TESTING.....	27
7:9A-3.7 MODIFICATION OF PLANS.....	27
7:9A-3.8 PINELANDS AREA APPROVALS.....	27
7:9A-3.9 TREATMENT WORKS APPROVAL.....	27
7:9A-3.10 NJPDES PERMITS.....	28
7:9A-3.11 EXPERIMENTAL SYSTEMS.....	29
7:9A-3.12 HOLDING TANKS.....	29
7:9A-3.13 CERTIFICATE OF COMPLIANCE.....	29
7:9A-3.14 NOTIFICATION OF PROPER OPERATION AND MAINTENANCE PRACTICES.....	30
7:9A-3.15 RECORDS.....	31
7:9A-3.16 OTHER SANITARY SEWAGE DISPOSAL UNITS.....	31
7:9A-3.17 SYSTEM PROFESSIONALS.....	32
7:9A-3.18 REQUIREMENTS FOR CERTIFICATION OF SEWERAGE FACILITIES SERVING SUBDIVISIONS INVOLVING 50 OR MORE REALTY IMPROVEMENTS.....	33
7:9-3.19 ENTRY AND INSPECTION.....	34
7:9A-3.20 HEARING PROCEDURES.....	35
SUBCHAPTER 4 SITE EVALUATION AND SYSTEM LOCATION.....	35
7:9A-4.1 GENERAL PROVISIONS FOR SITE EVALUATION AND SYSTEM LOCATION.....	35

THIS IS A COURTESY COPY OF THIS RULE. ALL OF THE DEPARTMENT'S RULES ARE COMPILED IN TITLE 7 OF THE NEW JERSEY ADMINISTRATIVE CODE.

7:9A-4.2 LOCATION GENERALLY	35
7:9A-4.3 DISTANCES	36
7:9A-4.4 SLOPE	37
7:9A-4.5 SURFACE DRAINAGE	37
7:9A-4.6 SURFACE FLOODING.....	38
7:9A-4.7 FRESHWATER WETLANDS	39
7:9A-4.8 AREA RESERVED FOR SANITARY SEWAGE DISPOSAL	41
SUBCHAPTER 5. DETERMINATION OF SOIL SUITABILITY	41
7:9A-5.1 GENERAL PROVISIONS FOR THE DETERMINATION OF SOIL SUITABILITY	41
7:9A-5.2 REQUIREMENTS FOR SOIL PROFILE PITS AND BORINGS	41
7:9A-5.3 TERMINOLOGY REQUIRED FOR SOIL LOGS.....	43
7:9A-5.4 CRITERIA FOR DETERMINATION OF SOIL SUITABILITY CLASSES	45
7:9A-5.5 ROCK SUBSTRATA.....	45
7:9A-5.6 EXCESSIVELY COARSE HORIZONS AND SUBSTRATA	46
7:9A-5.7 HYDRAULICALLY RESTRICTIVE HORIZONS AND SUBSTRATA.....	46
7:9A-5.8 CRITERIA FOR RECOGNITION OF ZONES OF SATURATION	47
7:9A-5.9 HYDRAULIC HEAD TEST	48
7:9A-5.10 DISTURBED GROUND.....	49
SUBCHAPTER 6. PERMEABILITY TESTING	51
7:9A-6.1 GENERAL PROVISIONS FOR PERMEABILITY TESTING	51
7:9A-6.2 TUBE PERMEAMETER TEST.....	54
7:9A-6.3 SOIL PERMEABILITY CLASS RATING	58
7:9A-6.4 PERCOLATION TEST	60
7:9A-6.5 PIT-BAILING TEST	62
7:9A-6.6 PIEZOMETER TEST.....	64
7:9A-6.7 BASIN FLOODING TEST.....	66
SUBCHAPTER 7. GENERAL DESIGN AND CONSTRUCTION REQUIREMENTS.....	67
7:9A-7.1 DESIGN REQUIREMENTS.....	67
7:9A-7.2 CONSTRUCTION	67
7:9A-7.3 TYPE OF WASTES.....	67
7:9A-7.4 VOLUME OF SANITARY SEWAGE	68
7:9A-7.5 SEPARATE DISPOSAL OF GREYWATER AND BLACKWATER.....	71
7:9A-7.6 TYPE OF SYSTEM.....	71
7:9A-7.7 BUILDING SEWER	72
SUBCHAPTER 8. PRETREATMENT UNITS	72
7:9A-8.1 GREASE REMOVAL AND HIGH STRENGTH WASTEWATER PRETREATMENT COMPONENTS	72
7:9A-8.2 SEPTIC TANKS	73

THIS IS A COURTESY COPY OF THIS RULE. ALL OF THE DEPARTMENT'S RULES ARE COMPILED IN TITLE 7 OF THE NEW JERSEY ADMINISTRATIVE CODE.

7:9A-8.3 ADVANCED WASTEWATER PRETREATMENT COMPONENTS	77
SUBCHAPTER 9. EFFLUENT DISTRIBUTION NETWORKS	79
7:9A-9.1 GENERAL REQUIREMENTS FOR EFFLUENT DISTRIBUTION	79
7:9A-9.2 DOSING TANKS	80
7:9A-9.3 CONNECTING AND DELIVERY PIPES.....	83
7:9A-9.4 DISTRIBUTION BOXES	84
7:9A-9.5 LATERALS; GRAVITY DISTRIBUTION	85
7:9A-9.6 PRESSURE DOSING NETWORKS	85
7:9A-9.7 DESIGN PROCEDURE FOR PRESSURE DOSING SYSTEMS	86
7:9A-9.8 PRODUCTS IN LIEU OF LATERALS AND/OR FILTER MATERIAL	88
SUBCHAPTER 10. DISPOSAL FIELDS.....	89
7:9A-10.1 GENERAL DESIGN REQUIREMENTS FOR DISPOSAL FIELDS.....	89
7:9A-10.2 DISPOSAL FIELD SIZING REQUIREMENTS	93
7:9A-10.3 SPECIFIC REQUIREMENTS FOR CONVENTIONAL DISPOSAL FIELD INSTALLATIONS.....	96
7:9A-10.4 SPECIFIC REQUIREMENTS FOR SOIL REPLACEMENT DISPOSAL FIELD INSTALLATIONS.....	98
7:9A-10.5 SPECIFIC REQUIREMENTS FOR MOUNDED DISPOSAL FIELD INSTALLATIONS.....	99
7:9A-10.6 SPECIFIC REQUIREMENTS FOR MOUNDED SOIL REPLACEMENT DISPOSAL FIELD INSTALLATIONS	101
7:9A-10.7 INTERCEPTOR DRAINS	101
7:9A-10.8 SPECIFIC REQUIREMENTS FOR DRIP DISPERSAL	103
TABLE 10.8 DRIP DISPERSAL AREA LOADING RATES	109
SUBCHAPTER 11. SEEPAGE PITS.....	109
7:9A-11.1 SITE/SOIL REQUIREMENTS.....	109
7:9A-11.2 DESIGN REQUIREMENTS.....	109
7:9A-11.3 CONSTRUCTION REQUIREMENTS	110
SUBCHAPTER 12. OPERATION AND MAINTENANCE	111
7:9A-12.1 SYSTEM USE.....	111
7:9A-12.2 SYSTEM MAINTENANCE	111
7:9A-12.3 MAINTENANCE AND MONITORING REQUIREMENTS FOR SYSTEMS INCORPORATING ADVANCED WASTEWATER PRETREATMENT DEVICES.....	112
7:9A-12.4 [RESERVED].....	113
7:9A-12.5 [RESERVED].....	113
7:9A-12.6 SYSTEM INSPECTION PROTOCOL FOR INSPECTIONS CONDUCTED DURING REAL PROPERTY TRANSFER	113
7:9A-12.7 SYSTEM TESTING	114
7:9A-12.8 ABANDONED SYSTEMS.....	114
SUBCHAPTER 13. CRITICAL AREAS.....	115
7:9A-13.1 IDENTIFICATION OF CRITICAL AREAS	115
7:9A-13.2 ESTABLISHMENT OF CRITICAL AREAS	115

THIS IS A COURTESY COPY OF THIS RULE. ALL OF THE DEPARTMENT'S RULES ARE COMPILED IN TITLE 7 OF THE NEW JERSEY ADMINISTRATIVE CODE.

APPENDIX A - FIGURES	117
APPENDIX B STANDARD FORMS FOR SUBMISSION OF SOILS/ENGINEERING DATA	143
APPENDIX C UNIFORM PLACEMENT OF PERCOLATION TESTS.....	153
APPENDIX D SOIL SUITABILITY CLASSIFICATION OF NEW JERSEY SOILS	156
APPENDIX E. SYSTEM INSPECTION PROTOCOL	166
APPENDIX F: INDIVIDUAL SUBSURFACE SEWAGE DISPOSAL INSPECTION REPORTING FORM	170

Subchapter 1. General Provisions

7:9A-1.1 Purpose

(a) The purpose of this chapter is to:

1. Prevent pollution of the waters of the State that results from improper location, design, construction, installation, alteration, operation or maintenance of individual subsurface sewage disposal systems;
2. Provide standards for the proper location, design, construction, installation, alteration, repair and operation of individual subsurface sewage disposal systems;
3. Protect the public health and safety and the environment;
4. Protect potable water supplies; and
5. Safeguard fish and aquatic life and ecological values.

7:9A-1.2 Scope

(a) This chapter prescribes standards for the location, design, construction, installation, alteration, repair and operation of individual subsurface sewage disposal systems.

(b) Except as otherwise provided by N.J.S.A. 58:11-25 or in N.J.A.C. 7:14A, the following shall constitute the rules of the New Jersey Department of Environmental Protection for all individual subsurface sewage disposal systems with an expected volume of sanitary sewage less than or equal to 2,000 gpd and shall be regarded as the minimum uniform standards, in force throughout the State, governing individual subsurface sewage disposal systems. Different requirements or specifications for individual subsurface sewage disposal systems may be set forth in a treatment works approval, general NJPDES permit or individual NJPDES permit as provided at N.J.A.C. 7:14A.

7:9A-1.3 Construction of rules

(a) This chapter shall be liberally construed to permit the Department to discharge its statutory functions.

(b) All appendices attached to this chapter are incorporated into this chapter and are made a part hereof.

7:9A-1.4 Practice where rules do not govern

The Commissioner, or any other appropriate management employee within the Department, shall exercise his or her discretion in respect to any matters not governed by this chapter.

7:9A-1.5 Severability

If any provision of this chapter or the application thereof to any person or circumstance is held invalid, such invalidity shall not affect other provisions of this chapter, and to this end, the provisions of this chapter are declared to be severable.

7:9A-1.6 General prohibitions

(a) A person shall not install, construct, alter or repair an individual subsurface sewage disposal system without first obtaining the necessary permits, approvals or certifications as required by this chapter.

(b) An administrative authority shall not issue an approval, permit or certification for installation, construction, alteration, or repair of an individual subsurface sewage disposal system where such installation, construction, alteration or repair will violate or otherwise not be in compliance with the requirements of this chapter.

(c) The construction, installation or operation of a subsurface sewage disposal system to serve more than one property is prohibited unless a treatment works approval and/or a NJPDES permit has been issued by the Department.

THIS IS A COURTESY COPY OF THIS RULE. ALL OF THE DEPARTMENT'S RULES ARE COMPILED IN TITLE 7 OF THE NEW JERSEY ADMINISTRATIVE CODE.

- (d) Individual subsurface sewage disposal systems shall not be located, designed, constructed, installed, altered, repaired or operated in a manner that will allow the discharge of an effluent onto the surface of the ground or into any water course.
- (e) The administrative authority shall not approve the construction or alteration of individual subsurface sewage disposal systems or other means of private sewage disposal where a sanitary sewer line is available within 100 feet of the property to be served. For the purpose of this subsection, an existing sanitary sewer line shall be considered to be available when the following conditions are met:
1. Connection of the facility to the sanitary sewer line may be accomplished without installing a pump station, blasting bedrock, acquiring an easement or right-of-way to cross an adjoining property, or crossing a watercourse, railway, major highway or other significant obstacle; and
 2. The property to be served is located within the designated sewer service area of the sewage treatment plant to which the sanitary sewer line is connected.
- (f) The discharge of sanitary sewage or the effluent from any individual subsurface sewage disposal system into any abandoned well or any well constructed for the purpose of sanitary sewage disposal is prohibited. The administrative authority shall not approve the discharge of sanitary sewage or septic tank effluent into an existing well or the construction of a new well for the purpose of waste disposal.
- (g) The construction, installation, alteration or repair of cesspools, privies, outhouses, latrines and/or pit toilets is prohibited.
- (h) The administrative authority shall not approve the construction or installation of seepage pits except as provided by N.J.A.C. 7:9A-7.6.
- (i) The discharge of industrial wastes into an individual subsurface sewage disposal system is prohibited unless such discharge has been authorized by a treatment works approval or a NJPDES permit issued by the Department.
- (j) The administrative authority shall not approve the construction, installation or alteration of any individual subsurface sewage disposal system used for the discharge of industrial wastes.
- (k) The administrative authority shall not approve the construction, installation, repair or alteration of any system, or part thereof, that is located on a property other than the property on which the structure it serves is located, until it is in receipt of a copy of a deed notice prepared in accordance with the New Jersey Recording Act, N.J.S.A. 46:15-1.1 et seq., recorded with the office of the clerk or the registrar of deeds and mortgages of the county in which the property where the system is located. The deed notice shall run with the property and be binding upon the property owner and the successors in interest in the property or in any part thereof. The deed notice shall include:
1. The lot(s) and block(s) of the property on which the structure generating the sanitary sewage is located;
 2. The lot(s) and block(s) of the property in which the system or system components are located;
 3. The site plan location of all the system components and the associated, applicable separation distances on the properties in (k)1 and 2 above, as set forth in N.J.A.C. 7:9A-4.3 or a reference to those materials permanently on file with the administrative authority; and
 4. A restriction and/or 100-year lease agreement or easement for the property(ies) where the system or portion of the system will be located, which shall provide notice:
 - i. That the property(ies) contains a system or components of a system which serves a structure on another property; and
 - ii. Of the associated restrictions on any realty improvements on the property(ies) containing the system or components of the system serving a structure on another property that may infringe upon the minimum separation distances as set forth in N.J.A.C. 7:9A-4.3.

THIS IS A COURTESY COPY OF THIS RULE. ALL OF THE DEPARTMENT'S RULES ARE COMPILED IN TITLE 7 OF THE NEW JERSEY ADMINISTRATIVE CODE.

(l) The administrative authority shall not approve the construction, installation, alteration, operation or repair of any system or systems that are included as any part of any improvement to a property, existing, proposed or planned in accordance with any municipal subdivision or site plan approval(s), where the total expected volume of sanitary sewage for the property, based upon completion of all improvements, will exceed 2,000 gpd. This prohibition shall not apply to residential developments where each individual private residence is served by a system that serves only that individual private residential source and both the individual private residential source and the system are located on the same individual lot.

7:9A-1.7 Penalties

Violation of any provision of this chapter shall be a violation of the New Jersey Water Pollution Control Act, N.J.S.A. 58:10A-1 et seq., and the violator shall be subject to assessment of civil administrative penalties pursuant to the provisions of N.J.A.C. 7:14-8.

7:9A-1.8 Limitations

(a) The administrative authority shall not approve the installation, construction or alteration of an individual subsurface sewage disposal system unless the proposed system falls within the limits defined as follows:

1. A system serving one or more dwelling unit on one individual property where the total daily volume of sewage generated, calculated as prescribed in N.J.A.C. 7:9A-7.4, is no greater than 2,000 gallons per day and the type of waste discharged consists of sanitary sewage only; or
2. A system serving facilities other than one or more dwelling unit where the total daily volume of sewage generated, calculated as prescribed in N.J.A.C. 7:9A-7.4, is no greater than 2,000 gallons per day, the type of waste discharged consists of sanitary sewage only, and the system is connected to buildings, commercial units or other realty improvements on the same individual properties.

(b) When an individual subsurface sewage disposal system exceeds the limitations in (a) above, a treatment works approval and a NJPDES permit issued by the Department will be required.

(c) In cases where the actual volume of sanitary sewage discharged from a facility will be reduced by use of water-saving plumbing fixtures, recycling of renovated wastewater, incineration or composting of wastes, evaporation of sewage effluent or any other process, the requirement for obtaining a treatment works approval and a NJPDES permit shall be based upon the design volume of sanitary sewage, calculated as prescribed in N.J.A.C. 7:9A-7.4, rather than the actual discharge volume as modified by water conservation or special treatment processes.

Subchapter 2. Definitions

7:9A-2.1 Definitions

The following words and terms, when used in this chapter, shall have the following meanings unless the context clearly indicates otherwise:

"A-horizon" means the uppermost mineral horizon in a normal soil profile. The upper part of the A-horizon is characterized by maximum accumulation of finely divided, dark colored organic residues, known as humus, which are intimately mixed with the mineral particles of the soil.

"Administrative authority" means the board of health having jurisdiction or its authorized agent acting on its behalf.

"Advanced wastewater pretreatment device" means an NSF International (NSF) Standard 40 or Standard 245 certified technology which may be incorporated as a part of an onsite wastewater treatment system, which bears the NSF mark and is designed, installed, operated, monitored and maintained in accordance with that certification and this chapter. This definition also includes those technologies that are authorized for use in the Pinelands Area through the Pinelands Advanced Wastewater Treatment Systems Pilot Program at N.J.A.C 7:50-10.23.

THIS IS A COURTESY COPY OF THIS RULE. ALL OF THE DEPARTMENT'S RULES ARE COMPILED IN TITLE 7 OF THE NEW JERSEY ADMINISTRATIVE CODE.

"Age-restricted unit" means a housing unit designed to meet the needs of, and exclusively for, the residents of an age-restricted segment of the population where the head of the household is a minimum age of either 62 years, or 55 years and meets the provisions of the 42 U.S.C. §§ 3601 et seq., except that due to death, a remaining spouse of less than 55 years of age shall be permitted to continue to reside.

"Alteration" means any change in the physical configuration of an existing individual subsurface sewage disposal system or any of its component parts, including replacement, modification, addition or removal of system components such that there will be a change in the location, design, construction, installation, size, capacity, type or number of one or more components. The term "alter" shall be construed accordingly.

"Applicant" means the person who signs and submits an application to construct, install or alter an individual subsurface sewage disposal system.

"Approved" means accepted or acceptable under applicable specifications stated or cited in this chapter, or accepted as suitable for the proposed use under the procedures of this chapter. The word "approval" shall be construed accordingly.

"Approved engineering design" means the engineering plans and specifications for construction, installation or alteration of the individual subsurface sewage disposal system which have been reviewed and approved by the administrative authority.

"Artesian zone of saturation" means a zone of saturation which exists immediately below a hydraulically restrictive horizon, and which has an upper surface which is at a pressure greater than atmospheric, either seasonally or throughout the year.

"Authorized agent" means a licensed health officer, licensed professional engineer or first-grade sanitarian who is delegated to function within specified limits as the agent of the administrative authority.

"Authorized installer" means an individual who has completed all training requirements of a manufacturer of a product that is listed by the Department in accordance with N.J.A.C. 7:9A-8.3 or 9.8 and/or a listed system integrator of a drip dispersal system designed and installed in accordance with N.J.A.C. 7:9A-10.8, and who installs those advanced wastewater pretreatment devices, products used in lieu of laterals/filter material and/or drip dispersal systems, as applicable.

"Authorized service provider" means an individual who maintains an advanced wastewater pretreatment device and/or drip dispersal system in accordance with N.J.A.C. 7:9A-12.3, who monitors the system remotely and who responds appropriately to alarm conditions. This individual must either hold an S2 or greater license pursuant to N.J.A.C. 7:10A; or have completed all training required by a manufacturer of an advanced wastewater pretreatment device that is listed by the Department in accordance with N.J.A.C. 7:9A-8.3; and/or be a listed system integrator of a drip dispersal system in accordance with N.J.A.C. 7:9A-10.8.

"Bedrock" means any solid body of rock, with or without fractures, which is not underlain by soil or unconsolidated rock material.

"Bedroom" means any room within a dwelling unit, finished or unfinished, which may reasonably be expected to serve primarily as a bedroom or dormitory. The term bedroom shall be considered to include any room or rooms within an expansion attic.

"Blackwater" means any sanitary sewage generated within a residential, commercial or institutional facility which includes discharges from water closets, toilets, urinals or similar fixtures alone or in combination with other wastewater. Blackwater generally does not include laundry or kitchen wastewater.

"Building sewer" means the pipe extending from the outer wall of the building, or as defined in the State Uniform Construction Code, N.J.A.C. 5:23, to the septic tank or approved place of disposal other than a public sewer.

"Certificate of compliance" means a formal determination in writing by the administrative authority or its authorized agent that an individual subsurface sewage disposal system has been constructed, installed or altered in conformance with the requirements set forth in this chapter as well as any other applicable local ordinances.

THIS IS A COURTESY COPY OF THIS RULE. ALL OF THE DEPARTMENT'S RULES ARE COMPILED IN TITLE 7 OF THE NEW JERSEY ADMINISTRATIVE CODE.

"Cesspool" means a covered pit with open-jointed lining into which untreated sewage is discharged, the liquid portion of which is disposed of by leaching into the surrounding soil, the solids or sludge being retained within the pit.

"Chroma" means the relative purity or strength of a color, a quantity which decreases with increasing grayness. Chroma is one of the three variables of soil color as defined in the Munsell system of classification.

"Clay" means a particle size category consisting of mineral particles which are smaller than 0.002 millimeters in equivalent spherical diameter. Also, a soil textural class having more than 40 percent clay, less than 45 percent sand, and less than 40 percent silt, as shown in Figure 3 of Appendix A.

"Clay loam" means a soil textural class having 27 to 40 percent clay and 20 to 45 percent sand, as shown in Figure 3 of Appendix A.

"Coarse fragment" means a rock fragment contained within the soil which is greater than two millimeters in equivalent spherical diameter or which is retained on a two millimeter sieve.

"Cobble" means a coarse fragment which is rounded or subrounded in shape and which is between 76 millimeters (three inches) and 254 millimeters (10 inches) in diameter.

"Commercial food service activity" means any food service activity that includes the preparation of food for sale to any individual who or group that does not work at the facility where the food is prepared. This includes, but is not limited to, supermarkets, restaurants (including fast food), mini markets, bakeries, delis, bodegas and caterers. This does not include food service activities at cafeterias such as those at offices, schools, religious centers or employee eating areas that serve only the individuals that are employed by or attend the facility as part of normal operating functions. This definition shall not be construed to exempt any facility discharging large quantities of grease from the requirements in N.J.A.C. 7:9A-8.1.

"Commercial unit" means one or more buildings, or one or more rooms within a building, which will be occupied by a single individual, corporation, company, association, society, firm, partnership or joint stock company, and used for non-residential purposes. Within a commercial building, each room or suite of rooms having its own separate sanitary facilities as well as a separate entrance to the outside, or to a hallway, lobby, foyer or other common area, shall be considered to be a separate realty improvement, as defined in this section.

"Commercial use activities" means those activities that are related to the buying or selling of goods or services, and commonly occur at facilities such as offices, wholesale or retail stores, industrial buildings, factories, and shopping centers.

"Common plan of development or sale" means a contiguous area where multiple separate and distinct development activities have occurred, are occurring, or are proposed to occur under one plan. The "plan" in a common plan of development is broadly defined as any announcement or piece of documentation (including, but not limited to, a sign, public notice or hearing, advertisement, drawing, permit application, zoning request) or physical demarcation (including, but not limited to, boundary signs, lot stakes, surveyor markings).

"Component" means any device and/or structure that functions as a part of any system regulated by this chapter.

"Congregate living activities" means those activities at structures such as dormitories, motels, nursing/rest homes, group homes, assisted living facilities and boarding houses. These structures typically have one or more amenities and/or activities that service the establishment and not typically an individual unit, such as common bathrooms, kitchens, dining areas and/or laundry facilities.

"Construct" means to build, install, fabricate or put together on-site one or more components of an individual subsurface sewage disposal system.

"Conventional disposal field installation" means a type of disposal field installation described in N.J.A.C. 7:9A-10.1(b)1.

THIS IS A COURTESY COPY OF THIS RULE. ALL OF THE DEPARTMENT'S RULES ARE COMPILED IN TITLE 7 OF THE NEW JERSEY ADMINISTRATIVE CODE.

"County soil survey report" means a report prepared by the U.S. Department of Agriculture, Soil Conservation Service which includes maps showing the distribution of soil mapping units throughout a particular county together with narrative descriptions of the soil series shown and other information relating to the uses and properties of the various soil series.

"D-box" means a distribution box.

"Delineated stream" or "delineated floodplain" means a stream or flood plain for which the flood hazard areas have been officially specified by the State of New Jersey.

"Department" means the Department of Environmental Protection.

"Design permeability" means the permeability or percolation rate measured at the level of infiltration, as prescribed in N.J.A.C. 7:9A-6. For the purpose of this chapter, a percolation rate measured at the level of infiltration, though not a true measurement of permeability, may be considered to be a form of design permeability.

"Direct supervision" means control over and direction of work carried out by others with full knowledge of and responsibility for such work.

"Disposal bed" means an individual subsurface sewage disposal system component consisting of a closed excavation made within soil or fill material to contain filter material in which two or more distribution laterals have been placed for the disposal of septic tank effluent.

"Disposal field" means a disposal bed, a group of one or more disposal trenches, a drip dispersal area designed in accordance with N.J.A.C. 7:9A-10.8, or a seepage pit designed in accordance with N.J.A.C. 7:9A-11 or a seepage pit previously approved for sanitary sewage disposal. The perimeter of the disposal field corresponds to the perimeter of the disposal bed, or the outermost extent of fill material in a fill enclosed system, and the extent of the lateral fill extension in a mounded system, a line circumscribing the outermost edges of the outermost disposal trenches and including the area between the disposal trenches or the outermost layer of filter material surrounding a seepage pit.

"Disposal trench" means an individual subsurface sewage disposal system component of a covered excavation made within soil or fill material to contain filter material in which a single distribution lateral has been placed for the disposal of septic tank effluent.

"Distribution box" means a water-tight structure which receives sanitary sewage effluent from a septic tank and distributes such sewage effluent in equal portions to two or more pipelines leading to the disposal field.

"Distribution lateral" means a perforated pipe or one of several perforated pipes used to carry and distribute septic tank effluent throughout the disposal field. The term "distribution line" is equivalent in meaning.

"Distribution network" means two or more inter-connected distribution laterals.

"Disturbed ground" means any site or portion of a site which has been modified in its suitability for absorption or disposal of septic tank effluent, or its ability to physically support the system components, as a result of activities carried out by man other than those specified in the approved engineering design. Except for artificial drainage, ground disturbed only for cultivation or related agricultural activities, shall not be considered disturbed ground. Disturbed ground includes those conditions set forth in N.J.A.C. 7:9A-5.10(b).

"Dosing tank" means a water-tight receptacle located between the septic tank and the disposal field, equipped with a siphon or pump, and designed to store and deliver doses of septic tank effluent to the disposal field.

"Drip dispersal" means a high pressure, low volume, subsurface method of disposing sanitary sewage in a manner that does not create saturated subsurface conditions below the ground surface and which is preceded by an advanced wastewater pretreatment device. A drip dispersal system includes all associated tanks, pumps, control panels, and piping that is designed, installed, operated and maintained in accordance with the requirements of the system integrator and this chapter.

THIS IS A COURTESY COPY OF THIS RULE. ALL OF THE DEPARTMENT'S RULES ARE COMPILED IN TITLE 7 OF THE NEW JERSEY ADMINISTRATIVE CODE.

"Drip emitter" or "emitter" means an engineered, pressure compensating flow control device which is typically attached to the inside wall of a dripperline over each orifice, that is wastewater rated and discharges wastewater out of the orifice at a constant rate over a range of operating pressures.

"Dripperline" or "drip tubing" means the wastewater rated polyethylene tubing that has uniformly spaced drip emitters along its length, which are attached to the inside wall of the tubing.

"Dry well" means a covered pit with open-jointed lining through which drainage from roofs, basement floors or areaways may seep into the surrounding soil.

"Dwelling unit" means any building or portion of a building, permanent or temporary in nature, used or proposed to be used as a residence either seasonally or throughout the year.

"Education/child care" means, for the purposes of estimating volumes of sanitary wastewater at facilities using onsite wastewater treatment and disposal systems, any activity associated with educating or providing for activities to individuals under instructor or supervisory care, but provides for no overnight accommodations. These include, but are not limited to all levels of schools, colleges, vocational training centers, day care facilities and day camps.

"Encroachment line" means a line encompassing the channel of a natural stream and portions of the 100-year flood plain adjoining the channel which are reasonably required to carry and discharge the flood water or flood flow of any natural stream. It is approximately equal to the floodway line along delineated streams.

"Equivalent spherical diameter" of a particle means the diameter of a sphere which has a volume equal to the volume of the particle.

"Excessively coarse horizon" means a horizon of limited thickness within the soil profile which provides inadequate treatment of septic tank effluent due to a high coarse fragment content, excessively coarse texture and/or excessively rapid permeability.

"Excessively coarse substratum" means a substratum below the soil profile which extends beyond the depth of soil profile pits and borings and which provides inadequate treatment of septic tank effluent due to a high coarse fragment content, excessively coarse texture and/or excessively rapid permeability.

"Existing ground surface" means the level of the ground surface prior to any manmade modification or disturbance.

"Expansion attic" means that part of a dwelling unit left unfinished but which is capable of being finished as a bedroom or bedrooms and which is accessible by permanent stairways or designed so that stairways can be installed.

"Experimental system" means an individual subsurface sewage disposal system which does not conform in location, design, construction or installation to standard engineering practice as set forth in this chapter.

"Extremely firm consistence" means a type of soil consistence which is described in N.J.A.C. 7:9A-5.3(h).

"Failing system" means a system that is malfunctioning in accordance with N.J.A.C. 7:9A-3.4.

"Fill material" or "fill" means any naturally occurring soil or rock based material that has not been physically altered, which meets or can be sorted to meet a specific grain size requirement and is placed within an excavation or over the existing ground surface.

"Filter material" means washed gravel or crushed stone, free of fines such as dust, ashes or clay, and meeting the size requirements of N.J.A.C. 7:9A-10.3(e)2 or 10.7(f).

"Finished grade" means the surface of the ground after completion of final grading.

"Firm consistence" means a type of soil consistence which is described in N.J.A.C. 7:9A-5.3(h).

"Flood fringe" means that portion of the flood hazard area not designated as the floodway. See N.J.A.C. 7:13.

"Flood hazard area" means the floodway and the flood fringe area of a delineated stream. See also N.J.A.C. 7:13.

THIS IS A COURTESY COPY OF THIS RULE. ALL OF THE DEPARTMENT'S RULES ARE COMPILED IN TITLE 7 OF THE NEW JERSEY ADMINISTRATIVE CODE.

"Floodway" means the channel of a natural stream and portions of the flood hazard area adjoining the channel which are reasonably required to carry and discharge the flood water or flood flow of any natural stream. See also N.J.A.C. 7:13.

"Flushing" means, for the purposes of drip dispersal design and operation, the process by which the entire piping network, including dripperlines, is hydraulically cleansed to prevent emitter clogging by increasing the velocity of water flow through the dripperlines to scour and transport solid materials that may have accumulated in or on the interior surfaces of the piping in a drip dispersal system.

"Food service activities" means those activities associated with the handling, preparing or serving of food that will result in the generation of wastewater. These activities are typically characterized by the use of heating, cooling, cooking or cleaning equipment including walk-in refrigeration units, stoves, fryers, ovens, warmers, steamers, dishwashers and sinks typically used for food or dish washing.

"Footing drain" means a subsurface drain installed below the foundation of a building to prevent the accumulation of surface and ground water below the foundation of the building.

"Fractured rock substratum" means a rock substratum which contains an adequate number of open and inter-connected fractures to allow unimpeded absorption of applied wastewater and transmission of this wastewater away from the disposal area.

"Fueling position" means the location at any automotive service station that can dispense any type of fuel to one vehicle at any one time. There may be multiple hoses or nozzles located at a single fueling dispenser. However, if only one vehicle can fuel at the dispenser at one time, the dispenser has only one fueling position.

"Gal/day" or "gpd" means U.S. gallons per day, which is a measure of rate of flow or hydraulic loading.

"General assembly activities" means those activities which provide areas of fixed or movable seating that may be used for gatherings of individuals. The type of facilities in which these activities could occur include, but are not limited to, religious facilities, all purpose rooms, stadiums, indoor or outdoor theatres, assembly halls, and airports.

"Gravel" means a rounded or subrounded coarse fragment which is between two millimeters (0.1 inches) and 76 millimeters (three inches) in diameter.

"Gravity dosing" means a type of effluent distribution which is defined in N.J.A.C. 7:9A-9.1(a)2.

"Gravity flow" means a type of effluent distribution which is defined in N.J.A.C. 7:9A-9.1(a)1.

"Grease trap" means a device in which the grease present in sanitary sewage is intercepted, congealed by cooling, accumulated and stored for pump-out and disposal.

"Greywater" means that portion of the sanitary sewage generated within a residential, commercial or institutional facility which does not include discharges from water closets or urinals.

"Ground water" means water below the land surface in a zone of saturation.

"Hard consistence" means a type of soil consistence which is described in N.J.A.C. 7:9A-5.3(h).

"Health Officer" means an individual licensed as such pursuant to N.J.S.A. 26:1A-41.

"High strength wastewater pretreatment component" means a sanitary sewage pretreatment device designed to actively remove fats, oils and grease, as well as reduce total suspended solids, biochemical and chemical oxygen demand, and is incorporated into septic system design by a septic system designer and takes into consideration the existing or anticipated sanitary wastewater strength and the required removal capabilities identified in N.J.A.C. 7:9A-8.1(i).

"Holding tank" means a closed water-tight structure designed and operated in such a manner as to receive and store sanitary sewage or septic tank effluent but not to discharge sanitary sewage or septic tank effluent to the surface or ground water or onto the surface of the land.

THIS IS A COURTESY COPY OF THIS RULE. ALL OF THE DEPARTMENT'S RULES ARE COMPILED IN TITLE 7 OF THE NEW JERSEY ADMINISTRATIVE CODE.

"Hue" means the dominant spectral color, one of the three variables of soil color defined within the Munsell system of classification.

"Hydraulically restrictive horizon" means a horizon within the soil profile which slows or prevents the downward or lateral movement of water and which is underlain by permeable soil horizons or substrata. Any soil horizon which has a saturated permeability less than 0.2 inch per hour or a percolation rate slower than 60 minutes per inch is hydraulically restrictive.

"Hydraulically restrictive substratum" means a substratum below the soil profile which slows or prevents the downward or lateral movement of water and which extends beyond the depth of profile pits or borings or to a massive substratum. A substratum which has a saturated permeability less than 0.2 inch per hour or a percolation rate slower than 60 minutes per inch is hydraulically restrictive.

"Individual subsurface sewage disposal system" or "ISSDS" means a collection of components for disposal of sanitary sewage into the ground which is designed and constructed in conformance with this chapter to treat sanitary sewage in a manner that will retain most of the settleable solids in a septic tank or may incorporate an advanced wastewater pretreatment device and discharges liquid effluent of typical domestic strength to a disposal field. An ISSDS may include advanced wastewater pretreatment. The terms "onsite wastewater treatment system" and "system" are equivalent in meaning.

"Industrial wastes" means solid or liquid wastes resulting from processes employed in industrial establishments or in any commercial establishment engaged in processes which use or generate any of the pollutants or any substance containing any of the pollutants regulated under section 307(a), (b), or (c) of the Federal Clean Water Act of 1977, 33 U.S.C. §§ 1251 et seq., and the regulations promulgated pursuant thereto and any amendments thereto.

"Infiltrative surface" means the interface or contact between the filter material and the soil or fill at the bottom and sidewalls of the disposal bed or each individual disposal trench.

"Install" means to assemble, put in place or connect components of an individual subsurface sewage disposal system in a manner that will permit their use by the occupants of the realty improvement served.

"Interceptor drain" means a subsurface drain designed and constructed to intercept laterally moving perched ground water.

"Invert" means the floor, bottom or lowest portion of the internal cross-section of a closed conduit, used with reference to pipes or fittings conveying sanitary sewage.

"Level of infiltration" means the elevation of the horizontal interface or contact between the filter material and the soil or fill material at the bottom of the filter material.

"Limiting zone" means any horizon or combination of horizons within the soil profile, or any substratum or combination of substrata below the soil profile, which limits the ability of the soil to provide treatment and/or disposal of septic tank effluent. Limiting zones include rock substrata, hydraulically restrictive horizons and substrata, excessively coarse horizons and substrata, perched and regional zones of saturation. Criteria for recognition of limiting zones are given in N.J.A.C. 7:9A-5.5 through 5.9.

"Loamy sand" means a soil textural class, as shown in Figure 3 of Appendix A, that has a maximum of 85 to 90 percent sand with a percentage of silt plus 1.5 times the percentage of clay not in excess of 15; or a minimum of 70 to 85 percent sand with a percentage of silt plus 1.5 times the percentage of clay not in excess of 30.

"Lower plastic limit" means the moisture content corresponding to the transition between the plastic and semi-solid states of soil consistency. This corresponds to the lowest soil moisture content at which the soil can be molded in the fingers to form a rod or wire, one-eighth of an inch in thickness, without crumbling.

"Malfunctioning system" means an individual sewage disposal system which pollutes ground or surface waters or which creates a nuisance or hazard to public health or safety or the environment and includes, but is not limited to, the situations described in N.J.A.C. 7:9A-3.4.

THIS IS A COURTESY COPY OF THIS RULE. ALL OF THE DEPARTMENT'S RULES ARE COMPILED IN TITLE 7 OF THE NEW JERSEY ADMINISTRATIVE CODE.

"Manufacturer" means the company which holds proprietary rights to a system component or technology.

"Massive rock substratum" means a rock substratum which does not contain an adequate number of open and inter-connected fractures to allow unimpeded absorption of applied wastewater and transmission of this wastewater away from the disposal area.

"Massive structure" means one of the soil structural classes which is described in N.J.A.C. 7:9A-5.3(h).

"Minimum drip dose volume" means the volume of water discharged during a dosing event that is necessary to pressurize the entire drip dispersal system and sustain that pressure over a sufficient period to achieve the desired uniformity of discharges between all orifices.

"Mottling" means a color pattern observed in soil consisting of blotches or spots of contrasting color. The term "mottle" refers to an individual blotch or spot. Mottling is an indication of seasonal or periodic and recurrent saturation.

"Mounded disposal field installation" means a type of disposal field installation which is described at N.J.A.C. 7:9A-10.1(b)4.

"Mounded soil replacement disposal field installation" means a type of disposal field installation which is described at N.J.A.C. 7:9A-10.1(b)5.

"Munsell system" means a system of classifying soil color consisting of an alpha-numeric designation for hue, value and chroma, such as "7.5 YR 6/2", together with a descriptive color name, such as "strong brown".

"NJPDES permit" means a permit issued by the Department pursuant to the authority of the Water Pollution Control Act, N.J.S.A. 58:10A-1 et seq., and N.J.A.C. 7:14A for a discharge of pollutants.

"NJPDES" means the New Jersey Pollutant Discharge Elimination System as set forth in N.J.S.A. 58:10A-1 et seq. and in N.J.A.C. 7:14A.

"NTU" or "nephelometric turbidity units" is measure of water clarity.

"O-horizon" means a surface horizon, occurring above the A-horizon in some soils, which is composed primarily of undecomposed or partially decomposed plant remains which have not been incorporated into the mineral soil.

"One hundred year flood plain" means the area inundated by the 100-year flood. A 100-year flood is estimated to have a one percent chance, or one chance in 100, of being equalled or exceeded in any one year. See also N.J.A.C. 7:13.

"Onsite wastewater treatment system" or "OWTS" means an individual subsurface sewage disposal system.

"Operate" means to use or convey a building or facility served by an individual subsurface sewage disposal system or to own a building or facility where such use or occupation exists.

"Perched zone of saturation" means a zone of saturation which occurs immediately above a hydraulically restrictive horizon and which is underlain by permeable horizons or substrata which are not permanently or seasonally saturated.

"Percolation rate" means the rate of fall of water measured in a test hole as prescribed in N.J.A.C. 7:9A-6.4.

"Permeability" means the rate at which water moves through a unit area of soil or rock material at hydraulic gradient of one, determined as prescribed in N.J.A.C. 7:9A-6.2, 6.3, 6.5 or 6.6.

"Permeable" means having a permeability of 0.2 inches per hour or faster or a percolation rate of 60 minutes per inch or faster. The terms "permeable soil", "permeable rock" and "permeable fill" shall be construed accordingly.

"Permit" means a written approval issued by the administrative authority or the Department for the construction, installation, alteration or operation of an individual subsurface sewage disposal system.

THIS IS A COURTESY COPY OF THIS RULE. ALL OF THE DEPARTMENT'S RULES ARE COMPILED IN TITLE 7 OF THE NEW JERSEY ADMINISTRATIVE CODE.

"Person" means an individual, corporation, company, association, society, firm, partnership and joint stock company as well as the State and any political subdivision thereof.

"Piezometer" means a device consisting of a length of metal or plastic pipe, open at the bottom or perforated within a specified interval, and used for the determination of depth to water, permeability or hydraulic head within a specific soil horizon or substratum.

"Platy structure" means one of the soil structural classes described in N.J.A.C. 7:9A-5.3(g).

"Practice of engineering" means any professional service or creative work requiring engineering education, training, and experience and the application of special knowledge of the mathematical, physical and engineering sciences to such professional services or creative work as consultation, investigation, evaluation, planning, design or general supervision of construction or operation for the purpose of assuring compliance with plans, specification and design in connection with any public or private engineering or industrial project.

"Pressure dosing" means a type of effluent distribution which is described in N.J.A.C. 7:9A-9.1.

"Pre-treatment unit" means a septic tank or a grease trap.

"Private access restroom activities" means sanitary sewage generating activities (not associated with shower/bathing activity) that occur at facilities where the typical user of the establishment including the restroom is present in the establishment for more than one hour. These include restroom activities at bathhouses, bowling alleys, day camps, religious institutions, day schools, schools and swimming pools.

"Professional engineer" means a person licensed to practice professional engineering in this State pursuant to N.J.S.A. 48:8-27 et seq.

"Property" means:

1. A single lot as defined by municipal lot and block or right of way (unless paragraph 2 below applies); or
2. The combined area contained within the legal boundaries of two or more contiguous lots where, for any part of each of those lots, there is a shared pecuniary, possessory or other substantial common interest by one or more persons (such as common ownership and/or operation or a common plan of development or sale).

"Public access restroom activities" means sanitary sewage generating activities that occur at establishments where the typical user of the facility is present for one hour or less. These include, but are not limited to, restroom activities at highway rest areas, roadside comfort stations, visitor centers and restaurants (for customers and/or non-customers).

"Real property transfer" means a conveyance of real property from one party to another.

"Realty improvement" means any proposed new residence, commercial building or other premises (including, but not limited to, condominiums, garden apartments, town houses, mobile homes, stores, office buildings, restaurants, hotels and so forth) not served by an approved water supply and approved sewerage system, the useful occupancy of which will require the installation or erection of a water supply system or sewerage facilities. Each dwelling unit in a proposed multiple-family dwelling or each commercial unit in a commercial building shall be construed to be a separate realty improvement.

"Regional zone of saturation" means a zone of saturation which extends vertically without interruption below the depth of soil borings and profile pits.

"Registered Environmental Health Specialist" means an individual licensed as such pursuant to N.J.S.A. 26:1A-41.

"Re-grading" means modification of a land slope by cutting and filling with the native soil or re-distribution of the native soil which is present at the site.

"Repair" means to fix, refurbish or replace one or more components of an individual subsurface sewage disposal system in a manner that will restore, preserve and not change the original location, design, construction and installation, size, capacity, type, or number of the components of the system.

THIS IS A COURTESY COPY OF THIS RULE. ALL OF THE DEPARTMENT'S RULES ARE COMPILED IN TITLE 7 OF THE NEW JERSEY ADMINISTRATIVE CODE.

"Replicate" means one of two or more soil samples or tests taken at the same location (within five feet of each other), and depth, within the same soil horizon or substratum. In the case of fill material, replicate tests are tests performed on sub-samples of the same bulk sample packed to the same bulk density.

"Reservoir" means a surface water body used to store a public drinking water supply or any portion of a tributary water course within one mile upstream of such a surface water body.

"Restricted chemical material" means any chemical material which contains concentrations in excess of one part per hundred, by weight of any halogenated hydrocarbon chemical, aliphatic or aromatic, including, but not limited to, trichloroethane, trichloroethylene, tetrachloroethylene, methylene chloride, halogenated benzenes and carbon tetrachloride; any aromatic hydrocarbon chemical, including, but not limited to, benzene, toluene and naphthalene; any phenol derivative in which a hydroxy group and two or more halogen atoms are bonded directly to a six-carbon aromatic ring, including, but not limited to, trichlorophenol or pentachlorophenol; or acrolein, acrylonitrile, or benzidine. Restricted chemical material does not, however, include any chemical material which is biodegradable and not a significant source of contamination of the ground waters of the State.

"Return manifold" means the pipe to which the distal ends of each lateral in a drip dispersal zone are connected.

"Rock substratum" means a solid and continuous body of rock, with or without fractures, or a weathered or broken body of rock fragments overlying a solid body of rock, where more than 50 percent by volume of the rock fragments are greater than two millimeters in diameter or large enough to be retained on a two millimeter sieve.

"Sand" means a particle size category consisting of mineral particles which are between 0.05 and 2.0 millimeters in equivalent spherical diameter. Also, a soil textural class having 85 percent or more of sand and a content of silt and clay such that the percentage of silt plus 1.5 times the percentage of clay does not exceed 15, as shown in Figure 3 of Appendix A.

"Sandy clay" means a soil textural class having 35 percent or more of clay and 45 percent or more of sand, as shown in Figure 3 of Appendix A.

"Sanitary sewage" means any liquid waste containing animal or vegetable matter in suspension or solution, or the water carried wastes resulting from the discharge of water closets, laundry tubs, washing machines, sinks, dishwashers, or any other source of water carried wastes of human origin or containing putrescible material. This term specifically excludes industrial, hazardous or toxic wastes and materials.

"Scum" means a mass of sewage solids floating at the surface of sewage and buoyed up by entrained gas, grease, or other substances. The term "scum layer" shall be construed accordingly.

"Seasonally high water table" means the upper limit of the shallowest zone of saturation which occurs in the soil, identified as prescribed in N.J.A.C. 7:9A-5.8.

"Seepage pit" means a covered pit with open-jointed lining through which septic tank effluent may seep into the surrounding soil.

"Septic system designer" means a New Jersey licensed professional engineer who prepares engineering plans and specifications for the construction or alteration of individual subsurface sewage disposal systems.

"Septic system enforcement officer" means a New Jersey licensed professional engineer, licensed health officer or registered environmental health specialist, acting as the authorized agent for the administrative authority, who approves, permits, certifies or licenses the construction, installation, alteration, repair or operation of individual subsurface sewage disposal systems or who reviews engineering plans; witnesses site evaluation and testing; and inspects construction or makes determinations that might be used for the granting of such approvals, permits, certifications or licenses.

"Septic system inspector" means a person who performs inspections of systems in accordance with N.J.A.C. 7:9A-12.6 for inspections during real property transfers.

THIS IS A COURTESY COPY OF THIS RULE. ALL OF THE DEPARTMENT'S RULES ARE COMPILED IN TITLE 7 OF THE NEW JERSEY ADMINISTRATIVE CODE.

"Septic system installer" means a person who constructs, installs or alters individual subsurface sewage disposal systems in accordance with approved engineering plans and specifications or who repairs systems in accordance with N.J.A.C. 7:9A-3.3.

"Septic tank" means a water-tight receptacle which receives the discharge of sanitary sewage from a building sewer or part thereof, and is designed and constructed so as to permit settling of settleable solids from the liquid, partial digestion of the organic matter, and discharge of the liquid portion into a disposal field or seepage pit.

"Septic tank effluent" means the primary treated wastewater or sewage discharged through the outlet of a septic tank. The term "effluent" is equivalent in meaning.

"Serial distribution" means a method of distributing septic tank effluent between a series of disposal trenches so that each successive trench receives effluent only after the preceding trenches have become full to overflowing.

"Service contract" means a legal, written agreement between a property owner and an authorized service provider to perform all system startup, maintenance and monitoring requirements identified in this chapter for any system that includes an advanced wastewater pretreatment device, which includes all drip dispersal systems. The agreement must be fully transferable to subsequent owners of the property and renewable.

"Sewage system cleaner" means any solid or liquid material intended or used primarily for the purpose of cleaning, treating, degreasing, unclogging, disinfecting or deodorizing any part of a sewage system but excluding those liquid or solid products intended or used primarily for manual cleaning, scouring, treating, deodorizing or disinfecting the surface of common plumbing fixtures.

"Sewage system" means any part of a wastewater disposal system, including but not limited to all toilets, piping, drains, sewers, septic tanks, grease traps, distribution boxes, dosing tanks, disposal tanks, disposal fields, seepage pits, cesspools or dry wells.

"Silt" means a particle size category consisting of mineral particles which are between 0.002 and 0.05 millimeters in equivalent spherical diameter. It also means a soil textural class having 80 percent or more of silt and 12 percent or less of clay, as shown in Figure 3 of Appendix A.

"Silty clay" means a soil textural class having 40 percent or more of clay and 40 percent or more of silt, as shown in Figure 3 of Appendix A.

"Silty clay loam" means a soil textural class having 27 to 40 percent of clay and less than 20 percent of sand, as shown in Figure 3 of Appendix A.

"Silt loam" means a soil textural class having 50 percent or more of silt and 12 to 27 percent of clay; or 50 to 80 percent of silt and less than 12 percent of clay, as shown in Figure 3 of Appendix A.

"Single grain structure" means one of the soil structural classes which are described in N.J.A.C. 7:9A-5.3(h).

"Single residential occupancy activities" means those activities that are associated with an individual private residence, such as, but not limited to, a single family home, apartment, condominium, townhouse and/ or a duplex home.

"Sink hole" means a topographic depression the origin of which may be attributed to the dissolution and collapse of underlying limestone or dolomite bedrock.

"Sink station activities" means sanitary sewage generating activities associated with, but not limited to, hair styling at beauty salons and parlors.

"Site evaluator" means a New Jersey licensed professional engineer, licensed health officer, registered environmental health specialist or soil scientist who performs site evaluation, soil evaluation or soil testing as prescribed in N.J.A.C. 7:9A-4, 5, and 6.

THIS IS A COURTESY COPY OF THIS RULE. ALL OF THE DEPARTMENT'S RULES ARE COMPILED IN TITLE 7 OF THE NEW JERSEY ADMINISTRATIVE CODE.

"Sludge" means a relatively dense suspension of sewage solids which settle to the bottom of a septic tank, are relatively resistant to biological decomposition, and which collect in the septic tank over a period of time. The term "sludge layer" shall be construed accordingly.

"Soil" means any naturally occurring unconsolidated body of mineral and organic particles derived from the weathering in place of consolidated rock or unconsolidated mineral deposits and the decay of living organisms.

"Soil aggregate" means a naturally occurring unit of soil structure consisting of particles of sand, silt, clay, organic matter, and coarse fragments held together by the natural cohesion of the soil.

"Soil color" means the soil color name and Munsell color designation determined by comparison of the moist soil with color chips contained in a Munsell soil color book.

"Soil consistence" means the resistance of a soil aggregate or clod to being crushed between the fingers or broken by the hands. Terms for describing soil consistence described are in N.J.A.C. 7:9A-5.3(h).

"Soil horizon" means a layer within a soil profile differing from layers of soil above and below it in one or more of the soil morphological characteristics including color, texture, coarse fragment content, structure, consistence and mottling.

"Soil log" means a description of the soil profile which includes the depth, thickness, color, texture, coarse fragment content, mottling, structure and consistence of each soil horizon or substratum.

"Soil mapping unit" means an area outlined on a map in a County Soil Survey Report and marked with a letter symbol designating a soil phase, a complex of two or more soil phases, or some other descriptive term where no soil type has been identified.

"Soil material" means soil as well as any naturally occurring unconsolidated mineral deposit which is not a rock substratum.

"Soil phase" means a specific type of soil which is mapped by the Soil Conservation Service and which belongs to a soil series described within the County Soil Survey Report.

"Soil profile" means a vertical cross-section of undisturbed soil showing the characteristic horizontal layers or horizons of the soil which have formed as a result of the combined effects of parent material, topography, climate, biological activity and time.

"Soil profile pit" means an excavation made for the purpose of exposing a soil profile which is to be described.

"Soil replacement disposal field installation" means a disposal field installed as prescribed in N.J.A.C. 7:9A-10.1(b)2 and 3.

"Soil series" means a grouping of soil types possessing a specific range of soil profile characteristics which are described within the County Soil Survey Report. Each soil series may consist of several "soil phases" which may differ in slope, texture of the surface horizon or stoniness.

"Soil structural class" means one of the shape classes of soil structure described in N.J.A.C. 7:9A-5.3(g).

"Soil structure" means the naturally occurring arrangement, within a soil horizon, of sand, silt and clay particles, coarse fragments and organic matter, which are held together in clusters or aggregates of similar shape and size.

"Soil suitability class" means one of the classes of soil suitability with regard to the installation of an individual subsurface sewage disposal system which are defined based upon the type and depth of limiting zones present, as prescribed in N.J.A.C. 7:9A-5.4.

"Soil texture" means the relative proportions of sand, silt and clay in that portion of the soil which passes through a sieve with two millimeter openings.

"Soil textural class" means one of the classes of soil texture defined within the USDA system of classification. (Soil Survey Manual, Agricultural Handbook No. 18, U.S.D.A. Soil Conservation Service 1962.)

THIS IS A COURTESY COPY OF THIS RULE. ALL OF THE DEPARTMENT'S RULES ARE COMPILED IN TITLE 7 OF THE NEW JERSEY ADMINISTRATIVE CODE.

"Special ordinance" means an ordinance which sets requirements for the location, design, construction, alteration or use of individual subsurface sewage disposal systems which differ from the requirements of this chapter.

"Static water level" means the depth below the ground surface or the elevation with respect to some reference level, of the water level observed within a soil profile pit or boring, or within a piezometer, after this level has stabilized or become relatively constant with the passage of time.

"Stone" means a coarse fragment which is rounded or subrounded in shape and greater than 254 millimeters (10 inches) in diameter.

"Structure" means the same as the definition of the same term under the Realty Improvement Sewerage and Facilities Act (1954) at N.J.S.A. 58:11-25a.

"Subsurface drain" means any open pipe, layer of gravel, stone or coarse sand, or any combination of these elements placed below the surface of the ground and designed or constructed in such a manner as to allow movement of ground water into any surface water body, water course or onto the surface of the ground.

"Substratum" means a layer of soil or rock material present below the soil profile and extending beyond the depth of soil borings or profile pits.

"Suitable fill" means fill material which meets the requirements of N.J.A.C. 7:9A-10.1(f).

"Suitable soil" means unsaturated soil, above the seasonally high water table, which contains less than 50 percent by volume of coarse fragments and which has a permeability between 0.2 and 20 inches per hour or a percolation rate between three and 60 minutes per inch.

"Supply manifold" means the pipe to which the proximal ends of the laterals of a drip dispersal zone are connected to supply water to the dripperline during dosing events.

"Surface water" means any waters of the State which are not ground water.

"System" is an abbreviated designation for "individual subsurface sewage disposal system" and is equivalent in meaning. Cesspools, privies, latrines, pit toilets, outhouses, composting or waterless toilets, direct discharges to the ground surface or water courses, and illegally constructed or altered treatment or disposal mechanisms are not systems.

"System integrator" means a company or individual authorized by an original equipment manufacturer of drip tubing that pre-engineers drip dispersal systems, the required advanced wastewater pretreatment and other necessary parts of a drip dispersal system and authorizes installers and service providers for those systems.

"Test replicate" means one of two or more soil tests performed using the same procedure on each of several soil samples taken within the same soil horizon and at the same location within the proposed disposal field. The term "replicate sample" shall be construed accordingly.

"Textural analysis" means the determination of soil texture by means of a hydrometer analysis and a sieve analysis.

"Treatment works approval" means an approval issued pursuant to N.J.S.A. 58:10A-6 and N.J.A.C. 7:14A-22, or pursuant to former N.J.S.A. 58:12-3 (repealed by P.L. 1977, c. 74, Section 14 effective July 24, 1977).

"Undisturbed soil sample" means a soil sample in which the natural soil structure, porosity and cohesion are preserved intact, and in which the only cracks or planes of separation evident are those occurring naturally between soil aggregates.

"Value" means the relative lightness or intensity of a color, one of the three variables of soil color defined within the Munsell system of classification.

"Very firm consistence" means a type of soil consistence which is described in N.J.A.C. 7:9A-5.3(h).

"Very hard consistence" means a type of soil consistence which is described in N.J.A.C. 7:9A-5.3(h).

THIS IS A COURTESY COPY OF THIS RULE. ALL OF THE DEPARTMENT'S RULES ARE COMPILED IN TITLE 7 OF THE NEW JERSEY ADMINISTRATIVE CODE.

"Volume of sanitary sewage" means the maximum volume of sanitary sewage which may reasonably be expected to be discharged from a residential, commercial, or institutional facility on any day of operation, determined as prescribed in N.J.A.C. 7:9A-7.4 and expressed as gallons or, for the purpose of this chapter, in gallons per day. The volume of sanitary sewage shall not be considered as an average daily flow, but shall incorporate a factor of safety over and above the average daily flow which is adequate to accommodate peak sanitary sewage flows or facilities which discharge greater than the average volumes of sanitary sewage either occasionally or on a regular basis. The use of water saving devices shall not be used as a basis for reducing estimates of the volume of sanitary sewage.

"Water course" means any stream or surface water body, or any ditch or subsurface drain that will permit drainage into a surface water body. This term does not include swales or roadside ditches which convey only direct runoff from storms or snow melting, and storm sewers designed and constructed in a manner that will prevent infiltration of ground water into the pipe or lateral movement of ground water through the excavation in which the pipe has been laid. Water course includes all wetlands and subsurface drains with an above-ground or surface water outlet.

"Water service line" means any underground conduit to convey potable or non-potable water.

"Water table" means the upper surface of a zone of saturation.

"Waters of the State" means the ocean and its estuaries, all springs, streams, wetlands and bodies of surface and ground water, whether natural or artificial, within the boundaries of this State or subject to its jurisdiction.

"Well" means a bored, drilled or driven shaft, or a dug hole, which extends below the seasonally high water table and which has a depth which is greater than its largest surface dimension.

"Wetland" means any area inundated or saturated by surface or ground water at a frequency or duration sufficient to support, and which under normal circumstances does support, a prevalence of vegetation typically adapted for life in saturated soil conditions, commonly known as hydrophytic vegetation. Wetlands generally include swamps, marshes, bogs and similar areas.

"U.S.D.A. system of classification" means the system of classifying soil texture used by the United States Department of Agriculture which defines 12 soil textural classes based upon the weight percentages of sand, silt and clay in that portion of the soil which passes through a sieve with two millimeter openings. The soil textural classes are shown graphically on the soil textural triangle, Figure 3 of Appendix A.

"Zone of disposal" means the permeable layers of soil or rock material below the zone of treatment which permit downward movement of the septic tank effluent and lateral movement of this effluent away from the area of the disposal field.

"Zone of treatment" means the upper four feet of suitable soil or fill material, below the level of infiltration, which remove pollutants from the septic tank effluent by processes which include physical filtration of bacteria, adsorption of viruses and bacteria by clay and organic matter, biological destruction of pathogens by soil microorganisms, chemical fixation or precipitation of phosphorous, bio-chemical transformations of nitrogen compounds and biological assimilation of phosphorous and nitrogen.

"Zone of saturation" means a layer within or below the soil profile which is saturated with ground water either seasonally or throughout the year.

Subchapter 3. Administration

7:9A-3.1 Ordinances

(a) The administrative authority may adopt this chapter by reference as allowed by N.J.S.A. 26:3-69 to 69.6.

(b) For the purpose of this chapter, the term "special ordinance" means any ordinance which differs in any detail from this chapter. Within 10 days after adoption of a special ordinance, the administrative authority shall forward to the Department a copy of the ordinance together with a written statement in which all provisions which differ

THIS IS A COURTESY COPY OF THIS RULE. ALL OF THE DEPARTMENT'S RULES ARE COMPILED IN TITLE 7 OF THE NEW JERSEY ADMINISTRATIVE CODE.

from this chapter are identified, the reasons for the differences are explained and all supporting facts and data are provided. Where requirements differing from the requirements of this chapter are proposed in order to conform with the requirements of the Pinelands Comprehensive Management Plan, the appropriate section(s) of the Plan shall be cited.

(c) The administrative authority shall not adopt an ordinance which is less stringent than this chapter.

7:9A-3.2 New systems

All aspects of the location, design, construction, installation, operation, and maintenance of new individual subsurface sewage disposal systems shall comply with the requirements of these standards and any conditions specified in a treatment works approval.

7:9A-3.3 Existing systems

(a) Existing systems serving existing structures may continue to be used without change provided that these systems are compliant with the conditions upon which they were approved, are not malfunctioning in accordance with N.J.A.C. 7:9A-3.4, and there is no expansion or change in use of the existing structure that increases the estimated volume of sanitary sewage from the structure (calculated in accordance with N.J.A.C. 7:9-7.4) or changes the type of waste generated (as prescribed in N.J.A.C. 7:9A-7.3).

(b) Existing systems associated with a realty improvement or structure that undergoes a reconstruction as defined in the Uniform Construction Code, N.J.A.C. 5:23, without a change in use, may be approved to be used by the administrative authority when:

1. A system designer has certified that all aspects of the location, design, construction, installation and operation of the existing system are in conformance with the requirements of this chapter or the system will be altered so that it will be in conformance with the requirements of this chapter. If the property cannot support a system in conformance with the requirements of this chapter, the owner shall apply for approval to utilize a holding tank in accordance with N.J.A.C.7:9A-3.12.; or
2. A septic system designer certifies that the existing septic tank and disposal field do not exhibit any condition representative of non-compliance, including any of the malfunction criteria listed at N.J.A.C. 7:9A-3.4(b), and are adequate to treat and dispose of the estimated volume and type of sanitary sewage generated by the reconstructed structure, the existing system may continue to be used, limited to the following cases:
 - i. The reconstruction is necessitated by a catastrophic event, such as fire, storm or flood; or
 - ii. The existing system was approved by the administrative authority after December 31, 1996.

(c) When an existing system is serving an existing structure and is not malfunctioning, and the owner proposes a change to the structure or the use of the structure that will change in any way the estimated volume of sanitary sewage or the type of waste generated, the system may continue to be used if it is demonstrated that the wastewater generated will not exceed the treatment and disposal capability of the existing system by submission of either:

1. A prior approval for the existing system issued by the administrative authority or Department that demonstrates that the existing system is adequate to treat and dispose of the estimated volume and type of sanitary sewage generated by the proposed expanded structure or new use of the existing structure; or
2. A certification by a septic system designer that all components of the existing system are adequate to treat and dispose the estimated volume of sanitary sewage and the type of waste generated.

(d) When an existing system serving an existing structure is in need of repair for any reason, the repair shall be made in a manner that restores and preserves the original approved design, and does not change the original location, size, capacity, type, or number of components of the system.

THIS IS A COURTESY COPY OF THIS RULE. ALL OF THE DEPARTMENT'S RULES ARE COMPILED IN TITLE 7 OF THE NEW JERSEY ADMINISTRATIVE CODE.

1. If the existing system is malfunctioning or otherwise non-compliant as described in N.J.A.C. 7:9A-3.4, the repair shall be done in a manner that eliminates the cause of the malfunction, addresses the non-compliance, and ensures that the system will not, with proper operation and maintenance, result in future non-compliance; and

2. If the disposal field requires repair due to a malfunction, the information in (d)2i and ii below shall also be provided to the administrative authority.

i. A certification by a septic system designer prior to the issuance of the approval by the administrative authority that:

(1) The repaired disposal field will be adequate to treat and dispose of the estimated volume of sanitary sewage and the type of waste generated; and

(2) If there is a malfunctioning condition, the repair will correct the malfunctioning condition.

ii. A final as-built drawing signed and sealed by a septic system designer after the repair is completed if any inconsistencies from the original system design are identified during the repair or if original drawings of the system are not currently on file with the administrative authority.

(e) When an existing system associated with an existing structure is to be altered for any reason, including an expansion or change in use of the structure(s) served, alterations shall meet the requirements of a new system in N.J.A.C. 7:9A-3.2 except as indicated below. If the scope of the alteration is such that it constitutes the practice of professional engineering according to N.J.S.A. 45:8-1 et seq. and the rules adopted pursuant thereto, then such alterations shall be made in conformance with plans and specifications signed and sealed by a septic system designer. Any alteration to a disposal field constitutes the practice of professional engineering.

1. If the alteration is not necessitated due to a malfunction, and the owner does not propose to expand or change the use of the associated structure in a manner that will increase the estimated volume of sanitary sewage or type of waste, the administrative authority shall approve the alteration if it is determined to be protective of human health and the environment and will be completed in a manner that brings the system closer to conformance with the requirements of this chapter.

2. If the existing system is proposed to be altered because it is malfunctioning as described in N.J.A.C. 7:9A-3.4 and the owner does not propose to expand or change the use of the associated structure in a manner that will increase the estimated volume of sanitary sewage or type of waste, the alteration shall:

i. Be performed in a manner that will bring the system into conformance with this chapter, eliminate the cause of the malfunction and assure that, with proper operation and maintenance, the system design will not cause future malfunction; and

ii. If it is not possible to bring the system into conformance with this chapter, the system shall be brought as close to conformance with the requirements of this chapter as the administrative authority determines is possible, provided the system as improved results in a discharge that is protective of human health and the environment. If the administrative authority is not able to approve a system under this subparagraph, application shall be made for approval to utilize a holding tank in accordance with N.J.A.C. 7:9A-3.12(b).

7:9A-3.4 Non-compliant systems

(a) There are two types of non-compliant systems:

1. Systems that do not perform as approved, or that malfunction, as identified in (b) below; and

2. Systems that are not constructed, operated or maintained in accordance with the requirements of this chapter or as specified in an approval issued by either the Department or the administrative authority.

(b) Indications that an individual subsurface sewage disposal system is malfunctioning include but are not limited to the following:

THIS IS A COURTESY COPY OF THIS RULE. ALL OF THE DEPARTMENT'S RULES ARE COMPILED IN TITLE 7 OF THE NEW JERSEY ADMINISTRATIVE CODE.

1. Contamination of nearby wells or surface water bodies by sewage or effluent as indicated by the presence of fecal bacteria where the ratio of fecal coliform to fecal streptococci is four or greater;
2. Ponding or breakout of sewage or effluent onto the surface of the ground;
3. Seepage of sanitary sewage or effluent into portions of buildings below ground;
4. Back-up of sanitary sewage into the building served which is not caused by a physical blockage of the internal plumbing;
5. Any leakage from or into septic tanks, connecting pipes, distribution boxes and other components that are not designed to discharge sanitary sewage or effluent; or
6. Any discharge of sanitary sewage without a zone of treatment.

(c) The owner or owner's agent shall immediately notify the administrative authority upon detection of a potential non-compliant system, as described in (a) above.

(d) Whenever the administrative authority has knowledge through report or direct observation of the existence of a potential non-compliant system, it shall investigate and take all steps necessary to determine whether the system is non-compliant. Only the administrative authority or the Department shall determine that a system is non-compliant.

(e) When a system has been determined to be non-compliant, the owner shall take immediate steps to correct the non-compliance. When it becomes necessary to repair or replace one or more of the system components or to make alterations to the system, all the following requirements shall be met:

1. The owner shall obtain prior approval from the administrative authority or its authorized agent for any repairs or alterations made.
2. Alterations made to correct a malfunctioning system shall meet the requirements of N.J.A.C. 7:9A-3.3(e)2. In cases where the alteration does not involve the practice of engineering as defined by N.J.S.A. 45:8-28(b), the administrative authority or its authorized agent may approve plans and specifications prepared by a septic system installer rather than a licensed professional engineer.
3. When the malfunction involves continuous discharge of sewage or septic tank effluent onto the surface of the ground or into a watercourse, the use of the system shall cease until repairs or alterations have been completed in a manner which is satisfactory to the administrative authority. In such cases, the administrative authority may permit continued occupation of the building served provided that further surface discharge of sewage or septic tank effluent is prevented by the installation of a holding tank or use of an existing septic system component as a holding tank. The latter may be accomplished by pumping-out the septic tank, dosing tank, seepage pit or other system component at an adequate frequency to prevent overflow.

(f) Upon receipt of notification of the existence of a potentially non-compliant system identified during an inspection done in accordance with N.J.A.C. 7:9A-12.6, the administrative authority shall respond to the notification and shall provide its findings to the system owner within 10 business days after the notification. If immediate action is necessary to abate a potential public health or environmental impact, the administrative authority shall respond to the non-compliant system according to its standard operating procedures.

(g) Any food service establishment which generates grease and experiences a malfunction must, at a minimum, upgrade the grease removal components to the requirements of N.J.A.C. 7:9A-8.1.

(h) The administrative authority may, under certain circumstances, approve as a last resort, the permanent use of a holding tank in accordance with the requirements in (i) below to correct the problem of a malfunctioning system which cannot be repaired or altered in a satisfactory manner. Such approval may be granted by the administrative authority only if prior written approval has been granted by the Department and one of the following criteria is met:

THIS IS A COURTESY COPY OF THIS RULE. ALL OF THE DEPARTMENT'S RULES ARE COMPILED IN TITLE 7 OF THE NEW JERSEY ADMINISTRATIVE CODE.

1. The malfunctioning system serves a single family dwelling or other facility falling within the limitations set forth in N.J.A.C. 7:9A-1.8 and the system was constructed prior to the effective date of this chapter; or
2. The malfunctioning system serves a facility which exceeds the limitations set forth in N.J.A.C. 7:9A-1.8 but was constructed prior to March 6, 1981, the effective date of the NJPDES rules (N.J.A.C. 7:14A).

(i) The Department and the administrative authority may approve the permanent use of a holding tank to correct the problem of a malfunctioning system only when all of the following facts have been established to the satisfaction of the administrative authority and the Department:

1. The present malfunctioning system poses a threat or a potential threat to ground or surface water quality or public health or safety or the environment;
2. Due to site conditions, lot configuration, financial circumstances or other constraints, repair, or alteration of the system in a manner that will eliminate the cause of the malfunction is not feasible;
3. Public sewers are not available as established at N.J.A.C. 7:9A-1.6(e);
4. Reduction of disposal field hydraulic loading by means of water-saving plumbing fixtures will not correct the malfunction; and
5. Assurances are given that the holding tank will be emptied and the contents disposed of in a manner which complies with all applicable local, State and Federal ordinances, statutes and regulations. As a means of confirmation, the owner of the system shall install a water meter and shall submit to the administrative authority on a quarterly basis, evidence of dates and quantities of sewage removed, name of person(s) or firm(s) contracted to remove the sewage, the name of the facility(s) to which the sewage is taken, as well as any other evidence or information which is requested by the administrative authority.

7:9A-3.5 Permit to construct or alter

(a) A person shall not construct, install, repair or alter an individual subsurface sewage disposal system until the administrative authority or its authorized agent has issued a permit for such construction, installation, repair or alteration.

(b) The administrative authority or its authorized agent shall not issue a permit to construct, install or alter an individual subsurface sewage disposal system until an application has been submitted as prescribed in (c) below and, based upon a review of the application submitted, the location and design of the proposed system are found by the administrative authority or its authorized agent to be in conformance with the requirements of this chapter.

(c) The applicant shall submit a complete, accurate and properly executed application to the administrative authority. All soil logs, soil testing data, design data and calculations, plans and specifications, and other information submitted in connection with the subsurface sewage disposal system design shall be signed and sealed by a septic system designer except where N.J.A.C. 7:9A-3.3(d) or (e) allows otherwise. The application shall include the following information:

1. Key maps showing the approximate boundaries of the lot on a U.S. Geological Survey (U.S.G.S.) topographic quadrangle or other accurate map and on a U.S.D.A. soil survey map, which is available from the Natural Resource Conservation Service (NRCS). A good quality photo-copy reproduction of the U.S.G.S. quadrangle or U.S.D.A. soil survey map may be used for this purpose;
2. Full build-out plans of the property if it is part of a common plan of development or sale;
3. A site plan, prepared in accordance with N.J.A.C. 13:40-7 and drawn at a scale adequate to depict clearly the following features within a 150 foot radius around the proposed system:
 - i. Location of all components of the proposed system including, but not limited to, septic tanks, grease traps, dosing tanks, distribution boxes, distribution laterals, disposal fields, interceptor drains and seepage pits;

THIS IS A COURTESY COPY OF THIS RULE. ALL OF THE DEPARTMENT'S RULES ARE COMPILED IN TITLE 7 OF THE NEW JERSEY ADMINISTRATIVE CODE.

- ii. Boundaries of lot;
 - iii. Locations of existing and proposed buildings roadways, subsurface drains, wells and disposal areas on same lot and on adjacent lots;
 - iv. Existing and finished grade topography (two foot contour interval) using absolute elevations or relative elevations referenced to a permanent bench-mark;
 - v. Location of all surface water bodies, natural and artificial, and all springs or areas of ground water seepage;
 - vi. Location of existing and proposed surface water diversions;
 - vii. Location of all outcrops of bedrock;
 - viii. Conformance with setback requirements as required in N.J.A.C. 7:9A-4.3;
 - ix. Location of all soil profile pits, soil borings and permeability tests;
 - x. Location of riparian zones, flood hazard areas and floodways and streams within the near vicinity of the site; and
 - xi. State approved boundaries of any wetland areas or transition areas within the boundaries of the property or within 150 feet of the area of the proposed system. Alternatively, the applicant may submit evidence of compliance with the requirements of N.J.A.C. 7:7A as provided pursuant to N.J.A.C. 7:9A-4.7(b) or (c).
4. Soil logs prepared as prescribed in N.J.A.C. 7:9A-5.3;
 5. Soil suitability class(es) determined as prescribed in N.J.A.C. 7:9A-5.4;
 6. Results of permeability tests performed as prescribed in N.J.A.C. 7:9A-6, including all test data and calculations;
 7. Maximum expected daily volume of sanitary sewage and method of calculation. For properties that are part of a common plan of development or sale, the estimated volume of sanitary sewage shall be estimated from the maximum daily activities at the property after completion of the common plan of development or sale;
 8. Detailed engineering plans and specifications for all components of the systems; and
 9. All data and calculations used in the design of the system.
- (d) Applications shall be made using standard forms provided in Appendix B of this chapter or forms provided by the administrative authority which contain all of the information required on the standard forms in Appendix B. The administrative authority or its authorized agent may require additional data or the completion by the applicant of additional application forms.
- (e) The administrative authority or its authorized agent shall include an expiration date in every permit to construct, install, alter or repair an individual subsurface sewage disposal system. The expiration date shall not exceed five years from the effective date of the permit.
- (f) Other than field modifications in accordance with N.J.A.C. 7:9A-3.7, any administrative authority that receives information following the issuance of any permit to install, construct, repair or alter, which contradicts or otherwise may invalidate the issuance of the original permit, shall require the cessation of installation, construction, repair or alteration activities on the system, as applicable, and determine the accuracy of the information. If the administrative authority verifies information that invalidates the conditions on which the original permit was based, the administrative authority shall:
1. Rescind the approved permit for any system on which construction was not completed and certified in accordance with N.J.A.C. 7:9A-3.13 and direct the permittee to amend the application with information that accurately reflects actual site conditions and an appropriate system design; or

THIS IS A COURTESY COPY OF THIS RULE. ALL OF THE DEPARTMENT'S RULES ARE COMPILED IN TITLE 7 OF THE NEW JERSEY ADMINISTRATIVE CODE.

2. Direct the permittee to institute remedial measures in situations where system construction has been completed and certified, and to reapply with an application that accurately reflects actual site conditions and an appropriate system design.

7:9A-3.6 Witnessing of soil evaluation and testing

(a) The administrative authority or its authorized agent shall witness the excavation of soil profile pits and borings, in-situ permeability testing or soil sample collection and any other site evaluation procedure relied upon in the design or location of the system. The administrative authority or its authorized agent may require a maximum of 15 business days prior to written notice for the purpose of witnessing of soil evaluation or testing procedures.

(b) The administrative authority may waive the requirements for witnessing of soil evaluation or testing procedures which are identified in (a) above. Failure of the administrative authority or its authorized agent to be present when 15 business days prior written notice has been given shall be construed to be a waiver of the witnessing requirements.

7:9A-3.7 Modification of plans

(a) Modification of plans or specifications for an individual subsurface sewage disposal system made subsequent to approval of the plans shall not be carried out unless the revisions are in conformance with the requirements of this chapter and noted on a revised set of plans which have been signed, sealed and dated by a licensed professional engineer and approved by the administrative authority or its authorized agent.

(b) Any modification to plans or specifications made without approval of the administrative authority shall render the original approval null and void and a new application shall be required.

(c) The administrative authority or its authorized agent may require the revision of plans or specifications as it deems necessary if conditions found prior to or during construction warrant such change in order to obtain conformance with the provisions of this chapter.

7:9A-3.8 Pinelands area approvals

The administrative authority shall not approve an application to construct, install or alter an individual subsurface sewage disposal system within the Pinelands area (as defined in N.J.S.A. 13:18A-1 et seq.) until the Pinelands Commission has issued a Notice of Filing, Certificate of Compliance, Certificate of Filing, development approval, or a written statement that no approval from the Pinelands Commission is required. All approvals issued by the administrative authority shall be consistent with the requirements of N.J.A.C. 7:50-5 and 6, and shall be reported to the Pinelands Commission in accordance with N.J.A.C. 7:50-4.

7:9A-3.9 Treatment works approval

(a) A treatment works approval issued by the Department pursuant to this chapter is required for:

1. Any project which is required to obtain a sewerage facilities certification from the Department pursuant to N.J.S.A. 58:11-25.1;
2. Any design of a new or expanded individual subsurface sewage disposal system which will not conform with one or more requirements of this chapter;
3. Any design that incorporates an experimental system or component pursuant to N.J.A.C. 7:9A-3.11;
4. Any design that incorporates wastewater treatment in order to meet effluent discharge limitations or ground and/or surface water quality standards as prescribed by applicable State or Federal regulations or statutes; or
5. Any design in which sanitary sewage will not flow by gravity from the realty improvement to the septic tank.

(b) A treatment works approval required for the certification of sewerage facilities pursuant to (a)1 above shall follow the requirements in N.J.A.C. 7:9A-3.18.

THIS IS A COURTESY COPY OF THIS RULE. ALL OF THE DEPARTMENT'S RULES ARE COMPILED IN TITLE 7 OF THE NEW JERSEY ADMINISTRATIVE CODE.

(c) Upon determining that a proposed design requires a treatment works approval for a deviation from this chapter, the administrative authority shall direct the applicant to apply to the Department for a treatment works approval.

(d) The administrative authority shall endorse by signing treatment works approval applications to certify that the proposed design otherwise meets the standards of this chapter and local requirements, except for the aspect(s) for which the treatment works approval is being sought.

(e) Applications for treatment works approvals shall be made on forms available from the Department and shall be accompanied by the required application fee, as set forth in N.J.A.C. 7:14A-22.25. Application forms and instructions regarding administrative and technical submission requirements, which may be established by the Department in a technical manual prepared in accordance with N.J.S.A. 13:1D-111, may be obtained from the Department's website at www.state.nj.us/dep/ or by contacting the Department at the following address:

Department of Environmental Protection
401-02B
Division of Water Quality
Bureau of Nonpoint Pollution Control
Post Office Box 420
Trenton, N.J. 08625-0420

(f) Each application for a treatment works approval shall include:

1. Proposed system designs;
2. Endorsement by the administrative authority specified at (d) above; and
3. Supporting documentation that proves that the proposed design will protect surface and ground water quality to at least the same degree as the system requirements in this chapter.

(g) In reviewing a treatment works approval application, the Department will determine whether to grant an approval based upon the following criteria:

1. Protection of public health and safety, and the environment;
2. Protection of water quality;
3. Appropriate assurance of adequate operation, maintenance and management of the system;
4. System design and expected performance;
5. Structural stability of the system and any adjacent improvements; and
6. Impacts to adjacent properties.

(h) The Department shall not issue a treatment works approval for the construction of any system that would create a waiver from an administrative authority ordinance or a Federal, State, county or local law, rule or regulation other than this chapter.

(i) Upon the issuance of a treatment works approval by the Department pursuant to this chapter, the administrative authority may issue final design approvals. Final design approvals issued by the administrative authority must reflect all deviations from this chapter as specified in the treatment works approval and must be conditioned upon compliance with any requirements contained in the treatment works approval.

7:9A-3.10 NJPDES permits

(a) Individual subsurface sewage disposal systems which serve single family dwelling units and which are located, designed, constructed, installed, altered, repaired and operated in conformance with the requirements set forth in

THIS IS A COURTESY COPY OF THIS RULE. ALL OF THE DEPARTMENT'S RULES ARE COMPILED IN TITLE 7 OF THE NEW JERSEY ADMINISTRATIVE CODE.

these standards are exempt from NJPDES permit requirements in accordance with N.J.A.C. 7:14A-7.4(a)1 and 8.1(b)2ii.

(b) Subsurface sewage disposal systems which serve facilities other than single family dwelling units and which are located, designed, constructed, installed, altered, repaired and operated in conformance with the requirements set forth in this chapter, and N.J.S.A. 58:11-43 et seq. where these restrictions are applicable, are deemed to have a NJPDES permit-by-rule pursuant to N.J.A.C. 7:14A-7.5(a)1 and 8.5(b)1

(c) When the proposed system does not fall into either of the categories outlined in (a) or (b) above, the administrative authority shall direct the applicant to apply to the Department for a NJPDES permit.

7:9A-3.11 Experimental systems

The Department encourages the development and use of new technologies which may improve the treatment of sanitary sewage prior to discharge or allow environmentally safe disposal of sanitary sewage in areas where standard sewage disposal systems might not function adequately. Where the design, location, construction or installation of the system or any of its components does not conform to this chapter, the administrative authority shall direct the applicant to apply to the Department for a treatment works approval. Depending upon the volume and quality of the wastewater discharged, a NJPDES permit may also be required.

7:9A-3.12 Holding tanks

(a) The administrative authority may approve the use of a temporary sanitary sewage holding tank in lieu of an individual subsurface sewage disposal system, as a temporary means of waste disposal, for a period not to exceed 180 days, where alteration or repair of an existing system is being implemented as approved by the administrative authority. An existing septic tank or a portable holding tank may be used as a temporary sanitary sewage holding tank.

(b) The administrative authority may approve permanent use of a holding tank in the case of a malfunctioning system, subject to approval by the Department, as allowed in N.J.A.C. 7:9A-3.4(h).

(c) Where an existing cesspool, privy, outhouse, latrine or pit toilet is required to be abandoned pursuant to N.J.A.C. 7:9A-3.16, the administrative authority may approve the permanent use of a holding tank if:

1. The property is unable to support a system; and
2. The holding tank is approved under a treatment works approval issued by the Department pursuant to N.J.A.C. 7:14A.

7:9A-3.13 Certificate of compliance

(a) Prior to issuance of a certificate of compliance, the administrative authority or its authorized agent shall make sufficient inspections during the course of construction and installation or alteration of the individual subsurface sewage disposal system to determine that the system has been located, constructed and installed or altered in compliance with the requirements of this chapter and the approved engineering design. Alternatively, the administrative authority may issue a certificate of compliance if a licensed professional engineer submits to the administrative authority, a statement in writing, signed and sealed by him or her that the said system has been located, constructed, installed or altered in compliance with the requirements of these standards and the approved engineering design.

(b) The administrative authority or authorized agent may require additional permeability tests to be conducted, the disposal field excavation to be deepened, fill material to be added or other changes to be made in the installation of the system if, during the course of excavation, soil limitations not identified previously are discovered. Such changes shall be made as prescribed in N.J.A.C. 7:9A-3.7.

(c) A component of an individual subsurface sewage disposal system shall not be backfilled or otherwise concealed from view until a final inspection has been conducted by the administrative authority or its authorized

THIS IS A COURTESY COPY OF THIS RULE. ALL OF THE DEPARTMENT'S RULES ARE COMPILED IN TITLE 7 OF THE NEW JERSEY ADMINISTRATIVE CODE.

agent, or a licensed professional engineer, and permission has been granted by the administrative authority to backfill the system. Any component of the system which has been covered without such permission shall be uncovered upon the order of the administrative authority or its authorized agent.

(d) A person shall not commence operation or use of an individual subsurface sewage disposal system until a certificate has been issued by the administrative authority or its authorized agent indicating that said system has been located, constructed, installed or altered in compliance with this chapter. The issuance of a certificate of compliance shall constitute only certification that the individual subsurface sewage disposal system has been constructed, located, installed or altered in conformance with this chapter. It shall not be construed as a guarantee that the system will function satisfactorily, nor shall it in any way restrict the powers or responsibilities of the administrative authority or the Department in the enforcement of any law or ordinance relating to public health and safety or environmental protection.

(e) The administrative authority or its authorized agent shall give to the building inspector or similar official of the municipality who is responsible for the issuance of occupancy permits a copy of the certificate of compliance.

7:9A-3.14 Notification of proper operation and maintenance practices

(a) The administrative authority shall notify each property owner issued approval for the design, construction, installation, alteration or repair of an individual subsurface sewage disposal system after January 1, 1990 of the proper operation and maintenance practices.

(b) Written notification of the proper operation and maintenance practices shall initially be issued to the applicant with the approval for the location, design, construction, installation, alteration or repair of the individual subsurface sewage disposal system and reissued on a triennial basis to the present property owner. For approvals issued before June 21, 1993, the notification shall be accomplished by December 21, 1993 and reissued on a triennial basis, thereafter.

(c) The written notification shall inform the present property owner how to properly operate and maintain an individual subsurface sewage disposal system. A mass mailing to all property owners who have individual subsurface sewage disposal systems is an acceptable method of notice. The notice shall include, at a minimum:

1. A general outline of how an individual subsurface sewage disposal system works and the potential impact of improper operation and maintenance on system performance, ground and surface water quality, and public health;
2. The recommended frequency of septic tank and grease trap pumping to prevent over-accumulation of solids, and methodology for inspection to determine whether pumping is necessary;
3. A list of materials containing toxic substances which are prohibited from being disposed of into an individual subsurface sewage disposal system;
4. A list of inert or non-biodegradable substances which should not be disposed of within an individual subsurface sewage disposal system;
5. Proper practices for maintaining the area reserved for sewage disposal;
6. Impacts upon system performance resulting from excessive water use; and
7. Warning signs of poor system performance or malfunction and recommended or required corrective measures.

(d) The written notification may be developed by the administrative authority, or the administrative authority may distribute copies of relevant guidance material and/or technical manuals for onsite wastewater treatment systems subject to this chapter made available by the Department.

THIS IS A COURTESY COPY OF THIS RULE. ALL OF THE DEPARTMENT'S RULES ARE COMPILED IN TITLE 7 OF THE NEW JERSEY ADMINISTRATIVE CODE.

7:9A-3.15 Records

(a) The administrative authority or its authorized agent shall maintain records and shall keep on file copies of the following documents:

1. Applications and plans and specifications for the construction, installation or alteration of individual subsurface sewage disposal systems, including all forms and data submitted by the applicant;
2. Permits issued for the construction, installation or alteration of individual subsurface sewage disposal systems;
3. Modifications to plans made subsequent to the issuance of a permit to construct, install or alter individual subsurface sewage disposal systems;
4. Reports of construction inspections made prior to issuance of a certificate of compliance for an individual subsurface sewage disposal system;
5. Certificates of compliance issued for individual subsurface sewage disposal systems;
6. Inspection reports, plans and specifications for repair or alteration of malfunctioning individual subsurface sewage disposal systems or components of malfunctioning systems. Information about all verified non-compliant malfunctioning systems shall be recorded in a format provided by the Department; and
7. All records of septic system inspections submitted in accordance with the requirements of N.J.A.C. 7:9A-12.6.

(b) Files containing records or documents listed in (a) above shall be available upon request for inspection by personnel of the Department.

(c) The administrative authority or its administrative agent shall maintain records until such time as the realty improvement served by the proposed or existing subsurface sewage disposal system is removed or connected to a public sewer.

(d) The administrative authority shall submit electronically, in a format or manner compatible with the Department's electronic reporting system, an annual report to the Department, by February 1 of every year. The report shall include:

1. The total number of systems known to be present in each municipality;
2. The types of inspections conducted on systems and the number of each type conducted;
3. The types of permits issued by the administrative authority and the number of each type issued;
4. The number, type and apparent cause of verified non-compliant systems; and
5. A description of areas known to have higher than normal rates of non-compliance.

7:9A-3.16 Other sanitary sewage disposal units

(a) Cesspools, privies, outhouses, latrines, pit toilets or similar sanitary sewage disposal units are not systems. When an administrative authority discovers a privy, outhouse, latrine, pit toilet or similar sanitary sewage disposal unit, or any cesspool that serves a structure and that is in need of repair or alteration, it must order these units be abandoned and a conforming system installed except:

1. If it is not possible to bring the system into conformance with this chapter, the system shall be brought as close to conformance with the requirements of this chapter as the administrative authority determines is possible, provided the system as improved results in a discharge that is protective of human health and the environment; or
2. If the administrative authority is not able to approve a system under (a)1 above, application shall be made for approval to utilize a holding tank in accordance with N.J.A.C. 7:9A-3.12(c).

THIS IS A COURTESY COPY OF THIS RULE. ALL OF THE DEPARTMENT'S RULES ARE COMPILED IN TITLE 7 OF THE NEW JERSEY ADMINISTRATIVE CODE.

(b) Effective June 2, 2012, except as provided at (c) below, all cesspools, privies, outhouses, latrines and pit toilets that are part of a real property transfer shall be abandoned and replaced with a system in accordance with (a) above.

(c) A cesspool that is not malfunctioning may continue to serve the structure after a real property transfer only in the following circumstances:

1. A conveyance for a consideration of less than \$100.00;
2. A conveyance by or to the United States of America, the State of New Jersey, or any instrumentality, agency or subdivision thereof;
3. A conveyance encumbering realty, or providing for the modification, release or discharge of a debt, obligation or encumbrance, or the foreclosure of a mortgage or lien, or sheriff and execution sales;
4. A deed which confirms or corrects a deed previously recorded;
5. A sale for delinquent taxes or assessments and the foreclosure of same;
6. Judicial proceedings affecting interests in real estate, and documents filed in connection thereto;
7. A conveyance by a receiver, trustee in bankruptcy or liquidation, or assignee for the benefit of creditors;
8. A deed eligible to be recorded as an "ancient deed" pursuant to N.J.S.A. 46:16-7;
9. A deed or map that memorializes subdivisions of land, or which creates or affects easements or restrictions or other burdens upon title;
10. A conveyance between family members or former spouses;
11. Execution of a lease or license;
12. In specific performance of final judgment;
13. A deed releasing a right of reversion;
14. A deed by a executor or administrator of a decedent to a devisee or heir to effect distribution of the decedent's property in accordance with the provisions of the decedent's will or the intestacy laws of New Jersey, or the passage of title by intestacy or descent; or
15. A deed to effectuate a boundary line agreement.

(d) A person claiming to qualify for an exemption under (c) above shall document the exemption that applies by providing to the administrative authority applicable State of New Jersey Affidavit of Consideration of Use forms available through the New Jersey Department of Treasury and all supporting documentation.

7:9A-3.17 System professionals

(a) An authorized installer shall, upon request, provide the Department or the administrative authority with written evidence from those manufacturers and/or system integrators certifying that the installer has sufficient knowledge to install the proprietary technologies in accordance with all manufacturer specifications and this rule pursuant to N.J.A.C.7:9A-8.3, 9.8 and 10.8, as applicable. Beginning January 1, 2013, an authorized installer shall also be in possession of a valid Certified Installer of Onsite Wastewater Treatment Systems (CIOWTS) Advanced Level certification from the National Environmental Health Association (NEHA).

(b) An authorized service provider shall, upon request, provide the Department or the administrative authority with either:

1. Written evidence from manufacturers and/or system integrators certifying that the service provider is sufficiently knowledgeable to provide maintenance services on the proprietary technologies in accordance with all manufacturer specifications and this section pursuant to N.J.A.C.7:9A-8.3 and 10.8, as applicable; or

THIS IS A COURTESY COPY OF THIS RULE. ALL OF THE DEPARTMENT'S RULES ARE COMPILED IN TITLE 7 OF THE NEW JERSEY ADMINISTRATIVE CODE.

2. An S2 or higher public wastewater treatment system operator license from the Department issued pursuant to N.J.A.C. 7:10A.

(c) An authorized service provider who holds an S2 or higher public wastewater treatment system license but is not authorized by the manufacturer and/or system integrator, as applicable, shall meet all applicable requirements of N.J.A.C. 7:10A when performing maintenance on any advanced wastewater pretreatment unit or drip dispersal system, in addition to all applicable requirements of this chapter.

7:9A-3.18 Requirements for certification of sewerage facilities serving subdivisions involving 50 or more realty improvements

(a) Pursuant to N.J.S.A. 58:11-25.1, no subdivision approval shall be granted by any municipal or other authority in the State to cover 50 or more realty improvements, or less than 50 where the subdivision extends into an adjoining municipality or municipalities and will, in the aggregate, cover 50 or more realty improvements, until the Department has certified that the proposed water supply and sewerage facilities for realty improvements comply with applicable State standards. An application for Department certification of sewerage facilities for 50 or more realty improvements shall be directed to the Department by the municipal authority, reviewed by the Department as part of an application for a treatment works approval issued pursuant to N.J.A.C. 7:9A-3.9 and shall be processed in accordance with N.J.A.C. 7:9A-3.9 and this section. The 50 or more realty improvements treatment works approval application for the proposed sewerage facilities shall contain all information specified in N.J.A.C. 7:9A-3.5(b) and this section, and shall be reviewed for compliance with the Water Pollution Control Act N.J.S.A. 58:10A-1 et seq. and the applicable Ground Water Quality Standards N.J.A.C. 7:9C.

(b) The TWA application for 50 or more realty improvement certification shall include the following information:

1. A completed Treatment Works Approval Application (TWA-1) form;
2. Engineering plans including Plot Plan, Final Grading and Drainage Plan, Topographic Plan, and Test Pit/Septic Location Plan in accordance with (c) below;
3. A copy of the preliminary subdivision approval, or other written documentation, signed by the municipal or other authority, stating that the proposed project plan in the 50 or More Realty Improvement Certification Application, as submitted to the Department, will comply with local zoning, planning and environmental ordinances and, if applicable, all local master plan requirements;
4. A "Pinelands Certificate of Filing" or a Pinelands "Public Development Approval" as applicable or a certification by the applicant that the project is not subject to the requirements of the Pinelands Comprehensive Management Plan N.J.A.C. 7:50;
5. A certification from the applicant or applicant's agent stating that the information furnished in the application is true, accurate and complete and that it is understood that any falsification or omission of data or information is a violation of the Water Pollution Control Act N.J.S.A. 58:10A-1 et seq. and is subject to penalties as prescribed at N.J.A.C. 7:14-8;
6. Copies of return receipts that demonstrate the local planning board, environmental commission, town clerk and administrative authority have received notification of the submittal of the application for certification; and
7. The results of application of a nitrate dilution model to the proposed development in accordance with the Technical Manual for 50 or More Realty Improvement Certification (which may be obtained from the address specified at N.J.A.C. 7:9A-3.9(e)) or alternatively for lands within the Pinelands, a dilution model as approved by the Pinelands Commission.

(c) Applications for 50 or more realty improvement certifications must include the following in addition to the information required by N.J.A.C. 7:9A-3.5(b). This additional information shall be provided on a general site plan of the subdivision, signed and sealed by a licensed land surveyor:

1. Lots with their dimensions and acreage;

THIS IS A COURTESY COPY OF THIS RULE. ALL OF THE DEPARTMENT'S RULES ARE COMPILED IN TITLE 7 OF THE NEW JERSEY ADMINISTRATIVE CODE.

2. Contours of existing topography (at an appropriate contour interval) using absolute elevations or relative elevations referenced to a permanent bench-mark;
3. Drainage right of way and any contemplated diversion thereof;
4. Location of all existing and proposed water supply wells within 500 feet from the boundaries of the subdivisions;
5. Streams and surface water bodies;
6. Existing and proposed storm sewers and subsurface drains;
7. Above and below ground power transmission lines, gas pipe lines and associated right-of-ways;
8. Location of all stream encroachment boundaries and 100-year flood plain boundaries which fall within the boundaries of the subdivision;
9. Location of all State approved wetlands or transition area delineation lines which fall within the boundaries of the subdivision;
10. Location of all profile pits, soil borings, permeability or percolation tests made within the area of the subdivision; and
11. Boundaries of all soil types or mapping units, obtained from detailed onsite soil investigations or transferred from USDA County Soil Survey Report.

(d) After the issuance of a 50 or more realty improvement certification by the Department, the administrative authority shall review each proposed new system for conformance with N.J.A.C. 7:9A-3.2 prior to the commencement of construction of any realty improvement or system.

(e) (Reserved)

(f) Copies of all applications and accompanying engineering data for certifications submitted under N.J.S.A. 58:11-25 to cover 50 or more realty improvements shall be filed with or mailed to the Department on the date the application is made to the administrative authority.

(g) Copies of all certifications issued by administrative authorities under N.J.S.A. 58:11-25 covering 50 or more realty improvements shall be mailed to the Department by the administrative authority issuing the same on the date of issue.

(h) In cases where preliminary determination by the administrative authority regarding the acceptability of the proposed sewage disposal systems may be required prior to the granting of subdivision approval by the planning board or other municipal agency, such determinations may be made based upon the type of disposal field installations proposed and the soil suitability classification determined by use of Soil Conservation Service soil survey maps in conjunction with Appendix D of this chapter. Alternatively, onsite soil evaluation consisting of soil logs and permeability tests may be required. Where onsite soil evaluation is required, a minimum of one soil log for every five acres or fraction thereof shall be sufficient provided that at least one soil log is provided for every soil series present within the area of the subdivision as shown on Soil Conservation Service soil survey maps. The number of permeability tests required shall be a minimum of one test for every five acres or fraction thereof.

(i) Treatment works approval application forms shall be requested from and complete application packages submitted to the Department at the address specified at N.J.A.C. 7:9A-3.9(e). Fees shall be calculated based upon the formulas at N.J.A.C. 7:14A-22.26, using the estimated costs associated with all of the proposed systems to be located on the proposed project.

7:9A-3.19 Entry and inspection

The administrative authority and its agent and the Department shall have power to make, or cause to be made, such inspections and tests as may be necessary to enforce these standards and they and their authorized representatives

THIS IS A COURTESY COPY OF THIS RULE. ALL OF THE DEPARTMENT'S RULES ARE COMPILED IN TITLE 7 OF THE NEW JERSEY ADMINISTRATIVE CODE.

shall at all times have the right to enter upon lands of realty improvements for these purposes. The system owner shall not refuse, prevent or otherwise prohibit such tests and inspections to determine compliance with this chapter.

7:9A-3.20 Hearing procedures

When any certification has been denied by the administrative authority, the aggrieved applicant may contest the denial by requesting a hearing from the applicable board of health. The hearing shall be held within 15 business days after the request. Once a hearing is held, the board of health shall render a decision to affirm, alter or rescind the contested determination and take action accordingly within an additional 15 business days. If the applicant is dissatisfied with the outcome of the hearing, the applicant may appeal the decision to a court of competent jurisdiction.

Subchapter 4 Site Evaluation and System Location

7:9A-4.1 General provisions for site evaluation and system location

(a) Selection of a location for each individual subsurface sewage disposal system shall be based upon evaluation of all site characteristics which may affect the functioning of the system. Site characteristics to be evaluated shall include, but may not be limited to, minimum required separation distances as prescribed in N.J.A.C. 7:9A-4.3, slope, surface drainage and flood potential.

(b) A site plan shall be required as part of each application and shall, as a minimum, provide the information outlined in N.J.A.C. 7:9A-3.5(c)3.

7:9A-4.2 Location generally

(a) The location and installation of each individual subsurface sewage disposal system and every part thereof shall be such that with reasonable maintenance, as required by N.J.A.C. 7:9A-12, it will function in a satisfactory manner and will not create a nuisance or source of foulness, pose a threat to public health or safety or the environment, or otherwise adversely affect the quality of surface water or groundwater.

(b) Individual subsurface sewage disposal systems shall not be located in such a manner that their functioning may be adversely affected by the following features unless the design adequately addresses the special limitations associated with these features and complies with all applicable local, State and Federal laws, regulations and ordinances.

1. Bedrock outcrops or areas with excessive stones;
2. Sink-holes;
3. Steep slopes showing signs of unstable soil such as landslide scars, slump blocks, fence posts or lower trunks of trees bending downslope;
4. Bare eroded ground, denuded of vegetation, or with deep wheel ruts;
5. Highly disturbed ground indicated by such features as remnants of foundations or pavements, buried building debris or buried plant remains;
6. Sand dunes;
7. Mine spoils, borrow pits, dumps or landfills;
8. Low-lying coastal areas exhibiting signs of tidal inundation or tidal marsh vegetation such as cordgrass (*Spartina alterniflora*), salt-meadow grass (*Spartina patens*) or spike grass (*Distichlis spicata*);

THIS IS A COURTESY COPY OF THIS RULE. ALL OF THE DEPARTMENT'S RULES ARE COMPILED IN TITLE 7 OF THE NEW JERSEY ADMINISTRATIVE CODE.

- 9. Low-lying inland areas showing signs of ponding or freshwater wetland vegetation such as skunk cabbage (*Symplocarpus foetidus*), tussock sedge (*Carex stricta*), cat-tails (*Typha* spp.), alders (*Alnus* spp.), or white cedar (*Chamaecyparis thyoides*); and
- 10. Flat low-lying areas adjoining streams.

7:9A-4.3 Distances

The minimum separation distance between the various components of the system and the other features listed shall conform to and be maintained in accordance with Table 4.3 below. The location of a new well must be in conformance with the requirements of N.J.A.C. 7:9D. No permit or waiver issued outside of this Chapter by any local, State or Federal entity shall be construed to permit deviation from or a waiver of the separation distances requirements listed in the Table 4.3 below..

Table 4.3 Minimum Required Separation Distances (feet)

Component	Reservoir, Well or Suction Line	Water Service Line, Pressure	Water Course (1,12)	Occupied Building	Property Line (15)	Disposal Field	Existing Seepage Pit or Cesspool	In-ground Swimming pool
Building Sewer	25 ⁽²⁾	1	-	-	-	-	-	-
Septic Tank	50 ⁽²⁾	10	25 ^(2,5)	10 ⁽⁶⁾	5	-	-	10
D-Box ⁽¹⁴⁾	50 ⁽²⁾	10	25 ^(2,5)	10	5	-	-	10
Disposal Field ⁽¹¹⁾	100 ^(2,4)	10	50 ^(2,3,5)	25 ⁽⁷⁾	10	50 ⁽⁸⁾	50	20
Seepage Pit ⁽⁹⁾	150/100 ^(2,13)	25	100 ^(2,5)	50 ⁽⁷⁾	20	50	50 ⁽¹⁰⁾	30
Dry Well	50	-	-	-	-	50	50	-

- (1) This distance may be increased as determined by a local, State or Federal entity having authority for establishing separation distances, including, but not limited to, wetlands protection, stream encroachment and riparian corridor.
- (2) Where excessively coarse soils or fractured rock substrata are encountered, these distances may be increased by the administrative authority.
- (3) This distance may be decreased only in the case of an interceptor drain as allowed in N.J.A.C. 7:9A-10.7(d).
- (4) This distance may be decreased by the administrative authority to a minimum of 50 feet only when the well is provided with a water-tight casing to a depth of 50 feet or more, and where the casing is sealed into an impervious stratum which separates the waterbearing stratum from the layer of soil used for sanitary sewage disposal. N.J.A.C. 7:9D shall govern whenever the well under consideration has been installed after July 13, 1979.
- (5) These distances may be reduced by one-half if the water course is a footing drain with an invert elevation higher than the bottom of the disposal field or more than four feet above the level of the seasonally high water table.
- (6) May be reduced to five feet with special approval of the administrative authority.

THIS IS A COURTESY COPY OF THIS RULE. ALL OF THE DEPARTMENT'S RULES ARE COMPILED IN TITLE 7 OF THE NEW JERSEY ADMINISTRATIVE CODE.

- (7) May be reduced to 15 feet from disposal field and 30 feet from seepage pit for portions of the building constructed either on a slab foundation or over a continuous dust cap which is at or above natural or finished grade, whichever is higher only.
- (8) This distance applies to disposal fields serving separate realty improvements but not to disposal fields which are part of a split system serving a single realty improvement.
- (9) Applies only to seepage pits allowed as prescribed in N.J.A.C. 7:9A-7.6.
- (10) In no case shall the distance be less than three times the pit diameter.
- (11) These distances shall be measured from the outermost margin of the disposal bed or trench in the case of conventional and soil replacement bottom-lined installations, from the outermost lateral extension of suitable fill in the case of soil replacement fill-enclosed and mounded soil replacement installations or the edge of the required lateral suitable fill extension in the case of mounded installations.
- (12) For the purposes of this section, the setback distance for a water course shall apply to a stormwater management basin. The setback distance from a stormwater management basin shall be measured from the elevation contour that is coincident with the high water mark.
- (13) The setback distance from a seepage pit shall be 150 feet from a well and 100 feet from a suction line.
- (14) For the purposes of measuring separation distance requirements, a D-Box shall include all piping and appurtenances associated with the effluent distribution network from the outlet of the septic tank to the disposal area.
- (15) This separation distance requirement may be reduced to zero feet in cases where either of the following is provided to the administrative authority prior to obtaining a construction approval for the infringing system or its component:
 - i. If the property line abuts a roadway or utility easement on the side of the property where the reduction in the separation distance is being sought and there are no subsurface utilities located within the separation distance specified in Table 4.3, a notarized statement from the owner of record of the roadway or utility easement acknowledging that no subsurface utilities will be installed within that area; or
 - ii. A copy of a deed notice prepared in accordance with the New Jersey Recording Act, N.J.S.A. 46:15-1.1 et seq., recorded with the office of the clerk or the registrar of deeds and mortgages of the county in which the property where the system is located for each affected property indicating that the affected property owner(s) allow for the reduction in the required separation distance, detailing the reduction in the required separation distance and acknowledging that future improvements may be limited on each affected property based on the reduced separation distance granted due to the need to maintain other setbacks, including but not limited to those for in-ground swimming pools and occupied buildings. The deed notice shall run with the property and be binding upon the property owner and the successors in interest in the property or in any part thereof.

7:9A-4.4 Slope

- (a) No disposal field or seepage pit shall be located in an area where the slope of the existing ground surface is greater than 25 percent.
- (b) Where the slope is greater than 10 percent, no disposal field or seepage pit shall be placed less than 50 feet upslope of any bedrock outcrop where signs of ground water seepage can be detected.
- (c) Modification of slopes by re-grading shall meet the requirements of N.J.A.C. 7:9A-10.3(b).

7:9A-4.5 Surface drainage

- (a) No disposal area shall be placed within a topographical depression or in any area where surface runoff or ground water is likely to accumulate unless measures adequate to address these limitations are incorporated in the approved engineering design and implemented when the system is constructed.

THIS IS A COURTESY COPY OF THIS RULE. ALL OF THE DEPARTMENT'S RULES ARE COMPILED IN TITLE 7 OF THE NEW JERSEY ADMINISTRATIVE CODE.

(b) The use of swales to divert surface run-off away from the disposal field shall be carried out only as prescribed within the engineering design which has been approved by the administrative authority.

(c) The system shall be designed in a manner that will prevent any increase in stormwater runoff to or ponding on adjoining properties as a result of the installation of the system. This shall include any additional runoff to adjoining properties during the construction of the system, unless a temporary increase in runoff is specifically agreed to in writing by all affected property owners prior to commencement of construction of the system and such an increase is not prohibited by other Federal, State, or local requirements.

7:9A-4.6 Surface flooding

(a) No part of a subsurface sewage disposal system shall be constructed in ground subject to surface flooding. For the purposes of this chapter, a site shall be considered to be subject to surface flooding when any of the criteria given in (b) below are satisfied. This determination shall be made whenever the proposed site is located adjacent to a stream or coastline, and the distance and relative elevation of the site with respect to the stream or sea level are such that it is reasonable to expect that the site may be subject to flooding as a result of stream overflow, tides or ocean waves.

(b) For the purpose of compliance with (a) above, a site shall be considered subject to flooding whenever any of the following criteria are met:

1. Flooding is observed during a site inspection made by the administrative authority or its agent or the administrative authority has records or knowledge of past flooding at the site or in adjacent contiguous areas; or
2. Maps contained in a Soil Conservation Service County Soil Survey Report indicate the presence of one or more of the following soil types:

Alluvial Land	Muck Shallow Over Clay
Atsion Tide Flooded	Muck Shallow Over Loam
Berryland	Mullica Loamy Substratum
Berryland-Othello Complex	Parsippany
Bowmansville	Plummer
Carlisle Muck	Pompton Fine Sandy Loam
Colemantown	Pope High Bottom
Colemantown-Matlock	Portsmouth Thin Surface Variant
Fluvaquents	Preakness
Fredon	Raritan
Humaquepts Flooded	Rowland
Manahawkin	Sloan and Wayland
Middlebury	Tioga

- i. Where the accuracy of the Soil Survey Report mapping is questioned, the soil series actually present at the site shall be identified by comparing the soil profile characteristics observed in a soil profile pit with the range of soil profile characteristics given in the County Soil Survey Report for a particular soil series.

(c) Development within a flood hazard area is subject to the restrictions and requirements of the Flood Hazard Area Control Act Rules N.J.A.C. 7:13. N.J.A.C. 7:13 prohibits the construction of an individual subsurface disposal system within the floodway of a regulated water, as defined at N.J.A.C. 7:13-2.2, and may require a flood hazard area permit for the construction of a system within a regulated area, as defined at N.J.A.C. 7:13-2.3.

THIS IS A COURTESY COPY OF THIS RULE. ALL OF THE DEPARTMENT'S RULES ARE COMPILED IN TITLE 7 OF THE NEW JERSEY ADMINISTRATIVE CODE.

(d) The criteria for delineation of flood hazard areas used in the Flood Hazard Area Rules, N.J.A.C. 7:13, are different from the criteria used in this chapter for identification of areas subject to flooding. Consequently, a site which does not meet the criteria given in (b) above may still be subject to N.J.A.C. 7:13. It is the responsibility of the applicant to comply with all applicable requirements of N.J.A.C. 7:13 regardless of whether the site of the proposed individual subsurface sewage disposal system meets the criteria given in (b) above. Compliance with this or any other provision of this chapter does not exempt the applicant from compliance with the requirements of N.J.A.C. 7:13.

7:9A-4.7 Freshwater wetlands

(a) As part of the initial site evaluation process, prior to selection of a site for a proposed subsurface sewage disposal system, the applicant shall take into consideration the possible presence of freshwater wetlands which are protected by the Freshwater Wetlands Protection Act, N.J.S.A. 13:9B-1 et seq., and the rules promulgated pursuant thereto, N.J.A.C. 7:7A. In cases where available information submitted as part of the application requirements for approval under this chapter indicate the potential presence of a freshwater wetlands within the proposed area of disturbance, the administrative authority shall require evidence that the applicant has complied with applicable regulations. This evidence shall meet the requirements of (c) below and shall be required whenever the criteria given in (b) below are satisfied. This section shall not apply to projects located within areas under the jurisdiction of the Pinelands Commission pursuant to N.J.S.A. 13:18A-1 et seq. and areas under the jurisdiction of the Hackensack Meadowlands Development Commission pursuant to N.J.S.A. 13:17-1 et seq.

(b) For the purpose of compliance with (a) above, the proposed site of a subsurface sewage disposal system shall be tentatively considered to be located within a potential freshwater wetland whenever any of the following criteria are met:

1. Surface ponding is observed, or the vegetation, topography or relative elevation with respect to adjacent surface water bodies is such as to indicate the likelihood of periodic or seasonal surface ponding;
2. Soil profile evaluation carried out as prescribed in N.J.A.C. 7:9A-5 indicates a seasonally high water table at a depth shallower than 1.5 feet below the existing ground surface; or
3. Maps contained in a Soil Conservation Service County Soil Survey Report indicate the presence of one or more of the following soil types:

Abbottstown	Manahawkin
Adrian	Marsh
Albia	Matlock
Alluvial Land	Muck
Amwell	Mullica
Atherton	Norwich
Atsion	Othello
Bayboro	Parsippany
Berryland	Pasquotank
Bibb	Passaic (Parsippany variant)
Biddeford	Peat
Bowmansville	Plummer
Carlisle	Pocomoke
Chalfont	Portsmouth

THIS IS A COURTESY COPY OF THIS RULE. ALL OF THE DEPARTMENT'S RULES ARE COMPILED IN TITLE 7 OF THE NEW JERSEY ADMINISTRATIVE CODE.

Chippewa	Preakness
Cokesbury	Raynham
Colemantown	Reaville (wet variant)
Croton	Ridgebury
Doylestown	Rowland
Elkton	Shrewsbury
Fallsington	Sloan
Fluvaquents	St. Johns
Fredon	Sulfaquents
Fresh Water Marsh	Sulfihemists
Haledon (wet variant)	Swamp
Halsey	Tidal Marsh
Hammonton	Turbotville
Humaquepts	Venango (Albia)
Keansburg	Wallkill
Klej	Watchung
Lamington	Wayland
Lenoir	Weeksville
Leon	Whippany
Livingston	Whitman
Lyons	Unnamed

i. In addition to the soil types listed above, wet phases of soils classified by the Soil Conservation Service as somewhat poorly drained may also indicate the presence of a freshwater wetland.

ii. Where the accuracy of the Soil Survey Report mapping is questioned, the soil series actually present at the site shall be identified by comparing the soil profile characteristics observed in a soil profile pit with the range of soil profile characteristics given in the County Soil Survey Report for a particular soil series.

(c) Evidence that the applicant has complied with applicable State freshwater wetland rules shall consist of any of the following documents:

1. A valid "letter of interpretation" issued by the Department, indicating that the proposed development is not located in wetlands, waters or transition areas;
2. A valid freshwater wetlands statewide general or individual permit, or a valid transition area waiver, issued by the Department for the wetlands or transition area aspects of the proposed development; or
3. A written determination from the Department that the proposed development is not subject to regulation under the Freshwater Wetlands Protection Act.

(d) Use of the criteria given in (b) above to identify the presence of a potential freshwater wetland does not constitute an official freshwater wetlands delineation by the Department's "three-parameter approach" in accordance with N.J.A.C. 7:7A. As a result, sites which do not meet these criteria may still be subject to regulation

THIS IS A COURTESY COPY OF THIS RULE. ALL OF THE DEPARTMENT'S RULES ARE COMPILED IN TITLE 7 OF THE NEW JERSEY ADMINISTRATIVE CODE.

under N.J.A.C. 7:7A or other Federal, State or local laws. The applicant shall contact the appropriate agencies and comply with all applicable statutes or regulations or ordinances.

7:9A-4.8 Area reserved for sanitary sewage disposal

The area used for sewage disposal shall be selected and maintained so that it is free from encroachments by driveways, accessory buildings, additions to the main building, patios, decks and trees or shrubbery whose roots may cause clogging of any part of the system. The area of sewage disposal shall not be located under driveways, parking lots (paved or otherwise), accessory buildings, additions to main buildings or any other form of encroachment which may adversely affect the functioning of the system or interfere with system maintenance.

Subchapter 5. Determination of Soil Suitability

7:9A-5.1 General provisions for the determination of soil suitability

(a) When a site meeting the requirements of N.J.A.C. 7:9A-4 has been chosen for location of the proposed individual subsurface wastewater disposal system, the suitability of the soil for treatment and disposal of the effluent shall be determined as prescribed below. This determination shall be made based upon soil profile characteristics observed in soil profile pits and borings as prescribed in N.J.A.C. 7:9A-5.2, criteria for determination of soil suitability classes which are given in N.J.A.C. 7:9A-5.4, criteria for recognition of soil limiting zones which are given in N.J.A.C. 7:9A-5.5 through 5.9, as well as any other related data that may be required by the administrative authority.

(b) All soil evaluation procedures relied upon as a basis for the design of an individual subsurface sewage disposal system shall be carried out by or under the direct supervision of a licensed professional engineer.

7:9A-5.2 Requirements for soil profile pits and borings

(a) Soil profile pits shall be excavated at the site of each proposed disposal field for the purpose of determining the suitability and distribution of soil types present at the site. Partial substitution for soil profile pits may be made using soil borings as outlined in (b) below.

(b) A minimum of two profile pits are required for each disposal field. A minimum of three soil borings may be performed in lieu of the second profile pit, provided that the soil horizons and substrata observed in the borings are not significantly different from those observed in the first profile pit.

(c) The location of soil profile pits and borings for disposal fields shall be as follows:

1. As shown in Figure 1 of Appendix A, profile pits shall be located at either end of the disposal field, within or no further than 15 feet beyond the boundaries of the disposal field.

2. In cases where a profile pit or part of a profile pit has been excavated within the boundaries of a proposed disposal trench or bed, the pit shall be backfilled after use in a manner that will not result in a major discontinuity with respect to soil horizonation, density or permeability in the soil below the disposal trench or bed.

3. When soil borings are substituted for the second profile pit these shall be located as shown in Figure 1 of Appendix A, at the approximate center of the disposal field and at corners opposite the profile pit. All soil borings shall be within the boundaries of the disposal field, or no further than 15 feet beyond the boundaries of the disposal field.

(d) When a seepage pit(s) is proposed, as allowed in N.J.A.C. 7:9A-7.6, a minimum of one profile pit or two soil borings shall be performed for each seepage pit. Profile pits shall be located within or no further than 15 feet from the proposed seepage pit. Borings shall be located on opposite sides of the seepage pit, no further than 15 feet from the seepage pit.

THIS IS A COURTESY COPY OF THIS RULE. ALL OF THE DEPARTMENT'S RULES ARE COMPILED IN TITLE 7 OF THE NEW JERSEY ADMINISTRATIVE CODE.

(e) Profile pits shall be prepared as follows:

1. Profile pits shall be excavated, if possible, to a minimum depth of 10 feet below the existing ground surface or to solid bedrock, where encountered. If the profile pit becomes unstable due to lack of soil cohesion or the presence of groundwater, or both, the pit may be terminated at a depth less than 10 feet and soil evaluation below the depth of the pit may be carried out by means of three or more soil borings, performed as prescribed in (f) below. The depth of the soil evaluation shall never be less than eight feet below the proposed level of infiltration.
2. When a seepage pit is proposed, the profile pit shall extend a minimum of eight feet below the bottom of the seepage pit or to solid bedrock, when encountered. In cases where the minimum required depth is deeper than that practically attainable using ordinary excavating equipment, soil borings should be used rather than a profile pit. Alternatively, borings may be used to extend the depth of profile pits beyond the range of the excavating equipment.
3. It is recommended that the sides of the profile pit be stepped and sloped as shown in Figure 2 of Appendix A, to prevent caving-in and to allow safe access to the upper portion of the pit. An undisturbed face, a minimum of one foot wide and extending from the top of the pit to a depth of five feet, shall be exposed by means of hand tools, for observation of the soil profile characteristics. Evaluation of soil properties below a depth of five feet may be accomplished by examination of samples removed by excavating equipment or by examination of three or more borings, performed as prescribed in (f) below.
4. It is recommended that persons performing soil evaluation not enter into portions of a soil profile pit which have been excavated to depths greater than five feet below the surrounding ground surface. It is the responsibility of persons performing or witnessing soil evaluation to comply with all applicable Federal, State and local laws and regulations governing occupational safety.

(f) Soil borings shall be performed as follows:

1. Soil borings shall be completed to a minimum depth of 10 feet below the existing ground surface or to solid bedrock, where encountered. In no case shall the depth of the borings be less than eight feet below the proposed level of infiltration. Where a seepage pit is proposed, the borings shall extend a minimum of eight feet below the bottom of the seepage pit or to solid bedrock, where encountered.
2. Soil borings shall be made in a manner that will provide a continuous sample of the soil profile without mixing the soil from different depths. Hand augers may be used provided that the hole remains open and does not slump.

(g) In soil profile pits and borings, the following characteristics of each recognizable soil horizon or substratum (not including rock substrata) shall be determined:

1. Depth and thickness of horizon;
2. Soil color, using the Munsell system of classification which includes an alpha-numeric symbol together with a descriptive color name;
3. Estimated soil textural class, using the USDA system of classification;
4. Estimated volume percentage of coarse fragment, if present;
5. Abundance, size and contrast of mottles, if present;
6. Soil structural class (soil profile pits only); and
7. Soil consistence.

(h) Soil profile characteristics shall be reported in log form, using terminology as prescribed in N.J.A.C. 7:9A-5.3.

THIS IS A COURTESY COPY OF THIS RULE. ALL OF THE DEPARTMENT'S RULES ARE COMPILED IN TITLE 7 OF THE NEW JERSEY ADMINISTRATIVE CODE.

7:9A-5.3 Terminology required for soil logs

- (a) A soil log shall be prepared for each soil profile pit or soil boring. The soil profile characteristics listed in N.J.A.C. 7:9A-5.2(g) shall be described using the terminology specified in (b) through (h) below.
- (b) Depth and thickness of each distinct soil horizon or substratum shall be reported in inches. A distinct soil horizon or substratum is any soil horizon or substratum which differs from horizons or substrata above or below it in color, texture, coarse fragment content, mottling, structure or consistence.
- (c) Color shall be described using the Munsell system of classification which includes a descriptive color name such as "strong brown" or "pale red", together with an alpha-numeric designation of hue, value and chroma such as "7.5 YR 5/6" or "2.5 YR 6/2". When mottling is encountered, report the dominant or background color and the mottle colors.
- (d) Texture shall be reported as the name of the appropriate textural class which is shown on the USDA textural triangle, Figure 3 of Appendix A, determined based upon the relative proportions of sand, silt and clay in that portion of the soil which excludes the coarse fragment. Texture shall be estimated in the field by feel, or determined by textural analysis as prescribed in N.J.A.C. 7:9A-6.3.
- (e) The volume percentage of coarse fragments shall be estimated in the field visually using volume percentage estimation charts provided in Figure 4 of Appendix A. Coarse fragments which are rounded or subrounded in shape shall be classified based upon size, as indicated in (e)1 through 3 below. In the case of shale, slate, or other thin rock fragments, the rock type and the average length and thickness of the rock fragments shall be reported.
1. "Gravel" means a rock fragment from two millimeters (0.1 inches) to 76 millimeters (three inches) in diameter;
 2. "Cobble" means a rock fragment from 76 millimeters (three inches) to 254 millimeters (10 inches) in diameter; and
 3. "Stone" means a rock fragment greater than 254 millimeters (10 inches) in diameter.
- (f) When mottling is observed, the abundance, size, and contrast of the mottles shall be reported using the following terminology:
1. Abundance shall be estimated visually, by using the volume percentage charts provided in Figure 4 of Appendix A, to estimate the percentage of the exposed surface which is occupied by mottles. Abundance of mottles shall be classified as follows:
 - i. Mottles are "few" when less than two percent of the exposed surface is occupied by mottles;
 - ii. Mottles are "common" when from two percent to 20 percent of the exposed surface is occupied by mottles; and
 - iii. Mottles are "many" when more than 20 percent of the exposed surface is occupied by mottles.
 2. Size shall be classified based on the estimated average longest dimension of the mottles, as follows:
 - i. Mottles are "fine" when they are less than five millimeters in size;
 - ii. Mottles are "medium" when they are from five to 15 millimeters in size; and
 - iii. Mottles are "course" when they are greater than 15 millimeters in size;
 3. Contrast shall be described as follows:
 - i. Mottles are "faint" when they may be distinguished only on close examination;
 - ii. Mottles are "distinct" when they are readily seen but not prominent; and
 - iii. Mottles are "prominent" when they are obvious and one of the outstanding features of the soil horizon.

THIS IS A COURTESY COPY OF THIS RULE. ALL OF THE DEPARTMENT'S RULES ARE COMPILED IN TITLE 7 OF THE NEW JERSEY ADMINISTRATIVE CODE.

(g) Soil structure shall be described using the following terms which refer to the shape of the natural soil aggregates:

1. Structure is "spheroidal" when the aggregates are more or less equi-dimensional and lack sharp corners, sharp edges or well-defined faces. This term includes crumb and granular structure as defined by the USDA;
2. Structure is "subangular blocky" when the aggregates are more or less equi-dimensional and possess well-defined flat or somewhat curved faces, but lack sharp corners or edges;
3. Structure is "angular blocky" when the aggregates are more or less equi-dimensional in shape and possess well-defined flat or somewhat curved faces, sharp corners and sharp edges;
4. Structure is "prismatic" when the aggregates have one axis distinctly longer than the other two and are oriented with the long axis vertical;
5. Structure is "platy" when the aggregates have one axis distinctly shorter than the other two and are oriented with the short axis vertical. Soil horizons with platy structure generally show numerous well-defined horizontal structural faces and lack well defined vertical structural faces;
6. Structure is "massive" when the soil consists of a dense, compact mass showing no recognizable natural aggregates or structural faces; and
7. Structure is "single grain" when the soil consists of loose individual sand grains which lack cohesion and are not bound together into recognizable soil aggregates.

(h) Soil consistence shall be described using the following terminology which refers to the ease with which a soil clod or aggregate may be crushed with the fingers in either the dry or moist condition.

1. In the dry soil condition, soil consistence is characterized as:

- i. "Loose" when the soil is non-coherent;
- ii. "Soft" when the soil mass breaks to a powder of individual grains with slight pressure;
- iii. "Slightly hard" when the soil mass is easily broken between thumb and forefinger;
- iv. "Hard" when the soil mass can be broken in the hands without difficulty, but is barely breakable between thumb and forefinger; and
- v. "Very hard" when the soil mass can be broken in the hands with difficulty, but is not breakable between thumb and forefinger.

2. In the moist soil condition, soil consistence is characterized as:

- i. "Loose" when the soil is non-coherent;
- ii. "Friable" when the soil material crushes easily between thumb and forefinger;
- iii. "Firm" when the soil material crushes under moderate pressure between thumb and forefinger;
- iv. "Very firm" when the soil material is barely crushable under strong pressure between thumb and forefinger; and
- v. "Extremely firm" when the soil material cannot be crushed between thumb and forefinger, but can only be broken apart bit by bit.

3. For any moisture condition, soil consistence is characterized as "cemented" when the soil mass is brittle and hard, and cannot be broken by hand.

7:9A-5.4 Criteria for determination of soil suitability classes

(a) The soil suitability class shall determine what type(s) of standard disposal field installation(s), if any, may be approved on a given site. The soil suitability class is determined based upon the type and depth of limiting zone(s) present. In the case of disturbed ground, additional factors must be considered, as outlined N.J.A.C. 7:9A-5.10.

(b) The depth to the limiting zone shall be measured from the ground surface to the top of the limiting zone. In the case of disturbed ground, depth to the limiting zone shall be measured from the existing ground surface or the ground surface, whichever is lowest. Criteria for recognition of the existing ground surface are given in N.J.A.C. 7:9A-5.10(c).

(c) As shown in Table 5.4 below, the soil suitability designation consists of a Roman numeral from I to III which designates the severity of the soil limitation, together with a letter symbol which designates the type(s) of limitation. When more than one limiting zone is present, the following practice shall be followed:

1. The primary classification of the soil is based upon whichever limiting zone presents the most severe limitation (highest number value). Secondary classifications are given based upon limitations which are less severe (lower number values). The primary classification is stated first followed by secondary classifications in parentheses. For example, the classification for a soil with a seasonally high water table (top of the zone of saturation) at a depth of 1.5 feet and a massive rock substratum at seven feet would be III Wr (II Sr).

2. When two or more limiting zones are present with the same degree of limitation, a compound symbol is used, in primary or secondary classifications, consisting of a Roman numeral showing the degree of limitation followed by a letter symbol for each limiting zone. For example, the classification for a soil with a seasonally high water table at 2.5 feet and a fractured rock substratum at three feet would be II Wr, Sc.

Table 5.4 Soil Suitability Classification

Type of Limiting Zone	Depth ¹ , Ft.	Suitability Class
Fractured Rock or Excessively Coarse Substratum	>5	I
	0-5	IISc
Massive Rock or Hydraulically Restrictive	>9	I
	4-9	IISr
	<4	IIISr
Hydraulically Restrictive Horizon, Permeable Substratum	>9	I
	4-9	IIHr
	<4	IIIHr
Excessively Coarse Horizon	>5	I
	0-5	IIHc
Zone of Saturation, Regional	>5	I
	2-5	IIWr
	<2	IIIW _r
Zone of Saturation, Perched	>5	I
	2-5	IIW _p
	<2	IIIW _p

(1) Depth is measured from the existing ground surface to the top of the limiting zone. In the case of disturbed ground, the depth to the limiting zone shall be measured from the existing ground surface, identified as prescribed in N.J.A.C. 7:9A-5.10, or the ground surface, whichever is lowest.

7:9A-5.5 Rock substrata

(a) Criteria for recognition of rock substrata shall include but not be limited to the following:

THIS IS A COURTESY COPY OF THIS RULE. ALL OF THE DEPARTMENT'S RULES ARE COMPILED IN TITLE 7 OF THE NEW JERSEY ADMINISTRATIVE CODE.

1. Any solid and continuous body of rock, with or without fractures, or any weathered or broken body of rock fragments overlying a solid body of rock, in which more than 50 percent by volume of the rock fragments are greater than two-millimeters in diameter or large enough to be retained on a two millimeter sieve shall be considered to be a rock substratum. In cases where the content of coarse fragments increases downward in a soil profile underlain by a rock substratum, the upper limit of the limiting zone shall be taken as the depth above which 50 percent or more of the soil material consists of particles less than two millimeters in diameter or small enough to pass through a two millimeter sieve.
2. A rock substratum shall be considered as a fractured rock substratum if, based upon the judgment and experience of the soil evaluator, the rock substratum in question is determined to contain an adequate number of open and inter-connected fractures to allow unimpeded absorption of applied wastewater and transmission of this wastewater away from the disposal area. Any rock substratum which does not contain an adequate number of open and inter-connected fractures shall be considered a massive rock substratum. When doubt exists as to whether the limiting zone should be considered a fractured rock substratum or a massive rock substratum, the administrative authority may require a pit-bailing test or a basin flooding test to be performed as prescribed in N.J.A.C. 7:9A-6.
3. Whenever the presence of a perched zone of saturation, immediately above the rock substratum, is inferred based upon observation of soil morphology, as prescribed in N.J.A.C. 7:9A-5.8, or confined, by direct observation or by testing, as prescribed in N.J.A.C. 7:9A-5.9, the rock substratum shall be considered massive.

7:9A-5.6 Excessively coarse horizons and substrata

(a) Criteria for recognition of excessively coarse horizons or substrata are as follows:

1. Soil horizons or substrata which have a coarse fragment content greater than 50 percent by volume shall be considered excessively coarse regardless of their measured permeability or percolation rate.
2. Sand textured soil horizons or substrata containing no greater than 50 percent coarse fragments by volume, and no less than 15 percent coarse fragments by volume (20 percent coarse fragments by weight), shall be considered excessively coarse if they are composed primarily of coarse-very coarse sand (from 0.5 to two millimeters in diameter) and lack detectable amounts (two percent or more) of silt and clay. Soils which lack detectable amounts of silt and clay are soils which are dominantly gritty to the touch, lack cohesion when moist, lack stickiness when wet and do not stain the fingers when rubbed in the hand.
3. When doubt exists as to whether a horizon or substratum should be considered excessively coarse, the administrative authority may require a soil permeability or percolation test to be performed within the horizon or substratum in question. Soil horizons or substrata which are tested shall be considered excessively coarse when the measured permeability is faster than 20 inches per hour or the measured percolation rate is faster than three minutes per inch. Alternatively, soil texture may be verified by textural analysis as prescribed in N.J.A.C. 7:9A-6.3.

7:9A-5.7 Hydraulically restrictive horizons and substrata

(a) Criteria for recognition of hydraulically restrictive horizons and substrata shall include but not be limited to the following:

1. Any soil horizon or substratum which exists immediately below a perched zone of saturation shall be considered hydraulically restrictive. The perched zone of saturation may be observed directly, inferred based on observation of soil profile morphology as prescribed in N.J.A.C. 7:9A-5.8, or confirmed by testing as prescribed in N.J.A.C. 7:9A-5.9.
2. Any soil horizon or substratum possessing a clay, silty clay, or silty clay loam texture, as defined in the U.S.D.A. system of classification, shall be considered to be hydraulically restrictive.
3. Any soil horizon or substratum shall be considered hydraulically restrictive if it possesses a sandy clay, clay loam, silt loam or silt texture together with:

THIS IS A COURTESY COPY OF THIS RULE. ALL OF THE DEPARTMENT'S RULES ARE COMPILED IN TITLE 7 OF THE NEW JERSEY ADMINISTRATIVE CODE.

- i. A massive or platy structure; or
- ii. A hard, very hard, firm, very firm or extremely firm consistence.

4. Any cemented horizon or substratum such as ironstone, which remains hard even when soaked in water, shall be considered hydraulically restrictive.

(b) When doubt exists as to whether a soil horizon or substratum should be considered hydraulically restrictive, the administrative authority may require that the soil horizon or substratum in question be tested by an appropriate method, as prescribed in N.J.A.C. 7:9A-6. The soil horizon or substratum shall be considered to be hydraulically restrictive if the measured permeability is slower than 0.2 inch per hour or the percolation rate is slower than 60 minutes per inch.

7:9A-5.8 Criteria for recognition of zones of saturation

(a) Criteria for recognition of zones of saturation shall include but not be limited to the following:

1. Any layer within or below the soil profile which exhibits mottling shall be considered a zone of saturation.
2. Any layer within or below the soil profile from which ground water seepage is observed shall be considered a zone of saturation.
3. Any layer within or below the soil profile which is below the static water level observed within a soil profile pit or boring shall be considered to be a zone of saturation.

(b) The upper limit of the zone of saturation, which is the seasonally high water table, shall be determined by one of the following means:

1. Where mottling is observed, at any season of the year, the seasonally high water table shall be taken as the highest level at which mottling is observed, except when the water table is observed at a level higher than the level of the mottling.
2. Where mottling is not observed, the seasonally high water table shall be determined based upon either of the following methods:

- i. During the months of January through April, inclusive, water levels may be measured directly within soil profile pits or borings. Whenever the Department determines that there has been a significant departure from normal climatic conditions the Department may, with due notice to the administrative authority, lengthen or shorten the period allowed for direct measurement during any given year. In low lying coastal areas where groundwater levels fluctuate with the tides, measurements shall be taken at the time of highest groundwater elevation in response to tidal fluctuation; or
- ii. During other times of the year, the depth to the seasonally high water table may be obtained from the Soil Conservation Service County Soil Survey Report provided that the soil series present at the site is identified based upon comparison of soil profile morphology observed within a soil profile pit, and the soil profile description provided for the soil series in question within the County Soil Survey Report. In cases where the seasonal high water table is shown as a range of elevations in the County Soil Survey Report, the highest elevation of the range shall be used as the seasonal high water table.

3. When the determination of seasonally high water table must be made in disturbed ground recognized as prescribed in N.J.A.C. 7:9A-5.10, direct observation during the months of January through April inclusive is the only method which shall be permitted.

(c) When a hydraulically restrictive horizon, a hydraulically restrictive substratum, or a massive rock substratum is not present throughout or immediately below the zone of saturation, the zone of saturation shall be considered a regional zone of saturation.

(d) Any zone of saturation which occurs above a hydraulically restrictive horizon, a hydraulically restrictive substratum, or a massive rock substratum shall be considered a regional zone of saturation unless a perched zone

THIS IS A COURTESY COPY OF THIS RULE. ALL OF THE DEPARTMENT'S RULES ARE COMPILED IN TITLE 7 OF THE NEW JERSEY ADMINISTRATIVE CODE.

of saturation is identified based upon the criteria given in (e) below. When doubt exists as to whether the zone of saturation is regional or perched, and an interceptor drain is proposed to remove the zone of saturation below the disposal field, the administrative authority may require a hydraulic head test to be performed as prescribed in N.J.A.C. 7:9A-5.9.

(e) A zone of saturation shall be considered to be perched whenever any of the following conditions are met:

1. The zone of saturation is present immediately above a hydraulically restrictive horizon underlain by a layer of permeable unsaturated soil which is free of mottling and has a chroma of four or higher;
2. Water is observed ponded above a hydraulically restrictive horizon at the bottom of the soil profile pit but this water drains away naturally when the depth of the pit is extended below the bottom of the hydraulically restrictive horizon; or
3. Water is observed seeping into a profile pit immediately above a hydraulically restrictive horizon, a hydraulically restrictive substratum or a massive rock substratum and this seep is eliminated by means of a trench excavated upslope of the profile pit which intercepts and diverts laterally moving ground water away from the profile pit.

(f) Any zone of saturation which is present below a hydraulically restrictive horizon shall be considered an artesian zone of saturation whenever any of the following conditions are met:

1. Artesian conditions have been observed in contiguous geologic formations or are known to exist in adjacent areas underlain by similar soils and/or geologic substrata;
2. Water-bearing strata which are present below the hydraulically restrictive horizon are known to be inclined and to have outcrop areas upslope or at elevations higher than the elevation of the site; or
3. An unsaturated zone of substantial thickness and continuity is not observed below the hydraulically restrictive horizon. To prove the absence of an artesian condition, the unsaturated zone must be free of mottling and have a chroma of four or higher. When this determination is made during the months of January through April inclusive, the unsaturated zone must be a minimum of one foot in thickness. At times of the year other than January through April inclusive, the unsaturated zone must be a minimum of four feet in thickness. Whenever the Department determines that there has been a specific departure from normal climatic conditions, the Department may, with prior written notice to the administrative authority, adjust or modify the length of seasons for application of the criteria set forth in this paragraph.

(g) When any of the conditions in (f) above are met, the administrative authority shall not approve the removal of the hydraulically restrictive horizon for the purpose of installing a soil replacement disposal field unless it is determined by means of a hydraulic head test, as prescribed in N.J.A.C. 7:9A-5.9, that an artesian zone of saturation is absent below the hydraulically restrictive horizon.

7:9A-5.9 Hydraulic head test

(a) When a hydraulic head test is required by the administrative authority to determine the presence or absence of a perched or artesian zone of saturation, piezometers shall be installed and monitored by the applicant as follows:

1. Piezometer A shall consist of a steel or plastic casing, a minimum of two inches in diameter, perforated or open at the bottom, and extending from above the ground surface to a point immediately above but not penetrating into the hydraulically restrictive horizon.
2. Piezometer B shall consist of a steel or plastic casing, a minimum of two inches in diameter located two to five feet from Piezometer A and extending from above the ground surface to a minimum of one foot below the bottom of the restrictive horizon. Piezometer B must be:
 - i. Open at the bottom or perforated only below the bottom of the restrictive horizon and within the underlying permeable horizon or stratum; and

THIS IS A COURTESY COPY OF THIS RULE. ALL OF THE DEPARTMENT'S RULES ARE COMPILED IN TITLE 7 OF THE NEW JERSEY ADMINISTRATIVE CODE.

ii. Installed or sealed in such a manner that no ground water may move upward or downward through the hydraulically restrictive horizon by flowing around the outside of the casing. When the hydraulically restrictive horizon is a horizon of high clay content and plastic consistence, this may be accomplished by use of a steel well-point which may be driven through the restrictive horizon and into the permeable soil below. In other cases, the piezometer shall be installed within an over-sized borehole with a bentonite pellet seal, a minimum of one foot thick, placed at the appropriate level.

(b) The piezometers shall be developed by pumping or surging. After a period of 24 hours the water levels in both piezometers shall be accurately measured and recorded. All piezometer readings shall be taken from the same point in the piezometer. The number of water level readings shall be proposed by the septic system designer to the administrative authority based upon site conditions. Piezometers shall not be installed prior to administrative authority approval of the number of water level readings. Additional readings may be required if variability is observed in the readings or if the administrative authority finds discrepancy in the measurements.

(c) Water level measurements shall be interpreted as follows:

1. An equal water level in both piezometers means that the water level above the hydraulically restrictive horizon is due to the presence of a regional rather than a perched zone of saturation. Interceptor drains shall not be relied on as a means of providing an unsaturated zone below the disposal field.

2. Where water levels are different in piezometers A and B:

i. A water level in piezometer B which is above the bottom of the hydraulically restrictive horizon means an artesian zone of saturation is present below the hydraulically restrictive horizon. Excavation and removal of the hydraulically restrictive horizon in order to install a soil replacement or mounded soil replacement disposal field shall not be allowed.

ii. A water level in piezometer B which is below the bottom of the hydraulically restrictive horizon means that the water level, if observed, in piezometer A is due to the presence of a perched zone of saturation. No artesian zone of saturation is present below the hydraulically restrictive horizon. Interceptor drains may be proposed as a means of providing an unsaturated zone below the disposal field. Excavation and removal of the restrictive horizon in order to install a soil replacement or mounded soil replacement disposal field may be allowed.

(d) When it is required, the hydraulic head test shall be conducted only during the months of January through April inclusive, and shall be witnessed by the administrative authority or its authorized agent in accordance with N.J.A.C. 7:9A-3.6. Whenever the Department determines that there has been a significant departure from normal climatic conditions, the Department may, with prior written notice to the administrative authority, lengthen or shorten the period allowed for use of this test during any given year.

(e) When piezometers are installed for the purpose of conducting this test, the piezometers shall be removed or filled with cement grout after completion of the test except in those cases where the piezometers will be utilized for monitoring ground water levels or for ground water sampling as required by the administrative authority or by the Department. Piezometers used for monitoring ground water levels over extended periods of time, or for ground water sampling in connection with water quality monitoring, may be considered to be monitoring wells requiring installation by a licensed well driller and a permit issued by the Department pursuant to State law (N.J.S.A. 58:4-1 et seq.). The applicant shall contact the Department for a determination of whether or not a permit is required.

7:9A-5.10 Disturbed ground

(a) When placement of a disposal field is proposed in an area of disturbed ground, the type and depth of soil limiting zones as well as a variety of additional factors must be considered in determination of soil suitability, depending on the nature of the soil disturbance, as outlined in (b) below. Types of soil disturbance which shall be addressed within the soil evaluation and engineering design include but are not limited to filled areas, excavated areas, re-graded areas, artificially drained areas and pre-existing wastewater disposal areas.

THIS IS A COURTESY COPY OF THIS RULE. ALL OF THE DEPARTMENT'S RULES ARE COMPILED IN TITLE 7 OF THE NEW JERSEY ADMINISTRATIVE CODE.

- (b) A site shall be considered disturbed ground when any of the following conditions are present:
1. Displaced or man-made objects such as tree stumps, branches, plant stems, leaves, building debris or trash of man-made origin, are observed below the ground surface in profile pits or soil borings;
 2. Soil profile pits or borings reveal A-horizons or O-horizons which are buried by layers of soil or other material;
 3. Soil horizons are absent or mixed in a manner which cannot be explained as a result of natural processes;
 4. Mounded areas or depressions in the land surface are observed which do not conform with surrounding topography and which show signs of recent disturbance such as lack of vegetation, weedy vegetation, severe erosion, wheel ruts, etc.;
 5. Remnants of building foundations, pavement or other man-made structures are observed at the surface or uncovered in profile pits or soil borings;
 6. Subsurface drains or their remnants are observed in profile pits or borings or the outlets of drains are observed at the surface; or
 7. Components of an existing wastewater disposal system, or remnants of an abandoned sewage disposal system are present below the site of a proposed new system.
- (c) When evidence is found that the surface of the ground may have been modified by a disturbance such as addition of fill material, removal of soil horizons or regrading, the existing ground surface shall be identified based upon the following criteria:
1. When a buried A- or O-horizon is present, the existing ground surface shall be taken as the top of the A-horizon or the bottom of the O-horizon.
 2. When a buried A- or O-horizon is not present, the level of the existing ground surface shall be determined by extrapolation from adjacent areas beyond the limit of soil disturbance. When this method is relied upon, the nature of the pre-existing topography as well as the nature of the ground disturbance shall be described, using topographic contour maps and profiles where appropriate, to the satisfaction of the administrative authority.
- (d) In cases where disturbed soil or other fill material are present at the site, the suitability of this material shall be evaluated based upon its composition and its physical stability as follows:
1. Fill materials containing more than trace amounts of the following types of materials, or any other materials which are subject to disintegration or change in volume, shall be considered unsuitable:
 - i. Tree stumps, plant stems, leaves, food or animal remains or wastes, wood chips, saw dust, or any organic materials which may be subject to decay;
 - ii. Trash, discarded furniture, building or demolition debris or any bulky objects containing large voids or subject to collapse or re-orientation; or
 - iii. Cans, bottles, drums or any containers which are empty or filled with liquids.
 2. Layers of fill material which do not contain materials as described in (d)1 above but which do contain coarse fragments in excess of 50 percent by volume shall be considered excessively coarse horizons or substrata. In the case of disturbed ground, coarse fragments may include man-made or artificial materials as well as rock fragments which are larger than two millimeters in diameter, provided that the man-made materials are limited only to physically and chemically inert materials without large voids, such as brick, concrete or glass fragments.
 3. When construction of a wastewater disposal field is proposed within disturbed ground, an acceptable state of compaction of the soil or fill material shall be verified by laboratory tests of samples taken from within the area of the proposed disposal field. Based upon the results of these tests, the design engineer shall certify to the administrative authority that the in-place dry density of the soil or fill material above which the proposed

THIS IS A COURTESY COPY OF THIS RULE. ALL OF THE DEPARTMENT'S RULES ARE COMPILED IN TITLE 7 OF THE NEW JERSEY ADMINISTRATIVE CODE.

system will be located is a minimum of 90 percent of the Standard Procter Density determined by laboratory analysis.

4. When a disposal field is to be constructed on sloping ground which has been regraded, the design engineer shall certify to the administrative authority that the regraded area within and surrounding the individual subsurface sewage disposal system is stable and can structurally support the individual subsurface sewage disposal system.

(e) In cases where the surface of the ground has been raised by the addition of fill material or lowered by the removal of pre-existing soil horizons, soil suitability shall be determined based upon the depth to limiting zones measured from the existing ground surface determined as prescribed in (c) above, or the ground surface, whichever is lowest.

(f) Ground containing subsurface drainage systems or remnants of abandoned subsurface drainage systems shall be considered unsuitable for the installation of a disposal field unless the drains will be removed or the outlets of the drainage system permanently sealed. Any subsurface drain which has a surface outlet shall be considered as a watercourse and is subject to minimum horizontal setback distances from waste disposal system components as set forth in N.J.A.C. 7:9A-4.3.

(g) Ground containing existing wastewater disposal systems or remnants of abandoned systems shall be considered unsuitable for the installation of a disposal field unless the pre-existing system will be removed prior to installation of the proposed new system.

Subchapter 6. Permeability Testing

7:9A-6.1 General provisions for permeability testing

(a) The design permeability is the basis for determining the minimum required area of the disposal field. Tests shall be required at the site of each proposed disposal field in native soil or rock material to demonstrate an adequate zone of disposal as required at N.J.A.C. 7:9A-10.1(e). Tests shall be required in those areas demonstrating an adequate zone of disposal for determination of the design permeability. Design permeability tests shall be conducted as follows:

1. Design permeability tests for conventional disposal fields shall be conducted at the level of infiltration at a depth one to three feet below the ground surface within the soil horizon where the bottom of the disposal field will be placed;
2. Design permeability for all mounded disposal fields or soil replacement disposal fields where native soil will remain above the identified zone of disposal shall be determined from the remaining least permeable native soil material above the identified zone of disposal;
3. Design permeability for all soil replacement disposal fields, including mounded soil replacement systems, using fill material that meets the requirements of N.J.A.C. 7:9A-10.1(f) from the top of the zone of treatment to the top of zone of disposal shall be between six and 20 inches per hour; and
4. The permeability of all fill material shall be confirmed after installation to be greater than six inches per hour at the level of infiltration. A percolation test shall be conducted within the fill material after it has been emplaced and compacted, or a tube permeameter test shall be conducted using samples of the fill material which have been compacted to a bulk density equivalent to that achieved in the construction of the disposal field. An additional test shall be required at the top of each separate type of fill, should the fill material in the zone of treatment differ from the fill material being used in the zone of disposal, to confirm each type of fill material has been installed with a permeability rate greater than six inches per hour.

THIS IS A COURTESY COPY OF THIS RULE. ALL OF THE DEPARTMENT'S RULES ARE COMPILED IN TITLE 7 OF THE NEW JERSEY ADMINISTRATIVE CODE.

- (b) The administrative authority may require additional types of tests, or additional tests at additional locations or alternate depths other than the depth of infiltration, when doubt exists regarding the presence or the type of a limiting zone or the soil conditions present.
- (c) The type of tests which may be used shall be determined based upon the purpose of the test and the soil conditions at the depth of the test as shown in Table 6.1 below.

Table 6.1 Type of Test

Test Options:

- 1-Tube Permeameter Test
- 2-Soil Permeability Class Rating Test^t
- 3-Percolation Test
- 4-Basin Flooding Test
- 5-Pit-bailing Test
- 6-Piezometer Test

Purpose of Test and Soil Conditions at Depth of Test	Acceptable Test Options
I. Determination of Design Permeability at Level of Infiltration, Identification of Hydraulically Restrictive or Excessively Course Horizons or Substrata Above the Water Table	
A. Sands and loamy sands with single grain structure	1, 2 or 3
B. Other soil textures	
1. Undisturbed sample can be taken	1, 2 or 3
2. Undisturbed sample cannot be taken	2 or 3
II. Identification of Massive Rock Substrata Above the Water Table	4
III. Identification of hydraulically Restrictive Horizons or Substrata and Massive Rock Substrata Below the Water Table	5 or 6
IV. Design of Seepage Pits	3

^t This test shall not be used in soil horizons or substrata containing coarse fragments in excess of 50 percent by volume or 75 percent by weight.

- (d) The number and location of permeability tests required shall be as follows:

- 1. When the tube permeameter test or the soil permeability class rating test are used to determine the design permeability at the level of infiltration, a minimum of one test shall be conducted within each disposal field and each test shall consist of a minimum of two test replicates. The administrative authority shall require additional tests or more than two replicates per test where the variability of test results exceeds the limits allowed in N.J.A.C. 7:9A-6.2(i)2, or where the results of soil profile pits or borings, made as prescribed in N.J.A.C. 7:9A-5.2, indicate the presence of more than one soil type within the area of the disposal field. When soil tests taken in different parts of the disposal field yield different results, the system shall be designed based upon the most restrictive conditions found within the area of the disposal field.
- 2. When the basin flooding test, the pit-bailing test or the piezometer test are required for identification of limiting zones, a minimum of one test shall be required within or no further than 15 feet beyond the boundaries

THIS IS A COURTESY COPY OF THIS RULE. ALL OF THE DEPARTMENT'S RULES ARE COMPILED IN TITLE 7 OF THE NEW JERSEY ADMINISTRATIVE CODE.

of each disposal field. The administrative authority may require more than one test where conditions vary from one part of the disposal field to another.

3. In cases where a pit-bailing or basin flooding test pit or part of a test pit has been excavated within the boundaries of the proposed disposal trench or bed, the pit shall be backfilled after use in a manner that will not result in a major discontinuity with respect to soil horization, density, or permeability in the soil below the disposal bed or trench.

(e) When the percolation test is used the following requirements shall be met:

1. When the percolation test is used to determine the design permeability at the level of infiltration, the administrative authority shall require a minimum number of percolation tests based upon the size of the proposed disposal field, as follows:

Size of Disposal Field (Square feet)	Minimum Number of Tests
Less than 1,500	2
1,500 - 3,000	3
3,000 - 4,000	4
4,000 - 6,000	5

2. When the accuracy of a percolation test is questioned, one or more replicate tests may be performed at the same location within the disposal field as a means of better defining the true soil conditions at that particular location. The average of the results obtained from replicate tests at a given location within the disposal field shall be used for design purposes or for determination of soil suitability at that location.

3. The results of percolation tests taken at different locations within the disposal field shall not be averaged.

4. When a percolation test is abandoned due to lack of measurable percolation, this test may be disregarded provided that a minimum of three replicate tests taken at that same location yield acceptable results and provided that all subsequent test replicates taken at that location yield measurable percolation rates.

5. All percolation tests shall be located within the boundaries of the proposed disposal field and only the most restrictive percolation rate obtained within the disposal field shall be utilized for design purposes.

6. Percolation tests shall be uniformly spaced within the area of the disposal field. Acceptable patterns of percolation test placement are shown in Appendix C.

7. When a seepage pit is proposed, as allowed in N.J.A.C. 7:9A-7.6, a minimum of one percolation test shall be performed within each soil horizon or substratum between the invert of the inlet and the bottom of the seepage pit. The administrative authority may require additional tests below the bottom of the seepage pit where the presence of a limiting zone is in question.

(f) The administrative authority or its authorized agent shall witness permeability tests in accordance with the requirements of N.J.A.C. 7:9A-3.6.

(g) When the results of a permeability test or a percolation test are questionable, the administrative authority or its authorized agent may require that the test be repeated. When the tube permeameter test or the soil permeability class rating method is used, the administrative authority may collect and test replicate samples for verification of soil permeability. In cases where the results obtained by the applicant differ from those obtained by the administrative authority, the results obtained by the administrative authority shall be used for design or determination of soil suitability.

(h) Except as provided in N.J.A.C. 7:9A-6.3, only unadulterated water to which no foreign substances or chemical additives have been added shall be used to conduct permeability or percolation tests. The addition of foreign substances or chemical additives to water used for permeability testing shall be considered as a falsification of data subject to penalties as outlined in N.J.A.C. 7:9A-1.7.

THIS IS A COURTESY COPY OF THIS RULE. ALL OF THE DEPARTMENT'S RULES ARE COMPILED IN TITLE 7 OF THE NEW JERSEY ADMINISTRATIVE CODE.

- (i) The results of all permeability tests or percolation tests, complete or incomplete, including all test replicates, taken within the disposal field or less than 150 feet beyond the boundaries of the proposed disposal field shall be reported to the administrative authority using data submission forms as provided in Appendix B. Results shall be reported regardless of whether or not they are acceptable and regardless of whether or not they are used as a basis for the disposal field design. Failure to report test results shall be considered a falsification of data and may subject the violator to penalties as outlined in N.J.A.C. 7:9A-1.7.
- (j) The administrative authority may allow the use of test methods other than the standard test options outlined in N.J.A.C. 7:9A-6.1(c), subject to review and approval of the test method by the Department.
- (k) A septic system designer shall carry out or directly supervise and certify all soil testing procedures and results relied upon as a basis for the design of an individual subsurface sewage disposal system and determine the permeability of fill material on site as determined by the tests required in (a) above.
- (l) Where test sampling indicates inadequate permeability in a specific soil horizon to comply with this chapter, the test location(s) established both horizontally and vertically and an area 15 feet around the test location(s) in that same soil horizon shall not be utilized as disposal area unless three additional replicate tests are performed within that area and horizon, each of which demonstrate acceptable permeability.

7:9A-6.2 Tube permeameter test

- (a) The following equipment is required for the tube permeameter test:
 - 1. A thin-walled (one millimeter or less in thickness) metal tube, from one and one-half to three inches in diameter, six inches in length, beveled on the lower outside edge;
 - 2. A wooden block with dimensions broader than the diameter of the tube in (a)1 above and a hammer, to drive the tube into the soil;
 - 3. A small trowel;
 - 4. A knife (to trim core);
 - 5. Muslin or similar open-textured cloth and a rubberband;
 - 6. A soaking basin of adequate size and depth to soak cores as prescribed in (c) below;
 - 7. Fine gravel (from two to 10 millimeters in diameter);
 - 8. A test basin of adequate length (generally 10 inches or greater) and width (generally four inches or greater) to accommodate one or more replicate samples at a time. The depth of the basin should be adequate to allow placement of the sample on a layer of gravel while keeping the bottom of the core several inches below the rim of the basin, as prescribed in (d) below (See Figure 5 of Appendix A);
 - 9. A stopper which fits water-tight into the top of the sample tube and which is fitted with a glass standpipe from three to five inches long and from 0.25 to 0.75 inches in diameter (See Figure 5 of Appendix A). The standpipe should have a scale for measuring changes in water level over time as required in (d) below;
 - 10. A small laboratory wash bottle for refilling standpipe;
 - 11. A clock or watch with second hand;
 - 12. A ruler (engineering scale is best);
 - 13. One gallon of water per test. The water should be allowed to stand in an open container until clear of dissolved air. Boiling may be used to remove air provided that the water is allowed to cool down to room temperature before use; and
 - 14. A two millimeter sieve.

THIS IS A COURTESY COPY OF THIS RULE. ALL OF THE DEPARTMENT'S RULES ARE COMPILED IN TITLE 7 OF THE NEW JERSEY ADMINISTRATIVE CODE.

- (b) When the tube permeameter test is used, undisturbed samples shall be collected as prescribed in (d) below. When the texture of the soil to be tested is a sand or loamy sand and lack of soil cohesion or the presence of large amounts of coarse fragments, roots or worm channels prevent the taking of undisturbed samples, disturbed samples shall be taken as prescribed in (e) below. When the texture of the soil is other than a sand or loamy sand and undisturbed samples cannot be taken, the tube permeameter test shall not be used.
- (c) When the tube permeameter test is used, a minimum of two replicate samples shall be taken and the procedures outlined in this section shall be followed for each replicate sample to be tested. It is recommended that more than two replicate samples be taken to avoid the necessity of re-sampling in the event that samples are damaged in transport or the results of one or more replicate tests must be rejected due to extreme variability of results, as required in (i) below. Replicate samples shall be taken from within the same soil horizon at the same location within the area of the proposed disposal field.
- (d) The following procedure shall be used to collect each replicate sample:
1. Step One: Expose an undisturbed horizontal surface within and a minimum of three inches above the bottom of the soil horizon or layer to be tested.
 2. Step Two: Position the sampling tube on the soil surface at the point chosen for sampling. Care should be taken to avoid large gravel or stones, large roots, worm holes or any discontinuity which might influence results. If the soil is excessively dry it may be moistened, but not saturated, provided that the force of falling water is not allowed to act directly upon the soil surface.
 3. Step Three: Hold the wooden block on the top of the sampling tube and drive the tube into the soil a distance of from two to four inches (but not entirely through the horizon) using light even blows with the hammer. Care should be taken to hit the block squarely in the center and to drive the tube straight down into the soil. Do not attempt to straighten the tube by pushing or by hitting the tube on the side with the hammer.
 4. Step Four: When the tube has been driven to the desired depth, carefully remove the soil around the outside of the tube, insert a trowel into the soil below the tube and, exerting pressure from below, lift the sampling tube out of the soil.
 5. Step Five: Trim the bottom of the soil core flush with the sampling tube using a knife and taking care not to smear the soil surface. Carefully invert the sampling tube and tap the side lightly with the handle of the knife or similar implement to remove any loose soil which may be resting on the top of the soil core and to verify that an undisturbed sample has been obtained. Omit this step in the case of sandy-textured non-cohesive soils with single grain structure. Check the top and bottom surfaces of the core sample and discard any sample which has worm holes or large cracks caused by handling.
 6. Step Six: After the core has been checked for worm holes or signs of disturbance, stretch a piece of muslin cloth over the bottom of the tube and secure with a strong rubberband.
- (e) The following procedure shall be used for the collection of disturbed samples for the tube permeameter test:
1. Step One: Collect an adequate volume of the soil or fill material to be tested. Spread the soil on a clean surface and allow to dry in the air until dry to the touch. An oven may be used to accelerate drying provided that the soil is allowed to cool down to room temperature before testing.
 2. Step Two: Pass the soil through a two millimeter sieve to remove gravel and stones.
 3. Step Three: Stretch a piece of muslin cloth over the bottom of the sampling tubes and place the tubes on a flat surface. Slowly pour the soil into each sampling tube while gently tapping the side of the tube with a hard instrument. Fill the tubes to a depth of three to four inches. Check the bulk density of the sample by dividing the weight of the sample (weight of sample tube containing sample minus the weight of empty sample tube) by the volume of the sample (length of sample multiplied by $3.14 r^2$, where r is the internal radius of the sample tube). The minimum acceptable bulk density for disturbed samples is 1.2 grams per cubic centimeter.

THIS IS A COURTESY COPY OF THIS RULE. ALL OF THE DEPARTMENT'S RULES ARE COMPILED IN TITLE 7 OF THE NEW JERSEY ADMINISTRATIVE CODE.

(f) The following procedure shall be used for pre-soaking undisturbed or disturbed core samples for the tube permeameter test:

1. Step One: Place the soil core in the pre-soak basin and fill the basin with water to a point just below the top of the soil core. Never fill the basin to a level which is higher than the top of the soil core. Never use water directly from the tap to soak cores. Use only de-aired water as prescribed in (a)13 above. Allow the sample to soak until the top surface of the core is saturated with water. This may require only a few minutes of soaking for sandy textured soils or several days for clay textured soils. Failure to soak the sample for sufficient time may result in greatly reduced permeability measurements due to entrapped air.
2. Step Two: When the sample has soaked for sufficient time, place a one inch layer of fine gravel (from two to 10 millimeters in diameter) on top of the soil core in the sampling tube. Slowly fill the tube with de-aired water taking care not to disturb the surface of the core. A small spatula or similar implement may be used to break the fall of the water as it is poured into the tube.
3. Step Three: Immediately transfer the soil core to the test basin in which a layer of gravel has been placed and gently press the soil core into the gravel so that it stands vertically with its base positioned at the desired depth below the rim of the test basin.

(g) The following procedure shall be used to conduct the tube permeameter test:

1. Step One: When the soil core has been positioned at the desired height within the test basin (see Figure 5 of Appendix A), fill the test basin to overflowing with de-aired water. (Note: The hydraulic head used in the test depends upon the height of the top of the sample tube or standpipe above the rim of the test basin as shown in Figure 5. In general, a higher hydraulic head should be used for heavy textured soils to expedite the test and a lower head should be used for sandy textured soils to prevent an excessively fast flow rate).
2. Step Two: Fill the tube to overflowing with de-aired water and record the time, in minutes, required for the water level in the tube to drop a standard distance such as one-half inch, one inch, or two inches. Repeat this step until the rate of fall becomes constant or the difference between the highest and lowest of three successive readings is less than five percent. When the readings are less than 20 minutes in length the time should be reported to the nearest second.
3. Alternate Step Two: When the rate of fall observed in "Step Two" ((g)2 above) is slow, the flow rate may be increased by use of a standpipe as shown in Figure 5. Carefully insert the standpipe into the top of the sample tube and fill with de-aired water. The apparatus should be checked for leaks where the standpipe fits into the sample tube. Silicon jelly, petroleum jelly or a similar material may be used to prevent leakage. Measure the rate of fall of the water level in the standpipe as in Step Two.

(h) The permeability of each replicate sample tested shall be calculated using the following formula:

1. $K \text{ (in/hr)} = 60 \text{ min/hr} \times L \text{ (in)} / T \text{ (min)} \times r^2 / R^2 \times \ln (H_1 / H_2)$ Where:

K is the permeability of the soil sample;

L is the length of the soil core, in inches;

T is the time, in minutes, required for the water level to drop from H₁ to H₂ during the final test interval;

r is the radius of the standpipe, in centimeters or inches;

R is the radius of the soil core, in the same units as "r";

ln is the natural logarithm

H₁ is the height of the water level above the rim of the test basin at the beginning of each test interval, in inches; and

H₂ is the height of the water level above the rim of the test basin at the end of each test interval, in inches.

THIS IS A COURTESY COPY OF THIS RULE. ALL OF THE DEPARTMENT'S RULES ARE COMPILED IN TITLE 7 OF THE NEW JERSEY ADMINISTRATIVE CODE.

[Note: When the standpipe is not used, the term r^2/R^2 is omitted from the equation.]

(i) Variability of test results shall be evaluated as follows:

1. Soil permeability classes are defined as follows:

Measured Permeability Greater than	Soil Permeability Class
20 inches per hour ("in/hr")	K5
6-20 in/hr	K4
2-6 in/hr	K3
0.6-2 in/hr	K2
0.2-0.6 in/hr	K1
Less than 0.2 in/hr	K0

2. The variability of soil permeability test results shall be considered acceptable only where the results of all replicate tests fall within one soil permeability class or two adjacent permeability classes.

3. Where the results of replicate tests differ by more than one soil permeability class, the samples shall be examined for the following defects:

- i. Cracks, worm channels, large root channels or poor soil tube contact within the sample yielding the highest permeability value(s);
- ii. Large pieces of gravel, roots or unsaturated soil within the interior of the sample yielding the slowest permeability value(s); or
- iii. Smearing or compaction of the upper or lower surface of the sample yielding the lowest permeability value(s).

4. If any of the defects described in (i)3 above are found, the defective core(s) shall be discarded and the test repeated using a new replicate sample for each defective replicate sample.

(j) When test results have been obtained with an acceptable range of variability as defined in (i) above, the results shall be interpreted as follows:

1. When the purpose of the test is to determine the design permeability at the level of infiltration, the slowest of the test replicate results shall be used for design purposes.
2. When the purpose of the test is to identify a hydraulically restrictive horizon or substratum above the water table, the horizon or substratum in question shall be considered hydraulically restrictive if the average permeability of the replicate samples tested falls within soil permeability class KO as defined in (i)1 above.
3. When the purpose of the test is to identify an excessively coarse horizon or substratum above the water table, the horizon or substratum in question shall be considered excessively coarse if the average permeability of the replicate samples tested falls within permeability class K5 as defined in (i)1 above.

(k) Where results of replicate tests exceed the limits of variability allowed in (i)2 above, the results shall be interpreted as follows:

1. When the purpose of the test is to determine the design permeability at the depth of infiltration, the slowest of the test replicate results shall be used for design purposes.
2. When the purpose of the test is to identify a hydraulically restrictive horizon or substratum above the water table, the horizon or substratum in question shall be considered hydraulically restrictive if the slowest permeability of the replicate samples tested falls within soil permeability class KO as defined in (i)1 above.

THIS IS A COURTESY COPY OF THIS RULE. ALL OF THE DEPARTMENT'S RULES ARE COMPILED IN TITLE 7 OF THE NEW JERSEY ADMINISTRATIVE CODE.

3. When the purpose of the test is to identify an excessively coarse horizon or substratum above the water table, the horizon or substratum in question shall be considered excessively coarse if the fastest permeability of the replicate samples tested falls within permeability class K5 as defined in (i)1 above.

7:9A-6.3 Soil permeability class rating

(a) Determination of permeability by the soil permeability class rating technique is based upon a hydrometer analysis performed as prescribed in (f) below, and a sieve analysis performed as prescribed in (g) below, together with evaluation of soil morphological properties as prescribed in N.J.A.C. 7:9A-5.2 and 5.3. As an alternate to the hydrometer analysis procedure prescribed in (f) below, the hydrometer analysis procedure given in ASTM STANDARD D 422, published by the American Society for Testing and Materials, may be used to determine the percent by weight of sand and the percent by weight of clay in the sample.

(b) The following equipment is required:

1. A two-millimeter sieve, with an eight inch or larger diameter frame;
2. A set of two sieves, with five inch or larger diameter frames, with covers and pans. The sieves shall meet the following specifications:
 - i. The first sieve shall be 0.25 millimeter, 60-mesh, Bureau of Standards, phosphor bronze wire cloth; and
 - ii. The second sieve shall be 0.045 millimeter, 325-mesh, Bureau of Standards, phosphor bronze wire cloth (0.0015 wire);
3. A wooden rolling pan or mortar with rubber-tipped pestle;
4. An oven;
5. A scale (0.1 gram accuracy);
6. Distilled water;
7. A sodium hexametaphosphate solution of 50 grams of the salt dissolved in one liter of distilled water;
8. The electric mixer (see section 2.1.1 of ASTM Standard D 422) or mechanical shaker;
9. A 1000 milliliter graduated cylinder with rubber stopper;
10. A soil hydrometer calibrated to read in grams per liter at 68 degrees Fahrenheit (ASTM #152H);
11. A thermometer;
12. A clock with second hand; and
13. A sieve shaker

(c) A loose sample of soil, 200 grams or more, shall be collected from the soil horizon or substratum to be tested.

(d) The soil sample shall be prepared as follows:

1. Pass the soil sample to be tested, which has been allowed to air dry, through a two millimeter sieve to remove coarse fragments. Use moderate pressure with a wooden rolling pin or mortar with rubber-tipped pestle to break soil aggregates (but not soft rock fragments) which are larger than two millimeters.
2. Weigh both the material retained and the material which passes through the sieve. This method shall not be used where the weight of coarse fragments retained on the sieve exceeds 75 percent of the total sample weight.
3. Discard the coarse fragments.

(e) Dispersion of the soil sample shall be accomplished using a motor-mixed or a reciprocating shaker as prescribed below. This procedure shall be followed for each replicate sample tested.

THIS IS A COURTESY COPY OF THIS RULE. ALL OF THE DEPARTMENT'S RULES ARE COMPILED IN TITLE 7 OF THE NEW JERSEY ADMINISTRATIVE CODE.

1. Step One: Place 40 grams of air dry soil which has been passed through a two millimeter sieve into a mixing cup or one liter shaker bottle together with 100 milliliters of sodium hexametaphosphate solution and 400 milliliters of distilled water. Weigh out an additional 40 gram sample for determination of oven dry weight. Re-weigh the latter sample after keeping it in an oven at 105 degrees Centigrade for 24 hours. (Only one sample is required for determination of oven-dry weight regardless of the number of replicate samples used for the hydrometer analysis).

2. Step Two: If a motor mixer is used, allow the soil to soak in the cup for 10 minutes, place the cup on the mixer and mix the sample for five minutes. Next, transfer the suspension completely to the cylinder. Rinse the mixing cup with distilled water and pour the rinse water into the cylinder so that none of the suspension is left in the mixing cup. Bring the volume of the suspension in the cylinder up to the 1000 milliliter mark with distilled water. Allow the suspension to reach room temperature.

3. Alternate Step Two: If a reciprocating shaker is used in lieu of the mixer, shake the sample for 12 hours, at a rate of approximately 120 strokes per minute, and transfer to the cylinder rinsing the shaking bottles with distilled water. Bring the volume of the suspension in the cylinder to the 1000 milliliter mark with distilled water. Allow the suspension to reach room temperature.

(f) The following procedure shall be used for the hydrometer analysis:

1. Step One: Calibrate the hydrometer as follows: Add 100 milliliters of sodium hexametaphosphate solution to a 1000 milliliter cylinder and fill to the 1000 milliliter mark with distilled water. Place the stopper in the cylinder and shake vigorously in a back and forth motion. Place the cylinder on the table and lower the hydrometer into the solution. Determine the scale reading at the upper edge of the meniscus surrounding the hydrometer stem. This is the hydrometer calibration, R_c . Record the temperature in degrees Fahrenheit ($^{\circ}F$).

2. Step Two: Place a stopper in the cylinder containing the dispersed soil sample, shake the cylinder using a back and forth motion (avoid causing circular currents in the cylinder) and place the cylinder on the table. Record the time immediately. After 20 seconds carefully lower the hydrometer into the cylinder and, after exactly 40 seconds, read the hydrometer. Repeat this step until two successive readings are obtained which agree within 0.5 gram per liter.

3. Step Three: Determine the temperature of the suspension and correct the hydrometer reading as follows:

i. Subtract the reading obtained in Step One, R_c , from the hydrometer reading.

ii. For each degree Fahrenheit above 68 add 0.2 gram to the reading or for each degree Fahrenheit below 68 subtract 0.2 gram.

4. Step Four: Remove the hydrometer, stopper the cylinder, and shake the hydrometer as in Step Two. Remove the stopper and immediately place the cylinder on a table where it will not be disturbed. Take a hydrometer reading after exactly two hours and correct the hydrometer reading as in Step Three.

5. Step Five: Using test data reporting forms provided in Appendix B, record, the following data:

i. Oven dry weight of soil, W_t (from Step One of (e) above);

ii. Hydrometer calibration, R_c and Temperature ($^{\circ}F$) (Step One);

iii. Hydrometer reading at 40 seconds, R_1 (Step Two);

iv. Temperature of suspension (Step Three);

v. Corrected hydrometer reading, R_1' (Step Three);

vi. Hydrometer reading at two hours, R_2' (Step Four); and

vii. Corrected hydrometer reading, R_2' (Step Four);

6. Step Six: Calculate the percent of sand and percent of clay as follows:

THIS IS A COURTESY COPY OF THIS RULE. ALL OF THE DEPARTMENT'S RULES ARE COMPILED IN TITLE 7 OF THE NEW JERSEY ADMINISTRATIVE CODE.

i. Percent of sand = $(Wt. - R')/Wt. \times 100$

ii. Percent of clay = $R2'/Wt. \times 100$

NOTE: The hydrometer analysis may not be carried out in a room where the temperature varies more than two degrees during the time required to perform the test.

(g) A sieve analysis shall be performed as prescribed below for each replicate sample used in the hydrometer analysis except when the content of sand determined as prescribed in Step Six of (f) above is less than 25 percent.

1. Step One: After the completion of Step Four in (f) above, pour the suspension from the sedimentation cylinder into a 0.045 millimeter sieve and wash the fine material through the sieve using running water.

2. Step Two: Dry the sieve and its contents in an oven. Cool the sieve and transfer the sand to a pre-weighed evaporating dish (or similar heat resistant vessel) carefully, using a soft brush.

3. Step Three: Place the dish and its contents in an oven at 105 degrees Centigrade, for two hours, to dry. Cool the dish and its contents and weigh to the nearest 0.01 gram. Determine the weight of the sand by subtracting the weight of the dish.

4. Step Four: Assemble a stack of sieves as specified in (a)2 above, consisting of the pan, the 0.045 millimeter sieve and the 0.25 millimeter sieve, from bottom to top, respectively. Inspect sieves carefully before using to make sure that they are clean and undamaged. Transfer the sand from the evaporating dish to the top sieve using a soft brush to complete the transfer.

5. Step Five: Put the cover on the top sieve, firmly fasten the sieves to the sieve shaker and shake for three minutes. Disassemble the stack of sieves, transfer the contents of each sieve to a weighing dish separately. Weigh the contents of each sieve to the nearest 0.01 gram. Record the following data:

i. Total weight of sand fraction, from Step Three;

ii. Weight of sand passing the 0.25 millimeter sieve (retained in the 0.045 millimeter sieve);

iii. Percent fine plus very fine sand: Divide weight of sand passing 0.25 millimeter sieve by total weight of sand fraction and multiply this value by 100.

(h) The following procedure shall be used to determine the soil permeability class:

1. Step One: Using the soil permeability/textural triangle, Figure 6 of Appendix A, determine the soil permeability class of the soil horizon being tested, based upon the average percentage of sand and the average percentage of clay in the replicate samples tested as prescribed in (f) above.

2. Step Two: If the average percentage of fine plus very fine sand in the replicate samples tested, determined as prescribed in Step Five of section (g) above, is 50 percent or greater, adjust the permeability class determined in Step One of this subsection to the next slowest class.

3. Step Three: If the soil horizon being tested is found to have a massive or platy structure or a hard, very hard, firm, very firm or extremely firm consistence, determined as prescribed in N.J.A.C. 7:9A-5.3, adjust the permeability class determined in Step One of this subsection to the next slowest class.

7:9A-6.4 Percolation test

(a) The following equipment is required for the percolation test:

1. A soil auger, post-hole digger or other means of preparing a test hole as prescribed in (b) below;

2. A knife or trowel for removing smeared or compacted surfaces from the walls of the test hole;

3. Fine (from two to 10 millimeter in diameter) gravel (optional);

4. A water supply (50 gallons is generally adequate);

THIS IS A COURTESY COPY OF THIS RULE. ALL OF THE DEPARTMENT'S RULES ARE COMPILED IN TITLE 7 OF THE NEW JERSEY ADMINISTRATIVE CODE.

5. A straight board (to serve as fixed reference point for water level measurements);
6. A clock and a ruler (12 inches or longer, engineering scale);
7. An automatic siphon or float valve (optional); and
8. A hole liner consisting of a 14 inch section of slotted pipe or well screen, or a 14 inch length of one-quarter inch hardware cloth or other similar material rolled into a tube (optional). The hole liner shall be no smaller than two inches in diameter less than the test hole.

(b) Percolation tests shall not be conducted in frozen ground or in holes which have been allowed to remain open to the atmosphere for periods greater than three days. The required configuration of the test hole is illustrated in Figure 7 of Appendix A. The following procedure shall be used in preparation of the test hole.

1. Step One: Excavate a test hole having horizontal dimensions of eight to 12 inches at a depth such that the lower six inches of the test hole are contained entirely within the soil horizon or layer of fill material being tested. In order to facilitate access to the lower portion of the hole, the test hole may be excavated from the bottom of a shallow pit provided that the vertical axis of the test hole is a minimum of 14 inches measured from the bottom of the pit to the bottom of the test hole.
2. Step Two: In soil textures other than sands or loamy sands, remove smeared or compacted soil from the sides and bottom of the test hole by inserting the tip of a knife or trowel into the soil surface and gently prying upward and outward. Remove loose soil from the test hole.
3. Step Three: At this point, a one-half inch layer of fine gravel may be placed in the bottom of the hole to protect the soil surface from disturbance or siltation when water is added to the hole. If additional protection is desired, a hole liner as described in (a)8 above may be placed in the hole and the space between the liner and the sides of the hole may be filled with fine gravel.
4. Step Four: Place and secure a straight board horizontally across the top of the test hole, as shown in Figure 7 of Appendix A, to serve as a fixed point for depth of water measurements to be made at appointed time intervals throughout the test.

(c) All soils, except for sandy textured soils which meet the requirements of (d) below, shall be pre-soaked using the following procedure. Any soil which exhibits cracks or fissures between soil aggregates shall be pre-soaked regardless of the texture. Pre-soak as follows:

1. Fill the test hole with water and maintain a minimum depth of 12 inches for a period of four hours by refilling as necessary or by means of an automatic siphon or float valve.
2. At the end of four hours, cease adding water to the hole and allow the hole to drain for a period of from 16 to 24 hours.

(d) In sandy textured soils, including sands, loamy sands and sandy loams, where a rapid percolation rate is anticipated, fill the test hole to a depth of 12 inches and allow to drain completely. Refill the hole to a depth of 12 inches and record the time required for the hole to drain completely. If this time is less than 60 minutes, the test procedure may begin as prescribed in (e) below without further pre-soaking. If water remains in the test hole after 60 minutes, the hole must be pre-soaked as prescribed in (c) above before proceeding with the test.

(e) Immediately following the pre-soak procedure (no more than 28 hours after the start of the pre-soak procedure), the percolation rate shall be determined using the following procedure:

1. Step One: If water remains in the test hole after the completion of the pre-soak period, the test shall be terminated and the percolation rate shall be reported as greater than 60 minutes per inch. If no water remains in the test hole, fill to a depth of seven inches. At a five to 30 minute time interval, depending upon the rate of fall, record the drop in water level to the nearest one-tenth of an inch. Refill the hole at the end of each time interval and repeat this procedure using the same time interval until a constant rate of fall is attained. A

THIS IS A COURTESY COPY OF THIS RULE. ALL OF THE DEPARTMENT'S RULES ARE COMPILED IN TITLE 7 OF THE NEW JERSEY ADMINISTRATIVE CODE.

constant rate of fall is attained when the difference between the highest and lowest of three consecutive measurements is no greater than two-tenths of an inch.

2. Step Two: Immediately after the completion of Step One, refill the test hole to a depth of seven inches and record the time required for exactly six inches of water to seep away. This time divided by six will be the percolation rate in minutes per inch.

(f) The results of the percolation test shall be interpreted as follows:

1. When the purpose of the test is to determine the design permeability at the level of infiltration, the slowest percolation rate determined within the proposed disposal field shall be used for design purposes. If any of the measured percolation rates are slower than 60 minutes per inch or faster than three minutes per inch the application shall not be approved. A percolation rate may be the result of a single percolation test or the average of several replicate tests, as allowed in N.J.A.C. 7:9A-6.1(e)2.
2. When the result of the test(s) is an average percolation rate slower than 60 minutes per inch, the horizon or substratum in question shall be considered hydraulically restrictive.
3. When the result of the test(s) is an average percolation rate faster than three minutes per inch, the horizon or substratum in question shall be considered excessively coarse.
4. When a seepage pit is proposed, the design percolation rate shall be calculated by adding the products of the percolation rate and the thickness of each individual horizon tested and dividing the result by the total thickness of all the horizons tested. Any horizon with a percolation rate slower than 40 minutes per inch shall be excluded from this computation.

7:9A-6.5 Pit-bailing test

(a) The following equipment is required for performing a pit-bailing test (see Figure 8 in Appendix A):

1. A back-hoe;
2. Wooden or metal stakes, string and a hanging level;
3. A steel measuring tape;
4. A pump (optional);
5. A stop-watch; and
6. A perforated pipe, with a three inch diameter or greater.

(b) The following procedure shall be used for preparation of the test pit:

1. Step One: Excavate a test pit extending into but not below the soil horizon or layer to be tested. The bottom of the pit should be a minimum of 1.5 feet below the observed water level and a minimum of six feet below the proposed level of infiltration. The bottom of the pit should be relatively flat and level. The shape of the pit within the depth interval tested should be approximately square or round. A rectangular or elliptical pit may be used provided that, within the depth interval tested, the length of the long dimension is no more than twice the length of the short dimension. The excavation made for a soil profile pit as prescribed in N.J.A.C. 7:9A-5.2 may be used provided that all the above requirements are met.

2. Step Two: Allow the water level to rise in the pit for a minimum of two hours and until the sides have stabilized. If large volumes of soil have slumped into the pit, this soil must be removed before proceeding with the test. If the sides of the pit continue to slump and cannot be stabilized, the test shall be abandoned. If water is observed seeping into the pit from soil horizons above the zone of saturation in which the test is being conducted, adequate means shall be taken to intercept and divert this water away from the test pit, otherwise the pit-bailing test shall not be used. If, during the excavation of the pit, the water level in the pit rises

THIS IS A COURTESY COPY OF THIS RULE. ALL OF THE DEPARTMENT'S RULES ARE COMPILED IN TITLE 7 OF THE NEW JERSEY ADMINISTRATIVE CODE.

suddenly after a hydraulically restrictive horizon is penetrated, and continues to rise above the bottom of the hydraulically restrictive horizon, the pit-bailing test shall not be used.

(c) The following procedure shall be used for performance of the pit-bailing test and the calculation of test results:

1. Step One: Establish a fixed reference point for depth to water level measurements which will not be disturbed during removal of water from the pit or which can be temporarily removed and later re-positioned in exactly the same place. One way to establish a removable reference level mark is as follows:

- i. Drive stakes firmly into the ground on opposite sides of the test pit, several feet beyond the edge, where they will not be disturbed.
- ii. Next, stretch a string with hanging level from stake to stake, over the pit, and adjust the string to make it level.
- iii. Finally, secure the string to the stakes and mark or notch the positions on the stakes where the string is attached so that the string may be removed temporarily and later repositioned exactly in its place.

2. Step Two: Measure the distance from the reference level to the bottom of the pit and to the observed water level.

3. Step Three: Lower the water in the pit by at least one foot, by pumping or bailing. If the back-hoe bucket is used to remove water from the pit, it may be necessary to remove the reference level marker prior to bailing and re-position it in its original position prior to beginning step four.

4. Step Four: Choose a time interval, based upon the observed rate of water level rise. At the end of each time interval, measure and record the information indicated in (c)4 i through iii below and repeat these measurements until the water level in the pit has risen a total of one foot or more.

- i. Time, in minutes (the time interval, in minutes, between measurements should be chosen to allow the water level to rise by several inches);
- ii. Depth of water level below the reference string at the end of each time interval, to the nearest eighth of an inch or one-hundredth of a foot; and
- iii. Area of water surface, in square feet. Measure appropriate dimensions of the water surface, depending on the shape of the pit, to permit calculation of the area of the water surface at the time of each water level depth measurement. Entering a soil pit excavated below the water table can be extremely dangerous and should be avoided unless the pit is relatively shallow and the sides of the pit have been stepped and sloped as prescribed in N.J.A.C. 7:9A-5.2(e)3 to eliminate the likelihood of sudden and severe cave-in of the pit. The distance between two opposite edges of the water surface can be measured accurately, without entering the pit, as follows. Place a board on the ground, perpendicular to the side of the pit and extending out over the edge. Using a plumb-bob, position this board so that its end is directly over the edge of the water surface in the pit, below. Position a second board, in the same manner, on the opposite side of the pit. Measure the distance between the ends of the boards to determine the length of the water surface below.

5. Step Five: Determine whether an adequately consistent set of data has been obtained in accordance with (e)5i and ii below.

i. Calculate the permeability for each time interval using the following equation:

$$K_a = (h_{\text{rise}}/t) \times [A_{\text{av}} / 2.27(H^2 - h^2)] \times 60 \text{ min/hr}$$

where:

K_a = permeability, in inches per hour;

h_{rise} = difference in depth to water level at the beginning and end of the time interval, in inches;

THIS IS A COURTESY COPY OF THIS RULE. ALL OF THE DEPARTMENT'S RULES ARE COMPILED IN TITLE 7 OF THE NEW JERSEY ADMINISTRATIVE CODE.

t = length of time interval, minutes;

A_{av} . = average of water surface area at the beginning of time interval (end of previous time interval) and at the end of the time interval, in square feet;

H = difference between depth to assumed static water level and actual or assumed depth to impermeable stratum, in feet (Depth to impermeable stratum, if unknown, is assumed to be one and one-half times the depth of the pit.); and

h = difference between average depth of water levels at beginning and end of time interval and actual or assumed depth to the impermeable stratum, in feet.

ii. If the calculated values of K_a for successive time intervals show either an increasing or a decreasing trend, repeat Steps Three and Four until consecutive values of K_a are approximately equal.

6. Step Six: Remove as much water as possible from the pit. Continue excavating the pit until an impermeable stratum is encountered or as deep as possible considering the limitations of the excavating equipment used and the nature of the soil conditions encountered. Where no impermeable stratum is encountered, the impermeable stratum shall be assumed to be at the bottom of the excavation. Due to the potential safety hazards posed by the excavation of a large test pit such as that required for this test, adequate safety measures shall be taken, including the posting of warning signs and installation of a fence to prohibit access to the pit by the public during periods when the pit is left unattended.

7. Step Seven: Record the depth to the static water level from the same reference level used in Step One, (c)1 above. This step may be conducted either 24 hours after completion of Step Six at (c)6 above or of Step Two at (b)2 above.

8. Step Eight: Recalculate the permeability, K, using the following formula:

$$K = (h_{rise}/t) \times [A_{av}/2.27(H^2 - h^2)] \times 60 \text{ min/hr}$$

where:

K = permeability, inches per hour;

The values of h_{rise} , t, and A_{av} . are the values recorded for these parameters in the last time interval of Step Four of this subsection:

H = difference between depth to actual corrected static water level and actual or assumed depth to impermeable stratum, recorded in Steps Six and Seven, in feet; and

h = difference between the average depth of water levels at the beginning and end of the last time interval recorded in Step Four and the actual or assumed depth to impermeable stratum recorded in Step Six, in feet.

(d) When the permeability calculated in Step Eight of (c) above is slower than 0.2 inch per hour, the horizon(s) being tested shall be considered a hydraulically restrictive horizon and shall not be considered an acceptable zone of wastewater disposal.

7:9A-6.6 Piezometer test

(a) The following equipment is required for the piezometer test:

1. A screw type soil auger, minimum of one inch in diameter, with extensions;
2. A piezometer tube consisting of a metal pipe beveled on the outside lower edge, with an inside diameter about one-sixteenth of an inch larger than the diameter of the soil auger;
3. A maul or hammer, to drive pipe into the ground;
4. A pump with tubing, to evacuate water from piezometer tube;

THIS IS A COURTESY COPY OF THIS RULE. ALL OF THE DEPARTMENT'S RULES ARE COMPILED IN TITLE 7 OF THE NEW JERSEY ADMINISTRATIVE CODE.

5. A stop watch;

6. A means for accurately measuring the water level within the piezometer tube as a function of time, which may consist of one of the following:

i. A light-weight rod with measuring scale mounted on a cylindrical float with a diameter one-quarter inch or more smaller than the inside diameter of the piezometer tube;

ii. An electric probe consisting of a thin wire embedded in and protruding from the tapered end of a wooden rod, graduated in inches, and connected in series to a limiting resistor, a millimeter and a 33-volt hearing-aid battery, the opposite terminal of which is connected to the piezometer tube; or

iii. For depths greater than six feet, an electric sounder or the "wetted tape" method should be used.

(b) The following procedure shall be used for the piezometer test:

1. Step One: Remove any sod, vegetation or leaf litter from the ground surface where the test hole will be excavated. The test hole may be excavated from the ground surface or from the bottom of a larger excavation or soil profile pit.

2. Install the piezometer in accordance with Step Two A and Two B outlined in (b)2i and ii below or Alternate Step Two outlined in (b)2iii below.

i. Step Two A: Using the soil auger, drill the test hole down to a depth of six inches. Remove the auger and drive the piezometer tube into the hole to a depth of five inches. Re-insert the soil auger through the piezometer tube and into the test hole and drill down six inches further. Remove the soil auger, drive the piezometer tube six inches deeper, re-insert the auger and drill six inches deeper, repeating this procedure until the test hole reaches the top of the soil horizon or zone within a soil horizon to be tested.

ii. Step Two B: Using the soil auger, extend the test hole exactly four inches below the bottom of the piezometer tube (see Figure 9 of Appendix A). In coarse-textured soils lacking cohesion, where the unlined cavity at the bottom of the test hole may be unstable, use a piezometer tube with closely spaced perforations in the lower four inches of its length and drive the tube down to the bottom of the test hole.

iii. Alternate Step Two: Power equipment may be used in lieu of the hand auger to drill the test hole and install the piezometer casing provided that the casing fits tightly into the hole or the installation is sealed with bentonite so that leakage does not occur around the outside of the casing and provided that a suitable unlined cavity is provided at the bottom of the bore hole as required in Step Two B above.

3. Step Three: Allow the lower portion of the test hole to fill with ground water and pump the water out one or more times to minimize the effect of soil puddling and to flush the soil pores in the unlined portion of the test hole.

4. Step Four: Allow the water level to rise within the piezometer until the water level becomes relatively stable. Note the approximate rate of rise and record the static water level using the top of the piezometer tube as a reference point.

5. Step Five: Pump most of the water out of the piezometer tube. Record the time and the depth of the water level below the top of the tube. After an appropriate interval of time, record the new depth of the water level. Choose the length of the time interval based upon the rate of rise observed in Step Four so that the difference in water levels at the beginning and end of the time interval will be large enough to permit an accurate measurement, but do not allow the water level to rise to within eight inches of the static level determined in Step Four.

6. Step Six: Repeat Step Five of this subsection, lowering the water level to approximately the same depth and using the same time interval, until consistent results are obtained.

7. Step Seven: Allow the water level in the piezometer tube to rise and, a minimum of 24 hours later, record the depth of the water table for use in the calculation of permeability.

THIS IS A COURTESY COPY OF THIS RULE. ALL OF THE DEPARTMENT'S RULES ARE COMPILED IN TITLE 7 OF THE NEW JERSEY ADMINISTRATIVE CODE.

(c) The permeability of the soil horizon tested shall be determined as follows:

1. Step One: Determine the value of the A-parameter from Figure 10 of Appendix A based upon D, the diameter of the soil auger (or drill bit).

2. Step Two: Calculate the permeability, K, in inches per hour, using the following formula:

$$K = 60 \text{ min/hr} \times (3.14R^2)/At \times \ln(d_1 - D_{\text{stat}}/d_2 - D_{\text{stat}}) \text{ where:}$$

K = the permeability of the soil horizon tested, in inches per hour;

R = the inside radius of the piezometer tube, in inches;

\ln = the natural logarithm;

D_{stat} = the depth of the static water level below the top of the piezometer tube determined in Step Seven, in inches;

d_1 = depth of the water level below the top of the piezometer tube at the beginning of the last time interval, in inches;

d_2 = depth of the water level below the top of the piezometer tube at the end of the last time interval, in inches;

t = length of time interval, in minutes; and

A = value determined in Step One above, in inches.

(d) When the permeability calculated in (c)2 above is less than 0.2 inch per hour, the horizon or substratum in question shall be considered hydraulically restrictive and shall not be considered an acceptable zone of wastewater disposal.

(e) When piezometers are used for conducting this test, they shall be installed and removed in accordance with the Department's procedures pursuant to N.J.S.A. 58:4A-4.1 et seq.

7:9A-6.7 Basin flooding test

(a) The following equipment is required for basin flooding test:

1. Excavating equipment capable of producing a test basin as prescribed in (b) below;
2. A water supply (minimum of 375 gallons per basin filling); and
3. A means for accurately measuring the water level within the basin as required in (c) below.

(b) A test basin meeting the following requirements shall be excavated within or immediately adjacent to the proposed disposal field.

1. The bottom of the test basin shall be at a depth between six and eight feet below the bottom of the proposed level of infiltration.
2. The bottom area of the basin shall be a minimum of 50 square feet.
3. A soil profile pit excavated as prescribed in N.J.A.C. 7:9A-5.2 may be utilized for this test provided that the requirements of (b)1 and 2 above are satisfied.
4. The bottom of the basin should be made as level as possible so that high areas of rock do not project above the water level when the basin is flooded as prescribed in (c) below.
5. If ground water is observed within the test basin, the basin flooding test shall not be used.

(c) The following test procedure shall be used for the basin flooding test:

THIS IS A COURTESY COPY OF THIS RULE. ALL OF THE DEPARTMENT'S RULES ARE COMPILED IN TITLE 7 OF THE NEW JERSEY ADMINISTRATIVE CODE.

1. Step One: Fill the test basin with exactly 12 inches of water and record the time. Allow the basin to drain completely. If the time required for the basin to drain completely is greater than 24 hours, the test shall be terminated and the limiting zone in question shall be considered to be a massive rock substratum.

2. Step Two: If the basin drains completely within 24 hours after the first flooding, immediately refill the basin to a depth of 12 inches and record the time. If the basin drains completely within 24 hours of the second filling, the limiting zone in question shall be considered to be fractured rock substratum. If water remains in the basin after 24 hours the limiting zone in question shall be considered to be a massive rock substratum.

(d) Due to the potential safety hazards which are posed by the excavation of a large test basin such as that required for this test, adequate safety measures shall be taken including the use of stepped and sloped sidewalls as shown in Figure 2 of Appendix A to permit safe access to the test basin during the test procedure as well as the use of warning signs or a fence to limit access to the basin by the public during periods when the basin is left unattended, or both.

(e) The basin flooding test shall not be conducted in rock strata which have been blasted with explosives.

Subchapter 7. General Design and Construction Requirements

7:9A-7.1 Design requirements

(a) A professional engineer who is licensed in the State of New Jersey shall design all individual subsurface sewage disposal systems.

(b) The engineer shall take into consideration slope, surface drainage, soil characteristics, the presence and depth of limiting zones within the soil, soil permeability, type of wastes and the expected volume of sanitary sewage in the design of all individual subsurface sewage disposal systems.

(c) Individual subsurface sewage disposal systems shall not be designed in a manner that will permit a direct discharge of sanitary sewage or septic tank effluent onto the surface of the ground, into a subsurface drain, or into any water course.

(d) The septic system designer shall design the system in a manner that provides ground access on the property for servicing and maintenance of all system components. This shall include clearance for appropriate equipment and/or replacement components to be brought to the existing component locations without the need to remove or alter existing or proposed structures, accessory buildings, swimming pools, retaining structures, patios, decks, trees or other permanent features.

7:9A-7.2 Construction

(a) The system and all its component parts shall be constructed and installed to conform in all details to the requirements set forth in this chapter and to the engineering design which has been approved by the administrative authority. Departures from the approved design which become necessary due to circumstances which arise during construction and installation shall be approved by the design engineer and the administrative authority in accordance with N.J.A.C. 7:9A-3.7 and shall meet or exceed the requirements of this chapter.

(b) Construction and installation shall be performed in such a manner that the capacity of the soil or fill material to adequately absorb or purify the septic tank effluent is not adversely affected.

7:9A-7.3 Type of wastes

(a) The system(s) shall be designed to receive all sanitary sewage from the building served except in the following cases:

1. Separate systems may be designed to receive only greywater, or only blackwater, as allowed in N.J.A.C. 7:9A-7.5.

THIS IS A COURTESY COPY OF THIS RULE. ALL OF THE DEPARTMENT'S RULES ARE COMPILED IN TITLE 7 OF THE NEW JERSEY ADMINISTRATIVE CODE.

2. Laundry wastes may be discharged into a seepage pit when approved by the administrative authority as a means of reducing hydraulic loading on an existing disposal field which has been malfunctioning

(b) Drainage from basement floors, footings or roofs shall not enter the individual subsurface sewage disposal system and shall be diverted away from the area of the disposal field.

(c) Discharge of industrial wastes onto the land, into the soil, or into the ground water is prohibited. The administrative authority shall not approve any system serving any establishment engaged in activities such as photo-processing, dry-cleaning, printing, furniture stripping and refinishing, manufacturing, automobile painting, or any other process or activity which may result in discharge of industrial wastes into the system, without prior approval from the Department. Where doubt exists as to whether or not a waste generated by a particular facility may be considered as an industrial waste, the administrative authority shall instruct the applicant to contact the Department for a determination of whether or not a NJPDES permit will be required.

(d) The administrative authority shall report to the Department any discharge of industrial wastes into an individual subsurface sewage disposal system. Use of sewage system cleaners which contain restricted chemical materials shall be considered to be a discharge of industrial wastes and is prohibited.

(e) Discharges from commercial activities where wastewater is anticipated to contain significant quantities of blood, hide, flesh, bones, paunch materials, viscera, offal and/or non-biodegradable solids of animal origin shall not be discharged to an onsite system unless specifically authorized under a NJPDES permit. Examples of such activities include, but are not limited to, slaughtering, rendering, food processing, processing deceased human bodies for burial or other disposition and surgical procedures.

7:9A-7.4 Volume of sanitary sewage

(a) Each component of the individual subsurface sewage disposal system shall be designed and constructed to adequately treat and dispose of the expected volume of sanitary sewage to be discharged from the premises to be served. The expected volume of sanitary sewage from single residential occupancy activities shall be determined based on the criteria set forth in (b) below. The expected volume of sanitary sewage from establishments which have activities other than single residential occupancy shall be determined based on the criteria set forth in (c) below. The total expected volume is based on a maximum use day and shall be calculated by adding the daily volume of sanitary sewage associated with all activities proposed and planned in accordance with municipal subdivision or site plan approvals.

(b) The criteria for estimating the volume of sanitary sewage from single residential occupancy activities shall be as follows:

1. The daily volume for each bedroom or dwelling unit shall be:

Volume, first bedroom	200 gallons per day ("gal/day")
Volume, each additional bedroom	150 gal/day
Minimum volume per dwelling unit	350 gal/day
Minimum volume per apartment	350 gal/day

2. The administrative authority may approve the reduction of the daily design volume for a one-bedroom age-restricted unit or one-bedroom mobile home dwelling units less than 500 square feet in size to 200 gallons per day.

(c) The volume of sanitary sewage from establishments which have activities other than single residential occupancy shall be based upon the types of activities that are expected to occur that will generate sanitary sewage, the size of the facility and the maximum expected number of persons that may be served during any single day of operation. The total expected volume shall be estimated for each activity generating sanitary sewage by multiplying the number of gallons per unit per day by the maximum anticipated number of units as identified in

THIS IS A COURTESY COPY OF THIS RULE. ALL OF THE DEPARTMENT'S RULES ARE COMPILED IN TITLE 7 OF THE NEW JERSEY ADMINISTRATIVE CODE.

Tables 7.4(a) and 7.4(b) below. Those tables identify the appropriate units to be used based upon each activity. Those tables shall be used as follows:

1. Identify the primary activity for the facility in Table 7.4(a) below, in consideration of those activities defined at N.J.A.C. 7:9A-2.1, and calculate the primary activity volume. If more than one primary activity is proposed, each primary activity shall be calculated separately and then added together to calculate the total primary activity volume;
2. Identify each additional source of sanitary sewage proposed for the facility. If an activity is specifically excluded by a footnote to the primary activity(ies) identified in (c)1 above, those additional sources do not need to be added to the total volume for those primary activity areas. If those additional sources of sanitary wastewater are not specifically excluded, calculate the volume for each additional source of sanitary wastewater and add it to the total volume; and
3. If a primary activity in Table 7.4(a) below, is not identified, the administrative authority may allow for the applicant to use appropriate additional source(s) of sanitary sewage activities for the proposed facility to determine the total design volume calculation. If there is question regarding the design volume calculation, the administrative authority shall direct the applicant to apply for a treatment works approval pursuant to N.J.A.C. 7:9A-3.9 for the Department to determine the appropriate volume.

(d) The criteria listed in Tables 7.4(a) and 7.4(b) below reflect the average amount of sanitary sewage expected to be generated by the listed activities and shall be used to calculate the estimated volume of sanitary sewage. If an administrative authority determines that a proposed type of activity(ies) is not listed in the tables below or is not appropriately represented by the tables below, the administrative authority shall direct the applicant to obtain a treatment works approval for the total expected volume.

(e) When facilities with activities generating sanitary sewage use portable toilets, temporary restrooms or holding tanks on a regular basis, the total design volume from all activities shall be used to determine the total volume for the facility. The total design volume from these facilities shall be calculated as prescribed in (c) above. The use of portable toilets, temporary restrooms or holding tanks for sanitary sewage from activities at any facility shall not be used to reduce the total design volume. The only exception to this requirement is for sanitary sewage volume associated with the use of portable toilets, temporary restrooms or holding tanks during the construction of a realty improvement.

(f) Facilities incorporating commercial food service, golf course, country club, prison, hospital, funeral home, hotel, campgrounds and laboratory related activities shall apply for a treatment works approval to determine total expected volume, if an application proposes flows no greater than 2,000 gallons per day. Hospitals include, but are not limited to, medical or psychiatric institutions with the capacity to accommodate patients overnight.

THIS IS A COURTESY COPY OF THIS RULE. ALL OF THE DEPARTMENT'S RULES ARE COMPILED IN TITLE 7 OF THE NEW JERSEY ADMINISTRATIVE CODE.

Table 7.4(a) Primary Design Criteria

<i>Primary Activity</i>	<i>Daily Volume (gallons)</i>	<i>Units</i>	<i>Footnotes</i>
Commercial Use	15 0.125	Employee or Gross Square Footage (whichever results in greater volume)	1, 2, 3
General Assembly	3	Seat/Person	1, 2, 4
Congregate living	130 50	Sleeping unit Bed (whichever results in greater volume)	1, 5
Warehouse	15 5	Maximum Employees; and Delivery/Field Personnel	1, 2, 6
Vehicle service	125 10	Fueling Position; and Vehicle served in service bays	1, 2, 7
Education/Child care	Go to Table 7.4(b)	Maximum number of students (includes teachers and other employees)	1

Table 7.4(b) Additional Design Criteria

<i>Additional Source of Sanitary Sewage 8</i>	<i>Daily Volume (gallons)</i>	<i>Units</i>	<i>Footnotes</i>
Private Access Restroom	10	Person Served	
Public Access Restroom	5	Person Served	
Showers	5	Person Served	6, 9
Food Service	5 35	Person Served; or Seat (whichever results in greater volume)	1, 7, 10
Laundry	Increase expected daily volume from other activities by 50% or 550	Machine	1, 11
Sink Station	120	Sink	2
Minimum Criteria	350		12

Footnotes:

1. Total expected volume shall be calculated using a maximum service day; therefore, the use of this criterion does not preclude using criteria for every other proposed or existing activity for the facility.

THIS IS A COURTESY COPY OF THIS RULE. ALL OF THE DEPARTMENT'S RULES ARE COMPILED IN TITLE 7 OF THE NEW JERSEY ADMINISTRATIVE CODE.

2. The volume generated by public or private access restroom facilities is not required in addition to the referenced activity criteria. Design criteria from food service are not required for facilities with employee lunch rooms which limit food preparation to employees preparing their own individual meals.
3. Kennels and veterinary offices with kennels shall include an additional 10 gallons per animal that could be kenneled on a maximum service day.
4. Projected flow shall be calculated based upon a design criteria of three gallons per seat (including both fixed and non-fixed seating) during maximum occupancy.
5. Estimated volume shall be calculated based on the number of sleeping units or beds, whichever results in a greater number plus any additional volume sanitary sewage generated from employee restrooms, shower, laundry and food preparation activities if present.
6. Design criteria for warehouse activities is 15 gallons per day per employee per eight hour shift and is based upon the maximum number of employees working an eight hour shift a day. A design criterion of five gallons per day shall be used for part time employees and delivery personnel. For example, a warehouse that operates with three shifts proposes 10 employees on one shift but only five employees for the other two shifts must calculate based upon the maximum use and therefore provide volume for three 10-employee shifts or 450 gallons plus any additional flows for delivery personnel or part time employees that might have access to restrooms plus any additional volumes associated with additional sources of sanitary sewage applicable in Table 7.4(b).
7. A design criterion of 125 gallons per day per gasoline fueling position and 10 gallons per day per motorized vehicle served in service bays on a maximum use day shall be used for motorized vehicle service activity.
8. Additional sources of sanitary sewage shall be included in the cumulative daily volume when applicable.
9. The design criteria for showers shall be used when shower facilities are available this includes employee showers at any factory, warehouse, industrial building or other place of business (other than emergency shower facilities) as well as showers for patrons at swimming pools, clubs or schools.
10. The number of seats must be calculated using the maximum number of indoor and outdoor table and counter seats that may be available on a maximum use day.
11. Public, centralized or commercial laundry activities shall use a design criterion of 550 gallons per day per machine. For any other realty improvement, design criteria for realty improvements that include laundry facilities must increase design volume by 50 percent for each unit containing those facilities.
12. The minimum design volume for any system is 350 gallons per day, other than a single system serving a single dwelling unit identified in N.J.A.C. 7:9A-7.4(b). This criterion shall be used when any calculated criteria from this table results in an estimated volume of sanitary sewage less than 350 gallons per day.

7:9A-7.5 Separate disposal of greywater and blackwater

A greywater system may be approved by the administrative authority provided that all of the requirements of these standards are satisfied and provided that an acceptable means for disposal of the blackwater from the building served is indicated in the system design. When the blackwater from the building served by a greywater system is to be disposed of into a waterless toilet, a variance from the Uniform Construction Code, Plumbing subcode, N.J.A.C. 5:23-3.15, must be obtained by the applicant prior to approval of the greywater system by the administrative authority and the volume of sanitary sewage to be used in the design of the greywater system shall be determined as prescribed in N.J.A.C. 7:9A-7.4. When the black-water from the building served by a greywater system is to be disposed of into a separate subsurface sewage disposal system, the blackwater system shall meet all the requirements of this chapter and the volume of sanitary sewage used in the design of both the greywater system and the blackwater system shall be a minimum of 75 percent of the volume of sanitary sewage determined as prescribed in N.J.A.C. 7:9A-7.4.

7:9A-7.6 Type of system

Administrative authorities shall only approve designs that meet the definition of a system as specified in N.J.A.C. 7:9A-2.1. Seepage pits shall not be approved for new installations except in the case of a greywater system as

THIS IS A COURTESY COPY OF THIS RULE. ALL OF THE DEPARTMENT'S RULES ARE COMPILED IN TITLE 7 OF THE NEW JERSEY ADMINISTRATIVE CODE.

provided in N.J.A.C. 7:9A-7.5. Installation of a seepage pit may be approved as an alteration for an existing noncompliant malfunctioning system subject to the requirements of N.J.A.C. 7:9A-3.3(d).

7:9A-7.7 Building sewer

The building sewer shall be designed and constructed in accordance with the provisions of the State Uniform Construction Code, N.J.A.C. 5:23, adopted pursuant to the Uniform Construction Code Act, N.J.S.A. 52:27D-119 et seq.

Subchapter 8. Pretreatment Units

7:9A-8.1 Grease removal and high strength wastewater pretreatment components

(a) Restaurants, cafeterias, institutional kitchens and other facilities discharging large quantities of grease shall use a grease trap and a high strength wastewater pretreatment component. A garbage grinder shall not be used when grease removal components are required.

(b) The grease trap shall be installed in a separate line serving that part of the plumbing system into which the grease will be discharged. The grease trap shall be located close to the source of the wastewater, where the wastewater is still hot, to facilitate separation. Grease traps shall be located, designed and constructed in a manner that will permit easy access and cleaning.

(c) The following equation shall be used to determine the minimum size required for grease traps serving restaurants:

$Q = (D) \times (HR/2) \times (12.5) \times (LF)$, where

Q = size of grease trap in gallons;

D = number of seats in dining area;

HR = number of hours open per day; and

LF = loading factor depending on restaurant location:

1.25 for interstate freeways;

1.0 for other freeways;

1.0 for recreation areas;

0.8 for main highways;

0.5 for other highways.

(d) The following equation shall be used to determine the minimum size required for grease traps serving cafeterias and institutional kitchens:

$Q = (M) \times (11.25) \times (LF)$, where:

Q = size of grease trap, gallons;

M = total number of meals served per day; and

LF = loading factor depending on type of facilities present:

1.0 with dishwashing;

0.5 without dishwashing.

(e) In no case shall a grease trap serving a restaurant, cafeteria or institutional kitchen be smaller than 750 gallons in capacity.

THIS IS A COURTESY COPY OF THIS RULE. ALL OF THE DEPARTMENT'S RULES ARE COMPILED IN TITLE 7 OF THE NEW JERSEY ADMINISTRATIVE CODE.

- (f) The minimum requirements for construction, materials and foundations of grease traps shall be the same as those required for septic tanks, as prescribed in N.J.A.C. 7:9A-8.2.
- (g) The inlet and outlet of the grease trap shall be provided with "T" baffles extending to a depth of 12 inches above the tank floor and well above the liquid level.
- (h) To facilitate maintenance, manholes extending to finished grade shall be provided. Covers shall be of gas-tight construction and shall be designed to withstand expected loads and prevent access by children.
- (i) High strength wastewater pretreatment components shall be approved by the administrative authority only if the components are designed, constructed and certified by a septic system designer to actively treat and therefore reduce fats, oils and grease, total suspended solids, biochemical oxygen demand and chemical oxygen demand. The components shall be designed to meet the following effluent criteria:

<u>Constituent</u>	<u>Concentration (mg/L)</u>
Total suspended solids (TSS)	155
Five-day biochemical oxygen demand (BOD ₅)	155
Fats, oils and grease (FOG)	70
Chemical oxygen demand (COD)	500

- (j) The septic system designer certification of the high strength wastewater pretreatment components must specify how the grease removal components are to be installed and maintained to achieve the identified effluent design criteria.
- (k) Grease removal components must be equipped with audio and visual alarms to identify when the storage capacity of the system has reached 75 percent. When the storage capacity reaches 75 percent, the operator of the system shall take immediate steps to maintain effluent criteria by ensuring that grease is removed from the system. Disposal of grease must be in compliance with all local, State and Federal requirements.
- (l) Any grease removal components that are not operated and maintained in conformance with the original administrative authority approval or manufacturer's specifications shall be considered non-compliant with N.J.A.C. 7:9A-3.4.

7:9A-8.2 Septic tanks

- (a) The use of a septic tank shall be required for all systems except as provided at N.J.A.C. 7:9A-8.3.
- (b) The minimum capacity of the septic tank shall be determined in accordance with the following criteria:
 1. When serving single family dwelling units, septic tanks shall have the minimum capacity of 250 gallons per bedroom. Expansion attics shall be considered additional bedrooms. In no case shall the capacity be less than 1000 gallons.
 2. When serving installations other than single family dwelling units, the minimum capacity shall be 1.5 times (150 percent) the volume of sanitary sewage, Q, when Q, determined as prescribed in N.J.A.C. 7:9A-7.4, is less than 1,500 gallons per day. When Q is greater than 1,500 gallons per day, the minimum capacity in gallons shall be 1,125 plus 0.75Q. In no case shall the capacity be less than 1000 gallons.
 3. Two or more septic tanks may be connected in series in order to obtain the minimum required liquid capacity providing that each tank is at least as large as the succeeding tank. When a multiple compartment tank is used, the requirements of (d)3 below shall be satisfied.

THIS IS A COURTESY COPY OF THIS RULE. ALL OF THE DEPARTMENT'S RULES ARE COMPILED IN TITLE 7 OF THE NEW JERSEY ADMINISTRATIVE CODE.

(c) When domestic garbage grinder units or sanitary sewage ejector pumps are installed or proposed, a multiple compartment septic tank is required and the liquid capacity of the septic tank(s), exclusive of air space, shall be at least 50 percent greater than the minimum capacity required in (b)1 above.

(d) Multiple compartment septic tanks shall be required for institutional and commercial installations where the daily volume of sewage determined as prescribed in N.J.A.C. 7:9A-7.4 is greater than 1,000 gallons or when sewage is conveyed from the building served to the septic tank by means of a sewage ejector pump. When multiple compartment tanks are used the following shall be required:

1. The total capacity of multiple compartment tanks shall not be less than 1000 gallons. The first compartment shall have a liquid capacity of two-thirds the total required liquid capacity determined as prescribed in (b) above.
2. Not more than two compartments shall be provided in tanks having liquid capacities of less than 1250 gallons. Tanks having liquid capacities of over 1250 gallons may be provided with more than two compartments.
3. Multiple compartments may be provided by partitions within a single tank as shown in Figure 11 of Appendix A, or by connecting individual tanks in series. When a single partitioned tank is used, vent holes shall be provided near the top of each partition to allow free exchange of evolved gases between compartments and the two compartments shall be connected by means of a pipe tee, baffle or septic solids retainer, as shown in Figure 11.

(e) Septic tanks shall be designed and constructed according to the following requirements:

1. Septic tanks shall be water-tight and constructed of sound and durable materials which are resistant to corrosion, decay, frost damage or to cracking or buckling due to settlement or backfilling. All joints below the liquid level of the tank or below the seasonally high water table shall be provided with a permanent water-tight seal.
2. Covers shall be designed and constructed so as not to be damaged by any load which is likely to be placed on them. Precast slabs used as covers shall be water-tight, a minimum of three inches in thickness and adequately reinforced.
3. The walls and base of poured-in-place concrete tanks shall not be less than six inches in thickness. The sides and bottom of precast concrete tanks shall be a minimum of three inches in thickness and shall be adequately reinforced.
4. Concrete used in the construction of septic tanks shall conform to the American Concrete Institute (ACI) standards for frost resistance (ACI 318-16-4.5.1) and water-tightness (ACI 318-16-4.5.2). In the case of built-in-place tanks, certification that these standards have been met shall be provided by the design engineer and the certification shall be signed, sealed and attached to the approved engineering design. In the case of precast tanks, certification shall be provided by the manufacturer and the certification displayed on the tank.
5. All inside concrete surfaces shall be sealed with two coatings of an appropriate inert coating to minimize corrosion. Coating of pre-cast tanks shall be applied by the manufacturer prior to delivery to the job site.
6. The base of poured-in-place tanks shall be cast in one piece and shall extend beyond the side and end walls of the tank. Such tanks shall not be emplaced until 48 hours after the base has been poured.
7. Pre-fabricated polyethylene septic tanks shall conform with the standards for materials, wall thickness, fastening of fittings and maximum deformation under load as prescribed by the Canadian Standards Association in CSA Standard CAN3-B66-M79.
8. Pre-fabricated fiberglass septic tanks shall conform to ASTM Standard D4021.

(f) A pre-fabricated septic tank constructed of any material which may be floated or shifted by water or ground cave-in shall be filled with water immediately after it is set in its proper position. When a septic tank is installed

THIS IS A COURTESY COPY OF THIS RULE. ALL OF THE DEPARTMENT'S RULES ARE COMPILED IN TITLE 7 OF THE NEW JERSEY ADMINISTRATIVE CODE.

below or partially below the level of the seasonally high water table, the design engineer shall show by means of appropriate calculations that the tank is of sufficient weight or will be otherwise secured or anchored so that it will not shift or float if emptied during the time of seasonally high groundwater. Perforating or otherwise damaging the water-tight integrity of a septic tank for the purpose of installation below the water table is prohibited.

(g) Septic tanks shall be placed upon a firm and stable foundation so that the potential for uneven settlement or shifting is minimized. Tanks shall be constructed or installed directly on undisturbed natural soil. If the excavation is dug too deep, it shall be backfilled to the proper elevation with sand. When the tank must be constructed or installed on a layer of fill material greater than one foot in thickness, the fill shall be properly emplaced and compacted as prescribed in N.J.A.C. 7:9A-10.4(f)3.

(h) Metal septic tanks are prohibited. Septic tanks may be constructed of the following materials:

1. Poured-in-place concrete;
2. Precast reinforced concrete;
3. Fiberglass;
4. Polyethylene; or
5. Other materials as approved by the Department.

(i) Septic tanks shall conform to the following specifications:

1. The depth below the liquid level of the tank shall not be less than 36 inches or more than 72 inches.
2. Inlets and outlets shall be arranged so that all flow is directed along the longest horizontal dimension of the tank.
3. Tanks which are rectangular in cross-section shall have an inside length at least twice the inside width. The inside length, measured from the inlet side to the outlet side, shall not be less than 72 inches. The inside width of the tank shall not be less than 36 inches.
4. All cylindrical tanks shall have a minimum inside length of 72 inches measured between the inlet side to the outlet side and a minimum width at the liquid level of 36 inches.

(j) Inlets and outlets of septic tanks shall conform to the following specifications:

1. Inlet and outlet connections of each tank or compartment shall be arranged so as to obtain effective retention of scum and sludge and shall be fastened with and constructed of, or coated with, materials which are resistant to corrosion by sulfuric acid. Where pipe tees are used, the tees shall be sanitary tees and shall be installed in a manner that will provide a lasting water-tight seal between the tee and the wall of the tank. For this purpose, a manufactured water-proof pipe coupling which is incorporated into the wall of the tank may be used, or an expanding grout which will adhere both to the tee and to the body of the tank where the tee is installed.
2. A baffle or a pipe tee, not less than four inches in diameter, is required at the inlet of the tank. The bottom of the baffle or the bottom of the vertical leg of the tee shall extend below the liquid level a distance equal to 25 to 33 percent of the liquid depth. The invert elevation of the inlet shall not be less than two inches higher than the invert elevation of the tank outlet or the outlet of the first compartment. The inverts of the inlets of subsequent compartments shall be a minimum of one inch higher than their outlets.
3. A septic solids retainer or septic effluent filter shall be installed and maintained in conjunction with all new septic tanks prior to the effluent distribution network and in accordance with all manufacturer's specifications. Septic solids retainers and septic effluent filters shall be certified by, and bear the mark of, NSF International (NSF) under NSF Standard 46. The Department recommends that filters be a minimum of six inches in diameter (or equivalent area) measured at the inlet to the filter. Additionally, the Department recommends that system designers provide a means in the design to prevent flow of solids, scum and floatables out of the tank when the filter is removed for maintenance. Outlet connections of an existing tank or each compartment

THIS IS A COURTESY COPY OF THIS RULE. ALL OF THE DEPARTMENT'S RULES ARE COMPILED IN TITLE 7 OF THE NEW JERSEY ADMINISTRATIVE CODE.

thereof and connections between new tank compartments or tanks installed in series shall be provided with a tee not less than four inches in diameter or a durable baffle equivalent in size. They shall be permanently fastened in place with the bottom opening extending below the liquid level by a distance equal to 25 to 40 percent of the total liquid depth. Outlet baffles or tees shall be provided with a gas deflection device adequately designed to prevent gases generated in the septic tank from rising through the outlet baffle or tee. The gas deflection device shall be constructed of, or coated with, materials which are resistant to corrosion by sulfuric acid and shall be securely fastened to the tee or the side of the tank. Figure 12 of Appendix A illustrates several acceptable gas deflection devices. In lieu of a baffle or tee connection, a septic solids retainer or septic effluent filter installed and maintained in accordance with this chapter may be used. Where a septic solids retainer or septic effluent filter is used, a gas deflection baffle is not required.

(k) The space between the liquid surface and the top of the outlet tee or baffle shall not be less than 15 percent of the total liquid depth.

(l) Access openings for septic tanks shall meet the following requirements:

1. Each septic tank or each compartment of a multiple compartment tank shall be provided with at least one access opening which shall be a manhole a minimum of 24 inches square or 24 inches in diameter.
2. All manholes shall be extended to and maintained at finished grade by means of a riser fitted with a removable watertight cover. Covers shall be bolted or locked to prevent access by children and shall be of cast iron when a concrete riser is used. Manhole covers shall be designed using materials that will ensure a water tight seal between the cover and the riser at all times as specified by a septic system designer and approved by the administrative authority. A permanent, non-corrosive marker a minimum of six square inches in size containing the following information shall be attached to the manhole cover or riser immediately below the cover:
 - i. The administrative authority name and permit number under which the system was installed;
 - ii. The date of installation;
 - iii. The type of system; and
 - iv. The total design criteria in gallons per day.
3. An inspection port extending to finished grade shall be provided over each tank or compartment inlet and outlet which is not directly below a manhole except for those outlets where a septic solids retainer or effluent filter is used. Inspection ports shall extend to finished grade, shall be constructed of four-inch cast iron or Polyvinyl Chloride (PVC), and shall have a locked or bolted cap. Outlets where a septic solids retainer or effluent filter is located shall be directly below a manhole or have an inspection port that allows for at grade access to that device to allow for unimpeded maintenance without entering the septic tank.
4. Manhole risers and inspection ports on fiberglass or polyethylene tanks shall be constructed of the same material as the tank.

(m) All tanks, including risers and inspection ports to the highest joint, shall be tested for watertightness after installation using hydrostatic or vacuum tests in accordance with the following:

1. Watertightness testing procedures and criteria for concrete tanks shall follow the methods described in American Standard Testing Method (ASTM) C-1227 standards incorporated by reference, as amended, or the National Pre-cast Concrete Association (NPCA) testing criteria and procedures specified in its Precast Concrete On-site Wastewater Tank Best Practices Manual incorporated by reference, as amended. The ASTM methods can be obtained at: <http://www.astm.org/Standard/index.shtml> and the NPCA methods may be obtained at: <http://www.precast.org/technical-services-overview>.
2. Tanks made of materials other than concrete shall be tested, after installation, in accordance with the methods described in ASTM C-1227 standards, if applicable, or other hydrostatic or vacuum testing methods approved by the tank manufacturer.

THIS IS A COURTESY COPY OF THIS RULE. ALL OF THE DEPARTMENT'S RULES ARE COMPILED IN TITLE 7 OF THE NEW JERSEY ADMINISTRATIVE CODE.

3. Water used for this testing shall be either from a potable water source or reclaimed water for beneficial reuse authorized by a NJPDES permit.
 4. The use of an onsite potable well for purposes of supplying water for this testing is not recommended.
 5. If an onsite potable well is to be used, withdrawal of water from the well shall be at a rate of less than 50 percent of the design yield of the well and in a manner that will avoid damage to the pump or any other part of the well.
- (n) Backfill around septic tanks shall be free of large stones, roots or foreign objects, shall be placed in thin layers, not to exceed eight inches, and shall be thoroughly tamped in a manner that will not produce undue strain on the tank. In the case of pre-fabricated plastic or fiberglass tanks, backfill shall be no thicker than the maximum depth recommended by the manufacturer.

7:9A-8.3 Advanced wastewater pretreatment components

(a) The use of an advanced wastewater pretreatment device in addition to a septic tank, or in lieu of a septic tank provided a primary settling component is incorporated into the design, may be allowed or required, at the discretion of an administrative authority, for new construction, projects where there is an increase in the expected volume of sanitary sewage pursuant to N.J.A.C. 7:9A-7.4, or to alter an existing, malfunctioning system. For individual systems with expected volumes of sanitary sewage less than or equal to 1,500 gallons per day, advanced wastewater pretreatment devices shall have obtained an NSF Standard 40 and/or Standard 245 certification, bear the mark of NSF and must be used in accordance with all conditions of that certification in addition to the requirements in this chapter. For systems with expected volumes of sanitary sewage greater than 1,500 gpd or systems that receive waste flows that are not residential in nature, advanced wastewater pretreatment devices shall be from a manufacturer that has obtained an NSF Standard 40 and/or Standard 245 certification for the treatment technology, be certified by the manufacturer that the technology is designed to achieve secondary effluent standards for the actual or proposed waste strength that will be generated at the site and must be used in accordance with all requirements in this chapter. The Department shall maintain a list of advanced wastewater pretreatment devices that are applicable under this section that comply with the following:

1. Any advanced wastewater pretreatment device manufacturer that wishes to have their device listed by the Department shall submit a written request and a copy of an NSF Final Report. The written request shall include an acknowledgement by the manufacturer to comply with all applicable requirements of this chapter.
2. Listed manufacturers shall make available up-to-date training, design, installation and service manuals and materials to any administrative authority or the Department upon request.
3. All advanced wastewater pretreatment devices shall be used in accordance with the provisions of this chapter and all documentation in the NSF Final Report provided to the Department.

(b) Prior to submitting any design that includes an advanced wastewater pretreatment device to the administrative authority, a system designer shall:

1. Certify in the application that they are sufficiently knowledgeable of the technology(ies) to design the system;
2. Design systems that include advanced wastewater pretreatment devices in a manner which meets all manufacturer's minimum specifications and/or recommendations;
3. Design all advanced wastewater pretreatment devices so that the raw wastewater cannot be discharged without first being properly treated by the treatment unit as it was designed. The design shall provide that the liquid levels in the tanks or other treatment vessels shall be monitored by a properly functioning high level alarm and any other monitoring equipment or alarm as recommended by the manufacturer;
4. Utilize the manufacturer's recommendations for sizing of the advanced wastewater pretreatment whenever a discrepancy occurs between the estimated volume of sanitary sewage calculated in accordance

THIS IS A COURTESY COPY OF THIS RULE. ALL OF THE DEPARTMENT'S RULES ARE COMPILED IN TITLE 7 OF THE NEW JERSEY ADMINISTRATIVE CODE.

with N.J.A.C. 7:9A-7.4 and the manufacturer's recommended sizing of the advanced wastewater pretreatment device. Sizing of all other components of the system shall conform to this chapter.

5. For non-residential systems, obtain a letter from the manufacturer, or the manufacturer's representative, and provide it to the administrative authority, verifying the design's consistency with all manufacturer's minimum specifications and recommendations. The administrative authority may require the septic system designer to obtain a letter from the manufacturer, or the manufacturer's representative, for residential systems and provide it to the administrative authority, verifying the design's consistency with all manufacturer's minimum specifications and recommendations;
 6. Include in the design of the system a control panel that tracks, at a minimum, pump elapsed time, cycle counts and high level alarm counts or other means to determine flow through the system and any other system information for troubleshooting purposes as recommended by the manufacturer.
 - i. Systems may be equipped with a telemetry control panel, attached to an Internet-based interface that provides continuous remote monitoring, information management and control of the advanced wastewater pretreatment device; or
 - ii. Systems that do not have a telemetry control panel shall use an active phone line equipped with an auto dialer to notify the authorized service provider of alarm conditions, including if power to any of the system equipment is disconnected;
 7. Design the system so that all processing tanks, discharge tanks and related treatment unit(s) shall maintain the same minimum separation distances as required for septic tanks at N.J.A.C. 7:9A-4.3;
 8. Include in the system design only advanced wastewater pretreatment devices that are watertight. All advanced wastewater pretreatment devices must be designed in a manner that considers all structural issues including, but not limited to, venting of the disposal area, load bearing, buoyancy and all other structural effects on the treatment unit for the intended installation;
 9. Include in the design a septic tank prior to any advanced wastewater pretreatment devices unless otherwise specifically identified in the NSF Standard 40 or 245 certification and the manufacturer's recommendations or specifications. Effluent filters required at N.J.A.C. 7:9A-8.2 may be relocated to another point downstream of the septic tank or may be eliminated provided that this design consideration is specifically identified in the manufacturer's recommendations or specifications;
 10. Include within any system that incorporates an advanced wastewater pretreatment device a method of sampling wastewater after the advanced wastewater pretreatment device to monitor effluent quality after final treatment has been achieved. This method of sampling must be achievable at final grade without excavation; and
 11. Note in the design all installation requirements in (c) below, and all maintenance and monitoring requirements required by N.J.A.C. 7:9A-12.3.
- (c) The following requirements are applicable to the installation of an advanced wastewater pretreatment device;
1. An authorized installer shall be physically present at all times during installation of an advanced wastewater pretreatment device and either install or directly oversee the installation of the advanced wastewater pretreatment device.
 2. The authorized installer shall ensure that the property owner has been provided with a copy of the service contract and agrees to comply with the requirements therein by obtaining their written acknowledgement via signature prior to the installation of any system that incorporates an advanced wastewater pretreatment device.
 3. All advanced wastewater pretreatment devices shall be installed in accordance with directions provided in the advanced wastewater pretreatment device manufacturer's installation manual and the approved system design.

THIS IS A COURTESY COPY OF THIS RULE. ALL OF THE DEPARTMENT'S RULES ARE COMPILED IN TITLE 7 OF THE NEW JERSEY ADMINISTRATIVE CODE.

4. The authorized installer shall be in possession of all necessary permits, approvals and licenses before attempting any portion of an installation. All documentation must be located at the installation site for the duration of the installation and made available upon request by the administrative authority or the Department.
5. The watertightness of any tanks specified in the design must be watertight tested at the installation site after the tank has been installed, in accordance with the same requirements identified for septic tanks at N.J.A.C. 7:9A-8.2(m).

(d) The following requirements are applicable for system start-up of any system containing an advanced wastewater pretreatment device:

1. The authorized service provider shall inspect the system following installation.
 - i. The authorized service provider shall complete a manufacturer's system start-up checklist; and
 - ii. The authorized service provider shall provide the completed start-up checklist to the administrative authority.
2. The authorized installer that installed the advanced wastewater pretreatment device shall be present at the time of start-up.

(e) The following requirements are applicable to the administrative authority that approved the installation of an advanced wastewater pretreatment device:

1. The administrative authority shall not approve any system incorporating an advanced wastewater pretreatment device unless all design, installation or maintenance documentation for any part of the proposed system has been received from the septic system designer.
2. All sites where an advanced wastewater pretreatment device has been installed shall be tracked to manage contact information, maintenance activities, and generate reports. The reports shall be submitted to the Department with the annual reports required at N.J.A.C. 7:9A-3.15 and shall provide the following information, at a minimum:
 - i. The type of advanced wastewater pretreatment devices installed;
 - ii. The location of each installed advanced wastewater pretreatment device;
 - iii. The type of use (for example residential or commercial);
 - iv. The type of disposal area (for example bed, trench, or drip dispersal);
 - v. The date when the advanced wastewater pretreatment device was installed and started up; and
 - vi. The date of each inspection/maintenance calls conducted.
3. The administrative authority shall not issue a certificate of compliance for any system incorporating an advanced wastewater pretreatment device unless a copy of a fully executed service contract has been received and the reporting information required in (e)2 above is recorded.

Subchapter 9. Effluent Distribution Networks

7:9A-9.1 General requirements for effluent distribution

(a) Discharge of effluent from the septic tank or grease trap to the disposal field and distribution of effluent within the disposal field shall be accomplished by one of the following methods:

1. The gravity flow method whereby the pretreatment unit discharges directly to a single distribution lateral, an inter-connected network of distribution laterals or to a distribution box discharging to two or more individual distribution laterals;

THIS IS A COURTESY COPY OF THIS RULE. ALL OF THE DEPARTMENT'S RULES ARE COMPILED IN TITLE 7 OF THE NEW JERSEY ADMINISTRATIVE CODE.

2. The gravity dosing method whereby the pretreatment unit discharges to a dosing tank with a pump or siphon which in turn discharges to a single distribution lateral, an inter-connected network of distribution laterals or to a distribution box discharging to two or more individual distribution laterals; or
3. The pressure dosing method whereby the pretreatment unit discharges to a dosing tank with a pump or siphon which in turn discharges to an inter-connected network of distribution laterals designed to discharge effluent under pressure.

(b) Each lateral in the distribution network shall receive an equal hydraulic loading. The use of serial distribution is prohibited.

(c) The use of gravity flow is restricted to those cases where less than 600 linear feet of distribution laterals are used and where the relative locations and elevations of the system components will allow gravity flow from the building sewer to the pretreatment unit and on through the distribution network.

(d) Alternating siphons or pumps may be used to alternately dose and rest two or more disposal fields provided that no field or portion of a field receives more than the maximum daily hydraulic loading rate allowed in N.J.A.C. 7:9A-10.2. Soils with a permeability faster than six inches per hour or a percolation rate faster than 15 minutes per inch shall not be rested for periods longer than one day unless pressure distribution is used and shall not receive more than 25 percent of the maximum allowed daily hydraulic loading in a single dose.

7:9A-9.2 Dosing tanks

(a) A dosing tank using a siphon or pump is required for systems using gravity or pressure dosing and shall meet the requirements of (b) through (f) below.

(b) The minimum capacity of dosing tanks using pumps shall be determined as follows:

1. Dosing tanks using pumps shall have sufficient capacity to distribute septic tank effluent equally to all parts of the disposal field during each dosing cycle and to provide adequate reserve storage capacity in the event of a pump malfunction. The total liquid capacity shall be great enough to accommodate the minimum required dose volume (V_d) determined as prescribed in (b)2 below, plus the minimum required reserve storage capacity determined as prescribed in (b)3 below. Additional volume must be provided above the pumping level to accommodate the volume of water displaced by the pump and controls (V_{pd}) as well as any quantity of effluent which will drain back into the dosing tank when the pump shuts off at the end of a dosing cycle (V_{cp}). Additional volume must be provided below the pumping level so that the pump may be placed on a pedestal, above the dosing tank bottom, to prevent the pump from drawing in air or whatever solids may accumulate in the bottom of the dosing tank.

2. The dose volume (V_d) shall be determined based upon the soil permeability or percolation rate, daily volume of sewage (Q) and the total internal volume of the distribution network (V), as shown below. In the case of pressure dosing systems, the volume of the distribution network, V , shall include the volume of the delivery pipe (V_p), the manifold (V_m) and the laterals (V_l).

Soil Permeability (in/hr)	Percolation Rate (min/in)	Required Dose Volume Gravity Dosing	Required Dose Volume Pressure Dosed
6-20	3-15	minimum of 75 percent V , ¹ maximum of 25 percent Q	minimum of $10V^2$ maximum of 25 percent Q
0.2-6	15-60	minimum of 75 percent V maximum of 100 percent Q	minimum of $10V$ maximum of 100 percent Q

THIS IS A COURTESY COPY OF THIS RULE. ALL OF THE DEPARTMENT'S RULES ARE COMPILED IN TITLE 7 OF THE NEW JERSEY ADMINISTRATIVE CODE.

- (1) In cases where 75 percent V is larger than 25 percent Q, the 25 percent Q maximum rather than the percent minimum shall be observed.
- (2) In cases where 10V is larger than 25 percent Q, the 25 percent Q maximum rather than the 10V minimum shall be observed.

3. Reserve capacity is the inside volume of the dosing tank which lies between the level at which the high-water alarm switch is set and the invert elevation of the tank inlet, as shown in Figure 13 of Appendix A. A minimum reserve capacity equal to the daily volume of sewage shall be required except where a stand-by pump is provided which is equivalent in performance capacity to the primary pump and which will switch on automatically in the event that the primary pump malfunctions.

(c) The capacity of dosing tanks using siphons shall be adequate to provide the required dose volume determined as prescribed in (b)2 above. No reserve capacity is required when a siphon is used.

(d) All dosing tanks shall meet the following requirements regardless of whether a pump or siphon is used.

1. The requirements for the construction of dosing tanks shall be the same as those prescribed for septic tanks in N.J.A.C. 7:9A-8.2(e). Dosing tanks may be constructed as a separate unit or may share a common wall with the pretreatment unit.
2. Materials used for the construction of dosing tanks shall be the same as those allowed for septic tanks as prescribed in N.J.A.C. 7:9A-8.2(h).
3. Dosing tanks shall be constructed in a manner that will permit venting of the disposal area.
4. Installation requirements for pre-fabricated dosing tanks shall be the same as those for septic tanks, as prescribed in N.J.A.C. 7:9A-8.2(f).
5. Dosing tanks shall be placed on a firm and stable foundation so that the potential for differential settling or shifting is minimized.
6. Inlets shall be above the highest water level attained when the entire reserve capacity is full. Outlets for dosing tanks using siphons shall conform with the manufacturer's recommendations.
7. Dosing tanks shall be readily accessible for service and repair. A removable watertight cover or a manhole with a removable watertight cover shall be provided. Manholes shall be a minimum of 24 inches in diameter or 24 inches square and shall be located directly over the pump or siphon. The top of the tank or manhole riser, at a minimum, shall be extended to within six inches of finished grade and be equipped with a watertight cover. Where manholes are extended flush with finished grade, the cover shall be bolted or locked to prevent access by children and shall be of cast iron when a concrete riser is used. When the top of the tank or manhole is not extended to finished grade, covers shall be constructed of precast reinforced concrete, fiberglass, polyethylene or other materials as specified by a licensed professional engineer and approved by the administrative authority. The location of the manhole shall be marked on the ground surface by means of a permanent, non-corrosive marker a minimum of three inches in diameter.
8. Requirements for backfilling around dosing tanks shall be the same as for septic tanks, as prescribed in N.J.A.C. 7:9A-8.2(n).

(e) Dosing may be accomplished by means of an automatic siphon when the low water level in the dosing tank is at a higher elevation than the invert of the highest distribution lateral. When a siphon is used the following requirements shall be met:

1. Siphons shall be constructed of durable materials not subject to corrosion by acid or alkali.
2. Extreme care shall be utilized in the installation of siphons. The installation shall conform exactly and in all details to the manufacturer's recommendations and specifications.

THIS IS A COURTESY COPY OF THIS RULE. ALL OF THE DEPARTMENT'S RULES ARE COMPILED IN TITLE 7 OF THE NEW JERSEY ADMINISTRATIVE CODE.

3. The horizontal dimensions of the dosing tank shall be adjusted so that the volume obtained by multiplying the manufacturer's rated siphon drawing depth by the internal horizontal area of the tank will be equal to the required dose volume determined as prescribed in (b)2 above.
4. When installation is complete, the siphon shall be primed by filling it with water at which time the siphon shall be checked for leaks as evidenced by air bubbles rising from the bell casing or piping. Any leaks shall be repaired before final approval is given.
5. In gravity dosing systems, when the delivery pipe between the dosing tank and the distribution box or distribution network is long, the siphon invert shall be set at an elevation sufficiently higher than the invert of the highest distribution lateral to compensate for any head losses due to friction in the connecting pipe. Friction head shall be determined using Figure 16 of Appendix A.
6. In pressure dosing systems, the invert of the siphon shall be set higher than the invert of the distribution laterals by a distance equal to the total operating head determined as prescribed in N.J.A.C. 7:9A-9.7(a)ii.
7. For facilities from which large quantities of septic tank effluent may be discharged at one time, the design engineer shall make certain that the siphon discharge rate will not be exceeded by the maximum expected rate of inflow at time of peak flow.
8. Each dosing tank shall be equipped with a cycle counter activated by a weighted float or mercury switch to facilitate monitoring of siphon performance.
9. Dosing tanks using siphons shall be equipped with an overflow to the distribution box or distribution network and a high-water alarm meeting the requirements of (f)7iii below. The invert of the overflow shall be just above the level of the high-water alarm switch which shall be several inches above the normal high-water level of the dosing tank.

(f) Dosing may be accomplished by means of a pump when either gravity dosing or pressure dosing is used. Duplicate pumps may be required by the administrative authority. The following requirements shall be met:

1. The pump must be rated by the manufacturer to handle septic tank effluent and all equipment must be listed and identified for the intended use as determined by the design.
2. Pumps used for gravity dosing systems must be rated by the manufacturer, as indicated by the manufacturer's pump performance curve, to be capable of delivering the total required dose volume within a period of 15 minutes or less when working against a total dynamic head equal to the total design operating head. For the purpose of making this determination, the total design operating head shall be considered as the sum of the elevation head and the friction head calculated as prescribed in N.J.A.C. 7:9A-9.7(a)7.
3. Selection of an adequate pump for pressure dosing is part of the design procedure for pressure dosing systems and shall be performed in conformance with N.J.A.C. 7:9A-9.7(a).
4. Pumps shall be set on a pedestal so that the intake is elevated several inches above the bottom of the dosing tank.
5. Easy or "quick-disconnect" couplings shall be used to facilitate removal of the pump for servicing.
6. For facilities from which large quantities of septic tank effluent may be discharged at one time, the design engineer shall make certain that the pump discharge rate will not be exceeded by the maximum expected rate of inflow at times of peak flow.
7. The operation of the pump shall be controlled by means of automatic switches which are activated by the rising and falling level of effluent in the dosing tank. Such switches shall meet the following requirements:
 - i. Switches shall be able to withstand the humid and corrosive atmosphere in the dosing tank. Mercury or weighted float type switches are suitable for this purpose. Pressure-diaphragm type switches are prohibited.

THIS IS A COURTESY COPY OF THIS RULE. ALL OF THE DEPARTMENT'S RULES ARE COMPILED IN TITLE 7 OF THE NEW JERSEY ADMINISTRATIVE CODE.

ii. The pump-on and pump-off switches shall be set at appropriate levels to provide a dose volume as required in N.J.A.C. 7:9A-9.2(b)2. The pump-off switch shall be set six inches above the pump intake. The pump-on switch shall be set at a distance, d , above the pump-off switch, which is calculated by means of the following formula:

$$d, \text{ in} = (V_d + V_{cp} + V_{pd}) \times (1 \text{ ft}^3/7.48 \text{ gal}) \times (12 \text{ in}/1 \text{ ft})/(A), \text{ where:}$$

V_d is the required dose volume, in gallons, determined as prescribed in N.J.A.C. 7:9A-9.2(a)2;

V_{cp} is the internal volume of all pipes which will drain back into the dosing tank at the end of a dosing cycle, in gallons;

V_{pd} is the displacement, in gallons, of pump and controls; and

A is the internal horizontal area of the dosing tank, in square feet.

iii. A high-water alarm switch shall be set four inches above the pump-on switch and shall activate visible and audible alarms which can be readily seen and heard by occupants within the building served. The high-water alarm switch shall meet the same requirements prescribed for pump-control switches in (f)7i above. The alarm and its switch shall not be on the same electrical circuit as the pump and its switches.

iv. All electrical splices, junction boxes, contacts and relays shall be located outside of the dosing tank and a gas-tight seal shall be provided where electrical conduits enter the tank.

v. All electrical service lines to or from the pump control panel shall be installed in electrical conduit.

7:9A-9.3 Connecting and delivery pipes

(a) Connecting pipes between pretreatment units and dosing tanks, distribution boxes or distribution networks, and delivery pipes discharging effluent from dosing tanks shall be of such size as to serve the connected fixtures but in no case less than one and one half inches in diameter. Delivery pipes from dosing tanks using siphons shall be one nominal size larger than the siphon to facilitate venting.

(b) Delivery pipes for pressure dosing networks shall be constructed of Polyvinyl Chloride (PVC) plastic (ASTM D-2665), schedule 40, SDR-21 or SDR-26; or Acrylonitrile-Butadiene-Styrene (ABS) plastic (ASTM D-2661). Connecting pipes may be constructed of any of the following materials:

1. Plastic meeting the following criteria:

- i. PVC (ASTM D 2665)--schedule 40, SDR-21 or SDR-26; or
- ii. ABS (ASTM D-2661).

2. Cast-iron; or

3. Other material acceptable to the administrative authority.

(c) All pipe joints in connecting pipes and delivery pipes shall be made water-tight and protected against damage by roots.

(d) Connecting pipes and delivery pipes shall be laid on a firm foundation satisfactory to the administrative authority.

(e) The alignment and grade of connecting pipes shall meet the following requirements:

- i. Connecting pipes shall have a minimum grade of one-quarter inch per foot unless otherwise authorized by the administrative authority.

THIS IS A COURTESY COPY OF THIS RULE. ALL OF THE DEPARTMENT'S RULES ARE COMPILED IN TITLE 7 OF THE NEW JERSEY ADMINISTRATIVE CODE.

ii. Connecting pipes shall be laid in a continuous grade and, as nearly as possible, in a straight line. Drop manholes may be installed if found necessary. Horizontal bends, where required, shall not be sharper than 45 degrees. The inside angle between adjacent sections of pipe shall be no less than 135 degrees.

(f) In cases where the delivery pipe from the dosing tank will be installed higher than the maximum expected depth of frost penetration, measures shall be taken, as outlined in this subsection, to insure that the delivery pipe will drain at the end of each dosing cycle.

1. In the case of dosing tanks using pumps, when the low-water level in the tank is lower than the invert of the distribution box or distribution network, the delivery pipe shall be sloped back towards the dosing tank and there shall be no check-valve at the pump so that the delivery pipe will drain back into the dosing tank at the end of each dosing cycle. Also, a one-eighth inch weep hole shall be provided, at the invert of the pump discharge pipe, at a point which is above the high water level in the dosing tank.

2. In the case of dosing tanks using siphons, or when a pump is used and the elevation of the low-water level in the dosing tank is higher than the invert of the distribution box or distribution network, the distribution network must be designed so that the delivery pipe (as well as the manifold pipe, in pressure distribution systems) will drain out through the distribution laterals at the end of each dosing cycle. In the latter case, where a pump is used, a one-eighth inch weep hole shall be drilled in the delivery pipe, at its highest point within the dosing tank, to prevent effluent from siphoning out of the tank between dosing cycles.

7:9A-9.4 Distribution boxes

(a) A distribution box shall be required for all gravity flow systems and all gravity dosing systems where the effluent shall be distributed between two or more separate distribution laterals. The following requirements shall be met:

1. Distribution boxes shall be water-tight and constructed of sound and durable materials which will resist decay or corrosion by sulphuric acid, frost damage, cracking or buckling due to backfilling or other anticipated stresses.

2. The distribution box shall be set perfectly level and shall be installed as follows:

i. In the case of disposal beds, the distribution box shall be installed directly on the filter material within the disposal bed.

ii. In the case of disposal trenches, the distribution box shall be set on a layer of gravel or a concrete footing extending downward below the maximum expected depth of frost penetration. Where gravel is used, the gravel shall extend laterally a minimum of six inches beyond the sides of the distribution box.

3. A separate outlet shall be provided for each distribution lateral. The inverts of all outlets shall be securely set at the same level which shall be a minimum of two inches above the bottom of the box. When installation is complete the distribution box shall be filled with water at which time the installation shall be checked to make sure that it is level. Adjustments shall be made as necessary so that all outlets are permanently and securely fixed at exactly the same elevation prior to backfilling.

4. The invert of the inlet shall be at least one inch above the invert of the outlets. Where dosing is employed, or where the connecting pipe from the pre-treatment unit has a steep slope, measures shall be taken to prevent direct flow of effluent across the distribution box resulting in unequal distribution of effluent among the distribution box outlets. This may be accomplished by installation of a baffle or elbow within the distribution box or by use of two distribution boxes connected in series. In the latter case, all outlets of the first distribution box shall be sealed off except for the outlet which discharges to the second distribution box.

5. Distribution boxes shall be provided with a means of access which may be a removable lid in the case of smaller boxes. Access to larger boxes may be provided by means of manholes and inspection ports with removable water-tight covers. In any case, the following requirements shall be met:

THIS IS A COURTESY COPY OF THIS RULE. ALL OF THE DEPARTMENT'S RULES ARE COMPILED IN TITLE 7 OF THE NEW JERSEY ADMINISTRATIVE CODE.

- i. Access openings must be adequate in size and located to facilitate removal of accumulated solids and inspection of the inlet and all outlets.
- ii. All access openings shall be extended to within 12 to 18 inches of the finished grade surface.
- iii. Access openings shall be constructed in such a manner as to prevent the entrance of surface water.

7:9A-9.5 Laterals; gravity distribution

(a) Except as provided by N.J.A.C. 7:9A-9.8, gravity flow networks and gravity dosing networks may consist of a single distribution lateral, two or more laterals connected by means of elbows or tees, or two or more separate distribution laterals connected independently to a distribution box. Distribution laterals shall meet all the following requirements:

1. Distribution laterals shall be a minimum of three inches in diameter.
2. Distribution laterals shall consist of lengths of rigid perforated pipe connected with tight joints.
3. Spacing and arrangement of distribution laterals shall conform with N.J.A.C. 7:9A-10.3(d).
4. Perforations shall be evenly spaced along two rows running the length of the pipe, on each side, midway between the invert and the centerline which separates the upper and lower halves of the pipe. Perforations shall be no smaller than three-eighth inch and no longer than three-quarter inch in diameter.
5. Each individual distribution line shall be approximately level and shall be capped at the end, except where the laterals are connected together by loops. In no case shall the slope of the distribution lines be greater than two inches per 100 feet.
6. An inspection port shall be provided in each corner of the disposal bed or at each end of a disposal trench. Inspection ports shall consist of a perforated pipe with a removable cap, extending from the level of infiltration to finished grade.

(b) The following materials are acceptable for distribution laterals:

1. Clay pipe, standard and extra strength perforated (ASTM C-211); or
2. Plastic:
 - i. Acrylonitrile-Butadiene-Styrene (ABS) (ASTM D-2751);
 - ii. Polyvinyl Chloride (PVC) (ASTM D-2729, D-3033, D-3034);
 - iii. Styrene-Rubber (ASTM D-2852, D-3298); or
 - iv. Polyethylene, straight wall (ASTM F-810).

7:9A-9.6 Pressure dosing networks

(a) Pipe networks for pressure dosing systems shall consist of two or more distribution laterals connected to a central or end manifold. The following requirements shall be met:

1. The size of laterals shall be no less than one but no greater than three inches in diameter and shall be chosen in conformance with N.J.A.C. 7:9A-9.7(a)3. The size of the manifold pipe shall be chosen in conformance with N.J.A.C. 7:9A-9.7(a)5.
2. Spacing and arrangement of laterals shall conform with the requirements of N.J.A.C. 7:9A-10.3(d).
3. All joints and connections shall be water-tight. Solvent-weld joints shall be used.
4. Holes shall be spaced evenly, in a straight line along the invert of each lateral. Hole diameter and spacing may vary from one-quarter to one-half inch and from 30 to 60 inches, respectively, and shall be chosen in conformance with N.J.A.C. 7:9A-9.7(a)2. In bed systems, holes in adjacent laterals shall be off-set by one-half

THIS IS A COURTESY COPY OF THIS RULE. ALL OF THE DEPARTMENT'S RULES ARE COMPILED IN TITLE 7 OF THE NEW JERSEY ADMINISTRATIVE CODE.

the hole spacing so that the distance between holes in adjacent laterals is maximized. All holes shall be deburred.

5. The ends of the laterals shall be capped. A small hole shall be drilled horizontally in the end-cap of each lateral, near the crown, to facilitate venting at the beginning of each dosing cycle.

6. Each individual distribution line shall be approximately level. In no case shall the slope of the distribution lines be greater than two inches per 100 feet.

7. An inspection port shall be provided in each corner of a disposal bed or at each end of a disposal trench. Inspection ports shall consist of a perforated pipe with a removable cap, extending from the level of infiltration to finished grade.

8. Pressure dosing networks shall be constructed of PVC plastic (ASTM D-2665), schedule 40, SDR-21 or SDR-26, or ABS plastic (ASTM D-2661) pipe.

7:9A-9.7 Design procedure for pressure dosing systems

(a) The following procedure shall be used for disposal fields consisting of a disposal bed or disposal trenches which are at equal elevations.

1. Step One: Determine the length, number and spacing of distribution laterals based upon the required size of the disposal field, determined as prescribed in N.J.A.C. 7:9A-10.2, and the requirements for spacing of disposal trenches or the requirements for spacing of distribution laterals within disposal beds as prescribed in N.J.A.C. 7:9A-10.3(d). The number of distribution laterals will also depend upon whether a central or end manifold arrangement is used.

2. Step Two: Select the hole diameter and spacing. The hole diameter shall be a minimum of one-quarter inch but no larger than one-half inch. The minimum allowed hole spacing shall be 30 inches. The maximum allowed hole spacing shall be 60 inches, except in the case of systems installed in soils or fill material with a permeability faster than six inches per hour or a percolation rate faster than 15 minutes per inch, in which case the maximum allowed hole spacing shall be 36 inches.

3. Step Three: Based upon the hole diameter and the hole spacing selected and the length of the laterals, determine the required diameter of laterals using Figure 14 of Appendix A. If the disposal field configuration is such that it is beyond the applicable limits of Figure 14, other methods of hydraulically evaluating adequate lateral diameter may be used subject to prior approval by the administrative authority.

4. Step Four: Pressure distribution systems shall be designed so that a minimum pressure head of 2.5 feet shall be maintained at the distal end of the laterals. Based upon the hole diameter and the design pressure head at the distal end of the laterals, determine the hole discharge rate from the table below. Determine the lateral discharge rate by multiplying the hole discharge rate by the number of holes per lateral.

Discharge Rate (gallons per minute) based on Hole Diameter (inches)

Pressure Head (ft.)	1/4	5/16	3/8	7/16	1/2
2.5	1.18	1.85	2.66	3.63	4.73
3.0	1.28	1.99	2.87	3.91	5.10
3.5	1.40	2.19	3.15	4.29	5.60
4.0	1.47	2.30	3.31	4.51	5.89
4.5	1.59	2.48	3.57	4.86	6.35

THIS IS A COURTESY COPY OF THIS RULE. ALL OF THE DEPARTMENT'S RULES ARE COMPILED IN TITLE 7 OF THE NEW JERSEY ADMINISTRATIVE CODE.

5.0 1.65 2.57 3.71 5.04 6.59

5. Step Five: Based upon the number of laterals and the lateral spacing, determine the manifold length. Based upon the manifold length, the lateral discharge rate and the number of laterals, using Figure 15 of Appendix A, determine the required manifold diameter. If the disposal field configuration is such that it is beyond the applicable limits of Figure 15, other methods of hydraulically evaluating proper manifold diameter may be used subject to approval by the administrative authority.

6. Step Six: Determine the necessary system discharge rate by multiplying the lateral discharge rate by the number of laterals; and

7. Step Seven: For pump systems, select the proper pump as follows:

i. Using Figure 16 of Appendix A, determine the friction head based upon the system discharge rate and the diameter and length of the delivery pipe. If the system discharge rate is such that it is beyond the applicable limits of Figure 16, then other methods of determining friction head in the delivery pipe may be used subject to approval by the administrative authority.

ii. Calculate the total operating head, H_t , using the following formula:

$$H_t = H_f + H_e + H_p$$

H_f is the friction head, in feet, determined in (a)7i above;

H_e is the elevation head, in feet, calculated by subtracting the dosing tank low water elevation from the elevation of the invert of the distribution laterals; and

H_p is the design pressure head to be maintained at the distal end of the laterals, in feet.

iii. Choose a pump which is rated by the manufacturer to deliver a flow rate equal to or greater than the system discharge rate calculated in Step Six when working against a total dynamic head equal to the total operating head calculated in (a)7ii above.

8. Alternate Step Seven: For systems using siphons, determine the siphon elevation as follows:

i. Determine the friction head in the delivery pipe as in (a)7i above.

ii. Calculate the velocity head using the following formula:

$$H_v, \text{ ft} = (D/A)^2/2g$$

where:

D = System Discharge Rate, ft^3/sec .

= (System Discharge Rate, gpm) $(1 \text{ ft}^3/7.48 \text{ gal}) (1 \text{ min}/60 \text{ sec})$

A = pipe area, ft^2

= $[(\text{internal pipe diameter, in}/2) (1 \text{ ft}/12 \text{ in})]^2 (3.14)$

$g = 32.2 \text{ ft}/\text{sec}^2$

iii. Calculate the total operating head, H_t , by the following equation:

$$H_t, \text{ ft} = H_f + H_v + H_p$$

where:

THIS IS A COURTESY COPY OF THIS RULE. ALL OF THE DEPARTMENT'S RULES ARE COMPILED IN TITLE 7 OF THE NEW JERSEY ADMINISTRATIVE CODE.

H_f , is the friction head, in feet, determined from Figure 16 of Appendix A.

H_v , is the velocity head, in feet, determined in (a)8ii above.

H_p , is the design pressure head to be maintained at the supply end of the laterals, in feet.

iv. Choose a siphon rated to discharge at a flow rate equal to or greater than the system discharge rate. Install the siphon at an elevation such that the siphon invert is higher than the invert of the distribution laterals by a distance equal to the total operating head calculated in (a)7iii above.

(b) If a trench system is proposed where the elevation of the infiltrative surface will not be the same in all trenches, the design engineer must demonstrate by means of appropriate calculations to the satisfaction of the administrative authority, that all portions of all trenches will receive equal hydraulic loading in conformance with the requirements of N.J.A.C. 7:9A-10.2. One way of accomplishing this would be to divide the disposal field into sections consisting of individual trenches or groups of trenches which are at the same elevation and which are dosed individually in conformance with the requirements of this section.

7:9A-9.8 Products in lieu of laterals and/or filter material

(a) The Department shall maintain a list of products that may be used in lieu of laterals specified in N.J.A.C. 7:9A-9.5 and/or filter material specified in N.J.A.C. 7:9A-10.3(e) as acceptable alternatives to those specifications. For systems designed as pressure dosing networks (see N.J.A.C. 7:9A-9.6), these products may be used in lieu of the filter material only, and then only if the required laterals are securely installed within the specified product. These products may be used for a trench or bed configurations designed in accordance with this section in conventional, soil replacement-bottom lined, soil replacement-fill enclosed, mounded, and mounded soil replacement systems, designed in accordance with the requirements of N.J.A.C. 7:9A-10. Manufacturers of these products shall comply with the following:

1. Any manufacturer seeking listing of a product pursuant to this section shall submit a written request to the Department at the address identified at N.J.A.C. 7:9A-3.9(e) identifying that manufacturer. The written request shall include all results documenting structural integrity of the product evaluated in accordance with an American Association of State Highway and Traffic Officials (AASHTO) H-10 load rating (16,000 lbs/axle), incorporated by reference, as amended. AASHTO load rating methods can be obtained at <http://transportation.org>. The request shall additionally specify a means of installing inspection ports that will allow an inspector or system owner to determine the depth of wastewater within the product. Any other performance based certifications or approvals from other states that have been issued for the product should also be included with the request.
2. Manufacturers shall make available up-to-date training, design, installation and service manuals and materials to any administrative authority or the Department upon request.
3. Manufacturers shall comply with all requirements of this chapter and any requirements of any certification submitted in support of this listing, including the manufacture, design or construction standards for the product used in support of the AASHTO load rating report.
4. If a manufacturer of a product used in lieu of laterals and filter material wishes to allow for an alternative inlet invert elevation of 12 inches above the level of infiltration, required by N.J.A.C. 7:9A-10 for the various types of system designs, an alternative inlet invert may be requested by a manufacturer if it can be demonstrated to the Department that the product will provide an equivalent storage capacity provided by laterals and filter material in a standard system design. Alternative inlet invert heights will be specified in the list provided by the Department.

(b) Systems that are proposed to include products identified on the Department list developed in accordance with (a) above shall be designed by a septic system designer who is sufficiently knowledgeable of the product and installed by an authorized installer. A copy of the authorized installer's written certification as required in N.J.A.C. 7:9A-3.17 shall be available upon request.

THIS IS A COURTESY COPY OF THIS RULE. ALL OF THE DEPARTMENT'S RULES ARE COMPILED IN TITLE 7 OF THE NEW JERSEY ADMINISTRATIVE CODE.

- (c) Any system containing these products shall be designed and installed in accordance with all manufacturer's specifications and recommendations and the minimum requirements of this chapter. The septic system designer shall certify on the plans that he or she is sufficiently knowledgeable of the technology to design the system being proposed.
- (d) The minimum area of the disposal field shall be calculated in accordance with N.J.A.C. 7:9A-10.2. The product shall be designed in accordance to the manufacturer's recommendations. If the manufacturer recommends a specified spacing between product units, the disposal area does not need to be increased provided the spacing does not exceed six inches. If the soil between the units does not have the capacity to become saturated or spacing of the units exceeds six inches, the minimum disposal area must equal the bottom area of the units only, not including the space between the units.
- (e) When pressure dosing is specified, a distribution pipe meeting the requirements of N.J.A.C. 7:9A-9.6 shall be installed according to manufacturer's instructions. Holes in the distribution pipe shall face up at an angle consistent with manufacturer's instructions.
- (f) Inspection ports shall be installed in the four corners of the disposal area within the product. When individual rows of the product are not immediately adjoining or are not interconnected at both ends within four inches of the level of infiltration, inspection ports shall be installed in each end of each row of these products.
- (g) Drainage fabric required at N.J.A.C. 7:9A-10.3(e)3 may be omitted for those products where the manufacturer has specified in the design standards that drainage fabric is not required and that the product is designed to prevent soil material above the product from migrating into the product and to the level of infiltration.
- (h) When a disposal bed with a distribution box is proposed, in lieu of N.J.A.C. 7:9A-9.4(a)2i the distribution box shall be installed within two feet of the disposal bed using the criteria specified in N.J.A.C. 7:9A-9.4(a)2ii.

Subchapter 10. Disposal Fields

7:9A-10.1 General design requirements for disposal fields

- (a) A disposal field shall be required for all new systems except as allowed in N.J.A.C. 7:9A-7.6, in which case a seepage pit may be approved in lieu of a disposal field. The disposal field shall consist of one or more disposal trenches or a disposal bed designed, constructed and installed as hereafter prescribed.
- (b) No disposal field shall be installed in areas where the depth to any limiting zone below the existing ground surface is less than 24 inches. The disposal field installation shall be such that the disposal field is underlain by a suitable zone of treatment as prescribed in (d) below and a suitable zone of disposal as prescribed in (e) below. Acceptable options for disposal field installation are as follows:
 1. Conventional installation: The disposal field shall be installed directly within the native soil and the level of infiltration shall be from one to three feet below the existing ground surface, as shown in Figure 17 of Appendix A.
 2. Soil replacement, bottom-lined installation: The excavation for the disposal bed or each individual trench shall be extended below the level of infiltration and back-filled up to the level of infiltration with suitable fill. The disposal bed or trenches shall be installed on top of the fill with the level of infiltration one to three feet below the existing ground surface, as shown in Figure 18 of Appendix A.
 3. Soil replacement, fill-enclosed installation: An excavation shall be made below the level of infiltration and extending laterally a minimum of two feet beyond the perimeter of the disposal field on all sides. This excavation shall be back-filled with suitable fill, the disposal bed or trenches installed within the fill, and the level of infiltration shall be at existing ground surface to three feet below the existing ground surface, as shown in Figure 19 of Appendix A.
 4. Mounded installation: Fill material shall be placed above the existing ground surface; the disposal field shall be installed within the fill; and the level of infiltration shall be one to four feet above the existing ground

THIS IS A COURTESY COPY OF THIS RULE. ALL OF THE DEPARTMENT'S RULES ARE COMPILED IN TITLE 7 OF THE NEW JERSEY ADMINISTRATIVE CODE.

surface (measured on the upslope side of the disposal bed or each individual disposal trench), as shown in Figure 20 of Appendix A.

5. Mounded soil replacement installation: An excavation shall be made below the existing ground surface; fill material shall be placed within this excavation and mounded up above the existing ground surface; the disposal field shall be installed within the fill; and the level of infiltration shall be at existing ground surface or up to four feet above the existing ground surface (measured on the upslope side of the disposal bed or each individual disposal trench), as shown in Figure 21 of Appendix A.

(c) The type of disposal field installation permitted shall be determined based upon the soil suitability class as outlined in Table 10.1, below.

TABLE 10.1 TYPE OF DISPOSAL FIELD INSTALLATION

C = Conventional Installation

SRB = Soil Replacement, Bottom-lined Installation

SRE = Soil Replacement, Fill-enclosed Installation

M = Mound Installation

MSR = Mounded Soil Replacement Installation¹

Type of Limiting Zone	Depth ² , Ft.	Suitability Class	Type of Installation Permitted ³
Fractured Rock or Excessively Coarse Substratum	>5	I	C, (SRB, SRE, M, MSR)
	0-5	IISc	SRE, M, (MSR)
Massive Rock Hydraulically Restrictive Substratum	>9	I	C, (SRB, SRE, M, MSR)
	4-9	IISr	M, (MSR)
	<4	IIISr	UNSUITABLE
Hydraulically Restrictive Horizon, Permeable Substratum	>9	I	C, (SRB, SRE, M, MSR)
	4-9	IIHr	SRB, SRE, M, (MSR)
	<4	IIIHr	SRB, SRE, (MSR)
Excessively Coarse Horizon	>5	I	C, (SRB, SRE, M, MSR)
	0-5	IIHc	SRE, M, (MSR)
Zone of Saturation, Regional	>5	I	C, (SRB, SRE, M, MSR)
	2-5	IIWr	M, (SRE, MSR)
	<2	IIIW _r	UNSUITABLE
Zone of Saturation, Perched	>5	I	C, (SRB, SRE, M, MSR)
	2-5	IIWp	C ⁴ , (SRB ⁴ , SRE, M, MSR)
	<2	IIIW _p	C ⁴ , (SRB ⁴ , SRE, M, MSR)

- (1) Mounded soil replacement systems are generally required only in cases where several limiting zones are present as, for example, in compound soil suitability classes such as IIScWr, IIIHr (IISr) or IIIHr (IIWr).
- (2) Depth is measured from the ground surface to the top of the limiting zone. In the case of disturbed ground, the depth to the limiting zone shall be measured from the existing ground surface, identified as prescribed in N.J.A.C. 7:9A-5.10(c), or the ground surface, whichever is lowest.

THIS IS A COURTESY COPY OF THIS RULE. ALL OF THE DEPARTMENT'S RULES ARE COMPILED IN TITLE 7 OF THE NEW JERSEY ADMINISTRATIVE CODE.

- (3) Installations shown in parentheses are allowed but are generally not the most cost-effective type of installation for the soil suitability class unless other soil limitations are present.
- (4) An interceptor drain or other means of removing the perched zone of saturation is required.

Note: In soils with a compound soil suitability class, where more than one limiting zone is present in the soil, a disposal field installation shall not be approved unless the type of installation proposed is listed in Table 10.1 as an acceptable option for each of the soil suitability classes which apply.

(d) A zone of treatment (see Figures 22, 23 and 24 in Appendix A), a minimum of four feet in thickness, shall be present below the disposal field and shall meet all of the following requirements:

1. The zone of treatment shall be composed of suitable soil which meets all of the criteria listed in (d)2 below, suitable fill material which satisfies the requirements of (f) below, or a combination of suitable soil and suitable fill.
2. Suitable soil within the zone of treatment shall meet the following criteria:
 - i. Coarse fragment content less than 50 percent by volume;
 - ii. Permeability less than 20 inches per hour and greater than 0.2 inches per hour, or a percolation rate slower than three minutes per inch and faster than 60 minutes per inch.
3. The zone of treatment shall not contain or be interrupted by fractured or massive rock substrata, hydraulically restrictive horizons or substrata, perched zones of saturation or regional zones of saturation. When excessively coarse horizons or substrata are present above, within or below the zone of treatment, these horizons shall not be considered part of the zone of treatment.
4. For design purposes, the top of the zone of treatment shall be considered to be the bottom of the disposal field or the bottom of an excessively coarse horizon when such a horizon is present immediately below the bottom of the disposal field. The bottom of the zone of treatment shall be considered to be whichever of the features listed below occurs at a shallower depth below the disposal field, except that in no case shall the bottom of the zone of treatment extend to a depth greater than eight feet below finished grade.
 - i. An imaginary horizontal surface at a depth of four feet below the top of the zone of treatment, excluding the thickness of any intervening excessively coarse horizons;
 - ii. The top of the shallowest limiting zone which is present in the soil below the disposal field; or
 - iii. The bottom of the shallowest soil profile pit or boring made within the area of the disposal field.
5. The thickness of the zone of treatment may be reduced, at the administrative authority's discretion, to a minimum of 18 inches in thickness when the system design incorporates an advanced wastewater pretreatment device in accordance with N.J.A.C. 7:9A-8.3.

(e) A zone of disposal (see Figures 22, 23 and 24 in Appendix A), a minimum of four feet in thickness, shall be present below the zone of treatment and shall meet all of the following requirements:

1. The zone of disposal shall be composed of native soil or rock material which has a permeability more rapid than 0.2 inch per hour or a percolation rate more rapid than 60 minutes per inch;
2. When the permeability in the zone of disposal has been determined, as prescribed in N.J.A.C. 7:9A-6, to be two inches per hour or faster, the minimum required thickness of the zone of disposal may be reduced to two feet. This determination shall not be made using the percolation test or basin flooding test;
3. When the permeability of the zone of disposal has been determined to be two inches per hour or faster, as prescribed in N.J.A.C. 7:9A-6, or the basin flooding test drains in less than three hours on each and every filling, the minimum required field bottom area of the zone of disposal may be reduced by 25 percent, except in cases where a perched zone of saturation exists and interceptor trenches are not proposed. This determination shall not be made using the percolation test. The permeability test shall be conducted within the

THIS IS A COURTESY COPY OF THIS RULE. ALL OF THE DEPARTMENT'S RULES ARE COMPILED IN TITLE 7 OF THE NEW JERSEY ADMINISTRATIVE CODE.

zone of disposal at the location of the proposed disposal field. In no case shall the reduction result in drainage from the zone of treatment being inhibited. Accordingly, the unexcavated area of the zone of disposal shall be sloped to promote drainage to the excavated area. The minimum field bottom area of the zone of treatment shall not be reduced.

4. The zone of disposal shall not contain or be interrupted by any hydraulically restrictive horizon unless the entire thickness of this horizon has been removed throughout the entire area of the disposal field and has been replaced with fill material meeting the requirements of (f)5 below. The thickness of any restrictive horizon which has been removed shall not be counted as part of the zone of disposal; and

5. For design purposes, the top of the zone of disposal shall be taken as the bottom of the zone of treatment. The bottom of the zone of disposal shall be considered to be whichever of the following features is present at a shallower depth below the disposal field:

- i. The top of any massive rock or hydraulically restrictive substratum;
- ii. The top of the shallowest hydraulically restrictive horizon which occurs below the bottom of the disposal field, except when the hydraulically restrictive horizon is to be removed and replaced with suitable fill materials; or
- iii. The bottom of the shallowest soil profile pit or boring made below the disposal field.

(f) When fill material is used in disposal field construction, the following requirements shall be met:

1. When a soil replacement installation is proposed, the zone of treatment may consist partly or entirely of fill material provided that the requirements of N.J.A.C. 7:9A-10.4 are satisfied and the fill material used meets the requirements of (f)4 below. The zone of disposal may contain a layer of fill provided that the fill material used within the zone of disposal meets the requirements of (f)5 below.

2. When a mound installation is proposed, the zone of treatment may consist partly or entirely of fill material provided that the requirements of N.J.A.C. 7:9A-10.5 are satisfied and the fill material used meets the requirements of (f)4 below.

3. When a mounded soil replacement installation is proposed, the zone of treatment may consist partly or entirely of fill material provided that the requirements of N.J.A.C. 7:9A-10.6 are satisfied and the fill material used meets the requirements of (f)4 below. The zone of disposal may contain a layer of fill provided that the fill material used within the zone of disposal meets the requirements of (f)5 below.

4. When fill material is utilized within the zone of treatment, the fill shall meet the following requirements:

- i. Coarse fragment content (greater than a No. 8 sieve) less than 15 percent by volume or less than 20 percent by weight;
- ii. Textural analysis (composition, by weight, of size fraction passing the particular sieve as stated below in this subparagraph) between 80 and 100 percent must pass a No. 8 sieve (2.36 mm); between 50 and 85 percent must pass a No. 16 sieve (1.18 mm); between 25 and 60 percent must pass a No. 30 sieve (0.6 mm); between 10 and 30 percent must pass a No. 50 sieve (0.3 mm); and between two and 10 percent must pass a No. 100 sieve (0.15 mm); and
- iii. Permeability for this material is established in this chapter at the range of six to 20 inches per hour for design purposes.

5. When fill material is placed within the zone of disposal, the fill material shall meet the specifications in (f)4 above or the following requirements:

- i. Coarse fragment content less than 15 percent by volume or less than 25 percent by weight;
- ii. Textural analysis (composition, by weight, of size fraction passing the two millimeter sieve): 85 percent or more sand; and

THIS IS A COURTESY COPY OF THIS RULE. ALL OF THE DEPARTMENT'S RULES ARE COMPILED IN TITLE 7 OF THE NEW JERSEY ADMINISTRATIVE CODE.

iii. Permeability greater than two inches per hour; or percolation rate faster than 30 minutes per inch.

6. Use of the term or specification bank run, which implies a material of alluvial deposition which is high in coarse fragment content, in system designs shall be prohibited unless a septic system designer includes a specification for that material consistent with (f)4 or 5 above, as applicable.

(g) The following requirements shall be met when installing a disposal field in sloping ground:

1. The interface between filter material and the underlying soil or fill material at the bottom of each individual trench or bed shall be level;
2. On strongly sloping sites the shape of the disposal field shall be elongated with the long axis parallel to the topographic contour;
3. When the slope of the existing ground surface is between 10 and 25 percent, trenches shall be used rather than beds;
4. Mound or mounded soil replacement installations shall be restricted to slopes less than 10 percent; and
5. When disposal trenches are installed at different elevations and gravity flow or gravity dosing are used, the distribution of effluent between trenches shall be accomplished by means of a distribution box.

(h) When a conventional or soil replacement installation is proposed, the bottom of the disposal field shall be at a depth from one to three feet below the existing ground surface. When a mound or mounded soil replacement installation is proposed, the level of infiltration shall be at an elevation no higher than four feet above the existing ground surface, measured on the upslope side of the disposal bed or each individual disposal trench. In no case shall the level of infiltration be greater than three feet below the finished grade.

7:9A-10.2 Disposal field sizing requirements

(a) The minimum required disposal field size or the maximum allowable hydraulic loading rate shall be determined, using sizing criteria as prescribed below, based upon the volume of sanitary sewage, determined as prescribed in N.J.A.C. 7:9A-7.4, and the results of permeability tests or percolation tests performed as prescribed in N.J.A.C. 7:9A-6.

1. The disposal field sizing criteria to be used shall be determined based upon the type of disposal field, disposal field installation and the method of effluent distribution used, as follows:

TABLE 10.2(a) APPLICABLE DISPOSAL FIELD SIZING CRITERIA

Type of Disposal Field Installation	Type of Disposal Field	Method of Distribution	Applicable Sizing Criteria
Conventional	Trench	Gravity	N.J.A.C. 7:9A-10.2(b)
		Pressure	N.J.A.C. 7:9A-10.2(b)
	Bed	Gravity	N.J.A.C. 7:9A-10.2(c)
		Pressure	N.J.A.C. 7:9A-10.2(c)
Soil Replacement, Bottom-lined	Trench	Gravity	N.J.A.C. 7:9A-10.2(c)
		Pressure	N.J.A.C. 7:9A-10.2(d)
	Bed	Gravity	N.J.A.C. 7:9A-10.2(c)
		Pressure	N.J.A.C. 7:9A-10.2(d)
Soil Replacement, Fill-enclosed	Trench	Gravity	N.J.A.C. 7:9A-10.2(b)
		Pressure	N.J.A.C. 7:9A-10.2(b)
	Bed	Gravity	N.J.A.C. 7:9A-10.2(c)
		Pressure	N.J.A.C. 7:9A-10.2(d)

THIS IS A COURTESY COPY OF THIS RULE. ALL OF THE DEPARTMENT'S RULES ARE COMPILED IN TITLE 7 OF THE NEW JERSEY ADMINISTRATIVE CODE.

Mounded, Mounded Soil Replacement	Trench	Gravity	N.J.A.C. 7:9A-10.2(b)
		Pressure	N.J.A.C. 7:9A-10.2(b)
	Bed	Gravity	N.J.A.C. 7:9A-10.2(c)
		Pressure	N.J.A.C. 7:9A-10.2(d)

2. Systems that incorporate an advanced wastewater pretreatment device may, at the administrative authority's discretion, alternatively use Table 10.2(d) below for Table 10.2(b) below and Table 10.2(e) below for (d) below or Table 10.2(c) below, as applicable, for the criteria used to calculate the size of a disposal field.

(b) All disposal fields using trenches, except for bottom-lined soil replacement installations, shall meet the following size requirements:

1. The minimum required length of trenches per gallon of daily sewage volume, L/Q, shall be determined from Table 10.2(b) below, based upon the trench width selected and the results of permeability tests or percolation tests, performed as prescribed in N.J.A.C. 7:9A-6.

2. The minimum required length of trenches, L, shall then be determined by multiplying the value of L/Q obtained from the table by the daily volume of sewage, Q, determined as prescribed in N.J.A.C. 7:9A-7.4.

(c) All disposal beds using gravity flow or gravity dosing, all conventionally installed disposal beds using pressure dosing and all bottom-lined soil replacement trench installations using gravity flow or gravity dosing shall meet the following size requirements.

1. The minimum required bottom area of disposal field per gallon of daily sewage volume, A/Q, shall be determined from Table 10.2(c) below, based upon the results of permeability tests or percolation tests performed as prescribed in N.J.A.C. 7:9A-6.

2. The minimum required bottom area shall then be determined by multiplying the value of A/Q obtained from the table by the daily volume of sewage, Q, in gallons, determined as prescribed in N.J.A.C. 7:9A-7.4.

(d) All disposal beds using pressure dosing except for conventional installations and all bottom-lined soil replacement trench installations using pressure dosing shall have a minimum size of 1.33 square feet of bottom area per gallon of daily sewage volume.

TABLE 10.2(b) MINIMUM REQUIRED DISPOSAL TRENCH LENGTH PER GALLON OF DAILY SANITARY SEWAGE VOLUME, L/Q (ft/gal per day)

Permeability (in/hr)	Percolation Rate (min/in)	Trench Width (ft):	L/Q ¹ (ft/gal per day)			
			1.5	2.0	2.5	3.0
>6-20	<3-15		0.65	0.54	0.46	0.40
>2-6	<15-30		0.83	0.69	0.59	0.52
>0.6-2	<30-45		1.03	0.85	0.73	0.64
>0.2-0.6	<45-60		1.18	0.98	0.84	0.74

TABLE 10.2 (c) MINIMUM REQUIRED DISPOSAL FIELD BOTTOM AREA OF ZONE OF TREATMENT PER GALLON OF DAILY SANITARY SEWAGE VOLUME A/Q¹ (ft²/gal per day))

Permeability (in/hr)	Percolation Rate (min/in)	A/Q ¹ (ft ² /gal per day)
>6-20	<3-15	1.61
>2-6	<15-30	2.08

THIS IS A COURTESY COPY OF THIS RULE. ALL OF THE DEPARTMENT'S RULES ARE COMPILED IN TITLE 7 OF THE NEW JERSEY ADMINISTRATIVE CODE.

>0.6-2	<30-45	2.56
>0.2-0.6	<45-60	2.94

TABLE 10.2(d) MINIMUM REQUIRED DISPOSAL TRENCH LENGTH PER GALLON OF DAILY SANITARY SEWAGE VOLUME, L/Q^1 (ft/gal per day) WITH AN ADVANCED WASTEWATER PRETREATMENT DEVICE

Permeability (in/hr)	Percolation Rate (min/in)	Trench Width (ft)	Adjusted L/Q^1 (ft/gal per day)			
			1.5	2.0	2.5	3.0
>6-20	<3-15		0.50	0.42	0.36	0.31
>2-6	<15-30		0.68	0.57	0.49	0.43
>0.6-2	<30-45		0.89	0.73	0.63	0.55
>0.2-0.6	<45-60		1.04	0.86	0.74	0.65

TABLE 10.2(e) MINIMUM REQUIRED DISPOSAL FIELD BOTTOM AREA PER GALLON OF DAILY SANITARY SEWAGE VOLUME, A/Q^1 (ft²/gal per day) WITH AN ADVANCED WASTEWATER PRETREATMENT DEVICE

Permeability (in/hr)	Percolation Rate (min/in)	Adjusted A/Q^1 (ft ² /gpd)
>6-20	<3-15	1.233
>2-6	<15-30	1.704
>0.6-2	<30-45	2.190
>0.2-0.6	<45-60	2.596
Pressure Dosing Design		0.956

¹ Additional Requirements:

a. Where garbage disposal units or grinder/ejector pumps are installed or proposed, the value obtained from this table shall be increased by a factor of 50 percent for use in disposal field sizing.

(e) Any system designed in accordance with Table 10.2(d) or (e) above shall not be sized less than 400 square feet of total bottom area and shall also include at least one of the following restrictions, at the administrative authority's discretion, in the application for the proposed design:

THIS IS A COURTESY COPY OF THIS RULE. ALL OF THE DEPARTMENT'S RULES ARE COMPILED IN TITLE 7 OF THE NEW JERSEY ADMINISTRATIVE CODE.

1. An area reserved for sanitary sewage disposal, including all necessary separation distance requirements, equal to the total area required if advanced wastewater pretreatment was not included in the design. This area reserved for sanitary sewage disposal may include the area where the proposed disposal area is located; and/or
2. A deed restriction placed on the property prior to the issuance of any certificate of compliance for the system, a copy of which must be maintained in the administrative authority's records that identifies the need for the advanced wastewater pretreatment system and accompanying requirements to maintain that system in perpetuity, as required by N.J.A.C. 7:9A-12.3, including any repairs or alterations to the system as long as the structure served exists on the property.

7:9A-10.3 Specific requirements for conventional disposal field installations

- (a) A conventional installation shall be made by placing the disposal bed or each individual disposal trench in an excavation made directly within the natural soil.
- (b) All rough-grading shall be in accordance with the following requirements:
 1. Sites which have been re-graded prior to site evaluation, soil evaluation or permeability testing shall be considered to be disturbed ground and all requirements relating to disturbed ground shall be met.
 2. When a site is re-graded after site evaluation, soil evaluation or permeability testing, this re-grading shall be carried out in conformance with an engineering design which has been approved by the administrative authority.
- (c) Excavation for the disposal field shall be in accordance with the following procedures:
 1. Adequate measures shall be used to insure that the bottom of the disposal bed or each individual disposal trench is level.
 2. In soil textures other than sands or loamy sands, excavation which exposes the infiltrative surface of the disposal field shall not be carried out when the soil moisture content is above the lower plastic limit. This means that when a small lump of soil, taken from the depth of the proposed excavation, can be rolled out with the fingers to form a wire or rod, one-eighth of an inch in thickness, and does not crumble when handled, the soil is too wet to proceed with the excavation.
 3. Excavation shall be carried out in a manner that will avoid unnecessary compaction of the disposal field bottom and sidewalls. Heavy equipment such as bulldozers or front-end loaders shall not be driven over the exposed infiltrative surface of the disposal field. Excavation should be carried out with a backhoe operating from between disposal trenches or from outside the perimeter of previously excavated portions of the disposal bed. If it becomes necessary to walk on the disposal field bottom, a suitable board shall be laid over the soil to avoid trampling.
 4. Any smeared or compacted soil surfaces which have been produced on the bottom or sidewalls of the excavation shall be removed to expose a fresh soil surface which is rough and uneven.
 5. Work should be scheduled so that the bottom and sidewalls of the excavation will not be exposed to rainfall or wind-blown silt between the time of excavation and the time of final inspection and backfilling. Any loose soil or debris which is washed into or otherwise deposited within the excavation as a result of the excavation remaining open to the elements shall be carefully removed prior to backfilling.
- (d) The construction of the distribution network shall be in accordance with N.J.A.C. 7:9A-9.5, when gravity flow or gravity dosing is used, or N.J.A.C. 7:9A-9.6, when pressure dosing is used. Additional requirements for disposal trenches or beds are given in (d)1, and 2 below, respectively.
 1. Disposal trenches shall be constructed in accordance with the following requirements:
 - i. The minimum spacing between trenches (sidewall to sidewall) shall be six feet.
 - ii. The minimum width of trenches shall be 1.5 feet.

THIS IS A COURTESY COPY OF THIS RULE. ALL OF THE DEPARTMENT'S RULES ARE COMPILED IN TITLE 7 OF THE NEW JERSEY ADMINISTRATIVE CODE.

- iii. The maximum width of trenches shall be three feet.
 - iv. There shall be one distribution line per trench.
2. Disposal beds shall be constructed in conformance with the following requirements:
- i. There shall be a minimum of two distribution lines per bed.
 - ii. The maximum distance from edge of bed to nearest distribution line shall be three feet.
 - iii. The minimum distance from edge of bed to nearest distribution line shall be one foot.
 - iv. The maximum spacing between distribution lines for gravity distribution shall be three feet.
 - v. The required spacing between distribution lines for pressure distribution shall be from $3/4$ to $5/4$ of the hole spacing;
 - vi. The spacing between all distribution lines shall be equal and uniform; and
 - vii. Holes in pressure distribution lines shall be aligned so that holes in adjacent laterals shall be off-set by one-half the hole spacing.
- (e) Except as provided by N.J.A.C. 7:9A-9.8, filter material shall meet the following requirements:
1. Filter material shall cover the distribution lines and extend the full width of the trench or bed, shall extend between 12 and 18 inches deep beneath the bottom of the distribution lines and shall extend at least two inches above the top of the lines.
 2. The filter material shall be washed gravel or crushed stone, free of fines, dust, ashes or clay. Refer to the New Jersey Department of Transportation standard sizes for coarse aggregates as shown in Figure 26 of Appendix A. The filter material shall conform in size and gradation to size number 24, size number three or size number four.
 3. The filter material shall be covered with drainage fabric as the laying of the distribution lines progresses. In addition, the following requirements shall be met:
 - i. Edges of adjacent sheets shall be overlapped by a minimum of six inches.
 - ii. Drainage fabric shall be specified in the engineering design and shall have adequate tensile strength to prevent ripping during installation and backfilling, adequate air permeability to allow free passage of gases, and adequate particle retention to prevent downward migration of soil particles into the filter material.
 4. The filter material may be laid into the excavation using a backhoe, front-end loader or dump truck provided that this operation is carried out from sides of the system rather than by driving out onto the exposed disposal field infiltrative surface. In the case of large beds, tracked equipment may be operated within the disposal bed provided that the equipment does not exert a ground pressure in excess of eight pounds per square inch and provided that the filter material is pushed out in front of the vehicle while maintaining a minimum thickness of one foot of filter material below the vehicle tracks at all times.
- (f) Backfill and final grading shall be carried out in accordance with the following requirements:
1. A minimum of nine inches and no more than 18 inches of backfill shall be placed over the top of the disposal field filter material.
 2. Backfill material shall be of earth similar to that found at the site and free of large stones, tree stumps, broken masonry or other waste construction material.
 3. In no case shall the backfill material be more permeable than the surrounding soil.
 4. Backfill shall completely cover the entire disposal bed or each of the disposal trenches and shall be graded smoothly into the surrounding topography on all sides.

THIS IS A COURTESY COPY OF THIS RULE. ALL OF THE DEPARTMENT'S RULES ARE COMPILED IN TITLE 7 OF THE NEW JERSEY ADMINISTRATIVE CODE.

5. The following practices shall be followed:

- i. Heavy machinery, rubber-tired vehicles or other vehicles exerting a ground pressure in excess of eight pounds per square inch shall not be permitted to pass over the disposal field after the filter material and distribution network have been installed.
- ii. Tracked equipment may be used for the purpose of backfilling and final grading provided that this equipment does not exert a pressure on the underlying soil in excess of eight pounds per square inch.
- iii. Final grading shall be completed in accordance with the approved engineering design and in such a manner that surface water will not collect over the disposal field.
- iv. After completion of backfilling and final grading, the backfilled area over the disposal field shall be seeded or sodded to establish a vegetative cover or otherwise stabilized against erosion in a manner acceptable to the administrative authority.

7:9A-10.4 Specific requirements for soil replacement disposal field installations

(a) A soil replacement disposal field installation shall be made by installing the disposal bed or each individual disposal trench on top of or within suitable fill material which has been placed in an excavation made below the existing ground surface. In a bottom-lined installation, the fill material shall be placed below the disposal field only, as prescribed in (b) below. In a fill-enclosed installation, the fill shall be placed around the sides as well as below the disposal field, as prescribed in (c) below. The type of soil replacement disposal field installation required depends upon the soil limitations present and the slope across the disposal area as follows:

1. A fill-enclosed installation shall be required when:

- i. The limiting zone is a perched zone of saturation underlain by a hydraulically restrictive horizon and the slope across the disposal field is less than five percent;
- ii. The limiting zone is an excessively coarse horizon or substratum; or
- iii. The limiting zone is a fractured rock substratum.

2. A bottom-lined installation may be permitted where:

- i. The limiting zone is a hydraulically restrictive horizon and no perched zone of saturation is present; or
- ii. The limiting zone is a perched zone of saturation underlain by a hydraulically restrictive horizon and the slope across the disposal field is five percent or greater.

(b) Bottom-lined soil replacement disposal field installations shall be constructed as follows:

1. An excavation shall be made within the area occupied by the disposal bed or by each individual disposal trench and, where the limiting zone is a hydraulically restrictive horizon, the excavation(s) shall extend a minimum of two feet below the bottom of the hydraulically restrictive horizon.
2. The excavation shall be backfilled to the level of infiltration with suitable fill material.
3. The disposal field shall be constructed on top of the fill material within the excavation(s).
4. An interceptor drain designed and constructed as prescribed in N.J.A.C. 7:9A-10.7 shall be provided to divert away from the disposal field laterally moving ground water which may be perched above any hydraulically restrictive horizon penetrated by the excavation.

(c) Fill-enclosed soil replacement disposal field installations shall be constructed as follows:

1. An excavation shall be made to the required depth extending throughout the entire area to be occupied by the disposal field and beyond the perimeter of the disposal field a minimum of two feet in all directions. In cases where the limiting zone is a fractured rock substratum and a pit-bailing or basin flooding test has been

THIS IS A COURTESY COPY OF THIS RULE. ALL OF THE DEPARTMENT'S RULES ARE COMPILED IN TITLE 7 OF THE NEW JERSEY ADMINISTRATIVE CODE.

used to establish adequate permeability, the depth of the disposal field excavation shall be no less than the depth of the test pit.

2. The excavation shall be backfilled with suitable fill material.

3. The disposal field shall be constructed within the fill material so that the entire disposal bed or each individual trench is surrounded by a minimum of two feet of fill material on all sides.

(d) Requirements and restrictions relating to site regrading shall be the same as those prescribed for conventional installations in N.J.A.C. 7:9A-10.3(b).

(e) Excavation prior to the placement of fill material shall be carried out in accordance with the requirements of N.J.A.C. 7:9A-10.3(c)2 through 5.

(f) Fill material used in soil replacement disposal field installations shall meet the following requirements:

1. The fill material used below the disposal field shall meet the requirements for texture and permeability which are prescribed in N.J.A.C. 7:9A-10.1(f).

2. The minimum depth of fill below the disposal field shall be one foot.

3. Compaction of fill material shall be required whenever fill material is used below the disposal field and shall be carried out in accordance with the following requirements:

i. Compaction of fill shall be carried out as directed by a professional engineer and as indicated on the approved engineering design.

ii. Based upon a final inspection, a professional engineer shall certify by signature and seal that compaction of the fill has been performed adequately to prevent failure of any component of the system due to excessive settlement or differential settlement.

iii. Fill material shall be spread and compacted in layers one foot or less in thickness.

iv. Compaction may be accomplished manually or mechanically, by tamping or rolling, or by driving over the filled area in a controlled pattern using tracked or rubber-tired vehicles. Compaction may also be accomplished by puddling.

v. When heavy excavating equipment is operated within the excavation for the purpose of placement of compaction of the fill material, this equipment shall not be driven directly on the exposed bottom of the excavation. A minimum of one foot of fill material shall be maintained below the vehicle tracks or wheels at all times.

(g) Construction of the disposal field and distribution network shall be as prescribed for conventional installations in N.J.A.C. 7:9A-10.3(d).

(h) Filter material shall be as prescribed for conventional installations, in N.J.A.C. 7:9A-10.3(e).

(i) Backfill and final grading shall be as required in N.J.A.C. 7:9A-10.3(f) and shall extend a minimum of five feet, in all directions, beyond the perimeter of the filled area.

7:9A-10.5 Specific requirements for mounded disposal field installations

(a) A mounded disposal field installation shall be made by installing the disposal field as prescribed below, within suitable fill which has been placed above the existing ground surface.

(b) Requirements and restrictions relating to site regrading shall be the same as those prescribed for conventional installations in N.J.A.C. 7:9A-10.3(b).

(c) On sloping sites, the disposal field shall be elongated in shape with the long axis parallel to the topographic contour.

(d) Prior to placement of fill material, the ground surface shall be prepared as follows:

THIS IS A COURTESY COPY OF THIS RULE. ALL OF THE DEPARTMENT'S RULES ARE COMPILED IN TITLE 7 OF THE NEW JERSEY ADMINISTRATIVE CODE.

1. Excessive vegetation shall be cut and removed. Large trees including the stumps shall be removed. If large holes are left as a result of stump removal these shall be filled with fill material meeting the requirements of N.J.A.C. 7:9A-10.1(f)4.
2. The delivery pipe from the dosing tank shall be installed and the excavation backfilled and compacted prior to preparation of the ground surface for fill placement.
3. The area within the perimeter of the mound shall be plowed or disked to produce a thoroughly roughened surface. Plowing shall be done using a two bottom or larger moldboard plow or chisel plow and shall be parallel to the topographic contour in such a direction that each plow furrow will be thrown upslope. The soil should be broken-up to a depth of six to eight inches. Alternatively, a roto-tiller may be used provided that the surface soil is of sand or loamy sand texture.

(e) A mound shall be constructed by placing a layer of fill material over the ground within and adjacent to the area of the disposal field. The method of emplacement and lateral extent of the fill material shall be as follows:

1. The area of the fill layer shall include the area of the disposal field plus a lateral extension of fill material surrounding the disposal field on all sides.
2. The minimum required width of the lateral fill extension shall be 20 feet where gravity distribution is to be used and five feet where pressure distribution is to be used.
3. Within the area of the lateral fill extension, the top surface of the fill material shall be kept level with or higher than the invert of the distribution laterals.
4. On sloping sites, the width of the lateral fill extension may be reduced on the upslope side of the disposal field provided that the top surface of the fill material is kept level with or higher than the invert of the distribution laterals up until the point where the top surface of the fill material intersects with the existing slope.
5. At the outside edge of the lateral fill extension, the mound shall be terminated by sloping the top surface of the fill layer downward, or by providing a berm of soil material meeting the requirements of N.J.A.C. 7:9A-10.3(f)2 and 3, at a slope of three to one or less. Alternatively, lateral support for the fill layer may be provided by a retaining wall meeting the following requirements:

i. The retaining wall shall be designed and constructed in a manner that:

- (1) Prevents lateral movement or seepage of water through the retaining wall;
- (2) Ensures wall stability by including an adequate footing that accounts for the hydraulic forces of effluent and stormwater on the retaining wall and footing; and
- (3) Withstands hydrostatic pressure without the use of subsurface drainage mechanisms;

ii. The elevation of the top of the retaining wall shall be no lower than the elevation of the top of the filter material in the disposal area;

iii. The distance from any retaining wall to any property line must be at least the total height of the retaining wall;

iv. The retaining wall shall be designed by a New Jersey licensed professional engineer who shall certify, in accordance with N.J.A.C. 13:40-7 of the State Board of Professional Engineers and Land Surveyors rules, that the requirements of (e)5i through iii. above are met by the proposed design;

v. Construction of the retaining wall shall be supervised by the New Jersey licensed professional engineer; and

vi. The administrative authority shall not issue a certificate of compliance until an as-built plan has been prepared and certified by the New Jersey licensed professional engineer confirming that the retaining wall has been constructed in accordance with the approved design plan.

THIS IS A COURTESY COPY OF THIS RULE. ALL OF THE DEPARTMENT'S RULES ARE COMPILED IN TITLE 7 OF THE NEW JERSEY ADMINISTRATIVE CODE.

6. Fill material below the disposal field and within the area of the lateral fill extensions shall be suitable fill material meeting the requirements of N.J.A.C. 7:9A-10.1(f)4.

7. Compaction of fill shall be carried out as prescribed in N.J.A.C. 7:9A-10.4(f).

(f) Construction and installation of the disposal field and distribution network shall be as prescribed for conventional installations in N.J.A.C. 7:9A-10.3(d).

(g) Filter material shall be as prescribed for conventional installations in N.J.A.C. 7:9A-10.3(e).

(h) Backfill and final grading over the mound shall be completed as follows:

1. Immediately above the disposal field filter material which has been covered with a suitable barrier material, as prescribed in N.J.A.C. 7:9A-10.3(e)3, a layer of topsoil, suitable for establishment of a good vegetative cover, 12 to 18 inches in thickness at the center of the mound and six to 12 inches in thickness at the edges, shall be placed over the entire mound, covering the top and side slopes. The topsoil shall be build up thicker along the long axis of the mound so that a convex profile is produced parallel to the direction of the slope. The topsoil shall be lightly compacted by tamping or rolling to prevent settlement.

2. Immediately after completion of final grading, the mound surface shall be mulched and seeded, or sodded, to establish a good vegetative cover and to prevent erosion.

7:9A-10.6 Specific requirements for mounded soil replacement disposal field installations

(a) Mounded soil replacement disposal fields shall be constructed as follows:

1. An excavation shall be made to the required depth throughout the entire area of the disposal field and extended laterally in all directions a minimum of two feet beyond the perimeter of the disposal field.

2. This excavation shall be backfilled with suitable fill material and the fill material mounded up over the excavation to produce a mound of the desired height in which to install the disposal field.

3. The sides of the mound shall be constructed with slopes of three to one or less. Alternatively, lateral support for the fill layer may be provided by a retaining wall that meets the requirements described at N.J.A.C. 7:9A-10.5(e)5.

(b) Requirements and restrictions relating to site regrading shall be the same as those prescribed for conventional installations in N.J.A.C. 7:9A-10.3(b).

(c) Excavation prior to placement of fill material shall be carried out as specified in N.J.A.C. 7:9A-10.3(c)2 through 5.

(d) Fill material shall meet the requirements of N.J.A.C. 7:9A-10.4(d).

(e) Construction of the disposal field and distribution network shall be as prescribed for conventional installations in N.J.A.C. 7:9A-10.3(d).

(f) Filter material shall be as prescribed for conventional installations, in N.J.A.C. 7:9A-10.3(e).

(g) Backfill and final grading shall be as prescribed for mounded installations, in N.J.A.C. 7:9A-10.5(h).

7:9A-10.7 Interceptor drains

(a) Interceptor drains may be used on sloping sites to improve site suitability by intercepting laterally moving ground water which is perched above a hydraulically restrictive horizon provided that the requirements of (b) through (k) below are met.

(b) Interceptor drains shall be oriented parallel to the length and width of the disposal field and shall be installed on all sides except for the downslope side, as shown in Figure 25 of Appendix A.

THIS IS A COURTESY COPY OF THIS RULE. ALL OF THE DEPARTMENT'S RULES ARE COMPILED IN TITLE 7 OF THE NEW JERSEY ADMINISTRATIVE CODE.

(c) Interceptor drains designed to intercept ground water which is perched above a hydraulically restrictive horizon shall extend to the top but not through the entire thickness of the hydraulically restrictive horizon.

(d) The minimum distance between the disposal field and an interceptor drain shall be as prescribed in (d)1 and 2 below. The only exceptions to these requirements shall be where the bottom of the drain is at an elevation which is higher than the bottom of the disposal field or where the drain is set at the top of a restrictive horizon which is penetrated by the excavation for a soil replacement or mounded soil replacement installation, in which cases the minimum setback distance between the disposal field and the drain shall be 20 feet.

1. The minimum distance between a disposal field and any portion of an interceptor drain which is downslope of the disposal field shall be 50 feet.

2. The minimum distance between a disposal field and those portions of the interceptor drain which are upslope of the disposal field's downslope side shall be 50 feet unless a shorter distance is calculated using the formula given in (d)3 below. In no case shall this distance be less than 10 feet.

3. Calculate the minimum required horizontal separation distance, D , using the equation, $D = Q/(LKI^2)$, where:

Q is the volume of sanitary sewage, determined as prescribed in N.J.A.C. 7:9A-7.4, in gallons per day, multiplied by a unit conversion factor of $1 \text{ ft}^3/7.48 \text{ gallons}$.

L is the total length of the disposal field, in feet, measured parallel to the topographic contour.

K is the horizontal saturated permeability above the restrictive horizon, in inches per hour, determined as prescribed in N.J.A.C. 7:9A-6.5 or 6.6, multiplied by unit conversion factors of (1 foot/12 inches) and (24 hours/1 day).

I is the slope, in feet/foot, measured perpendicular to the topographic contour and described based on appropriately located subsurface explorations.

(e) Excavation shall be carried out as follows:

1. The excavation for the interceptor drain shall be made to the exact depth required in (c) above, a minimum two feet wide, and shall extend for the entire length of the drain, around the upslope side of the disposal field and down both ends of the field to the downslope side, as shown in Figure 25 of Appendix A.

2. To accommodate the drain discharge pipes, the excavation shall extend, on each end of the disposal field, beyond the extent of the drain, from the downslope side of the disposal field to free-flowing outlet meeting the requirements of (f) below.

3. The part of the excavation in which the drain discharge pipe will be laid shall have a slope which is steep enough to carry away the intercepted ground water.

(f) That portion of the excavation which will accommodate the drain shall be filled with filter material to a depth which is a minimum of one foot higher than the top of the perched zone of saturation which is to be drained. Filter material used for this purpose shall be washed gravel or crushed stone, free of fines, dust, ashes or clay, and shall conform in size and gradation with one of the following New Jersey Department of Transportation standard sizes for coarse aggregate as shown in Figure 26 of Appendix A: size number four, size number five, size number 56 or size number six.

(g) Barrier material shall consist of continuous layers of drainage fabric and shall be placed throughout the entire length of the drain, above, below and along the sides of the filter material. The following requirements shall be met:

1. The edges of adjacent sheets shall be overlapped by a minimum of six inches.

THIS IS A COURTESY COPY OF THIS RULE. ALL OF THE DEPARTMENT'S RULES ARE COMPILED IN TITLE 7 OF THE NEW JERSEY ADMINISTRATIVE CODE.

2. The type of drainage fabric used shall be specified in the engineering design and shall have adequate tensile strength to prevent ripping during installation and backfilling, adequate permeability to allow unimpeded passage of water, and adequate particle retention to prevent migration of soil particles into the filter material.

(h) Drainage pipe shall be laid throughout the entire length of the excavation and shall be placed immediately above the barrier material at the bottom of the excavation and midway between the sides. The type of drainage pipe used shall be as follows:

1. Upslope of the downslope side of the disposal field, where the excavation is filled with filter material, the pipe shall be perforated or laid with open joints.
2. Downslope of the downslope edge of the disposal field, and beyond the extent of the filter material, the pipe shall be non-perforated and laid with tight joints.
3. The size of the pipe shall be large enough to handle the expected amount of flow and in no case shall the pipe diameter be less than four inches.
4. Materials used for drainage pipe shall be as allowed in N.J.A.C. 7:9A-9.5(b).

(i) Free-flowing outlets shall be provided downslope of the drain, on each end of the disposal field. Outlets shall meet the following requirements:

1. Outlets may empty into a surface water body, a drainage swale discharging to a surface water body, a storm sewer, a groundwater recharge basin, a gravel bed, dedicated seepage pit, or dry well.
2. Outlets shall be designed, constructed, located and maintained in a manner which does not cause soil erosion, surface flooding or damage to adjacent properties, does not create a public nuisance, and does not violate any applicable Federal, State or local laws or regulations.
3. Adequate measures shall be taken to protect each outlet from entry of rodents or other small animals.

(j) Backfill over the drain and the drain discharge pipes shall be of earth similar to that found at the site and free of large stones, broken masonry, stumps or other waste construction material.

(k) Where an interceptor drain is proposed to divert laterally moving perched ground water away from the area of the disposal field, the drain shall be installed and its satisfactory performance confirmed prior to granting of final approval, as follows.

1. After installation of the drain has been completed, borings or pits shall be excavated to the top of (but not penetrating) the hydraulically restrictive horizon, hydraulically restrictive substratum or massive rock substratum above which the perched zone of saturation is located. This shall be done on the upslope and downslope sides of the drain and during a time of year when the presence of the perched zone of saturation is anticipated. Piezometers may also be used for this purpose provided that they do not penetrate through the hydraulically restrictive horizon and provided that the requirements of N.J.A.C. 7:9A-5.9(e) are met.
2. The drain shall be considered to be performing adequately if no perched zone of saturation is observed on the downslope side of the drain at the same time that a perched zone of saturation is observed on the upslope side of the drain. This test shall be witnessed by the administrative authority or its authorized agent.

7:9A-10.8 Specific requirements for drip dispersal

(a) The Department shall maintain a list of system integrators that may offer drip dispersal systems that may be used in lieu of the disposal field installation options identified in N.J.A.C. 7:9A-10.1. The following are the requirements for system integrators of systems that wish to be listed by the Department for the incorporation of their drip dispersal designs:

1. All drip tubing and drip emitters shall be wastewater rated, designed to prevent root intrusion, include biologic barriers, and be used in a manner consistent with all manufacturer requirements and recommendations for systems designed, constructed and operated in accordance with this chapter.

THIS IS A COURTESY COPY OF THIS RULE. ALL OF THE DEPARTMENT'S RULES ARE COMPILED IN TITLE 7 OF THE NEW JERSEY ADMINISTRATIVE CODE.

2. Any drip dispersal technology system integrator that wishes to be listed shall submit to the Department a written request and copies of their pre-engineered designs, including advanced wastewater pretreatment, that have been certified by the system integrator to be appropriate for drip dispersal systems designed, constructed, operated and maintained in accordance with this chapter.
3. Listed system integrators shall make available up-to-date training, design, installation and maintenance manuals and materials to any administrative authority or the Department upon request.
4. All drip dispersal technology manufacturers and system integrators must comply with all applicable requirements of this chapter.

(b) Drip dispersal systems must be designed by a septic system designer sufficiently knowledgeable of the drip dispersal system they are proposing to include in the design. The system designer shall certify on the plans that they are sufficiently knowledgeable of the technologies to design the system being proposed. The septic system designer shall provide for the following minimum general design requirements:

1. Drip dispersal systems must be preceded by an advanced wastewater pretreatment device that meets the criteria specified at N.J.A.C. 7:9A-8.3. Septic tank effluent shall not be discharged to a drip dispersal system.
2. Only drip tubing that is warranted fully by the manufacturer for protection against root intrusion for a minimum period of 10 years from installation shall be specified in the design. The warranty must be fully transferable but may be limited to provide requirements for operation and maintenance of the system in conformance with manufacturer requirements.
3. Drip dispersal system designs shall specify that the system shall be installed by an authorized installer in accordance with all requirements of this chapter. The specifications shall include that the authorized installer shall provide the property owner with a copy of all operation and maintenance manuals and the service contract. The specifications shall also instruct the authorized installer to obtain the property owner's written acknowledgement of the need to comply with the provisions of these documents and N.J.A.C. 7:9A-12.3 prior to initiating the installation of any drip dispersal system. Copies of these documents shall be submitted to the administrative authority or the Department upon request.
4. Permeability testing for systems including drip dispersal shall be completed in the soil horizon in which the drip tubing will be installed and shall include percolation tests in accordance with N.J.A.C. 7:9A-6 whenever possible.
5. Drip dispersal systems shall have a minimum vertical separation distance of 24 inches from the point of infiltration (tubing installation depth) to a limiting zone. An additional zone of disposal is not required for drip dispersal systems.
6. Drip dispersal systems shall not be installed in areas where the existing ground surface contains slopes of more than 25 percent. Where the existing ground surface contains slopes greater than 10 percent, drip tubing installations must be hand dug unless the septic system designer certifies a method of installation that provides for measures to protect human health and safety, meets dripperline manufacturer and system integrator requirements and satisfies all concerns of the administrative authority.
7. Drip dispersal systems shall not be installed in areas where the depth to any limiting zone below the existing ground surface is less than 24 inches. Dripperlines shall be located and maintained between a minimum of six inches to a maximum of 12 inches below final grade.
8. The entire system is to be configured as a complete pre-engineered package from a system integrator consisting of, at minimum, an advanced wastewater pretreatment device identified in N.J.A.C. 7:9A-8.3, drip tubing, specialized field fittings, pump/pump chamber components, a filtration unit, headworks, and a control panel as specified in this chapter. All piping, valves, fittings, level control switches, and other components shall be designed and manufactured to resist the corrosive effects of wastewater and common household chemicals.

THIS IS A COURTESY COPY OF THIS RULE. ALL OF THE DEPARTMENT'S RULES ARE COMPILED IN TITLE 7 OF THE NEW JERSEY ADMINISTRATIVE CODE.

9. Minimum required separation distances from drip dispersal areas shall be the same as those specified for disposal fields in N.J.A.C. 7:9A-4.3.

10. Permanent corner markers shall be installed at or above grade to identify the extent of the drip dispersal area.

11. The design shall note that the drip dispersal system shall be maintained according to the maintenance requirements at N.J.A.C. 7:9A-12.3.

(c) The septic system designer shall provide for the following minimum design requirements for the drip tubing layout:

1. All drip dispersal systems shall be equipped with pressure compensating emitters rated for use with wastewater. The discharge rate of any two emitters shall not vary by more than 10 percent in order to ensure that the effluent is uniformly distributed over the entire drip field or zone. Emitter separation along the tubing length shall be placed in the dripperlines on two-foot intervals.

2. The distance between dripperlines shall not exceed two feet, except to preserve existing vegetation such as large trees. The dripperlines shall be laid level as possible and shall run with the contour. The maximum lateral length of a dripperline, measured from supply to return manifolds, shall be specified by the septic system designer in accordance with dripperline manufacturer and/or system integrator recommendations.

3. The field shall be sized according to the area loading rate given in Table 10.8 below. The minimum amount of tubing required is the area divided by two (based on a two-foot center). For example, based on 60 minutes per inch (mpi), $500 \text{ gpd} / 0.154 \text{ gal/ft}^2/\text{day} = 3,247 \text{ ft}^2$ of area, $3,247 \text{ ft}^2$ of area /two-foot center = 1,624 feet of tubing, an area approximately 102 feet by 32 feet would be required. Septic system designers may specify lesser or greater tubing separation depending on the specific site conditions such as to account for vegetation. However, the minimum tubing length must be provided. A minimum of two zones is recommended. In the case of smaller drip dispersal areas, and in consideration of a system integrator's minimum zone size, single zone systems, and/or closer drip tubing and/or drip emitter spacing may be permissible.

4. Drip lines may be installed below the soil surface using a vibratory plow, a standard trencher (maximum six-inch width), or by manual or hand installation to a maximum depth of 12 inches from the soil surface, with six to eight inches being the optimum installation depth. Cable pullers must not be used where the tubing installation depth is within three inches of clay loam and clay texture or the soil contains particles that exceed 75 mm in diameter. Other methods of installation may be considered by the administrative authority. Drip tubing is prohibited in standard backhoe trenches, except for systems designed as provided in (c)7 below. Installations of drip dispersal systems are additionally subject to the following:

i. The dripperline shall be installed by a method that will prevent pulling, stretching, or crimping of the dripperline, and smearing, compaction, or altering of the soil texture. The method shall be acceptable to the dripperline manufacturer, system integrator and specified in the proposed design.

ii. Drip tubing shall not be installed during unsuitable soil moisture conditions. In soil textures other than sands or loamy sands, drip tubing installation shall not be carried out when the soil moisture content is above the lower plastic limit from the surface of the ground to 12 inches below the proposed tubing installation depth. To identify this limitation, when a small lump of soil, taken within the above depth, can be rolled out with the fingers to form a wire or rod, one-eighth of an inch in thickness, and does not crumble when handled, the soil is too wet to proceed with the installation.

iii. On sites where vegetation will be removed, methods to minimize soil disturbance must be used. Any soil disturbance below four inches from the ground surface shall be backfilled with fill material meeting the specifications of N.J.A.C. 7:9A-10.1(f)4. Additional fill material and/or topsoil may be used, provided the drip tubing will be installed with at least two inches of specified fill above the drip tubing. The fill material must be applied in shallow layers no greater than six inches in thickness and installed in a manner

THIS IS A COURTESY COPY OF THIS RULE. ALL OF THE DEPARTMENT'S RULES ARE COMPILED IN TITLE 7 OF THE NEW JERSEY ADMINISTRATIVE CODE.

established by the manufacturer and/or system integrator to prevent an abrupt textural interface with the native soil.

iv. All system control units, valve boxes, drip dispersal lines, conveyance lines and other system appurtenances shall be designed and installed to prevent freezing in accordance with the system integrator and dripperline manufacturer recommendations.

v. Both the septic system designer and/or a system integrator's representative may be required by the administrative authority to conduct a final construction inspection and/or certify that as-built conditions are in conformance with the approved system design and/or submit as-built plans.

5. All drip dispersal systems shall be designed with devices such as check valves, piping configurations, or methods such as elevated loops to prevent the redistribution of effluent at pump shut off by gravity in the dispersal area. The device shall additionally minimize the effluent remaining in the lines after the end of a dose cycle from redistribution to lower portions of the drip zone. Variability in distribution shall never exceed 10 percent.

6. The system integrator shall make available in their pre-engineered design head loss charts, tables and/or formulas, for the filtration headworks and for various drip tubing lateral lengths, during a dosing and flushing cycle, and other pertinent information such as minimum/maximum zone size for the proper dosing and flushing of the drip dispersal system. The minimum scouring/flushing velocity (no less than two feet per second) for the distal end of the drip tubing lateral and minimum and maximum operating pressures shall be provided.

7. The following are the requirements for mounded soil replacement drip dispersal designs:

i. In addition to the applicable requirements of this section, mounded soil replacement drip dispersal systems shall require a minimum soil depth of 24 inches from the existing ground surface to any limiting condition and shall not be used at sites where there is a 36-inch or more depth to a limiting zone where a non-mounded drip dispersal system can be designed, as described in this section.

ii. Undisturbed soil and the depth of dispersal are to be maximized below the bed bottom but in no case are to be less than 12 inches in thickness. The minimum depth of soil excavation for fill material depth is to be four inches. In all cases, the fill material is to be mounded, extending a minimum of six inches above grade to provide a minimum of 24 inches of separation, fill material and soil, to a limiting zone. Fill material must extend above the dripperlines by at least two inches. Fill material must be installed in accordance with the system integrator and dripperline manufacturer requirements and recommendations to prevent an abrupt textural interface with native soil.

iii. The bed bottom is to be installed level. The length to width ratio of the bed(s) is to be maximized as the site allows. In no case shall the length to width ratio be less than 3:1. The use of two or more narrow beds to maintain the required minimum depth to a limiting condition and geometry may be necessary. One bed may be possible on sites where the existing ground surface is flat across the entire area required for the bed however, re-grading shall not be allowed in any case. The minimum separation between beds (sidewall to sidewall) is to be six feet of native soil material.

iv. Permeability testing must be conducted in the most hydraulically restrictive zone within the 24 inches of native soil below the proposed bottom of the fill material. The permeability of the fill material shall not be used to size the drip dispersal area.

v. The bed bottom loading rate for mounded soil replacement drip dispersal designs shall be sized in accordance with the area loading rate in Table 10.8 below multiplied by three. For example, based on 60 mpi, Table 10.8 provides for a 0.154 gal/ft²/day area loading rate $\times 3 = 0.462$ gal/ft²/day for the bed loading rate. For a three-bedroom home, $500 \text{ gpd} / 0.462 = 1,083 \text{ ft}^2$ of bed bottom required. If there is 45 feet of available length (contour) the bed would be approximately 45 feet by 24 feet (1,083 ft² of bed bottom / 45 feet) representing a ratio of approximately 2:1. Two beds, each 45 feet by 12 feet, and

THIS IS A COURTESY COPY OF THIS RULE. ALL OF THE DEPARTMENT'S RULES ARE COMPILED IN TITLE 7 OF THE NEW JERSEY ADMINISTRATIVE CODE.

separated by a minimum of six feet, would be required, representing a ratio of 3.75:1 per bed. In the case of these smaller dispersal areas, and in consideration of a system provider's minimum zone size, single zone systems, and/or closer tubing spacing (typically twelve inches or less) may be indicated. In no case shall the total area of the drip dispersal bed(s) be less than 400 square feet.

vi. An additional lateral fill extension is not required. The minimum distance from the edge of the fill bed to any drip line is to be one foot. Tubing separation over the soil replacement bed may be less (with a minimum separation of 0.5 feet) to accommodate minimum zone sizes in accordance with manufacturer's recommendations. The drip tubing is to be covered with a minimum two inches of additional fill material. Drainage fabric, in accordance with the requirements of N.J.A.C. 7:9A-10.3(e)3, shall then be placed over the additional fill material covering the drip tubing.

vii. If the permeability of the zone of disposal for a soil replacement system is greater than 20 inches per hour, the septic system designer shall use a design value of six inches per hour for the purposes of designing the drip dispersal field. For areas where only a basin flood test is possible, permeability shall be established pursuant to N.J.A.C. 7:9A-6.7(f) provided percolation testing or tube permeameter testing is completed in the fill material after emplacement and compaction of the material and the testing demonstrates a permeability greater than six inches per hour.

viii. All other considerations regarding the design of a mounded soil replacement drip dispersal system shall be in conformance with N.J.A.C. 7:9A-10.6.

(d) The septic system designer shall provide for the following minimum dosing design requirements:

1. Each drip dispersal field or zone shall be time-dosed at regular intervals, throughout the day, at an average flow/peak design flow dose regime, as specified by the system integrator or the septic system designer if a dosing regime is not specified by the system integrator, in a manner that avoids soil saturation. The system control panel shall include a controller that shall provide for a zone to be "rested" or taken "out of service" manually. The controller shall have the capability to bypass the zone(s) that have been taken out of service and dose the next available zone with normal sequence continuation. The following requirements are additionally applicable to the dosing of a drip dispersal system:

i. Mechanical indexing valves to control zone dosing are prohibited.

ii. To maintain uniform distribution, the minimum drip dose volume in a drip dispersal network is calculated using 80 percent of the dose being dispersed during times of equal distribution, accounting for pressurization time and redistribution at pump shut off. In no case shall the minimum drip dose volume be less than three times the volume of the pipe (plus the volume of supply/return lines and field manifolds where applicable).

2. A dosing chamber shall be employed after the advanced wastewater pretreatment device and before the drip dispersal system, and shall be sized and equipped so as to permit timed dosing of the daily sanitary sewage flow with adequate reserve storage capacity for those times when the system is inoperable. The system design shall comply with the following:

i. The dosing chamber working volume (surge storage) shall be a minimum 60 percent of the design volume. This volume may be calculated from the timer enable to the high water alarm floats. These dosing tanks may be less than 1,000 gallons.

ii. The dosing chamber shall be equipped with an audible and visual high-water alarm set to provide reserve capacity to allow for the prompt repair of the system. The minimum amount of reserve volume above the high water alarm is 25 percent of the design volume. A low-water separate cutoff device (float) shall be provided to prevent damage to the pump during low-water conditions and shall be separate from the timer enable device (float).

iii. The dosing chamber shall be fitted with watertight access risers to grade that are secured against unauthorized entry.

THIS IS A COURTESY COPY OF THIS RULE. ALL OF THE DEPARTMENT'S RULES ARE COMPILED IN TITLE 7 OF THE NEW JERSEY ADMINISTRATIVE CODE.

iv. All other aspects of the dosing chambers shall meet the minimum requirements for dosing tanks specified in N.J.A.C. 7:9A-9.2.

3. The system design shall provide the means, at minimum, to accurately calculate flows, count pump cycles, determine pump elapsed time, count automated flushing events and report alarm events. This requirement may be accomplished by having a flow meter and a control panel that performs these functions. These functions are necessary to provide proper operation and maintenance and to determine and monitor emitter performance, scouring or flushing performance, and water use. The system control panel and associated controllers shall also include:

- i. A programmable timer to regulate dosing frequency/volume and record dosing information.
- ii. Manual capability to operationally determine filter flushing, dosing, and flushing.
- iii. Components that are restricted to those that are UL Listed.
- iv. A schematic and manual shall be provided to the homeowner with control panel.
- v. Telemetry or an auto dialer for alarm conditions related to the drip dispersal components in addition to those required at N.J.A.C. 7:9A-8.3(b)6.
- vi. Electrical control equipment shall be mounted within a NEMA 4X rated enclosure with a rigid latching door.
- vii. Switches shall be clearly identified, and all internal wiring shall be factory installed.

(e) The septic system designer shall provide for the following minimum filtration and field flushing design requirements:

1. Final filtration must be provided by a hydraulic unit fitted with in-line screen or disk filter(s) to remove suspended solids to prevent clogging of the emitters.
 - i. The filter(s) shall achieve the drip tubing manufacturer's minimum specified filtration at a rate equal to or greater than the peak discharge rate, typically during network forward flushing.
 - ii. The filter(s) shall be washed automatically on a routine basis as specified by the system integrator, normally at the beginning of each dose event.
 - iii. The system shall be designed to return filter and drip tubing flush residuals to the head of the pretreatment train or a settling tank to allow for primary settling prior to the dosing station.
 - iv. The filter and drip tubing flush return volume shall not exceed the hydraulic capacity of the pretreatment device.
 - v. The hydraulic unit (and other components) must be protected from temperatures below freezing in accordance with the manufacturer's specifications.
2. The system shall be capable of forward flushing each drip field or zone at a minimum fluid velocity, as required by the manufacturer of the dripperline and the system integrator.
 - i. The fluid velocity shall be no less than two feet per second.
 - ii. The residuals shall be returned back to the head of the pre-treatment train or if site design allows, a separate settling tank to allow for primary settling prior to a dosing station.
 - iii. Field flushing velocity shall be designed to be met at the distal end of each lateral connection.
 - iv. Each zone shall be automatically flushed a minimum of once every 50 cycles. However, the flush return volume shall not exceed the hydraulic capacity of the advanced wastewater pretreatment device.
3. Pump selection shall take account of the operating volume and pressure for the drip dispersal field when calculating the total dynamic head required for filter flushing and/or back flushing, field dosing, and

THIS IS A COURTESY COPY OF THIS RULE. ALL OF THE DEPARTMENT'S RULES ARE COMPILED IN TITLE 7 OF THE NEW JERSEY ADMINISTRATIVE CODE.

dripperline flushing. All disposal and flushing parameters shall meet the listed system integrator's requirements and fall within the operational range of the pump selected.

TABLE 10.8 DRIP DISPERSAL AREA LOADING RATES

Percolation Rate	Area Loading Rate
Mpi	gal/ft²/day
5	0.303
10	0.278
15	0.253
20	0.228
25	0.211
30	0.203
35	0.196
40	0.189
45	0.180
50	0.173
55	0.162
60	0.154

Subchapter 11. Seepage Pits

7:9A-11.1 Site/soil requirements

(a) Seepage pits shall not be approved except as specified in N.J.A.C. 7:9A-7.6. When a seepage pit is approved, the following site/soil requirements shall be met:

1. The bottom of any seepage pit shall be a minimum of eight feet above any hydraulically restrictive horizon or substratum not fully penetrated or any massive rock substratum.
2. The bottom of any seepage pit shall be a minimum of four feet above any fractured rock substratum.
3. The bottom of any seepage pit shall be a minimum of four feet above the level of the seasonally high water table.

7:9A-11.2 Design requirements

(a) The percolating area shall be considered to be the total outside surface of the seepage pit lining below the inlet and exclusive of any soil horizons with a percolation rate slower than 40 minutes per inch. The bottom of the seepage pit shall not be counted as part of the percolating area.

(b) The minimum required percolating area for dwelling units shall be determined from the following table, based upon a weighted average, of the percolation rates of all the soil layers exposed in the sidewalls, determined as prescribed in N.J.A.C. 7:9A-6.4(f)4. In no case, however, shall the percolating area be less than 110 square feet per dwelling unit.

THIS IS A COURTESY COPY OF THIS RULE. ALL OF THE DEPARTMENT'S RULES ARE COMPILED IN TITLE 7 OF THE NEW JERSEY ADMINISTRATIVE CODE.

Average Percolation Rate (Min/inch)	Minimum Area Per Bedroom Per Day (Square feet)
10 or less	72
11-20	108
21-30	144
31-40	180
over 40	not acceptable

(c) The minimum percolating area for facilities other than individual dwellings shall be determined from the following table based upon the volume of sanitary sewage, determined as prescribed in N.J.A.C. 7:9A-7.4, and a weighted average of the percolation rates of all soil layers exposed in the sidewalls, determined as prescribed in N.J.A.C. 7:9A-6.4(f)4. In no case, however, shall the percolating area be less than 110 square feet.

Average Percolation Rate (Min/inch)	Minimum Area Per Gallon Per Day (Square feet)
10 or less	0.48
11-20	0.72
21-30	0.96
31-40	1.20
over 40	not acceptable

7:9A-11.3 Construction requirements

(a) Seepage pits shall be constructed within an excavation affording adequate working space and shall be constructed of stone, brick, cinder, precast concrete or concrete block, or similar material laid dry with open joints where permeable strata has been penetrated, except that if the seepage pit is not of circular construction or if the surrounding ground is subject to cave-in, all horizontal joints shall be mortared in such a manner as to prevent structural failure. The following requirements shall be met:

1. All joints above the inlet, in all cases, shall be made water-tight.
2. Before placement of backfill, all sidewall areas shall be scarified.
3. The bottom of the seepage pit shall be filled with coarse gravel to a depth of one foot unless the bottom is in a sand or gravel formation.

(b) Seepage pits shall be backfilled according to the following procedure:

1. The space between the excavation and the seepage pit wall shall be backfilled with at least three inches of coarse gravel or filter material meeting the requirements of N.J.A.C. 7:9A-10.3(e)2.
2. Where cinder or concrete blocks are laid with core openings exposed, the space between the excavation and seepage pit wall shall be backfilled with at least six inches of two and one-half inch crushed stone or gravel.
3. Backfill above the inlet shall be as required for disposal fields in N.J.A.C. 7:9A-10.3(f)2 and shall be thoroughly compacted by hand or mechanical tamping methods. The use of heavy machinery for this purpose is prohibited.

THIS IS A COURTESY COPY OF THIS RULE. ALL OF THE DEPARTMENT'S RULES ARE COMPILED IN TITLE 7 OF THE NEW JERSEY ADMINISTRATIVE CODE.

(c) Covers shall be constructed of reinforced concrete, shall be a minimum of three inches in thickness, water-tight, and shall be designed and constructed so as not to be damaged by any load which is likely to be placed upon them.

(d) At least one access opening with a removable water-tight cover and a minimum dimension of 24 inches shall be provided. Access openings shall meet the following requirements:

1. Access shall be adequate to permit pumping out of the pit as well as inspection and maintenance of the inlet.
2. When the cover of the seepage pit is deeper than 12 inches below finished grade, the access opening shall be extended to within 12 inches of finished grade by means of a concrete riser with a cast-iron manhole cover.
3. When the access opening is below finished grade, a permanent marker at finished grade shall be provided to indicate its location.
4. When the access opening is at or above finished grade, the cover shall be bolted, locked or otherwise secured to prevent access by children.

Subchapter 12. Operation and Maintenance

7:9A-12.1 System use

(a) The individual subsurface sewage disposal system shall be used only for the disposal of wastes of the type and origin provided for in the approved engineering design. No permanent or temporary connection shall be made to any other source of wastes, wastewater or clean water. This prohibition does not apply to those plumbing fixtures which are normally present within the type of facility indicated in the approved engineering design, such as air conditioning condensate, heating system condensate and water softener backwash.

(b) Drainage from basement floors, footings or roofs shall not enter the individual subsurface sewage disposal system and shall be diverted away from the area of the disposal field.

(c) As set forth in N.J.S.A. 58:10A-17, no person shall use or introduce or cause any other person to use or introduce into any individual subsurface sewage disposal system any sewage system cleaner containing any restricted chemical material.

(d) Disposal of materials containing toxic substances into an individual subsurface sewage disposal system is prohibited. Material containing toxic substances include, but are not limited to, waste oil (other than cooking oil), oil-based or acrylic paints, varnishes, photographic solutions, pesticides, insecticides, paint thinners, organic solvents or degreasers and drain-openers.

(e) Inert or non-biodegradable substances shall not be disposed of in the individual subsurface sewage disposal system. Such substances include, but are not limited to, disposable diapers containing plastic, cat box litter, coffee grounds, cigarette filters, sanitary napkins, facial tissues and wet-strength paper towels.

(f) Large quantities of cooking greases or fats shall not be discharged into systems not equipped with a grease trap designed and constructed as prescribed in N.J.A.C. 7:9A-8.1.

(g) Major plumbing leaks shall be repaired promptly to prevent hydraulic overloading of the system.

7:9A-12.2 System maintenance

(a) The individual subsurface sewage disposal system shall be maintained in accordance with this chapter, the system approval issued by the administrative authority, and any applicable mandatory maintenance program including, but not limited, to any applicable ordinance adopted in accordance with N.J.A.C. 7:9A-3.1 or 7:15-5.25(e), by the system owner, or a qualified professional retained by the system owner in order to prevent the system from malfunctioning and/or becoming non-compliant as defined in N.J.A.C. 7:9A-3.4.

THIS IS A COURTESY COPY OF THIS RULE. ALL OF THE DEPARTMENT'S RULES ARE COMPILED IN TITLE 7 OF THE NEW JERSEY ADMINISTRATIVE CODE.

- (b) Maintenance activities shall include, but not be limited to, inspection of the septic tank or other pre-treatment units, the distribution box and connecting pipes, and the disposal field as well as scheduled pump-outs of the septic tank. Maintenance activities shall be conducted in a manner consistent with this chapter, the approval issued by the local administrative authority and any applicable mandatory maintenance program as described in (a) above. Upon detection, all potentially non-compliant systems shall be reported to the administrative authority in accordance with N.J.A.C. 7:9A-3.4. Septic effluent filters shall be maintained in such a way to prevent solids, scum or floatables from entering the effluent distribution network and disposal field.
- (c) The Department recommends the use of the applicable sections of the inspection protocol established in N.J.A.C. 7:9A-12.6 for inspecting any portion of a system during maintenance activities.
- (d) Systems approved by a treatment works approval shall be maintained in accordance with conditions specified in that approval.
- (e) Any system not maintained in accordance with this section shall be deemed non-compliant in accordance with N.J.A.C. 7:9A-3.4.

7:9A-12.3 Maintenance and monitoring requirements for systems incorporating advanced wastewater pretreatment devices

- (a) The owner of a system that includes an advanced wastewater pretreatment device, including all drip dispersal systems, shall have in place a service contract, throughout the life of the system, with an authorized service provider. A current service contract signed by the property owner and an authorized service provider must be in place prior to issuance of any certificate of compliance, any occupancy permit, or any sign off by the administrative authority required for the issuance of any construction application, applied for after the installation of the advanced wastewater pretreatment device, to a municipality pursuant to N.J.S.A. 58:11-25.
- (b) Failure to be in possession of a valid service contract shall constitute a violation of the Water Pollution Control Act, N.J.S.A. 58:10A-1 et seq. and a noncompliance violation of N.J.A.C. 7:9A-3.4. Each day the property owner fails have in place a valid service contract shall constitute a separate and distinct violation.
- (c) Upon expiration of a service contract, a new contract, which shall be at least one year in duration, shall be entered into by the property owner with an authorized service provider. If the property owner chooses to enter into a service contract with a different authorized service provider than under the expiring contract, a copy of the new, fully-executed service contract shall be submitted to the administrative authority by the property owner within 14 days after the expiration of the previous contract. The new service contract must demonstrate that service for the system under an authorized service provider has been continuous.
- (d) If a property owner fails to renew the service contract, the authorized service provider shall provide written notification of the service contract expiration within 30 days after the expiration to the administrative authority.
- (e) The following are the requirements for an authorized service provider:
 1. All advanced wastewater pretreatment devices and drip dispersal systems shall be maintained according to the manufacturer's/system integrator's maintenance requirements. Current maintenance manuals shall be obtained by the authorized service provider prior to performing maintenance.
 2. Advanced wastewater pretreatment devices and drip dispersal systems shall be inspected by an authorized service provider on the following schedule, at a minimum:
 - i. Once within 30 days following system startup;
 - ii. Subsequent to initial inspection under (e)2i above, twice per year for the first two years of system operation, once per year thereafter;
 - iii. At the time of transfer of the property with the new system owner; and

THIS IS A COURTESY COPY OF THIS RULE. ALL OF THE DEPARTMENT'S RULES ARE COMPILED IN TITLE 7 OF THE NEW JERSEY ADMINISTRATIVE CODE.

- iv. Inspections shall be conducted on a more frequent basis if required by the manufacturer or system integrator, as applicable.
- 3. All inspection results shall be recorded on an inspection form, copies of which shall be made available by the manufacturer/system integrator. The forms must be signed by the authorized service provider and shall be submitted to the administrative authority within 30 days after the inspection. Online access or electronic submission of the data may be substituted for the physical form, at the administrative authority's discretion.
- 4. At each regularly scheduled maintenance visit the authorized service provider shall, at minimum, observe, monitor and record:
 - i. The wastewater level in the tanks;
 - ii. Any effluent/pump filter for clogging and clean as needed;
 - iii. Clarity in NTUs;
 - iv. The final effluent for odor;
 - v. All tanks for oily film;
 - vi. All tanks for foam;
 - vii. The pH of final effluent;
 - viii. The ponding of effluent around the advanced wastewater pretreatment device and/or disposal area;
 - ix. Pump cycle and run time meters;
 - x. The condition of drip dispersal system headworks and filters and service as needed; and
 - xi. Any other requirement established by the manufacturer or system integrator.
- 5. At least once per year the authorized service provider shall, at a minimum:
 - i. Measure the sludge and scum levels in the septic tank and notify the homeowner if the tank is in need of pumping; and
 - ii. Check the effluent filter for clogging and clean it, as needed.
- 6. The authorized service provider shall have proper equipment and training to access and program any system control panel on site.
- 7. The authorized service provider shall monitor the telemetry control panel or auto dialer alarms required by N.J.A.C. 7:9A-8.3(b)6 and respond to any alarm condition in the manner specified by the manufacturer of the advanced wastewater pretreatment device and/or system integrator of a drip dispersal system.

7:9A-12.4 [Reserved]

7:9A-12.5 [Reserved]

7:9A-12.6 System inspection protocol for inspections conducted during real property transfer

- (a) To be a Department recognized method of inspection, a septic system inspector shall conduct all system inspections for a transfer of real property in accordance with this section and the protocol described in chapter Appendix E, incorporated herein by reference.
- (b) Septic system inspectors shall follow all inspection requirements established by the manufacturer of a product used in lieu of laterals and/or filter material pursuant to N.J.A.C. 7:9A-9.8, advanced wastewater pretreatment device used pursuant to N.J.A.C. 7:9A-8.3, or system integrator of a drip dispersal system used pursuant to N.J.A.C. 7:9A-10.8, as applicable, in addition to the protocol in chapter Appendix E.

THIS IS A COURTESY COPY OF THIS RULE. ALL OF THE DEPARTMENT'S RULES ARE COMPILED IN TITLE 7 OF THE NEW JERSEY ADMINISTRATIVE CODE.

(c) The septic system inspector shall describe all observations as to the condition of a system during an inspection without the use of the terms "malfunctioning", "failure" or "non-compliant". A system may only be classified as "malfunctioning", "failure" or "non-compliant" by the administrative authority or the Department in accordance with N.J.A.C. 7:9A-3.4(d).

(d) The septic system inspector shall report the results of inspections to the administrative authority in accordance with the following:

1. An initial report shall be made within 24 hours after the inspection by telephone, facsimile, e-mail or another means by which delivery can be verified when any of the conditions identified in the "Health Department Reporting" section of chapter Appendix F is observed; and
2. The completed chapter Appendix F Onsite System Inspection Form, incorporated herein by reference, shall be provided within 10 business days after the system inspection is completed.

(e) In addition to the Onsite System Inspection Form in chapter Appendix F, the septic system inspector shall provide a written analysis of the possible effects of the precipitation event or snow melt on the results of the inspection when inspections are conducted within 48 hours after a precipitation event or snow melt.

(f) The Department's inspection protocol technical manual detailing the methods for conducting an inspection in accordance with the protocol in chapter Appendix E is available through the Department at the address listed in N.J.A.C. 7:9A-3.9.

(g) The inspection form in chapter Appendix F is not applicable to cesspools, privies, outhouses, pit toilets or latrines. When the septic system inspector identifies such sanitary sewage disposal units, the presence of the unit shall be reported to the administrative authority in writing within 48 hours of the inspection. The septic system inspector shall additionally notify their client of the requirements of N.J.A.C. 7:9A-3.16(b).

7:9A-12.7 System testing

No person shall test an individual subsurface sewage disposal system in a manner that will adversely affect the functioning of the system. Hydraulic loading shall not be applied in excess of the design flow capacity of the septic tank and/or grease trap unless all solids have been removed from the septic tank and/or grease trap prior to testing or unless the hydraulic loading is applied at a point that will bypass the septic tank and/or grease trap. All testing of operating systems which requires a hydraulic loading which is in excess of the design flow shall be performed under the supervision of a licensed professional engineer.

7:9A-12.8 Abandoned systems

(a) When it is necessary to abandon a system or components of a system in place for any reason other than connection to a sanitary sewer line, all septic tanks, dosing tanks, seepage pits, dry wells and cesspools which are to be abandoned shall be emptied of wastes and filled completely with gravel, stones or soil material in a manner which is acceptable to the administrative authority. In cases where the individual subsurface sewage disposal system, or components thereof, is being abandoned due to the connection of the facility to a sanitary sewer line, the local plumbing inspector shall ensure the system is abandoned in accordance with the requirements of this section.

(b) Gravel filter material, fill material, soil or other similar material from an abandoned individual subsurface sewage disposal system that is removed from the ground shall be managed as follows:

1. If the abandoned system served single family or multi-family dwelling unit(s), the material shall be either:
 - i. Placed into trenches or pits excavated on the property and covered using the soil removed during the excavation of the trenches or pits; or
 - ii. Disposed of, or reused beneficially, in accordance with the New Jersey Solid Waste Management Act, N.J.S.A. 13:1E-1 et seq., and implementing rules at N.J.A.C. 7:26; or

THIS IS A COURTESY COPY OF THIS RULE. ALL OF THE DEPARTMENT'S RULES ARE COMPILED IN TITLE 7 OF THE NEW JERSEY ADMINISTRATIVE CODE.

2. If the abandoned system served a commercial, industrial or any facility other than single family or multi-family dwelling unit(s), the material shall be disposed of, or reused beneficially, in accordance with the New Jersey Solid Waste Management Act, N.J.S.A. 13:1E-1 et seq., and implementing rules at N.J.A.C. 7:26.

(c) Any system components, other than the material described at (b) above, from an abandoned individual subsurface sewage disposal system that are removed from the ground shall be disposed of, or reused beneficially, in accordance with the New Jersey Solid Waste Management Act, N.J.S.A. 13:1D-1 et seq., and implementing rules at N.J.A.C. 7:26.

SUBCHAPTER 13. CRITICAL AREAS

7:9A-13.1 Identification of critical areas

(a) The Department shall investigate various geographical areas of the State to determine whether any such areas should be restricted as to the types of sewerage facilities which may be thereafter located, constructed, altered or repaired. Areas identified as requiring imposition of these restrictions shall be designated as critical areas.

Potential areas to be investigated may be identified by:

1. The Department;
2. Requests from administrative authorities and other public health agencies; and
3. Any person that provides documentation to the Department that demonstrates that adverse conditions exist related to the ground or surface water, such that special measures are required to protect the environment or public health, safety or welfare.

(b) In conducting such an investigation, the Department shall give consideration to factors such as ground water and surface water quality, soil conditions, ground water levels, proximity to surface waters, population densities and projected growth trends and such other factors that could affect the safe and proper operation of sewerage facilities, including impacts to human health and impairment of the environment in the potential critical area.

7:9A-13.2 Establishment of critical areas

(a) If the Department determines that it is essential to the environment or public health and well-being of the inhabitants residing in the area to restrict or regulate the type or types of sewerage facilities which may thereafter be located, constructed, altered or repaired in such area, it shall proceed with designation of the area as a critical area for sewerage purposes.

(b) Prior to designating an area as a critical area for sewerage purposes, the Department shall provide notice of its determination that the area qualifies for critical area designation and hold a public hearing within the area proposed for critical area designation.

1. The Department shall publish a notice of the hearing specifying the time and place where the hearing will be held not less than 15 days prior to the hearing in each municipality any portion of which is located within the proposed critical area.
2. The notice shall be published in a newspaper with general circulation in the identified critical area.
3. The notice shall include a description of the area proposed to be designated as a critical area and a brief summary of the type or types of sewerage facilities that may thereafter be located, constructed, altered or repaired in the proposed critical area.

(c) No sooner than 60 days after the Department has conducted its public hearing, the Department shall determine whether the area should be designated as a critical area. If the designation as a critical area is determined to be appropriate by the Department, the Department shall publish a notice in accordance with (d) below, identifying:

1. The geographical area contained within the critical area; and

THIS IS A COURTESY COPY OF THIS RULE. ALL OF THE DEPARTMENT'S RULES ARE COMPILED IN TITLE 7 OF THE NEW JERSEY ADMINISTRATIVE CODE.

2. The type(s) of sewerage facilities which may thereafter be located, constructed, altered or repaired in the critical area in order to protect public health and the environment.

(d) New critical area designations shall be distributed by the Department to affected municipal governing bodies and administrative authorities in the newly established critical area. The designation shall specify, at a minimum, the information listed in (c)1 and 2 above.

(e) The Department shall publish in the New Jersey Register a notice of administrative change revising the list of critical areas contained in Table 13 below and shall mail notice of such revision to the affected municipality(ies). The list in Table 13 is for informational purposes only. Any person may obtain the most current list of such critical areas from the Department's Division of Water Quality, Bureau of Nonpoint Pollution Control at 401-02B, P.O. Box 420, Trenton, NJ 08625 or from the Division's website (<http://www.state.nj.us/dep/dwq>).

TABLE 13 CRITICAL AREAS

Critical Area	Affected County(ies)	Affected Municipality(ies)	Geographical Area	Restriction(s)

THIS IS A COURTESY COPY OF THIS RULE. ALL OF THE DEPARTMENT'S RULES ARE COMPILED IN TITLE 7 OF THE NEW JERSEY ADMINISTRATIVE CODE.

APPENDIX A - Figures

APPENDIX A—FIGURES

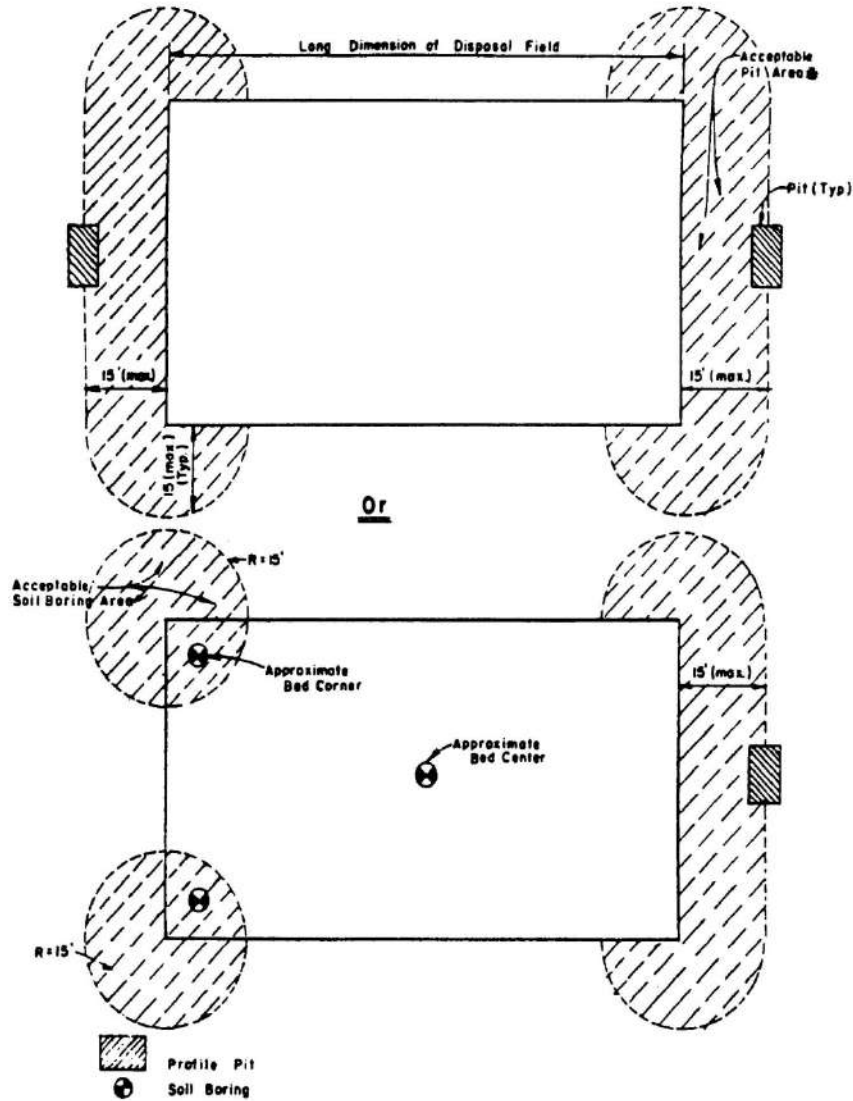

*Profile pits may be located within the boundaries of the disposal field also, provided that they are backfilled after use as prescribed in N.J.A.C. 7:9A-5.2(c).

Figure 1. Location of Soil Profile Pits and Borings

THIS IS A COURTESY COPY OF THIS RULE. ALL OF THE DEPARTMENT'S RULES ARE COMPILED IN TITLE 7 OF THE NEW JERSEY ADMINISTRATIVE CODE.

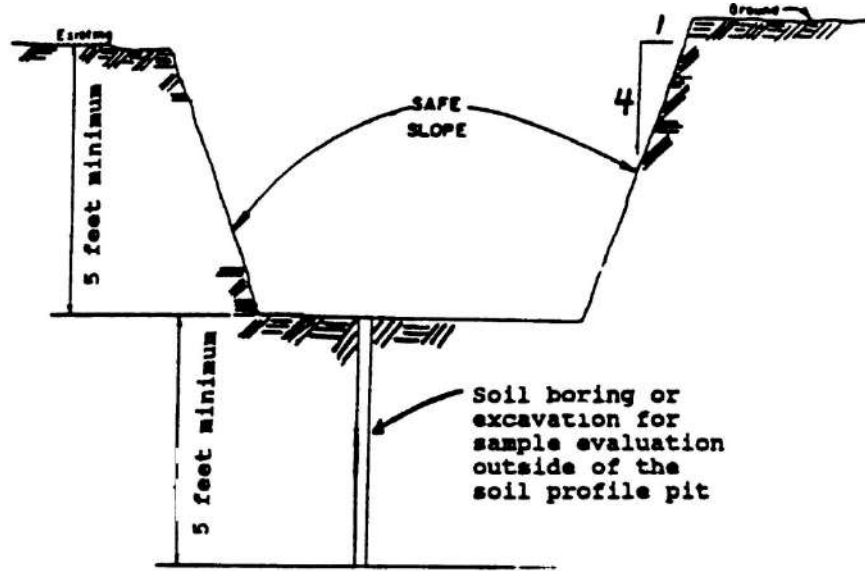
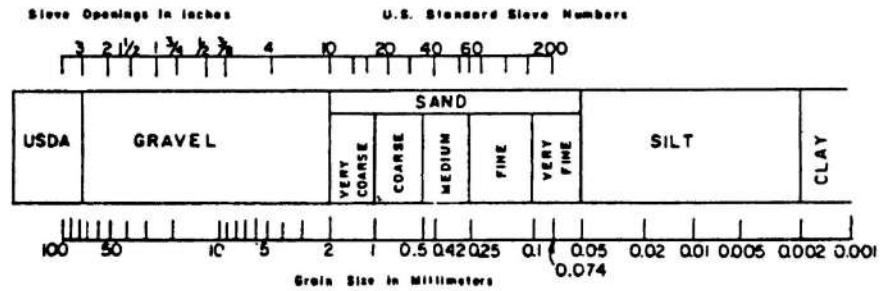
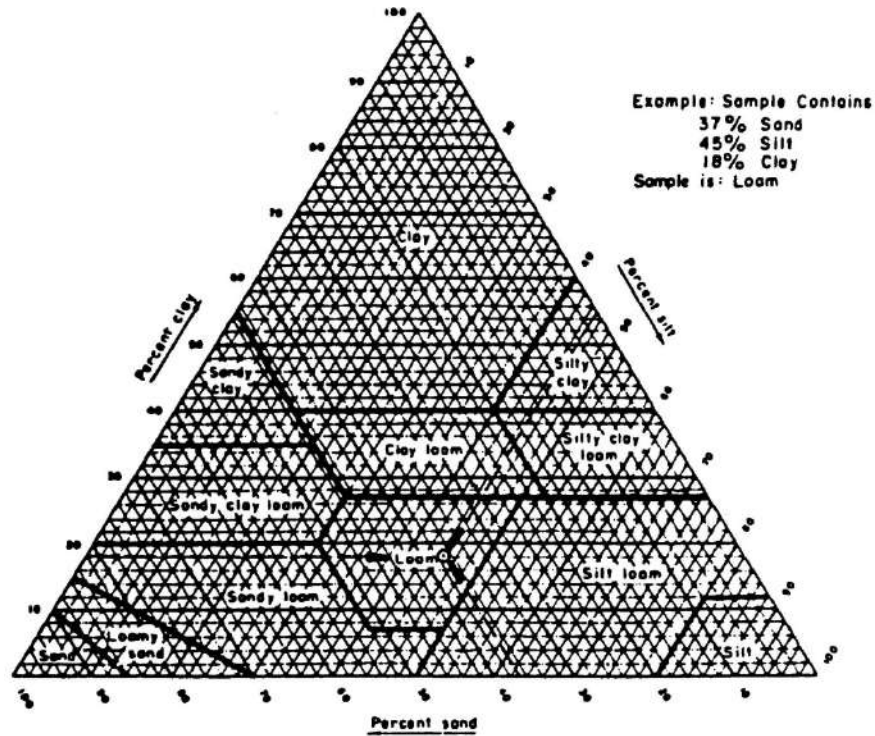

Figure 2. Recommended Cross-section of Soil Profile Pit.

THIS IS A COURTESY COPY OF THIS RULE. ALL OF THE DEPARTMENT'S RULES ARE COMPILED IN TITLE 7 OF THE NEW JERSEY ADMINISTRATIVE CODE.



Adapted from U.S. Dept. of the Interior, Water & Power Research Service (1974) *Earth Manual*, 2nd Edition, pg. 82

Figure 3. U.S.D.A. System of Soil Textural Classification

THIS IS A COURTESY COPY OF THIS RULE. ALL OF THE DEPARTMENT'S RULES ARE COMPILED IN TITLE 7 OF THE NEW JERSEY ADMINISTRATIVE CODE.

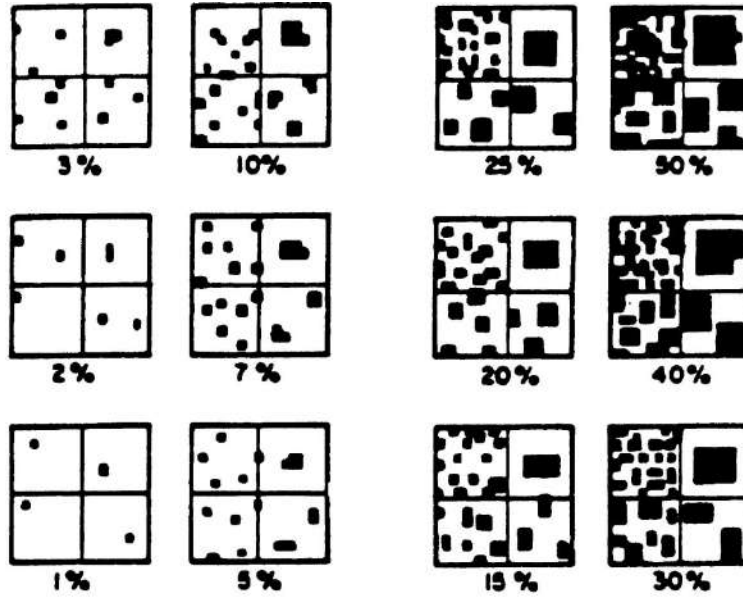

**Charts for estimating proportions of Matties and Coarse Fragments.
Each fourth of any one square has the same amount of black.**

Adapted from *Technical Manual for Sewage Enforcement Officers* Commonwealth of Pennsylvania, Dept. of Environmental Resources, Div. of Local Environmental Services, Bureau of Water Quality Management

Figure 4. Charts for Visual Estimation of Volume Percentage

THIS IS A COURTESY COPY OF THIS RULE. ALL OF THE DEPARTMENT'S RULES ARE COMPILED IN TITLE 7 OF THE NEW JERSEY ADMINISTRATIVE CODE.

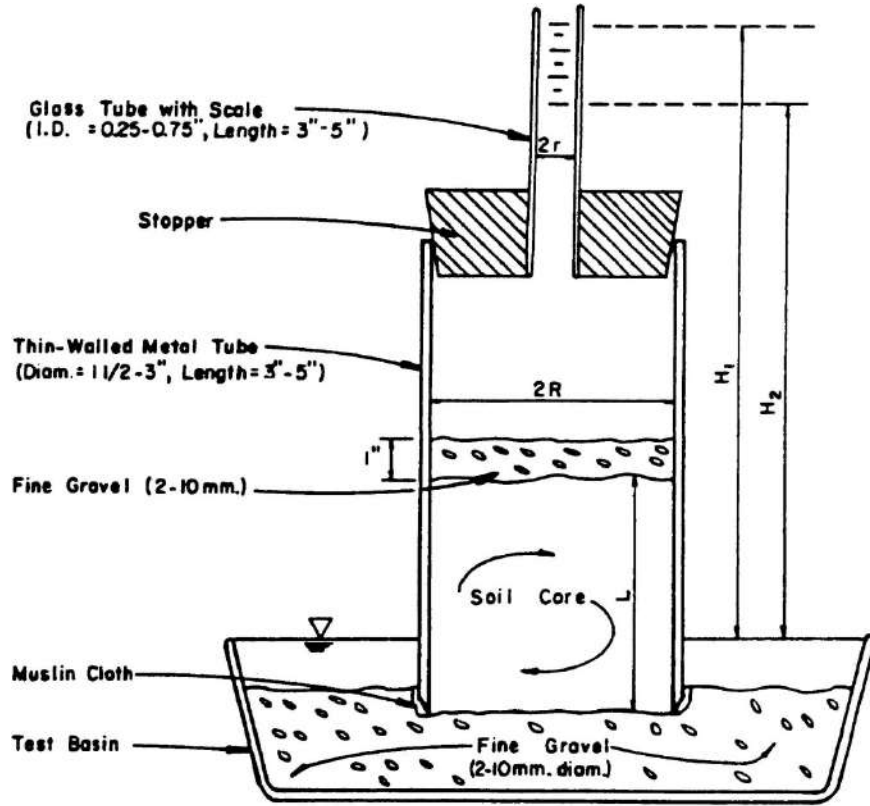

$$K(\text{in./hr.}) = 60(\text{min./hr.}) \times \frac{r^2}{R^2} \times \frac{L(\text{in.})}{T(\text{min.})} \times \frac{1}{n} \left(\frac{H_1}{H_2} \right)$$

Figure 5. Tube Permeameter (with standpipe)

THIS IS A COURTESY COPY OF THIS RULE. ALL OF THE DEPARTMENT'S RULES ARE COMPILED IN TITLE 7 OF THE NEW JERSEY ADMINISTRATIVE CODE.

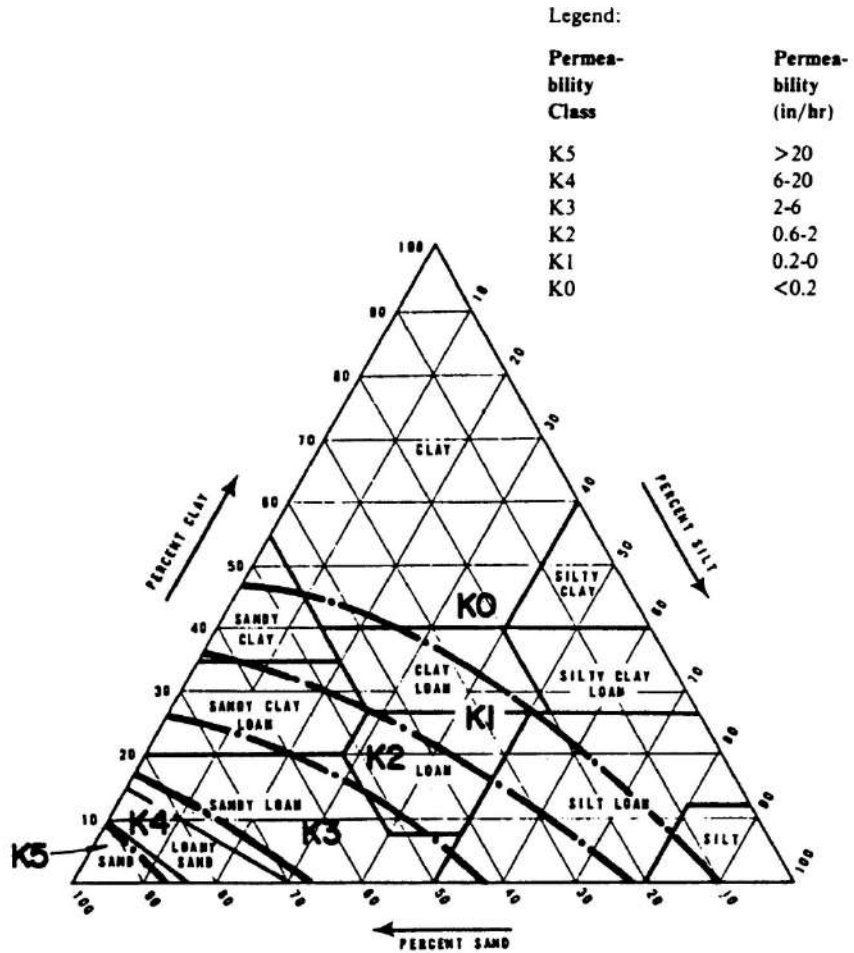

Adapted from N.N. Hantzsche et al. (1982) Soil Textural Analysis for Onsite Sewage Disposal Evaluation, Proc. 3rd Nat. Symposium on Individual and Small Community Sewage Treatment, Am. Soc. Agric. Eng., St. Joseph, Michigan

Figure 6. Soil Permeability/Textural Triangle

THIS IS A COURTESY COPY OF THIS RULE. ALL OF THE DEPARTMENT'S RULES ARE COMPILED IN TITLE 7 OF THE NEW JERSEY ADMINISTRATIVE CODE.

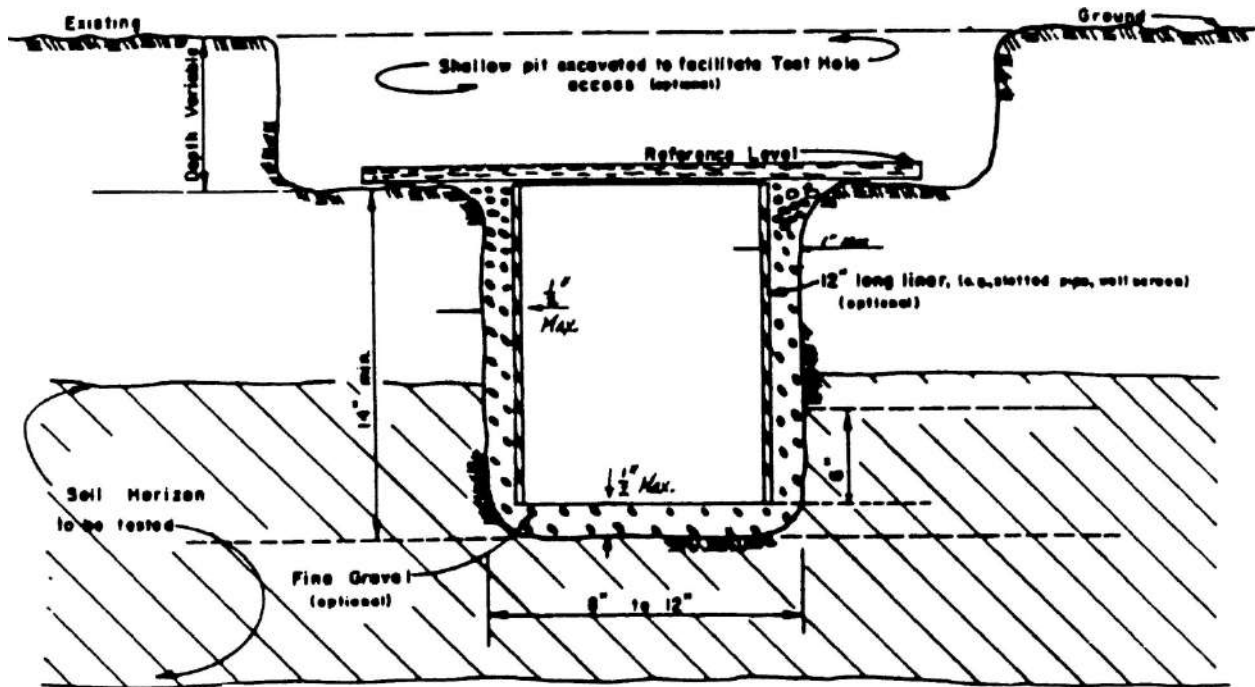
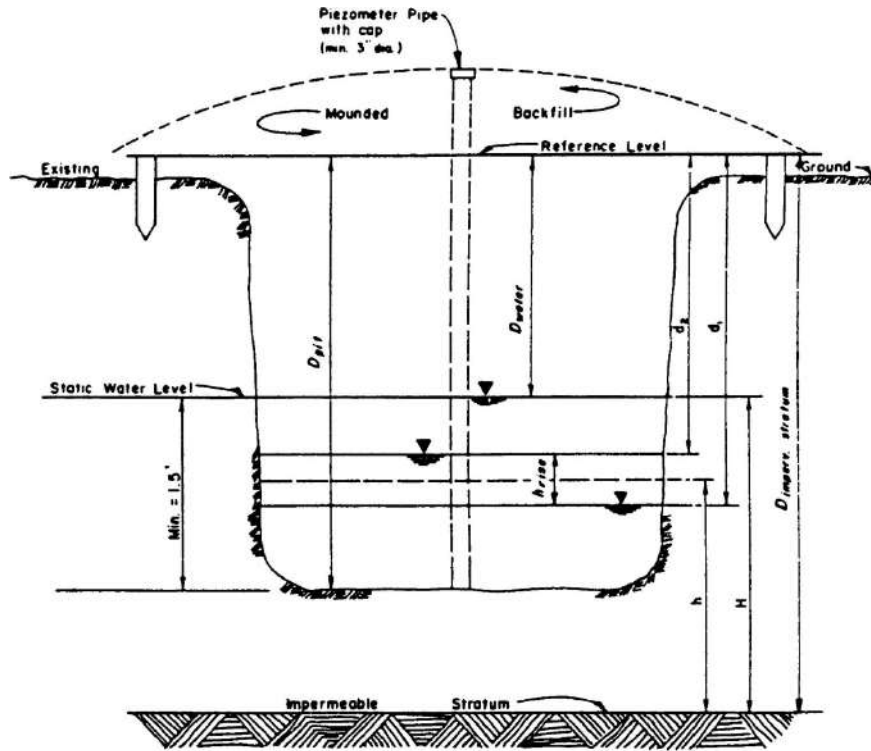

Figure 7. Percolation Test

THIS IS A COURTESY COPY OF THIS RULE. ALL OF THE DEPARTMENT'S RULES ARE COMPILED IN TITLE 7 OF THE NEW JERSEY ADMINISTRATIVE CODE.



$$K \text{ (in./hr.)} = \left[\frac{h^2 \text{ rise}}{t} \right] \times \left[\frac{A_{wc}}{2.27 (H^2 - h^2)} \right] \times 60 \text{ min./hr.}$$

Figure 8. Pit-bailing Test.

THIS IS A COURTESY COPY OF THIS RULE. ALL OF THE DEPARTMENT'S RULES ARE COMPILED IN TITLE 7 OF THE NEW JERSEY ADMINISTRATIVE CODE.

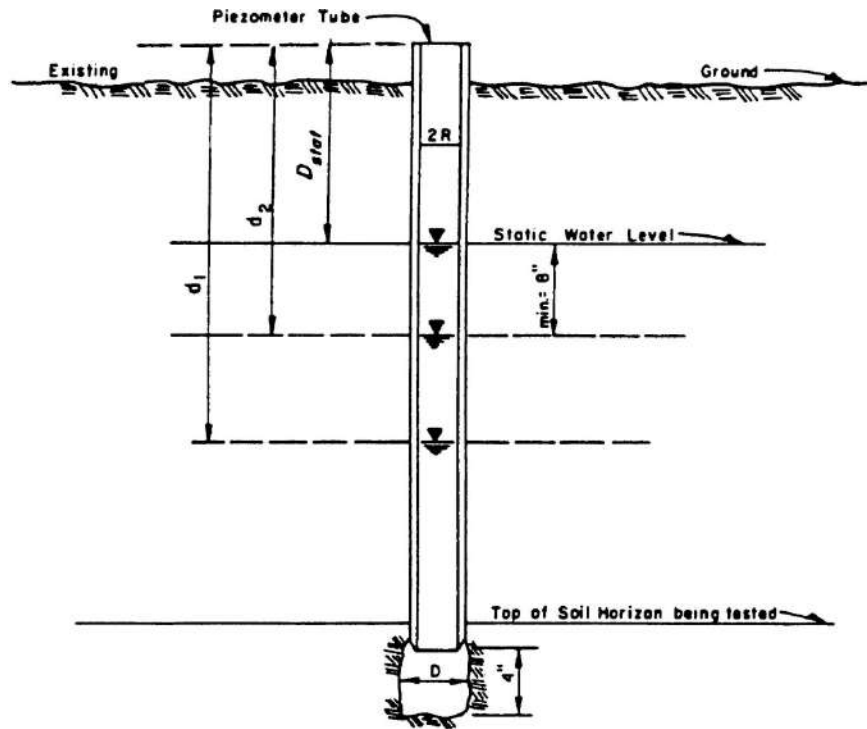

$$K = 60 \text{ min/hr.} \times (3.14 R^2 / A t) \times \ln [(d_1 - D_{stat}) / (d_2 - D_{stat})]$$

Figure 9. Piezometer Test.

THIS IS A COURTESY COPY OF THIS RULE. ALL OF THE DEPARTMENT'S RULES ARE COMPILED IN TITLE 7 OF THE NEW JERSEY ADMINISTRATIVE CODE.

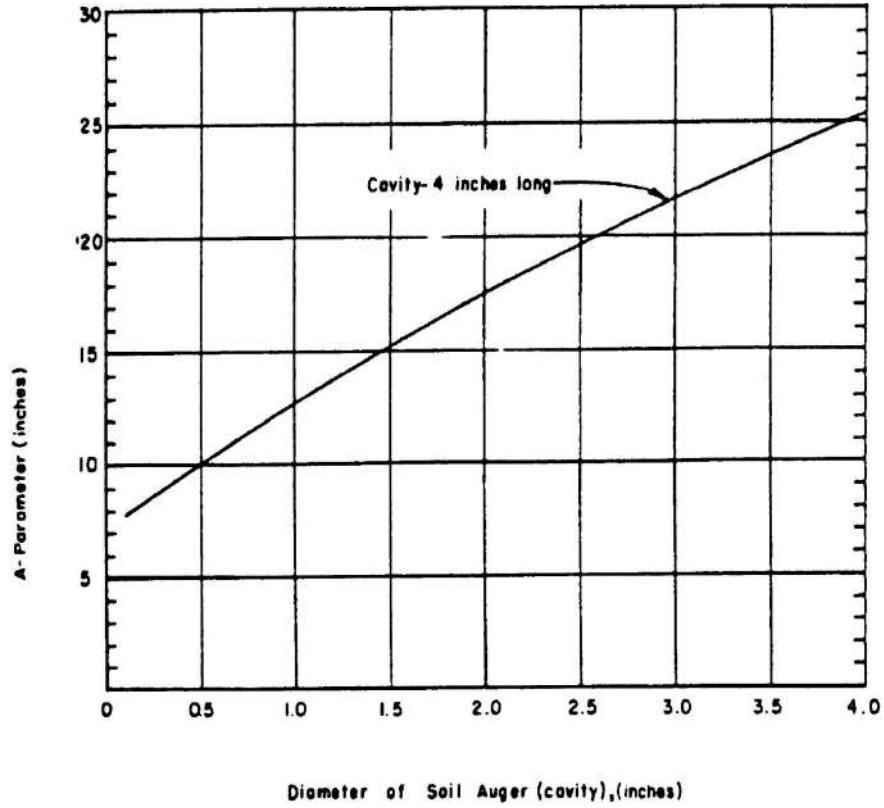
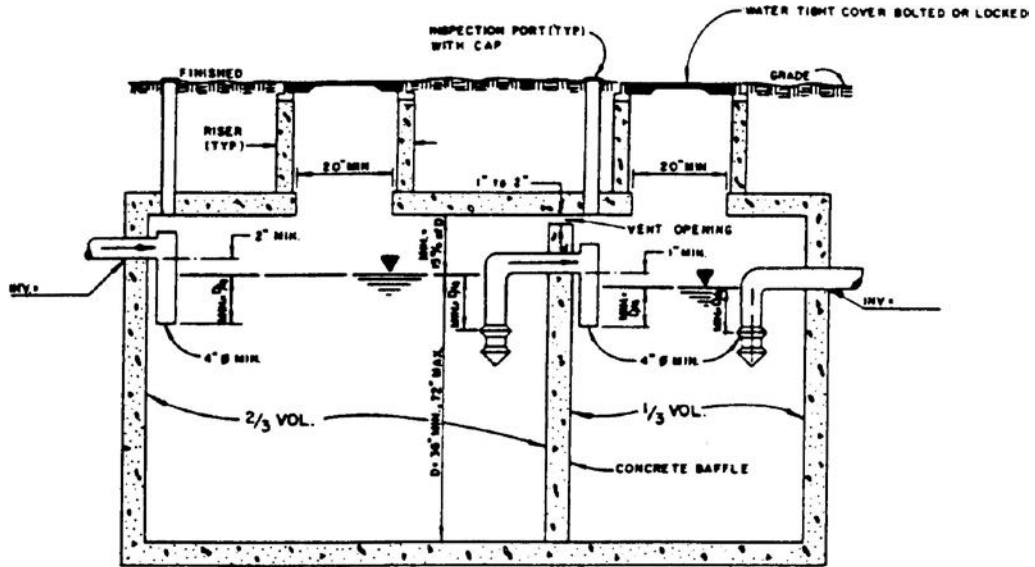

Figure 10. "A" Parameter for Piezometer Test.

THIS IS A COURTESY COPY OF THIS RULE. ALL OF THE DEPARTMENT'S RULES ARE COMPILED IN TITLE 7 OF THE NEW JERSEY ADMINISTRATIVE CODE.



ELEVATION

VOL. = TOTAL LIQUID CAPACITY

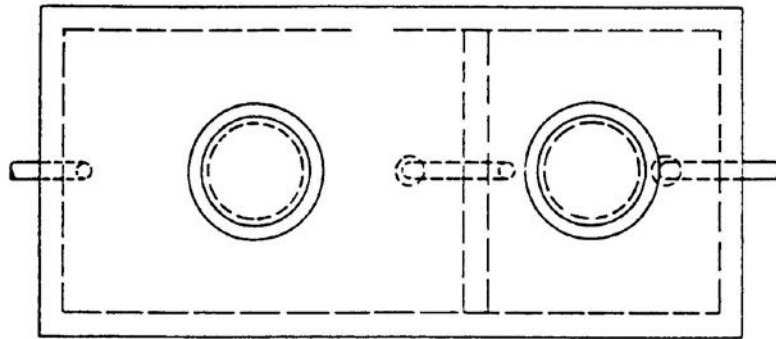

PLAN

Figure 11. Multiple Compartment Septic Tank with Septic Solids Retainer

THIS IS A COURTESY COPY OF THIS RULE. ALL OF THE DEPARTMENT'S RULES ARE COMPILED IN TITLE 7 OF THE NEW JERSEY ADMINISTRATIVE CODE.

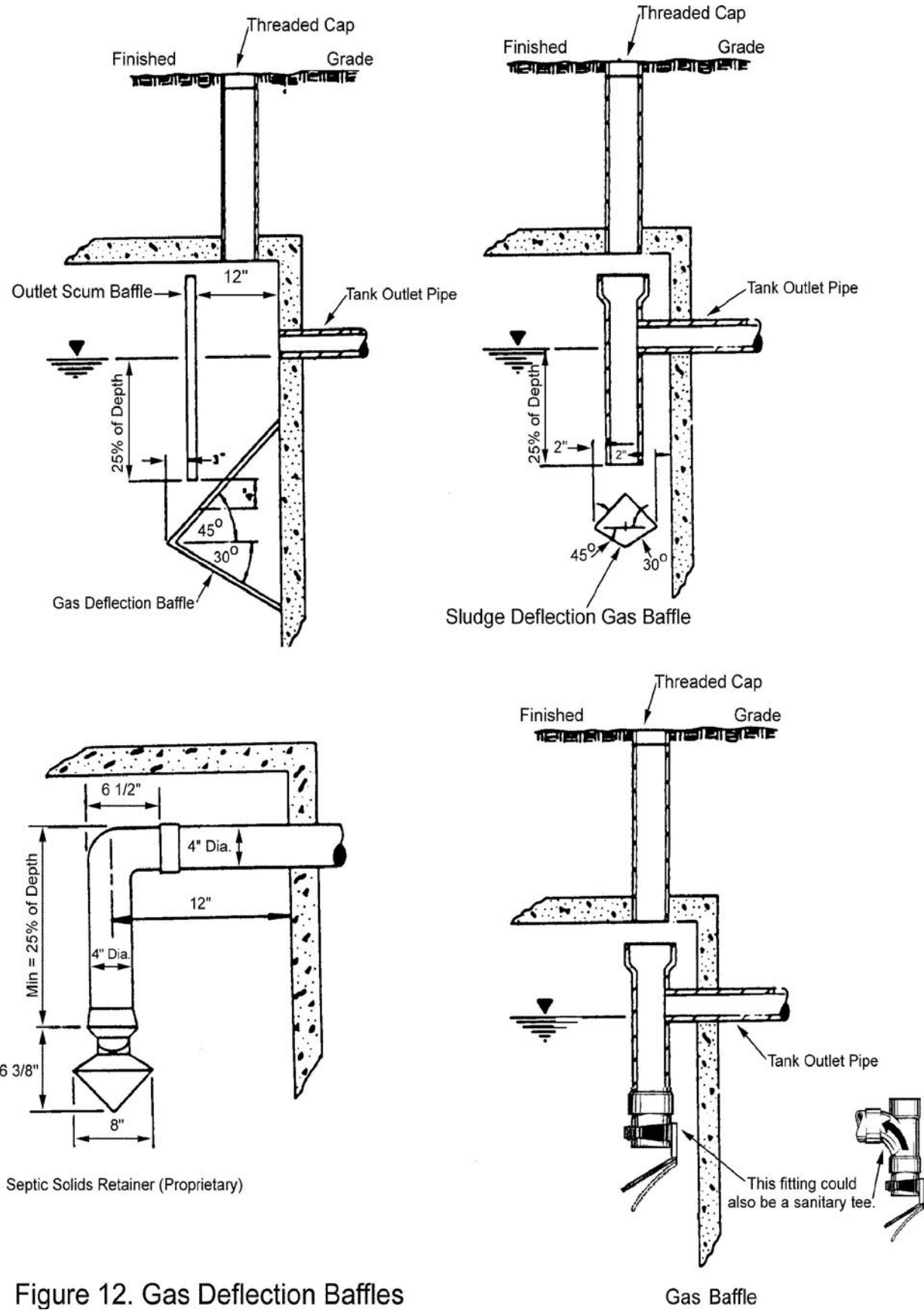
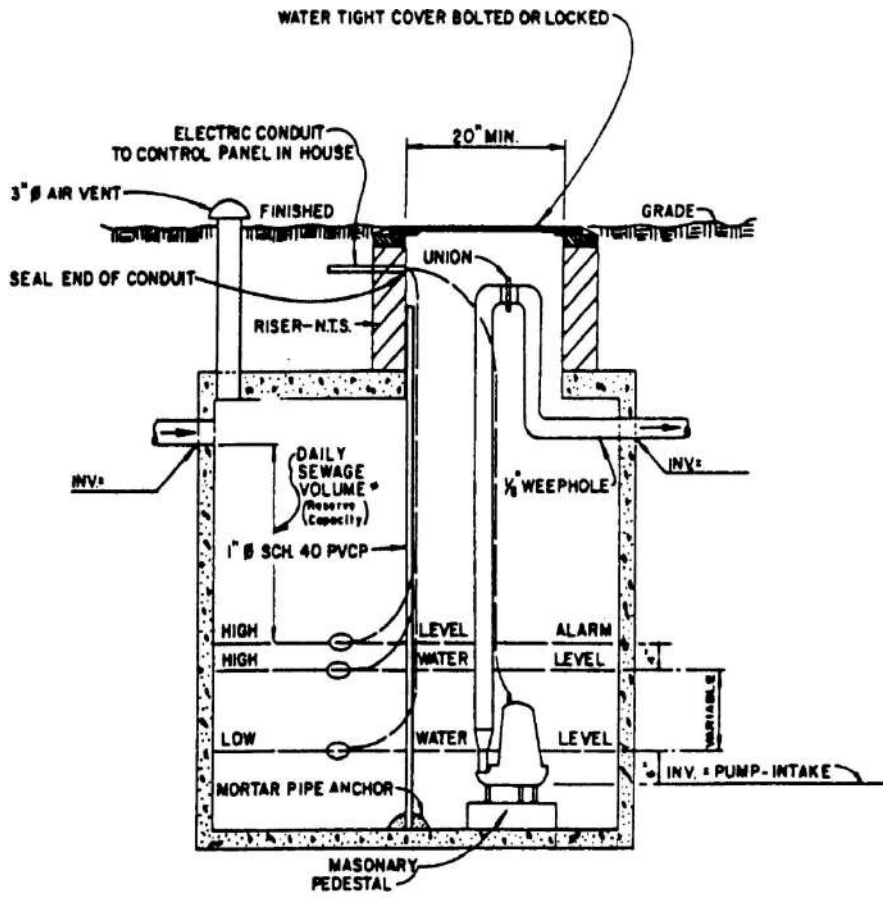

Figure 12. Gas Deflection Baffles

THIS IS A COURTESY COPY OF THIS RULE. ALL OF THE DEPARTMENT'S RULES ARE COMPILED IN TITLE 7 OF THE NEW JERSEY ADMINISTRATIVE CODE.



* Except where dual pumps used.

Figure 13. Dosing Tank with Pump.

THIS IS A COURTESY COPY OF THIS RULE. ALL OF THE DEPARTMENT'S RULES ARE COMPILED IN TITLE 7 OF THE NEW JERSEY ADMINISTRATIVE CODE.

LATERAL LENGTH (FT)	PIPES WITH 1/4 INCH HOLES				PIPES WITH 5/16 INCH HOLES				PIPES WITH 3/8 INCH HOLES			
	HOLE SPACING (FT)				HOLE SPACING (FT)				HOLE SPACING (FT)			
	2	3	4	5	2	3	4	5	2	3	4	5
10												
15											1	
20			1				1					
25									3/2	5/4		
30					3/2							
35							5/4					
40	3/2		5/4				3/2			2	3/2	
45						2						
50	2	3/2			3			3/2	3			

LATERAL LENGTH (FT)	PIPES WITH 7/16				PIPES WITH 1/2			
	HOLE SPACING (FT)				HOLE SPACING (FT)			
	2	3	4	5	2	3	4	5
10								
15				1				1
20	3/2					3/2	5/4	
25		3/2	5/4				3/2	
30			3/2					3/2
35				3/2			2	
40		2						
45					3			
50	3							

Computed for plastic pipe. The Hazen-Williams equation was used to compute headlosses through each pipe segment. (Hazen-Williams C = 150). The orifice equation for sharp-edged orifices (discharge coefficient = 0.6) was used to compute discharge rates through each orifice. The maximum lateral length for a given hole and spacing was defined as that length at which the difference between the rates of discharge from the distal end and the supply end orifices reached 10% of the distal orifice rate.

Figure 14. Required Lateral Diameters, in Inches, For Various Hole Diameters, Hole Spacings and Lateral Lengths

THIS IS A COURTESY COPY OF THIS RULE. ALL OF THE DEPARTMENT'S RULES ARE COMPILED IN TITLE 7 OF THE NEW JERSEY ADMINISTRATIVE CODE.

MANIFOLD DIAMETER (IN)

Flow per Lateral, Central Manifold, gpm	Manifold Length (ft)																								Flow per Lateral, End Manifold, gpm												
	5						10						15						20							25						30					
	Number of Laterals with Central Manifold																																				
	4	6	4	6	8	10	4	6	8	10	12	6	8	10	12	14	6	8	10	12	14	6	8	10	12	14											
5	1	5/4	5/4	5/3	3/2	2	5/4	5/4	5/3	3/2	2	5/4	5/4	5/3	3/2	2	2	2	2	2	2	2	2	2	2	2	2	10									
10	1	5/4	3/2	3/2	2	2	2	2	2	2	2	2	2	2	2	2	2	2	2	2	2	2	2	2	2	2	2	20									
15	1	3/2	2	2	2	2	2	2	2	2	2	2	2	2	2	2	2	2	2	2	2	2	2	2	2	2	2	30									
20	1	2	3	3	4	4	3	3	3	4	4	3	3	3	4	4	3	3	3	4	4	4	3	3	3	4	4	40									
25	1	2	3	3	4	5	2	3	4	5	6	3	4	5	6	7	3	4	5	6	7	7	3	4	5	6	7	50									
	Number of Laterals with End Manifold																																				

Flow per Lateral, Central Manifold, gpm	Manifold Length (ft)																								Flow per Lateral, End Manifold, gpm						
	35						40						45						50												
	Number of Laterals with Central Manifold																														
	6	8	10	12	14	16	6	8	10	12	14	16	18	6	8	10	12	14	16	18	20	6	8	10	12	14	16	18	20	22	
5	2					2							2									2							4	10	
10	3					3							3									3							4	20	
15						4							4									4							4	30	
20						6							6									6							6	40	
25																														50	
	Number of Laterals with End Manifold																														

Figure 15. Required Manifold Diameters For Various Manifold Lengths, Number of Laterals and Lateral Discharge Rates

Computed for plastic pipe only. The Hazen-Williams equation was used to compute headlosses through each segment (Hazen-Williams C = 150). The maximum manifold length for given lateral discharge rate and spacing was defined as that length at which the difference between the heads at the distal and supply ends of the manifold reached 10 percent of the head at the distal end.

THIS IS A COURTESY COPY OF THIS RULE. ALL OF THE DEPARTMENT'S RULES ARE COMPILED IN TITLE 7 OF THE NEW JERSEY ADMINISTRATIVE CODE.

**FRICITION LOSS IN SCHEDULE 40 PLASTIC PIPE, C=150
(ft/100 ft) Pipe Diameter (in)**

Flow (gpm)	1	1 1/4	1 1/2	2	2 1/2	3	4	6	8	10
2
4	1.01
6	2.14	0.55
8	3.63	0.97	0.46
10	5.50	1.46	0.70	0.21
12	5.64	2.09	1.01	0.30	0.12
15	11.75	3.06	1.45	0.44	0.18	0.07
18		4.37	2.07	0.62	0.25	0.10
20		5.23	2.46	0.73	0.31	0.12
25		7.89	3.72	1.10	0.46	0.16
30		11.10	5.22	1.55	0.65	0.23
35			6.95	2.06	0.87	0.30	0.07
40			8.90	2.62	1.11	0.39	0.09
45			11.06	3.29	1.38	0.48	0.12
50			13.45	3.98	1.68	0.58	0.16
55			16.04	4.75	2.00	0.70	0.18
60			18.85	5.58	2.35	0.81	0.21
65			21.86	6.47	2.72	0.95	0.25
70				7.43	3.13	1.08	0.28
75				8.44	3.55	1.12	0.33
80				9.51	4.00	1.38	0.37
85				10.64	4.49	1.55	0.41
90				11.83	4.98	1.73	0.46
95					5.50	1.91	0.49
100					6.05	2.09	0.55	0.07
110					7.22	2.51	0.67	0.09
120					8.48	2.94	0.78	0.11
130						3.42	0.91	0.12
140						3.92	1.04	0.14
150						4.45	1.17	0.16
200							2.02	0.28	0.07
250							3.05	0.41	0.11
300								0.58	0.16
350								0.78	0.20	0.07
400								0.99	0.26	0.09
450								1.22	0.32	0.11
500									0.38	0.14
600									0.54	0.18
700									0.72	0.24
800										0.32
900										0.38
1000										0.46

Figure 16. Friction Loss in Schedule 40 Pipe

THIS IS A COURTESY COPY OF THIS RULE. ALL OF THE DEPARTMENT'S RULES ARE COMPILED IN TITLE 7 OF THE NEW JERSEY ADMINISTRATIVE CODE.

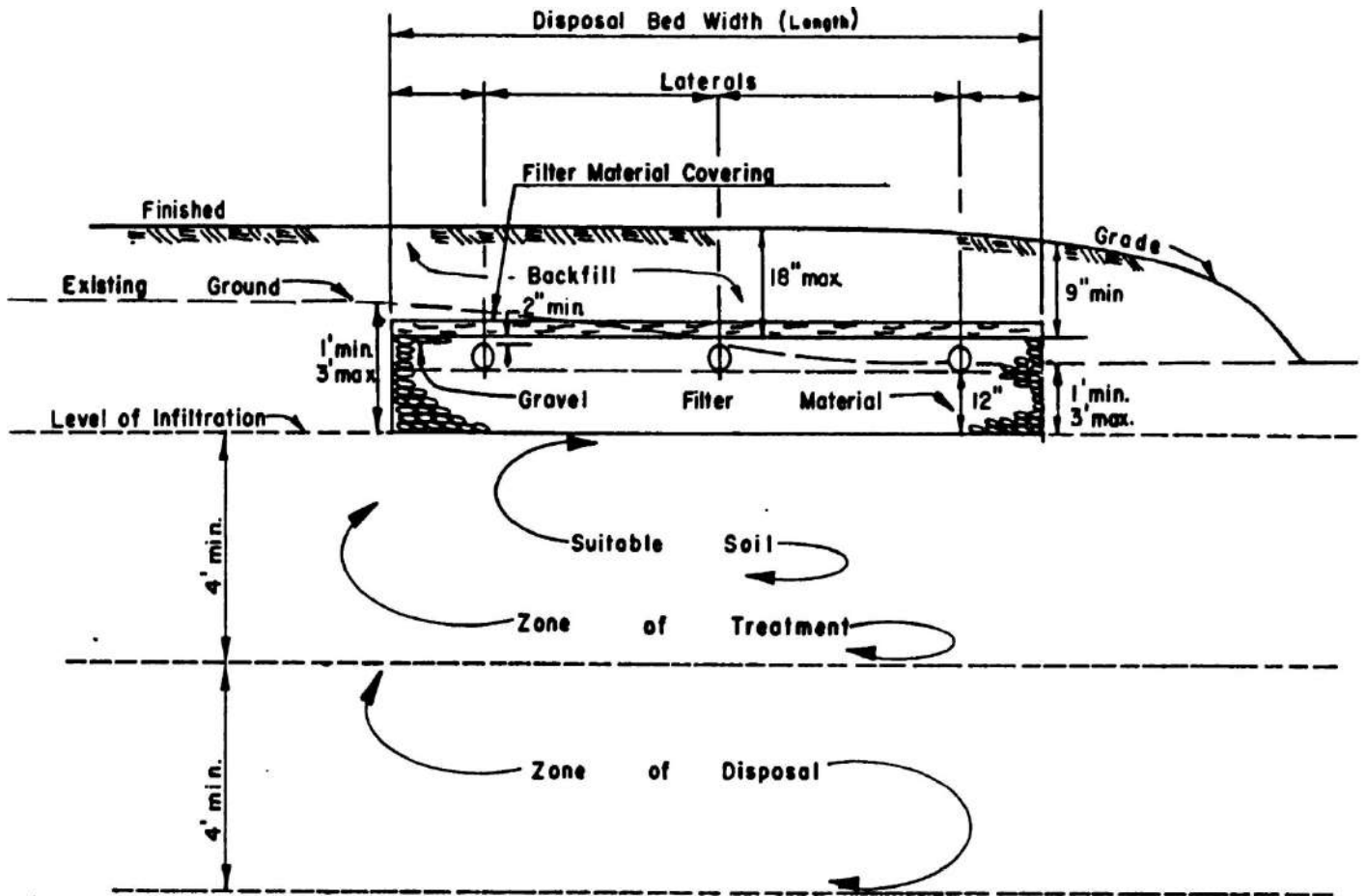

Figure 17. Conventional Disposal Field Installation.

THIS IS A COURTESY COPY OF THIS RULE. ALL OF THE DEPARTMENT'S RULES ARE COMPILED IN TITLE 7 OF THE NEW JERSEY ADMINISTRATIVE CODE.

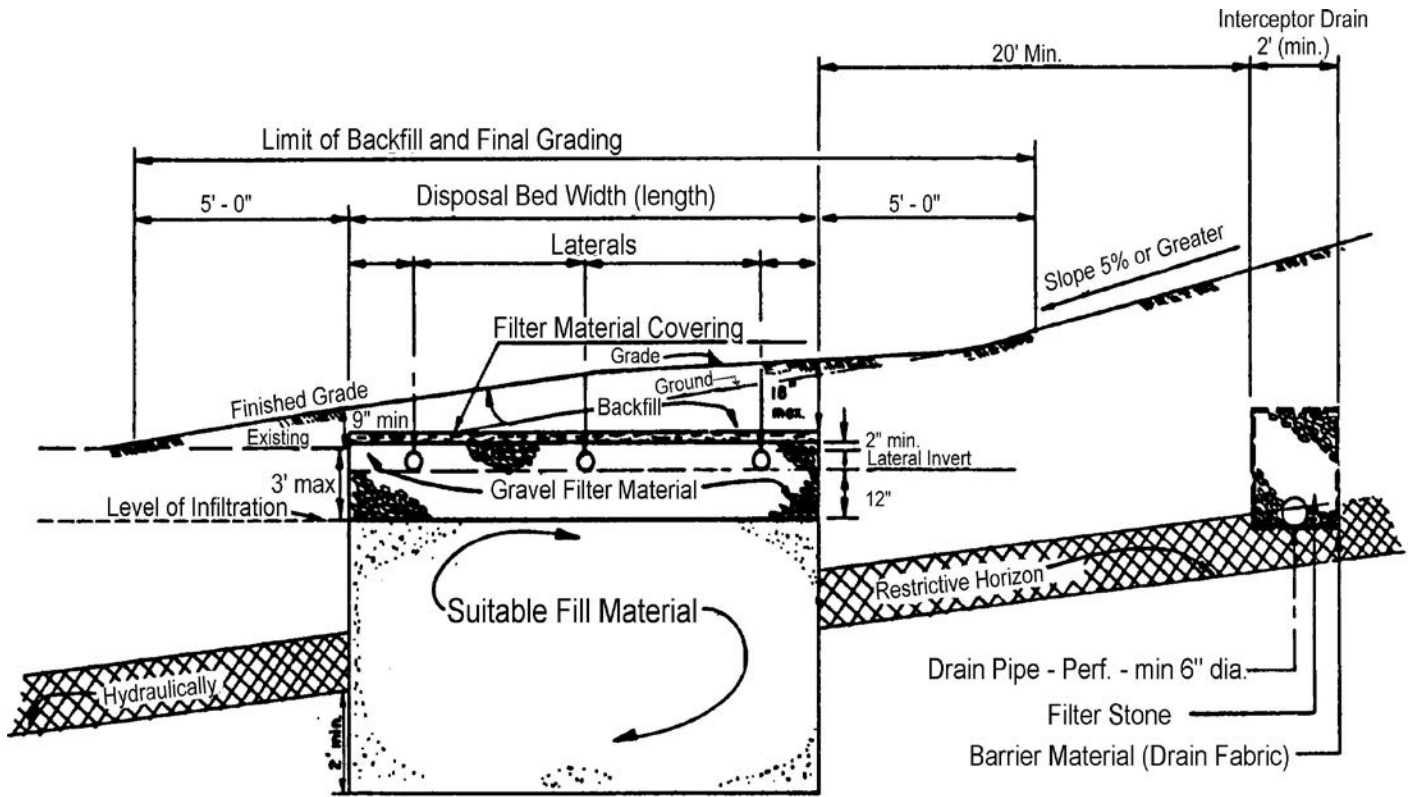

Figure 18. Soil Replacement, Bottom-Lined Disposal Field Installation

THIS IS A COURTESY COPY OF THIS RULE. ALL OF THE DEPARTMENT'S RULES ARE COMPILED IN TITLE 7 OF THE NEW JERSEY ADMINISTRATIVE CODE.

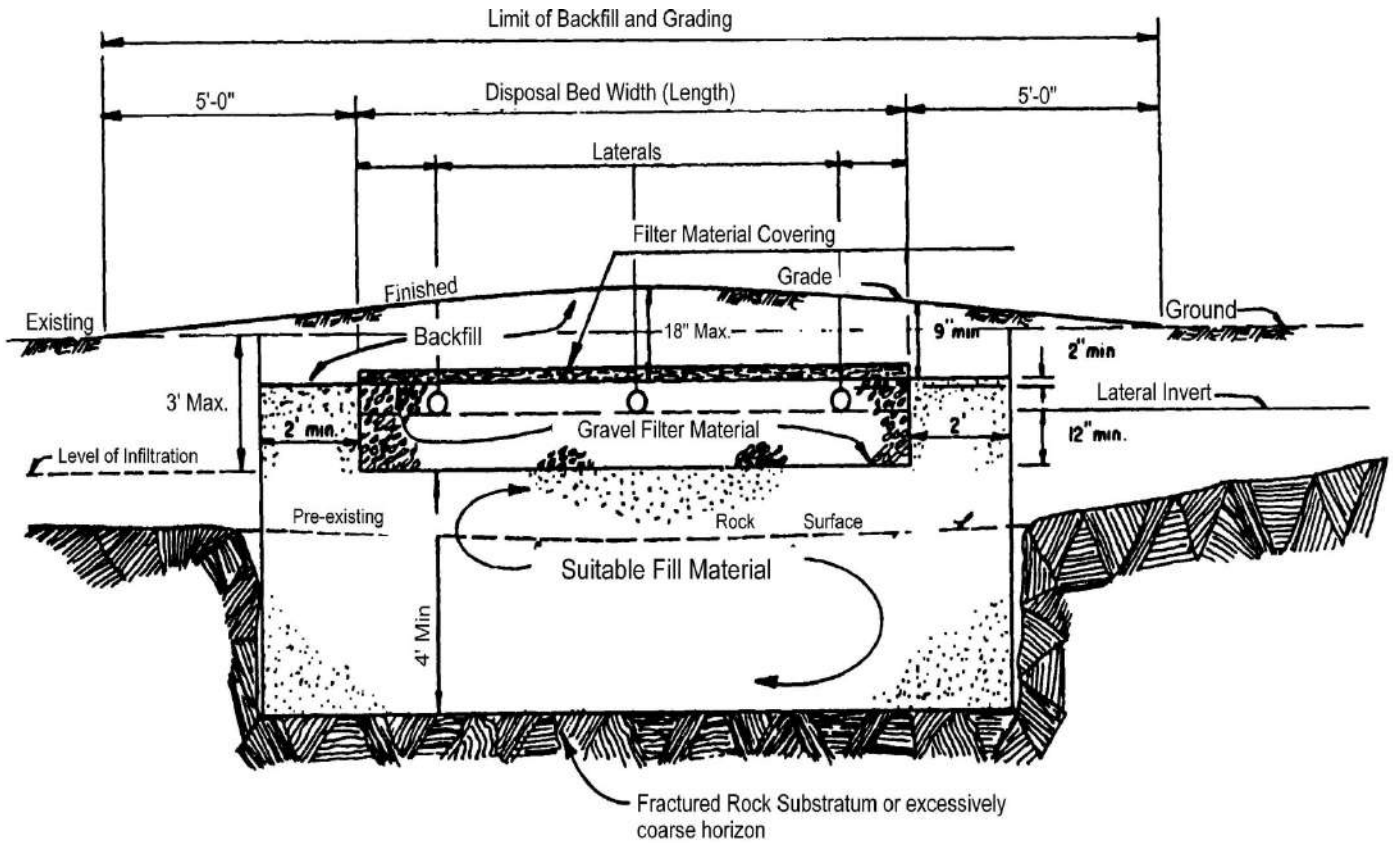

Figure 19. Soil Replacement, Fill-enclosed Disposal Field Installation

THIS IS A COURTESY COPY OF THIS RULE. ALL OF THE DEPARTMENT'S RULES ARE COMPILED IN TITLE 7 OF THE NEW JERSEY ADMINISTRATIVE CODE.

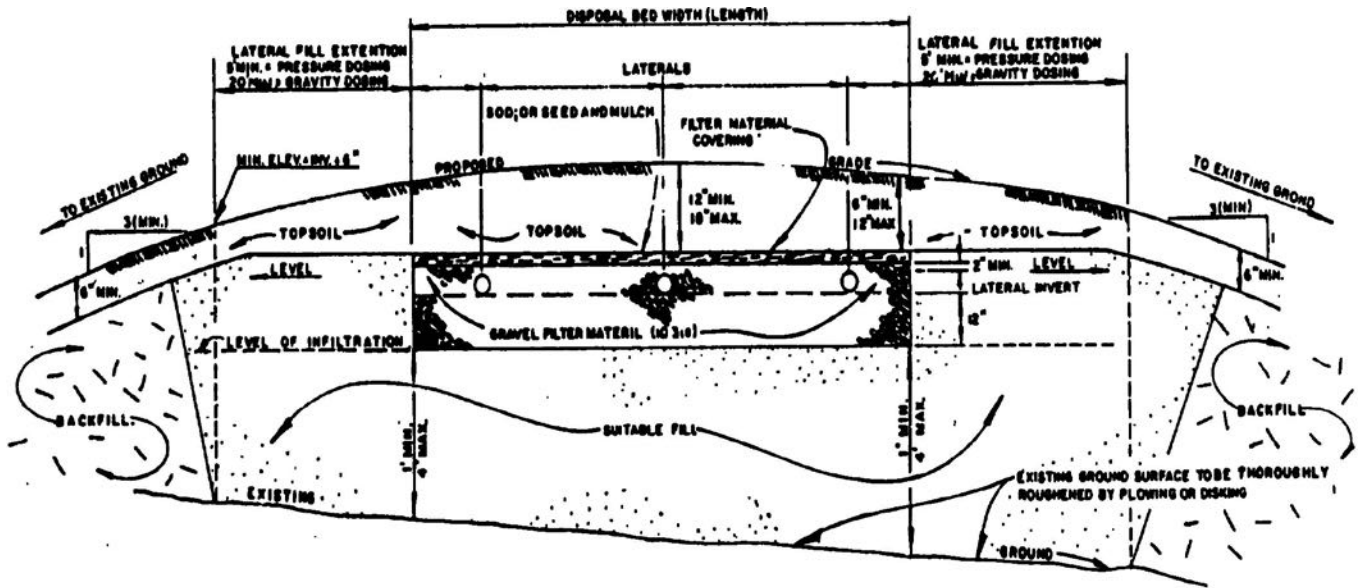

Figure 20. Mounded Disposal Field Installation.

THIS IS A COURTESY COPY OF THIS RULE. ALL OF THE DEPARTMENT'S RULES ARE COMPILED IN TITLE 7 OF THE NEW JERSEY ADMINISTRATIVE CODE.

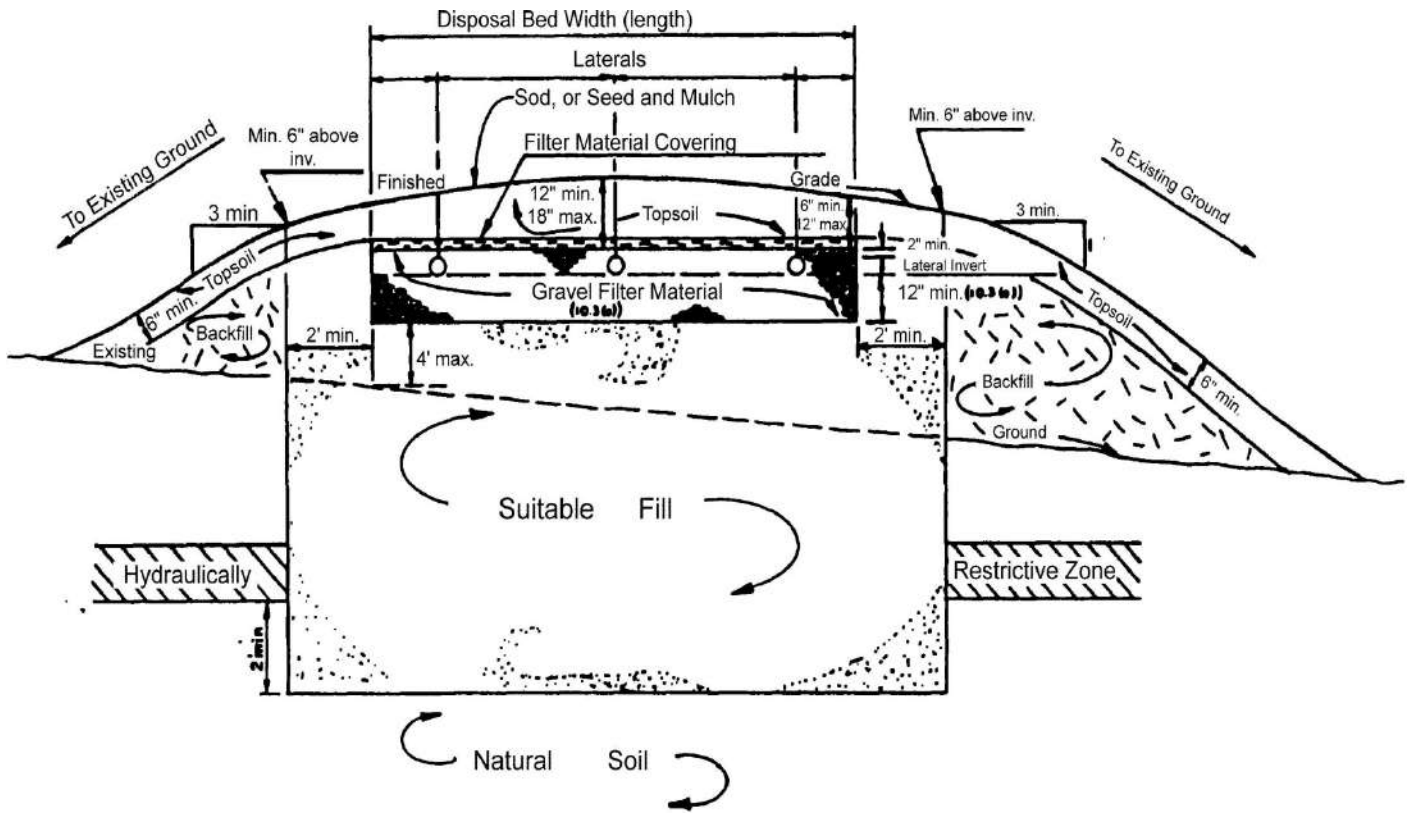

Figure 21. Mounded Soil Replacement Disposal Field Installation

THIS IS A COURTESY COPY OF THIS RULE. ALL OF THE DEPARTMENT'S RULES ARE COMPILED IN TITLE 7 OF THE NEW JERSEY ADMINISTRATIVE CODE.

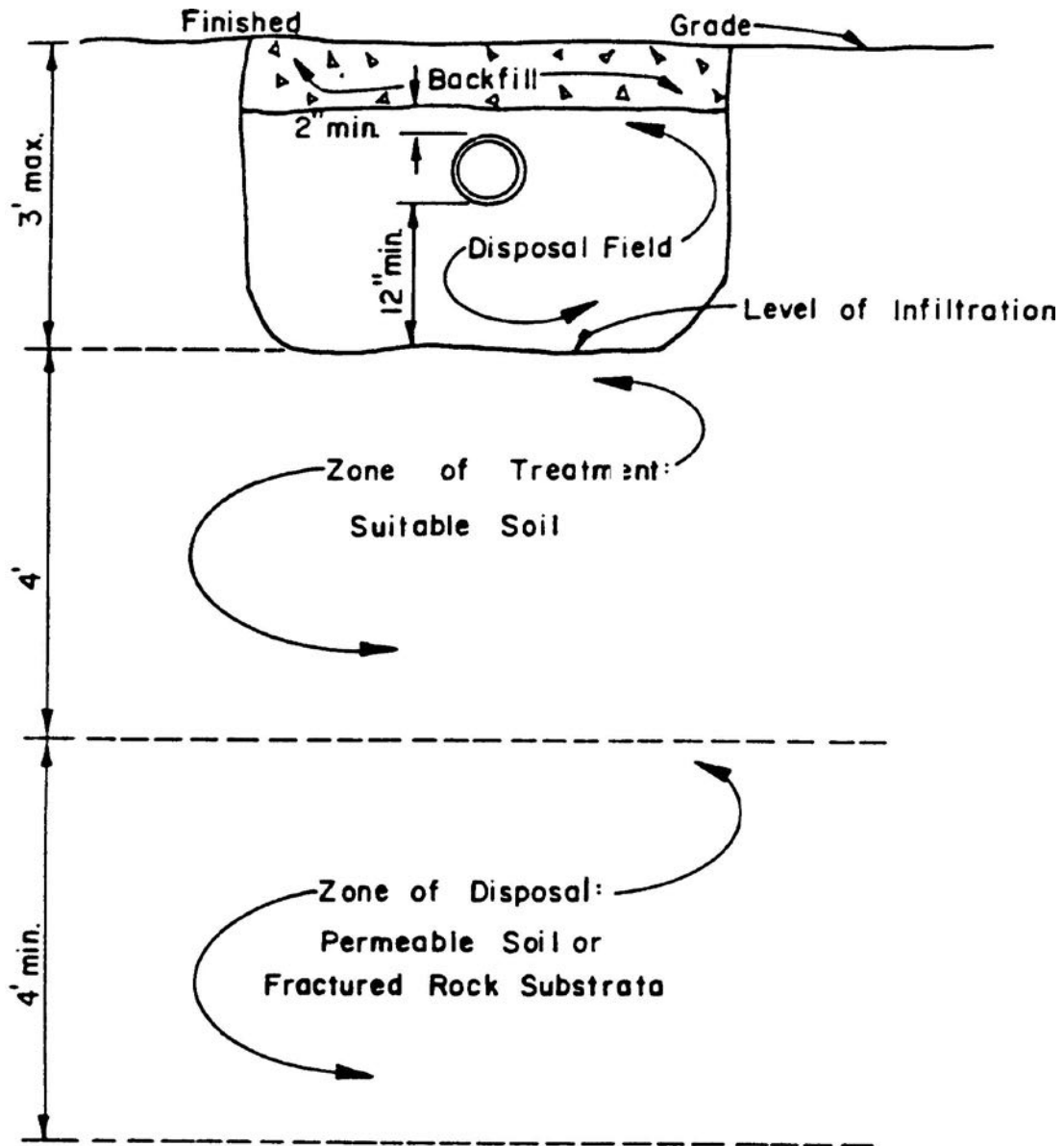

Figure 22. Zone of Treatment and zone of Disposal, Conventional Installations.

THIS IS A COURTESY COPY OF THIS RULE. ALL OF THE DEPARTMENT'S RULES ARE COMPILED IN TITLE 7 OF THE NEW JERSEY ADMINISTRATIVE CODE.

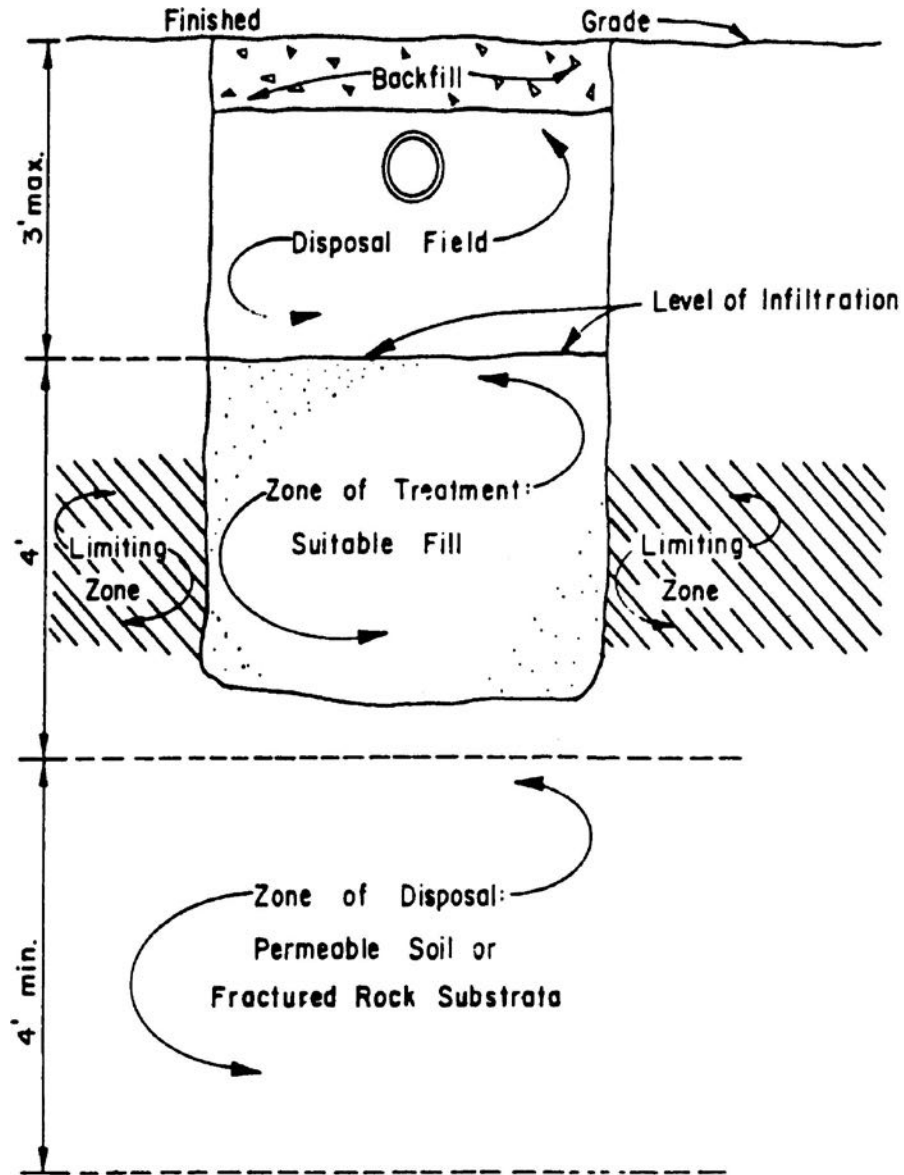

Figure 23. Placement of Fill Material Within Zone of Treatment.

THIS IS A COURTESY COPY OF THIS RULE. ALL OF THE DEPARTMENT'S RULES ARE COMPILED IN TITLE 7 OF THE NEW JERSEY ADMINISTRATIVE CODE.

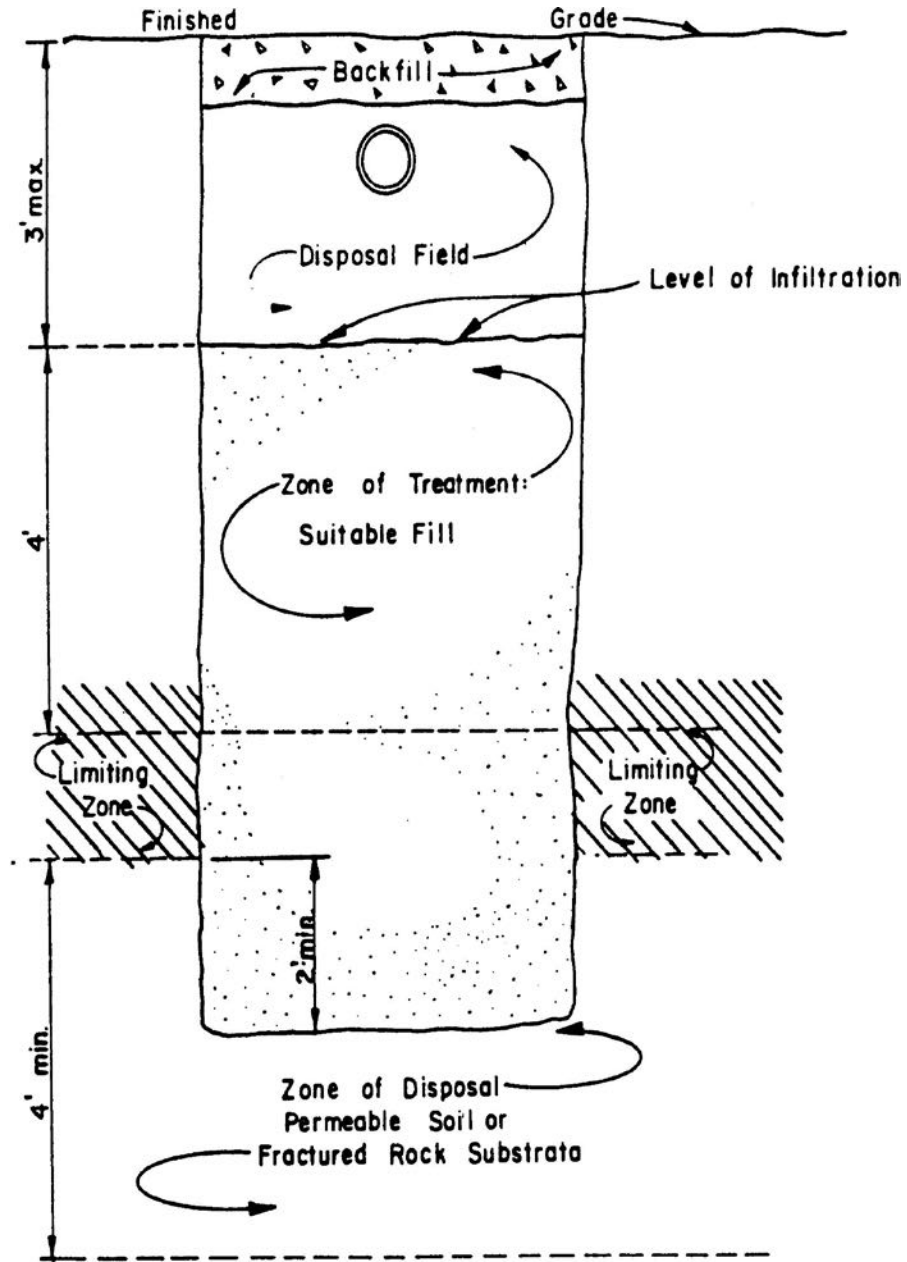

Figure 24. Placement of Fill Material Within Zone of Disposal.

THIS IS A COURTESY COPY OF THIS RULE. ALL OF THE DEPARTMENT'S RULES ARE COMPILED IN TITLE 7 OF THE NEW JERSEY ADMINISTRATIVE CODE.

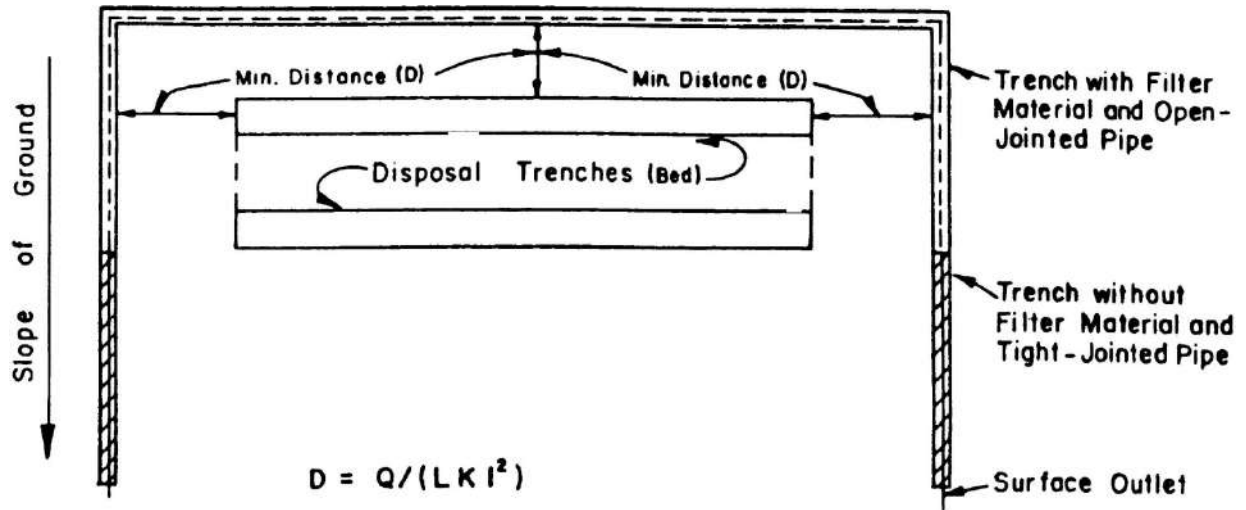

Figure 25. Disposal Field with Interceptor Drain.

THIS IS A COURTESY COPY OF THIS RULE. ALL OF THE DEPARTMENT'S RULES ARE COMPILED IN TITLE 7 OF THE NEW JERSEY ADMINISTRATIVE CODE.

Size Number	Nominal Size Square Openings (1)	Amounts finer than each laboratory sieve (square openings), percentage by weight															
		4	3½	3	2½	2	1½	1	¾	½	⅜	No. 4	No. 8	No. 16	No. 30	No. 100	
1	3½ to 1½	100	90-100		25-60		0-15		0-5								
2	2½ to 1½			100	90-100	35-70	0-15	0-5									
24	2½ to ¾			100	90-100		25-60		0-10	0-5							
3	2 to 1				100	90-100	35-70	0-15	0-5								
357	2 to No. 4				100	95-100		35-70		10-30			0-5				
4	1½ to ¾					100	90-100	20-55	0-15			0-5					
467	1½ to No. 4					100	95-100		35-70		10-30		0-5				
5	1 to ½						100	90-100	20-55	0-10		0-5					
56	1 to ¾						100	90-100	40-75	15-35		0-15					
57	1 to No. 4						100	95-100		25-60		0-10	0-5				
6	¾ to ¾							100	90-100	20-55		0-15	0-5				
67	¾ to No. 4							100	90-100		20-55	0-10	0-5				
68	¾ to No. 8							100	90-100		30-65	5-25	0-10	0-5			
7	½ to No. 4								100	90-100	40-70	0-15	0-5				
78	½ to No. 8								100	90-100	40-75	5-25	0-10	0-5			
8	¾ to No. 8									100	85-100	10-30	0-10	0-5			
89	¾ to No. 16										100	90-100	20-55	0-30	0-10	0-5	
9	No. 4 to No. 16											100	85-100	10-40	0-10	0-5	
10	No. 4 to 0 ²												100				10-30

¹In inches, except where otherwise indicated. Numbered sieves are those of the United States Sieve Series.
²Screenings.

Figure 26. N.J. Department of Transportation Standard Sizes for Coarse Aggregate

APPENDIX B STANDARD FORMS FOR SUBMISSION OF SOILS/ENGINEERING DATA

COUNTY/MUNICIPALITY _____

APPLICATION FOR PERMIT TO CONSTRUCT/ALTER/REPAIR AN INDIVIDUAL SUBSURFACE SEWAGE DISPOSAL SYSTEM

Form 1—General Information

1. Type of Permit Needed (Check and Fill-in applicable categories):
 - a. New Construction
 - b. Alteration/ No Expansion or Change in Use
 - c. Alteration/Expansion or Change in Use
 - d. Alteration/Malfunctioning System
 - e. Repair (in-kind replacement)/ Malfunctioning system
 - f. Repair (in-kind replacement) System is not malfunctioning
 - g. Deviation from Standards
 - h. New system installed (existing structure)
2. Location of Project:
Municipality _____ Block No. ____ Lot No. ____
Street Address _____ Zip _____
3. Name of Applicant (print): _____
4. Applicant's
Present Address: _____
5. Applicant's Phone Number: _____
6. Type Of Facility:
 - Residential
 - Commercial/InstitutionalSpecify Type of Establishment: _____
7. Type of Wastes to be Discharged:
 - Sanitary Sewage
 - Industrial Wastes
 - Other—Specify Type _____
8. If d. or e. in 1. above are checked, indicate the type of malfunction and its cause (check all that apply):
 - Contamination of nearby wells or surface water bodies by sanitary sewage or effluent
 - Ponding or breakout of sanitary sewage or effluent onto the surface of the ground
 - Seepage of sanitary sewage or effluent into portions of building below ground
 - Back-up of sanitary sewage into the building served, which is not caused by a physical blockage of the internal plumbing
 - Any manner of leakage observed from components that are not designed to emit sanitary sewage or effluent.
 - Direct discharges to ground water (no zone of treatment)Describe the cause of the malfunction: _____
9. Please expand on Question #1, above, by checking if any of the following apply):
 - A privy, outhouse, latrine or pit toilet is present, a system must be installed,
 - A system must be upgraded as part of a real property transfer,
 - A cesspool has been identified during a real property transfer and a conforming system must be installed,
 - A malfunctioning cesspool has been identified and a conforming system must be installed.
10. Other Approvals/Certification/Waivers/Exemptions (Attach to Application):
 - Pinelands Commission
 - Highlands Water Protection and Planning Act

THIS IS A COURTESY COPY OF THIS RULE. ALL OF THE DEPARTMENT'S RULES ARE COMPILED IN TITLE 7 OF THE NEW JERSEY ADMINISTRATIVE CODE.

- U.S. Army Corps of Engineers
- NJDEP—Bureau of Flood Plain Management
- Other—Specify:

11. I hereby certify that the information furnished on Form 1 of this application is true. I am aware that false swearing is a crime in this State and subject to prosecution.

Signature of Applicant _____ Date _____

FOR AGENCY USE ONLY

- Application Denied—Reason for Denial/Citation of Rules Violated: _____
- Application Approved
- Application Approved Subject to Approval by NJDEP
- Date of Action _____ Signature of Authorized Agent _____
- Name and Title _____

COUNTY/MUNICIPALITY _____

APPLICATION FOR PERMIT TO CONSTRUCT/ALTER/REPAIR AN INDIVIDUAL SUBSURFACE SEWAGE DISPOSAL SYSTEM

Form 2a—General Site Evaluation Data Lot ____ Block ____

1. Name of Site Evaluator (print): _____
2. Business Address of Site Evaluator: _____
3. Business Phone Number of Site Evaluator: _____
4. Special Site Limitations Identified (Check appropriate Categories):
 - Flood Plains Bedrock Outcrops Wetlands
 - Excessively Stony Disturbed Ground Sink Holes
 - Sand Dunes Steep Slopes
 - Other—Specify _____
5. Soil Logs—Enter on Form 2b—Use one sheet for each soil log.
6. Considerations Relating to Disturbed Ground:
 - a) Type of Disturbance (Check appropriate categories):
 - Filled Area Excavated Area Re-graded Area
 - Subsurface Drains Other—Specify ____
 - b) Existing Ground Surface
Elevation Relative to Ground Surface _____
Method of Identification _____
 - c) Suitability of Disturbed Ground
 - Unsuitable: Objects Subject to Disintegration or Change in Volume
 - Excessively Coarse
 - Proctor Test performed_% Standard Proctor Density = _____
7. Hydraulic Head Test:
 - a) Hydraulically Restrictive Horizon: Depth Top to Bottom _____
 - b) Piezometer A: Depth to Bottom Depth of Water Level (24 hrs)
 - c) Piezometer B: Depth to Bottom Depth of Water Level (24 hrs)
 - d) Witnessed by _____ Signature _____ Date _____
8. Attachments (Check items included):
 - Site Plan
 - Key Map Showing Location of Site On U.S.G.S. Quadrangle or Other Accurate Map
 - Key Map Showing Location of Site on U.S.D.A. Soil Survey Map
 - Other—Specify _____
9. I hereby certify that the information furnished on Form 2a of this application (and the attachments thereto) is true and accurate. I am aware that falsification of data is a violation of the Water Pollution Control Act (N.J.S.A. 58:10A-1 et seq.) and is subject to penalties as prescribed in N.J.A.C. 7:14-8.

THIS IS A COURTESY COPY OF THIS RULE. ALL OF THE DEPARTMENT'S RULES ARE COMPILED IN TITLE 7 OF THE NEW JERSEY ADMINISTRATIVE CODE.

Signature of Soil Evaluator _____ Date _____
 Signature of Professional Engineer _____ License # _____

COUNTY/MUNICIPALITY _____

APPLICATION FOR PERMIT TO CONSTRUCT/ALTER/REPAIR AN INDIVIDUAL SUBSURFACE SEWAGE DISPOSAL SYSTEM

Form 2b—Soil Log and Interpretation Lot ___ Block ___

1. Log Number ___ Method (Check One): Profile Pit Boring
2. Soil Log
 Depth (inches)
 Top-Bottom
 Munsel Color Name and Symbol; Estimated Textural Class: Estimated Volume % Coarse Fragment, If Present; Structure; Moist or Dry Consistence; Mottling—Abundance, Size and Contrast, If Present
3. Ground Water Observations:
 Seepage—Indicate Depth _____
 Pit/Boring Flooded—Depth after ___ Hours _____
4. Soil Limiting Zones (Check Appropriate Categories):
 Fractured Rock Substratum—Depth to Top _____
 Massive Rock Substratum—Depth to Top _____
 Excessively Coarse Horizon—Depth Top to Bottom ___
 Excessively Coarse Substratum—Depth to Top _____
 Hydraulically Restrictive Horizon—Depth Top to Bottom ___
 Hydraulically Restrictive Substratum—Depth to Top _____
 Perched Zone of Saturation—Depth Top to Bottom _____
 Regional Zone of Saturation—Depth to Top _____
5. Soil Suitability Classification:
6. I hereby certify that the information furnished on Form 2b of this application is true and accurate. I am aware that falsification of data is a violation of the Water Pollution Control Act (N.J.S.A. 58:10A-1 et seq.) and is subject to penalties as prescribed in N.J.A.C. 7:14-8.

Signature of Site Evaluator _____ Date _____
 Signature of Professional Engineer _____ License # _____

COUNTY/MUNICIPALITY _____

APPLICATION FOR PERMIT TO CONSTRUCT/ALTER/REPAIR AN INDIVIDUAL SUBSURFACE SEWAGE DISPOSAL SYSTEM

Form 3a. Soil Permeability Data Lot ___ Block ___

Assign a number for each test and a letter for each test replicate. Show test data and calculations on Form 3b, 3c, 3d, 3e, 3f or 3g. Use one sheet for each separate test or test replicate.

1. Summary of Data—Enter data for each test replicate on a separate line.

Type of Test	Test (number)	Replicate (letter)	Depth (inches)	Result*

THIS IS A COURTESY COPY OF THIS RULE. ALL OF THE DEPARTMENT'S RULES ARE COMPILED IN TITLE 7 OF THE NEW JERSEY ADMINISTRATIVE CODE.

* For tube permeameter, pit-bailing and piezometer tests report results in inches per hour. For Soil permeability class rating give soil permeability class number. For percolation test report result in minutes per inch. For basin flooding test report result as positive if basin drains completely within 24 hours after second filing, negative otherwise.

- 2. Design Permeability/Percolation Rate: Specify Test Number _____
 - _ Average of Test Replicates
 - _ Single Replicate
 - _ Slowest of Replicates

Type of Limiting Zone Identified	Test Number

- 4. Attachments (Check items included):
 - _ Form 3b—Tube Permeameter Test Data—Number of Sheets ___
 - _ Form 3c—Soil Permeability Class Rating Test Data—Number of Sheets _____
 - _ Form 3d—Percolation Test Data—Number of Sheets___
 - _ Form 3e—Pit-Bailing Test Data—Number of Sheets___
 - _ Form 3f—Piezometer Test Data—Number of Sheets___
 - _ Form 3g—Basin Flooding Test Data—Number of Sheets___
- 5. I hereby certify that the information furnished on Form 3a of this application (and the attachments thereto) is true and accurate. I am aware that falsification of data is a violation of the Water Pollution Control Act (N.J.S.A. 58:10A-1 et seq.) and is subject to penalties as prescribed in N.J.A.C. 7:14-8.
 Signature of Soil Evaluator _____ Date _____
 Signature of Professional Engineer _____ License # _____

Form 3b. Tube Permeameter Test Data

- 1. Test Number ___ Replicate (Letter) ___ Date Collected _
- 2. Material Tested: _ Fill _ Test in Native Soil—Indicate Depth ___
- 3. Type of Sample: _ Undisturbed _ Disturbed
- 4. Sample Dimensions: Inside Radius of Sample Tube, R, in cm ___ Length of Sample, L, in inches _____
- 5. Bulk Density Determination (Disturbed Samples Only):
 Sample Weight (Wt. Tube Containing Sample—Wt. of Empty Tube), grams _____
 Sample Volume ($L \times 2.54\text{cm./inch} \times 3.14R^2$), cc _____
 Bulk Density (Sample Wt./Sample Volume), grams/cc _____
- 6. Standpipe Used: _ No _ Yes —Indicate Internal Radius, cm _____
- 7. Height of Water Level Above Rim of Test Basin, in inches:
 At the Beginning of Each Test Interval, H_1 _____
 At the End of Each Test Interval, H_2 _____
- 8. Rate of Water Level Drop (Add additional lines if needed):

Time, Start of Test Interval, t_1	Time, End of Test Interval t_2	Length of Test Interval, t , minutes

THIS IS A COURTESY COPY OF THIS RULE. ALL OF THE DEPARTMENT'S RULES ARE COMPILED IN TITLE 7 OF THE NEW JERSEY ADMINISTRATIVE CODE.

--	--	--

9. Calculation of Permeability:
 $K, (\text{in/hr}) = 60 \text{ min/hr} \times r^2/R^2 \times L(\text{in})/T(\text{min}) \times \ln(H_1/H_2)$
 $= 60 \text{ min/hr} \times _ / _ \times _ / _$
 $\times \ln(_ / _) = _$
10. Defects in the Sample (Check appropriate items):
 None Cracks Worm Channels
 Root Channels Soil/Tube Contact
 Large Gravel Large Roots
 Dry Soil Smearing Compaction
 Other—Specify _____
11. I hereby certify that the information furnished on Form 3b of this application is true and accurate. I am aware that falsification of data is a violation of the Water Pollution Control Act (N.J.S.A. 58:10A-1 et seq.) and is subject to penalties as prescribed in N.J.A.C. 7:14-8.
 Signature of Site Evaluator _____ Date _____
 Signature of Professional Engineer _____ License # _____

Form 3c. Soil Permeability Class Rating Data

1. Test Number ____ Replicate (Letter) ____
2. Sample Depth_Soil Pit/Boring Number_Date Collected__
3. Coarse Fragment Content:
 Total Weight of Sample, W.T., grams _____
 Weight of Material Retained on 2mm sieve, W.C.F., grams____
 Wt. % Coarse Fragment (W.C.F./W.T. x 100): _____
4. Oven Dry Weight (24 hrs., 105°C) of 40 Gram Air Dry Sample, grams, Wt _____
5. Hydrometer Calibration, Rc _____
6. Hydrometer calibration temperature (°F) _____
7. Hydrometer Reading—40 seconds, grams, R1 _____
 Temperature of Suspension, °F _____
8. Corrected Hydrometer Reading, grams, R1' _____
9. Hydrometer Reading—2 hours, grams, R2 _____
 Temperature of Suspension, °F _____
- 10 Corrected Hydrometer Reading, grams, R2' _____
11. % sand = (Wt. - R1')/Wt. x 100 = (_ - _) / _ x 100 = ____
12. % clay = R2'/Wt. x 100 = _ / _ x 100 = _____
13. Sieve Analysis:
 a. Oven Dry Wt. (2 hrs., 105°C) Total Sand Fraction (Soil Retained in 0.047 mm Sieve), grams _____
 b. Wt. of Fine Plus Very Fine Sand Fraction (Sand Passing 0.25 mm Sieve), grams _____
 c. % Fine Plus Very Fine Sand (b/a) _____
14. Soil Morphology (Natural Soil Samples Only):
 Structure of Soil Horizon Tested _____
 Consistence of Soil Horizon Tested: Dry ___ Moist ___
15. Soil Permeability Class Rating (Based upon average textural analysis of this replicate and other replicate samples) _____
16. I hereby certify that the information furnished on Form 3c of this application is true and accurate. I am aware that falsification of data is a violation of the Water Pollution Control Act (N.J.S.A. 58:10A-1 et seq) and is subject to penalties as prescribed in N.J.A.C. 7:14-8.
 Signature of Site Evaluator _____ Date _____
 Signature of Professional Engineer _____ License # _____

Form 3d. Percolation Test Data

1. Test Number ___ Replicate (Letter)___ Date Tested ___
2. Depth _____
3. Pre-soak: _____
 - ___ Sandy Textured Soil Only, Shortened Pre-soak—Indicate Time Required for 12 Inches of Water to Drain After Second Filling, Minutes _____
 - ___ Four Hour Pre-soak Completed—Indicate Result:
 - ___ Test Hole Drained Within 16 to 24 Hours After Pre-soak
 - ___ Test Hole Did Not Drain Within 24 Hours After Pre-soak
4. Rate of Fall Data:
 - a. Time Interval Selected, Minutes _____
 - b. Record the Drop in Water Level During Each Time Interval to the Nearest 1/10th-Inch On the Lines Below:

Depth of Water, Start of Interval (inches)	Depth of Water, End of Interval (inches)	Drop in Water Level(Inches)

5. Percolation Rate:
 - a. Time, minutes, Required for a Six-inch Drop in Water Level___
 - b. Percolation Rate = $a/6 = _ / 6 = _ \text{ min/in}$
6. I hereby certify that the information furnished on Form 3d of this application is true and accurate. I am aware that falsification of data is a violation of the Water Pollution Control Act (N.J.S.A. 58:10A-1 et seq.) and is subject to penalties as prescribed in N.J.A.C. 7:14-8.
 Signature of Site Evaluator _____ Date _____
 Signature of Professional Engineer _____ License # _____

Form 3e. Piezometer Test Data

1. Test Number ___ Reference Soil Log ___ Date Tested ___
2. Diameter of Soil Auger, in. ___ Depth of Test Hole, in. ___
 Inside Radius of Pipe, R, in. _____
3. Depth to Apparent Static Water Level, in. _____
4. Measure and Record:

Water Depth, Start of Interval inches, d ₁	Time at Start of Interval	Water Depth, End of Interval inches, d ₁	Time at End of Interval	Length of Interval, min, t

THIS IS A COURTESY COPY OF THIS RULE. ALL OF THE DEPARTMENT'S RULES ARE COMPILED IN TITLE 7 OF THE NEW JERSEY ADMINISTRATIVE CODE.

5. Depth to Water Level After 24 Hour Stabilization Period, Dstatic in. _
6. Value of A-parameter _____
7. Calculation of Permeability:
 $K, \text{ in/hr} = [(3.14R^2)/(A \times t)] \times [\ln(d_1 - D_{\text{stat}}/d_2 - D_{\text{stat}})] \times 60 \text{ min/hr} =$
 $[(3.14 \text{ ___})/(\text{___} \times \text{___})] \times [\ln(\text{___} - \text{___}/\text{___} - \text{___})] \times 60 \text{ min/hr} = \text{___}$
8. I hereby certify that the information furnished on Form 3e of this application is true and accurate. I am aware that falsification of data is a violation of the Water Pollution Control Act (N.J.S.A. 58:10A-1 et seq.) and is subject to penalties as prescribed in N.J.A.C. 7:14-8.
 Signature of Site Evaluator _____ Date _____
 Signature of Professional Engineer _____ License # _____

Form 3f. Pit-Bailing Test Data

1. Test Number ___ Reference Soil Log ___ Date Tested ___
2. Using the reference level established, measure and record the following:
 —Depth to Bottom of Pit, ft, D_{pit} _____
 —Depth to Water Level after 2 hr. Stabilization Period, ft, D_{water} _____
 —Depth to Impermeable Stratum, ft, D_{stratum} _____ (If depth is unknown assume it to be 1.5 times the depth of the pit.)
 —Height of Water Level Above Impermeable Stratum, ft, H ___ (H = D_{stratum} - D_{water})
 —Length of Time Interval, T, in minutes _____
3. At the interval chosen, record the following data in the table below:
 —Time of Measurement, t_n, minutes
 —Depth of Water Level Below Reference Level, d_n, inches
 —Water Surface Dimensions, ft: l,w
4. Calculate the following values and enter in the table below:
 —Water Surface Area, ft², A_n
 —Water level Rise h_{rise} (Subtract current value of d_n from previous value)
 —Ave. Water Surface Area, ft², A_{av} (Take average of A_n and previous A_n)
 —Ave. Height of Water Level Above Impermeable Stratum, ft, h (Take ave. of d_n and previous value of d_n, convert to ft., and subtract from D_{stratum})
 —Permeability, in/hr, K_a (Calculate using formula): $K_a = [h_{\text{rise}}/T] \times [A_{\text{av}} / 2.27 (H^2 - h^2)] \times 60 \text{ min/hr}$

t _n	d _n (in.)	l, w (ft ²)	A _n (ft ²)	h _{rise} (in)	A _{av} (ft ²)	H (ft)	K _a
t ₀				XXXX	XXXX	XXXX	XXXX
T ₁							
T ₂							
T ₃							
T ₄							
T ₀				XXXX	XXXX	XXXX	XXXX
T ₁							
T ₂							
T ₃							
T ₄							
T ₀				XXXX	XXXX	XXXX	XXXX
T ₁							
T ₂							
T ₃							

T4							
----	--	--	--	--	--	--	--

5. Record the Following Data:
 - Final Depth of Pit, D_{pit} , ft _____
 - Depth to Impermeable Stratum, ft, $D_{stratum}$ _____ (If no impermeable stratum is encountered assume $D_{stratum} = D_{pit}$)
 - Height of Standpipe Above Reference Level, ft, h_{pipe} _____
 - Depth to Water Level after 24 hr. Stabilization Period, ft, D_{water} _____ (Take measurement from top of standpipe. Subtract h_{pipe})
 - Height of Static Water Level Above Impermeable Stratum, ft, H _____ ($H = D_{stratum} - D_{water}$)
 - Average Height of Water Level Above Impermeable Stratum, ft, h _____ (Take average of d_n from beginning and end of last time interval recorded in section 4, convert this to ft., subtract from $D_{stratum}$)
6. Re-calculation of K using data from section 5 above and from final time interval of section 4:
 $K = [h_{rise}/t] \times [A_{av}/2.27(H^2 - h^2)] \times 60 \text{ min/hr} = [_ / _] \times [_ / 2.27 (_ - _)] \times 60 \text{ min/hr} = _$
7. I hereby certify that the information furnished on Form 3f of this application is true and accurate. I am aware that falsification of data is a violation of the Water Pollution Control Act (N.J.S.A. 58:10A-1 et seq.) and is subject to penalties as prescribed in N.J.A.C. 7:14-8.
 Signature of Site Evaluator _____ Date _____
 Signature of Professional Engineer _____ License # _____

Form 3g. Basin Flooding Test Data

1. Test Number _____ Reference Soil Log _____ Date Tested _____
2. Depth of Pit, ft _____
3. Area of Pit, ft^2 _____
4. Description of Rock Substratum Within Test Zone:
 - Type of Rock _____
 - Name of Formation _____
 - Average Fracture Spacing _____
 - Type of Fractures (Check Appropriate Category):
 - ___ Open (Wide), Clean—Width of Openings, mm _____
 - ___ Open (Wide), Infilled with Fines—Width of Openings, mm _____
 - ___ Tight (Closed)
 - Orientation of Fractures:
 - ___ Horizontal (Parallel to Pit Bottom) Or Nearly So
 - ___ Inclined
 - ___ Vertical (Parallel to Sides of Pit) Or Nearly So
 - Hardness of Rock:
 - ___ Rippable with Hand Tools
 - ___ Not Rippable with Hand Tools, Rippable by Machine
 - ___ Not Rippable by Machine, Explosives Used
5. Time of First Basin Flooding _____
 Volume of Water Added, Gal. _____
6. Result of First Basin Flooding:
 - ___ Basin Drained within 24 Hrs.—Indicate Time _____
 - ___ Basin Not Drained within 24 Hrs.
7. Time of Second Basin Flooding _____
 Volume of Water Added, Gal. _____
8. Result of Second Basin Flooding:
 - ___ Basin Drained within 24 Hrs.—Indicate Time _____

THIS IS A COURTESY COPY OF THIS RULE. ALL OF THE DEPARTMENT'S RULES ARE COMPILED IN TITLE 7 OF THE NEW JERSEY ADMINISTRATIVE CODE.

Basin Not Drained within 24 Hrs.

9. I hereby certify that the information furnished on Form 3g of this application is true and accurate. I am aware that falsification of data is a violation of the Water Pollution Control Act (N.J.S.A. 58:10A-1 et seq.) and is subject to penalties as prescribed in N.J.A.C. 7:14-8.

Signature of Site Evaluator _____ Date _____
Signature of Professional Engineer _____ License # _____

Form 4. General Design Data

1. Volume of Sanitary Sewage, gal. _____
 Residential: No. of Dwelling Units _ Total No. of Bedrooms _
 Commercial/Institutional—Indicate type of establishment and show method of calculation. If estimate is based on water meter data, indicate source of data, frequency of readings, average daily flow, and maximum recorded daily reading _____
2. Alterations or Repairs
 - a) Reason for Alteration or Repair (Check appropriate categories):
 Expansion or Change in Use Upgrade Existing Facilities
 Correct Malfunctioning System Other—Specify _____
 - b) Describe Nature of Alteration or Repairs: _____
3. System Components:
 - a) Grease Trap Capacity, gals _____
Show Calculation Used: _____
 - b) Septic Tank Capacities, gals: First (Single) Compartment Second Compartment Third Compartment _____
 - c) Effluent Distribution
Method: Gravity Flow Gravity Dosing Pressure Dosing
Dosing Device: Pump Siphon
 - d) Dosing Tank Capacities, gals: Total Capacity _ Dose Volume _ Reserve Capacity _____
 - e) Laterals: Number _ Total Length _ Pipe Size _ Spacing _
 - f) Connecting Pipe: Size __ Length __
 - g) Manifold: Size __ Length __
 - h) Disposal Field: Type of Installation _____
Design Permeability (Percolation Rate) _____
Trenches: Width __ Total Length __ Bed: Area _
 - i) Seepage Pits: Design Percolation Rate _____
Number of Pits __ Total Percolating Area Provided _
4. Attachments (Check items included):
 General Plan of System Showing Location of All System Components
 X-Sections of Each System Component Including Grease Trap, Septic Tank, Dosing Tank, Disposal Field, Seepage Pits and Interceptor Drains
 Pump Performance Curve
 Other—Specify _____
5. I hereby certify that the information furnished on Form 4 of this application (and attachments thereto) is true and accurate. I am aware that falsification of data is a violation of the Water Pollution Control Act (N.J.S.A. 58:10A-1 et seq.) and is subject to penalties as prescribed in N.J.A.C. 7:14-8.
Signature of Professional Engineer _____ Date _____

Form 5. Design of Pressure Dosing System

1. Configuration of Distribution Network:
Type of Manifold: End Central
Distribution Laterals: Number _ Length, ft _ Spacing, ft _
Hole Diameter, ins _ Hole Spacing, ins _

THIS IS A COURTESY COPY OF THIS RULE. ALL OF THE DEPARTMENT'S RULES ARE COMPILED IN TITLE 7 OF THE NEW JERSEY ADMINISTRATIVE CODE.

- Diameter of Laterals, ins _
2. Lateral Discharge Rate:
Design Pressure Head at Supply End of Laterals, Hp, ft _
Hole Discharge Rate, Q, gpm _
Number of Holes per Lateral, n _
Lateral Discharge Rate, (Q x n) gpm _
3. Manifold Length, ft _ Manifold Diameter, ins _
4. System Discharge Rate, gpm _
5. Dose Volume:
Design Volume of Sewage, gal/day _
Design Permeability, in/hr _ or Percolation Rate, min/in _
Internal Volume of Distribution Network _
Dose Volume _
- 6a. Pump Selection:
Diameter of Delivery Pipe _ Length of Delivery Pipe _
Friction Loss in Delivery Pipe, Hf, ft _
Elevation of Dosing Tank Low Water Level _
Elevation of Lateral Invert _
Elevation Head, He, ft _
Total Operating Head, Ht (Hp + Hf + He), ft _
Pump Model _ Rated Horsepower _
Pump Discharge Rate at Total Operating Head, gpm _
- 6b. Siphon Elevation:
Diameter of Delivery Pipe _ Length of Delivery Pipe _
Friction Loss in Delivery Pipe, Hf, ft _
Velocity Head, Hv, ft _
Total Operating Head, Ht (Hp + Hf + Hv), ft _
Elevation of Lateral Invert _
Elevation of Siphon Invert _
7. I hereby certify that the information furnished on Form 4 of this application (and attachments thereto) is true and accurate. I am aware that falsification of data is a violation of the Water Pollution Control Act (N.J.S.A. 58:10A-1 et seq.) and is subject to penalties as prescribed in N.J.A.C. 7:14-8.
Signature of Professional Engineer _____ Date _____

APPENDIX C UNIFORM PLACEMENT OF PERCOLATION TESTS

Uniform Placement of Percolation Tests

N.J.A.C. 7:9A-6.1(e)7 of these standards requires that percolation tests be spaced uniformly within the area of the disposal field. Acceptable patterns or arrangements for percolation test placement depend upon the size and shape of the disposal field as outlined below. Patterns other than those provided below may be approved provided that it is determined by the Administrative Authority that the test results submitted are representative of the soil conditions throughout the entire area of the disposal field.

Definitions

The following words and terms shall have the following meanings when used within Appendix B of this chapter:

"Center" means the intersection of the two disposal field diagonals.

"Diagonal" means a line connecting opposite corners of the disposal field.

"Elongated disposal field" means a disposal field with a length/width ratio of 3.0-5.0.

"End" means one of the two shorter sides in a disposal field which has a length/width ratio not equal to 1.0.

"Length" means the longest dimension of the disposal field, or the distance between the ends of the disposal field.

"Long axis" means a line connecting the midpoints of the disposal field ends.

"Rectangular disposal field" means a disposal field with a length/width ratio of 1.5-3.0.

"Side" means one of the two longer sides of a disposal field which has a length/width ratio not equal to 1.0.

"Square disposal field" means a disposal field with a length/width ratio of 1.0-1.5.

"Very elongated disposal field" means a disposal field with a length/width ratio greater than 5.0.

"Width" means the shortest dimension of the disposal field, or the distance between the sides of the disposal field.

A. When the disposal field is less than 1500 square feet, a minimum of two percolation tests are required and the following arrangements are acceptable:

All Disposal Field Shapes

1. Both tests spaced along the long axis of the field, the minimum distance between tests one third of the length of the field.

2. Both tests spaced along the diagonal of the field, the minimum distance between tests one third the length of the diagonal.

B. When the disposal field size is 1500 to 3000 square feet, a minimum of three percolation tests are required and the following arrangements are acceptable:

All Disposal Field Shapes

1. All tests spaced evenly along the diagonal of the field, the minimum distance between tests one quarter the length of the diagonal.

2. One test near the midpoint of a side, one test near each of the two opposite corners.

Field Shape Rectangular to Very Elongated (L/W > 1.5)

3. All three tests spaced evenly along the long axis; minimum distance between tests one quarter the length of the disposal field.

C. When the disposal field size is 3000 to 4500 square feet, a minimum of four percolation tests are required and the following arrangements are acceptable:

Field Shape Square to Rectangular (L/W = 1.0 - 3.0)

1. One test near the midpoint of each of the sides and ends.
2. One test near each of the four corners.

All Field Shapes

3. A zig-zag pattern with tests placed at points along one side which are approximately zero thirds and two thirds the distance from end to end, and along the opposite side at points which are approximately one third and three thirds the distance from end to end.

Field Shape Elongated to Very Elongated (L/W > 3.0)

4. All tests spaced evenly along the long axis of the field, the minimum distance between tests one fifth the length of the field.

5. All tests spaced evenly along the diagonal of the field, the minimum distance between tests one fifth the length of the diagonals.

D. When the disposal field size exceeds 4500 square feet, a minimum of five percolation tests are required and the following arrangements are acceptable:

Square Fields

1. One test near the midpoints of each of the sides and ends, one test near the center of the field.

Field Shape Square to Rectangular (L/W = 1.0 - 3.0)

2. One test near each corner of the field, one test near the center of the field.

All Field Shapes

3. A zig-zag pattern with tests placed at points along one side which are approximately zero fourths, two fourths and four fourths the distance from end to end, and along the opposite side at points which are approximately one fourth and three fourths the distance from end to end.

Field Shape Elongated to Very Elongated (L/W > 3.0)

4. All tests spaced evenly along the long axis of the field, the minimum distance between tests one sixth the length of the field.

5. All tests spaced evenly along the diagonal of the field, the minimum distance between tests one sixth the length of the diagonal.

Uniform Placement of Percolation Tests—Figures

- (a) Square Disposal Fields, L/W = 1.0 - 1.5
- (b) Rectangular Disposal Fields, L/W = 1.5 - 3.0
- (c) Elongated Disposal Fields, L/W = 3.0 - 5.0

THIS IS A COURTESY COPY OF THIS RULE. ALL OF THE DEPARTMENT'S RULES ARE COMPILED IN TITLE 7 OF THE NEW JERSEY ADMINISTRATIVE CODE.

(d) Very Elongated Disposal Fields, $L/W > 5$

A. Disposal Field Size Up To 1500 Square Ft.— Minimum of 2 Percolation Tests Required

B. Disposal Field Size 1500-3000 Square Ft.— Minimum of 3 Percolation Tests Required

C. Disposal Field Size 3000-4500 Square Ft.— Minimum of 4 Percolation Tests Required

D. Disposal Field Size 4500- Square Ft.— Minimum of 5 Percolation Tests Required

The figures are not included in this document, but if they are required, please refer to the official version of the regulation. It is typically sufficient to distribute the sample points in a uniform manner.

APPENDIX D SOIL SUITABILITY CLASSIFICATION OF NEW JERSEY SOILS

Explanation of the Soil Suitability Classification System

The suitability of soil for onsite disposal of sanitary wastewater by means of individual subsurface sewage disposal systems is classified based upon the type and depth of soil limiting zones as outlined below. Definitions and criteria for recognition of soil limiting zones are provided in Subchapters 2 and 5 of this chapter.

Type of Limiting Zone	Depth, ft.	Suitability Class
Fractured Rock or Excessively Coarse Substrata	>5	I
Massive Rock or Hydraulically Restrictive	>9	I
Restrictive Substrata	4-9	IISr
	0-4	IIISr
Hydraulically Restrictive Horizon, Permeable Substratum	>9	I
	4-9	IIHr
Excessively Coarse Horizon	0-4	IIHr
	>5	I
Zone of Saturation, Regional	0-5	IIHc
	>5	I
	2-5	IIWr
Zone of Saturation, Perched	0-2	IIWr
	>5	I
	2-5	IIWp
	0-2	IIWp

The soil suitability classification consists of a Roman numeral from I to III which is indicative of the severity of the limitation and a letter symbol which indicates the type of limiting zone. (In general the limitation is considered more severe when the limiting zone occurs at a shallower depth in or below the soil profile). Where more than one type of limiting zone is present, the primary classification of the soil is based upon whichever limiting zone(s) presents the most severe limitation (highest numerical symbol). Secondary limitations are given based upon limitations which are less severe (lower numerical symbols). The primary classification is stated first, followed by secondary classifications in parentheses. For example, the classification for a soil with a seasonally high water table (top of a regional zone of saturation) at a depth of 1.5 feet and a massive rock substratum at a depth of 7 feet would be IIIWr(IISr).

Where two or more limiting zones are present with the same degree of limitation, a compound symbol is used in primary or secondary classifications, consisting of a Roman numeral showing the degree of limitation together with a letter symbol for each type of limited zone. For example, the classification for a soil with a seasonally high water table at a depth 2.5 feet and a fractured rock substratum at a depth of 3 feet would be IIWrSc.

Soil Suitability Classes of New Jersey Soil Series

The type of standard septic system installation, if any, which can be approved on a specific site depends upon the soil suitability class which must be determined based upon detailed onsite soil evaluation. Such evaluation is costly and would normally not be performed prior to the purchase of land or the granting of preliminary or conceptual

THIS IS A COURTESY COPY OF THIS RULE. ALL OF THE DEPARTMENT'S RULES ARE COMPILED IN TITLE 7 OF THE NEW JERSEY ADMINISTRATIVE CODE.

approvals for large tracts of land which are to be subdivided for residential or commercial development. In these or other situations where more general information regarding soil suitability is required, preliminary determinations may be made based upon information contained in the county soil surveys which are published by the U.S.D.A.—Soil Conservation Service in cooperation with the N.J. Agricultural Experiment Station and Cook College of Rutgers, The State University. These soil surveys contain descriptions of the various soil series which occur in New Jersey together with maps showing the geographic distribution of the soils. At present, published soil surveys or preliminary field maps are available for every county in the state with the exception of Essex and Hudson.

A soil series is a group of similar soil types having major horizons which are similar in thickness, arrangement and other important characteristics. The soil suitability classes provided for each New Jersey soil series listed below are based primarily upon the soil profile descriptions given in the soil survey reports.

Soil series may be divided into one or more soil phases which differ in the texture of the surface horizon, stoniness or some other property. Although soil phase differences may affect design and construction requirements, they are generally not a factor in determination of the soil suitability class given for a particular soil series. In some cases a soil series may have one or more variants which may differ significantly with respect to the types or depths of soil limiting zones. In such cases each variant is treated as a separate soil type with respect to the classification.

Each soil series is characterized by a range of soil profile characteristics so that two or more soil suitability classes may be possible for a given soil series. The soil suitability classes given below are those which are considered most typical for a given soil series. Other soil suitability classes are possible depending upon conditions which may vary from location to location.

Soil survey maps delineate the boundaries of soil mapping units in which a specific soil series, soil phase, soil complex, association or other grouping is predominant. Within every soil mapping unit however, there may be areas of dissimilar soils which are too small and scattered or otherwise impractical to show at the scale of mapping used. For this reason, use of the soil survey is not a substitute for onsite soil evaluation when detailed information for a specific site is required.

Many soil series in the coastal plain region of southern New Jersey are underlain by stratified sedimentary formations which consist of layers of contrasting grain size. In some cases layers of highly permeable sand and gravel may alternate with hydraulically restrictive layers of silt and clay. Where hydraulically restrictive layers occur at depths less than nine feet they will be a determining factor for the soil suitability classification. The presence of such layers below a depth of five feet however, is generally not indicated in the soil survey reports and therefore may not be reflected in the soil suitability classes given here. As a result, coastal plain soils series which are classified as having no limitation (Roman numeral I) with respect to hydraulically restrictive horizons and substrata may in some locations have IIHr or IISr limitations. In other cases, soil series which are assigned classifications of IISr or IIISr may in some locations have permeable substrata at depths below the extent of soil survey data such that a classification of IIHr or IIIHr may be appropriate.

In the northern portion of the state many soil series are described as having bedrock substrata at shallow depths below the soil profile. Soil survey reports generally do not provide information relative to the permeability of these rock substrata. Rock substrata underlying soil profiles of the same soil series may often range from excessively permeable to relatively impermeable. Soil suitability classes are given to represent those conditions which are considered most typical for a soil series. In many cases, however, soil series which are given classes of I or IISc may in some locations have the more severe limitations associated with classes IISr or IIISr. Classifications of rock substrata given here must be regarded as preliminary in nature and may be subject to modification based upon detailed onsite evaluation and testing.

Soil Series (Variant) Name	Typical Classification(s)
Abbottstown	IIIHR, Wp(IIISc); IISr, Wp(IIISc)

THIS IS A COURTESY COPY OF THIS RULE. ALL OF THE DEPARTMENT'S RULES ARE COMPILED IN TITLE 7 OF THE NEW JERSEY ADMINISTRATIVE CODE.

Adelphia	IIW _r
Adelphia Clayey Substratum	IIIS _r (IIW _r)
Adelphia Glauconitic Variant	IIIS _r (IIW _r)
Adelphia Truncated	IIIW _r
Adrian	IIIW _r
Albia	IIIH _r ,W _p ; IIIS _r ,W _p
Amwell	IIIH _r ,W _p ; IIIH _r ,W _p (IIS _r)
Amwell Rock Substratum	IIIH _r ,W _p ; IIIH _r ,W _p (IIS _r)
Annandale	IIIH _r
Arendtsville	I; IIS _c
Atherton	IIIW _r
Athol	I
Atsion	IIIW _r
Atsion Tide Flooded	IIIW _r
Aura	I; IIH _r
Aura Moderately Firm	I; IIH _r
Aura Ironstone Variant	I; IIH _r
Barclay	IIW _r ; IIIW _r
Bartley	IIIH _r (IIW _p)
Bath	IIIH _r (IIW _p Sc)
Bath Stony	IIIH _r (IIW _p Sc)
Bayboro	IIIS _r W _r
Bayboro Poned	IIIS _r W _r
Bedington	IIS _c
Berks	IIS _c
Berryland	IIIW _r
Berryland Flooded	IIIW _r
Berryland Freq. Flooded	IIIW _r
Berryland Heavy Subsoil Var.	IIIW _r
Bertie	IIIW _r
Bibb	IIIW _r
Biddeford	IIIS _r W _r
Birdsboro	I; IIW _r ; IIS _c ; IIW _r Sc
Birdsboro Gravelly Solum Var.	I
Birdsboro Sandy Subsoil Var.	IIS _c

THIS IS A COURTESY COPY OF THIS RULE. ALL OF THE DEPARTMENT'S RULES ARE COMPILED IN TITLE 7 OF THE NEW JERSEY ADMINISTRATIVE CODE.

Boonton	IIHrWp; IIISrWp
Bowmansville	IIIW _r
Braceville	IIHrWp
Bucks	IISc; IISr
Califon	IIHrWp
Califon Friable Subsoil Var.	IIIW _r
Carisle Muck	IIIW _r
Chalfont	IIISrWp
Chenango	IISc
Chillum	I; IISc; IIISr
Chippewa	IIISrWr
Cokesbury	IIHrWp
Colemantown	IIHrWp
Collington	I
Colonie	I
Colts Neck	I, IIHr
Croton	IIISrWp; IIISrWr
Donlonton	IIHrWr
Downer	I
Downer Clayey Substratum	I
Downer Gravelly Substratum	I; IISc
Downer Loamy Substratum	I
Downer Truncated	I
Doylestown	IIISrWr
Dragstown	IIIW _r ; IIWr
Duffield	I; IISr
Duffield Very Rocky	IISr
Dunellen	I
Dunellen Mod. Well Drained Var.	IIIW _r
Edneyville	I; IISc
Elkton	IIISrWr
Ellington Loamy Subsoil Var.	IISrWpWr, IIISrWpWr
Evesboro	I
Evesboro Clayey Substratum	IIISr; IIHr
Evesboro Sandy Loam Subsoil Var.	I

THIS IS A COURTESY COPY OF THIS RULE. ALL OF THE DEPARTMENT'S RULES ARE COMPILED IN TITLE 7 OF THE NEW JERSEY ADMINISTRATIVE CODE.

Fallsington	IIIW _r
Fallsington Clayey Substratum	IIIH _r
Fallsington Var.	IIIH _r W _r W _p
Fort Mott	I
Fredon	IIIW _r
Freehold	I
Freehold Clayey Substratum	IIIS _r
Fripp	I
Galestown	I
Galestown Clayey Substratum	IIIS _r
Haledon	IIIH _r W _p
Haledon Wet Var.	IIIH _r W _p W _r
Halsey	IIIW _r ; IIIW _r (IIIS _c)
Hammonton	IIW _r ;
Hammonton Clayey Substratum	IIIS _r (IIW _r W _p); IIIH _r (IIW _r W _p)
Hazen	I; IIIS _c
Hazleton	IIIS _c
Hero	IIIS _c W _r ; IIW _r
Hibernia	IIIH _r W _p
Holmdel	IIIW _r ; IIW _r
Holmdel Clayey Substratum	IIIS _r W _r
Holyoke Rocky	IIIS _c ; IIIS _r
Hoosic	I; IIIS _c
Howell	IIW _r ; IIIW _r
Keansburg	IIIW _r
Keyport	IIIS _r (IIW _p)
Klej	IIW _r ; IIIW _r
Klej Clayey Substratum	IIIS _r W _r ; IIIS _r (IIW _r)
Klej Loamy Substratum	IIIS _r W _r ; IIIS _r (IIW _r)
Klinesville Shaly	IIIS _c ; IIIS _r
Kresson	IIIH _r W _p (IIW _r)
Lakehurst	IIW _r ; IIIW _r
Lakehurst Clayey Substratum	IIIS _r W _r W _p ; IIIS _r (IIW _r W _p)
Lakehurst Loamy Substratum	IIW _r ; IIIW _r
Lakehurst Thick Surface	IIW _r ; IIIW _r

THIS IS A COURTESY COPY OF THIS RULE. ALL OF THE DEPARTMENT'S RULES ARE COMPILED IN TITLE 7 OF THE NEW JERSEY ADMINISTRATIVE CODE.

Lakeland	I
Lakeland Firm Substratum	I
Lakeland Water Table	IIWr
Lakewood	I
Lakewood Loamy Substratum	I
Lakewood Thick Surface	I
Lamington	IIIHrWpWr
Lansdale	IISc
Lansdowne	IIIHrWp(IISc); IIIHrWp(IISr)
Lansdowne Var.	IIIHrWp(IISc); IIISrWp
Lawrenceville	IIISrWp; IIIHrWp
Legore	I; IIISr
Lehigh	IIISrWp; IIIHrWp(IISc)
Lenoir	IIISrWr
Leon	IIIWr
Livingston	IIISrWr
Lyons	IIIWr; IIISrWr; IIISrWr(IISc)
Manahawkin	IIIWr;
Marlton	IIIHr(IIWp); IIIHr
Matapeake	IIISr(IIWp); IIISrWp: I
Matapeake Thin Solum	I
Matawan	IIWr; IIIHrWp(IIWr)
Mattapex	IIISr(IIWr); IIWr
Mattapex Clayey Substratum	IIISrWr
Mattapex Glauconitic Substratum	IIWr
Meckesville	IIIHr(IIWp)
Middlebury	IIIWr
Minoa	IIIWr
Mount Lucas	IIIWp(IISr)
Mullica	IIIWr
Mullica Loamy Substratum	IIIWr
Nassau	IIISr; IISc
Neshaminy	IIISr
Neshaminy Fragipan Var.	IIISrWp; IIIHrWP
Netcong	I

THIS IS A COURTESY COPY OF THIS RULE. ALL OF THE DEPARTMENT'S RULES ARE COMPILED IN TITLE 7 OF THE NEW JERSEY ADMINISTRATIVE CODE.

Nixon	I
Nixon Var.	IIW _r ; IIIW _r
Nixonton	IIIW _r
Norton	IIH _r
Norwich	IIH _r W _r
Oquaga	IISc; IIISr(IISc)
Othello	IIIW _r
Otisville	IISc
Palmyra	IISc
Parker	IISc
Parker Rocky	IISc
Parsippany	IIH _r W _r ; IIISrW _r
Parsippany Sandy Loam Substratum	IIH _r W _r
Parsippany Var.	IIISrW _r
Pasquotank	IIIW _r
Pattenburg	IISc
Pattenburg Moderately Wet	IIScW _r ; IIIW _r (IISc)
Pemberton	IIW _r ; IIIW _r
Pemberton Thick Surface	IIW _r ; IIIW _r
Penn	IISc; IIISr
Penn Shaly	IISc; IIISr
Phalanx	IISc
Plummer	IIIW _r
Plummer Very Wet	IIIW _r
Pocomoke	IIIW _r
Pompton	IIIW _r ; IIIW _r (IISc)
Pope	I; IISc
Portsmouth	IIIW _r
Preakness	IIIW _r
Preakness Dark Surface Var.	IIIW _r
Quakertown	IISc; I
Quakertown Channery	IISc
Raritan	IIH _r W _p ; IIH _r W _p (IISc); IIH _r W _p (IISr)
Raynham	IIIW _r
Readington	IIH _r W _p (IISc); IIW _p SrSc; IIW _r Sc

THIS IS A COURTESY COPY OF THIS RULE. ALL OF THE DEPARTMENT'S RULES ARE COMPILED IN TITLE 7 OF THE NEW JERSEY ADMINISTRATIVE CODE.

Reaville	IIISrWp(IIHc)
Reaville Deep Var.	IIISrWp(IIHc)
Reaville Wet Var.	IIISrWp(IIHc)
Ridgebury	IIIHrWp
Riverhead	I; IISc
Riverhead Neutral Var.	I; IISc
Rockaway	IIIHrWp
Rowland	IIIW _r
Royce	IISc
Sassafras	I
Sassafras Clayey Substratum	IIISr; IISr; IIIHr; IIHr
Sassafras Water Tabl	IIW _r
Shrewsbury	IIIW _r
Shrewsbury Clayey Substratum	IIIW _r Sr
Shrewsbury Ironstone Var.	IIIW _r Hr
Shrewsbury Truncated	IIIW _r
Sloan	IIIW _r
Steinsburg	IISc
St. Johns	IIIW _r
St. Johns Clayey Substratum	IIIW _r Sr
Swartswood	IIIHrWp
Tinton	I
Tinton Thick Surface	I;
Tioga	I; IIW _r ; IIW _r Sc; IISc
Turbotville	IIIHrWp
Unadilla	I
Valois	I
Venango	IIIHrWp; IIISrWp
Wallkill	IIIW _r
Washington	I; IISc
Wassaic	IISc; IIISr
Wassaic Rocky	IISc; IIISr
Watchung	IIIHrWpW _r
Wayland	IIIW _r ; IIIW _r Sr
Weeksville	IIIW _r

THIS IS A COURTESY COPY OF THIS RULE. ALL OF THE DEPARTMENT'S RULES ARE COMPILED IN TITLE 7 OF THE NEW JERSEY ADMINISTRATIVE CODE.

Westphalia	I
Whippany	IIISrWp;
Whippany Sandy Loan Substratum	IIIHrWp
Whitman	IIIHrWp
Woodmansie	I
Woodmansie Firm Substratum	I
Woodmansie Loamy Substratum	I
Woodstown	IIIW _r ; IIW _r
Woodstown Clayey Substratum	IIIW _r Sr; IIIW _r (IISr); IIW _r Sr;
Woodstown Loamy Substratum	IIIW _r ; IIW _r
Wooster	IISc; I
Wurtsboro	IIIHrWp; IIIHrWp(IISc)

THIS IS A COURTESY COPY OF THIS RULE. ALL OF THE DEPARTMENT'S RULES ARE COMPILED IN TITLE 7 OF THE NEW JERSEY ADMINISTRATIVE CODE.

Following is a listing of miscellaneous mapping unit designations which do not consist of any one specific soil series or soil series variant. In general these mapping units cannot be assigned a soil suitability class due to extreme variability or a lack of data. The type of limitations which are generally associated with these mapping units are indicated below:

Mapping Unit Designation	Type(s) of Limitations
Alluvial Land (Various Modifying Terms)	Flooding, Wetland
Clayey Land-Keyport Materials	Hydraulically Restrictive Substrata
Clayey Land-Marlton Materials	Hydraulically Restrictive Substrata
Clay Pits	Disturbed Ground, Hydraulically Restrictive Substrata
Coastal Beach	Dunes, Excessively Coarse Substrata
Cut and Fill Land	Disturbed Ground
Dune Land	Dunes, Excessively Course Substrata
Fill Land (Various Modifying Terms)	Disturbed Ground
Fluvaquents	Flooding
Fresh Water Marsh	Wetland
Gravel Pits	Disturbed Ground, Excessively Coarse Substrata
Humaquepts	Wetland
Made Land (Various Modifying Terms)	Disturbed Ground
Marsh (Various Modifying Terms)	Wetland
Mine Dump	Disturbed Ground
Muck (Various Modifying Terms)	Wetland
Peat (Various Modifying Terms)	Wetland
Pits (Various Modifying Terms)	Disturbed Ground
Psamments	Dunes, Excessively Coarse Substrata
Quarries	Disturbed Ground
Rock Land-Edneyville Material	Rock Outcrops, Excessively Coarse Substrata
Rock Outcrop	Rock Outcrops
Rough Broken Land	Excessively Stony
Sand Pits	Disturbed Ground, Excessively Coarse Substrata
Sandy Land	Excessively Coarse Substrata
Steep Stony Land Parker Material	Slope, Excessively Stony
Sulphaquents	Wetland
Sulphihemists	Wetland
Swamp	Wetland
Tidal Marsh	Wetland
Urban Land	Disturbed Ground

APPENDIX E. SYSTEM INSPECTION PROTOCOL

1. Procedures for preparing and reporting a system inspection

- (a) Obtain a signed inspection authorization from the owner of the property or its authorized agent before commencing any of the following.
- (b) Contact NJ ONE CALL at 1-800-272-1000 to delineate subsurface utilities.
- (c) Conduct a file review of the administrative authority's records.
- (d) Obtain the following minimum preliminary information regarding the subject system from the homeowner prior to the inspection:
 - i. Statistics regarding the type, age, number and use of onsite system(s) and structure(s) being inspected.
 - ii. The presence of garbage grinding equipment.
 - iii. The date of last treatment tank pumping and frequency.
 - iv. Any sanitary sewage discharges that bypass the system.
 - v. The summarized results of previous inspections conducted on the system.

2. Procedures for conducting the preliminary field investigation

- (a) Record the weather at the time of inspection.
- (b) Walk the entire interior of the structure(s) and examine for unexpected fixtures, plumbing or discharges.
- (c) Walk the exterior property looking for abnormally lush vegetation or other indications of discharges on or through the surface of the ground, streams, road ditches, storm drains or unexpected pipes.
- (d) Note and record if vegetation with invasive root systems have been located above any system component or within ten (10) feet of the perimeter of the disposal area.
- (e) Note and record the presence of any structures or heavy objects placed above any of the system components. Include any evidence of heavy objects, such as tire tracks from vehicles, being previously present.
- (f) Create a site sketch of all relevant onsite wastewater treatment system components and water supply wells.
- (g) Locate and gain access to the treatment tank(s) and determine their composition.
- (h) Check for surface leakage into tanks and then locate other system components.
- (i) Compare the information obtained onsite to the information gathered previously and identify any discrepancies.

3. Procedures for inspecting the internal plumbing

- (a) Confirm the number, size and general exit point(s) of the waste lines.
- (b) Determine if any sanitary sewage generating fixture can not reasonably be piped to the observed exit point.
- (c) Confirm that the discharge points of all sump pumps are separate from sanitary sewage lines and that the sanitary sewage is not directed to this equipment.

4. Procedures for inspecting treatment tanks

THIS IS A COURTESY COPY OF THIS RULE. ALL OF THE DEPARTMENT'S RULES ARE COMPILED IN TITLE 7 OF THE NEW JERSEY ADMINISTRATIVE CODE.

- (a) Confirm liquid level is below the inlet invert and equal to the height of the outlet invert.
- (b) Evaluate and record scum thickness and sludge depth through the main access port.
- (c) Do not pump any treatment tank until the disposal field area has been investigated.
- (d) Pump all treatment tanks and compartments using the main access (largest opening). Sanitary sewage must be removed, at a minimum, to within two inches of the tank bottom.
- (e) Identify sanitary sewage flows into the tank or defective septic system components and deficiencies including the tank bottom.
- (f) Verify that all fixtures discharge to the treatment tank.
- (g) Check for continuous flow through the building sewer and into the treatment tank.
- (h) Determine treatment tank construction, composition (material), and condition of the tank, the baffles, and the cover by accessing the interior of the tank.
- (i) Aerobic treatment tanks must be checked by observing the electrical and mechanical operation of the pumps and compressors in operation.
- (j) No inspection may be considered complete until every tank is pumped and its condition evaluated.

5. Procedures for inspecting holding tanks

- (a) Identify that the holding tank has audible and visual alarms.
- (b) Determine the tank's capacity.
- (c) Measure and record the liquid level; then pump all tanks and compartments. Examine for any defects, including the tank bottom.
- (d) Determine the tank does not leak and is watertight.
- (e) Recommend specific actions of ongoing maintenance.

6. Procedures for inspecting dosing and lift pumps/tanks and siphon tanks

- (a) Check the disposal field area before turning on any pump.
- (b) Check the condition and integrity of all pump and siphon tanks, using the tank inspection procedures described previously, including the alarm system.
- (c) If the system has a pump, verify the operation of every pump and control system.
- (d) Visually inspect all electrical components. Verify that the alarm and pump are on separate circuits.
- (e) Verify that pumps are elevated above the tank bottom and resting on a concrete block.
- (f) For siphon pressurized systems, open the observation port and check for continuous trickling.
- (g) Measure and record the liquid level; then pump the tanks using the main access.

7. Procedures for inspecting effluent delivery and distribution systems

- (a) If the liquid level in the distribution system is above the lowest point of the outlet of the treatment tank, further investigation is needed.
- (b) If a distribution box is found and exposed, it must be evaluated; if a distribution box is not found, the absorption area investigation should proceed. If known to exist, the location of the distribution box (D-box) shall be noted on the site sketch or a notation that further investigation would be needed to locate the D-box.

THIS IS A COURTESY COPY OF THIS RULE. ALL OF THE DEPARTMENT'S RULES ARE COMPILED IN TITLE 7 OF THE NEW JERSEY ADMINISTRATIVE CODE.

- (c) Evaluate the structural integrity of the D-box and check for the presence of solids, which must be removed. D-boxes must be watertight. Confirm the D-box is level and that effluent is equally distributed to the laterals.
8. Procedures for inspecting subsurface systems: seepage pits
- (a) Determine the structure's capacity; then measure the distance from the water level to the bottom of the inlet pipe.
 - (b) Determine total design volume using the design criteria in N.J.A.C. 7:9A-7.4.
 - (c) Determine the available storage capacity below the bottom of the inlet pipe.
 - (d) Confirm there is one day's storage capacity below the bottom of the inlet pipe.
 - (e) Evaluate the liquid, scum and sludge levels; then pump the seepage pit. Note all deficiencies and excessive inflow.
 - (f) If a system has both a seepage pit and a disposal area, evaluate each separately.
9. Procedures for inspecting disposal fields: beds or trenches
- (a) Determine the type, location and size of the disposal field.
 - (b) Determine if there is standing liquid in the disposal field by probing or other means available. Measure the depth of the effluent throughout the disposal field. Measure the difference between the liquid's depth and the invert of the laterals at the distribution box/manifold or the base of a lateral as best determined by the inspector. This depth (distance) is called the dry aggregate. Inspection ports may not be used for this evaluation.
 - (c) If there are six (6) or more inches dry aggregate below the invert of the laterals, the disposal field is satisfactory. If there are less than six (6) inches of dry aggregate, a high water condition must be noted.
 - (d) When liquid is present in the disposal field, it should be of an equal depth and evenly distributed throughout the entire bed.
 - (e) If the disposal field is completely saturated, do not pump the treatment tank.
10. Additional inspection criteria for trench systems
- (a) In serial distribution systems, confirm that higher trenches are saturated prior to lower trenches.
 - (b) In gravity supplied trenches, confirm that trenches receive effluent equally from the D-box.
11. Additional inspection criteria for mounded systems
- (a) Probe the aggregate in mound systems. Note any standing liquid.
 - (b) Examine the mound for leakage on the top, side slopes, and toe of the slope; sufficient depth of soil cover at the top edges, animal burrows, deeply rooted vegetation and erosion.
12. Procedures for conducting hydraulic load testing
- (a) When a hydraulic load test is determined to be necessary, describe why the recommendation is being made and what the test will entail.
 - (b) All hydraulic load test which does not follow the methodology in the Department's inspection protocol technical manual, must be designed and sealed by a septic system designer to evaluate how liquid levels in a disposal field respond to an appropriate volume of introduced clean water.
 - (c) Whenever possible, water from a public supply or brought in from off-site should be used to conduct hydraulic load testing. Permission to use water supplied from a private well for conducting hydraulic tests on systems must be obtained from the current well owner, in writing, prior to use. In no case shall the use

THIS IS A COURTESY COPY OF THIS RULE. ALL OF THE DEPARTMENT'S RULES ARE COMPILED IN TITLE 7 OF THE NEW JERSEY ADMINISTRATIVE CODE.

of the well exceed its design yield. Volume of withdrawal from a private well shall be limited to no more than two (2) gallons per minute.

13. Procedures for inspecting advanced wastewater pretreatment components and drip dispersal systems

Any advanced wastewater pretreatment device and drip dispersal systems may only be inspected by personnel trained or otherwise familiar with the specific technology. A review of the homeowner's service records, contacting the maintenance provider and the manufacturer of the equipment must be conducted. An estimate of the annual cost of operating the system and maintenance agreements must be provided.

THIS IS A COURTESY COPY OF THIS RULE. ALL OF THE DEPARTMENT'S RULES ARE COMPILED IN TITLE 7 OF THE NEW JERSEY ADMINISTRATIVE CODE.

**APPENDIX F: INDIVIDUAL SUBSURFACE SEWAGE DISPOSAL
INSPECTION REPORTING FORM**

Sketch the approximate system location in this space provided:

Dosing or Pump Tank:	<u>Yes</u>	<u>No</u>	<u>N/A</u>
Does the system contain a pump tank?	0	0	0
Is the pump operating?	0	0	0
Do the alarm(s) on the pump work?	0	0	0
Is the pump elevated above the tank floor?	0	0	0
Is the lid in satisfactory condition?	0	0	0
Is the tank in satisfactory condition?	0	0	0
Is the tank free of accumulated solids?	0	0	0

Summary:	<u>Satisfactory</u>	<u>Satisfactory with Concerns</u>	<u>Unsatisfactory</u>	<u>Requires Additional Investigation</u>	<u>N/A</u>
Condition of the treatment tank(s)	0	0	0	0	0
Condition of the conveyance and pump system(s)	0	0	0	0	0
Condition of the absorption area(s)	0	0	0	0	0
Condition of any accessory components	0	0	0	0	0
Comments: _____					

Health Department Reporting:

Note if any of the following conditions were observed during the inspection:

- () **1. Ponding or breakout of sewage or effluent onto the surface of the ground**
- () **2. Seepage of sewage or effluent into portions of buildings below ground**
- () **3. Backup of sewage into the building served which is not caused by a physical blockage of the internal plumbing**
- () **4. Any manner of leakage observed from or into septic tanks, connecting pipes, distribution boxes and other components that are not designed to emit sewage or effluent**

Pursuant to N.J.A.C. 7:9A-3.4 notification of any observation that is consistent with a condition noted above must be reported to the local administrative authority within 24 hours of the observation. Regardless of observations made, a copy of this report must be provided to the local administrative authority within 10 days of the issuance of this report.

If encountered, describe all observed noncompliant conditions encountered during this inspection:

Customer Authorization:

I authorize "The Company" to enter the above listed property for the purpose of performing a sub-surface sewage disposal system inspection. I authorize "The Company" to expose parts of the system if required, to determine location and condition. I understand that "The Company" relies on information supplied by the owner(s) of the listed property or their agent and the local administrative authority in the evaluation of the sub-surface disposal system. I authorize "The Company" to provide this form to all parties as required.

Customer signature: _____ Printed name: _____

Inspector's signature: _____ Printed name: _____

Disclaimer:

Based on today's observations and the information provided by the owner(s) or their agent, "The Company" submits this sub-surface sewage disposal system inspection form. The inspection is based on the current condition of the onsite sewage disposal system. "The Company" makes no representation that the system was designed, installed or meets N.J.A.C. 7:9A-1.1 et seq.. "The Company" has not been retained to warrant, guarantee, or certify the proper functioning of the system for any period of time. Because of numerous factors (usage, soil type, installation, maintenance, etc.) which affect the proper operation of a sub-surface disposal system, as well as the inability of "The Company" to supervise or monitor the use and maintenance of the system, this form shall not be construed as a warranty by "The Company" that the system will function properly for any prospective buyer. "The Company" disclaims any warranty, either expressed or implied, arising from the inspection of the septic system.

This form was developed as a cooperative effort of:
Pennsylvania/New Jersey Sewage Management Association;
Rutgers Cooperative Extension New Jersey Agricultural Experiment Station; and
The New Jersey Department of Environmental Protection Septic System Inspection Protocol Subcommittee