

CERTIFIED
LINE
PRESSURE
REGULATOR
GUIDEBOOK
7TH EDITION



2 AND 5 PSI
SYSTEMS

MAXITROL®

This Handbook contains information from national heating and plumbing ordinances or codes that may have been adopted or incorporated by local authorities. The Handbook should only be used as a guideline and should not be considered as a supplement or replacement of the existing ordinance or code for a particular area or industry. The color yellow on tags depicted herein is a trademark of the Maxitrol Company and all rights are reserved.

Maxitrol Company recommends that all installation contractors refer to their local requirements and applicable ordinances or codes, such as those found in the International Mechanical Code, International Plumbing Code, National Electrical Code, American Gas Association Standards, and National Board of Fire Underwriters.

MAXITROL COMPANY IS NOT RESPONSIBLE FOR ANY ERRORS OR OMISSIONS IN RELIANCE BY ANYONE OF ANY INFORMATION SET FORTH IN THIS HANDBOOK WITHOUT ADDITIONAL REFERENCE TO LOCAL REQUIREMENTS AND APPLICABLE ORDINANCES OR CODES.



CONTENTS

2 & 5 PSI PRESSURE FUEL GAS PIPING SYSTEMS

Line Pressure Regulators	6
2 psi Piping Systems	8
Piping Systems up to 5 psi	10
Line Pressure Regulator Options	12
✓Protector® Vent Protectors.....	13
✓Limiter® Vent Limiting Devices.....	14
2 psi Piping Systems Specifications.....	16
5 psi Piping Systems Specifications.....	18
Line Pressure Regulator Specification Chart.....	21
Typical Installations	22
Line Pressure Regulator Lockup Test Information	22
Class I and Class II Regulators	23
NFPA 54/ANSI Z223.1 National Fuel Gas Code	
5.8 Gas Pressure Regulators.....	26
5.8.1 Where Required.....	26
5.8.2 Listing.....	26
5.8.3 Overpressure Protection	26
5.8.4 Location.....	27
5.8.5 Regulator Protection	27
5.8.6 Venting.....	27
5.8.6.1 Line Pressure Regulators	27
8.1.3 Test Preparation	28

American National Standard/CSA Standard for Line Pressure Regulators

1.1 Scope.....	29
1.6 Adjustments	30
1.11 Materials	30
1.14 Overpressure Protection Devices	30
2.9 Regulator Lockup Pressure.....	31
Definitions.....	32
Inlet Pressure, Rated	32
Maximum Individual Load Capacity.....	32
Overpressure Protection Device.....	32
Regulator, Line Pressure	33
Vent Limiter.....	33

CSA B149.1 Natural Gas & Propane Gas Installation Code - Canada

5.2 Pressure Regulators	34
5.2.2 Additional Requirements for Propane Applications	34
5.2.3 Additional Requirements for Natural Gas Applications	34
Definitions.....	35

Codes for Vent Limiters

Commonly Asked Questions.....

LINE PRESSURE REGULATORS

ANSI Z21.80/CSA 6.22 is the standard for line pressure regulators, suitable for application in natural, manufactured, mixed gases, liquefied petroleum gases and LP gas-air mixture piping systems. Maxitrol, in compliance with ANSI Z21.80/CSA 6.22, offers line pressure regulators for 2 psi piping systems and piping systems up to 5 psi.

Maxitrol's 325 Series regulators are also certified (ANSI Z21.18) as appliance regulators. Appliance regulators were often used as line pressure regulators before the ANSI Z21.80/CSA 6.22 standard was developed.



Figure 1: 325-3L with 12A09 vLimiter® Vent Limiting Device

NOTE: With the implementation of ANSI Z21.80/CSA 6.22 standard, appliance regulators should no longer be used as line regulators.

Maxitrol places a yellow sticker on the regulator stack identifying it as a certified gas line pressure regulator, and a yellow tag is attached to its vLimiter® identifying it as a certified vent limiting device.

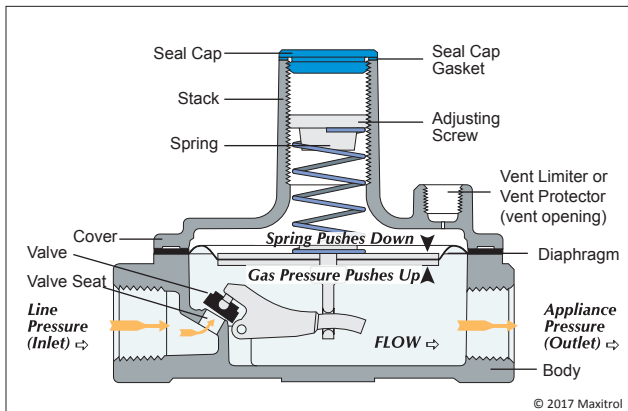

Figure 2: 325-3L Cutaway

- ▶ CSA design certified for 2 psi and up to 5 psi inlet pressures, (over 2 psi requires OPD) ANSI Z21.80/CSA 6.22.
- ▶ Designed for dead end lock up.
- ▶ Does not contain internal relief.
- ▶ Approved with **vLimiter[®]** vent limiting device (regulators up to 2" NPT).
- ▶ Suitable for natural, manufactured, mixed gases, liquefied petroleum gases and LP gas-air mixture piping systems.

2 PSI PIPING SYSTEMS

Maxitrol's 325 L-Series are CSA certified (ANSI Z21.80/CSA 6.22) for 2 psi inlet pressure, with an outlet pressure range of 7 to 11 inches w.c. (see page 16).

The L-models are for use on 2 psi piping systems such as CSST (corrugated stainless steel), semirigid copper tubing, or steel/black iron pipe. The regulators reduce pounds of pressure to a level within the appliance or equipment's operating supply range. The line regulator is located upstream of appliances already fitted with a regulator.

B Models: Imblue Technology® increases corrosion resistance and provides extra protection against the elements for regulators used in outdoor applications.

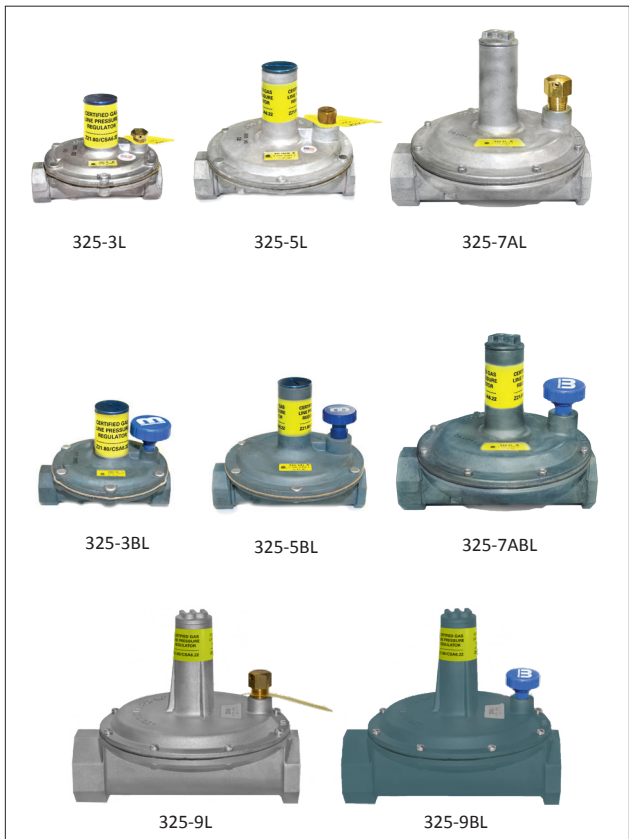

Figure 3: 325-L(B) Models: Pipe sizes from 3/8" to 2"

PIPING SYSTEMS UP TO 5 PSI

Maxitrol's 325 L-Series with overpressure protection devices (OPDs) are CSA certified (ANSI Z21.80/CSA 6.22) for up to 5 psi inlet pressure, and 7 to 11 inches w.c. outlet pressure (see page 18).

The L-models with OPDs are for use on piping systems up to 5 psi such as CSST (corrugated stainless steel), semirigid copper tubing, or steel/black iron pipe. The regulators reduce pounds pressure to a level within the appliance or equipment's operating supply range. The line regulator is located upstream of appliances already fitted with a regulator.

At supply pressures in excess of 2 psi, the ANSI Z21.80/CSA 6.22 standard for line pressure regulators requires an overpressure protection device - OPD. The OPD must be integral or factory pre-assembled, approved and tested for use with the regulator, to limit the downstream pressure to 2 psi maximum, in the event of line regulator failure.

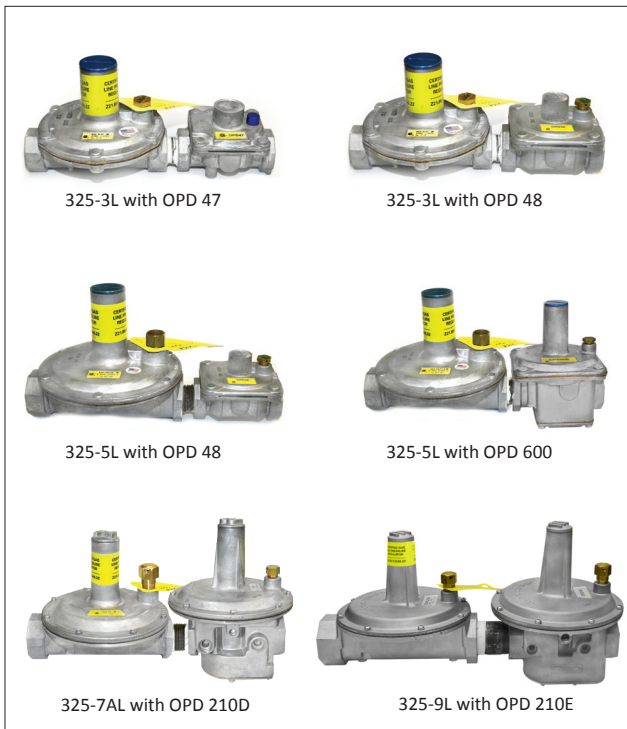

Figure 4: 325-L Models with OPDs

NOTE: Imblue Technology® Regulators available for all models above.

LINE PRESSURE REGULATOR OPTIONS

As optional accessories, the regulators and OPDs offer a **v**Limiter[®] vent limiting device. The 12A09, 12A39, or 12A49 **v**Limiter[®] vent limiting devices eliminate the need to run vent piping to an outside area. In the event of a diaphragm rupture, gas escapement is limited to within the ANSI standard requirements.

NOTE: Maxitrol line pressure regulators DO NOT contain an internal relief function.



Figure 5: 325-7AL with **v**Limiter[®] 12A49

vProtector® VENT PROTECTORS

Designed for outdoor applications. Use on vent opening to protect breather hole from the elements and debris (see Figure 6).



Figure 6: 325-7ABL with vProtector® 13A25



Figure 7: vProtector® Vent Protectors

NOTE: 13A15 and 13A15-5 vProtector® vent protectors are available for 325-3(B)L or 325-5A(B)L. 13A25 is available for 325-7A(B)L or 325-9(B)L. **Consult Maxitrol Company regarding other configurations.**

vLimiter® VENT LIMITING DEVICE MAXIMUM ALLOWABLE VENTING RATE

A vLimiter® vent limiting device used with Maxitrol regulators **DOES NOT** release or relieve gas into the environment during normal operation.

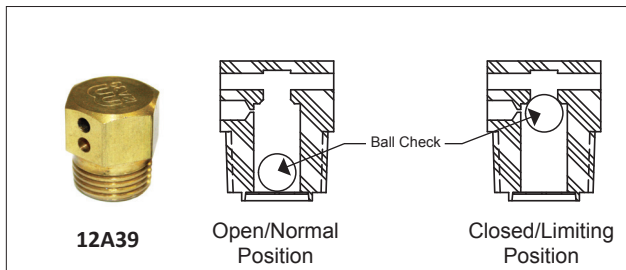

Figure 8: 12A39 Ball Check Cutaway



Figure 9: vLimiter® Vent Limiting Devices

vLimiter® vent limiting devices are designed for use indoors and in spaces where limiting the amount of gas escapement due to diaphragm failure is critical. **vLimiter® vent limiting devices should not be used outdoors if they are exposed to the environment.** 13A15, 13A15-5 and 13A25 **vProtector®** vent protectors are available for all outdoor applications to ensure proper vent protection.

vLimiter® vent limiting devices can only be installed in regulators for which they are certified. **vLimiter®** vent limiting devices must only be installed directly into the vent connection of the regulator without intermediate pipe or fittings. When using a vent limiting device, the regulator must be mounted in a horizontal upright position.

Requirements for vLimiter® Vent Limiting Device	Specific Gravity	Maximum allowable flow rate, cubic feet per hour (cm ³ /s)
Vent limiter for use only with natural, manufactured, mixed gases, and LP gas-air mixtures.	0.64	2.5 (19.6)
Vent limiter for use with liquefied petroleum gases.	1.53	1.0 (7.9)

NOTE: **vLimiter®** vent limiting devices meet ANSI Z21.80/CSA 6.22. The requirement states “Vent limiters shall be of materials having melting points of not less than 800°F (427°C).”

2 PSI LINE PRESSURE REGULATORS

GASES

Suitable for application in natural, manufactured, mixed gases, liquefied petroleum gases and LP gas-air mixture piping systems.

MAXIMUM INLET PRESSURE

CSA certified.....2 psi (13.8 kPa)

EMERGENCY EXPOSURE LIMITS

Inlet side only.....65 psi (450 kPa)

OUTLET PRESSURE RANGE

Certified spring.....7 - 11" w.c.

AMBIENT TEMPERATURE LIMITS: -40°F to 205°F (-40°C to 96°C)

MAXIMUM INDIVIDUAL LOAD

Largest single appliance served by the regulator

325-3(B)L	140,000 Btu/hr
325-5(B)L.....	425,000 Btu/hr
325-7A(B)L.....	1,250,000 Btu/hr
325-9(B)L.....	2,250,000 Btu/hr
325-11(B)L.....	4,450,000 Btu/hr

NOTE: Btu/hr is based on 0.64 sp gr GAS with 1,000 Btu/CF

CAPACITY: Total load of multiple appliances combined

NOTE: Capacity table is used to determine the maximum multiple appliance load. The largest single appliance served by the regulator should not exceed the maximum individual load specified above.

325-3(B)L ($\frac{3}{8}$ " , $\frac{1}{2}$ ").....	250,000 Btu/hr
325-5(B)L ($\frac{1}{2}$ ").....	500,000 Btu/hr
325-5(B)L ($\frac{3}{4}$ " , 1").....	600,000 Btu/hr
325-7A(B)L ($1\frac{1}{4}$ " , $1\frac{1}{2}$ ").....	1,250,000 Btu/hr
325-9(B)L ($1\frac{1}{2}$ " , 2").....	2,250,000 Btu/hr
325-11(B)L.....	4,450,000 Btu/hr

NOTE: Btu/hr is based on 0.64 sp gr GAS with 1,000 Btu/CF

vLimiter® VENT LIMITING DEVICE

325-3(B)L	12A09
325-5(B)L.....	12A39
325-7A(B)L.....	12A49
325-9(B)L.....	12A49

vProtector® VENT PROTECTOR FOR OUTDOOR APPLICATIONS

325-3(B)L.....	13A15
325-5(B)L.....	13A15-5
325-7A(B)L.....	13A25
325-9(B)L.....	13A25

MOUNTING

The 325 Series is suitable for multi-positional mounting. But when using a vent limiting device, the regulator must be mounted in a horizontal upright position. Install the regulator properly with gas flowing as indicated by the arrow on the casting (see the Safety Warning Instructions bulletin, GPR_CSA_2PSI_MI_EN.FR).

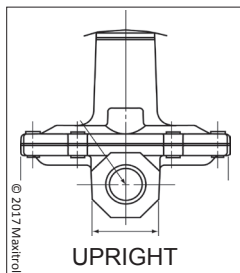

NOTE: Please refer to the Measurement Conversion Calculator on Maxitrol.com for conversions from natural to LP.

NOTE: 1 CFH = 1000 Btu of Natural Gas
 1 CFH = 2500 Btu of LP/Propane
 Formula for converting flow rates in different gases:

$$Q_2 = Q_1 \times \sqrt{\frac{S_1}{S_2}}$$

Where: Q is flow rate
 S is specific gravity

5 PSI LINE PRESSURE REGULATORS

To comply with the Standard for Line Pressure Regulators, ANSI Z21.80/CSA 6.22, installations exceeding 2 psi nominal require a tested and approved overpressure protection device (OPD, factory pre-assembled)* for use with the regulator.

GASES

Suitable for application in natural, manufactured, mixed gases, liquefied petroleum gases, and LP gas-air mixture piping systems.

MAXIMUM INLET PRESSURE

CSA certified.....5 psi (34.5 kPa)

EMERGENCY EXPOSURE LIMITS

Inlet side only.....65 psi (450 kPa)

OUTLET PRESSURE RANGE

Certified spring.....7-11" w.c.

MAXIMUM INDIVIDUAL LOAD

325-3(B)L47 (3/8", 1/2") (with OPD 47)	125,000 Btu/hr
325-3(B)L48 (1/2") (with OPD 48).....	200,000 Btu/hr
325-5(B)L48 (1/2") (with OPD 48).....	235,000 Btu/hr
325-5(B)L48 (3/4") (with OPD 48).....	320,000 Btu/hr
325-5(B)L600 (3/4") (with OPD 600).....	425,000 Btu/hr
325-5(B)L600 (1") (with OPD 600).....	465,000 Btu/hr
325-7A(B)L210D (1 1/4", 1 1/2") (with OPD 210D).....	1,250,000 Btu/hr
325-9(B)L210E (1/2", 2") (with OPD 210E).....	2,250,000 Btu/hr

MAXIMUM CAPACITY

325-3(B)L47 (3/8", 1/2") (with OPD 47)	125,000 Btu/hr
325-3(B)L48 (1/2") (with OPD 48).....	200,000 Btu/hr
325-5(B)L48 (1/2") (with OPD 48).....	235,000 Btu/hr
325-5(B)L48 (3/4") (with OPD 48).....	320,000 Btu/hr
325-5(B)L600 (3/4") (with OPD 600).....	425,000 Btu/hr
325-5(B)L600 (1") (with OPD 600).....	465,000 Btu/hr
325-7A(B)L210D (1 1/4", 1 1/2") (with OPD 210D).....	1,250,000 Btu/hr
325-9(B)L210E (1/2", 2") (with OPD 210E).....	2,250,000 Btu/hr

***NOTE:** Even though the Maxitrol 5 psi line regulator with OPD is shipped as an assembly it is important to check the pre-assembled pipe connection between the regulator and the OPD for leakage.

NOTE: Heating value specific gravity may vary based on location. Please contact local utility or gas supplier.

NOTE: Please refer to the Measurement Conversion Calculator on Maxitrol.com for conversions from natural to LP.

√**Limiter® VENT LIMITING DEVICE**

325-3(B)L.....	12A09
325-5(B)L.....	12A39
325-7A(B)L.....	12A49
OPD 47.....	integral vent limiting orifice with dust cap
OPD48.....	12A09
OPD600.....	12A09
OPD210D.....	12A39
OPD210E.....	12A49

√**Protector® VENT PROTECTORS FOR OUTDOOR APPLICATIONS**

325-3(B)L	13A15
325-5(B)L.....	13A15-5
325-7A(B)L.....	13A25
325-9(B)L.....	13A25
OPD47.....	includes dust cap
OPD48.....	13A15
OPD600.....	13A15
OPD 210D.....	13A15-5
OPD210E.....	13A25

NOTE: Vent limiters certified for 5 psi natural gas only.

AMBIENT TEMPERATURE LIMITS: -40°F to 205°F (-40°C to 96°C)

MOUNTING

The 325 Series with OPD is suitable for limited horizontal mounting (less than or equal to 90° from upright). But when using the vent limiting device, the regulator must be mounted in a horizontal upright position. Install the regulator properly with gas flowing as indicated by the arrow on the casting (see the Safety Warning Instructions bulletin, LPROPD_MI_EN.FR).

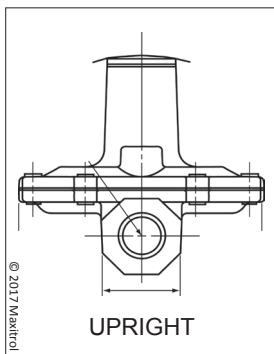

NOTE: If a 325 Series Regulator with OPD is used without a vent limiter, each vent must be run separately to the outdoors.

NOTE: 1 CFH = 1000 Btu of Natural Gas
 1 CFH = 2500 Btu of LP/Propane
 Formula for converting flow rates in different gases:

$$Q_2 = Q_1 \times \sqrt{\frac{S_1}{S_2}}$$

Where: Q is flow rate
 S is specific gravity

LINE PRESSURE REGULATOR SPECIFICATION CHART

The Certified Line Pressure Regulators have a 7 to 11" w.c. spring factory set to 8" w.c. outlet pressure and can be adjusted to 11" w.c. for LP.

Line Pressure Regulators CSA Certified*	Spring (inches w.c.)	Color	Factory Set Outlet Pressure (in. w.c.)	Certification Label	Vent Limiter	Vent Connection Pipe Size	
Line Pressure Regulator							
325-3L	7 - 11	White	8 for NG 11 for LP	Cert	2 PSI	12A09	1/8" NPT
325-5L	7 - 11	White	8 for NG 11 for LP	Cert	2 PSI	12A39	3/8" NPT
325-7AL	7 - 11	White	8 for NG 11 for LP	Cert	2 PSI	12A49	1/2" NPT
325-9L	7 - 11	White	8 for NG 11 for LP	Cert	2 PSI	12A49	1/2" NPT
325-11L	7 - 11	White	8 for NG 11 for LP	Cert	2 PSI		3/4" NPT
Over Pressure Protection Devices (OPD)							
325-3L47	7 - 11	White	8 for NG 11 for LP	Cert	5 PSI	12A09 + NONE	1/8" NPT + Integral
325-3L48	7 - 11	White	8 for NG 11 for LP	Cert	5 PSI	12A09 + 12A09	1/8" NPT + 1/8" NPT
325-5L48	7 - 11	White	8 for NG 11 for LP	Cert	5 PSI	12A39+ 12A09	3/8" NPT + 1/8" NPT
325-5L600	7 - 11	White	8 for NG 11 for LP	Cert	5 PSI	12A39 + 12A09	3/8" NPT + 1/8" NPT
325-7AL210D	7 - 11	White	8 for NG 11 for LP	Cert	5 PSI	12A49+ 12A39	1/2" NPT + 3/8" NPT
325-9L210E	7 - 11	White	8 for NG 11 for LP	Cert	5 PSI	12A49+ 12A49	1/2" NPT + 1/2" NPT

*ANSI Z21.80/CSA 6.22

NOTE: 325-L's ordered for LP applications will have a standard factory set outlet pressure of 11" w.c.

NOTE: Please refer to the Measurement Conversion Calculator on Maxitrol.com for conversions from natural to LP.

TYPICAL REGULATORS/MANIFOLD CONFIGURATION

(Refer to National and Local Codes for Requirements)

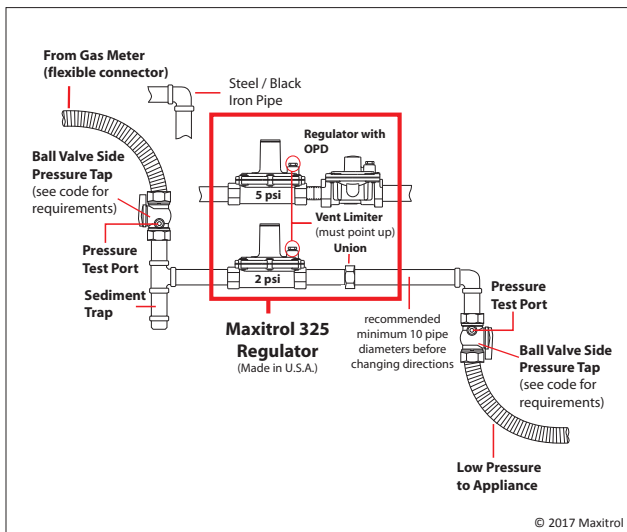

LINE PRESSURE REGULATOR LOCKUP TEST INFORMATION

Whenever introducing or restoring the gas supply to the line pressure regulator, open the manual valve **very slowly** in the line supplying the line pressure regulator.

NOTE: Lock up pressure testing and piping system testing are **separate tests**. Pressure testing of a piping system is done with the line pressure regulator removed or isolated.

CLASS I & II REGULATORS

Line pressure regulators are intended for use in a building's gas distribution system. Line pressure regulators are installed between the building's service regulator (or LP 2 psi service regulator) and the gas appliance's pressure regulator. Appliance pressure regulators are certified to ANSI Z21.18/CSA 6.3.

CLASS I OR CLASS II REGULATORS

- Line pressure regulators are classified in accordance with their intended application and are designated either Class I or Class II. The class designation must be located on the regulator's label.

LINE PRESSURE REGULATOR APPLICATIONS

- Class I regulators are primarily used with residential and light commercial appliances that use $\frac{1}{2}$ psi rated inlet pressure controls.
- Class II regulators are primarily used with industrial appliances that use controls having a rated inlet pressure up to 2 psi.

MAXIMUM OUTLET PRESSURE SETTING

- Class I regulators have a maximum outlet pressure setting of $\frac{1}{2}$ psi.
- Class II regulators have a maximum outlet pressure setting of 2 psi.

CERTIFIED RATED INLET PRESSURE

- Class I regulators can be certified for a rated inlet pressure of 2, 5, or 10 psi.
- Class II regulators can be certified for a rated inlet pressure of 5 or 10 psi.

CLASS I & II REGULATORS

OVER-PRESSURE PROTECTION DEVICE

- Class I regulators certified to a rated inlet pressure of 5 or 10 psi require an overpressure protection device (OPD). Separate OPD's shall be factory pre-assembled and supplied to the field as a unit. Class I regulators rated for 5 or 10 psi cannot be sold separately unless they have an integral OPD.
- Class II regulators certified to a rated inlet pressure of 5 or 10 psi and capable of being adjusted to deliver outlet pressures of less than $\frac{1}{2}$ psi require an overpressure protection device (OPD). Separate OPD's shall be factory pre-assembled and supplied to the field as a unit. Class II regulators supplied with adjustment means capable of outlet pressure below $\frac{1}{2}$ psi cannot be sold separately unless they have an integral OPD.

LINE PRESSURE REGULATORS

WITH **v**Limiter® VENT LIMITING MEANS

Certified vs. non-Certified construction.

The vast majority of installations require the line pressure regulator to be located at or near the appliance and, therefore, deep within the confines of the home or building. Having to run vent piping from this location is expensive, unsightly, and a lot of work. Using a line pressure regulator with a **v**Limiter® vent limiting device that has been tested and approved to ANSI Z21.80/CSA 6.22 eliminates the need to run vent piping.

Maxitrol vent limiting devices are tested and approved to ANSI Z21.80/CSA 6.22 for use with our line pressure regulators.

Don't be fooled. Regulators using safety or double diaphragm vent limiter designs DO NOT COMPLY with the vent limiting device requirements stated in ANSI Z21.80/CSA 6.22 and MUST BE VENTED TO THE OUTSIDE. The National Fuel Gas Code NFPA54/ANSI Z223.1 only allows line pressure regulators that are listed with approved vent limiting means. Regulators constructed with double or safety diaphragm vent limiting means ARE NOT LISTED with an approved vent limiting means.

INSTALLER NOTE

When installing the Maxitrol 325 Series regulator it is important to ensure the mating pipe threads and internals are clean and free of loose debris and excessive pipe sealant. Loose debris or pipe sealant may become lodged in the valve/seat area of the 325 and inhibit the regulator's ability to properly lock-up.

If the level of pipe system cleanliness is unacceptable or unknown we recommend installing Maxitrol GF Gas Filters (see bulletin GF_MBH_EN) directly ahead of the 325 to eliminate possible seat contamination due to system debris.

NFPA 54/ANSI Z223.1 NATIONAL FUEL GAS CODE

Instructions that the installation shall be performed in accordance with local codes or, in the absence of local codes, in accordance with the *National Fuel Gas Code, ANSI Z223.1*, or the *Natural Gas and Propane Install Code, NFPA 54/ANSI Z223.1 CSA B149.1*, as applicable.

5.8 GAS PRESSURE REGULATORS.

5.8.1 Where Required. A line pressure regulator or gas appliance pressure regulator, as applicable, shall be installed where the gas supply pressure is higher than that at which the branch supply line or appliances are designed to operate or vary beyond design pressure limits.

5.8.2 Listing. Line pressure regulators shall be listed in accordance with ANSI Z21.80/CSA 6.22, *Line Pressure Regulators*.

5.8.3 Overpressure Protection. Where the gas supply design pressure in piping systems located indoors exceeds 2 psi (14 kPa) and line pressure regulators are installed to reduce the supply pressure to 14 in. w.c. (3.4 kPa) or less, all of the following shall apply:

- (1) Regulators shall be provided with factory-installed overpressure protection devices.
- (2) Overpressure protection devices shall limit the pressure downstream of the line pressure regulator to 2 psi (14 kPa) in the event of failure of the line pressure regulator.

NFPA 54/ANSI Z223.1 NATIONAL FUEL GAS CODE

5.8.4 Location. The gas pressure regulator shall be accessible for servicing.

5.8.5 Regulator Protection. Pressure regulators shall be protected against physical damage.

5.8.6 Venting.

5.8.6.1 Line Pressure Regulators. Line pressure regulators shall comply with all of the following:

- (1) An independent vent to the exterior of the building, sized in accordance with the regulator manufacturer's instructions, shall be provided where the location of a regulator is such that a ruptured diaphragm will cause a hazard.
 - (a) Where more than one regulator is at a location, each regulator shall have a separate vent to the outdoors or, if approved by the authority having jurisdiction, the vent lines shall be permitted to be manifolded in accordance with accepted engineering practices to minimize back pressure in the event of diaphragm failure.
 - (b) Materials for vent piping shall be in accordance with Section 5.6.

EXCEPTION: A regulator and vent limiting means combination listed as complying with ANSI Z21.80/CSA 6.22, Line Pressure Regulators, shall be permitted to be used without a vent to the outdoors.

NFPA 54/ANSI Z223.1 NATIONAL FUEL GAS CODE

- (2) The vent shall be designed to prevent the entry of water, insects, or other foreign materials that could cause blockage.
- (3) The regulator vent shall terminate at least 3 ft (0.9 m) from a source of ignition.
- (4) At locations where regulators might be submerged during floods, a special antiflood-type breather vent fitting shall be installed, or the vent line shall be extended above the height of the expected flood waters.
- (5) A regulator shall not be vented to the appliance flue or exhaust system.

8.1.3 Test Preparation.

8.1.3.3 Appliances and equipment that are not to be included in the test shall be either disconnected from the piping or isolated by blanks, blind flanges, or caps. Flanged joints at which blinds are inserted to blank off other equipment during the test shall not be required to be tested.

8.1.3.4 Where the piping system is connected to appliances or equipment designed for operating pressures of less than the test pressure, such appliances or equipment shall be isolated from the piping system by disconnecting them and capping the outlet(s).

Reprinted with permission from NFPA 54: National Fuel Gas Code © 2012, National Fire Protection Association, Quincy, MA 02169. This reprinted material is not the complete and official position of the National Fire Protection Association on the referenced subject, which is represented only by the standard in its entirety.

ANSI/CSA STANDARD FOR LINE PRESSURE REGULATORS

Excerpts taken from the Line Pressure Regulators, Third Edition, 2011.

In July of 1994, the Joint Automatic Gas Controls Subcommittee adopted the harmonized draft standard for line pressure regulators, ANSI Z21.80.1993/CSA 6.22, for distribution for review and comment. The harmonized draft standard for line pressure regulators was based on American National Standard for Gas Appliance Pressure Regulator, ANSI Z21.18.1993.

Harmonized Standard for Line Pressure Regulators:

PART 1: CONSTRUCTION

1.1 SCOPE

1.1.1

This standard applies to line pressure regulators, (see Part V, Definitions), constructed entirely of new, unused parts and materials, hereinafter referred to as regulator(s), either individual or in combination with over pressure protection devices, hereinafter referred to as device(s), intended for application in gas piping systems between the service regulator, or LP-gas 2 psi service regulator, and the gas utilization equipment.

1.1.2

This standard applies to regulators for operation with natural, manufactured and mixed gases, liquefied petroleum gases, and LP gas-air mixtures.

ANSI/CSA STANDARD FOR LINE PRESSURE REGULATORS

1.6 ADJUSTMENTS

1.6.1

Adjustable regulators shall be provided with means for making any necessary adjustment of outlet pressure. The adjustment means of spring-type regulators shall be concealed.

Line pressure regulators shall not be capable of an outlet pressure adjustment in excess of the following:

- a. Class I - ½ psi (3.5 kPa); or
- b. Class II - 2 psi (13.8 kPa)

1.11 MATERIALS

1.11.4

Vent limiters shall be of materials having melting points of not less than 800°F(427°C).

1.14 OVERPRESSURE PROTECTION DEVICES

1.14.1

Line pressure regulators rated for inlet pressures in excess of 2 psi (13.8 kPa) and capable of being adjusted to deliver an outlet pressure of ½ psi (3.5 kPa) or less shall be provided with an independent means to limit the downstream pressure to 2 psi (13.8 kPa) maximum in the event of failure of the regulating mechanism.

1.14.2

An overpressure shutoff device (see Part V, Definitions), if provided, shall require a manual procedure to reset the device following actuation.

1.14.3

Line pressure regulators with separate overpressure protection devices shall be factory pre-assembled, and supplied to the field as a unit.

ANSI/CSA STANDARD FOR LINE PRESSURE REGULATORS

2.9 REGULATOR LOCKUP PRESSURE.

A regulator shall “lock up” under no-flow conditions to limit the downstream pressure as indicated in the following method of test.

METHOD OF TEST.

A regulator shall be mounted as specified in 2.6, Mounting Regulator for Test, and 1.1.4-b.

The regulator, if user adjustable, shall be adjusted to deliver its maximum outlet pressure. The inlet pressure to the regulator shall be adjusted to and maintained at the rated inlet pressure (see 1.1.3). With the instantaneous automatic valve energized (open), the flow adjustment means shall be adjusted to produce a flow equivalent to the maximum individual load capacity specified by the manufacturer (see 1.2-h). The regulator outlet pressure shall be observed and recorded as the initial outlet pressure.

The automatic valve shall then be de-energized, and the resultant regulator lock-up pressure under no-flow conditions shall be allowed to stabilize and shall be noted. This test shall be repeated by cycling the automatic gas valve on and then off for a total of five determinations of the regulator lock-up pressure. None of the lockup pressure readings shall exceed the following (see 1.1.3):

Class I regulator - 150 percent of initial outlet pressure or the initial outlet pressure + 5 in w.c. (1.24 kPa), whichever is greater.

Class II regulator - 150 percent of initial outlet pressure.

ANSI Z21.80/CSA 6.22 LINE PRESSURE REGULATORS

PART V - DEFINITIONS

INLET PRESSURE, RATED: The highest inlet pressure for which the control is intended to be used.

MAXIMUM INDIVIDUAL LOAD CAPACITY: The maximum capacity or flow at which a line pressure regulator will control lockup pressure within acceptable limits.

OVERPRESSURE PROTECTION DEVICE: For the purposes of this standard, a device which under abnormal conditions will act to reduce, restrict or shut off the supply of gas flowing into a system to prevent gas pressure in that system from exceeding 2 psi (13.8 kPa).

- a. **Overpressure Shutoff Device:** An overpressure protection device which functions by completely shutting off the flow of gas into the downstream system.
- b. **Overpressure Relief Device:** An overpressure protection device which functions by discharging gas from the downstream system to a safe location.
- c. **Monitoring Regulator:** An overpressure protection device which functions as a second gas pressure regulator in series with the primary gas pressure regulator.

ANSI Z21.80/CSA 6.22 LINE PRESSURE REGULATORS

REGULATOR, LINE PRESSURE: A gas pressure regulator intended for installation in a building gas distribution system between the building service regulator or LP-gas 2 psi service regulator and gas utilization equipment.

For purposes of this standard, a line pressure regulator is rated for an inlet gas pressure of either 2, 5 or 10 psi (13.8, 34.5 or 68.9 kPa) and is designated as either Class I or Class II as follows:

Class I - Maximum outlet pressure of $\frac{1}{2}$ psi (3.5 kPa)

Class II - Maximum outlet pressure of 2 psi (13.8 kPa)

VENT LIMITER: A means that limits the flow of gas from the atmospheric diaphragm chamber to the atmosphere in the event of a diaphragm rupture. This may be either a limiting orifice or a limiting device.

Limiting Orifice Type: A vent limiter where the flow through the limiter is the same in both directions.

CSA B149.1 NATURAL GAS & PROPANE GAS

5.2 Pressure Regulators

5.2.1.1 Every **regulator** shall be **certified** and be of sufficient size to provide the required flow of gas at the extremes of inlet pressures to which the **regulator** can be exposed. Recognized Standards for certifying **regulators** include

- (a) ANSI Z21.80/CSA 6.22;
- (b) UL 144; and
- (c) CSA 6.18.

5.2.1.3 A **pressure regulator** shall not be bypassed.

5.2.1.5 A **line pressure regulator** shall have

- (a) a manual shut-off **valve** installed upstream of the **regulator**; and
- (b) either a line **relief device** or an **overpressure protection device**. The **regulator** vent and **relief device** vent shall terminate outdoors.

5.2.2.2 Additional requirements for pressure regulators for propane applications

5.2.2.4

When used on a system operating at 2 psig (14 kPa) or less, a **line pressure regulator** equipped with a leak limiting system orificed for 1 ft³/h (0.0283 m³/h) of a gas having a specific gravity of 1.53 shall be exempt from the requirement of Clause 5.2.1.5(b).

A **regulator** with vent limiting means shall be installed in a **ventilated** space only.

5.2.3 Additional requirements for pressure regulators for natural gas applications

CSA B149.1 NATURAL GAS & PROPANE GAS

5.2.3.1

When used on a system operating at 2 psig (14 kPa) or less, a **line pressure regulator** equipped with a leak limiting system orificed for 2.5 ft³/h (0.0706 m³/h) of a gas having a specific gravity of 0.6 shall be exempt from the requirement of Clause 5.2.1.5(b).

A **regulator** with vent limiting means shall be installed in a **ventilated** space only.

5.2.3.2

For systems with inlet pressures above 2 psig (14 kPa), a pressure regulator shall be exempt from compliance with Clause 5.2.1.5(b) of this Code, provided that it is equipped to limit the escape of gas from the vent openings, even in the event of a main diaphragm failure, to less than 2.5 ft³/h (0.0706 m³/h), that it has an **overpressure protection device** set to a pressure either below 2 psig (14 kPa) or 2 times the delivery pressure on the system, and that it is certified to ANSI Z21.80/CSA 6.22.

DEFINITIONS

VENTILATED SPACE

A space where there is an air change by means of natural ventilation or mechanical means, or where the space communicates with the rest of the structure by means of permanent openings.

NOTE: A 12A09, 12A39 and 12A49 vent limiter can only be used with natural gas when used with a 5 psi system.

With the permission of Canadian Standards Association, material is reproduced from ANSI Z21.80.2011/CSA 6.22-2011 which is copyrighted by Canadian Standards Association, 178 Rexdale Blvd., Toronto, Ontario, M9W1R3. While use of this material has been authorized, CSA shall not be responsible for the manner in which the information is presented, nor for any interpretations thereof. For more information on CSA America or to purchase standards, please visit our website at www.csa-america.org or call 1-800-463-6727.

CODES FOR VENT LIMITERS

A) National Fuel Gas Code; ANSI Z223.1/NFPA 54 2012.

“9.1.19 Venting of Gas Appliance Pressure Regulators.

Venting of gas appliance pressure regulators shall comply with the following requirements:

- (2) Vent limiting means shall be employed on listed appliance pressure regulators only.*
- (3) In the case of vents leading outdoors, means shall be employed to prevent water from entering this piping and also to prevent blockage of vents by insects and foreign matter.”*

B) International Fuel Code 2011.

“410.3 Venting of regulators.

Pressure regulators that require a vent shall be vented directly to the outdoors. The vent shall be designed to prevent the entry of insects, water and foreign objects.

Exception: *A vent to the outdoors is not required for regulators equipped with and labeled for utilization with an approved vent-limiting device installed in accordance with the manufacturer’s instructions.”*

CODES FOR VENT LIMITERS

C) Uniform Plumbing Code IAPMO/ANSI UPC1-2012.

“1208.7.5 Venting.

1208.7.5.1 Line Gas Pressure Regulators.

Line gas pressure regulators shall be installed in accordance with the following requirements:

(1) An independent vent to the exterior of the building, sized in accordance with the regulator manufacturer’s instructions, shall be provided where the location of a regulator is such that a ruptured diaphragm will cause a hazard. Where more than one regulator is at a location, each regulator shall have a separate vent to the outdoors, or where approved by the Authority Having Jurisdiction, the vent lines shall be permitted to be manifolded in accordance with accepted engineering practices to minimize back pressure in the event of diaphragm failure. Materials for vent piping shall comply with Section 1208.5.

Exception: *A regulator and vent limiting means combination listed in accordance with CSA Z21.80 shall be permitted to be used without a vent to the outdoors.”*

Vent limiters will not prevent water, insects, or other foreign materials from entering the regulator.

If you have any questions, please contact Maxitrol’s Customer Service at (248) 356-1400.

COMMONLY ASKED QUESTIONS

List of Most Frequently Asked Questions from Training Sessions

1. Can I use a Maxitrol 325L with a vLimiter® vent limiting device in a confined space?

United States: Use good plumbing practices and common sense. It is up to the local jurisdiction for review and approval.
Canada: As long as confined space meets the definition for ventilated space as stated in CSA B149.1: Ventilating space - space where there is an air change by means of natural ventilation or mechanical means, or where the space communicates with the rest of the structure by means of permanent openings.

2. Can you mount the 325L in a position other than upright horizontal and then use an elbow, etc, to position the vent limiter in an upright horizontal position?

No. Vent limiters must be installed directly into the vent connection of the regulator without intermediate pipe or fittings. The Codes state you must follow the manufacturer's recommendations.

3. Can a vent limiter or a vent limiter with the ball check removed be used outdoors as a rain cap?

No. vLimiter® vent limiting devices should not be used outdoors if they are exposed to the environment. Use a 13A15, 13A15-5 or 13A25 vProtector® vent protector for outdoor use.

4. What is the vent line recommendation for venting a 325L?

Rule of thumb: increase the vent line one pipe size every 10 to 15 feet.

COMMONLY ASKED QUESTIONS

5. Can you use a bushing with the 13A15 vProtector® vent protector?

Yes. The use of a bushing in the vent port is no different than adding a vent line fitting. It does not affect regulator operation. Also, it is not a part of the gas piping that does not allow bushings; it is on the atmospheric side of the regulator diaphragm.

6. What length of pipe is recommended on the outlet side of the regulator before changing direction and why?

Rule of thumb and manufacturer's recommendation: 10 times the pipe diameter before changing direction. This helps prevent turbulence in the line that can create humming, chatter, and erratic operation.

7. Can a customer field install an OPD to a 325L for use on a 5 psi system?

No. ANSI Z21.80/CSA 6.22 Standard for Certified Line Pressure Regulators states, "Line pressure regulators with separate overpressure protection devices shall be factory pre-assembled, and supplied to the field as a unit." The 325L is certified as a stand alone regulator for 2 psi only.

COMMONLY ASKED QUESTIONS

8. What is Dead-End Lockup? Explain how it works.

When an appliance shuts off, gas pressure downstream of the regulator attempts to equalize with upstream gas pressure. As the outlet pressure increases and begins to exceed the set point pressure, the regulator assumes its fully closed position (this is true for all Maxitrol regulators). Further increases in downstream pressure over set point pressure increases the valve to valve seat sealing force. Regulators capable of dead-end lockup stop inlet to outlet pressure equalization and maintain an outlet pressure slightly above set point pressure under static conditions. The 325's lever action and rubber valve design guarantees consistent and reliable dead-end lockup.

9. What is the maximum allowable lockup pressure?

It is 150% of initial outlet pressure or initial outlet pressure plus 5" w.c., whichever is greater as defined by ANSI/CSA Standards.

10. How can excessive lockup pressure affect the appliance's operation?

Lockup pressure is the regulator outlet pressure under static conditions. If the regulator is undersized, incorrectly placed into service, or mounted too far from the appliance, a higher than desired lockup pressure can occur. This may result in the automatic valves not being able to open until upstream pressure is relieved.

11. Can I use a 12A49 vLimiter® on all 325-7's?

The 12A49 works with all 325-7's (325-7, 325-7L, 325-7A, 325-7AL).

COMMONLY ASKED QUESTIONS

12. Can I use the 13A15, 13A15-5, 13A25 vent protectors on outdoor applications rather than a vent limiter?

vProtector® in outdoor applications are designed to limit the entry of water, insects, or other foreign materials that could cause blockage and inhibit the vent function. The vLimiter® and vProtector® must be inserted directly into the vent opening and the regulator must only be mounted in a horizontal position. vLimiter® is intended for indoor applications and can be used in almost all cases instead of a vent line. CSA Certified vLimiter® and vProtector® are available for all 325 regulators including Overpressure Protection Devices (OPD).

13. What is Imblue Technology®?

Imblue Technology® is an anodized coating that increases corrosion resistance and provides extra protection against the elements for regulators used in outdoor applications.

14. Where should the Imblue® regulators be used?

The Imblue® Regulator should be used anywhere the conditions cause aluminum to oxidize such as coastal water areas, northern climates where roads are salted in the winter, roof-tops where airborne salt particles may impact regulators, water treatment plants, and swimming pool areas.

COMMONLY ASKED QUESTIONS

15. Why can't I install a regulator with a **vLimiter®** sideways or upside down?

If a regulator with a **vLimiter®** vent limiting device is installed in any orientation other than the horizontal upright position, the ball check in the vent limiter will roll into the CLOSED/LIMITING POSITION. When the ball check is in the CLOSED/LIMITING POSITION the regulator will experience high lock-up and will not operate properly.



Horizontal Upright Position
CORRECT

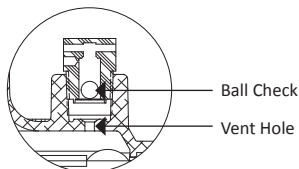

OPEN/NORMAL
POSITION



Sideways Position
INCORRECT

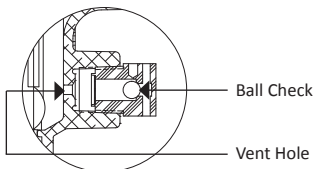

CLOSED/LIMITING
POSITION



Upside Down Position
INCORRECT

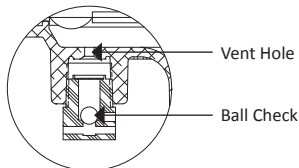

CLOSED/LIMITING
POSITION

NOTES



HARDI

US \$12.95
CAN \$20.75

MAXITROL®

P.O. Box 2230 Southfield, MI 48037-2230 www.maxitrol.com

© 2017 Maxitrol Company, All Rights Reserved.

LPROPD_GB_EN_10.2017 - 7th edition