

Instruction Manual for Residential Gas Water Heaters

NOT FOR USE IN MANUFACTURED (MOBILE) HOMES



GAMA certification applies to all residential gas water heaters with capacities of 20 to 100 gallons with input rating of 75,000 BTU/Hr. or less.

ALL TECHNICAL AND WARRANTY QUESTIONS: SHOULD BE DIRECTED TO THE LOCAL DEALER FROM WHOM THE WATER HEATER WAS PURCHASED. IF YOU ARE UNSUCCESSFUL, PLEASE WRITE TO THE COMPANY LISTED ON THE RATING PLATE ON THE WATER HEATER.

For Your Safety AN ODORANT IS ADDED TO THE GAS USED BY THIS WATER HEATER

WARNING: If the information in these instructions are not followed exactly, a fire or explosion may result, causing property damage, personal injury or death.

- Do not store or use gasoline or other flammable vapors and liquids in the vicinity of this or any other appliance.
- WHAT TO DO IF YOU SMELL GAS
 - Do not try to light any appliance.
 - Do not touch any electrical switch; do not use any phone in your building.
 - Immediately call your gas supplier from a neighbor's phone. Follow the gas supplier's instructions.
 - If you cannot reach your gas supplier, call the fire department.
- Installation and service must be performed by a qualified installer, service agency or the gas supplier.

WARNING

Improper installation, adjustment, alteration, service or maintenance can cause DEATH, SERIOUS BODILY INJURY, OR PROPERTY DAMAGE. Refer to this manual for assistance or consult the local gas utility for further information.

WARNING

Flammable vapors may be drawn by air currents from other areas of the structure to this appliance.

WARNING

READ THE GENERAL SAFETY SECTION BEGINNING ON INSIDE COVER AND THEN THIS ENTIRE MANUAL BEFORE INSTALLING OR OPERATING THIS WATER HEATER.

General Safety

▲ WARNING

Improper installation, adjustment, alteration, service or maintenance can cause DEATH, SERIOUS BODILY INJURY, OR PROPERTY DAMAGE. Refer to this manual or consult your local gas utility for assistance.

▲ WARNING

At the time of manufacture this water heater was provided with a combination temperature-pressure relief valve certified by a nationally-recognized testing laboratory that maintains periodic inspection of production of listed equipment or materials, as meeting the requirements for Relief Valves and Automatic Gas Shutoff Devices for Hot Water Supply Systems, and the current edition of ANSI Z21.22 and the code requirements of ASME. If replaced, the valve must meet the requirements of local codes, but not less than a combination temperature and pressure relief valve certified as meeting the requirements for Relief Valves and Automatic Gas Shutoff Devices for Hot Water Supply Systems, ANSI Z21.22 by a nationally recognized testing laboratory that maintains periodic inspection of production of listed equipment or materials.

The valve must be marked with a maximum set pressure not to exceed the marked hydrostatic working pressure of the water heater (150 lbs. p.s.i.) and a discharge capacity not less than the water heater input rate as shown on the model rating plate. (Electric heaters - watts divided by 1000 x 3412 equal BTU/Hr. rate.)

Your local jurisdictional authority, while mandating the use of a temperature-pressure relief valve complying with ANSI Z21.22 and ASME, may require a valve model different from the one furnished with the water heater.

Compliance with such local requirements must be satisfied by the installer or end user of the water heater with a locally prescribed temperature-pressure relief valve installed in the designated opening in the water heater in place of the factory furnished valve.

For safe operation of the water heater, the relief valve must not be removed from its designated opening or plugged.

The temperature-pressure relief valve must be installed directly into the fitting of the water heater designated for the relief valve. Position the valve downward and provide tubing so that any discharge will exit only within 6 inches above, or at any distance below the structural floor. Be certain that no contact is made with any live electrical part. The discharge opening must not be blocked or reduced in size under any circumstances. Excessive length, over 30 feet, or use of more than four elbows can cause restriction and reduce the discharge capacity of the valve.

No valve or other obstruction is to be placed between the relief valve and the tank. Do not connect tubing directly to discharge drain unless a 6" air gap is provided. To prevent bodily injury, hazard to life, or property damage, the relief valve must be allowed to discharge water in quantities should circumstances demand. If the discharge pipe is not connected to a drain or other suitable means, the water flow may cause property damage.

The Discharge Pipe:

- Must not be smaller in size than the outlet pipe size of the valve, or have any reducing couplings or other restrictions.
- Must not be plugged or blocked.
- Must be of material listed for hot water distribution.
- Must be installed so as to allow complete drainage of both the temperature-pressure relief valve, and the discharge pipe.
- Must terminate at an adequate drain.
- Must not have any valve between the relief valve and tank.

▲ WARNING

WATER HEATERS EQUIPPED FOR ONE TYPE GAS ONLY: This water heater is equipped for one type gas only. Check the rating plate near the gas control valve for the correct gas. DO NOT USE THIS WATER HEATER WITH ANY GAS OTHER THAN THE ONE SHOWN ON THE MODEL RATING PLATE. Failure to use the correct gas can cause problems which can result in DEATH, SERIOUS BODILY INJURY, OR PROPERTY DAMAGE. If you have any questions or doubts consult your gas supplier or local utility.

▲ WARNING

A fire can start if combustible materials such as clothing, cleaning materials, or flammable liquids are placed against or next to the water heater.

▲ WARNING

INSTALLATIONS IN AREAS WHERE FLAMMABLE LIQUIDS (VAPORS) ARE LIKELY TO BE PRESENT OR STORED (GARAGES, STORAGE, AND UTILITY AREAS, ETC): Flammable liquids (such as gasoline, solvents, propane (LP) or butane, etc.), all of which emit flammable vapors, may be improperly stored or used in such areas. The gas water heater pilot light or main burner can ignite such vapors. The resulting flashback and fire can cause death or serious burns to anyone in the area, as well as property damage.

If installation in such areas is your only option, then the installation must be accomplished in a way that the pilot flame and main burner flame are elevated from the floor at least 18 inches. While this may reduce the chances of flammable vapors from a floor spill being ignited, gasoline and other flammable substances should never be stored or used in the same room or area containing a gas water heater or other open flame or spark producing appliance.

NOTE: Flammable vapors may be drawn by air currents from other areas of the structure to the appliance.

▲ WARNING

HOTTER WATER CAN SCALD: Water heaters are intended to produce hot water. Water heated to a temperature which will satisfy space heating, clothes washing, dish washing, and other sanitizing needs can scald and permanently injure you upon contact. Some people are more likely to be permanently injured by hot water than others. These include the elderly, children, the infirm, or physically/mentally handicapped. If anyone using hot water in your home fits into one of these groups or if there is a local code or state law requiring a certain temperature water at the hot water tap, then you must take special precautions. In addition to using the lowest possible temperature setting that satisfies your hot water needs, a means such as a mixing valve, shall be used at the hot water taps used by these people or at the water heater. Mixing valves are available at plumbing supply or hardware stores. Follow manufacturers instructions for installation of the valves. Before changing the factory setting on the thermostat, read the "Temperature Regulation" section in this manual.

▲ WARNING

BEFORE LIGHTING PROPANE (L.P.) GAS WATER HEATERS: Propane (L.P.) gas is heavier than air. Should there be a leak in the system, the gas will settle near the ground. Basements, crawl spaces, skirted areas under manufactured (mobile) homes (even when ventilated), closets and areas below ground level will serve as pockets for the accumulation of this gas. Before attempting to light or relight the water heater's pilot or turning on a nearby electrical light switch, be absolutely sure there is no accumulated gas in the area. Search for odor of gas by sniffing at ground level in the vicinity of the appliance. If odor is detected, follow steps indicated at "For Your Safety" on the cover page of this manual then leave the premises.

General Safety

▲ WARNING

This water heater must not be installed directly on carpeting. Carpeting must be protected by a metal or wood panel beneath the appliance extending beyond the full width and depth of the appliance by at least 3 inches (76.2mm) in any direction, or if the appliance is installed in an alcove or closet, the entire floor must be covered by the panel. Failure to heed this warning may result in a fire hazard.

▲ WARNING

A gas water heater cannot operate properly without the correct amount of air for combustion. Do not install in a confined area such as a closet, unless you provide air as shown in the "Locating The New Water Heater" section. Never obstruct the flow of ventilation air. If you have any doubts or questions at all, call your gas company. Failure to provide the proper amount of combustion air can result in a fire or explosion and can cause DEATH, SERIOUS BODILY INJURY, OR PROPERTY DAMAGE.

▲ WARNING

If this water heater will be used in beauty shops, barber shops, cleaning establishments, or self-service laundries with dry cleaning equipment, it is imperative that the water heater or water heaters be installed so that combustion and ventilation air be taken from outside these areas. Refer to the "Locating The New Water Heater" section of this manual and also the current edition of the National Fuel Gas Code, ANSI Z223.1, also referred to as NFPA 54 for specifics provided concerning air required.

▲ WARNING

VENT DAMPERS - Any vent damper, whether it is operated thermally or otherwise must be removed if its use inhibits proper drafting of the water heater.

Thermally Operated Vent Dampers: Gas-fired water heaters having thermal efficiency in excess of 80% may produce a relatively low flue gas temperature. Such temperatures may not be high enough to properly open thermally operated vent dampers. This would cause spillage of flue gases and may cause carbon monoxide poisoning.

Vent dampers must bear evidence of certification as complying with the current edition of American National Standard ANSI Z21.68 (ANSI Z21.66 & 67, respectively, cover electrically and mechanically actuated vent dampers). Before installation of any vent damper, consult the gas utility for further information.

▲ WARNING

1. The appliance and its individual shutoff valve must be disconnected from the gas supply piping system during any pressure testing of the gas system at test pressures in excess of ½ pound per square inch (3.5kPa).
2. The appliance must be isolated from the gas supply piping system by closing its individual manual shutoff valve during any pressure testing of the gas supply piping system at test pressures equal or less than ½ pound per square inch (3.5kPa).

▲ WARNING

Soot build-up indicates a problem that requires correction before further use. Turn "OFF" gas to water heater and leave "OFF" until repairs are made, because failure to correct the cause of the sooting can result in a fire or explosion causing DEATH, SERIOUS BODILY INJURY, OR PROPERTY DAMAGE.

▲ WARNING

The water heater with draft hood installed must be properly vented to a chimney which terminates outdoors. Never operate the water heater unless it is vented to the outdoors and has adequate air supply to avoid risks of improper operation, explosion or asphyxiation.

▲ WARNING

Obstructed or deteriorated vent systems may present a serious health risk or asphyxiation.

▲ WARNING

Chemical vapor corrosion of the flue and vent system may occur if air for combustion contains certain chemical vapors. Spray can propellants, cleaning solvents, refrigerator and air conditioner refrigerants, swimming pool chemicals, calcium and sodium chloride, waxes, bleach, and process chemicals are typical compounds which are potentially corrosive.

▲ WARNING

Minimum clearances between the water heater and combustible construction are 1" at the sides and rear, 4" at the front, and 6" from the vent pipe. Clearance from the top of the jacket is 18" on most models. Note that a lesser dimension may be allowed on some models, refer to the label attached adjacent to the gas control valve on the water heater.

▲ WARNING

HYDROGEN GAS: Hydrogen gas can be produced in a hot water system that has not been used for a long period of time (generally two weeks or more). Hydrogen gas is extremely flammable and explosive. To prevent the possibility of injury under these conditions, we recommend the hot water faucet be opened for several minutes at the kitchen sink before any electrical appliances which are connected to the hot water system are used (such as a dishwasher or washing machine). If hydrogen gas is present, there will probably be an unusual sound similar to air escaping through the pipe as the hot water faucet is opened. There must be no smoking or open flame near the faucet at the time it is open.

▲ WARNING

INSULATING JACKETS: When installing an external water heater insulation jacket on a gas water heater:

- a. DO NOT cover the temperature-pressure relief valve.
 - b. DO NOT put insulation over any part of the top of the gas water heater.
 - c. DO NOT put insulation over the gas control valve or gas control valve/burner cover, or any access areas to the burner.
 - d. DO NOT let insulation around the gas water heater to get within 8 inches of the floor (air must get to the burner).
 - e. DO NOT cover or remove operating instructions, and safety related warning labels and materials affixed to the water heater.
- Failure to heed this will result in the possibility of a fire or explosion.

▲ WARNING

Flood damage to a water heater may not be readily visible or immediately detectible. However, over a period of time a flooded water heater will create dangerous conditions which can cause DEATH, SERIOUS BODILY INJURY, OR PROPERTY DAMAGE. Call a qualified service technician or contractor to replace a flooded water heater. Do not attempt to repair the unit! It must be replaced!

▲ CAUTION

WATER HEATERS EVENTUALLY LEAK: Installation of the water heater must be accomplished in such a manner that if the tank or any connections should leak, the flow of water will not cause damage to the structure. For this reason, it is not advisable to install the water heater in an attic or upper floor. When such locations cannot be avoided, a suitable drain pan should be installed under the water heater. Drain pans are available at your local hardware store. Such a drain pan must be not greater than 1½ inches deep, have a minimum length and width of at least 2 inches greater than the water heater dimensions and must be piped to an adequate drain. The pan must not restrict combustion air flow.

Table of Contents

General Safety	2,3
Table of Contents	4
Introduction	5
Preparing for the New Installation	5
Typical Installation	6
Locating the New Water Heater	7,8
Facts to Consider About Location	7
Combustion Air and Ventilation for Appliances Located in Unconfined Spaces	8
Combustion Air and Ventilation for Appliances Located in Confined Spaces	8
Installing the New Water Heater	9-13
Water Piping	9
Temperature-Pressure Relief Valve	10
Filling the Water Heater.....	11
Venting.....	11,12
Gas Piping.....	12,13
Installation Checklist	13
Lighting	14,15
Temperature Regulation	16
For Your Information	17,18
Start Up Conditions	17
Draft Hood Operation	17
Condensation	17
Smoke/Odor	17
Thermal Expansion	17
Strange Sounds	17
Operational Conditions	17,18
Smelly Water	17
“Air” In Hot Water Faucets	18
High Temperature Shut Off System	18
Not Enough or No Hot Water	18
Water Is Too Hot	18
Periodic Maintenance	18-20
Venting System Inspection	18,19
Burner Inspection	19
Burner Cleaning	19
L.P. Gas Control Valve & Burner Assembly Replacement Information	19
Housekeeping	19
Anode Rod Inspection	20
Temperature-Pressure Relief Valve Operation	20
Draining	20
Drain Valve Washer Replacement	20
Service	20
Leakage Checkpoints	21
Repair Parts	22

Introduction

Thank You for purchasing this water heater. Properly installed and maintained, it should give you years of trouble free service.

Abbreviations Found In This Instruction Manual

CSA - Canadian Standards Association
ANSI - American National Standards Institute
NFPA - National Fire Protection Association

▲ WARNING

This gas-fired water heater is design certified by CSA INTERNATIONAL under American National Standard/CSA Standard for Gas Water Heaters ANSI Z21.10.1 • CSA 4.1 (current edition). The installation must conform with this manual, Local Codes and with the current edition of the National Fuel Gas Code, ANSI Z223.1.

This publication is available from your local government or public library, gas company, or by writing NFPA, Batterymarch Park, Quincy, MA 02269.

Preparing for the New Installation

1. Read the "General Safety" section, pages 2 and 3 of this manual first and then the entire manual carefully. If you don't follow the safety rules, the water heater will not operate properly. It could cause DEATH, SERIOUS BODILY INJURY AND/OR PROPERTY DAMAGE. This manual contains instructions for the installation, operation, and maintenance of the gas-fired water heater. It also contains warnings throughout the manual that you must read and be aware of. All warnings and all instructions are essential to the proper operation of the water heater and your safety. Since we cannot put everything on the first few pages, **READ THE ENTIRE MANUAL BEFORE ATTEMPTING TO INSTALL OR OPERATE THE WATER HEATER.**
2. The installation must conform with the instructions in this manual; gas company rules; and Local Codes, or in the absence of Local Codes, with the current edition of the National Fuel Gas code, ANSI Z223.1, also referred to as NFPA 54. This publication is available from your local government or public library or gas company or by writing NFPA, Batterymarch Park, Quincy, MA 02269.
3. If after reading this manual you have any questions or do not understand any portion of the instructions, call the local gas utility or the manufacturer whose name appears on the rating plate.
4. Carefully plan the place where you are going to put the water heater. Correct combustion, vent action, and vent pipe installation are very important in preventing death from possible carbon monoxide poisoning and fires. Examine the location to ensure the water heater complies with the "Locating the New Water Heater" section in this manual.
5. For California installation this water heater must be braced, anchored, or strapped to avoid falling or moving during an earthquake. See instructions for correct installation procedures. Instructions may be obtained from your local dealer, wholesaler, public utilities or California Office of the State Architect, 400 P Street, Sacramento, CA 95814.
6. Massachusetts Code requires this water heater to be installed in accordance with Massachusetts 248-CMR 2.00: State Plumbing Code and 248-CMR 5.00.
7. Complies with SCAQMD rule #1121 and districts having equivalent NOx requirements.

Typical Installation

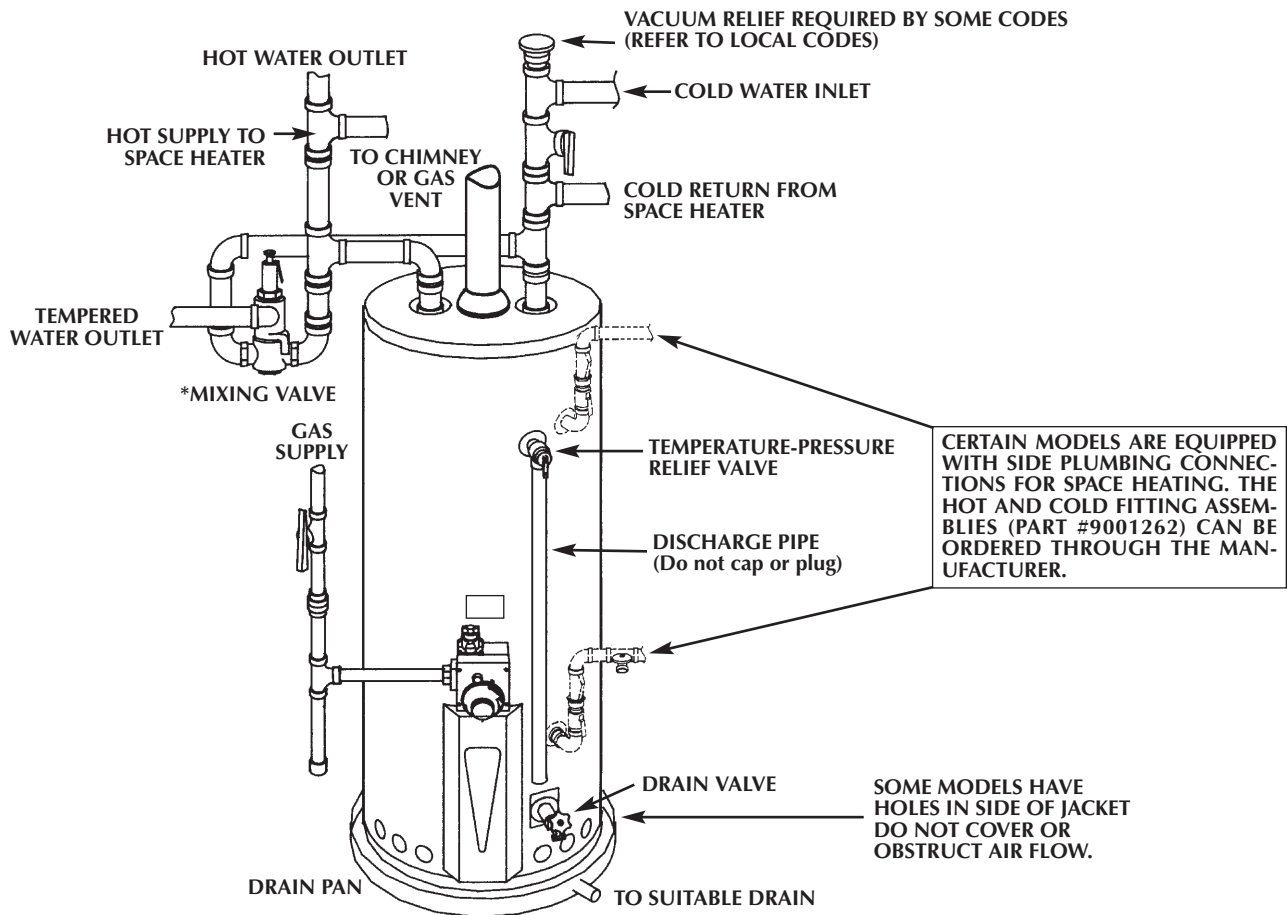

This appliance has been design certified as complying with American National Standard/CSA Standard for water heaters and is considered suitable for:

Water (Potable) Heating: All models are “considered suitable for water (potable) heating.”

Water (Potable) Heating and Space Heating: Certain models are “considered suitable for water (potable) heating and space heating.” Refer to the model and rating plate of the water heater.

▲ WARNING

HOTTER WATER CAN SCALD: Water heaters are intended to produce hot water. Water heated to a temperature which will satisfy space heating, clothes washing, dish washing, and other sanitizing needs can scald and permanently injure you upon contact. Some people are more likely to be permanently injured by hot water than others. These include the elderly, children, the infirm, or physically/mentally handicapped. If anyone using hot water in your home fits into one of these groups or if there is a local code or state law requiring a certain temperature water at the hot water tap, then you must take special precautions. In addition to using the lowest possible temperature setting that satisfies your hot water needs, a means such as a mixing valve, shall be used at the hot water taps used by these people or at the water heater. Valves for reducing point of use temperature by mixing cold and hot water are available: Consult a licensed plumber or the local plumbing authority. Follow mixing valve manufacturers instructions for installation of the valves. Before changing the factory setting on the thermostat, read the “Temperature Regulation” section in this manual.

▲ WARNING

This water heater shall not be connected to any heating systems or component(s) previously used with a non-potable water heating appliance. If this water heater is also used for space heating applications, all piping and components connected to the water heater shall be suitable for use with potable water.

▲ WARNING

Toxic chemicals such as used for treatment of boilers or non-potable water heating appliances shall never be introduced into a potable water space heating system.

NOTE: To protect against untimely corrosion of hot and cold water fittings, it is strongly recommended that di-electric unions or couplings be installed on this water heater when connected to copper pipe.

Locating the New Water Heater

Facts to Consider About the Location

You should carefully choose an indoor location for the new water heater, because the placement is a very important consideration for the safety of the occupants in the building and for the most economical use of the appliance. **This water heater is not for use in manufactured (mobile) homes or outdoor installation.**

Whether replacing an old water heater or putting the water heater in a new location, the following critical points must be observed.

1. The location selected should be indoors as close as practical to the gas vent or chimney to which the water heater vent is going to be connected, and as centralized with the water piping system as possible. The water heater, as all water heaters, will eventually leak. Do not install without adequate drainage provisions where water flow will cause damage.

▲ CAUTION

WATER HEATERS EVENTUALLY LEAK: Installation of the water heater must be accomplished in such a manner that if the tank or any connections should leak, the flow of water will not cause damage to the structure. For this reason, it is not advisable to install the water heater in an attic or upper floor. When such locations cannot be avoided, a suitable drain pan should be installed under the water heater. Drain pans are available at your local hardware store. Such a drain pan must be not greater than 1½ inches deep, have a minimum length and width of at least 2 inches greater than the water heater dimensions and must be piped to an adequate drain. The pan must not restrict combustion air flow.

▲ WARNING

INSTALLATIONS IN AREAS WHERE FLAMMABLE LIQUIDS (VAPORS) ARE LIKELY TO BE PRESENT OR STORED (GARAGES, STORAGE AND UTILITY AREAS, ETC): Flammable liquids (such as gasoline, solvents, propane (LP) or butane, etc.) or other substances (such as adhesives, etc.), all of which emit flammable vapors, may be improperly stored or used in such areas. The gas water heater pilot light or main burner can ignite such vapors. The resulting flashback and fire can cause death or serious burns to anyone in the area, as well as property damage.

If installation in such areas is your only option, then the installation must be accomplished in a way that the pilot flame and main burner flame are elevated from the floor at least 18 inches. While this may reduce the chances of flammable vapors from a floor spill being ignited, gasoline and other flammable substances should never be stored or used in the same room or area containing a gas water heater or other open flame or spark producing appliance.

Also, the water heater must be located and/or protected so it is not subject to physical damage by a moving vehicle.

NOTE: Flammable vapors may be drawn by air currents from other areas of the structure to the appliance.

▲ WARNING

Propellants of aerosol sprays and volatile compounds, (cleaners, chlorine based chemicals, refrigerants, etc.) in addition to being highly flammable in many cases, will also change to corrosive hydrochloric acid when exposed to the combustion products of the water heater. The results can be hazardous, and also cause product failure.

2. The location selection must provide adequate clearances for servicing and proper operation of the water heater.

▲ WARNING

This water heater must not be installed directly on carpeting. Carpeting must be protected by a metal or wood panel beneath the appliance extending beyond the full width and depth of the appliance by at least 3 inches (76.2mm) in any direction, or if the appliance is installed in an alcove or closet, the entire floor must be covered by the panel. Failure to heed this warning may result in a fire hazard.

▲ WARNING

Minimum clearances between the water heater and combustible construction are 1" at the sides and rear, 4" at the front, and 6" from the vent pipe. Clearance from the top of the jacket is 18" on most models. Note that a lesser dimension may be allowed on some models, refer to the label attached adjacent to the gas control valve on the water heater.

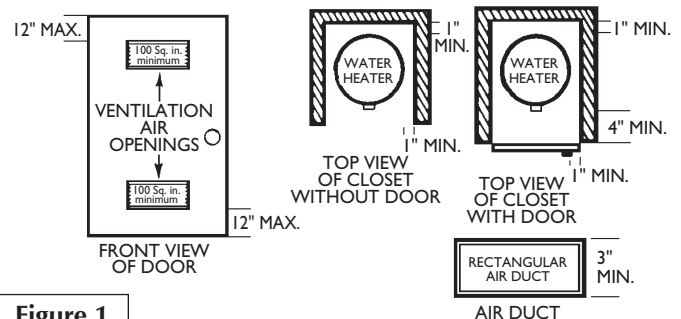

Figure 1

▲ WARNING

A gas water heater cannot operate properly without the correct amount of air for combustion. Do not install in a confined area such a closet, unless you provide air as shown in the "Locating The New Water Heater" section. Never obstruct the flow of ventilation air. If you have any doubts or questions at all, call your gas company. Failure to provide the proper amount of combustion air can result in a fire or explosion and can cause DEATH, SERIOUS BODILY INJURY, OR PROPERTY DAMAGE.

▲ WARNING

If this water heater will be used in beauty shops, barber shops, cleaning establishments, or self-service laundries with dry cleaning equipment, it is imperative that the water heater or water heaters be installed so that combustion and ventilation air be taken from outside these areas. Refer to the "Locating The New Water Heater" section of this manual and also the current edition of the National Fuel Gas Code, ANSI Z223.1, also referred to as NFPA 54 for specifics provided concerning air required.

Locating the New Water Heater (cont'd)

Combustion Air and Ventilation for Appliances Located in Unconfined Spaces

Unconfined Space is a space whose volume is not less than 50 cubic feet per 1,000 Btu per hour of the aggregate input rating of all appliances installed in that space. Rooms communicating directly with the space in which the appliances are installed, through openings not furnished with doors, are considered a part of the unconfined space.

In unconfined spaces in buildings, infiltration may be adequate to provide air for combustion, ventilation and dilution of flue gases. However, in buildings of tight construction (for example, weather stripping, heavily insulated, caulked, vapor barrier, etc.), additional air may need to be provided using the methods described in Combustion Air and Ventilation for Appliances Located in Confined Spaces.

Combustion Air and Ventilation for Appliances Located in Confined Spaces

Confined Space is a space whose volume is less than 50 cubic feet per 1,000 Btu per hour of the aggregate input rating of all appliances installed in that space.

a. ALL AIR FROM INSIDE BUILDINGS:

(See Page 7 Figure 1, and Figure 2 below)

The confined space shall be provided with two permanent openings communicating directly with an additional room(s) of sufficient volume so that the combined volume of all spaces meets the criteria for an unconfined space. The total input of all gas utilization equipment installed in the combined space shall be considered in making this determination. Each opening shall have a minimum free area of one square inch per 1,000 Btu per hour of the total input rating of all gas utilization equipment in the confined space, but not less than 100 square inches. One opening shall commence within 12 inches of the top and one commencing within 12 inches of the bottom of the enclosure.

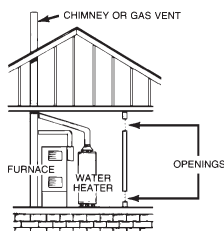

Figure 2

b. ALL AIR FROM OUTDOORS: (see Figures 3-5)

The confined space shall be provided with two permanent openings, one commencing within 12 inches of the top and one commencing within 12 inches from the bottom of the enclosure. The openings shall communicate directly, or by ducts, with the outdoors or spaces (crawl or attic) that freely communicate with the outdoors.

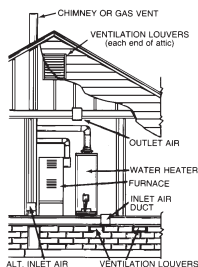

Figure 3

1. When directly communicating with the outdoors, each opening shall have a minimum free area of 1 square inch per 4,000 Btu per hour of total input rating of all equipment in the enclosure. (See Figure 3.)
2. When communicating with the outdoors through vertical ducts, each opening shall have a minimum free area of 1 square inch per 4,000 Btu per hour of total input rating of all equipment in the enclosure. (See Figure 4.)

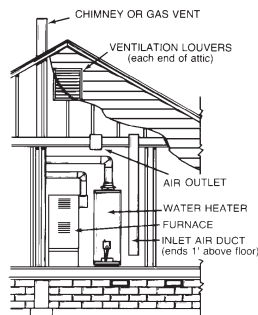

Figure 4

3. When communicating with the outdoors through horizontal ducts, each opening shall have a minimum free area of 1 square inch per 2,000 Btu per hour of total input rating of all equipment in the enclosure. (See Figure 5.)

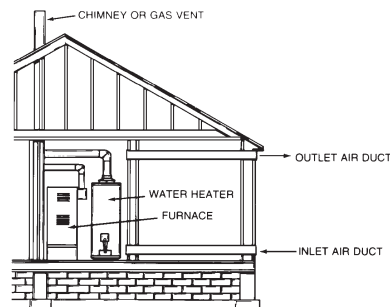

Figure 5

4. When ducts are used, they shall be of the same cross-sectional area as the free area of the openings to which they connect. The minimum short side dimension of rectangular air ducts shall not be less than 3 inches. (See Figure 5.)
5. Louvers and Grilles: In calculating free area, consideration shall be given to the blocking effect of louvers, grilles or screens protecting openings. Screens used shall not be smaller than 1/4 inch mesh. If the free area through a design of louver or grille is known, it should be used in calculating the size opening required to provide the free area specified. If the design and free area is not known, it may be assumed that wood louvers will be 20-25 percent free area and metal louvers and grilles will have 60-75 percent free area. Louvers and grilles shall be fixed in the open position or interlocked with the equipment so that they are opened automatically during equipment operation.
6. Special Conditions Created by Mechanical Exhausting or Fireplaces: Operation of exhaust fans, ventilation systems, clothes dryers or fireplaces may create conditions requiring special attention to avoid unsatisfactory operation of installed gas utilization equipment.

Installing the New Water Heater

Water Piping

▲ WARNING

HOTTER WATER CAN SCALD: Water heaters are intended to produce hot water. Water heated to a temperature which will satisfy clothes washing, dish washing, and other sanitizing needs can scald and permanently injure you upon contact. Some people are more likely to be permanently injured by hot water than others. These include the elderly, children, the infirm, or physically/mentally handicapped. If anyone using hot water in your home fits into one of these groups or if there is a local code or state law requiring a certain temperature water at the hot water tap, then you must take special precautions. In addition to using the lowest possible temperature setting that satisfies your hot water needs, a means such as a mixing valve, should be used at the hot water taps used by these people or at the water heater. Mixing valves are available at plumbing supply or hardware stores. Follow manufacturers instructions for installation of the valves. Before changing the factory setting on the thermostat, read the "Temperature Regulation" section in this manual.

This water heater shall not be connected to any heating systems or component(s) used with a non-potable water heating appliance.

If a water heater is installed in a closed water supply system, such as one having a back-flow preventer, check valve, water meter with check valve, etc. in the cold water supply, means shall be provided to control thermal expansion. Contact the water supplier or plumbing inspector on how to control this situation.

NOTE: To protect against untimely corrosion of hot and cold water fittings, it is strongly recommended that dielectric unions or couplings be installed on this water heater when connected to copper pipe.

The illustration shows the attachment of the water piping to the water heater. The water heater is equipped with $\frac{3}{4}$ " water connections.

NOTE: If using copper tubing, solder tubing to an adapter before attaching the adapter to the cold water inlet. Do not solder the cold water supply line directly to the cold water inlet. It will harm the dip tube and damage the tank.

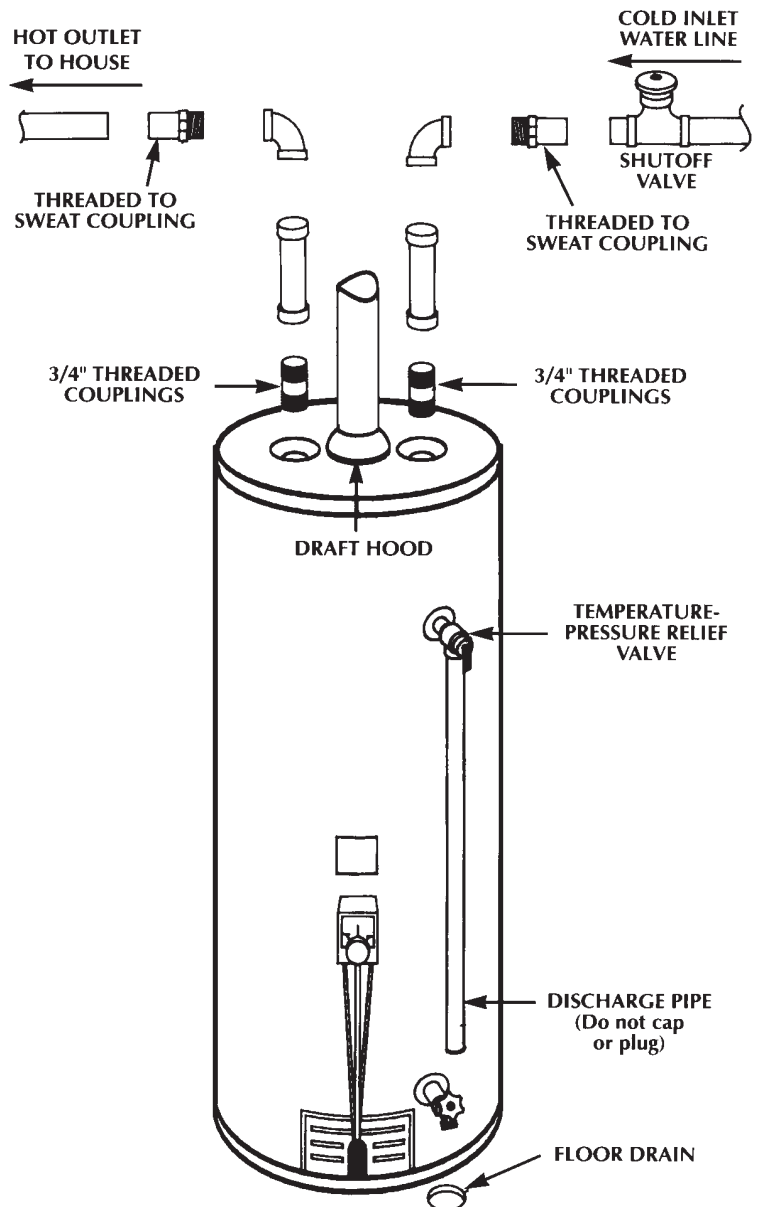

Installing the New Water Heater (cont'd)

Temperature-Pressure Relief Valve

▲ WARNING

At the time of manufacture this water heater was provided with a combination temperature-pressure relief valve certified by a nationally-recognized testing laboratory that maintains periodic inspection of production of listed equipment or materials, as meeting the requirements for Relief Valves and Automatic Gas Shutoff Devices for Hot Water Supply Systems, and the current edition of ANSI Z21.22 and the code requirements of ASME. If replaced, the valve must meet the requirements of local codes, but not less than a combination temperature and pressure relief valve certified as meeting the requirements for Relief Valves and Automatic Gas Shutoff Devices for Hot Water Supply Systems, ANSI Z21.22 by a nationally recognized testing laboratory that maintains periodic inspection of production of listed equipment or materials.

The valve must be marked with a maximum set pressure not to exceed the marked hydrostatic working pressure of the water heater (150 lbs. p.s.i.) and a discharge capacity not less than the water heater input rate as shown on the model rating plate. (Electric heaters - watts divided by 1000 x 3412 equal BTU/Hr. rate.)

Your local jurisdictional authority, while mandating the use of a temperature-pressure relief valve complying with ANSI Z21.22 and ASME, may require a valve model different from the one furnished with the water heater.

Compliance with such local requirements must be satisfied by the installer or end user of the water heater with a locally prescribed temperature-pressure relief valve installed in the designated opening in the water heater in place of the factory furnished valve.

For safe operation of the water heater, the relief valve must not be removed from its designated opening or plugged.

The temperature-pressure relief valve must be installed directly into the fitting of the water heater designated for the relief valve. Position the valve downward and provide tubing so that any discharge will exit only within 6 inches above, or at any distance below the structural floor. Be certain that no contact is made with any live electrical part. The discharge opening must not be blocked or reduced in size under any circumstances. Excessive length, over 30 feet, or use of more than four elbows can cause restriction and reduce the discharge capacity of the valve.

No valve or other obstruction is to be placed between the relief valve and the tank. Do not connect tubing directly to discharge drain unless a 6" air gap is provided. To prevent bodily injury, hazard to life, or property damage, the relief valve must be allowed to discharge water in quantities should circumstances demand. If the discharge pipe is not connected to a drain or other suitable means, the water flow may cause property damage.

The Discharge Pipe:

- Must not be smaller in size than the outlet pipe size of the valve, or have any reducing couplings or other restriction.
- Must not be plugged or blocked.
- Must be of material listed for hot water distribution.
- Must be installed so as to allow complete drainage of both the temperature-pressure relief valve, and the discharge pipe.
- Must terminate at an adequate drain.
- Must not have any valve between the relief valve and tank.

▲ WARNING

The temperature-pressure relief valve must be manually operated at least once a year. Caution should be taken to ensure that (1) no one is in front of or around the outlet of the temperature-pressure relief valve discharge line, and (2) the water manually discharged will not cause any bodily injury or property damage because the water may be extremely hot.

If after manually operating the valve, it fails to completely reset and continues to release water, immediately close the cold water inlet to the water heater, follow the draining instructions, and replace the temperature-pressure relief valve with a new one.

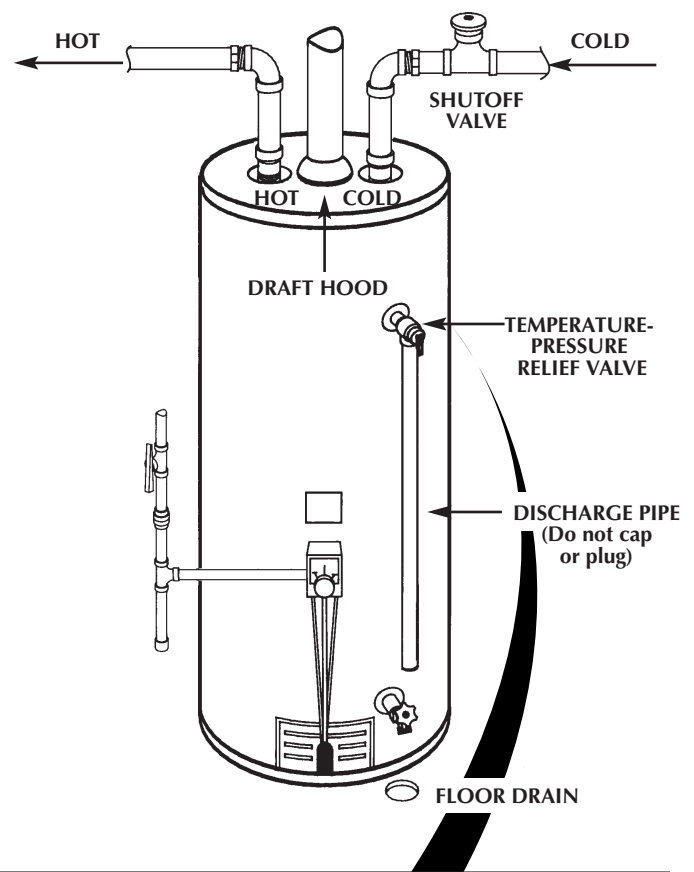

RELIEF VALVE OPENING

"THIS WATER HEATER IS PROVIDED WITH A COMBINATION TEMPERATURE-PRESSURE RELIEF VALVE. FOR SAFE OPERATION OF THE WATER HEATER, THE RELIEF VALVE(S) MUST NOT BE REMOVED FROM ITS DESIGNATED POINT OF INSTALLATION OR PLUGGED."

YOUR LOCAL JURISDICTIONAL AUTHORITY, WHILE MANDATING THE USE OF A TEMPERATURE-PRESSURE RELIEF VALVE COMPLYING WITH ANSI Z21.22 AND ASME, MAY REQUIRE A VALVE MODEL DIFFERENT FROM THE ONE FURNISHED WITH THE WATER HEATER.

COMPLIANCE WITH SUCH LOCAL REQUIREMENTS MUST BE SATISFIED BY THE INSTALLER OR END USER OF THE WATER HEATER WITH A LOCALLY PRESCRIBED TEMPERATURE-PRESSURE RELIEF VALVE INSTALLED IN THE DESIGNATED OPENING IN THE WATER HEATER.

SEE MANUAL HEADING—"TEMPERATURE-PRESSURE RELIEF VALVES" FOR INSTALLATION AND MAINTENANCE OF RELIEF VALVE, DISCHARGE LINE AND OTHER SAFETY PRECAUTIONS.

Installing the New Water Heater (cont'd)

Filling the Water Heater

▲ CAUTION

Never use this water heater unless it is completely full of water. To prevent damage to the tank, the tank must be filled with water. Water must flow from the hot water faucet before turning "ON" gas to the water heater.

To fill the water heater with water:

1. Close the water heater drain valve by turning the handle to the right (clockwise). The drain valve is on the lower front of the water heater.
2. Open the cold water supply valve to the water heater.
NOTE: The cold water supply valve must be left open when the water heater is in use.
3. To insure complete filling of the tank, allow air to exit by opening the nearest hot water faucet. Allow water to run until a constant flow is obtained. This will let air out of the water heater and the piping.
4. Check all new water piping for leaks. Repair as needed.

Venting

▲ WARNING

VENT DAMPERS - Any vent damper, whether it is operated thermally or otherwise must be removed if its use inhibits proper drafting of the water heater.

Thermally Operated Vent Dampers: Gas-fired water heaters having thermal efficiency in excess of 80% may produce a relatively low flue gas temperature. Such temperatures may not be high enough to properly open thermally operated vent dampers. This would cause spillage of flue gases and may cause carbon monoxide poisoning.

Vent dampers must bear evidence of certification as complying with the current edition of the American National Standard ANSI Z21.68 (ANSI Z21.66 & 67, respectively, cover electrically and mechanically actuated vent dampers). Before installation of any vent damper, consult the local gas utility for further information.

▲ WARNING

To insure proper venting of this gas-fired water heater, the correct vent pipe diameter must be utilized. Any additions or deletions of other gas appliances on a common vent with this water heater may adversely affect the operation of the water heater. Consult the local gas utility if any such changes are planned.

For proper venting in certain installations, a larger diameter vent pipe may be necessary. Due to great variances in installations, unforeseeable by the manufacturer of the water heater, you must consult your gas company to aid you in determining the proper venting for your water heater from the vent tables in the current edition of the National Fuel Gas Code ANSI Z223.1, also referred to as NFPA 54.

Check the venting system for signs of obstruction or deterioration and replace if needed.

The combustion and ventilation air flow must not be obstructed.

▲ WARNING

The water heater with draft hood installed must be connected to a chimney which terminates to the outdoors. Never operate the water heater unless it is vented to the outdoors and has adequate air supply to avoid risks of improper operation, explosion or asphyxiation.

▲ WARNING

Obstructed or deteriorated vent systems may present serious health risk or asphyxiation.

▲ WARNING

The vent pipe from the water heater must be no less than the diameter of the draft hood outlet on the water heater, and must slope upward to the chimney at least $\frac{1}{4}$ inch per linear foot.

All vent gases must be completely vented to the outdoors of the structure (dwelling). Install only the draft hood provided with the new water heater and no other draft hood.

Vent pipes must be secured at each joint with sheet metal screws.

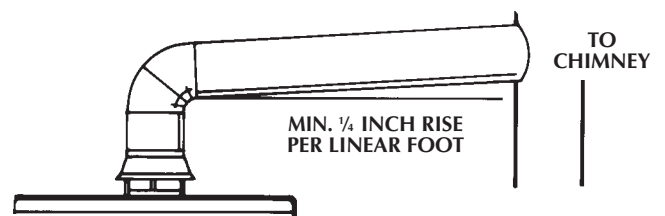

VENT PIPE INSTALLATION

There must be a minimum of 6 inches clearance between single wall vent pipe and any combustible material. Fill and seal any clearance between single wall vent pipe and combustible material with mortar mix, cement, or other noncombustible substance. For other than single wall, follow vent pipe manufacturer's clearance specifications. To insure a tight fit of the vent pipe in a brick chimney, seal around the vent pipe with mortar mix cement.

▲ WARNING

Failure to have required clearances between vent piping and combustible material will result in a fire hazard.

Installing the New Water Heater (cont'd)

Venting (cont'd)

▲ WARNING

Be sure vent pipe is properly connected to prevent escape of dangerous flue gases which could cause deadly asphyxiation.

▲ WARNING

Chemical vapor corrosion of the flue and vent system may occur if air for combustion contains certain chemical vapors. Spray can propellants, cleaning solvents, refrigerator and air conditioner refrigerants, swimming pool chemicals, calcium and sodium chloride, waxes, bleach and process chemicals are typical compounds which are potentially corrosive.

Gas Piping

▲ WARNING

Make sure the gas supplied is the same type listed on the model rating plate. The inlet gas pressure must not exceed 10.5 in. water column (2.6kPa) for natural gas or 13 in. water column (3.2kPa) for propane (L.P.) gas. The minimum inlet gas pressure listed on the rating plate is for the purpose of input adjustment.

▲ WARNING

If the gas control valve is subjected to pressures exceeding ½ pound per square inch (3.5kPa), the damage to the gas control valve could result in a fire or explosion from leaking gas.

▲ WARNING

If the main gas line shutoff serving all gas appliances is used, also turn "OFF" the gas at each appliance. Leave all gas appliances shut off until the water heater installation is complete.

A gas line of sufficient size must be run to the water heater. Consult the current edition of National Fuel Gas Code ANSI Z223.1, also referred to as NFPA 54 and the gas company concerning pipe size.

There must be:

- A readily accessible manual shut off valve in the gas supply line serving the water heater, and
- A drip leg (sediment trap) ahead of the gas control valve to help prevent dirt and foreign materials from entering the gas control valve.
- A flexible gas connector or a ground joint union between the shutoff valve and control valve to permit servicing of the unit.

Be sure to check all the gas piping for leaks before lighting the water heater. Use a soapy water solution, not a match or open flame. Rinse off soapy solution and wipe dry.

When installed at elevations above 2,000 feet, input rating should be reduced at the rate of 4 percent for each 1,000 feet above sea level which requires replacement of the burner orifice in accordance with the National Fuel Gas Code ANSI Z223.1 / NFPA 54. Contact your local gas utility for further information.

▲ WARNING

Failure to replace the standard orifice with a high altitude orifice when installed at elevations above 2,000 feet, could result in improper and inefficient operation of the appliance, producing carbon monoxide gas in excess of safe limits, which could result in serious injury or death. Contact your gas supplier for any specific changes which may be required in your area.

▲ WARNING

The appliance and its gas connection must be leak tested before placing the appliance in operation.

▲ WARNING

The appliance and its individual shutoff valve must be disconnected from the gas supply piping system during any pressure testing of that system at test pressures in excess of ½ pound per square inch (3.5kPa).

The appliance must be isolated from the gas supply piping system by closing its individual manual shutoff valve during any pressure testing of the gas supply piping system at test pressures equal to or less than ½ pound per square inch (3.5kPa).

▲ WARNING

Use pipe joint compound or teflon tape marked as being resistant to the action of petroleum [Propane (L.P.)] gases.

Connecting the gas piping to the gas control valve of the water heater can be accomplished by either of the two methods shown.

GAS PIPING WITH FLEXIBLE CONNECTOR

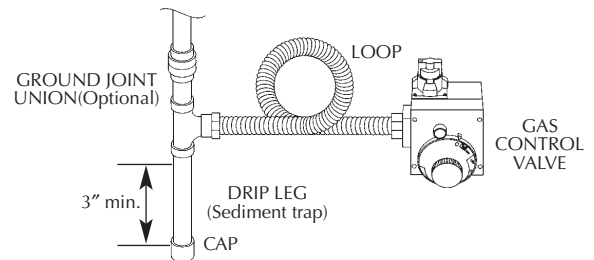

GAS PIPING WITH ALL BLACK IRON PIPE TO GAS CONTROL

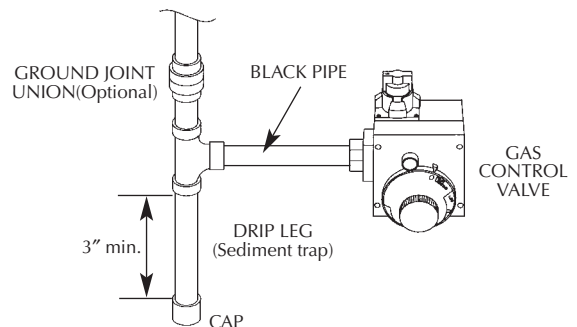

Installing the New Water Heater (cont'd)

▲ WARNING

Contaminants in the gas lines may cause improper operation of the gas control valve that may result in fire or explosion. Before attaching the gas line be sure that all gas pipe is clean on the inside. To trap any dirt or foreign material in the gas supply line, a drip leg (sometimes called a sediment trap) must be incorporated in the piping. The drip leg must be readily accessible. Install in accordance with the "Gas Piping" section. Refer to the current edition of the National Fuel Gas Code, ANSI Z223.1, also referred to as NFPA 54.

Installation Checklist

BEFORE LIGHTING THE PILOT:

1. Check the gas lines for leaks.
 - a. Use a soapy water solution. DO NOT test for gas leaks using a match or open flame.
 - b. Brush the soapy water solution on all gas pipes, joints and fittings.
 - c. Check for bubbling soap. This means you have a leak. Turn "OFF" gas and make the necessary repairs.
 - d. Recheck for leaks.
 - e. Rinse off soapy solution and wipe dry.

2. Is the new temperature-pressure relief valve properly installed and piped to an adequate drain? See "Temperature-Pressure Relief Valve" section.
3. Are the cold and hot water lines connected to the water heater correctly? See "Water Piping" instructions in the "Installing the New Water Heater" section.
4. Is the water heater completely filled with water? See "Filling the Water Heater" instructions in the "Installing the New Water Heater" section.
5. Will a water leak damage anything? See the "Locating the New Water Heater" section.
6. Is there proper clearance between the water heater and anything that might catch fire? See the "Locating the New Water Heater" section.
7. Do you have adequate ventilation so that the water heater will operate properly? See "Combustion Air and Ventilation" in the "Locating the New Water Heater" section.
8. Is the draft hood vent piping properly secured? See "Venting" instructions in the "Installing the New Water Heater" section.
9. Is there proper clearance between the vent pipe and anything that might catch on fire? See "Venting" instructions in the "Installing the New Water Heater" section.
10. Is the vent pipe properly sloped and does the vent terminate outdoors? See "Venting" instructions in the "Installing the New Water Heater" section.
11. Do you need to call your gas company to check the gas pipe and its hookup?

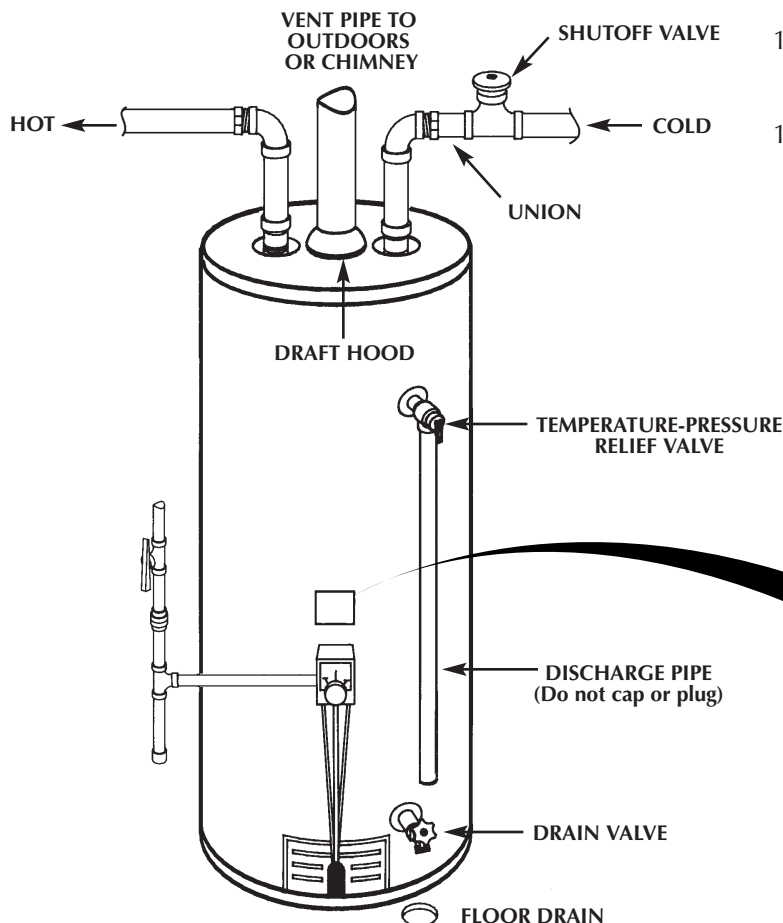

MODEL RATING PLATE

SUITABLE FOR WATER (POTABLE) HEATING				
MODEL NUMBER		CAPACITY		
		U.S. GAL.		
EQUIPPED FOR	INPUT	RECOVERY	SERIAL NUMBER	
GAS	BTU/HR	GAL./HR.		
MAXIMUM HYDROSTATIC WORKING PRESSURE		GAS PRESSURE IN W.C.		MANIFOLD
150		MAX. INLET	MIN. INLET PRESSURE	
P.S.I.		W.C.	W.C.	W.C.
AUTOMATIC STORAGE WATER HEATER				

Lighting

▲ WARNING

BEFORE LIGHTING [PROPANE (L.P.) GAS WATER HEATERS]: Propane (L.P.) gas is heavier than air. Should there be a leak in the system, the gas will settle near the ground. Basements, crawl spaces, skirted areas under manufactured (mobile) homes (even when ventilated), closets and areas below ground level will serve as pockets for the accumulation of this gas. Before attempting to light or relight the water heater's pilot or turning on a nearby electrical light switch, be absolutely sure there is no accumulated gas in the area. Search for odor of gas by sniffing at ground level in the vicinity of the appliance. If odor is detected, follow the steps indicated at "For Your Safety" on the cover page of this manual, then leave the premises.

Lighting and operating instructions are located on front of the water heater, above or to one side of the gas control valve.

▲ WARNING

AN ODORANT IS ADDED TO THE GAS USED BY THIS WATER HEATER.

**FOR YOUR SAFETY
IF YOU SMELL GAS:**

1. Do not try to light any appliance.
2. Do not touch any electrical switch; do not use any phone in your building.
3. Immediately call your gas supplier from a neighbor's phone. Follow the gas supplier's instructions.
4. If you cannot reach your gas supplier, call the fire department.

▲ WARNING

DO NOT force the gas control knob. Use only your hand to push it down to light the pilot, or to turn it to "ON", "OFF" or "PILOT". Never use a tool such as a lever, wrench or pliers. Do not hit or damage the knob. A damaged knob may result in an explosion and serious injury. If you have problem turning the knob, call the gas supplier immediately.

CHECK FOR LEAKS

Be sure to check all your gas pipes for leaks before lighting your water heater. Use a soapy water solution, not a match or open flame. Check the factory gas fittings after pilot is lit and gas control knob is still in "PILOT" position. Then, check the fittings when the main burner is turned "ON". Use a soapy water solution for this, too.

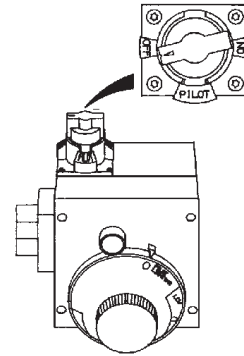

Figure 6

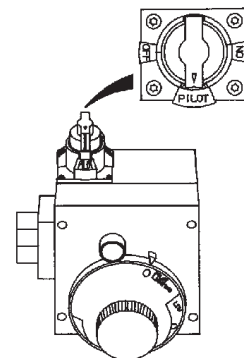

Figure 7

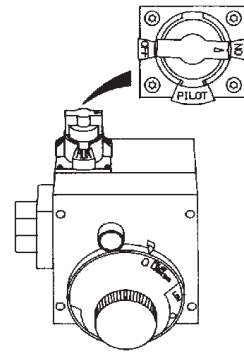

Figure 8

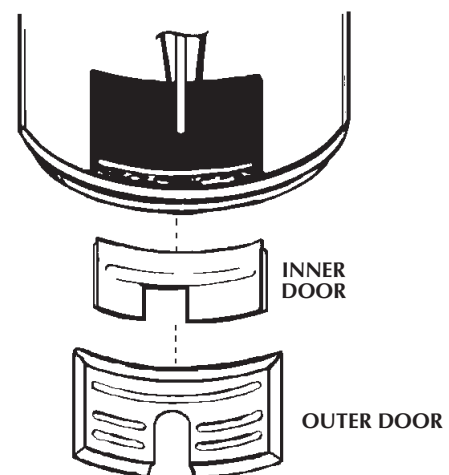

Figure 9

Lighting (cont'd)

FOR YOUR SAFETY READ BEFORE LIGHTING

WARNING



If you do not follow these instructions exactly, a fire or explosion may result causing property damage, personal injury or loss of life.

- A. This appliance has a pilot which must be lighted by hand. When lighting the pilot, follow these instructions exactly.
- B. **BEFORE LIGHTING** smell all around the appliance area for gas. Be sure to smell next to the floor because some gas is heavier than air and will settle on the floor.
WHAT TO DO IF YOU SMELL GAS
 - Do not try to light any appliance.
 - Do not touch any electric switch; do not use any phone in your building.
 - Immediately call your gas supplier from a neighbor's phone. Follow the gas supplier's instructions.
- C. If you cannot reach your gas supplier, call the fire department.
- D. Use only your hand to push in or turn the gas control knob. Never use tools. If the knob will not push in or turn by hand, don't try to repair it, call a qualified service technician. Force or attempted repair may result in a fire or explosion.
- E. Do not use this appliance if any part has been under water. Immediately call a qualified service technician to inspect the appliance and to replace any part of the control system and any gas control which has been under water.

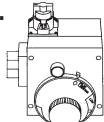

LIGHTING INSTRUCTIONS

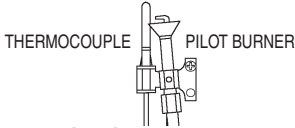
1. **STOP!** Read the safety information above on this label.
2. Remove outer door.
3. Set the thermostat dial to the "PILOT LIGHTING" position.



4. Turn gas control knob clockwise  to "OFF" position. Knob cannot be turned from "PILOT" to "OFF" unless knob is depressed slightly. **DO NOT FORCE.** (Figure 6)
5. Wait five (5) minutes to clear out any gas. If you then smell gas, **STOP!** Follow "B" in the safety information above on this label. If you don't smell gas, go to the next step.
6. Remove (or open) inner door located below the gas control unit. (Figure 9)
7. Find pilot-follow metal tube from gas control. The pilot is located in front of the burner.
 THERMOCOUPLE PILOT BURNER
8. If you don't smell gas, turn knob on gas control counter-clockwise  to "PILOT" position. (Figure 7)
9. Push in control knob all the way and hold down.



Immediately light the pilot with a match. Continue to hold control knob in for about one (1) minute after the pilot is lit. Release knob and it will pop back up. Pilot should remain lit. If it goes out, repeat steps 4 through 9.

- If knob does not pop up when released, stop and immediately call your service technician or gas supplier.
 - If the pilot will not stay lit after several tries, depress and turn the gas control knob clockwise  to "OFF" and call your service technician or gas supplier. (Figure 6)
10. Replace (or close) inner door. Replace outer door if door does not cover gas control on/off knob or temperature adjustment knob. (Figure 9)
 11. At arms length away, turn gas control knob counter-clockwise  to the full "ON" position. **WARNING: Do not use gas control knob to regulate gas flow.** (Figure 8)
 12. At arms length away, set the thermostat to desired setting. The mark (▲) indicative of approximate 120°F is preferred starting point. Some local laws may require a lower starting point. If hotter water is desired, see instruction manual and "warning" below.
 13. Replace the outer door if not replaced in step 10.

WARNING

Hotter water increases the risk of scald injury. Before changing temperature setting see instruction manual.

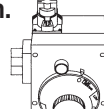
TO TURN OFF GAS TO APPLIANCE

1. Set the thermostat dial to the "PILOT LIGHTING" position.

2. Turn gas control knob clockwise  to "OFF" position. Knob cannot be turned from "PILOT" to "OFF" unless knob is depressed slightly. **DO NOT FORCE.** (Figure 6)
3. Replace outer door (if removed).

Temperature Regulation

Due to the nature of the typical gas water heater, the water temperature in certain situations may vary up to 30°F higher or lower at the point of use such as, bathtubs, showers, sink, etc.

This means that when the temperature adjustment dial is set at the mark approximating 120°F, the actual water temperature at any hot water tap could be as high as 150°F or as low as 90°F.

Any water heater's intended purpose is to heat water. Hot water is needed for cleansing, cleaning, and sanitizing (bodies, dishes, clothing). Hot water will present a scald hazard. Depending on the time element, and the people involved (normal adults, children, toddlers, elderly, infirm, etc.) scalding may occur at different temperatures.

The thermostat of this water heater has been factory set at its lowest position, to reduce the risk of scald injury. It is adjustable and must be reset to the desired temperature setting. The mark (▲) indicative of approximately 120°F is preferred starting point. Some states have a requirement for a lower setting. If you need hotter water, follow directions for temperature adjustment, but beware of the warnings in this section.

Turn the water temperature dial clockwise (↻) to decrease the temperature, or counterclockwise (↺) to increase the temperature.

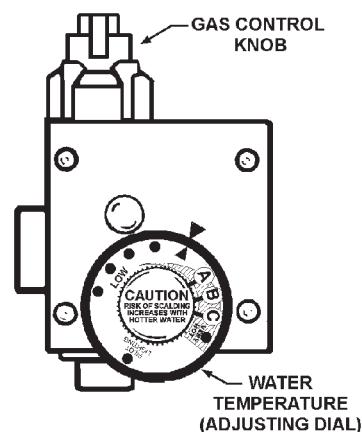

PILOT LIGHTING – Set here before attempting to light pilot.

▲ WARNING

HOTTER WATER CAN SCALD: Water heaters are intended to produce hot water. Water heated to a temperature which will satisfy space heating, clothes washing, dish washing, and other sanitizing needs can scald and permanently injure you upon contact. Some people are more likely to be permanently injured by hot water than others. These include the elderly, children, the infirm, or physically/mentally handicapped. If anyone using hot water in your home fits into one of these groups or if there is a local code or state law requiring a certain temperature water at the hot water tap, then you must take special precautions. In addition to using the lowest possible temperature setting that satisfies your hot water needs, a means such as a mixing valve, shall be used at the hot water taps used by these people or at the water heater. Mixing valves are available at plumbing supply or hardware stores. Follow manufacturers instructions for installation of the valves. Before changing the factory setting on the thermostat, read the "Temperature Regulation" section in this manual.

▲ WARNING

Never allow small children to use a hot water tap, or to draw their own bath water. Never leave a child or handicapped person unattended in a bathtub or shower.

Time to Produce 2nd & 3rd Degree Burns on Adult Skin

Temperature Setting

VERY HOT= approx. 160°F	About 1/2 second
C= approx. 150°F	About 1-1/2 seconds
B= approx. 140°F	Less than 5 seconds
A= approx. 130°F	About 30 seconds
▲= approx. 120°F	More than 5 minutes
LOW= approx. 80°F	-----

NOTE: Water temperature range of 120°–140°F recommended by most dishwasher manufacturers.

▲ WARNING

Should overheating occur or the gas supply fail to shut off, turn "OFF" the manual gas control valve to the appliance.

For Your Information

Start Up Conditions

DRAFT HOOD OPERATION

Check draft hood operation by performing a worst case depressurization of the building. With all doors and windows closed, and with all air handling equipment and exhaust fans operating, such as furnaces, clothes dryers, range hoods and bathroom fans, a match flame should still be drawn into the draft hood of the water heater with its burner firing. If the flame is not drawn toward the draft hood, shut off the water heater and make necessary air supply changes to correct.

CONDENSATION

Whenever the water heater is filled with cold water, a certain amount of condensation will form while the burner is on. A water heater may appear to be leaking when in fact the water is condensation. This usually happens when:

- When a new water heater is filled with cold water for the first time.
- When gas burns and water vapor is produced in water heaters, particularly high efficiency models where flue temperatures are lower.
- When you use large amounts of hot water in a short time and the refill water is very cold.

Moisture from the products of combustion condense on the cooler tank surfaces and form drops of water which may fall onto the burner or other hot surfaces to produce a "sizzling" or "frying" noise.

Excessive condensation can cause pilot outage due to water running down the flue tube onto the main burner and putting out the pilot.

Because of the suddenness and amount of water, condensation water may be diagnosed as a "tank leak". After the water in the tank warms up (about 1-2 hours), the condition should disappear.

Do not assume the water heater is leaking until there has been enough time for the water in the tank to warm up.

An undersized water heater will cause more condensation. The water heater must be sized properly to meet the family's demands for hot water including dishwashers, washing machines and shower heads.

Excessive condensation may be noticed during the winter and early spring months when incoming water temperatures are at their lowest.

Good venting is essential for a gas fired water heater to operate properly as well as to carry away products of combustion and water vapor.

SMOKE/ODOR

It is not uncommon to experience a small amount of smoke and odor during the initial start-up. This is due to burning off of oil from metal parts, and will disappear in a short while.

THERMAL EXPANSION

Water supply systems may, because of such events as high line pressure, frequent cut-offs, the effects of water hammer among others, have installed devices such as pressure reducing valves, check valves, back flow preventers, etc. to control these types of

problems. When these devices are not equipped with an internal by-pass, and no other measures are taken, the devices cause the water system to be closed. As water is heated, it expands (thermal expansion) and closed systems do not allow for the expansion of heated water.

The water within the water heater tank expands as it is heated and increases the pressure of the water system. If the relieving point of the water heater's temperature-pressure relief valve is reached, the valve will relieve the excess pressure. **The temperature-pressure relief valve is not intended for the constant relief of thermal expansion.** This is an unacceptable condition and must be corrected.

It is recommended that any devices installed which could create a closed system have a by-pass and/or the system have an expansion tank to relieve the pressure built by thermal expansion in the water system. Expansion tanks are available for ordering through a local plumbing contractor. Contact the local water supplier and/or plumbing inspector for assistance in controlling these situations.

STRANGE SOUNDS

Possible noises due to expansion and contraction of some metal parts during periods of heat-up and cool-down do not represent harmful or dangerous conditions.

Condensation causes sizzling and popping with the burner area during heating and cooling periods and should be considered normal. See "Condensation" in this section.

Operational Conditions

SMELLY WATER

In each water heater there is installed at least one anode rod (see parts section) for corrosion protection of the tank. Certain water conditions will cause a reaction between this rod and the water. The most common complaint associated with the anode rod is one of a "rotten egg smell." This odor is derived from hydrogen sulfide gas dissolved in the water. The smell is the result of four factors which must all be present for the odor to develop:

- a concentration of sulfate in the supply water.
- little or no dissolved oxygen in the water.
- a sulfate reducing bacteria within the water heater. (This harmless bacteria is non-toxic to humans.)
- an excess of active hydrogen in the tank. This is caused by the corrosion protective action of the anode.

Smelly water may be eliminated or reduced in some water heater models by replacing the anode(s) with one of less active material, and then chlorinating the water heater tank and all hot water lines. Contact the local water heater supplier for further information concerning an Anode Replacement Kit #9000029 and this Chlorination Treatment.

If the smelly water persists after the anode replacement and chlorination treatment, we can only suggest that continuous chlorination and filtering conditioning equipment be considered to eliminate the water problem.

Do not remove the anode leaving the tank unprotected. By doing so, all warranty on the water heater tank is voided.

For Your Information (cont'd)

"AIR" IN HOT WATER FAUCETS

▲ WARNING

HYDROGEN GAS: Hydrogen gas can be produced in a hot water system that has not been used for a long period of time (generally two weeks or more). Hydrogen gas is extremely flammable and explosive. To prevent the possibility of injury under these conditions, we recommend the hot water faucet be opened for several minutes at the kitchen sink before any electrical appliances which are connected to the hot water system are used (such as a dishwasher or washing machine). If hydrogen gas is present, there will probably be an unusual sound similar to air escaping through the pipe as the hot water faucet is opened. There must be no smoking or open flame near the faucet at the time it is open.

HIGH TEMPERATURE SHUT OFF SYSTEM

This water heater is equipped with an automatic gas shut off system. This system works when high water temperatures are present. Turn "OFF" the entire gas supply to the water heater. The high temperature shut off is built into the gas control valve. It is non-resettable. If the high temperature shut off activates, the gas control valve must be replaced. Contact the local gas utility.

▲ WARNING

Should overheating occur or the gas supply fail to shut off, turn "OFF" the manual gas control valve to the appliance.

NOT ENOUGH OR NO HOT WATER

1. Check the manual gas shut off valve to be sure it is open.
2. Check the pilot flame. It may have gone out. All models have an opening behind the outer door for viewing the pilot.
3. If the pilot is not lit, follow the "Lighting" instructions in this manual or located above the gas control valve on the water heater to relight the pilot. If the water was extremely hot and is now cold, the high limit safety temperature shut off may have put out the burner and pilot. The gas control valve now must be changed.
4. The gas control knob must be turned to the "ON" position.
5. The temperature adjustment dial may be set too low. See the "Temperature Regulation" section.
6. The gas company can check the gas input to see if it is correct. An underfired water heater will not heat water as quickly.
7. Look for leaking or open hot water faucets. Make sure all are closed.
8. The cold water inlet temperature may be colder during the winter months. It will take longer to heat the water and seem like less hot water.
9. If you cannot find what is wrong, call the local gas utility and/or plumbing contractor.

WATER IS TOO HOT

1. The temperature adjustment dial may be set too high. See the "Temperature Regulation" section.

NOTE: A period of time is necessary after an adjustment has been made for the water temperature to reach the new temperature setting.

2. If lower temperature settings will not lower the water temperature, call the local gas utility.

Periodic Maintenance

Venting System Inspection

At least once a year a visual inspection should be made of the venting system. You should look for:

1. Obstructions which could cause improper venting. The combustion and ventilation air flow must not be obstructed.
2. Damage or deterioration which could cause improper venting or leakage of combustion products.
3. Rusted flakes around top of water heater.

▲ WARNING

Be sure the vent piping is properly connected to prevent escape of dangerous flue gasses which could cause deadly asphyxiation.

▲ WARNING

Obstructions and deteriorated vent systems may present serious health risk or asphyxiation.

▲ WARNING

Chemical vapor corrosion of the flue and vent system may occur if air for combustion contains certain chemical vapors. Spray can propellants, cleaning solvents, refrigerator and air conditioner refrigerants, swimming pool chemicals, calcium and sodium chloride, waxes, bleach and process chemicals are typical compounds which are potentially corrosive.

Periodic Maintenance (cont'd)

▲ WARNING

If after inspection of the vent system you found sooting or deterioration, something is wrong. Call the local gas utility to correct the problem and clean or replace the flue and venting before resuming operation of the water heater.

Burner Inspection

▲ WARNING

Flood damage to a water heater may not be readily visible or immediately detectable. However, over a period of time a flooded water heater will create dangerous conditions which can cause DEATH, SERIOUS BODILY INJURY, OR PROPERTY DAMAGE. Contact a qualified service technician or contractor to replace a flooded water heater. Do not attempt to repair the unit! It must be replaced!

At least once a year a visual inspection should be made of the main burner and pilot burner. The drawing is for your reference.

You should check for sooting which is not normal and will impair proper combustion.

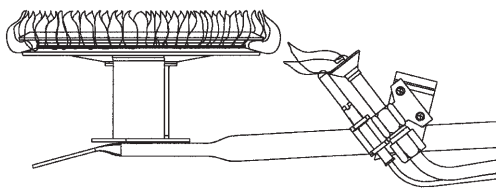

▲ WARNING

Soot build-up indicates a problem that requires correction before further use. Turn "OFF" gas to water heater and leave "OFF" until repairs are made, because failure to correct the cause of the sooting can result in a fire causing DEATH, SERIOUS BODILY INJURY, OR PROPERTY DAMAGE.

Burner Cleaning

In the event your burner needs cleaning, use the following instructions:

If inspection of the burner shows that cleaning is required, turn the gas control knob clockwise (↻) to the "OFF" position, depressing slightly.

NOTE: The knob cannot be turned from "PILOT" to "OFF" unless knob is depressed slightly. DO NOT FORCE.

Loose deposits on or around the burner can be removed by carefully using the hose of a vacuum cleaner inserted through the access door of the water heater. If the burner needs to be removed for additional cleaning, call the local gas utility to remove and clean the burner and correct the problem that required the burner to be cleaned.

L.P. Gas Control Valve & Burner Assembly Replacement Information

▲ WARNING

PROPANE (L.P.) GAS CONTROL VALVE AND BURNER ASSEMBLY REPLACEMENT INFORMATION.

For Propane (L.P.) Gas Models Only:

Your water heater is equipped with a Propane (L.P.) gas control valve and a main burner assembly with left hand threads for the following fittings and their connections.

- (1) The connection between the manifold and the gas control valve (A to B) are left hand threads.
- (2) The connection between the main burner orifice and the manifold (C to D) are left hand threads.

For ordering these replacement parts, please refer to the "Repair Parts" section of this manual.

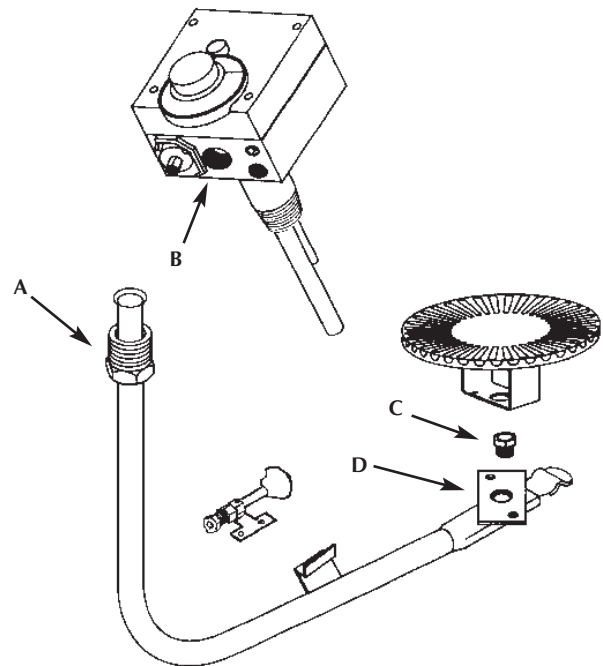

Housekeeping

Vacuum around base of water heater for dust, dirt, and lint on a regular basis.

▲ WARNING

INSTALLED IN SUITABLE AREA: To insure sufficient ventilation and combustion air supply, proper clearances from the water heater must be maintained. See "Locating the New Water Heater" section. Combustible materials such as clothing, cleaning materials, or flammable liquids, etc. must not be placed against or adjacent to the water heater which can cause a fire.

Periodic Maintenance (cont'd)

Anode Rod Inspection

The anode rod is used to protect the tank from corrosion. Most hot water tanks are equipped with an anode rod. The submerged rod sacrifices itself to protect the tank. Instead of corroding the tank, water ions attack and eat away the anode rod. This does not affect the water's taste or color. The rod must be maintained to keep the tank in operating condition.

Anode deterioration depends on water conductivity, not necessarily water condition. A corroded or pitted anode rod indicates high water conductivity and should be checked and/or replaced more often than an anode rod that appears to be intact. Replacement of a depleted anode rod can extend the life of your water heater. Inspection should be conducted by a qualified technician, and at a minimum should be checked annually after the warranty period.

Temperature-Pressure Relief Valve Operation

The temperature-pressure relief valve must be manually operated at least once a year.

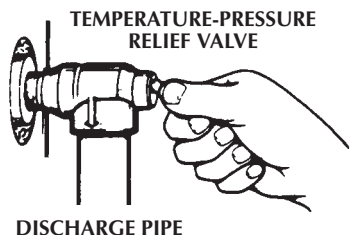

▲ WARNING

When checking the temperature-pressure relief valve operation, make sure that (1) no one is in front of or around the outlet of the temperature-pressure relief valve discharge line, and (2) that the water manually discharged will not cause any property damage because the water may be extremely hot.

If after manually operating the valve, it fails to completely reset and continues to release water, immediately close the cold water inlet to the water heater, follow the draining instructions, and replace the temperature-pressure relief valve with a new one.

Failure to install and maintain a new properly listed temperature-pressure relief valve will release the manufacturer from any claim which might result from excessive temperature or pressure.

▲ WARNING

If the temperature-pressure relief valve on the appliance weeps or discharges periodically, this may be due to thermal expansion. Your water heater may have a check valve installed in the water line or a water meter with a check valve. Consult the water supplier and/or plumbing inspector for further information. Do not plug the temperature-pressure relief valve.

Draining

The water heater should be drained if being shut down during freezing temperatures. Also periodic draining and cleaning of sediment from the tank may be necessary.

1. Turn the gas control knob to the "OFF" position.
2. CLOSE the cold water inlet valve to the water heater.
3. OPEN a nearby hot water faucet and leave open to allow for draining.
4. Connect a hose to the drain valve and terminate to an adequate drain.
5. OPEN the water heater drain valve to allow for tank draining.

NOTE: If the water heater is going to be shut down and drained for an extended period, the drain valve should be left open with hose connected allowing water to terminate to an adequate drain.

6. Close the drain valve.
7. Follow instructions in the "Filling The Water Heater" section.
8. Follow the lighting instructions in the "Lighting" section to restart the water heater.

Drain Valve Washer Replacement

NOTE: For replacement, use a $\frac{1}{32}$ " x $\frac{13}{64}$ " x $\frac{1}{8}$ " thick washer available at your nearest hardware store. For ordering replacement washers, refer to the "Repair Parts" section.

1. Turn "OFF" gas supply to water heater.
2. Follow "Draining" instructions.
3. Turning counter clockwise, remove the hex cap below the screw handle.
4. Remove the washer and put the new one in place.
5. Screw the handle and cap assembly back into the drain valve and retighten using a wrench. DO NOT OVER TIGHTEN.
6. Follow instructions in the "Filling The Water Heater" section.
7. Check for leaks.
8. Follow the lighting instructions in the "Lighting" section to restart the water heater.



Service

If a condition persists or you are uncertain about the operation of the water heater, let a qualified person check it out. Call the local utility and/or plumbing contractor.

Leakage Checkpoints

Use this guide to check a “Leaking” water heater. Many suspected “Leakers” are not leaking tanks. Often the source of the water can be found and corrected.

If you are not thoroughly familiar with gas codes your water heater, and safety practices, contact the gas utility to check the water heater.

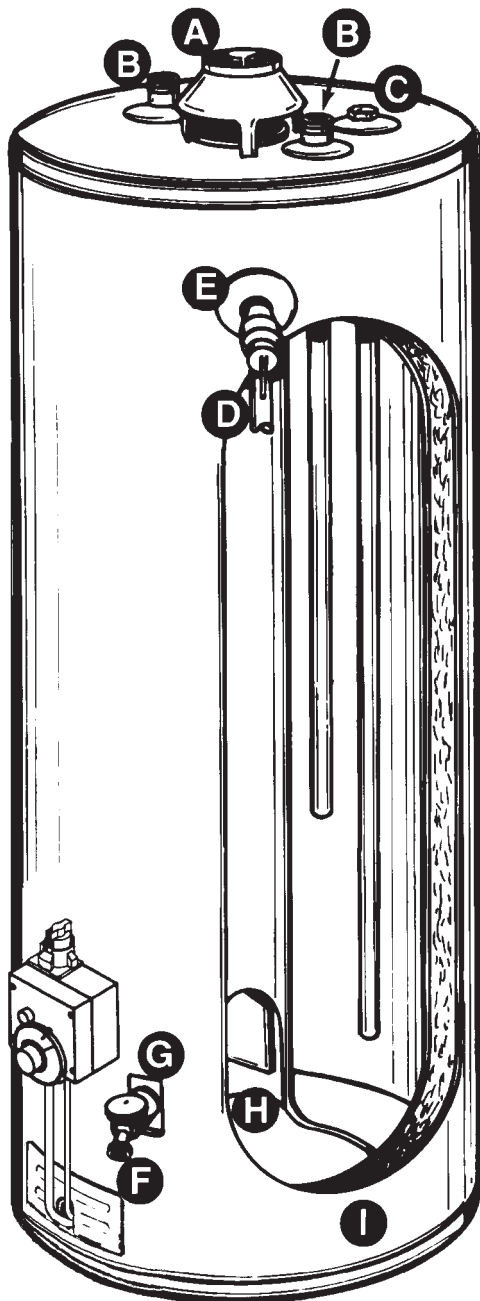

▲ CAUTION

Read this manual first. Then before checking the water heater make sure the gas supply has been turned “OFF”, and never turn the gas “ON” before the tank is completely full of water.

▲ CAUTION

Never use this water heater unless it is completely filled with water. To prevent damage to the tank, the tank must be filled with water. Water must flow from the hot water faucet before turning “ON” gas to the water heater.

- A** Water at the draft hood is water vapor which has condensed out of the combustion products. This is caused by a problem in the vent. Contact the gas utility.
- B** *Condensation may be seen on pipes in humid weather or pipe connections may be leaking.
- C** *The primary anode rod fitting may be leaking.
- D** Small amounts of water from temperature-pressure relief valve may be due to thermal expansion or high water pressure in your area.
- E** *The temperature-pressure relief valve may be leaking at the tank fitting.
- F** Water from a drain valve may be due to the valve opened slightly.
- G** *The drain valve may be leaking at the tank fitting.
- H** Combustion products contain water vapor which can condense on the cooler surfaces of the tank. Droplets form and drip into the fire or run on the floor. This is common at the time of startup after installation and when incoming water is cold.
- I** Water in the water heater bottom or on the floor may be from condensation, loose connections, or the relief valve. DO NOT replace the water heater until a full inspection of all possible water sources is made and necessary corrective steps taken.

Leakage from other appliances, water lines, or ground seepage should also be checked.

*To check where threaded portion enters tank, insert cotton swab between jacket opening and fitting. If cotton is wet, follow “Draining” instructions in the “Periodic Maintenance” section and then remove fitting. Put pipe dope or teflon tape on the threads and replace. Then follow “Filling the Water Heater” instructions in the “Installing the New Water Heater” section.

Repair Parts

KEY NO.	PART DESCRIPTION
1	Temperature-Pressure Relief Valve
2	Primary Anode Rod
3	Drain Valve*
4	Drain Valve Washer ($1\frac{7}{32}$ " x $1\frac{3}{64}$ " x $\frac{1}{8}$ " thick)*
5	Pilot
6	Thermocouple*
7	Pilot Tubing w/Fittings
8	Burner Orifice
9	Manifold
10	Burner
11	Outer Door
12	Inner Door
13	Gas Control Valve
14	Temperature Adjustment Knob*
15	Dip Tube
16	Flue Baffle
17	Draft Hood
#	Manual

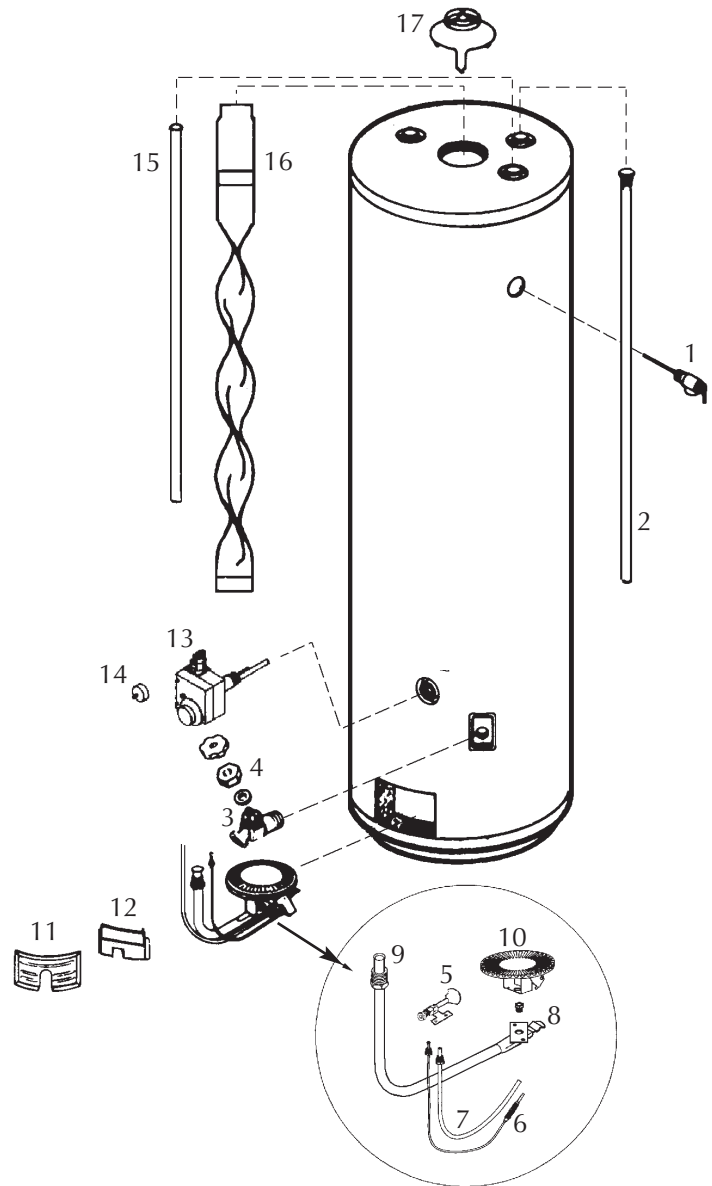

*These parts are available at most hardware stores.
Not Illustrated

Now that you have purchased this water heater, should a need ever exist for repair parts or service, simply contact the company it was purchased from or direct from the manufacturer listed on the rating plate on the water heater.

Be sure to provide all pertinent facts when you call or visit.

Selling prices will be furnished on request or parts will be shipped at prevailing prices and you will be billed accordingly.

The model number of your Gas Water Heater will be found on the rating plate located above the gas control valve.

WHEN ORDERING REPAIR PARTS, ALWAYS GIVE THE FOLLOWING INFORMATION:

MODEL NUMBER	TYPE GAS [NATURAL OR PROPANE (L.P.)]
SERIAL NUMBER	PART DESCRIPTION

THIS IS A REPAIR PARTS LIST, NOT A PACKING LIST.

Notes

