

Westwood

DE-AERATION



Tigerloop®
Oil De-Aerators

Increase Efficiency!
Burn Oil Cleaner!
Reduce Soot!



Standard
Models



BioHeat®
Models
(up to B100)

Tigerloop® will increase the efficiency of any burner by reducing vacuum, removing air and pre-heating oil delivered to the nozzle. Tigerloop® also reduces soot problems by burning cleaner and minimizing nozzle drips from air bubbles expanding in the nozzle line.

FILTRATION

Oil Filters
&
Spin Ons



IGNITION

Electrodes
& Terminals



Rajah™ Terminals



ACCESSORIES

Couplings

Nylo-Flex™

Spiralink™



Testers



Heating Products

Westwood Products Inc.

www.WestwoodProducts.com

330 William Street • P.O. Box 610 • South River, NJ 08882

Dear Westwood Customer,

Here is the latest Westwood Heating Products Catalog. As with our previous issues, this issue has new items and additions that are geared to the heating service industry. Every section has been revised and updated in our ongoing effort to make the Westwood Catalog the most comprehensive reference source for the products your customers, as professionals, demand and deserve.

In keeping with today's trend toward renewable fuels, we have expanded the number of products that are "BIOFUELS COMPATIBLE". Look for our logo (shown below) throughout the new catalog.

Our customers continue to remark that they had no idea such a varied and complete line of products was hidden amongst all those pages. Take a look yourself and browse through this latest issue. A small investment of time will prove a worthwhile experience. You will find that Westwood has truly become a "one stop" source for all your heating specialty needs.

Sincerely,



Pat DiNicola
President



PUBLIC NOTICE OF RESTRICTED PRODUCT USE

 The products shown in this catalog are "for professional use only" and not for use by the general public. They are for use in servicing heating equipment by a trained, qualified technician familiar with such systems, equipped with the proper tools and equipment, familiar with all governing codes and ordinances, and licensed by the proper authority where applicable. **WARNING: USE OF THESE PRODUCTS BY AN UNQUALIFIED PERSON CAN RESULT IN HAZARDS TO THAT PERSON AND OTHERS. THESE HAZARDS MAY INCLUDE RELEASE OF FUEL, FIRE, SEVERE BURNS, DAMAGE TO SYSTEM COMPONENTS, AND OTHER HAZARDS**

STATEMENT OF BIOFUELS COMPATIBILITY

The use in this catalog of the "biofuels COMPATIBLE" logo for a product indicates that the item has been tested by Westwood Products or the product's manufacturer and found to be suitable for use with biofuels made from biodiesel meeting ASTM D6751 and fuel oil meeting ASTM D396 at the blends indicated on the logo (i.e. B5, B20, B100), or lower. This suitability is specific as to that product's life expectancy and performance when used (1.) in an application for which it was originally designed, and (2.) as part of a system wherein all other non-Westwood components have been similarly approved by their respective manufacturers. Further, the indication of biofuels compatibility for an item that is UL Listed, or is a UL Recognized Component, shall not be construed to indicate testing by UL for biofuels compatibility.

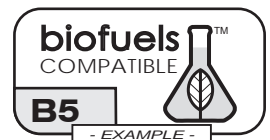

TERMS

Invoice Terms: 2% 10 days, Net 30 days upon credit approval. No discount allowed on freight charges.

Freight: All shipments FOB our plant, South River, New Jersey.

Prices: Price lists are available only to authorized distributors. Possession of a confidential price list by anyone else does not constitute an offer to sell. All prices subject to change without notice.

Sales Policy: Westwood Products Inc. sells only to wholesale supply houses or original equipment manufacturers. All orders are subject to home office approval. Minimum order charge is \$25.00.

Late Charges: There will be a 1-1/2% per month late charge on accounts over 30 days old.

Returns: Returned goods will not be accepted without authorization and may be subject to a restocking charge.

Warranty: Westwood Products Inc. guarantees that any product of its manufacture which is found to be defective in material or workmanship and is not suitable for use or service for the purpose for which it is designed will be replaced free of charge within one year of purchase. This includes transportation costs (US only) but no costs of installation. Inspection must be performed by a Westwood representative. This shall be Westwood's maximum liability. The sale of these products under any other warranty, expressed or implied, is not authorized by Westwood.

QUICK INDEX TO SECTIONS

CONTAINS

SECTION

CONTAINS	SECTION
CROSS FORMER PART NUMBERS TO NEW  No.	CROSS REFERENCE
CHEMICALS ODOR NEUTRALIZERS, FUEL TREATMENT, SOLVENTS	C
ELECTRICAL ELECTRODES, TERMINALS, AND RELATED ITEMS	E
FILTERS & FILTER ELEMENTS HEATING OIL FILTERS AND RELATED ITEMS	F
HYDRONIC PRODUCTS FOR STEAM & HOT WATER HEAT	H
SERVICE PARTS & SUPPLIES PRODUCTS TO SERVICE & MAINTAIN HEATING SYSTEMS	S
TOOLS & TESTERS SPECIALIZED TOOLS & TESTERS FOR THE SERVICE TECH	T
COMPLETE ALPHABETICAL INDEX OF PRODUCTS	INDEX

CROSS REFERENCE

Reference No.

TO



No.

(Before May 1, 2004 Westwood number)

(After May 1, 2004 Westwood number)

As of May 1, 2004, all Westwood part numbers were changed and updated to a new numbering system. This cross reference contains a listing by "Reference No." (the pre May 1, 2004 part number) and shows the corresponding new part number and the page number on which the item may be found.



SPECIAL NOTE: FOR ELECTRODES, PORCELAINS, & Rajah™ TERMINALS

The  No. for electrodes and related items is "E5-" followed by the former number.

Example: former electrode number "1510" is now "E5-1510"



The  No. for Rajah™ terminals and related items is "E9-" followed by the former number.

Example: former Rajah™ terminal number "CT" is now "E9-CT"

Reference No.	 No.	Page	Reference No.	 No.	Page	Reference No.	 No.	Page
Electrodes	E5 Series	E1	#135	S70-25	S2	3607	S213-7	S13
Rajah™ Terminals	E9 Series	E25	#200	S70-27	S2	3608	S213-8	S13
#1	S70-30	S2	250 BOOT	E9-250 BOOT	E29	3611	S213-11	S13
#2	S70-35	S2	251 BOOT	E9-251 BOOT	E29	3612	S213-12	S13
#3	S70-40	S2	#271	T200-15	T18	3616	S213-16	S13
#3 Gasket	H6-50	H2	467 GASKET	E9-467 GASKET	E27	4030	S90-10	S9
3L V-Belts	S30 Series	S1	475-243	S90-60	S9	4230	S90-12	S9
#4	S70-45	S2	475-287	S90-62	S9	4235	S90-14	S9
4FO-30	F84-30	F11	500 SHIELD	E9-500 SHIELD	E27	4725	S90-16	S9
4FO-IB	F84-36	F11	575-287	S90-64	S9	4729	S90-18	S9
4FO-IBG	F84-48	F11	625-400	S90-66	S9	4729-1	S91-18	S9
4L V-Belts	S40 Series	S1	686 BAR	E9-686 BAR	E27	4734	S90-20	S9
5L V-Belts	S50 Series	S1	#695	T200-10	T17	4734-1	S91-20	S9
6FO-30	F85-30	F11	951-57	S91-74	S9	5220	S90-22	S9
8FO-30	F86-30	F11	951-78	S90-68	S9	5220-1	S91-22	S9
#9	S70-9	S2	951-81	S90-70	S9	5225	S90-24	S9
#10	S70-10	S2	951-170	S91-72	S9	5225-1	S91-24	S9
#11	S70-11	S2	#996	T100-340	T16	5229	S90-26	S9
#12	S70-12	S2	#996-W	T100-342	T16	5229-1	S91-26	S9
12" Lighter	T34-40	T7	#997	T100-370	T17	5234	S90-28	S9
#13	S70-13	S2	#1240	S85-530	S6	5234-1	S91-28	S9
#15	S70-15	S2	#1240C	S85-540	S6	5495	H25-10	H7
20 AMP BOOT	E9-20 AMP BOOT	E29	#1242	S85-550	S6	5504	S100-158	S10
20 AMP CLIP	E9-20 AMP CLIP	E29	#1250	S85-560	S6	5506	S100-160	S10
#33 Gasket	H6-55	H2	#1251	S85-570	S6	5508	S100-162	S10
34	E9-34	E28	1412	S214-12	S13	5510	S100-164	S10
#35	T100-310	T16	1416	S214-16	S13	5512	S100-166	S10
#35 Blade	T100-312	T16	1890	S83-200	S4	5514	S100-168	S10
54	E9-54	E28	2097	E9-2097	E28	5515	S100-170	S10
#88	S85-500	S6	#3250	E64	E30	5516	S100-172	S10
#99A	S85-510	S6	#3253	E64-20	E30	5549	H25-12	H7
#101	S85-520	S6	3500	E9-3500	E28	5551	S100-174	S10
			3605	S213-5	S13	5554	S100-176	S10

• REFERENCE No. IS THE FORMER WESTWOOD NUMBER (before May 1, 2004) •



Reference No. TO  No.

Reference No.	 No.	Page	Reference No.	 No.	Page	Reference No.	 No.	Page
5561	S100-178	S10	51484U	S88-32	S7	165381	S100-274	S10
5563	S100-180	S10	51670U	S88-34	S7	166664	S100-200	S10
5729	S90-30	S9	52420	S100-126	S10	166665	S100-202	S10
5729-1	S91-30	S9	52576	S100-130	S10	166666	S100-204	S10
5734	S90-32	S9	58156	S100-412	S11	166667	S100-206	S10
5734-1	S91-32	S9	75260	S100-404	S11	166668	S100-208	S10
5738	S90-34	S9	75991	S100-328	S11	166669	S100-210	S10
5738-1	S91-34	S9	75995	S100-326	S11	AB	E9-AB	E27
6325	S90-36	S9	75996	S100-334	S11	AECF	E9-AECF	E29
6329	S90-38	S9	135392	H25-16	H7	AO25	F15-36	F10
6329-1	S91-38	S9	135393	H25-15	H7	AO25B	F15-48	F10
6334	S90-40	S9	141608	S70-50	S2	AO30	F75-12	F10
6334-1	S91-40	S9	141612	S70-51	S2	AO70	F35-24	F10
6338	S90-42	S9	144434	H25-18	H7	ARM-3L	S300-404	S23
6338-1	S91-42	S9	144435	H25-17	H7	ARM-3S	S300-400	S23
6342	S90-44	S9	144826	H25-19	H7	ARM-5C	S300-412	S23
6342-1	S91-44	S9	144827	H25-20	H7	ARM-5L	S300-406	S23
6346	S90-46	S9	146010	S100-100	S10	ARM-5S	S300-402	S23
7243-1	S91-48	S9	146011	S100-102	S10	ARM-14	S300-408	S23
7328	T100-50	T13	146013	S100-104	S10	ARM-15	S300-410	S23
11498	H25-31	H7	161963	S100-300	S11	BB	E9-BB	E27
11937	H25-35	H7	161964	S100-302	S11	BG-4	F80-52	F11
21551	S100-322	S11	161965	S100-306	S11	BG-20	F90-52	F11
21552	S100-324	S11	161966	S100-308	S11	BG-25	F10-52	F11
21553	S100-330	S11	161967	S100-310	S11	BG-33	H24-40	H5
21554	S100-332	S11	161968	S100-312	S11	BG-2002	F92-52	F11
31156	S88-70	S8	161969	S100-314	S11	BK-1	S88-36	S7
31156W	S88-72	S8	161970	S100-316	S11	BK-2	S88-38	S8
31157	S88-74	S8	161971	S100-318	S11	BK5780	S88-10	S7
31157W	S88-76	S8	161972	S100-320	S11	BK5782	S88-14	S7
45330	S100-114	S10	162787	S100-320	S11	CBR	E9-CBR	E27
45331	S100-146	S10	165282	S100-304	S11	CBS	E9-CBS	E27
45764	S100-112	S10	165283	S100-212	S10	CG-25	F10-50	F11
45765	S100-152	S10	165284	S100-214	S10	CG-70	F30-50	F11
46644	S100-110	S10	165285	S100-216	S10	CG-300	F75-50	F11
46645	S100-136	S10	165286	S100-218	S10	CG-2002	F92-50	F11
46646	S100-408	S11	165287	S100-220	S10	CG-B4	F80-50	F11
46648	S100-156	S10	165288	S100-222	S10	CK-1	E9-CK-1	E28
46775	H25-30	H7	165289	S100-224	S10	CK780	S88-50	S8
46778	S100-120	S10	165290	S100-226	S10	CO2 Cartridges	T32-30	T7
46912	S100-116	S10	165291	S100-228	S10	CP-1	T100-300	T15
46913	S100-150	S10	165292	S100-230	S10	DB	E9-DB	E27
47101	S100-118	S10	165293	S100-232	S10	DN	E9-DN	E29
47102	S100-140	S10	165294	S100-234	S10	DT	E9-DT	E27
47103	S100-502	S11	165295	S100-236	S10	ECF	E9-ECF	E29
47104	S100-504	S11	165296	S100-238	S10	FP2-E1	H76-2	H9
47105	S100-406	S11	165297	S100-240	S10	FP2-E2	H76-3	H9
47225	S100-500	S11	165298	S100-242	S10	FP2-M2	H76	H9
47411	S100-410	S11	165299	S100-244	S10	FP2-R2	H76-1	H9
47490	S100-128	S10	165300	S100-246	S10	FP3-M1	H75	H9
47491	S100-132	S10	165301	S100-248	S10	FP3-R1	H75-1	H9
47492	S100-122	S10	165302	S100-250	S10	FT-1	T200-80	T18
47493	S100-124	S10	165303	S100-252	S10	Gauge Adaptor	S100-10	S11
47495	S100-144	S10	165304	S100-258	S10	GGW-6812	H6-10	H1
47615	S100-108	S10	165305	S100-260	S10	GGW-7102	H6-15	H1
47738	S100-142	S10	165306	S100-262	S10	GGW-7103	H6-20	H1
47925	S100-400	S11	165307	S100-264	S10			
48302	S100-134	S10	165308	S100-266	S10			
48363	S100-138	S10	165309	S100-268	S10			
48365	S100-148	S10	165377	S100-270	S10			
49488	S100-106	S10	165378	S100-272	S10			
49609	S100-402	S11	165380					
49611	S100-154	S10						

• REFERENCE No. IS THE FORMER WESTWOOD NUMBER (before May 1, 2004) •

Please order by  No.

Reference No. TO  No.

Reference No.	 No.	Page	Reference No.	 No.	Page	Reference No.	 No.	Page
GGW-7105	H6-25	H1	PTA-224C	H25	H7	WTG-EK	E142-1	E33
GV-22	H7	H3	PTA-234C	H25-1	H7	WTG-EM	E142-2	E33
HDT 303K	T100-120	T13	PTA-322C	H25-2	H7	WTG-EO	E142-3	E33
HK-17	T200-58	T18	PTA-322L	H25-3	H7	WTG-K	E143	E33
HWT-A	H25-52	H7	QCK-1 Kit	T32-20	T6	WTG-KM	E143-1	E34
HWT-D	H25-90	H7	RD-95	T100-350	T16	WTG-KWM	E143-2	E34
I-18 GASKET	E9-I-18 GASKET	E27	RD-95-W	T100-352	T16	WTG-O	E143-3	E34
Ignitor Gauge	T100-220	T14	Red. Bushing,	S83-10	S4	WTG-RB	E144	E34
IJW-12	T100-80	T13	5/16 X 7/16			WTG-RK	E144-1	E34
IJW-18	T100-82	T13	RK-97	T200-56	T18	WTG-RM	E144-2	E34
IJW-36	T100-84	T13	#RS-3350	E64-5	E30	WTG-RO	E144-3	E34
JHS	S150	S12	SD Tester	T100-15	T13	WTG-RWM	E144-4	E34
JK-52	H24-15	H5	Service-Saw	S400	S25	WTG-UB2	E145	E34
JW-12	T100-70	T13	Sight Glass,			WTG-UK2	E145-1	E34
JW-18	T100-72	T13	1/8" Thick	S312 Series	S24	WTG-UM	E146	E34
JW-36	T100-74	T13	3/16" Thick	S318 Series	S24	WTG-UM1	E147	E35
LG-300	F75-56	F11	1/4" Thick	S325 Series	S24	WTG-UM1DH	E147-1	E35
Lighter, 12"	T34-40	T7	SK-59	T200-52	T18	WTG-UM1DOH	E147-2	E35
LK-66	T200-50	T18	SS KIT	S70-60	S2	WTG-UM1DOWR	E147-3	E35
LV BOOT	E9-LV BOOT	E29	SW-4	S300-414	S23	WTG-UM1OH	E147-4	E35
LV CLIP	E9-LV CLIP	E29	SW-5	S300-416	S23	WTG-UM1SDH	E147-5	E35
LV Tester	T100-10	T13	SW-6	S300-418	S23	WTG-UO2	E148	E35
ML-3	T32	T6	SW-8	S300-420	S23	WTG-UWM	E149	E35
ML-26	T34-35	T7	SW-9	S300-422	S23	WTG-UWM1DH	E150-1	E35
ML-3-150	T32-10	T6	T-160	T100-125	T13	WTG-UWM1DOH	E150-2	E35
ML-3-150-UPG	T32-11	T6	T-220	T100-130	T13	WTG-UWM1DOWR	E150-3	E35
ML-3-P1000	T32-15	T6	T-571	H25-50	H7	WTG-UWM1OH	E150-4	E35
ML-3-PQ	T32-16	T6	T-571 Brass	H25-51	H7	WTG-UWM1SDH	E150-5	E35
MR-1X2	T34-10	T7	T-572 Brass	H25-53	H7	XK-104	T200-54	T18
MR-2X3	T34-15	T7	T-1050	H25-54	H7			
MR-4	T34-25	T7	TA	S85-130	S5			
NAS-A1	T100-204	T14	TB-60	T100-230	T14			
NAS-ABW	T100-200	T14	TM-30L	E80	E32			
NAS-B1	T100-202	T14	TM-30S	E80-1	E32			
NAS-W1	T100-206	T14	TMK-60	E80-2	E32			
NBK5780	S88-12	S7	Type ET	E9-TYPE ET	E27			
NBK5782	S88-16	S7	Type F	E9-TYPE F	E27			
Nyloshaft 6"	S85-6	S5	Type M	E81	E32			
Nyloshaft 10"	S85-10	S5	Type ST	E9-TYPE ST	E27			
Nyloshaft 12"	S85-12	S5	Type W	E81-10	E32			
Nyloshaft 15"	S85-15	S5	ULTRAGLO	E140-40	E36			
Nyloshaft 30"	S85-30	S5	VB-1049	S20-16	S1			
O Rings	T32-25	T6	VG-4	F80-54	F11			
OBS-38	S305-37	S24	VG-25	F10-55	F11			
OBS-50	S305-50	S24	VG-2002	F92-54	F11			
OBS-75	S305-75	S24	W5780	S88-20	S7			
OBS-100	S305-100	S24	W5781	S88-22	S7			
OBS-125	S305-125	S24	W5782	S88-24	S7			
OBS-153	S305-150	S24	W5783	S88-26	S7			
OL-711	S214-25	S13	W5940	S88-28	S7			
P4FO-IB	F80-36	F9	WP-1	T100-330	T16			
PA-25	F10-48	F9	WMK-100	S88-60	S8			
PB	E9-PB	E27	WRM-798	H24-62	H5			
PD-40	H24-10	H5	WRM-858	H24-60	H5			
PF-20	F90-36	F9	WTG-54VL	E140	E33			
PF-30	F91-36	F9	WTG-54VLW	E140-1	E33			
PP-20	F92-36	F9	WTG-B	E141	E33			
PR-12	S300-424	S23	WTG-DB	E151	E35			
PR-18	S300-426	S23	WTG-DK	E151-1	E35			
PR-24	S300-428	S23	WTG-DK1	E151-2	E35			
PR-36	S300-430	S23	WTG-DO	E151-3	E35			
PR-48	S300-432	S23	WTG-EB	E142	E33			

• REFERENCE No. IS THE FORMER WESTWOOD NUMBER (before May 1, 2004) •

ODOR NEUTRALIZERS

No more: "PU, what's that smell?"



General purpose industrial strength odor neutralizers. Especially effective on fuel oil and other basement odors. Leaves a pleasant, clean, fresh scent that customers will like. Easy to spread granules (CHERRY BLAST) or (MINT BLAST).

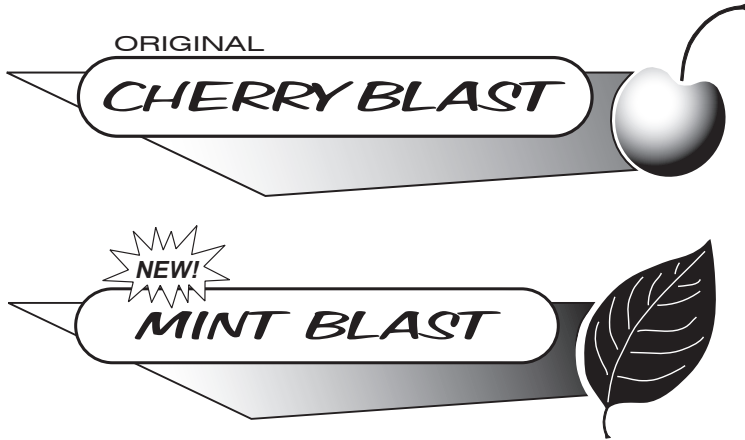

No. **C25**

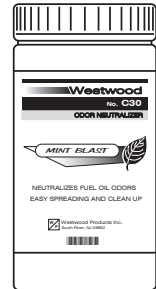

No. **C30**

No.	Description
C25	CHERRY BLAST fuel oil odor neutralizer, 1 quart shaker container
C30	MINT BLAST fuel oil odor neutralizer, 1 quart shaker container

WP-3

HEATING OIL ADDITIVE

Next generation fuel oil additive that stabilizes fuel, dissolves sludge, lowers pour point and disperses water. Helps prevent fuel line and oil filter freeze-ups.

- ▶ Stabilizes fuel and dissolves sludge
- ▶ Inhibits rust and tank corrosion
- ▶ Lowers pour point for better cold weather combustion
- ▶ Disperses water and prevents waxing
- ▶ Melts ice and helps prevent fuel line freeze-ups



No. **C50**

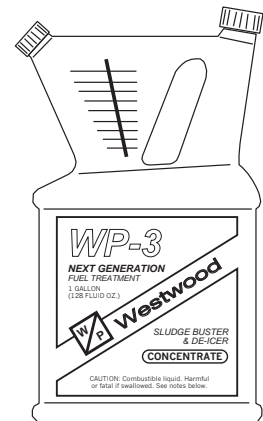

No. **C50-1**

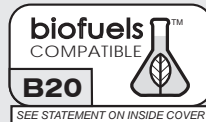

No.	Description
C50	WP-3 premium fuel oil additive, 8 oz. bottle (treats 275 gal. tank)
C50-1	WP-3 premium fuel oil additive, 1 gallon "Tip-N-Pour" bottle
C50-55	WP-3 premium fuel oil additive, 54 gallon drum

Please order by No.

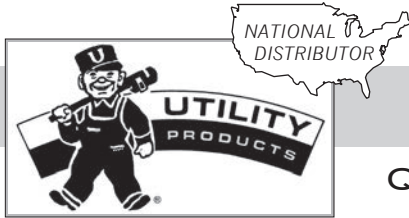

UTILITY PRODUCTS

Quality Chemicals for the Service Professional

SPRAY SOLVENTS



No. C80-10

SOLVIT
 SPRAY SOLVENT
*Non-Flammable
 Non-Drying
 Non-Corrosive
 Non-Conductive
 Dries Instantly*
 12 oz.



No. C80-12

SOLVIT GREEN
 SPRAY SOLVENT
*Environmentally Safer
 Non-Chlorinated
 Non-Brominated
 Non-Corrosive
 Non-Conductive
 Dries Instantly*
 12 oz.



No. C80-14

DE GREASE IT
 FOAMING DEGREASER
*Water Soluble
 Non-Flammable
 Emulsifies Grease
 Wipes off easily*
 12 oz.



No. C80-16

DE GREASE IT PLUS
 FOAMING DEGREASER
*Biodegradable
 Emulsifies Grease
 Wipes off easily*
 12 oz.

SOOT SPRAY



No. C80-20

SOOTAWAY
 SOOT REMOVER
*No Flashback
 Non-Corrosive
 Leaves No Residue
 Harmless to Metal*
 12 oz.

SOOT STICKS



No. C80-24

SOOTAWAY
 SOOT REMOVER STICK
*Non Explosive
 Non-Corrosive
 Leaves No Residue
 Harmless to Metal*
 2.8 oz.

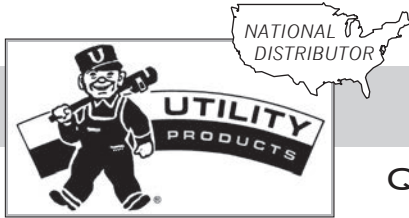

UTILITY PRODUCTS

Quality Chemicals for the Service Professional

WATER ABSORBER

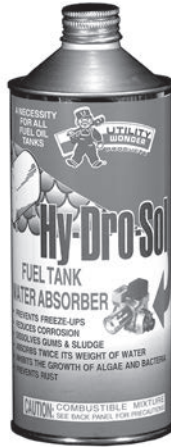

 No. C80-30

HY-DRO-SOL
FUEL TANK
WATER ABSORBER
Absorbs twice its weight of water - Fights Freeze Ups - Inhibits algae and bacteria growth
 32 oz.

ODOR ABSORBENT



 No. C80-50

ODOR KILL
ODOR ABSORBENT
POWDER
Absorbs fuel oil odors from leaks and spills
 14 oz.



 No. C80-56

ODOR KILL
ODOR ABSORBENT
SPRAY
Absorbs fuel oil odors from leaks and spills
 12 oz.

As a National Distributor, the entire Utility Products line is available through Westwood

Westwood electrodes & insulators
 HIGH DIELECTRIC STRENGTH • PRECISION DIMENSIONS



NOTE: Electrode and related items part numbers are now "E5-" followed by the former number.

Example:

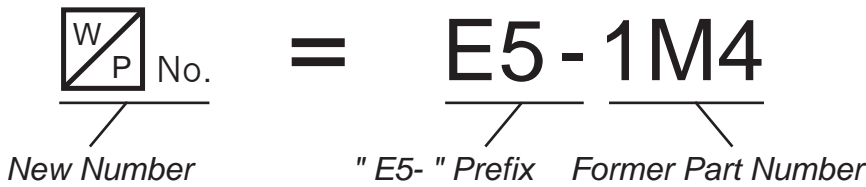

Type 1M

Insulator length	W/P No.
4"	E5-1M4
4-1/4"	E5-1M4-1/4
4-1/2"	E5-1M4-1/2
5"	E5-1M5
6"	E5-1M6
7"	E5-1M7
8"	E5-1M8

Type 2M

Insulator length	W/P No.
4"	E5-2M4
4-1/2"	E5-2M4-1/2
5"	E5-2M5
5-1/2"	E5-2M5-1/2
6"	E5-2M6
7"	E5-2M7
8"	E5-2M8

Type 3M

Insulator length	W/P No.
4"	E5-3M4
4-1/2"	E5-3M4-1/2
5"	E5-3M5
5-1/2"	E5-3M5-1/2
6"	E5-3M6
7"	E5-3M7
8"	E5-3M8

Type 4M

Insulator length	W/P No.
4"	E5-4M4
4-1/4"	E5-4M4-1/4
4-1/2"	E5-4M4-1/2
5"	E5-4M5
6"	E5-4M6
7"	E5-4M7
8"	E5-4M8

Type 5M

Insulator length	W/P No.
4"	E5-5M4
5"	E5-5M5
6"	E5-5M6

Type 2F

Insulator length	W/P No.
4"	E5-2F4
4-1/2"	E5-2F4-1/2
5"	E5-2F5
5-1/2"	E5-2F5-1/2
6"	E5-2F6
7"	E5-2F7
8"	E5-2F8

Type 3F

Insulator length	W/P No.
4"	E5-3F4
4-1/2"	E5-3F4-1/2
5"	E5-3F5
5-1/2"	E5-3F5-1/2
6"	E5-3F6
7"	E5-3F7
8"	E5-3F8

Note: To order the insulator only for any electrode found on this page, add "INS" to the part number.



Westwood electrodes & insulators

HIGH DIELECTRIC STRENGTH • PRECISION DIMENSIONS

<p>"A" Ace 5" E5-100 Ace 6" E5-100B Ace 7" E5-100C</p>	<p>ABC (with bracket) E5-130</p>	<p>ABC E5-147</p> <p>ABC E5-148</p>
<p>Acme E5-102A</p>	<p>ABC (with bracket) E5-130A</p>	<p>ABC E5-148A</p>
<p>Acme E5-102B</p>	<p>Acme E5-107</p>	<p>ABC E5-148B</p>
<p>Aero E5-109</p>	<p>"A" ABC 4" E5-131A ABC 5" E5-132A</p>	<p>ABC E5-148C</p>
<p>Aero E5-110</p>	<p>"A" ABC 4" E5-131 ABC 5" E5-132</p>	<p>ABC ← with 6" spring E5-148K</p>
<p>Aero E5-110B</p>	<p>ABC E5-133</p>	<p>ABC E5-148M</p>
<p>"A" Aero none E5-111A Aero 9-1/2" E5-111D Aero 13-1/2" E5-111E Aero 4-3/4" E5-111F Aero 7-1/2" E5-111G</p>	<p>"A" ABC 1-1/2" E5-137B ABC 4-1/4" E5-137C ABC 7-1/2" E5-137E</p>	<p>ABC Sunray OE-1 E5-148Q</p>
<p>Arco E5-123</p>	<p>A E5-144A A E5-144B A E5-144C A E5-144D A E5-144E A E5-144F A E5-144G A E5-144H</p>	<p>"A" "B" "C" ABC Sunray 7/16" 3-1/4" 3/4" E5-148R ABC Sunray 7/16" 4-1/4" 1/4" E5-148R1 ABC Sunray 15/16" 3-1/4" 3/4" E5-148S</p>
<p>Arco E5-126</p>	<p>Beckett E5-151A</p>	
<p>Arco E5-127</p>	<p>Beckett E5-151B</p>	
<p>Arco E5-127A</p>	<p>Beckett E5-151C</p>	
<p>Armstrong E5-128</p>	<p>Beckett E5-151D</p>	
<p>"A" ABC 4-1/4" E5-146A ABC none E5-146B ABC 4-1/2" E5-146C</p>	<p>Beckett E5-151E</p>	
	<p>spring Beckett E5-151E1</p>	

Westwood electrodes & insulators

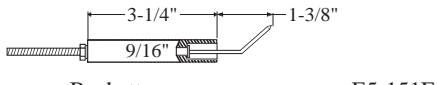
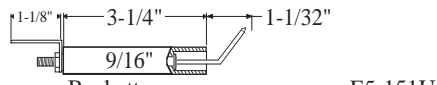
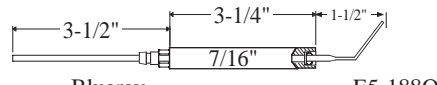
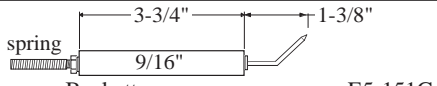
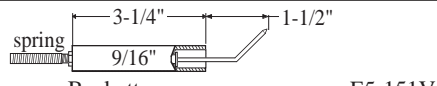
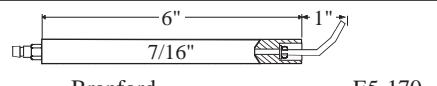
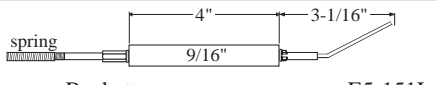
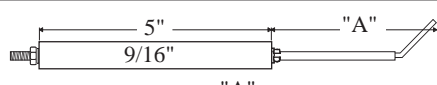
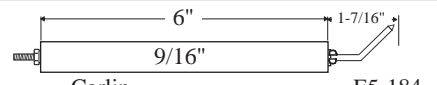
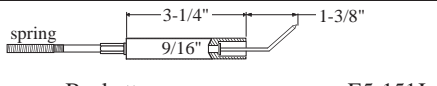
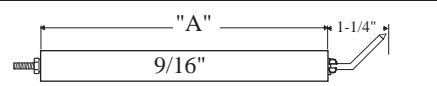
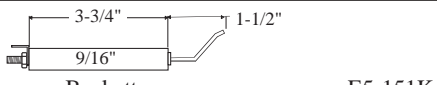
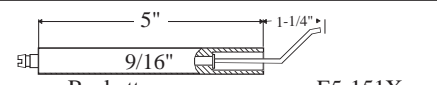
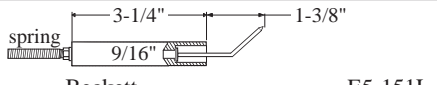
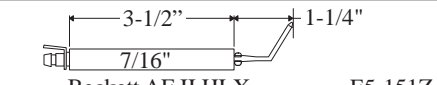
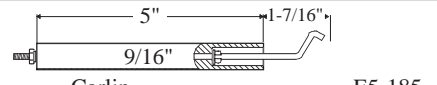
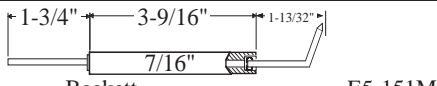
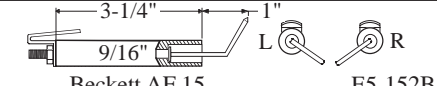
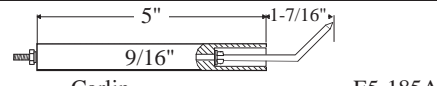
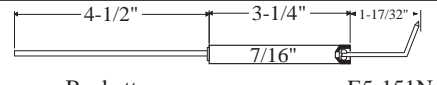
HIGH DIELECTRIC STRENGTH • PRECISION DIMENSIONS

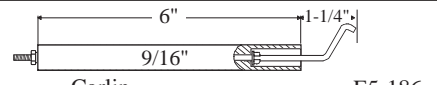
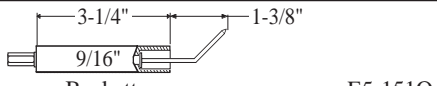
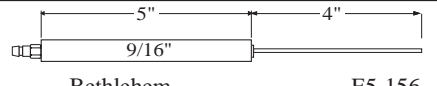
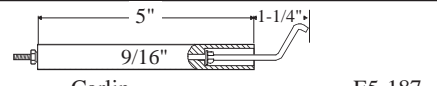
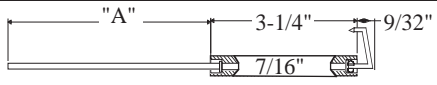
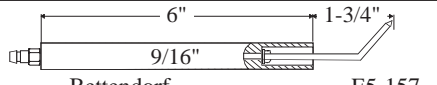
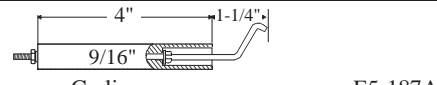
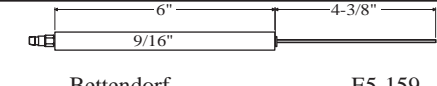
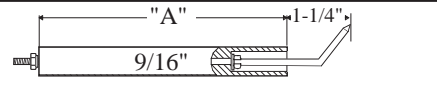
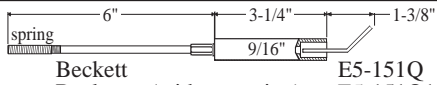
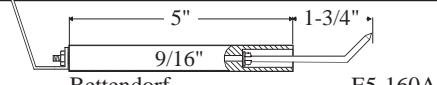
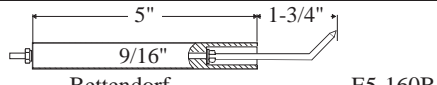
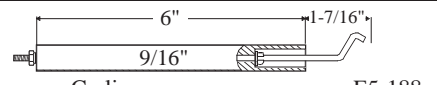
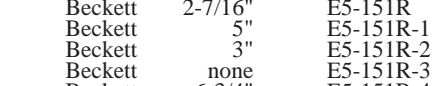
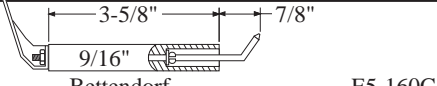
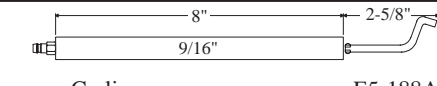
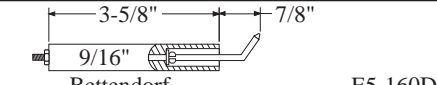
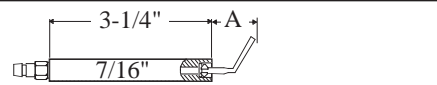
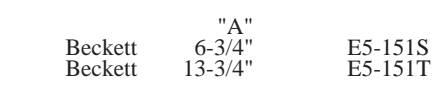
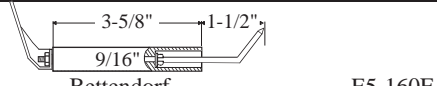
 Beckett E5-151F	 Beckett E5-151U	 Blueray E5-1880
 Beckett E5-151G	 Beckett E5-151V	 Branford E5-170
 Beckett E5-151I	 Beckett E5-151A	 Carlin E5-184
 Beckett E5-151J	Beckett 1-1/4" E5-151 Beckett 3-1/4" E5-152 Beckett 5" E5-152A Beckett 6-1/4" E5-153 Beckett 1-1/2" E5-153A	 Carlin E5-184A-C
 Beckett E5-151K	 Beckett E5-151X	Carlin "A" E5-184A Carlin 4" E5-184B Carlin 5" E5-184C Carlin 6" E5-184C
 Beckett E5-151L	 Beckett AF II HLX E5-151Z	 Carlin E5-185
 Beckett E5-151M	 Beckett AF 15 E5-152B	 Carlin E5-185A
 Beckett E5-151N	 Beckett AF II FBX E5-152C	 Carlin E5-186
 Beckett E5-151O	 Bethlehem E5-156	 Carlin E5-187
 Beckett E5-151P	 Bettendorf E5-157	 Carlin E5-187A
Beckett "A" E5-151P Beckett 5" E5-151P1 Beckett 2" E5-151P2 Beckett 3/4" E5-151P2	 Bettendorf E5-159	 Carlin E5-187B-C
 Beckett E5-151Q	 Bettendorf E5-160A	Carlin "A" E5-187B Carlin 5" E5-187C Carlin 6" E5-187C
Beckett (without spring) E5-151Q1	 Bettendorf E5-160B	 Carlin E5-188
 Beckett E5-151R	 Bettendorf E5-160C	 Carlin E5-188A
Beckett "A" E5-151R Beckett 2-7/16" E5-151R-1 Beckett 5" E5-151R-2 Beckett 3" E5-151R-3 Beckett none E5-151R-3 Beckett 6-3/4" E5-151R-4	 Bettendorf E5-160D	 Carlin E5-188B
 Beckett E5-151S	 Bettendorf E5-160E	Carlin "A" E5-188B Carlin 7/8" E5-188B Carlin 1-9/16" E5-188B2
Beckett 6-3/4" E5-151S Beckett 13-3/4" E5-151T		

Westwood electrodes & insulators

HIGH DIELECTRIC STRENGTH • PRECISION DIMENSIONS

 Carlin E5-188C	 Carlin E5-188O	 Cleanburn E5-199Z1																
 Carlin E5-188D	 Carlin E5-188P	 Cleaver Brooks E5-201																
 Carlin E5-188E	 Carlin E5-188Q	 Cleaver Brooks E5-203																
 Carlin E5-188F	 Carlin E5-188R2	 Cleaver Brooks E5-204A																
 Carlin E5-188G	<table border="0"> <tr> <td></td> <td>"A"</td> <td>"B"</td> <td></td> </tr> <tr> <td>Carlin</td> <td>7/8"</td> <td>12"</td> <td>E5-188R2</td> </tr> <tr> <td>Carlin</td> <td>1-9/16"</td> <td>12"</td> <td>E5-188R3</td> </tr> <tr> <td>Carlin</td> <td>7/8"</td> <td>15"</td> <td>E5-188R4</td> </tr> </table>		"A"	"B"		Carlin	7/8"	12"	E5-188R2	Carlin	1-9/16"	12"	E5-188R3	Carlin	7/8"	15"	E5-188R4	 Cleaver Brooks E5-205
	"A"	"B"																
Carlin	7/8"	12"	E5-188R2															
Carlin	1-9/16"	12"	E5-188R3															
Carlin	7/8"	15"	E5-188R4															
 Carlin E5-188H	 Century E5-189	 Cleaver Brooks E5-205A																
 Carlin E5-188I	 Century E5-191	 Cleaver Brooks E5-205A1																
 Carlin E5-188J	 Century E5-191A	 Cleaver Brooks E5-205A2																
 Carlin E5-188K	 Century E5-191B	 Cleaver Brooks E5-205B																
 Carlin E5-188L	 Chief E5-192	 Cleaver Brooks E5-205D																
 Carlin E5-188M	 Chief E5-192B	 Cleaver Brooks E5-205E																
 Carlin E5-188N	 Clayton E5-198	 Cleaver Brooks E5-205E2																
 Carlin E5-188N1	 Clayton E5-199	 Cleaver Brooks E5-205F																
 Carlin E5-188N2	 Clayton E5-199A	 Cleaver Brooks E5-205G																
 Carlin E5-188N3	 Clayton E5-199D	 Cleaver Brooks E5-205H																
 Carlin E5-188N4	 Cleanburn E5-199Z	 Cleaver Brooks E5-205I																
 Carlin E5-188N5		 Cleaver Brooks E5-205J																
 Carlin E5-188N6		 Cleaver Brooks E5-205K																
 Carlin E5-188N7		 Cleaver Brooks E5-205L																
 Carlin E5-188N8		 Cleaver Brooks E5-205M																
 Carlin E5-188N9		 Cleaver Brooks E5-205N																
 Carlin E5-188N10																		
 Carlin E5-188N11																		

Please order by No.

rev. 03-07-17

E4

Westwood electrodes & insulators

HIGH DIELECTRIC STRENGTH • PRECISION DIMENSIONS

<p>Cleaver Brooks E5-205T</p>	<p>Delco E5-225</p>	<p>Dravo E5-232N</p>
<p>Cleaver Brooks E5-205U</p>	<p>Delco E5-227</p>	<p>Dravo E5-233</p>
<p>Cleaver Brooks E5-205V</p>	<p>Delco E5-228</p>	<p>Ducane E5-234A Ducane E5-234B Ducane E5-234C Ducane E5-234D</p>
<p>Cleaver Brooks E5-205X</p>	<p>Dravo E5-232</p>	<p>Ducane E5-234E Ducane E5-234F Ducane E5-234G Ducane E5-234H Ducane E5-234I Ducane E5-234J</p>
<p>Cleaver Brooks E5-205Y</p>	<p>Dravo E5-232A</p>	<p>Ducane E5-234K Ducane E5-234L Ducane E5-234M</p>
<p>Cleaver Brooks E5-205Z</p>	<p>Dravo E5-232B</p>	<p>Ducane E5-234N</p>
<p>Cleaver Brooks E5-205Z2</p>	<p>Dravo E5-232C</p>	<p>Ducane OilMaster™ E5-234L Ducane OilMaster™ E5-234M</p>
<p>Cleaver Brooks E5-205Z3</p>	<p>Dravo E5-232D</p>	<p>Eclipse E5-235 Eclipse E5-235A Eclipse E5-235B</p>
<p>Coleman E5-202A</p>	<p>Dravo E5-232E</p>	<p>Eclipse E5-236</p>
<p>Coleman E5-202B</p>	<p>Dravo E5-232F</p>	<p>Eclipse E5-238</p>
<p>Columbia Boiler E5-206</p>	<p>Dravo E5-232G</p>	<p>Eclipse E5-238B</p>
<p>Columbia Boiler E5-207A</p>	<p>Dravo E5-232H</p>	<p>Economite E5-239</p>
<p>Crane E5-213 Crane E5-214</p>	<p>Dravo E5-232I</p>	<p>Economite E5-239A</p>
<p>Delco E5-221</p>	<p>Dravo E5-232J</p>	<p>Economite E5-239B</p>
<p>Delco E5-224</p>	<p>Dravo E5-232L</p>	<p>Economite E5-239M</p>
<p>Delco E5-224</p>	<p>Dravo E5-232M</p>	<p>Economite E5-239B</p>

Westwood electrodes & insulators

HIGH DIELECTRIC STRENGTH • PRECISION DIMENSIONS

<p>Economite E5-239C</p>	<p>Fulton Boiler 12-1/4" E5-282A Fulton Boiler 17-1/4" E5-282B</p>	<p>Gordon Piatt 5" E5-307B Gordon Piatt 7" E5-307C Gordon Piatt 9" E5-307D</p>
<p>Economite E5-239D</p>	<p>Fulton Boiler 5-1/2" E5-282C Fulton Boiler 8-3/4" E5-282C</p>	<p>Gordon Piatt 4" E5-307F Gordon Piatt 5" E5-307P Gordon Piatt 6" E5-307G Gordon Piatt 8" E5-307H</p>
<p>Economite E5-239E</p>	<p>Fulton Boiler 9" E5-283A Fulton Boiler 9/16" E5-283A</p>	<p>Gordon Piatt 7-3/4" E5-307I Gordon Piatt 13-1/2" E5-307J</p>
<p>Economite E5-239F</p>	<p>Fulton Boiler 8-1/4" E5-283B Fulton Boiler 9/16" E5-283B</p>	<p>Gordon Piatt 2-3/4" E5-307K Gordon Piatt 7" E5-307O</p>
<p>Edison E5-246</p>	<p>Fulton Boiler 2-3/4" E5-284 Fulton Boiler 9/16" E5-284</p>	<p>Gordon Piatt 2-3/4" E5-307K Gordon Piatt 9/16" E5-307K</p>
<p>Edison E5-247</p>	<p>Fulton Boiler 2-3/4" E5-285 Fulton Boiler 9/16" E5-285</p>	<p>Gordon Piatt 2" E5-307O Gordon Piatt 9/16" E5-307O</p>
<p>Electromagic E5-249A</p>	<p>General Automatic E5-290 General Automatic 9/16" E5-290</p>	<p>Gordon Piatt 4-5/8" E5-307Q Gordon Piatt 4" E5-307Q Gordon Piatt 6" E5-307R Gordon Piatt 8" E5-307S</p>
<p>Enterprise 5" E5-253B Enterprise 1-3/4" E5-253C Enterprise 2-1/2" E5-253D</p>	<p>General Electric E5-291 General Electric 7/16" E5-291</p>	<p>Gordon Piatt 1-1/4" E5-307U Gordon Piatt 7/16" E5-307U</p>
<p>Esso E5-258 Esso 7/16" E5-258</p>	<p>General Electric E5-296 General Electric 1/2" E5-296</p>	<p>Gordon Piatt 1-1/2" E5-307V Gordon Piatt 7/16" E5-307V</p>
<p>Esso E5-261 Esso 9/16" E5-261</p>	<p>General Electric E5-298 General Electric 7/16" E5-298</p>	<p>General Electric E5-299A General Electric 1-7/8" E5-299A</p>
<p>Flame Guard 3-9/16" E5-267A Flame Guard 6" E5-267B Flame Guard 11-7/16" E5-267C Flame Guard 5" E5-267E Flame Guard 4" E5-267F Flame Guard 8" E5-267G</p>	<p>General Electric E5-301A General Electric 1-1/4" E5-301A</p>	<p>Gordon Piatt 7" E5-307N Gordon Piatt 5" E5-307T</p>
<p>Flame Guard E5-267D Flame Guard 7/16" E5-267D</p>	<p>General Electric E5-301B General Electric 1-1/4" E5-301B</p>	<p>Gordon Piatt 1-9/32" E5-307W Gordon Piatt 7/16" E5-307W</p>
<p>Fulton Boiler 12-1/4" E5-282 Fulton Boiler 17-1/4" E5-283</p>	<p>Gold Star 4" E5-306 Gold Star 5" E5-307</p>	<p>Gould 5" E5-308 Gould 6" E5-309 Gould 7" E5-310 Gould 8" E5-311</p>



Westwood electrodes & insulators

HIGH DIELECTRIC STRENGTH • PRECISION DIMENSIONS

<p>Heil Heil "A" 2-1/4" 4" E5-330A E5-330B</p>	<p>International E5-348A</p>	<p>Iron Fireman E5-365D</p>
<p>Heil E5-331B</p>	<p>Iron Fireman E5-357</p>	<p>Iron Fireman E5-366D</p>
<p>Homelite E5-337A</p>	<p>Iron Fireman E5-357C</p>	<p>Johnson "A" 1-1/2" 2" 7-1/2" 6" E5-371 E5-371A E5-372 E5-374</p>
<p>Homestead E5-338</p>	<p>Iron Fireman E5-357D</p>	<p>Johnson E5-373</p>
<p>Homestead E5-340</p>	<p>Iron Fireman E5-357E</p>	<p>Johnson E5-373A</p>
<p>Homestead E5-341</p>	<p>Iron Fireman E5-357I</p>	<p>Johnson E5-375</p>
<p>Homestead E5-341A</p>	<p>Iron Fireman E5-357J</p>	<p>Johnson E5-375A</p>
<p>Industrial Combustion E5-342</p>	<p>Iron Fireman E5-357L</p>	<p>Johnson E5-377</p>
<p>Industrial Combustion E5-343</p>	<p>Iron Fireman E5-357M</p>	<p>Johnson Gas E5-377A</p>
<p>Industrial Combustion E5-343A</p>	<p>Iron Fireman E5-357O</p>	<p>Kewanee E5-378</p>
<p>Industrial Combustion E5-344</p>	<p>Iron Fireman E5-357R</p>	<p>Kewanee E5-378A</p>
<p>Industrial Combustion E5-344A</p>	<p>Iron Fireman E5-357S</p>	<p>Kewanee E5-378B</p>
<p>Industrial Combustion E5-345</p>	<p>Iron Fireman E5-357W</p>	<p>Kewanee E5-378C</p>
<p>Industrial Combustion E5-345A</p>	<p>Iron Fireman E5-357Y</p>	<p>Lenan E5-379I</p>
<p>International E5-348</p>	<p>Iron Fireman E5-364</p>	<p>La Salle E5-381</p>

Westwood electrodes & insulators

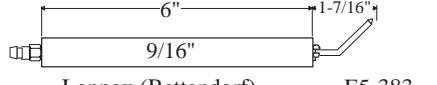
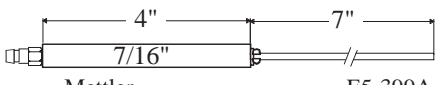
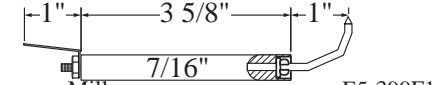
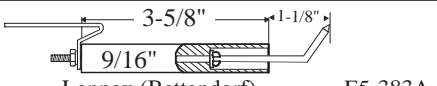
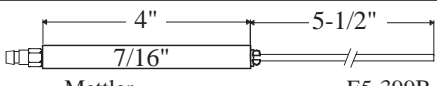
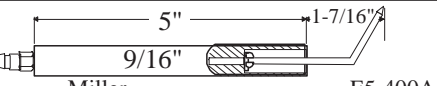
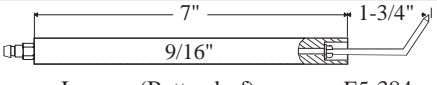
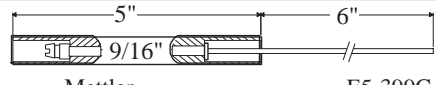
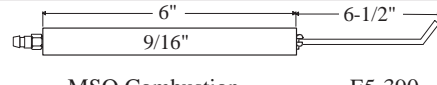
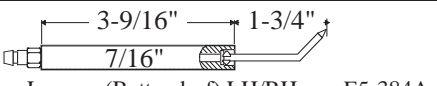
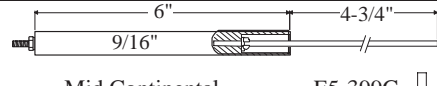
HIGH DIELECTRIC STRENGTH • PRECISION DIMENSIONS

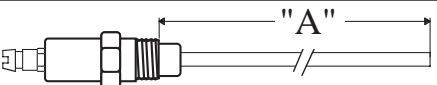
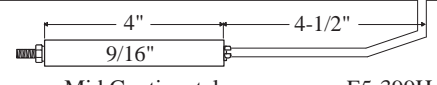
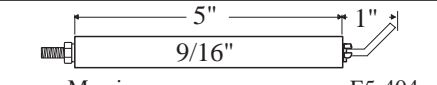
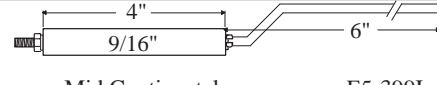
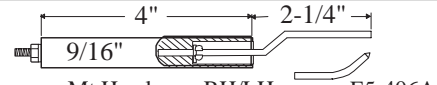
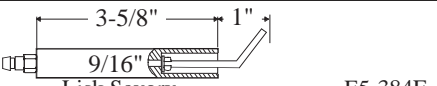
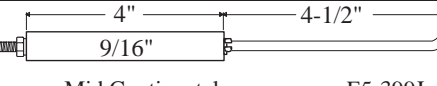
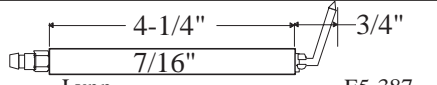
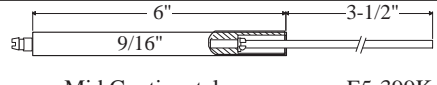
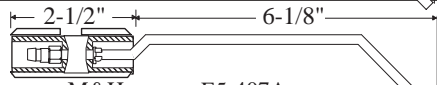
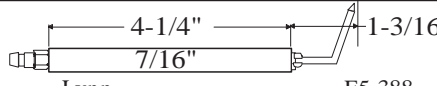
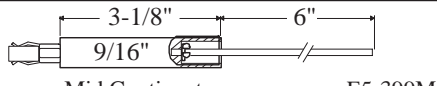
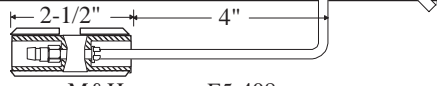
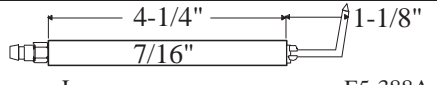
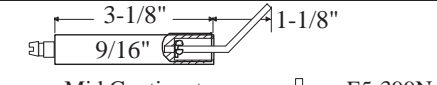
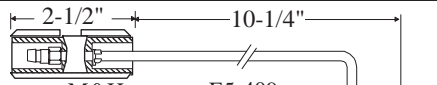
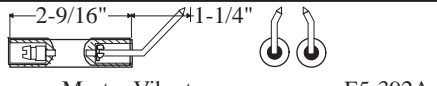
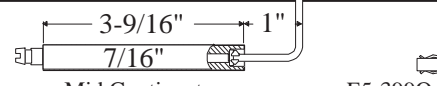
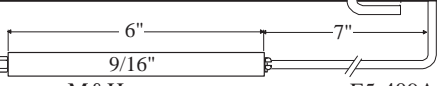
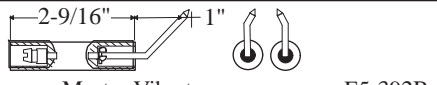
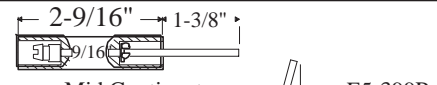
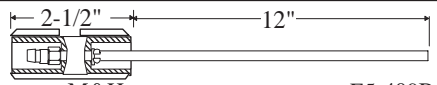
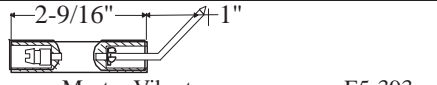
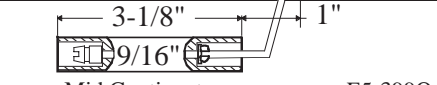
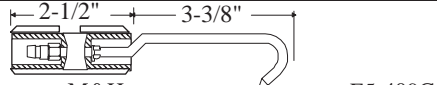
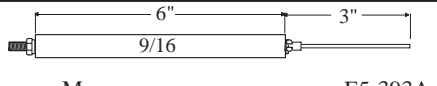
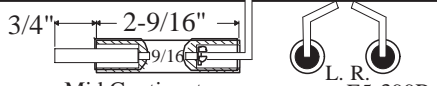
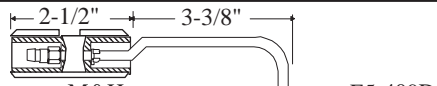
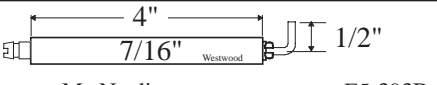
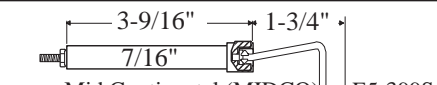
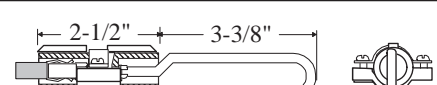
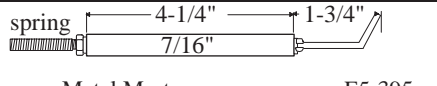
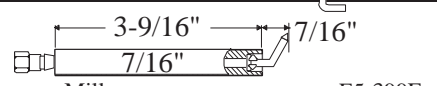
 Lennox (Bettendorf) E5-383	 Mettler E5-399A	 Miller E5-399F1
 Lennox (Bettendorf) E5-383A	 Mettler E5-399B	 Miller E5-400A
 Lennox (Bettendorf) E5-384	 Mettler E5-399C	 MSO Combustion E5-390
 Lennox (Bettendorf) LH/RH E5-384A	 Mid Continental E5-399G	 MSO Combustion E5-391
 "A" Lennox 2" E5-384C Lennox 4" E5-384D Lennox 6" E5-384E	 Mid Continental E5-399H	 Morrison E5-404
	 Mid Continental E5-399I	 Mt Hawley RH/LH E5-406A
	 Lisk Savory E5-384F	 Mid Continental E5-399J
 Lynn E5-387	 Mid Continental E5-399K	 M&H E5-407A
 Lynn E5-388	 Mid Continent E5-399M	 M&H E5-408
 Lynn E5-388A	 Mid Continent E5-399N	 M&H E5-409
 Master Vibrator E5-392A	 Mid Continent E5-399O	 M&H E5-409A
 Master Vibrator E5-392B	 Mid Continent E5-399P	 M&H E5-409B
 Master Vibrator E5-393	 Mid Continent E5-399Q	 M&H E5-409C
 Messer E5-393A	 Mid Continent E5-399R	 M&H E5-409D
 Mc Naulin E5-393D	 Mid Continental (MIDCO) E5-399S	 M&H (with Bracket) E5-409C-2
 Metal Master E5-395	 Miller E5-399F	

Westwood electrodes & insulators

HIGH DIELECTRIC STRENGTH • PRECISION DIMENSIONS

M&H E5-409E	Nu-Way E5-420A	Peabody E5-457
M&H E5-409F	Nu-Way E5-420A1	Peabody E5-458
M&H E5-409G	Nu-Way E5-420B	Petro E5-465
M&H E5-409H	Nu-Way E5-420C	Petro E5-467
		Petro 1-1/2" E5-467 Petro 2" E5-467A Petro 18" E5-467B Petro 6" E5-467G
M&H E5-409J	Nu-Way E5-421	
M&H E5-409K	Nu-Way E5-425	Petro E5-468A
National Airoil E5-412	Nu-Way E5-429	Petro E5-468B
		Petro 1-1/2" E5-468B Petro 2" E5-468C Petro 18" E5-468D
National Airoil E5-415	Nu-Way E5-429H	
National Radiator E5-416	Nu-Way E5-429A	Power Flame E5-475-1
	Nu-Way E5-429B 1/2" E5-429D 2" E5-429B 1" E5-429F 2-1/2" E5-429C 1-1/2" E5-429G 3-1/2"	
Northeast E5-417		Power Flame E5-475A
Nu-Way E5-418	Nu-Way E5-430	Power Flame (Kanthal tip) E5-475B
Nu-Way E5-418A	Nu-Way E5-430A	Power Flame E5-477
Nu-Way E5-418B	Orr & Sembower E5-443	Power Flame E5-477A
		Power Flame 5.81" .50" E5-477A Power Flame 6.44" .38" E5-477B Power Flame 6.88" .47" E5-477C
Nu-Way E5-418F	Orr & Sembower E5-449	
Nu-Way E5-419	Orr & Sembower E5-451	Power Flame E5-477A-1
		Power Flame 5.81" 6.30" E5-477A-1 Power Flame 6.44" 6.69" E5-477B-1 Power Flame 6.88" 8.66" E5-477C-1
Nu-Way E5-420	Orr & Sembower E5-453	

Westwood electrodes & insulators

HIGH DIELECTRIC STRENGTH • PRECISION DIMENSIONS

<p>Power Flame E5-477D</p>	<p>Power Flame E5-479B</p>	<p>Ray E5-500</p>
<p>Power Flame E5-477E</p>	<p>Power Flame E5-479C</p>	<p>Ray E5-502</p>
<p>Power Flame E5-477F</p>	<p>Power Flame E5-479D</p>	<p>Ray E5-503A</p>
<p>Power Flame (Stainless tip) E5-477G</p>	<p>Power Flame E5-479E</p>	<p>Ray E5-503D</p>
<p>Power Flame E5-477H</p>	<p>Power Flame E5-479E1</p>	<p>Ray E5-503E</p>
<p>Power Flame E5-477I</p>	<p>Preferred Utilities E5-471A</p>	<p>Ray E5-503G</p>
<p>Power Flame E5-477J</p>	<p>PVI E5-473F</p>	<p>Ray E5-503H</p>
<p>Power Flame E5-477K</p>	<p>PVI E5-473G</p>	<p>Ray E5-503J</p>
<p>Power Flame E5-478</p>	<p>Pyronics E5-474C-1 6" E5-474C-2 12"</p>	<p>Ray E5-503M</p>
<p>Power Flame E5-478A</p>	<p>Pyronics E5-474E</p>	<p>Ray E5-503P</p>
<p>Power Flame E5-478B</p>		<p>Robert Gordon E5-506B</p>
<p>Power Flame E5-478C</p>	<p>Quiet Heat 4-1/4" E5-483 Quiet Heat 5" E5-483-5 Quiet Heat 6" E5-483-6</p>	<p>Robert Gordon E5-506C</p>
<p>Power Flame E5-478D</p>	<p>Radiant E5-490</p>	<p>Light Tip</p> <p>Shellhead 4" E5-513-4 Shellhead 5" E5-513-5 Shellhead 6" E5-513-6 Shellhead 7" E5-513-7 Shellhead 8" E5-513-8 Shellhead 9" E5-513-9 Shellhead 10" E5-513-10 Shellhead 11" E5-513-11 Shellhead 12" E5-513-12 Shellhead 13" E5-513-13 Shellhead 14" E5-513-14</p>
<p>Power Flame E5-478E</p>	<p>Rails E5-489B</p>	
<p>Power Flame E5-479</p>	<p>Rails E5-489C</p>	
<p>Power Flame E5-479A</p>	<p>Ray E5-499 3-3/4" E5-499C 5"</p>	





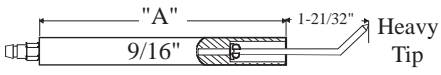
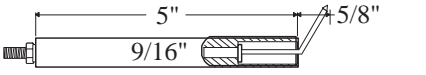
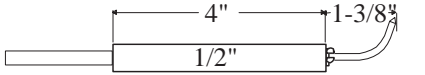
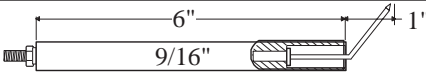
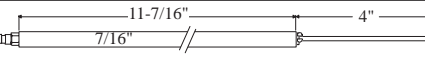
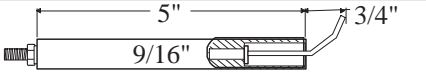
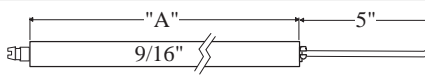
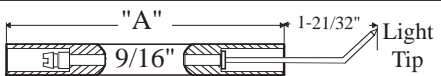
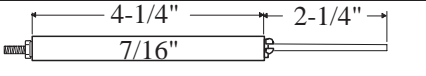
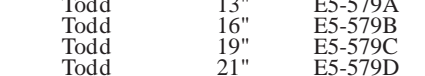
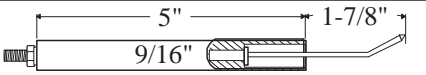
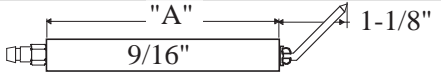
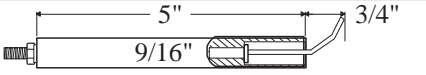
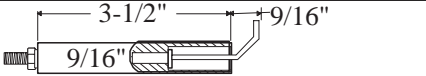
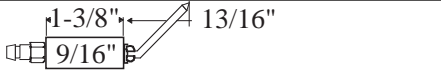
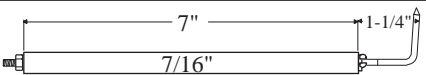
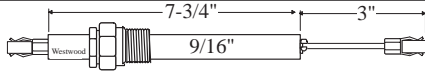
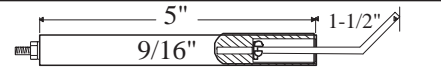
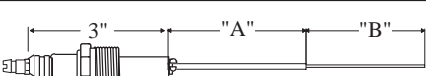
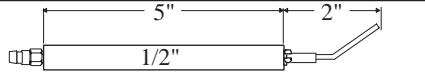
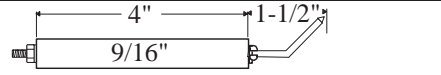
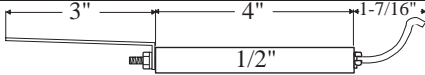
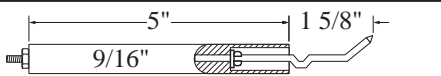
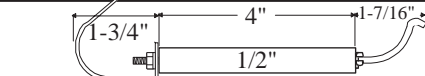
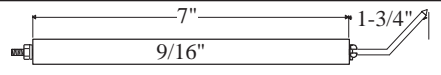
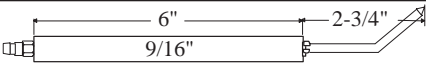
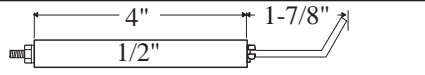
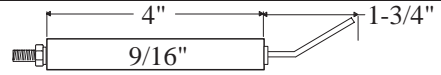
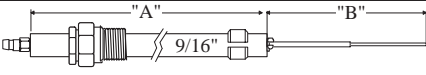
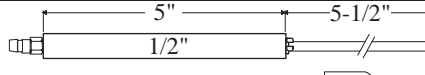
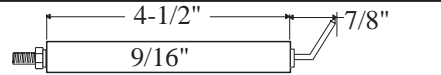
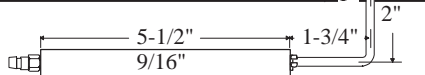
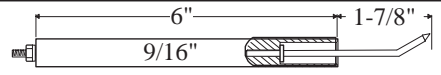
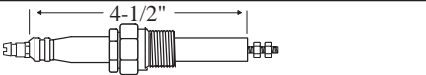
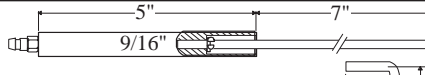
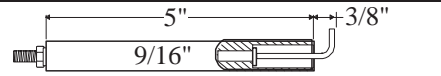
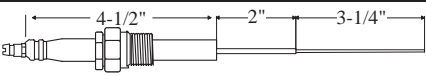
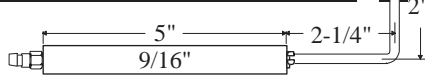

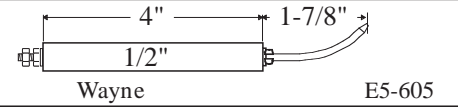
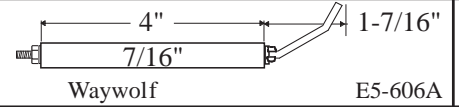
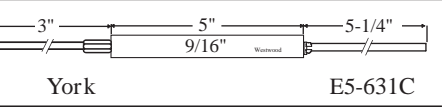
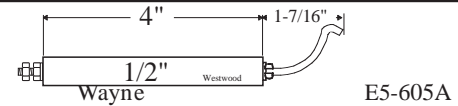
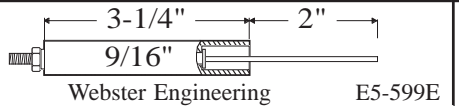
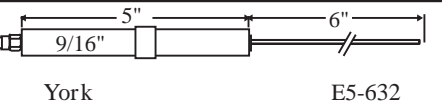
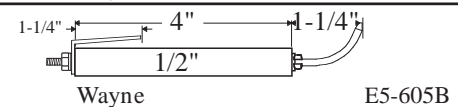
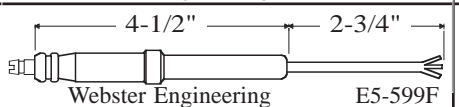
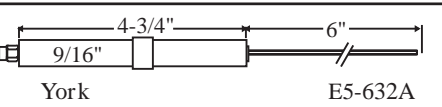
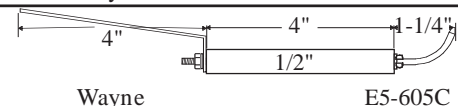
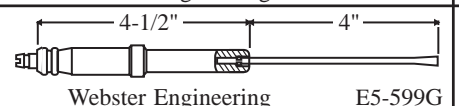
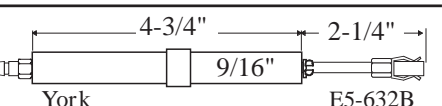
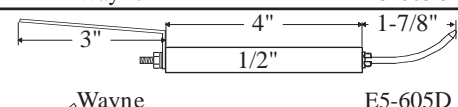
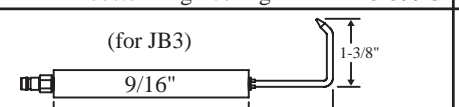
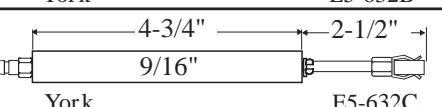
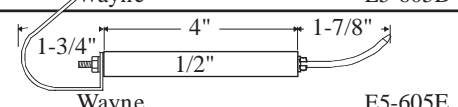
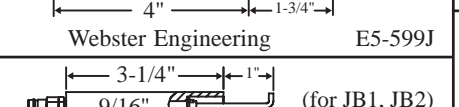
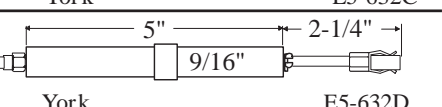
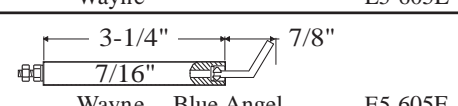
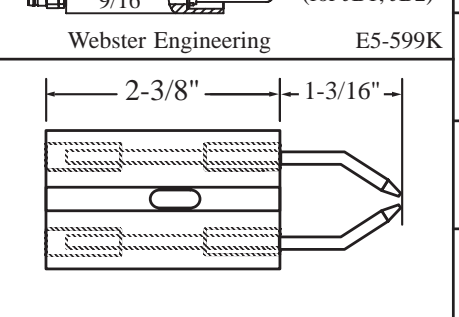
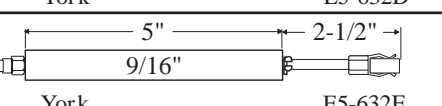
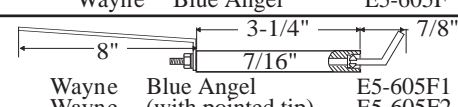
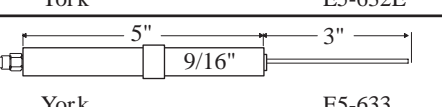
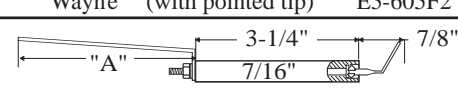
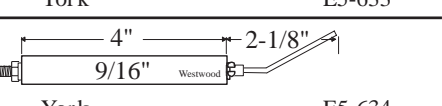
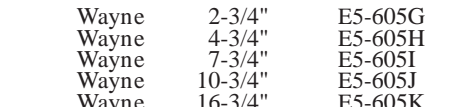
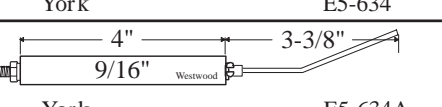
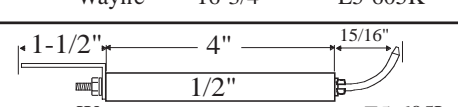
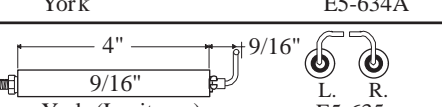
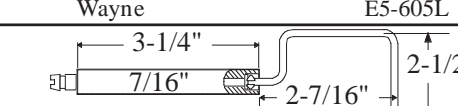
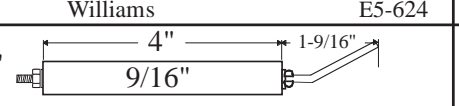
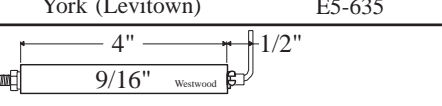
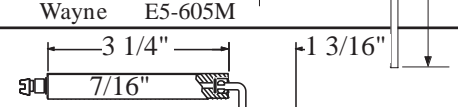
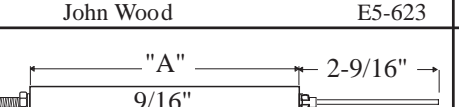
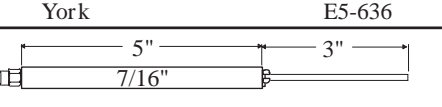

Westwood electrodes & insulators

HIGH DIELECTRIC STRENGTH • PRECISION DIMENSIONS

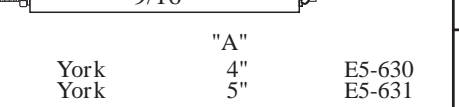
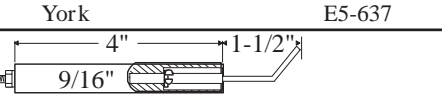
 <p>Shellhead 4" E5-514-4 Shellhead 5" E5-514-5 Shellhead 6" E5-514-6 Shellhead 7" E5-514-7 Shellhead 8" E5-514-8 Shellhead 9" E5-514-9 Shellhead 10" E5-514-10 Shellhead 11" E5-514-11 Shellhead 12" E5-514-12 Shellhead 13" E5-514-13 Shellhead 14" E5-514-14</p>	 <p>Sun Ray E5-559E</p>	 <p>Thatcher E5-560</p>
	 <p>Sun Ray E5-559F</p>	 <p>Todd E5-577A</p>
	 <p>Sun Ray E5-559H</p>	 <p>Todd 13" E5-579A Todd 16" E5-579B Todd 19" E5-579C Todd 21" E5-579D Todd 22" E5-579E</p>
 <p>Shellhead 5" E5-515-5 Shellhead 6" E5-515-6 Shellhead 7" E5-515-7 Shellhead 8" E5-515-8</p>	 <p>Sun Ray E5-559J</p>	 <p>Todd 8-3/4" E5-578 Todd 10-1/4" E5-578A Todd 12" E5-579 Todd 14" E5-580 Todd 17" E5-581 Todd 19" E5-582 Todd 21" E5-582A Todd 23" E5-582B Todd 24" E5-582C</p>
	 <p>Sun Ray E5-559K</p>	
 <p>Silent Glow 3" E5-523 Silent Glow 4" E5-524 Silent Glow 5" E5-525 Silent Glow 6" E5-526 Silent Glow 11-3/4" E5-527</p>	 <p>Sun Ray E5-559L</p>	
	 <p>Sun Ray E5-559M</p>	
 <p>Silent Glow E5-523A</p>	 <p>Sun Ray E5-559N</p>	 <p>Tornado Todd E5-588B</p>
 <p>Stewart Warner E5-545</p>	 <p>Superior 3-1/2" 4-1/2" E5-546 Superior 4-1/2" 6" E5-546A Superior 10-1/4" 5" E5-546B Superior 3" 3" E5-546C Superior 3" 2-1/4" E5-546D Superior 8-1/2" 3" E5-546E Superior 3-1/2" 8" E5-546F Superior 12-1/2" 4" E5-546G</p>	 <p>Volcano E5-590</p>
 <p>Sun Ray E5-550</p>		 <p>Wayne E5-601A</p>
 <p>Sun Ray E5-553</p>		 <p>Wayne E5-601B</p>
 <p>Sun Ray E5-557</p>	 <p>Superior E5-547</p>	 <p>Wayne E5-604</p>
 <p>Sun Ray E5-558</p>	 <p>Superior 14-3/4" 5" E5-547A Superior 18-1/2" 3-3/4" E5-547B Superior 16-1/2" 3-1/4" E5-547C Superior 13-1/2" 3" E5-547E</p>	 <p>Wayne E5-604A</p>
 <p>Sun Ray E5-559</p>		 <p>Wayne E5-604B</p>
 <p>Sun Ray E5-559B</p>	 <p>Superior Bulkhead E5-547D</p>	 <p>Wayne E5-604C</p>
 <p>Sun Ray E5-559D</p>	 <p>Superior E5-547F</p>	 <p>Wayne E5-604D</p>

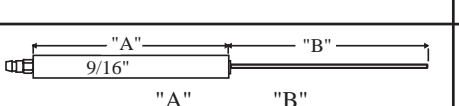
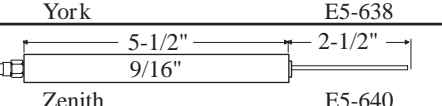
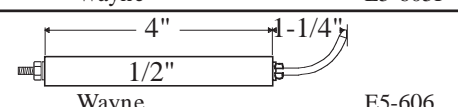
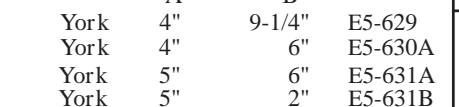
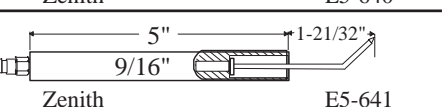
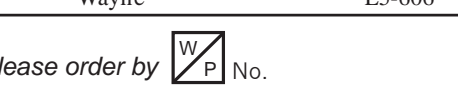
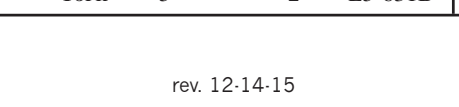
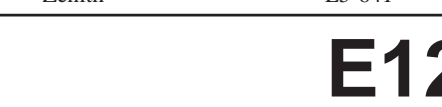
Westwood electrodes & insulators

HIGH DIELECTRIC STRENGTH • PRECISION DIMENSIONS

 Wayne E5-605	 Waywolf E5-606A	 York E5-631C
 Wayne E5-605A	 Webster Engineering E5-599E	 York E5-632
 Wayne E5-605B	 Webster Engineering E5-599F	 York E5-632A
 Wayne E5-605C	 Webster Engineering E5-599G	 York E5-632B
 Wayne E5-605D	 (for JB3) Webster Engineering E5-599J	 York E5-632C
 Wayne E5-605E	 (for JB1, JB2) Webster Engineering E5-599K	 York E5-632D
 Wayne Blue Angel E5-605F	 Weil-McLain, electrode only E5-598 Weil-McLain electrode w/leads E5-598A Leads only (former WMK-150) E5-598B	 York E5-632E
 Wayne Blue Angel E5-605F1		 York E5-633
 Wayne Blue Angel (with pointed tip) E5-605F2		 York E5-634
 Wayne E5-605G		 York E5-634A
 Wayne E5-605H		 York E5-635
 Wayne E5-605I	 Williams E5-624	 York (Levittown) E5-635
 Wayne E5-605J	 John Wood E5-623	 York E5-636
 Wayne E5-605K	 York E5-630 York E5-631	 York E5-637
 Wayne E5-605L	 York E5-638 York E5-639	 York E5-638
 Wayne E5-605M	 York E5-630 York E5-631	 York E5-639
 Wayne E5-605N	 York E5-630 York E5-631	 York E5-637
 Wayne E5-605P	 York E5-629 York E5-630A York E5-631A York E5-631B	 York E5-638
 Wayne E5-606	 Zenith E5-640	 Zenith E5-641

Westwood

ELECTRODE KITS

FOR THE SERVICE PROFESSIONAL

**ELECTRODE & INSULATOR KITS****Serviceman's Deluxe Kit****OEM Electrodes - 2 ea.**

ABC: E5-146

Beckett: E5-151E, E5-1510

Carlin: E5-188B, E5-188N, E5-188K

Quiet Heat: E5-483

Wayne: E5-604, E5-605, E5-605B,
E5-605F, E5-606**Rajah™ Terminals - 10 ea.**

E9-CT, E9-SS, E9-R-2, E9-RAC, E9-SF,

E9-BS 6-32, E9-BS 10-32,

E9-HS 6-32 (5 ea.), E9-HS 10-32 (5 ea.),
6-32 nut, 10-32 nut**Standard Electrodes - 2 ea.**E5-1M4, E5-2M4, E5-2M5, E5-2M6,
E5-4M4, E5-3M4, E5-3M5, E5-3M6**Also includes**

5 feet of GTO-15 ignition cable

1 set (2) T100-230 electrode benders

1 - T100-220 electrode gauge

1 set (2) T100-70 jumpers

1 - NAS gauge™ nozzle gauge

1 - Coupler Popper™ tool

1 - Plastic carrying case

 No. E5-2001
Serviceman's Super Kits

Same contents as the E5-2001 Deluxe Kit, less the NAS gauge™ and Coupler Popper™
in a plastic carrying case

 No. E5-1897

Same contents as the E5-2001 Deluxe Kit, less the NAS gauge™ and Coupler Popper™
in a cardboard box

 No. E5-1897-C
ELECTRODE & INSULATOR ROLL-UP KITS**Contains:****Electrodes - 2 ea.**

E5-3M4 (9/16"x4"), E5-3M5 (9/16"x5"),

E5-3M6 (9/16"x6"), E5-3F5 (9/16"x5"),

E5-483 (Quiet Heat)

Insulators - 2 ea.

E5-1M4-1/4 (7/16"x4-1/4"), E5-4M4 (1/2"x4"),

E5-2M4 (9/16"x4"), E5-2M5 (9/16"x5"),

E5-3M4 (9/16"x4")

 No. E5-595
Contains:**Electrodes - 2 ea.**

E5-188N (Carlin), E5-151E (Beckett),

E5-605 (Wayne), E5-2M4 (9/16"x4"),

E5-2M5 (9/16"x5"), E5-2M6 (9/16"x6"),

E5-2F5 (female 5"), E5-2F6 (female 6")

Insulators - 2 ea.

E5-1M4-1/4 (7/16"x4-1/4"), E5-3M4 (9/16"x4"),

E5-2M4 (9/16"x4"), E5-2M5 (9/16"x5"),

E5-2M6 (9/16"x6"), E5-2F5 (female 5"),

E5-2F6 (female 6"), E5-4M4 (1/2"x4")

 No. E5-920

Westwood

ELECTRODE KITS

FOR THE SERVICE PROFESSIONAL

**ELECTRODE & INSULATOR ROLL-UP KITS (Continued)**

For Servicing
Beckett Burners

Contains these electrodes:

4 · E5-151E	2 · E5-151D
2 · E5-151E1	2 · E5-151R
2 · E5-151O	2 · E5-151G
2 · E5-151F	2 · E5-151J
2 · E5-151	



 No. E5-BK-400

For Servicing
Carlin Burners

Contains these electrodes:

4 · E5-188N	2 · E5-188P
4 · E5-188B	2 · E5-188Q
2 · E5-188K	2 · E5-188R3
2 · E5-188R-2	2 · E5-188N4
2 · E5-188H	



 No. E5-CK-300

For Servicing
Wayne Burners

Contains these electrodes:

4 · E5-605	2 · E5-605E
4 · E5-606	2 · E5-605C
2 · E5-605B	2 · E5-605D
2 · E5-605F	2 · E5-605F1
2 · E5-604	



 No. E5-WK-500

 Take a look . . .

PORCELAIN CUTTER No. T100-370 on page T17
&
RAJAH TERMINAL KITS on page E28

Please order by  No.

rev. 6-13-18

E14

Westwood
AUBURN IGNITION PRODUCTS
 IGNITORS • FLAME RODS • LIQUID LEVEL ELECTRODES



NOTE: Auburn ignition products part numbers are now "E5-" followed by the former number.

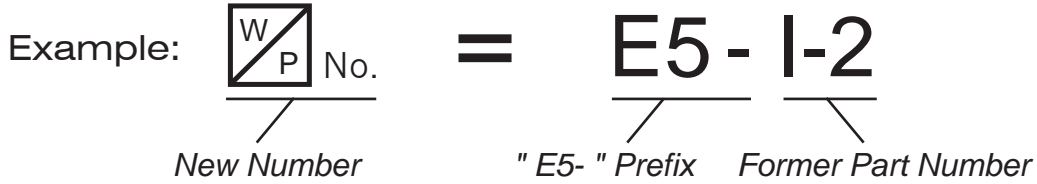

149T-1 (.090)

No.	Ref. No.
E5-149T-1-090	149T-1-090

I-2-EI-2

No.	Ref. No.
E5-I-2-EI-2	I-2-EI-2

F-68

No.	Ref. No.
E5-F-68	F-68

I-2 Series

No.	Ref. No.	"A" DIM.	"B" DIM.
E5-I-2	I-2	8.00	4.50
E5-I-2-1	I-2-1	15.50	12.00
E5-I-2-2	I-2-2	27.50	24.00

F-140

No.	Ref. No.
E5-F-140	

New!

* Dimensions marked with an asterisk are standard lengths - Other lengths available upon request

AUBURN ELECTRODES

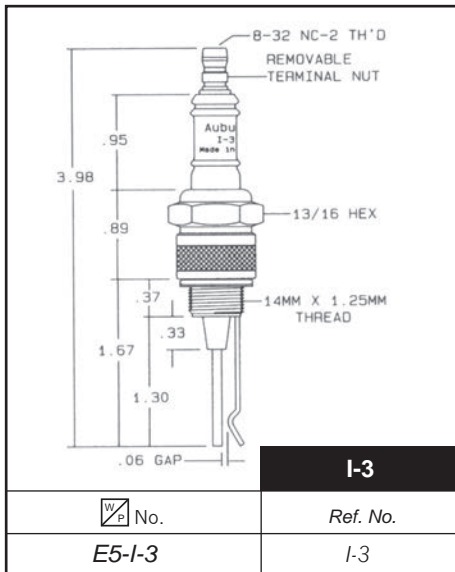

No.	Ref. No.
E5-I-3	I-3

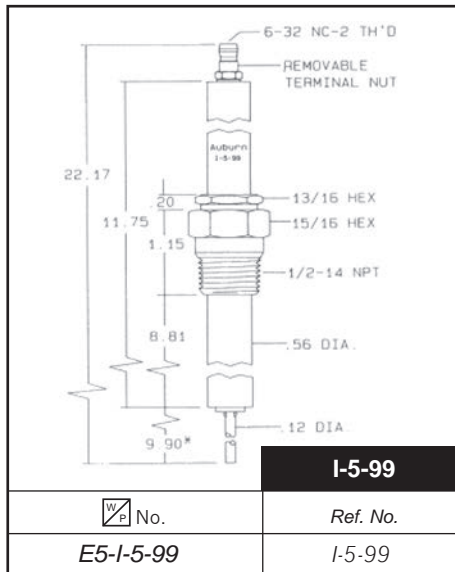

No.	Ref. No.
E5-I-5-99	I-5-99

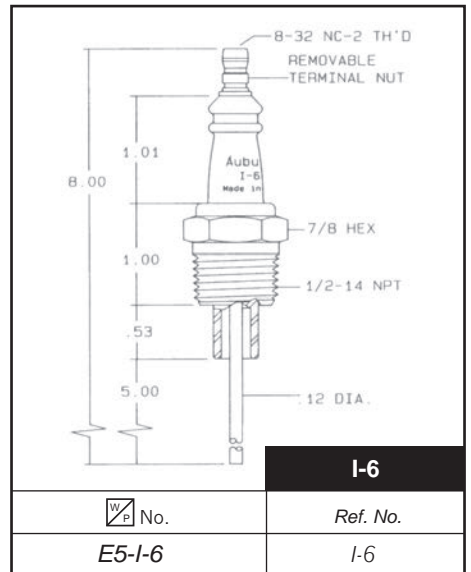

No.	Ref. No.
E5-I-6	I-6

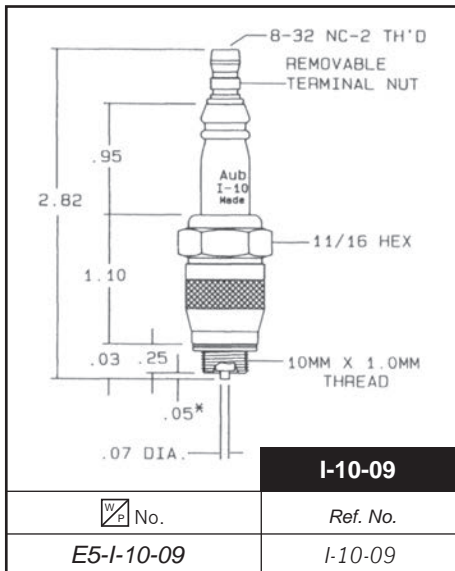

No.	Ref. No.
E5-I-10-09	I-10-09

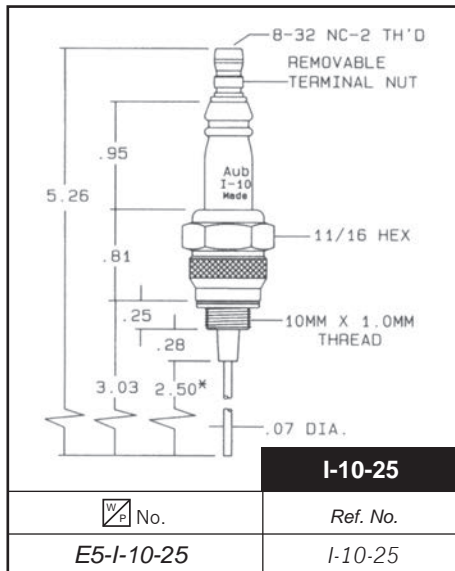

No.	Ref. No.
E5-I-10-25	I-10-25

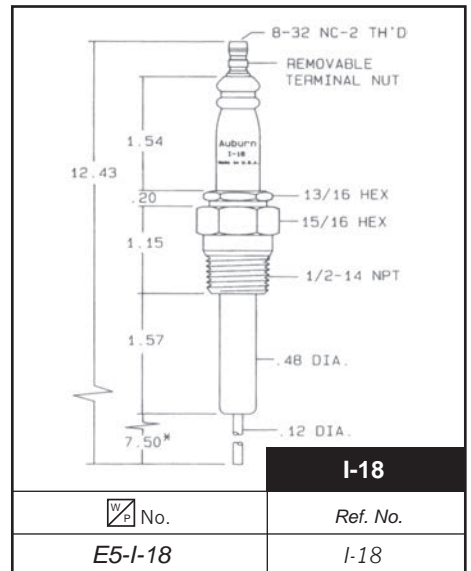

No.	Ref. No.
E5-I-18	I-18

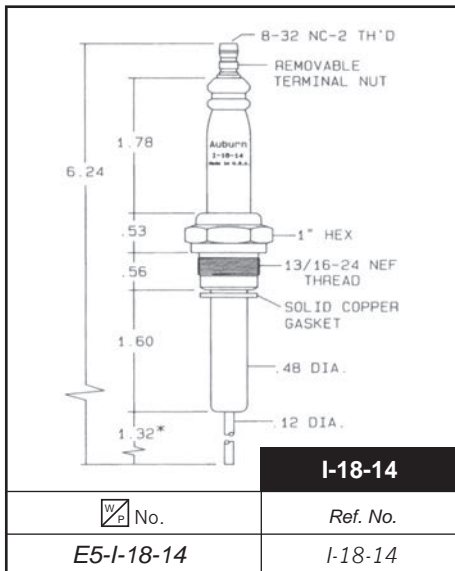

No.	Ref. No.
E5-I-18-14	I-18-14

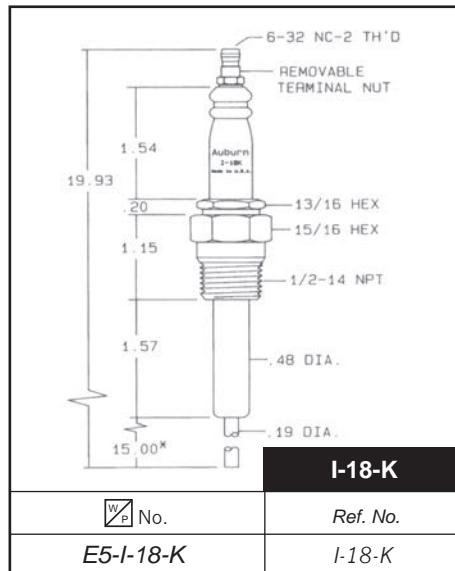

No.	Ref. No.
E5-I-18-K	I-18-K

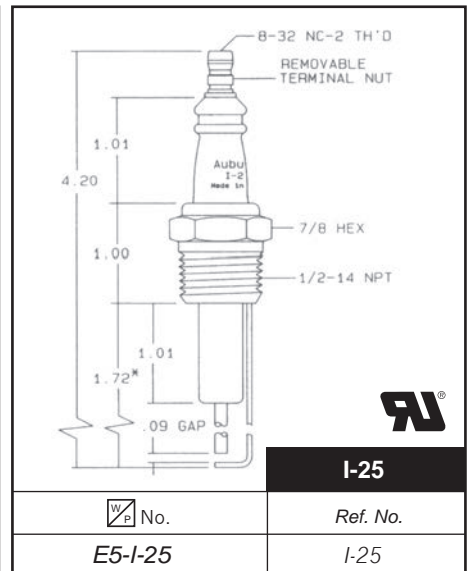

No.	Ref. No.
E5-I-25	I-25

* Dimensions marked with an asterisk are standard lengths - Other lengths available upon request

Please order by No.

rev. 12-14-15

E16

AUBURN ELECTRODES

I-25-3

W/P No.	Ref. No.
E5-I-25-3	I-25-3

I-28

W/P No.	Ref. No.
E5-I-28	I-28

I-31 Series

W/P No.	Ref. No.	"A"	"B"	ELEC. MAT.
E5-I-31	I-31	3.68	1.37	NICKEL
E5-I-31-1	I-31-1	4.17	1.87	NICKEL
E5-I-31-2	I-31-2	4.81	2.50	NICKEL
E5-I-31-3	I-31-3	4.17	1.87	INCONEL
E5-I-31-5	I-31-5	6.43	4.12	NICKEL
E5-I-31-6	I-31-6	3.31	1.06	NICKEL

I-32 **E5-FI21501**

DISCONTINUED SUBSTITUTE FI21501

W/P No.	Ref. No.
E5-I-32 discontinued	I-32
E5-FI21501	FI21501

I-33

W/P No.	Ref. No.
E5-I-33	I-33

I-64 Series

¹UL Recognized

W/P No.	Ref. No.	"A"	"B"	GAP	ELEC. MAT.
E5-I-64-1	I-64-1	4.20	1.72	.090	NI
E5-I-64-3	I-64-3	6.24	3.75	.090	NI
E5-I-64-4 ¹	I-64-4	3.60	1.12	.100	NI

I-75-5

W/P No.	Ref. No.
E5-I-75-5	I-75-5

I-75-6

W/P No.	Ref. No.
E5-I-75-6	I-75-6

I-82

W/P No.	Ref. No.
E5-I-82	I-82

* Dimensions marked with an asterisk are standard lengths - Other lengths available upon request

AUBURN ELECTRODES

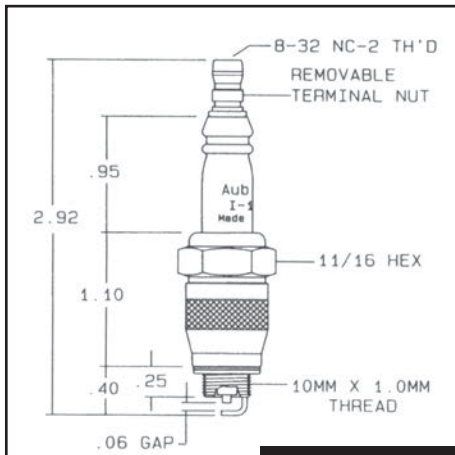

I-101

No.	Ref. No.
E5-I-101	I-101

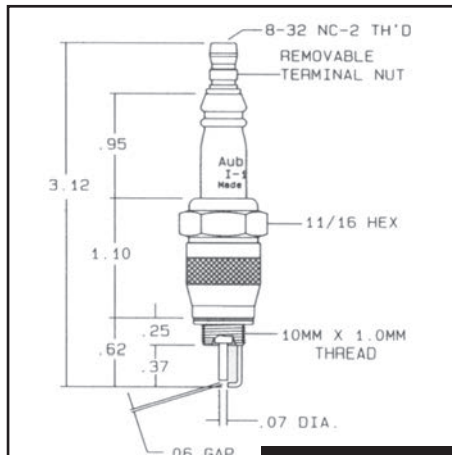

I-102

No.	Ref. No.
E5-I-102	I-102

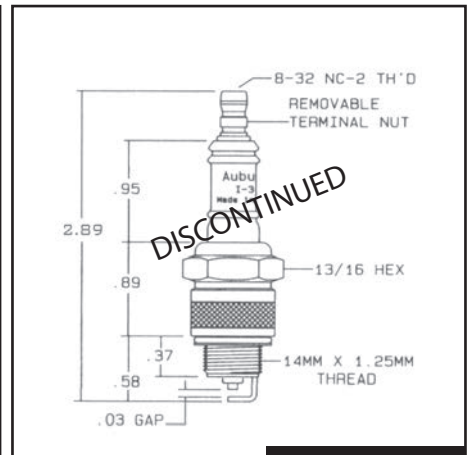

I-141

No.	Ref. No.
E5-I-141	I-141

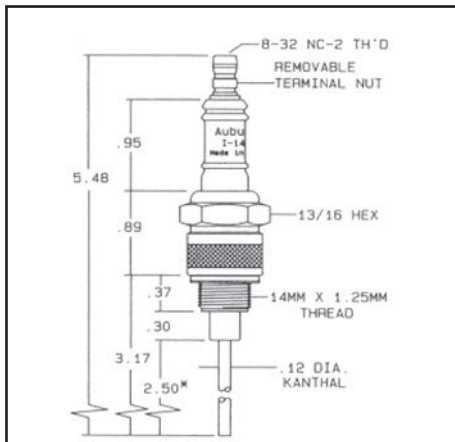

I-143

No.	Ref. No.
E5-I-143	I-143

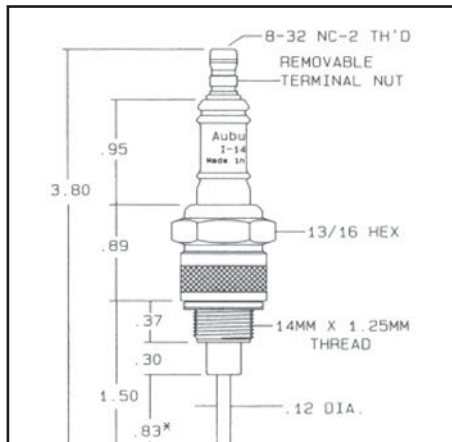

I-144

No.	Ref. No.
E5-I-144	I-144

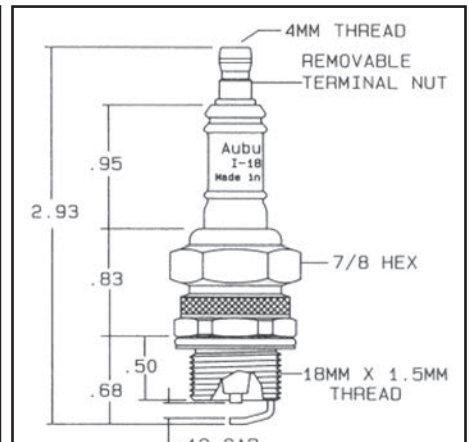

I-181

No.	Ref. No.
E5-I-181	I-181

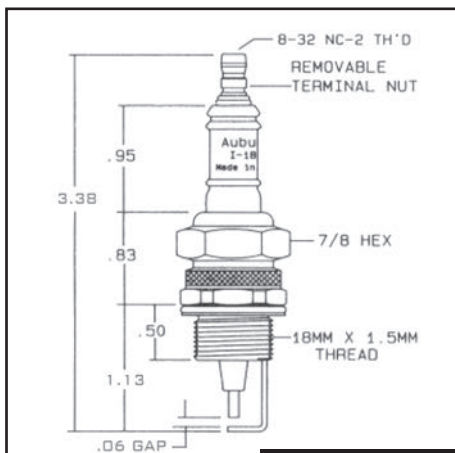

I-182

No.	Ref. No.
E5-I-182	I-182

As a major distributor of Auburn Ignition Products, Westwood can special order any Auburn item not shown in this catalog and get it to you fast!

* Dimensions marked with an asterisk are standard lengths - Other lengths available upon request

AUBURN ELECTRODES

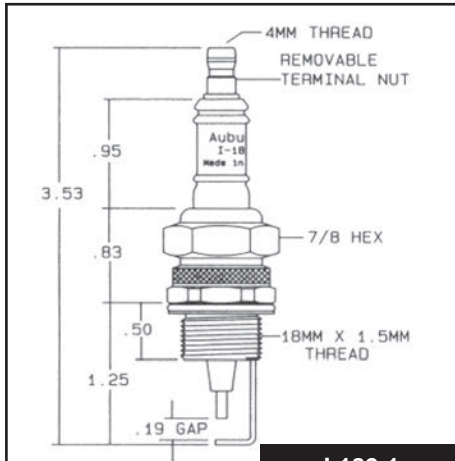

I-182-1

No.	Ref. No.
E5-I-182-1	I-182-1

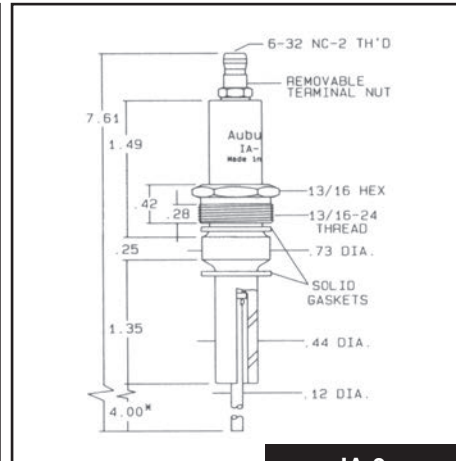

IA-9

No.	Ref. No.
E5-IA-9	IA-9

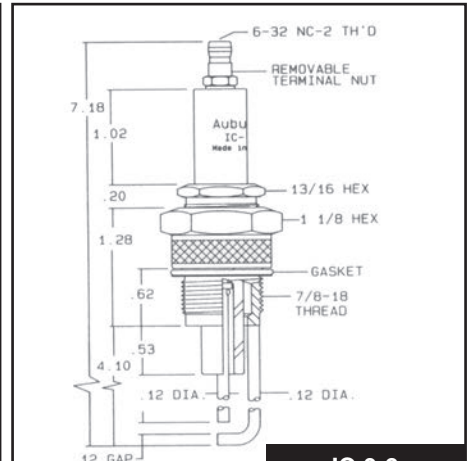

IC-9-2

No.	Ref. No.
E5-IC9-2	IC9-2

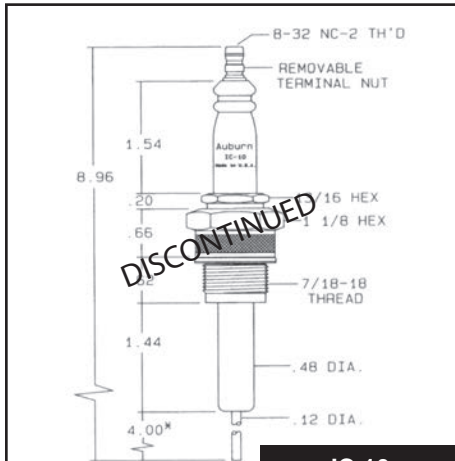

IC-10

No.	Ref. No.
E5-IC-10	IC-10

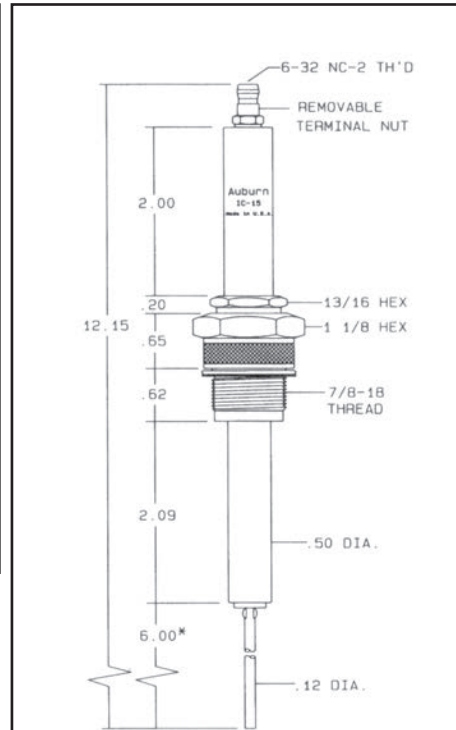

IC-15

No.	Ref. No.
E5-IC-15	IC-15

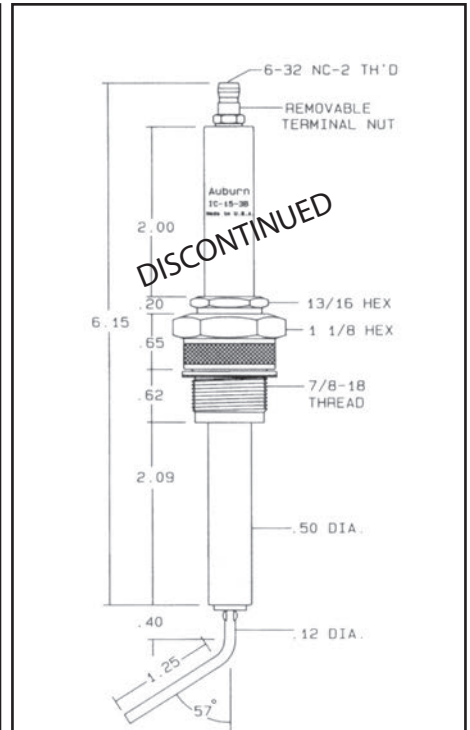

CHROMEL "D"
Center Wire

IC-15-3B

No.	Ref. No.
E5-IC-15-3B	IC-15-3B

As a major distributor of Auburn Ignition Products, Westwood can special order any Auburn item not shown in this catalog and get it to you fast!

* Dimensions marked with an asterisk are standard lengths - Other lengths available upon request

AUBURN ELECTRODES

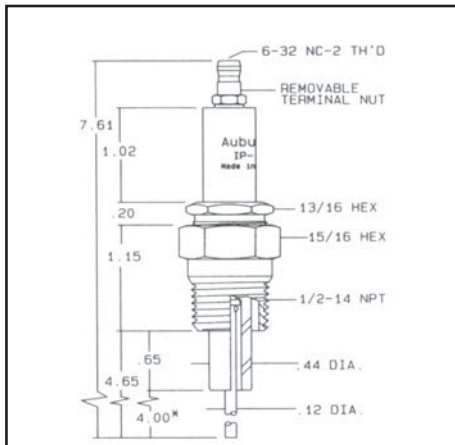

IP-9

No.	Ref. No.
E5-IP-9	IP-9

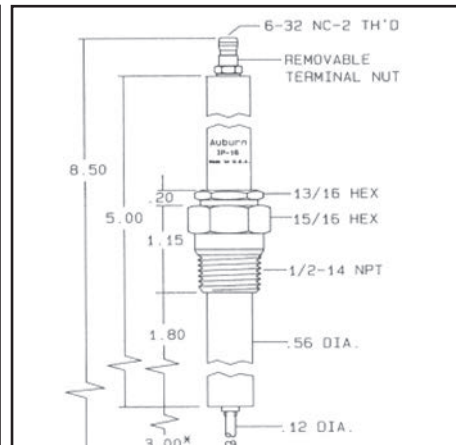

IP-16

No.	Ref. No.
E5-IP-16	IP-16

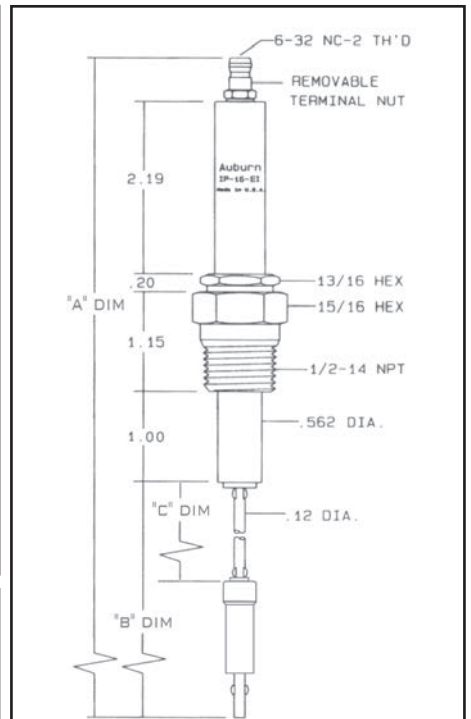

IP-16-EI Series

No.	Ref. No.	"A"	"B"	"C"
E5-IP-16-EI	IP-16-EI	18.75	13.25	11.25

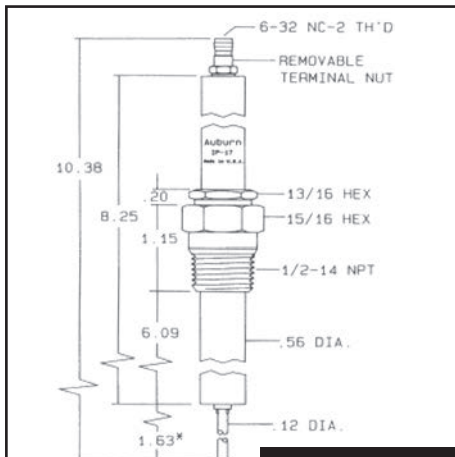

IP-17

No.	Ref. No.
E5-IP-17	IP-17

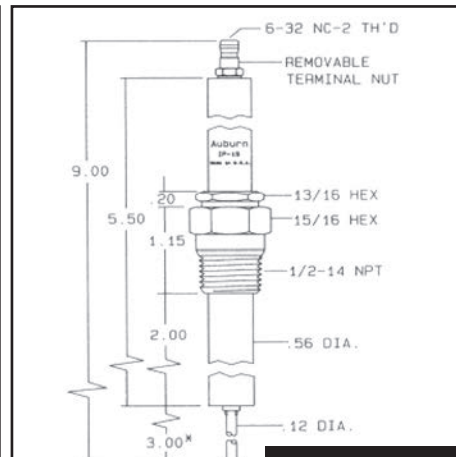

IP-19

No.	Ref. No.
E5-IP-19	IP-19

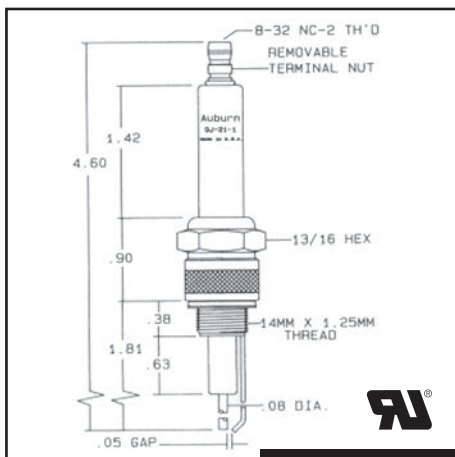

OJ-21-1

No.	Ref. No.
E5-OJ-21-1	OJ-21-1

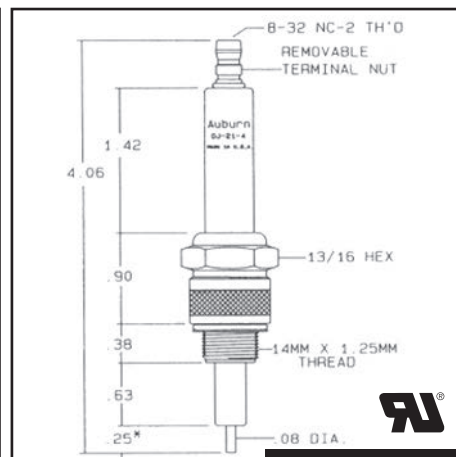

OJ-21-4

No.	Ref. No.
E5-OJ-21-4	OJ-21-4

As a major distributor of Auburn Ignition Products, Westwood can special order any Auburn item not shown in this catalog and get it to you fast!

* Dimensions marked with an asterisk are standard lengths - Other lengths available upon request

AUBURN ELECTRODES & FLAME RODS

OJ-21-5

No.	Ref. No.
E5-OJ-21-5	OJ-21-5

FLAME ROD FRS-2 Series

Center electrode tip operating temp 2,350° F

No.	Ref. No.	"A" DIM.
E5-FRS-2-6	FRS-2-6	6"
E5-FRS-2-12	FRS-2-12	12"
E5-FRS-2-18	FRS-2-18	18"
E5-FRS-2-24	FRS-2-24	24"

FLAME ROD FRS-4 Series

Center electrode tip operating temp 2,350° F

No.	Ref. No.	"A" DIM.
E5-FRS-4-4	FRS-4-4	4"
E5-FRS-4-6	FRS-4-6	6"
E5-FRS-4-7-1/2	FRS-4-7-1/2	7-1/2"
E5-FRS-4-12	FRS-4-12	12"
E5-FRS-4-24	FRS-4-24	24"

FLAME ROD FRS-3

No.	Ref. No.
E5-FRS-3	FRS-3

As a major distributor of Auburn Ignition Products, Westwood can special order any Auburn item not shown in this catalog and get it to you fast!

* Dimensions marked with an asterisk are standard lengths - Other lengths available upon request

AUBURN LIQUID LEVEL ELECTRODES

WCC Series:

Metal parts are 303 or 304 non-magnetic stainless steel. Incorporates an internal conductive glass seal (not recommended for use above 450 volts). Non-steam applications up to 2,500 PSI at 120° F or 0 PSI at 700° F. Steam applications up to 250 PSI at 406° F

WCC-KH Series:

Metal parts are 303 or 304 non-magnetic stainless steel. Incorporates a special insulator tip seal and Kovar center wire-glass seal. Non-steam applications up to 2,500 PSI at 120° F or 0 PSI at 450° F. Steam applications up to 450 PSI at 459° F

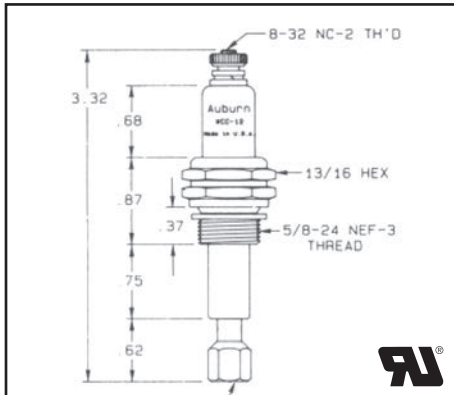

WCC-12

No.	Ref. No.
E5-WCC-12	WCC-12

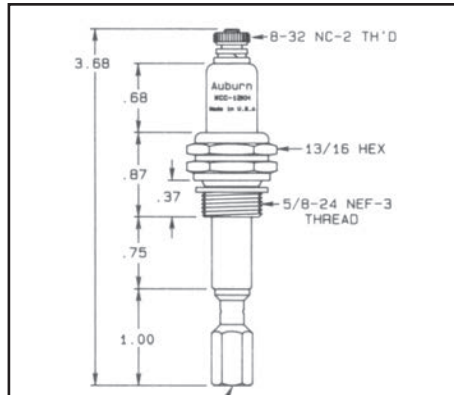

WCC-12KH

No.	Ref. No.
E5-WCC-12KH	WCC-12KH

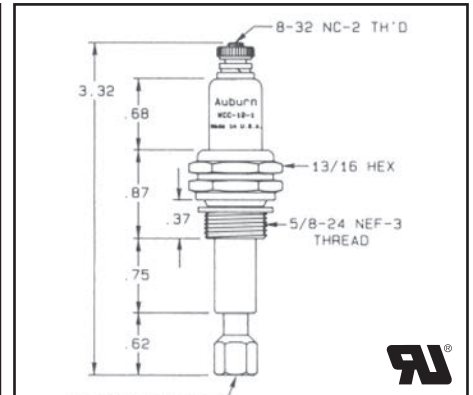

WCC-12-1

No.	Ref. No.
E5-WCC-12-1	WCC-12-1

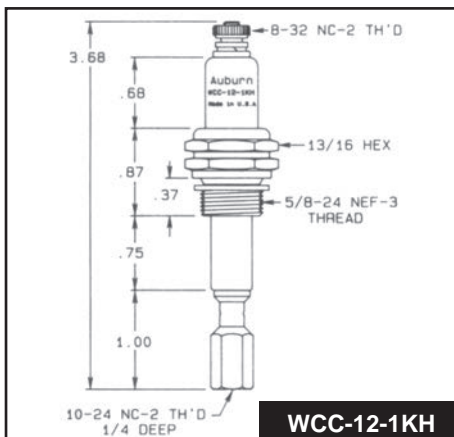

WCC-12-1KH

No.	Ref. No.
E5-WCC-12-1KH	WCC-12-1KH

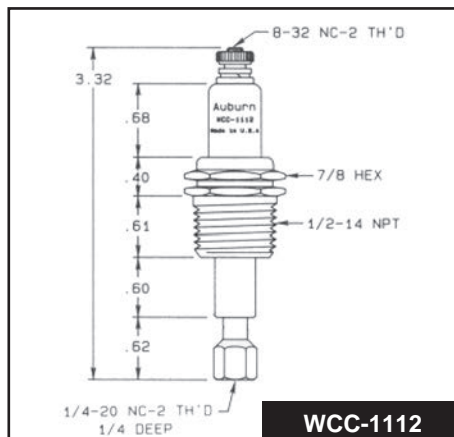

WCC-1112

No.	Ref. No.
E5-WCC-1112	WCC-1112

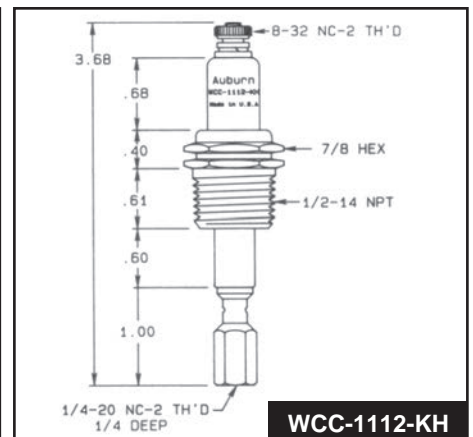

WCC-1112-KH

No.	Ref. No.
E5-WCC-1112-KH	WCC-1112-KH

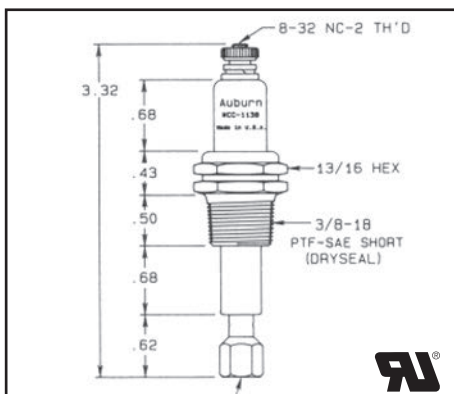

WCC-1138

No.	Ref. No.
E5-WCC-1138	WCC-1138

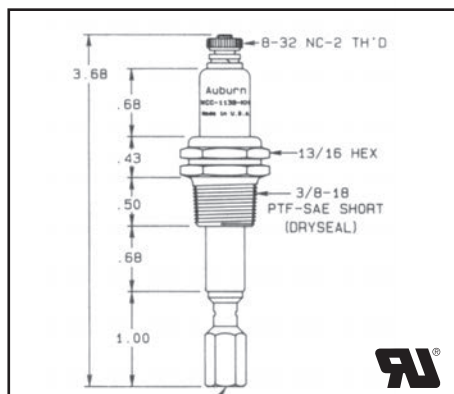

WCC-1138L

No.	Ref. No.
E5-WCC-1138L	WCC-1138L

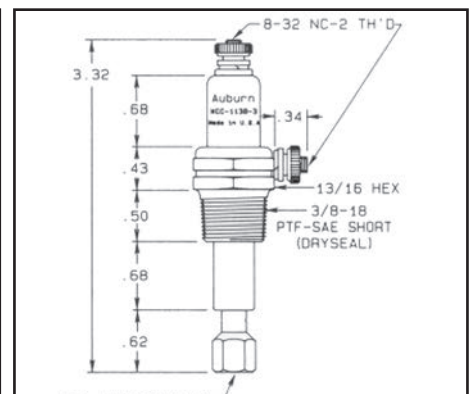

WCC-1138-3

No.	Ref. No.
E5-WCC-1138-3	WCC-1138-3

AUBURN LIQUID LEVEL ELECTRODES

WCT Series:

Metal parts are 303 or 304 non-magnetic stainless steel, center electrodes are one piece.

Non-steam applications up to 1,000 PSI at 120° F or 0 PSI at 400° F

Steam applications up to 100 PSI at 337° F

WCT-90

No.	Ref. No.
E5-WCT-90	WCT-90

WCT-90-2

No.	Ref. No.
E5-WCT-90-2	WCT-90-2

WCT-912

No.	Ref. No.
E5-WCT-912	WCT-912

WCT-938

No.	Ref. No.
E5-WCT-938	WCT-938

WCTL-3814

No.	Ref. No.
E5-WCTL-3814	WCTL-3814

As a major distributor of Auburn Liquid Level Electrodes, Westwood can special order any Auburn item not shown in this catalog and get it to you fast!

No.	Ref. No.	Thread	Length	Dia.
E5-1024-12	1024-12	10-24	12"	3/16"
E5-1024-18	1024-18	10-24	18"	3/16"
E5-1024-24	1024-24	10-24	24"	3/16"
E5-1420-6	1420-6	1/4-20	6"	1/4"
E5-1420-12	1420-12	1/4-20	12"	1/4"
E5-1420-18	1420-18	1/4-20	18"	1/4"
E5-1420-24	1420-24	1/4-20	24"	1/4"
E5-1420-36	1420-36	1/4-20	36"	1/4"
E5-3816-12	3816-12	3/8-16	12"	3/8"
E5-3816-18	3816-18	3/8-16	18"	3/8"
E5-3816-24	3816-24	3/8-16	24"	3/8"

SOLID STAINLESS STEEL PROBES

FOR USE ON LIQUID LEVEL ELECTRODE ASSEMBLIES

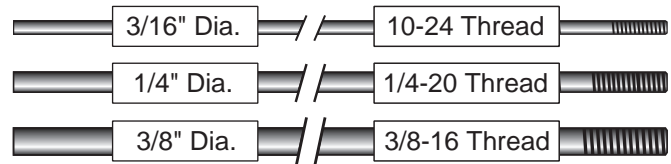

Take a look ...

LIQUID LEVEL PROBES for FULTON BOILERS on page H9

STANDARD SIZES*

*Made to order non-standard lengths available by special order.

Westwood

CHAMPION

IGNITION ASSEMBLIES



14 MM

CJ-8

No.	Ref. No.
E5-CJ-8	CJ-8

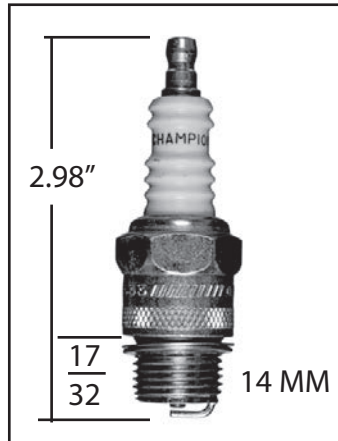

14 MM

D-9

No.	Ref. No.
E5-D-9	D-9

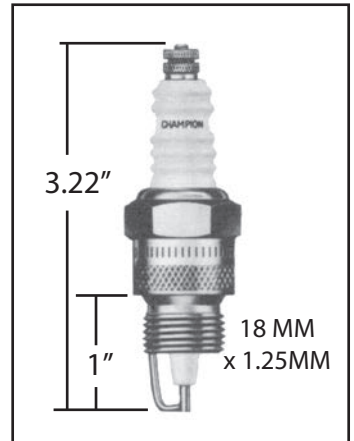

18 MM x 1.25MM

D-89D

No.	Ref. No.
E5-D-89D	D-89D

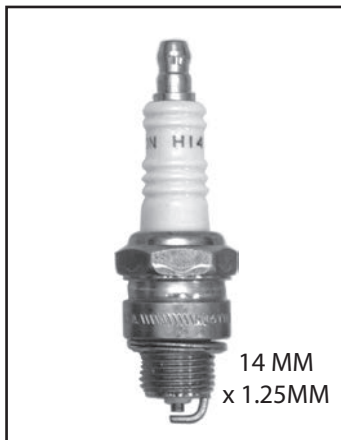

14 MM x 1.25MM

H14Y

No.	Ref. No.
E5-H14Y	H14Y

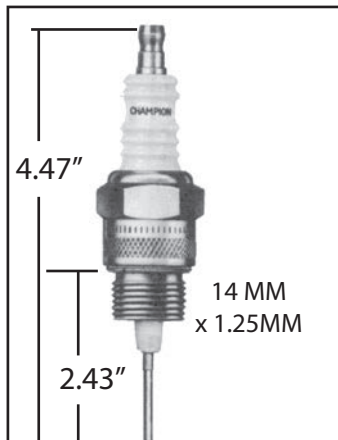

14 MM x 1.25MM

J-99

No.	Ref. No.
E5-J-99	J-99

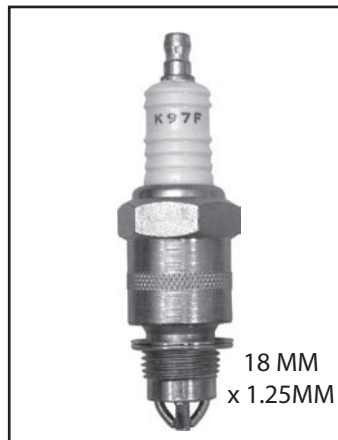

18 MM x 1.25MM

K97F

No.	Ref. No.
E5-K97F	K97F

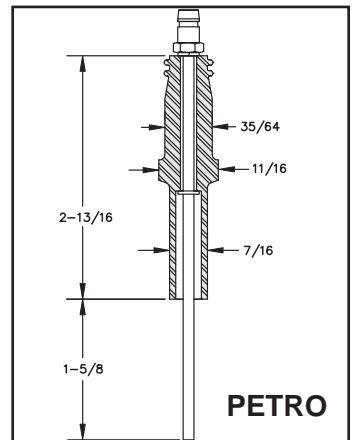

PETRO

OA-9

No.	Ref. No.
E5-OA-9	OA-9

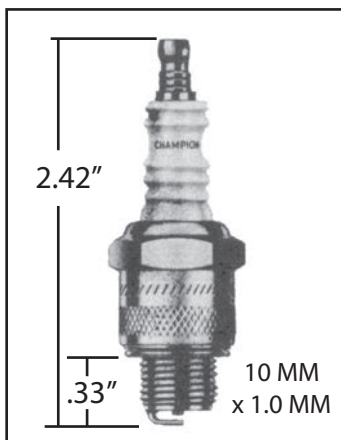

10 MM x 1.0MM

UY-6

No.	Ref. No.
E5-UY-6	UY-6



7/8-18 THD

W18

No.	Ref. No.
E5-W18	W18

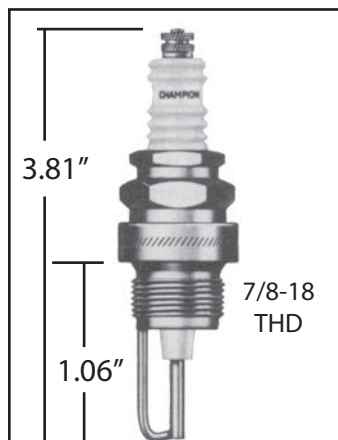

7/8-18 THD

W-95D

No.	Ref. No.
E5-W-95D	W-95D

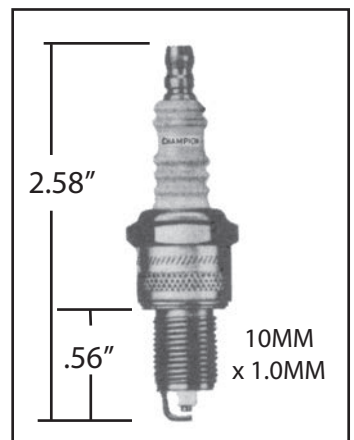

10MM x 1.0MM

Z-6

No.	Ref. No.
E5-Z-6	Z-6



TERMINALS



SPECIAL NOTE: NEW **Rajah™** TERMINAL PART NUMBERS

Rajah™ terminals and related items part numbers are now "E9-" followed by the former part number.

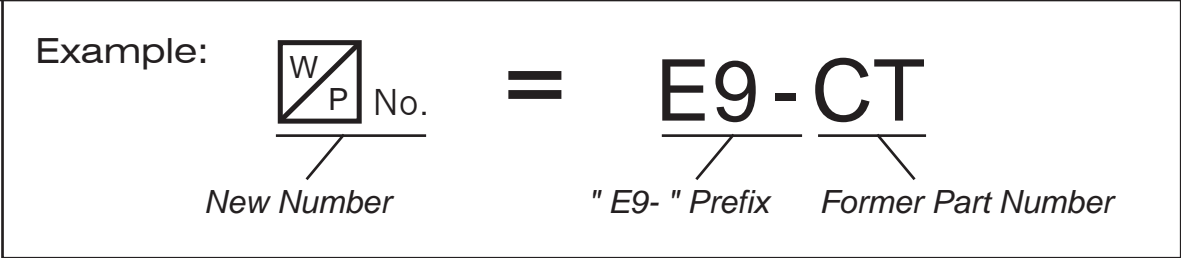

Note: Terminal part number endings of 6-32, 8-32, 10-24, and 10-32 refer to terminal thread size

 No. E9-CT	 No. E9-SS	 No. E9-R-2	 No. E9-SF	 No. E9-TT
 No. E9-CT-TS 8-32 E9-CT-TS 10-32	 No. E9-SS-TS 10-32	 No. E9-SR	 No. E9-HS 6-32 E9-HS 10-32	 No. E9-CT-BS 6-32 E9-CT-BS 8-32 E9-CT-BS 10-32
 No. E9-SS-BS 6-32 E9-SS-BS 8-32 E9-SS-BS 10-32	 No. E9-HT 6-32 E9-HT 8-32 E9-HT 10-32	 No. E9-SX-1 6-32 E9-SX-1 10-32	 No. E9-CT-SS	 No. E9-ACT
 No. E9-ASS	 No. E9-CHT	 No. E9-BS 6-32 E9-BS 8-32 E9-BS 10-24 E9-BS 10-32	 No. E9-458-9 10-32	 No. E9-RAC
 No. E9-RASS	 No. E9-EBS 6-32 E9-EBS 10-32	 No. E9-457-6 6-32	 No. E9-SS-SOS	 No. E9-R-SOS



TERMINALS



Note: Terminal part number endings of 6-32, 8-32, 10-24, and 10-32 refer to terminal thread size

 WP No. E9-T-SOS	 WP No. E9-AS-SOS	 WP No. E9-BS-SOS	 WP No. E9-SSN	 WP No. E9-RSN
 WP No. E9-TSN	 WP No. E9-ASN	 WP No. E9-BSN	 WP No. E9-ACT-BS 6-32 E9-ACT-BS 10-32	 WP No. E9-DS-1
 WP No. E9-FF-1	 WP No. E9-CC-1	 WP No. E9-SS-LBS	 WP No. E9-SS-LTS	 WP No. E9-XC
 WP No. E9-SA-1 6-32	 WP No. E9-ITN 8-32 E9-ITN 10-32	 WP No. E9-ITN-S 6-32 E9-ITN-S 8-32	 WP No. E9-TC-10	 WP No. E9-TS-10
 WP No. E9-R-1	 WP No. E9-RS-3 10-32	 WP No. E9-RX-4 6-32 E9-RX-4 8-32 E9-RX-4 10-32	 WP No. E9-RX-5 10-32	 WP No. E9-RP-6
 WP No. E9-RC-5	 WP No. E9-RE-7	 WP No. E9-AEBF	 WP No. E9-EBF	 WP No. E9-B-10 10-32 5/16" Long
 WP No. E9-B-11 10-32 1 1/16" Long	 WP No. E9-BC-11	 WP No. E9-BS-12		

Please order by  No.



TERMINALS



Note: Terminal part number endings of 6-32, 8-32, 10-24, and 10-32 refer to terminal thread size

<p><i>Reckett</i> DISCONTINUED USE E9-Y5-10</p> <p>W/P No. E9-S-15 10-32</p>	<p>W/P No. E9-AL-10</p>	<p>W/P No. E9-AS-10</p>	<p>W/P No. E9-ASC</p>	<p>W/P No. E9-S-10</p>
<p>W/P No. E9-CS</p>	<p>W/P No. E9-YL-10</p>	<p>W/P No. E9-YS-10</p>	<p>W/P No. E9-YSC</p>	<p>1-1/8" Long</p> <p>W/P No. E9-SCS-2 6-32</p>
<p>1-1/4" Long</p> <p>W/P No. E9-SCS-1 10-32</p>	<p>W/P No. E9-KBN 6-32 E9-KBN 10-24</p>	<p>W/P No. E9-DT</p>	<p>W/P No. E9-CBS</p>	<p>Cleaver Brooks Spring Connects plate assembly to ignitors - 20" Long</p>

SPECIALTY TERMINAL & ELECTRODE HARDWARE

<p>1-1/2"</p> <p>Walter Kidde brass buss bar</p> <p>W/P No. E9-686 BAR</p>	<p>3/4" O.D. 9/16" I.D.</p> <p>7/16"</p> <p>Beveled and split brass bushing</p> <p>W/P No. E9-BB</p>	<p>1/2" O.D. 7/16" I.D.</p> <p>7/16"</p> <p>Zinc plated split steel bushing</p> <p>W/P No. E9-PB</p>	<p>9/16" O.D. 7/16" I.D.</p> <p>3/4"</p> <p>Zinc plated split steel bushing</p> <p>W/P No. E9-AB</p>	<p>5/8" O.D. 9/16" I.D.</p> <p>1"</p> <p>Zinc plated split steel bushing</p> <p>W/P No. E9-DB</p>
<p>3/4" O.D. - 9/16" I.D. 1/16" Thick</p> <p>Cleaver Brooks split ring zinc plated steel</p> <p>W/P No. E9-CBR</p>	<p>3/4" O.D. - 9/16" I.D. 1/16" Thick</p> <p>Copper gasket - dished</p> <p>W/P No. E9-467 GASKET</p>	<p>3/4" O.D. - 9/16" I.D. 1/32" Thick</p> <p>Copper gasket - flat</p> <p>W/P No. E9-I-18 GASKET</p>	<p>19/32" I.D. 3/4" O.D.</p> <p>1"</p> <p>Black bakelite shield for Ray</p> <p>W/P No. E9-500 SHIELD</p>	

BUSS BARS

W/P No.	Ref. No.	12" Length*
E9-TYPE ET	Type ET	Round brass with eyelet and 6-32 thread
E9-TYPE F	Type F	Flat brass with 1/8" hole
E9-TYPE ST	Type ST	Round brass with 6-32 thread

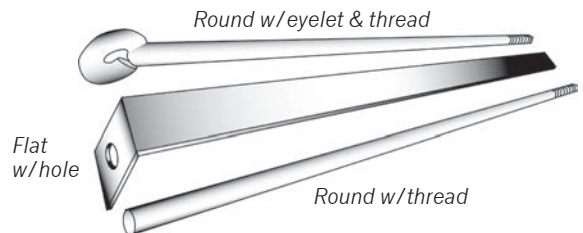



* Other lengths available up to 24"

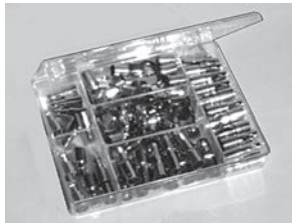

IGNITION TERMINAL KITS



 No.	Ref. No.	Description
E9-34	34	Rajah™ "Mini" Ignition Terminal Kit:
		20 - CT Cage Terminals 12 - SS Spring Snap Terminals 20 - R2 Ring Terminals 10 - RAC Right Angle Cage Terminals 12 - SF Stud Ferrule Terminals
E9-54	54	Rajah™ Transformer Terminal Kit:
		6 - AS-10 Short Adapter Spring 6 - AL-10 Long Adapter Spring 2 - TC-10 Thumb Nut on Cage 2 - 458-9 Spring Plunger (10-32) 4 - B-10 Button Contact (short) 2 - B-11 Button Contact (long) 6 - CC-1 Cage on Cage 6 - RC-5 Ram's Horn on Cage 4 - RX4 Ram's Horn on Hex 2 - R1 Ram's Horn Clip 6 - HS Hollow Stud (10-32) 6 - SX-1 Hex Stud (10-32)
E9-2097	2097	Rajah™ "Pro" Ignition Terminal Kit:
		24 - CT Cage Terminals 24 - SS Spring Snap Terminals 24 - R2 Ring Terminals 24 - SF Stud Ferrule Terminals 24 - RAC Right Angle Cage Terminals 100 - DT Distributor Terminals 24 - FF-1 Ferrule on Ferrule 1 - T200-10 (former #695) Terminal Crimping Tool
E9-3500	3500	Rajah™ "Deluxe" Ignition Terminal Kit:
		12 - CT Cage Terminals 12 - SS Spring Snap Terminals 12 - R2 Ring Terminals 12 - ACT Angle Cage Terminals 12 - SF Stud Ferrule Terminals 12 - BS Base Stud (6-32) 12 - BS Base Stud (10-32) 12 - HS Hollow Stud (6-32) 12 - HS Hollow Stud (10-32) 12 - CC-1 Cage on Cage 12 - CT-TS Cage on Stud (10-32) 12 - RC-5 Ram's Horn on Cage 12 - R-1 Ram's Horn Clip 12 - #299 Special GE Slotted Stud 12 - SX-1 Hex Stud (10-32) 1 - 1/4" Nut Driver 1 - 5/16" Nut Driver 1 - T200-10 (former #695) Terminal Crimping Tool
E9-CK-1	CK-1	Rajah™ Carlin Transformer Contact Kit:
		For in the field conversion on Carlin Burner models 98, 99, 100, 101, 102 Webster transformer model 313-28AB85 2 - Contact clips 2 - Flat washers (#10) 2 - Shakeproof washers (#10) 2 - 10-32 nuts

Please order by  No.

ELECTRICAL CLIPS & RUBBER BOOTS

 <p><input checked="" type="checkbox"/> No. E9-LV CLIP</p>	<p>Vinyl</p>  <p><input checked="" type="checkbox"/> No. E9-LV BOOT</p>	 <p><input checked="" type="checkbox"/> No. E9-20 AMP CLIP</p>	<p>Vinyl</p>  <p><input checked="" type="checkbox"/> No. E9-20 AMP BOOT</p>
<p>Distributor nipple</p>  <p><input checked="" type="checkbox"/> No. E9-DN</p>	<p>Silicone Rubber</p>  <p><input checked="" type="checkbox"/> No. E9-250 BOOT</p>	<p>Silicone Rubber</p>  <p><input checked="" type="checkbox"/> No. E9-251 BOOT</p>	





Take a look ...

JUMPERS & CORD CLIP SETS on page T13

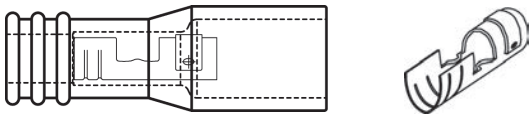
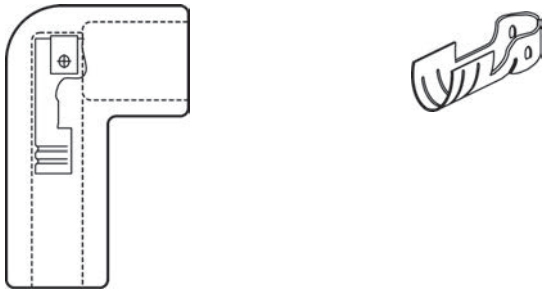
HIGH TEMPERATURE CERAMIC SPARK PLUG BOOTS with Stainless Steel Terminals

<input checked="" type="checkbox"/> No.	Ref. No.	Description
E9-ECF	ECF	<p>EXTENDED CERAMIC BOOT - with stainless steel terminal for 7mm ignition wire</p> 
E9-AECF	AECF	<p>ANGLE EXTENDED CERAMIC BOOT - with stainless steel terminal for 7mm ignition wire</p> 

Westwood IGNITION CABLE

Cable Type	 UL Recognized Component	 No.		
		25' Roll	100' Roll	1,000' Roll
GTO-15	Yes	E60-25	E60-100	E60-1000
White Silicone	-	E62-25	E62-100	-
Red Silicone	Yes	E63-25	E63-100	E63-1000

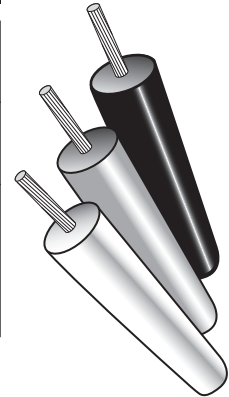

GTO-15 (black)	Large .275" outside diameter fits Rajah terminals perfectly. Withstands more than 15,000 VAC with low current leakage. Resists arc-over, tracking, and burning. Tested to withstand conditions of heat, oil, and moisture. No. 14 gauge, 19 x 26 stranded tinned copper wire. All vinyl insulation affords low temperature flexibility. Flame retardant, will not support combustion. Tough and abrasion resistant, yet easy stripping. Temperature range: UL Recognized to 105° C (221° F)
White Silicone	Large .275" outside diameter fits Rajah terminals perfectly. Withstands more than 10,000 VAC and 25,000 VDC with low current leakage. No. 16 gauge, 19 x 26 stranded tinned copper wire. Natural Silicone insulation, high dielectric strength. Temperature range: -65° F to 400° F (-54° C to 204° C)
Red Silicone	Large .275" outside diameter fits Rajah terminals perfectly. Withstands more than 10,000 VAC and 25,000 VDC with low current leakage. No. 16 gauge, 19 x 26 stranded nickel plated copper wire. Natural Silicone insulation, high dielectric strength. Temperature range: -65° F to 482° F (-54° C to 250° C) UL Recognized

CABLE ASSEMBLIES and FIBERGLAS BRAID

 No.	Ref. No.	Description
E64	#3250	Red Silicone wire high temperature cable assembly with protective metal braid . Temperature range -65° F to 450° F. Overall length is 32-1/2".
E64-5	#RS-3350	Red Silicone wire high temperature cable assembly with red Silicone boots . Temperature range -65° F to 450° F. Withstands 10,000 VAC / 25,000 VDC . Overall length is 33-1/2".
E64-20	#3253	Fiberglas braided sleeving. Fits over ignition cable for high temperature protection. Sold by the foot. (Ordering example: For 5' of sleeving order 5 of E64-20. Shipped as one piece)

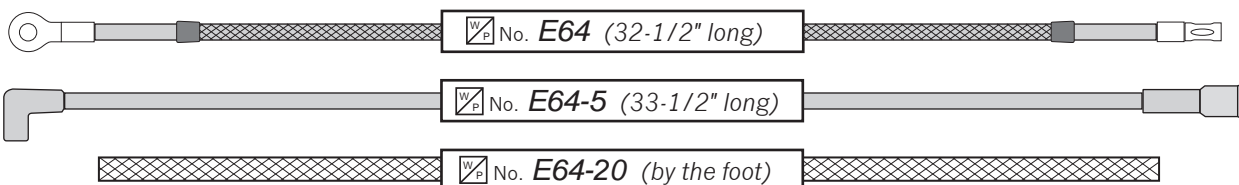

Please order by  No.

ELECTRICAL ACCESSORIES



SOLDERLESS TERMINAL KIT

No. **E70**

Contains 175 of the most popular terminals and connectors

KIT REFILL TERMINALS - Part numbers are for a package of the quantity indicated

 AWG: 22-16 Female .250 Tab No. E70-10	 AWG: 22-16 Ring #6 Stud No. E70-20	 AWG: 16-14 Ring #8 Stud No. E70-21	 AWG: 16-14 Spade #8 Stud No. E70-34	 AWG: 16-14 Spade #10 Stud No. E70-36	 AWG: 22-16 Butt Connector No. E70-40
BACK ROW - All Packages of 100					
 AWG: 16-14 Female .250 Tab No. E70-12	 AWG: 22-16 Ring #10 Stud No. E70-22	 AWG: 16-14 Ring #10 Stud No. E70-23	 AWG: 16-14 Spade #6 Stud No. E70-30	 AWG: 22-16 Spade #6 Stud No. E70-32	 AWG: 16-14 Butt Connector No. E70-42
MIDDLE ROW - Packages of 100					Pkg. of 50
 AWG: 12-10 Female .250 Tab No. E70-14	 AWG: 12-10 Ring #10 Stud No. E70-24	 AWG: 12-10 Ring 1/4" Stud No. E70-25	 AWG: 12-10 Ring 5/16" Stud No. E70-26	 AWG: 12-10 Spade #10 Stud No. E70-38	 AWG: 12-10 Butt Connector No. E70-44
FRONT ROW - All Packages of 50					

WIRE CONNECTORS - Part numbers are for a package of 100

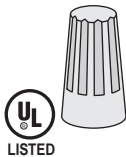

	GREY	BLUE	ORANGE	YELLOW	RED
No.	E70-50	E70-52	E70-54	E70-56	E70-58

CABLE TIES - Part numbers are for a package of 100

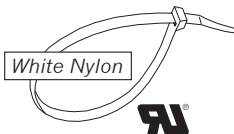

	4"	5-1/2"	7-1/2"	11"	14"
No.	E70-60	E70-62	E70-64	E70-66	E70-68

ROUGH SERVICE BULBS

Part numbers are for a box of 2 bulbs

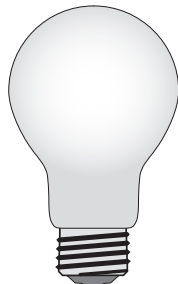

	75 Watt	100 Watt
No.	E70-75	E70-100



Westwood
CAD CELL FLAME DETECTORS

UNIVERSAL REPLACEMENT FOR HONEYWELL AND WHITE-RODGERS

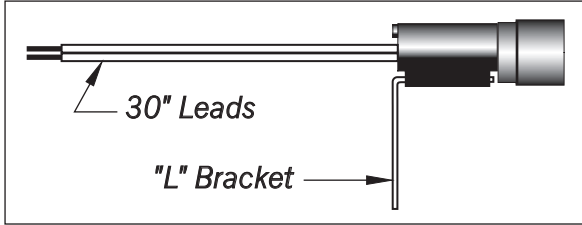
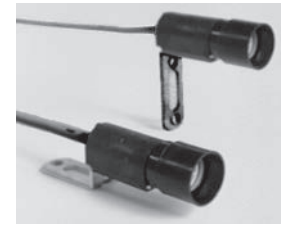

No. **E80**

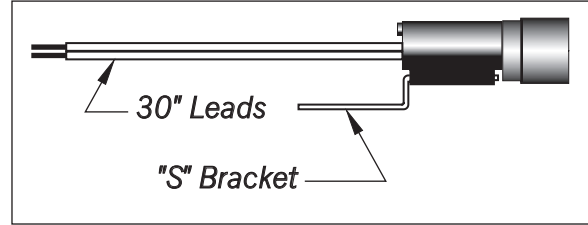

No. **E80-1**

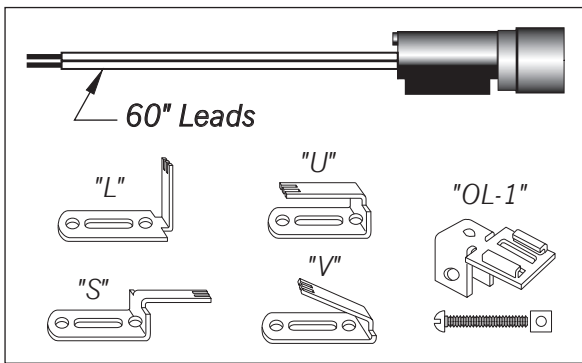

No. **E80-2**

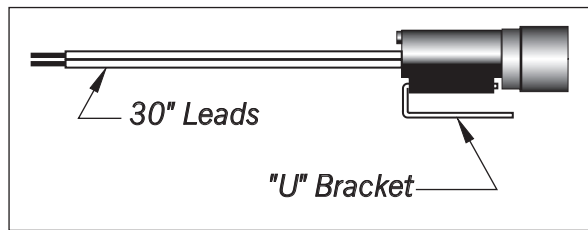

No. **E80-3**

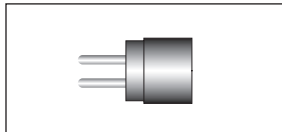

No. **E81**



No. **E81-10**

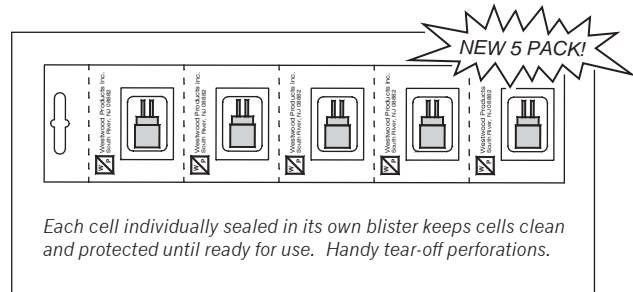

No. **E81-5**

No.	Ref. No.	Description
E80	TM-30L	Complete flame detector with cad cell eye*, 30" leads, "L" bracket, poly bag package
E80-1	TM-30S	Complete flame detector with cad cell eye*, 30" leads, "S" bracket, poly bag package
E80-2	TMK-60	Complete flame detector kit with cad cell eye*, 60" leads, "L" bracket, "S" bracket, "U" bracket, "V" bracket, "OL-1" special oil line bracket with mounting screw and nut, packaged in a box
E80-3	-	Complete flame detector with cad cell eye*, 30" leads, "U" bracket, poly bag package
E81	Type M	Cad cell eye* packaged in a box
E81-5	-	Cad cell eye* 5 pack (blister card with 5 E81-5 eyes per card), tear-off perforations
E81-10	Type W	Cad cell eye, bayonet mount for White-Rodgers cad cell flame detector DISCONTINUED

* Cad cell eye replaces Honeywell 130367 and fits C554A flame detector



T70 Cad cell relay and eye tester on page T11

Please order by No.

THERMOSTAT GUARDS

METAL AND PLASTIC TAMPER PROOF DESIGNS IN PLEASING COLORS

*Designed for use in schools, industrial plants and military installations where **rugged, maximum protection** is the first consideration. The louvered covers cannot be twisted or jammed open. Bobby pins, pencils, letter openers and other such objects cannot be inserted through the cover to adjust the thermostat.*

- ▶ Metal guards are constructed of 18-22 gauge steel with a baked enamel finish
- ▶ Plastic guards are molded from hi-impact plastic and can be used with both horizontally or vertically mounted thermostats
- ▶ All guards come with eight tumbler lock, one key, and mounting hardware
- ▶ Guards with ring bases can be installed without removing the thermostat



No. **E140**

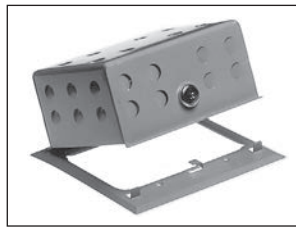

No. **E140-1**

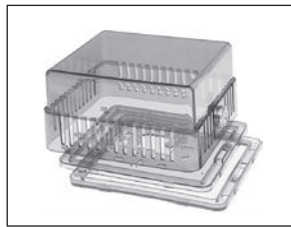

No. **E141**

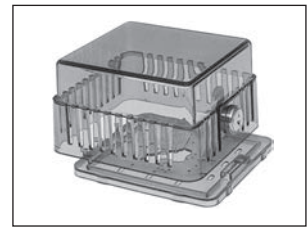

No. **E142**

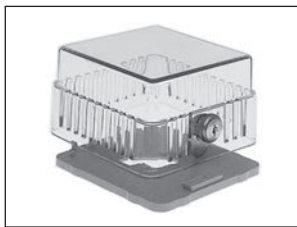

No. **E142-1**



No. **E142-2**



No. **E142-3**

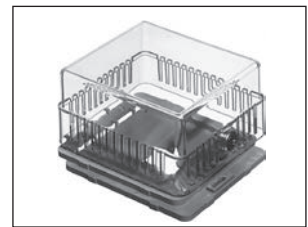

No. **E143**

No.	Ref. No.	Inside Dimensions H" x W" x D"	Mat'l	Color	Base	Comments
E140	WTG-54VL	6-1/4 x 4-3/4 x 3	M	BE	SH	T80, T90, T91, T199, T330, T340, T42, T26, T87, T92, T651, T921, T872, T882
E140-1	WTG-54VLW	6 x 3-13/16 x 3-1/8	M	BE	RH	
E141	WTG-B	5-1/4 x 4-5/8 x 3-1/4	P	BR	SR	T199, TP970, TP971, TP972, TP973, T26, T87, TS86, T832, T853, TP910
E142	WTG-EB	3-7/8 x 3-1/2 x 2-1/2	P	BR	S	
E142-1	WTG-EK	3-7/8 x 3-1/2 x 2-1/2	P	CL	S	
E142-2	WTG-EM	3-7/8 x 3-1/2 x 2-1/2	M	BE	S	
E142-3	WTG-EO	3-7/8 x 3-1/2 x 2-1/2	P	OP	S	
E143	WTG-K	5-1/4 x 4-5/8 x 3-1/4	P	CL	SR	

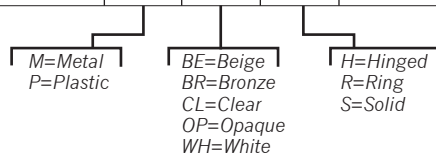

THERMOSTAT GUARDS (CONTINUED)

METAL AND PLASTIC TAMPER PROOF DESIGNS IN PLEASING COLORS

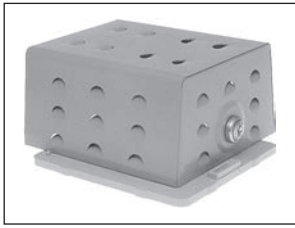

No. **E143-1**

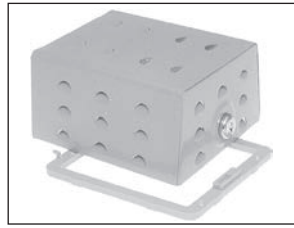

No. **E143-2**

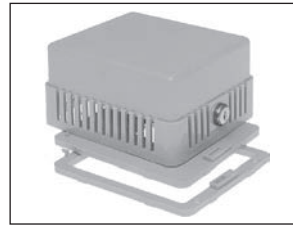

No. **E143-3**

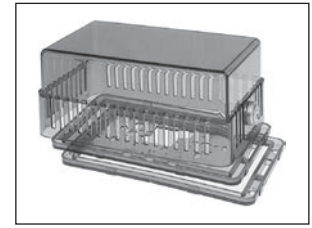

No. **E144**

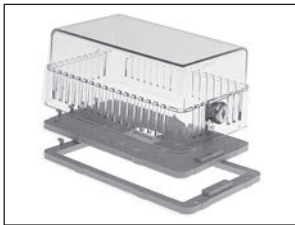

No. **E144-1**

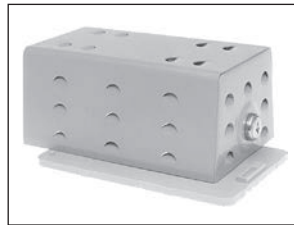

No. **E144-2**

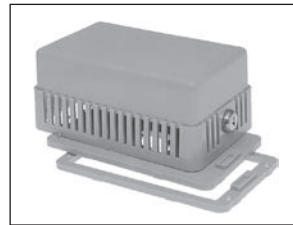

No. **E144-3**

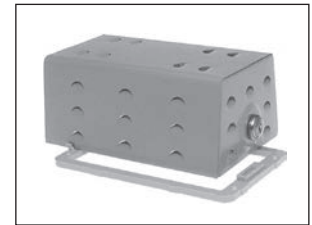

No. **E144-4**

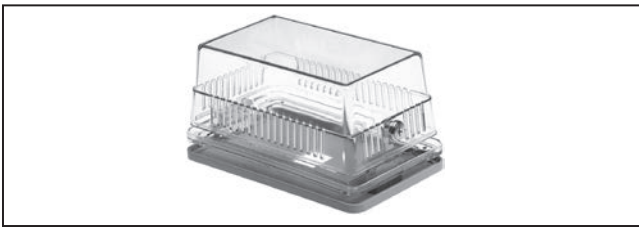

No. **E145 Series**

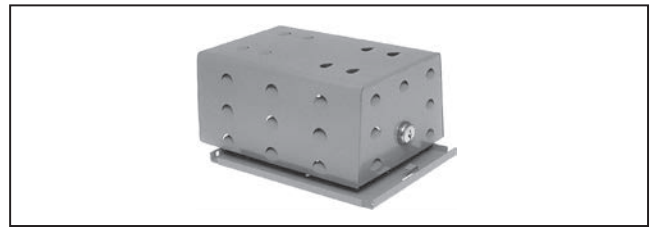

No. **E146**

No.	Ref. No.	Inside Dimensions H" x W" x D"	Mat'l	Color	Base	Comments
E143-1	WTG-KM	5-1/4 x 4-5/8 x 3	M	BE	S	
E143-2	WTG-KWM	5-1/4 x 4-5/8 x 3-1/4	M	BE	R	
E143-3	WTG-O	5-1/4 x 4-5/8 x 3-1/4	P	OP	SR	
E144	WTG-RB	6-3/8 x 3-1/2 x 3-1/4	P	BR	SR	
E144-1	WTG-RK	6-3/8 x 3-1/2 x 3-1/4	P	CL	SR	T80, T90, T91, T99, T199, T330, T340, T42, TA42, T26, TS86, T87, T92, T498, T651, T834, T921, T872, T882
E144-2	WTG-RM	6-3/8 x 3-1/2 x 3	M	BE	S	
E144-3	WTG-RO	6-3/8 x 3-1/2 x 3-1/4	P	OP	SR	
E144-4	WTG-RWM	6-3/8 x 3-1/2 x 3-1/4	M	BE	R	
E145	WTG-UB2	8-1/8 x 4-5/8 x 3-5/8	P	BR	SR	General, White-Rodgers, Barber Colman, Honeywell, Robertshaw, Camstat, Penn
E145-1	WTG-UK2	8-1/8 x 4-5/8 x 3-5/8	P	CL	SR	
E146	WTG-UM	7-1/4 x 5-3/8 x 3-1/2	M	BE	S	

M=Metal
 P=Plastic
 BE=Beige
 BR=Bronze
 CL=Clear
 OP=Opaque
 WH=White
 H=Hinged
 R=Ring
 S=Solid

Please order by No.

THERMOSTAT GUARDS (CONTINUED)

METAL AND PLASTIC TAMPER PROOF DESIGNS IN PLEASING COLORS

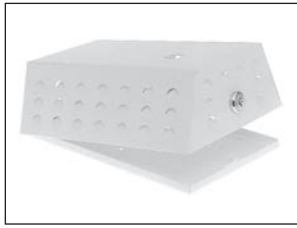

No. **E147 Series**

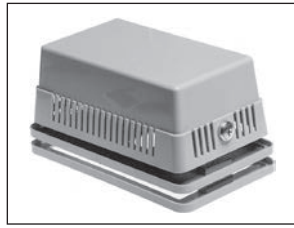

No. **E148**

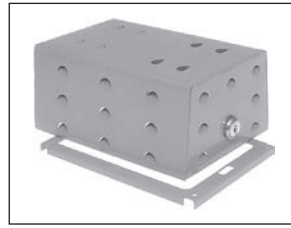

No. **E149**

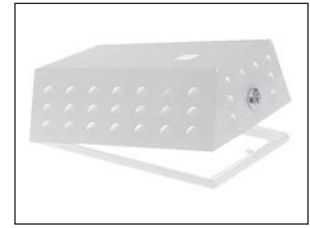

No. **E150 Series**

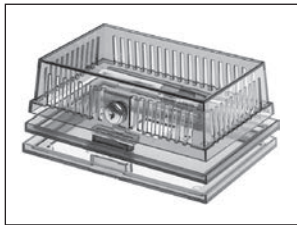

No. **E151**

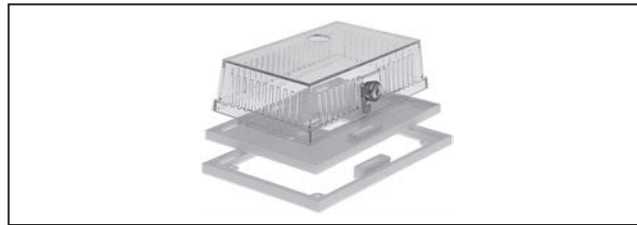

No. **E151-1, -2**

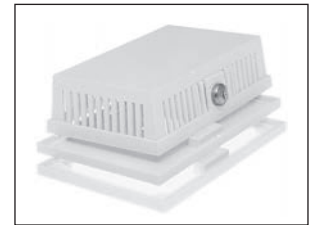

No. **E151-3**

No.	Ref. No.	Inside Dimensions H" x W" x D"	Mat'l	Color	Base	Comments
E147	WTG-UM1	9-3/8 x 6-3/4 x 3	M	WH	SH	Honeywell T7300 series
E147-1	WTG-UM1DH	9-3/8 x 6-3/4 x 3	M	WH	SH	Honeywell T7300 series w/display opening
E147-2	WTG-UM1DOH	9-3/8 x 6-3/4 x 3	M	WH	SH	Honeywell T7300 series w/override/display opening
E147-3	WTG-UM1DOWR	9-3/8 x 6-3/4 x 3	M	WH	SH	White-Rodgers IF90 series w/override/display opening
E147-4	WTG-UM1OH	9-3/8 x 6-3/4 x 3	M	WH	SH	Honeywell T7300 series w/override opening
E147-5	WTG-UM1SDH	9-3/8 x 6-3/4 x 3	M	WH	SH	Honeywell T7400 series w/display opening
E148	WTG-UO2	8-1/8 x 4-5/8 x 3-5/8	P	OP	SR	
E149	WTG-UWM	6-3/4 x 4-1/4 x 3-9/16	M	BE	R	
E150-1	WTG-UWM1DH	9-3/8 x 6-3/4 x 3	M	WH	RH	Honeywell T7300 series w/display opening
E150-2	WTG-UWM1DOH	9-3/8 x 6-3/4 x 3	M	WH	RH	Honeywell T7300 series w/override/display opening
E150-3	WTG-UWM1DOWR	9-3/8 x 6-3/4 x 3	M	WH	RH	White-Rodgers IF90 series w/override/display opening
E150-4	WTG-UWM1OH	9-3/8 x 6-3/4 x 3	M	WH	RH	Honeywell T7300 series w/override opening
E150-5	WTG-UWM1SDH	9-3/8 x 6-3/4 x 3	M	WH	RH	Honeywell T7400 series w/display opening
E151	WTG-DB	4-1/8 x 7-1/16 x 2-1/4	P	BR	SR	
E151-1	WTG-DK	4-1/8 x 7-1/16 x 2-1/4	P	CL	SR	
E151-2	WTG-DK1	4-1/8 x 7-1/16 x 2-1/4	P	CL	SR	w/override opening
E151-3	WTG-DO	4-1/8 x 7-1/16 x 2-1/4	P	OP	SR	

M=Metal
 P=Plastic
 BE=Beige
 BR=Bronze
 CL=Clear
 OP=Opaque
 WH=White
 H=Hinged
 R=Ring
 S=Solid

ULTRAGLO™ Thermostat Light

Mounts anywhere!

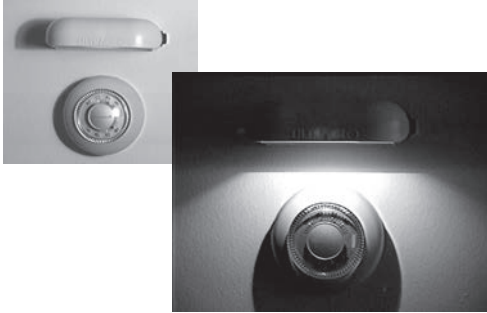

This easy to mount battery powered light has an ultra bright bulb that draws little current. It can be mounted in any convenient location with the two mounting screws provided. Easily slips out of its mounting bracket for use as a hand light. Use in cars, boats, RVs and campers too!

 No. **E140-40**

REPLACEMENT ZONE VALVE MOTOR

For motor driven OPEN, spring return CLOSE valves
(ie. Erie, Flare, Honeywell, Superior)

**INSTALLS WITHOUT REMOVING VALVE FROM PIPING
USING EASY TO INSTALL EXTENDED BRASS SCREWS**

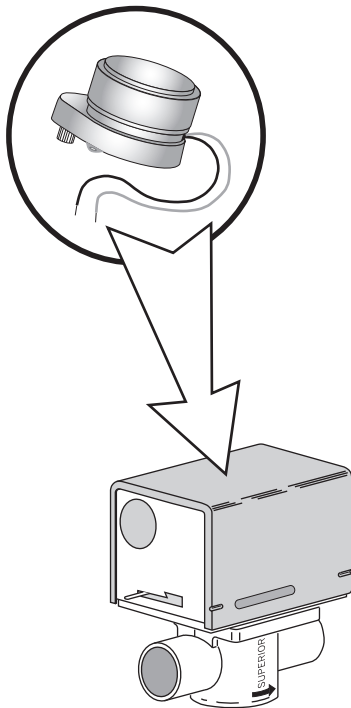

New easy to install screws!

 No.	Description
E180	Individually packaged with installation instructions, wire nuts, and easy to install extended brass mounting screws 24 VAC, 50/60 Hz, .32 A

Westwood

CAST IRON TOP FUEL FILTERS

WITH **EPOXY** COATING INSIDE!

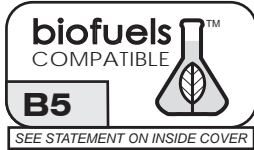

- Exact Replacement for popular CAST IRON top filters
- Heavy gauge canister with EPOXY COATING on the inside - FIRST in the industry!
- UL GPH and pressure ratings EXCEED comparable OEM filters
- 360° screwdriver slot makes disassembly for element changing easy
- Service environment: Indoors, 20° to 105° F





CHOICE OF ELEMENT INSIDE

Pure-Oil™

Fiber-Welded White Element



No. F20

CLASSIC **FELT™**

Stacked Segment Element



No. F25



CHOICE OF ELEMENT INSIDE

Pure-Oil™

Fiber-Welded White Element



No. F65

CLASSIC **FELT™**

Stacked Segment Element



No. F70

COMPLETE CAST IRON TOP FILTERS with EPOXY coated canister

 No.	Element Type	GPH	PSI	Exact Replacement for:
F20 F25	Pure-Oil™ CLASSIC FELT™	17	52	General 1A-25A
F65 F70	Pure-Oil™ CLASSIC FELT™	32	52	General 2A-700A

All filters have 3/8" NPT pipe connections

 Take a look ...

UL Recognized CANISTER UPGRADE KITS on page F12
Individual FILTER GASKETS on page F11

Westwood

HIGH CAPACITY CAST IRON TOP FUEL FILTERS

WITH **EPOXY** COATING INSIDE!

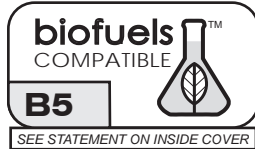

- Exact Replacement for popular CAST IRON top filters
- Heavy gauge canister with EPOXY COATING on the inside - FIRST in the industry!
- UL GPH and pressure ratings EXCEED comparable OEM filters
- 360° screwdriver slot makes disassembly for element changing easy
- **BIG GUY™** element holds twice as much as standard elements
- Service environment: Indoors, 20° to 105° F

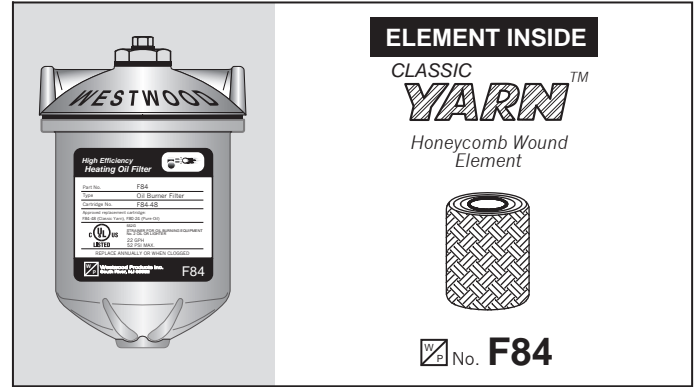
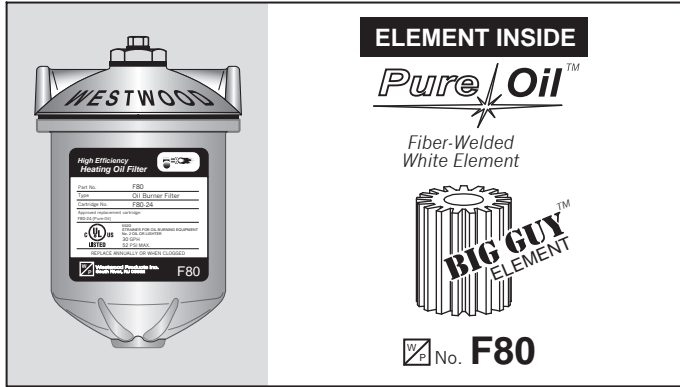

COMPLETE CAST IRON TOP FILTERS with EPOXY coated canister

BIG GUY™
ELEMENT
HOLDS TWICE
AS MUCH!

W/P No.	Element Type	GPH	PSI	Exact Replacement for:
F80	Pure-Oil™ BIG GUY™	30	52	Fulflo FB4
F84	CLASSIC YARN™	22	52	

All filters have 3/8"- NPT pipe connections

Take a look ...

UL Recognized CANISTER UPGRADE KITS on page F12
Individual FILTER GASKETS on page F11

Please order by No.

Westwood

the NEW industry leader in Spin-Ons!

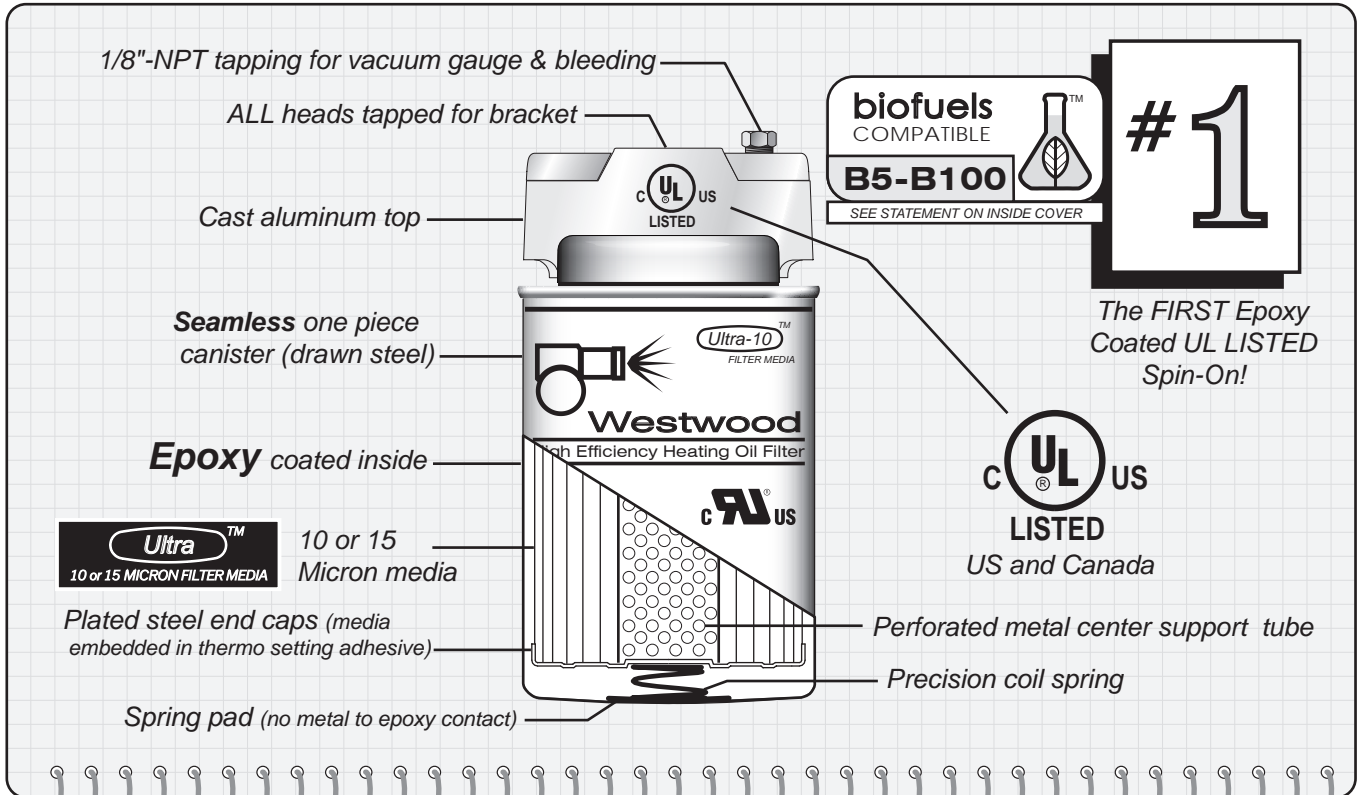

For Every Service Need...

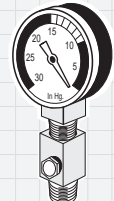
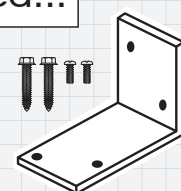
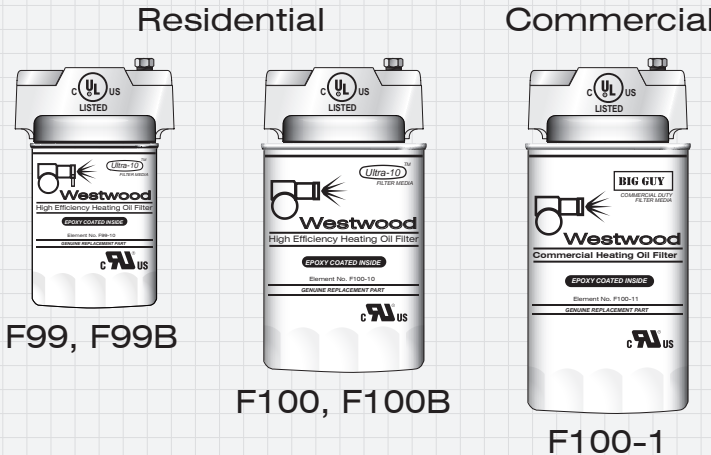

See the following pages for a complete listing of the entire Spin-On line, replacement elements, and accessories.

Model no.	F99	F99B	F100	F100B	F100-1
Microns	10	15	10	15	30
GPH	16	16	29	29	52
Fuel Oils	1, 2, up to B5	1, 2, up to B100	1, 2, up to B5	1, 2, up to B100	1, 2, up to B5

All Westwood Spin-On filters and replacement elements are either UL Listed or UL Recognized Components

THE NEW F99-2 SPIN-ON FILTER

Now The Perfect Size!

IF YOU LIKE
THIS FILTER...

...YOU'RE GONNA LOVE
THIS FILTER!



F20

- 17 GPH
- 52 PSI MAX
- UL Listed
- Epoxy Coated



F99-2

- 16 GPH
- 47 PSI MAX
- UL Listed
- Epoxy Coated
- 10 Micron Filtration
- Mounting Bracket
- Quick & Clean Filter Change
- Fits In Same Space As Traditional Filters

The New F99-2 Spin-on filter

Designed to match the size and performance of traditional oil burner filters, but with improvements that you will love! The F99-2 gives you 10 micron filtration, quick and clean filter changes, a mounting bracket, in a size that fits in the same space as traditional filters.

P/N	Description
F99-2	Complete Spin-on Filter w/mounting bracket
F99-10	Replacement Cartridge Only



Please order by  No.

F4

All Spin-On filters have 3/8"-NPT pipe connections and a 1/8"-NPT bleeder/gauge port. Service environment: Indoors, 20° to 105° F.

biofuels
COMPATIBLE

B5-B100

SEE STATEMENT ON INSIDE COVER

RESIDENTIAL - 16 GPH, 40 PSI, 10 or 15 Micron



Traditional
F20

New!
F99-2
F99-2B

The New F99-2 & F99-2B Spin-on filters

Designed to match the size and performance of traditional oil burner filters, but with improvements that you will love! The F99-2 & F99-2B (biofuel) filters give you 10 & 15 micron filtration respectively. They offer quick and clean filter changes, a mounting bracket, in a size that fits in the same space as traditional filters.



No. **F99-2**
 No. **F99-2B**
Complete Filter with
bracket kit



No. **F99-10**
 No. **F99-10B**
Replacement Element,
individ. boxed with "O" ring

Part No.	F99-2	F99-2B	F99-10	F99-10B
Microns	10	15	10	15
GPH	16	16	16	16
Fuel Oils	1, 2, up to B5	1, 2, up to B100	1, 2, up to B5	1, 2, up to B100

RESIDENTIAL - 29 GPH, 40 PSI, 10 or 15 Micron



No. **F100**
Complete Filter



No. **F100-2**
 No. **F100-2B**
Complete Filter with
bracket kit



No. **F100-4**
Complete Filter with
bleeder fitting and **FLI**[™]
gauge



No. **F100-6**
Complete Filter with
bracket kit, bleeder fitting
and **FLI**[™] gauge



No. **F100-10**
 No. **F100-10B**
Replacement Element,
individually boxed
with "O" ring

Part No.	F100	F100-2	F100-2B	F100-4	F100-6	F100-10	F100-10B
Microns	10	10	15	10	10	10	15
GPH	29	29	29	29	29	29	29
Fuel Oils	1, 2, up to B5	1, 2, up to B5	1, 2, up to B100	1, 2, up to B5	1, 2, up to B5	1, 2, up to B5	1, 2, up to B100

COMMERCIAL - 52 GPH, 20 PSI, 30 Micron, Fuels 1, 2, B5



No. **F100-1**
Complete Filter



No. **F100-3**
Complete Filter with
bracket kit



No. **F100-5**
Complete Filter with
bleeder fitting and **FLI**[™]
gauge



No. **F100-7**
Complete Filter with
bracket kit, bleeder fitting
and **FLI**[™] gauge



No. **F100-11**
Replacement Element,
individually boxed
with "O" ring









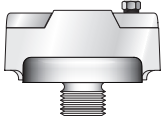

Need help identifying what you need? See cross reference on next page.

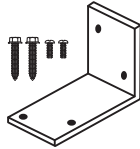
SPIN-ON CROSS REFERENCE - Westwood to others

 No.	Description	Gar-Ber	Sid Harvey (Mitco)	Crown
F99-2	Filter - Residential	-	-	41439
F99-2B	Filter - Residential, w/bracket, 100% Biofuel	-	-	-
F100	Filter - Residential	11V-R	290, 264-SO	-
F100-1	Filter - Commercial	-	292-2, 264-92	-
F100-2	Filter - Residential w/bracket	11BV-R	-	-
F100-2B	Filter - Residential w/bracket, 100% Biofuel	-	-	-
F100-3	Filter - Commercial w/bracket	11BV-M	292-2B, 264-92B	-
F100-4	Filter - Residential w/gauge	11V-RK	-	-
F100-5	Filter - Commercial w/gauge	-	292-2G, 264-92G	-
F100-6	Filter - Residential w/bracket & gauge	11BV-RK	-	-
F100-7	Filter - Commercial w/bracket & gauge	11BV-MK	292-2GB, 264-92GB	-
F100-8	Replacement spin-on filter top only	-	290-SO, 290-SOM	-
F100-10	Spin-On element only - Residential	R	290-6, 264-91	41436
F100-10B	Spin-On element only - Residential, 100% Biofuel	-	-	-
F100-11	Spin-On element only - Commercial	M	292-1, 264-93	-
F100-14	Filter Life Indicator (FLI) color coded gauge, 1/8"-NPT	F.R.I.	-	-

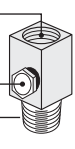
This cross-reference is provided as an aid in identifying which Westwood part numbers most closely replace those part numbers shown. It was accurate at the time it was created, to the extent that the information was publically available. Since manufacturers may sometimes change specs or discontinue products altogether, some inaccuracies may develop over time. Further, the Westwood parts shown will provide an equivalent, or superior, level of performance and service. However, due to differences among manufacturers, physical size and dimensions may vary.









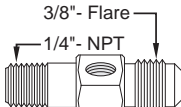

SPIN-ON PARTS & ACCESSORIES

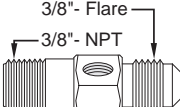
  No. F100-8 Replacement filter top only with holes for bracket	  No. F100-12 Mounting bracket Kit (includes screws)	  No. F100-14 FLI™ (Filter Life Indicator) color coded compound gauge	 1/8"- NPT Standard 8-32 bleed screw with gasket  No. F100-16 Gauge Mount with Bleeder Screw	  No. F100-18 Spin-On filter wrench (fits all popular filters)
--	--	--	---	--

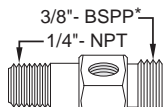

FILTER LIFE INDICATOR GAUGE AND FITTINGS

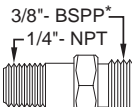
The **FLI™** gauge is a color coded compound gauge that predicts filter life by showing the running vacuum as the filter loads up. The fittings may also be used as a diagnostic tool wherever a gauge needs to be inserted into the system.

  No. F100-50 Piping: 3/8" Copper Use at: Pump, OSV, Tigerloop	  No. F100-60 Piping: 3/8" Copper Use at: Filter	  No. F100-70 Piping: Flexible oil Line Use at: Pump, OSV, Tigerloop	  No. F100-80 Piping: Buderus flexible oil line between Tigerloop and pump inlet port	  No. F100-85 Piping: Buderus flexible oil line between pump return port and Tigerloop
--	--	--	---	---

 No.	Description	System Piping	Typically Installed At
F100-14	FLI™ Filter Life Indicator color coded gauge, 1/8"-NPT	-	-
F100-50	FLI™ fitting, 3/8" flare x 1/4"- NPT(M)	3/8" OD Copper	Pump, OSV, Tigerloop
F100-55	F100-50 fitting with FLI™ gauge	3/8" OD Copper	Pump, OSV, Tigerloop
F100-60	FLI™ fitting, 3/8" flare x 3/8"- NPT(M)	3/8" OD Copper	Filter
F100-65	F100-60 fitting with FLI™ gauge	3/8" OD Copper	Filter
F100-70	FLI™ fitting, 1/4"- NPT(F) x 1/4"- NPT(M)	Flexible Oil Line	Pump, OSV, Tigerloop
F100-75	F100-70 fitting with FLI™ gauge	Flexible Oil Line	Pump, OSV, Tigerloop
F100-80	FLI™ fitting, 3/8"- BSPP* x 1/4"- NPT(M), with FLI™ gauge	Buderus Oil Line	Tigerloop to pump
F100-85	Buderus-Tigerloop pump return fitting, 3/8"- BSPP* x 1/4"- NPT(M)	Buderus Oil Line	Pump to Tigerloop

*BSPP = British Standard Pipe Parallel. The thread used on Buderus flexible oil lines.

Please order by  No.

Westwood

SECONDARY FILTRATION ASSEMBLIES

Fully assembled filter assemblies combining Westwood's premium cast iron top filters with Westwood's ultra fine spin-on filter. Connected in series, the **PRIMARY** filter catches most contamination; the **SECONDARY** filter traps the small nozzle plugging particles. All filters used in the secondary filtration assemblies are UL Listed. Service environment: Indoors, 20° to 105° F.

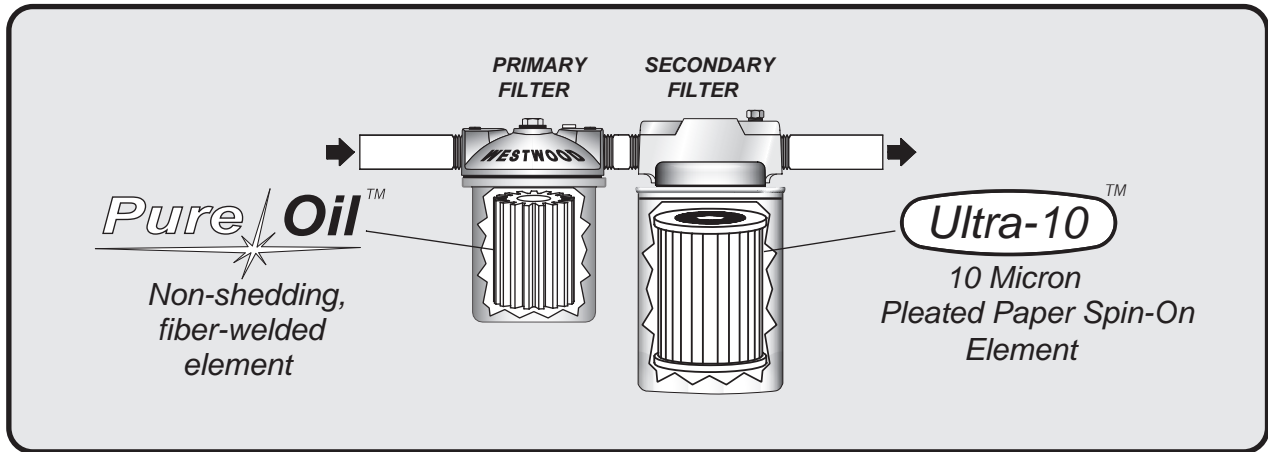

W/P No.	Primary Filter No.	Primary Element	Secondary Filter No.	Secondary Element
F20-100	F20		F100	
F65-100	F65	Pure-Oil™	F100	10 micron spin-on
F80-100	F80		F100	

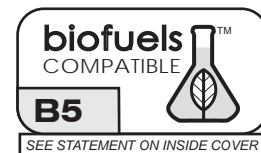

All filters have 3/8" - NPT pipe connections

Take a look ...

UL Recognized CANISTER UPGRADE KITS on page F12
Individual FILTER GASKETS on page F11

F7

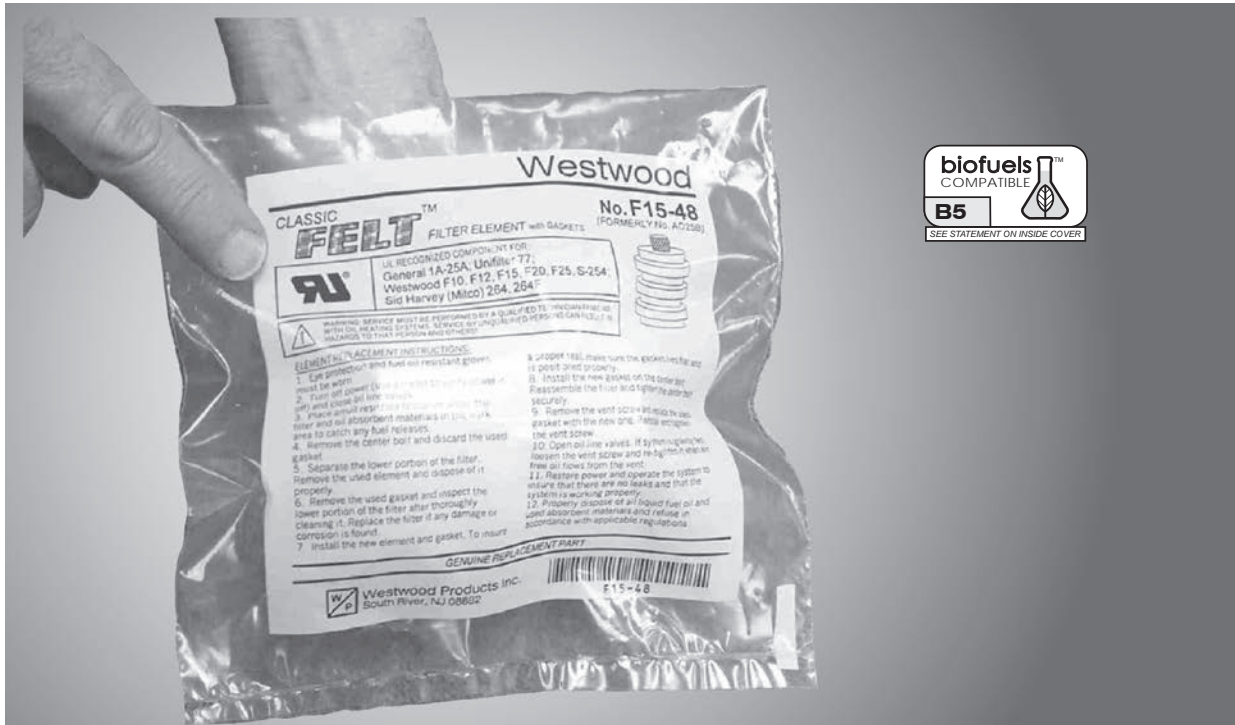

USE ONLY
UL RECOGNIZED
 replacement elements



An industry first! Westwood's new line of replacement filter elements are UL Recognized for use in the General 1A-25A, 2A-700A; Unifilter 77, 99; Sid Harvey (Mltco) 264, 265; Fulflo FB4; and Fromatic C-40, C-50

Be Safe! Always look for the UL Recognized Component symbol



Pure Oil™ FILTER ELEMENTS

- ▶ Latest Computer Designed Shape
- ▶ Largest surface area with most filtering ribs
- ▶ Greater capacity - highest in it's class!
- ▶ Fiber-welded for shed free performance
- ▶ Environmentally friendly processed plant fiber
- ▶ Popular elements UL Recognized Components

The Most Advanced Design...
With the Most Advanced Material!

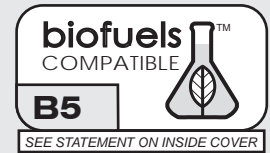
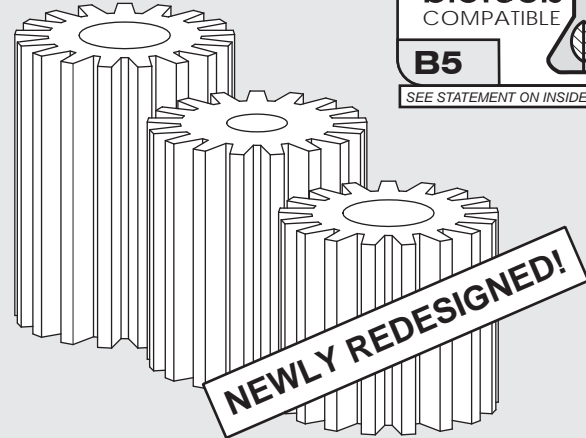

 No.	Reference No.	Description	Fits	QTY PKG
F10-48*	PA-25	Pure-Oil™ Individually bagged with gaskets	General 1A-25A; Unifilter 77; Westwood F10, F12, F15, F20, F25; Sid Harvey (Mitco) 264, 264F	48
F30-24*	-	Pure-Oil™ Individually bagged with gaskets	General 2A-700A; Unifilter 99; Westwood F30, F32, F35, F65, F70; Sid Harvey (Mitco) 265, 265F	24
F80-24*	-	Pure-Oil™ BIG GUY™ Ind. bag w/gaskets	Fulflo FB4; Westwood F80, F84	24
F80-30*	-	Pure-Oil™ bulk packed less gaskets	Fulflo FB4; Westwood F80, F84	30
F80-36*	P4FO-IB	Pure-Oil™ Individually boxed with gaskets	Fulflo FB4; Westwood F80, F84	36
F80-48*	-	Pure-Oil™ Individually bagged with gaskets	Fulflo FB4; Westwood F80, F84	48
F81-10	-	Pure-Oil™ Individually bagged with gaskets	Fulflo FB6	10
F82-6	-	Pure-Oil™ Individually bagged with gaskets	Fulflo FB8	6
F83-4	-	Pure-Oil™ Individually bagged with gaskets	Fulflo FB10	4
F90-6*	-	Pure-Oil™ Individually bagged with gaskets	Firomatic C-40 (RC-20)	6
F90-12*	-	Pure-Oil™ BIG GUY™ Ind. bag w/gaskets	Firomatic C-40 (RC-20)	12
F90-36*	PF-20	Pure-Oil™ Individually bagged with gaskets	Firomatic C-40 (RC-20)	36
F91-6*	-	Pure-Oil™ Individually bagged with gaskets	Firomatic C-50 (RC-30)	6
F91-12*	-	Pure-Oil™ BIG GUY™ Ind. bag w/gaskets	Firomatic C-50 (RC-30)	12
F91-36*	PF-30	Pure-Oil™ Individually bagged with gaskets	Firomatic C-50 (RC-30)	36
F92-6	-	Pure-Oil™ Individually bagged with gaskets	Purolator PF2002	6
F92-36	PP-20	Pure-Oil™ Individually bagged with gaskets	Purolator PF2002	36

* UL Recognized Component



HOLDS TWICE
AS MUCH!

Individual FILTER GASKETS on page F11

F9

Ultra-10™

10 MICRON FILTER ELEMENTS

Upgrades any standard filter to the performance of a SPIN-ON!

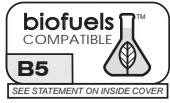

- ▶ 10 Micron rating for super fine filtration
- ▶ Same type element as used in Spin-Ons
- ▶ Advanced collapse-proof design
- ▶ UL Recognized Component

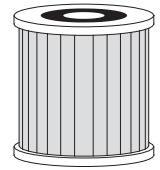
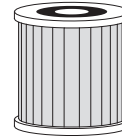

W/P No. **F12-12**

W/P No. **F32-12**

W/P No.	Description	Fits	QTY PKG
F12-12*	Ultra-10™ Indiv. bagged with gaskets	General 1A-25A; Unifilter 77; Westwood F10, F12, F15, F20, F25; Sid Harvey (Mitco) 264, 264F	12
F32-12*	Ultra-10™ Indiv. bagged with gaskets	General 2A-700A; Unifilter 99; Westwood F30, F32, F35, F65, F70; Sid Harvey (Mitco) 265, 265F	12

* UL Recognized Component

CLASSIC



STACKED SEGMENT ELEMENTS

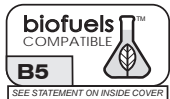

- ▶ Premium quality precision cut wool felt
- ▶ Economical time proven classic design
- ▶ UL Recognized Component

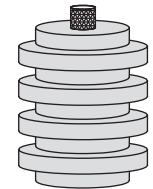
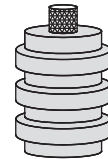

W/P No. **F15-36, -48**

W/P No. **F35-12, -24**

W/P No.	Reference No.	Description	Fits	QTY PKG
F15-36*	A025	CLASSIC FELT™ Indiv. boxed with gaskets	General 1A-25A; Unifilter 77; Westwood F10, F12, F15, F20, F25; Sid Harvey (Mitco) 264, 264F	36
F15-48*	A025B	CLASSIC FELT™ Indiv. bagged with gaskets	Sid Harvey (Mitco) 264, 264F	48
F35-12*	-	CLASSIC FELT™ Indiv. bagged with gaskets	General 2A-700A; Unifilter 99; Westwood F30, F32, F35, F65, F70; Sid Harvey (Mitco) 265, 265F	12
F35-24*	A070	CLASSIC FELT™ Indiv. boxed with gaskets	Sid Harvey (Mitco) 265, 265F	24

* UL Recognized Component

COMMERCIAL ELEMENT™ for General Filters 2A-300

- ▶ Original **Hard to find** sealed can design

W/P No.	Reference No.	Description	Fits	QTY PKG
F75-12	A030	Original sealed can design, individually boxed with gaskets	General 2A-300	12

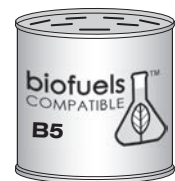

W/P No. **F75-12**

Individual FILTER GASKETS on page F11

Please order by No.

CLASSIC **YARN**™ WOUND ELEMENTS

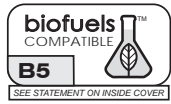

- ▶ Premium quality tightly wound yarn
- ▶ Economical time proven design
- ▶ Popular elements UL Recognized

W/P No.	Reference No.	Description	Fits	QTY PKG
F84-30*	4FO-30	Bulk (no gaskets)	Fulflo FB4;	30
F84-36*	4FO-IB	Boxed with gaskets	Westwood	36
F84-48*	4FO-IBG	Bagged with gaskets	F80, F84	48
F85-10	-	Bagged with gaskets	Fulflo FB6	10
F85-30	6FO-30	Bulk (no gaskets)		30
F86-6	-	Bagged with gaskets	Fulflo FB8	6
F86-30	8FO-30	Bulk (no gaskets)		30
F87-4	-	Bagged with gaskets	Fulflo FB10	4
F87-30	10FO-30	Bulk (no gaskets)		30

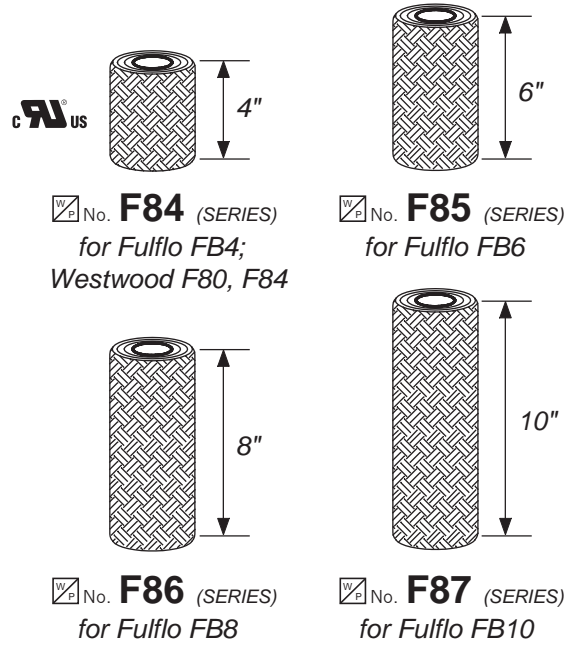

* UL Recognized Component

FUEL FILTER GASKETS

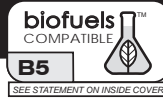

UL Recognized material - Same as used in Westwood's UL Listed filters



W/P No.	Reference No.	Description / Filter Manufacturer and Model Information	Where Used	Material	QTY PKG
F80-60	-	Gasket set for Fulflo FB4, FB6, FB8, FB10; Westwood F80, F84 filters; (1 ea. cover, nut, vent), bagged	Cover Nut Vent	Rubber Fiber Fiber	1 1 1
F10-50	CG-25	General 1A-25A; Unifilter 77;	Cover	Rubber	100
F10-52	BG-25	Westwood F10, F12, F15, F20, F25;	Bolt	Fiber	100
F10-54	-	Sid Harvey (Mitco) 264, 264F	Vent	Fiber	100
F10-55	VG-25	Westwood S-254	Vent	Fiber	100
F30-50	CG-70	General 2A-700A; Unifilter 99;	Cover	Rubber	100
F10-52	BG-25	Westwood F30, F32, F35, F65, F70;	Bolt	Fiber	100
F10-54	-	Sid Harvey (Mitco) 265, 265F	Vent	Fiber	100
F75-50	CG-300	General 2A-300	Cover	Rubber	100
F75-56	LG-300		Lower Can	Rubber	100
F80-50	CG-B4	Fulflo FB4, FB6, FB8, FB10;	Cover	Rubber	100
F80-52	BG-4	Westwood F80, F84	Nut	Fiber	100
F80-54	VG-4		Vent	Fiber	100
F90-50	CG-20	Firomatic C-40 (RC-20), C-50 (RC-30)	Cover	Rubber	100
F90-52	BG-20	DISCONTINUED	Bolt	Fiber	100
F92-50	CG-2002	Purolator PF2002	Cover	Rubber	100
F92-52	BG-2002		Bolt	Rubber	100
F92-54	VG-2002		Vent	Fiber	100

F11



USE ONLY
UL RECOGNIZED
 replacement canisters

Another industry first! Westwood's new line of replacement canisters are UL Recognized for use on General 1A-25A, 2A-700A; Unifilter 77, Unifilter 99; Sid Harvey (Mitco) 264, 264F, 265, 265F; and Fulflo FB4.

Be Safe! Always look for the UL Recognized Component symbol



CANISTER UPGRADE KITS*

Epoxy coated canister, element, center bolt, gasket, fiber washers
 Service environment: Indoors, 20° to 105° F

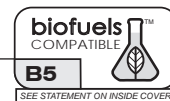

 No.	Element Type	Upgrades
F10-5 F15-5	Pure-Oil™ CLASSIC FELT™	General 1A-25A; Unifilter 77; Westwood F10, F12, F15, F20, F25; Sid Harvey (Mitco) 264, 264F
F30-5 F35-5	Pure-Oil™ CLASSIC FELT™	General 2A-700A; Unifilter 99; Westwood F30, F32, F35, F65, F70; Sid Harvey (Mitco) 265, 265F
F80-5 F84-5	Pure-Oil™ BIG GUY™ CLASSIC YARN™	FULFLO FB4; Westwood F80, F84

* All kits contain UL Recognized Component canisters and elements

Please order by  No.

Westwood
STANDARD GAUGE GLASS



HIGH QUALITY GLASS IN
5/8" AND 3/4"
OUTSIDE DIAMETER (O.D.) SIZES

STANDARD							
Length (inches)	No.		Max. PSI Water-Steam (see note 1.)	Length (inches)	No.		Max. PSI Water-Steam (see note 1.)
	5/8" 6/Pkg.	3/4" 12/Pkg.			5/8" 6/Pkg.	3/4" 12/Pkg.	
6	H1-6	-	210 - 100	24	H1-24	H2-24	180 - 100
8	H1-8	H2-8	210 - 100	26	-	-	-
10	H1-10	H2-10	205 - 100	28	-	-	-
12	H1-12	H2-12	200 - 100	30	H1-30	-	175 - NR
14	H1-14	H2-14	200 - 100	36	H1-36	H2-36	165 - NR
16	H1-16	H2-16	195 - 100	48	H1-48	H2-48	140 - NR
18	H1-18	H2-18	190 - 100	60	H1-60	-	-
20	H1-20	H2-20	185 - 100	72	-	-	-
22	H1-22	H2-22	180 - 100				

note 1. Maximum Working Pressure (PSI): Water up to 150° F - Steam up to 425° F - NR = Not Recommended

GAUGE GLASS WASHERS - Standard (Neoprene - Square cut)

I.D. x O.D. x Thickness	No.	Ref. No.	No.	Ref. No.	No.	Ref. No.
	Pkg. of 12		Pkg. of 50		Pkg. of 100	
9/16" x 13/16" x 1/4"	H6-6	-	H6-8	-	H6-10	GGW-6812
3/4" x 15/16" x 1/4"	H6-11	-	H6-13	-	H6-15	GGW-7102
3/4" x 15/16" x 3/8"	H6-16	-	H6-18	-	H6-20	GGW-7103
3/4" x 15/16" x 1/2"	H6-21	-	H6-23	-	H6-25	GGW-7105



Take a look ...

GAUGE GLASS CUTTERS on page T16

Westwood

**HIGH PRESSURE AND
RED LINE GAUGE GLASS**

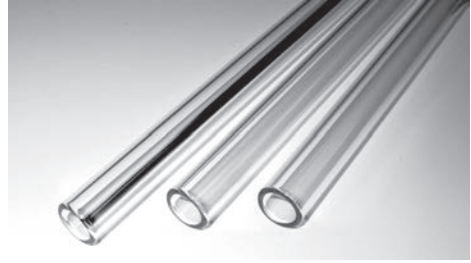

HIGH QUALITY GLASS IN
5/8" AND 3/4"
OUTSIDE DIAMETER (O.D.) SIZES

New!

In addition to the standard package of 12 pieces, High Pressure and Red Line gauge glass is now available individually packaged in PVC pipe containers for break resistant shipping.

HIGH PRESSURE				RED LINE					
Length (inches)	No.		Max. PSI <i>Water-Steam</i> (see note 1.)	No.		Max. PSI <i>Water-Steam</i> (see note 1.)	No.		Max. PSI <i>Water-Steam</i> (see note 1.)
	5/8" 12/Pkg.	5/8" <i>Individually Packaged</i>		5/8" 12/Pkg.	5/8" <i>Individually Packaged</i>		3/4" 12/Pkg.	3/4" <i>Individually Packaged</i>	
8	H3-8	H3-9	435 - 320	H4-8	H4-9	370 - 285	H5-8	H5-9	360 - 280
10	H3-10	H3-11	420 - 315	H4-10	H4-11	345 - 280	H5-10	H5-11	340 - 275
12	H3-12	H3-13	410 - 305	H4-12	H4-13	335 - 280	H5-12	H5-13	330 - 275
14	H3-14	H3-15	390 - 295	H4-14	H4-15	325 - 275	H5-14	H5-15	320 - 270
16	H3-16	H3-17	375 - 285	H4-16	H4-17	315 - 270	H5-16	H5-17	310 - 265
18	H3-18	H3-19	360 - 280	H4-18	H4-19	305 - 265	H5-18	H5-19	300 - 260
20	H3-20	H3-21	350 - 270	H4-20	H4-21	290 - 265	H5-20	H5-21	285 - 260
24	H3-24	H3-25	320 - 255	H4-24	H4-25	265 - 255	H5-24	H5-25	260 - 250
-	-	-	-	H4-30	H4-31	235 - NR	-	-	-
36	H3-36	H3-37	245 - NR	H4-36	H4-37	205 - NR	H5-36	H5-37	200 - NR
-	-	-	-	H4-48	H4-49	165 - NR	-	-	-
-	-	-	-	H4-60	H4-61	125 - NR	-	-	-
-	-	-	-	H4-72	H4-73	90 - NR	-	-	-

note 1. Maximum Working Pressure (PSI): Water up to 150° F - Steam up to 425° F - NR = Not Recommended

GAUGE GLASS WASHERS - High Pressure (Lip mold) 300°F

I.D. x O.D. x Thickness	No. Ref. No.		No. Ref. No.		No. Ref. No.	
	Pkg. of 12		Pkg. of 50		Pkg. of 100	
5/8" x 7/8" x 9/32"	H6-50	#3 GASKET	H6-52	-	H6-54	-
3/4" x 1-1/8" x 1/2"	H6-55	#33 GASKET	H6-57	-	H6-59	-



Take a look ...

GAUGE GLASS CUTTERS on page T16

Please order by No.

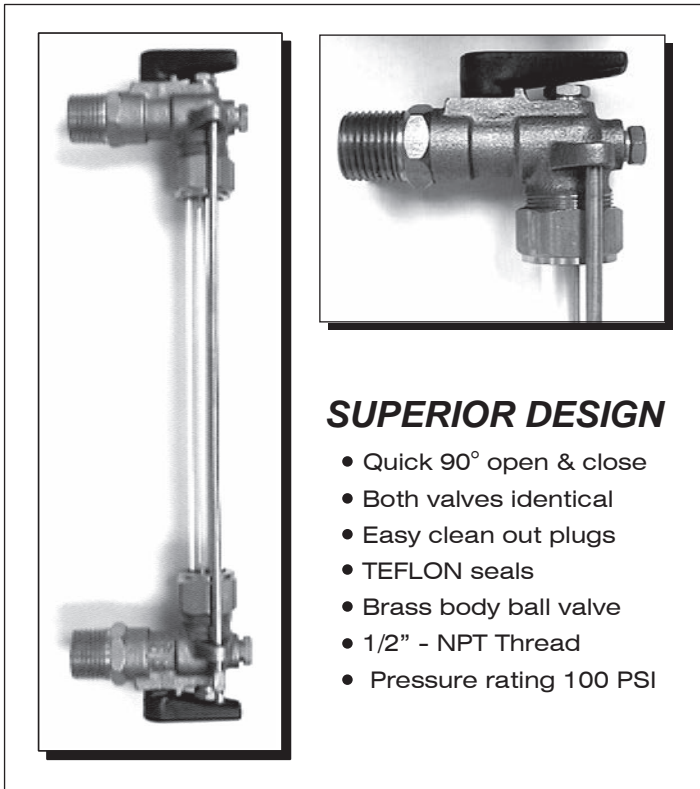

SUPERIOR DESIGN

- Quick 90° open & close
- Both valves identical
- Easy clean out plugs
- TEFLON seals
- Brass body ball valve
- 1/2" - NPT Thread
- Pressure rating 100 PSI

No. H7, -12

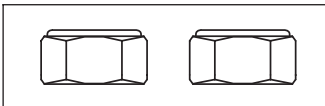

No. H7-15, -20

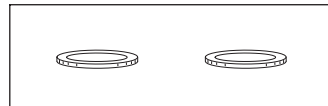

No. H7-21

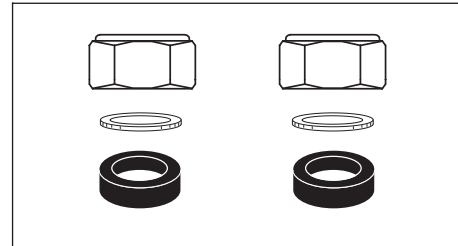

No. H7-17, -23

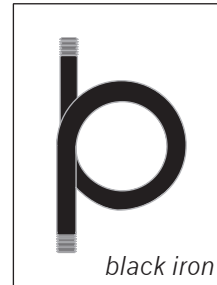

No. H7-50

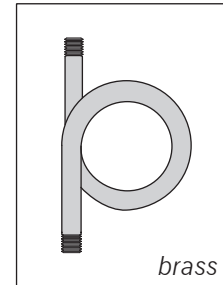

No. H7-52

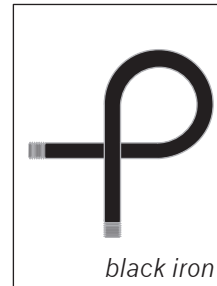

No. H7-55

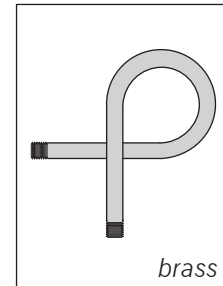

No. H7-57

STEAM BOILER PARTS

No.	Ref. No.	Description
H7	GV-22	Gauge Glass Set, 1/2"- NPT, w/Quick Open 90° Ball Valve, TEFLON Seals, Brass, w/10" rods
H7-12	-	Gauge Glass Set, 1/2"- NPT, w/Quick Open 90° Ball Valve, TEFLON Seals, Brass, w/12" rods & glass
H7-15	-	Gauge glass nut, special for H7 and H7-12, package of 2
H7-17	-	Repair Kit for H7 and H7-12, (2) ea. of nuts, friction washers, standard gauge glass washers
H7-20	-	Gauge glass nut, general replacement (not for H7 and H7-12), package of 2
H7-21	-	Gauge glass nut friction washer, universal replacement, package of 6
H7-23	-	Repair Kit, general replacement (not for H7 and H7-12), (2) ea. of nuts, friction washers, standard gauge glass washers
H7-50	-	Straight steam pig tail, black iron, 1/4"-NPT
H7-52	-	Straight steam pig tail, brass, 1/4"-NPT
H7-55	-	90° angle steam pig tail, black iron, 1/4"-NPT
H7-57	-	90° angle steam pig tail, brass, 1/4"-NPT

Westwood CIRCULATOR & FEEDER PARTS

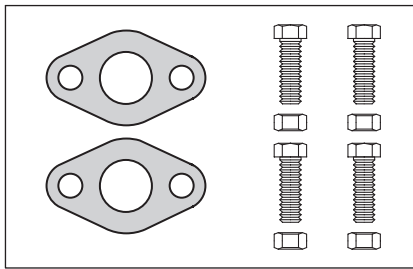

No. H10

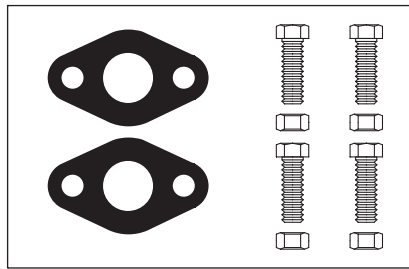

No. H10-1

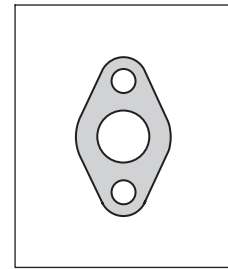

No. H15, -1

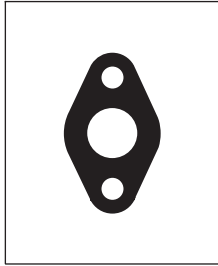

No. H16, -1

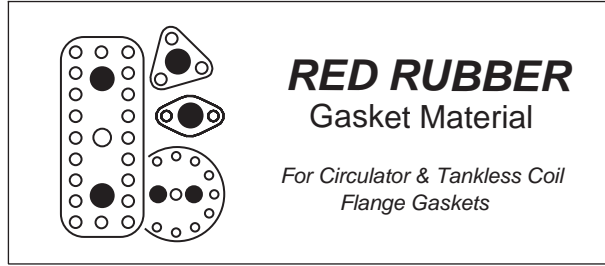

No. H21, -1

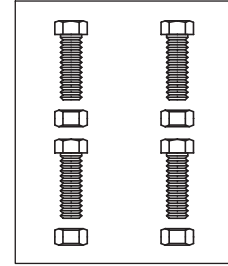

No. H22, -1

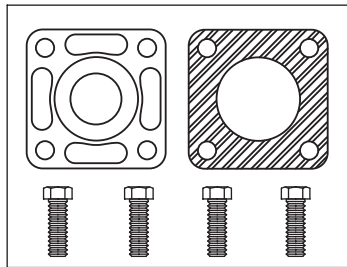

No. H23

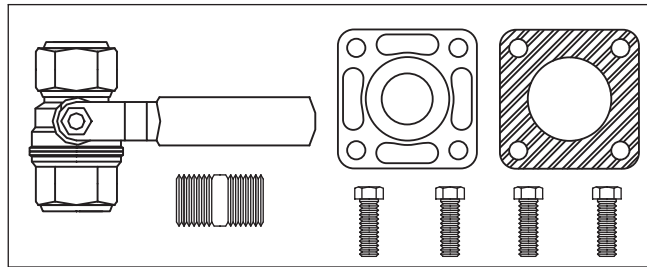

No. H23-1

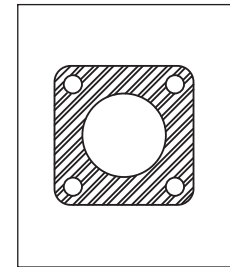



No. H23-4, -6

BOILER, CIRCULATOR, FEEDER PARTS

No.	Ref. No.	Description
H10	-	Circulator Flange Gasket Kit, (2) - RED rubber flange gaskets, (4) - 7/16"X1-3/4" bolts w/nuts
H10-1	-	Circulator Flange Gasket Kit, (2) - BLACK neoprene flange gaskets, (4) - 7/16"X1-3/4" bolts w/nuts
H15	-	Taco RED rubber flange gasket, package of 10 gaskets
H15-1	-	Taco RED rubber flange gasket, package of 100 gaskets
H16	-	Taco BLACK neoprene flange gasket, package of 10 gaskets
H16-1	-	Taco BLACK neoprene flange gasket, package of 100 gaskets
H21	-	Flange Gasket Material, Red Rubber, 1/8" Thick X 12" X 24" Sheet
H21-1	-	Flange Gasket Material, Red Rubber, 1/8" Thick X 18" X 36" Sheet
H21-36	-	Flange Gasket Material, Red Rubber, 1/8" Thick X 36" X 50' Roll
H22	-	B&G (small), Taco, Modern Flange Nuts and Bolts, (4) - 7/16" X 1-3/4"
H22-1	-	B&G (large) Flange Nuts and Bolts, (4) - 1/2" X 1-3/4"
H23	-	Dirt pocket cap for McDonnell & Miller (3/4"- NPT) w/gasket and (4) bolts
H23-1	-	Blow Down Kit for McDonnell & Miller (dirt pocket cap, full flow ball valve, nipple, gasket, (4) bolts
H23-4	-	Dirt pocket cap gasket, package of 10 gaskets
H23-6	-	Dirt pocket cap gasket, package of 100 gaskets

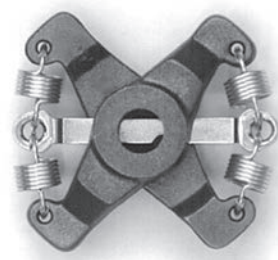
Westwood COUPLINGS FOR B & G CIRCULATORS

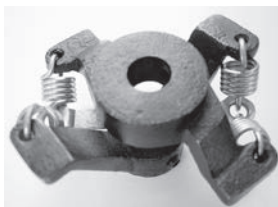
W/P No.	Ref. No.	Replaces B&G No.	Circ. HP	Description and Representative Picture
H24-10	PD-40	118705 (PZ-4291)	1/12, 1/6	Cast zinc, steel eyelet inserts, standard duty springs, for 1/2" shaft, individually boxed 
H24-15	JK-52	118705 (PZ-4291)	1/12, 1/6	Cast iron, heavy duty cross bar, springs reinforced, for 1/2" shaft, individually boxed 
H24-40	BG-33	118705 (PZ-4291)	1/12, 1/6	FLEXI-LINK spiral spring shock absorbing coupling, no moving parts, compensates for misalignment, quieter operation, for 1/2" shaft, individually bagged 
H24-60	WRM-858	118723 (PZ-12291)	1/4, 1/3	Cast iron, heavy duty cross bar, heavy duty springs, for 1/2" shaft, individually bagged 
H24-62	WRM-798	118473 (PDZ-12291)	1/2, 3/4	Cast iron, heavy duty cross bar, heavy duty springs, for 1/2" shaft, individually bagged 

 Take a look . . .

More parts for CIRCULATORS on page H4

H5

rev. 5-1-07

Please order by  No.



 No. H24-30
Model 10010
1/2" x 1/2" Shafts

 No. H24-31
Model 10010HD
1/2" x 1/2" Shafts
(Heavy Duty)



The Single Spring Alternative!

Spiralink™ Coupling Cross Reference Chart





 No. H24-32
Model 10023
1/2" x 1/2" or
1/2" x 5/8" Shafts



 No. H24-34
Model 10034
1/2" x 5/8" or
5/8" x 5/8" Shafts



 No. H24-36
Model 10045
1/2" x 1/2" or
1/2" x 5/8" or
5/8" x 5/8" Shafts

 No.	Spiralink Model	Circulator Model		Motor		Shaft Dia.	OEM Part No.		
		B & G	Armstrong	HP	Rot		B & G	Armstrong	
H24-30	10010	75	S-25	1/12	CCW	1/2 x 1/2	118705 or 189110	806026	
		100							
		125							
		150							
		1-1/2"	S-34	1/6					
		2"	S-35						
		2-1/2" LD3	S-45	1/4			118723	806168	
		HV1"	H-32	1/6			118705 or 189110	806026	
		HV1-1/4"							
		HV1-1/2"							
1" PR	H-41								
H24-31	10010HD	HD3	S-46	1/3					
H24-32*	10023	PD-35	S-55	1/2	1/2 x 1/2 or 1/2 x 5/8	118473 or 118708 or 09	807436 or 806137		
		PD-37	S-57	3/4					
H24-34*	10034	PD-38	S-60	1	1/2 x 5/8 or 5/8 x 5/8	118476 or P77271	812734 or 816665		
		PD-39							
H24-32*	10023	OLD NEW			CW	1/2 x 1/2 or 1/2 x 5/8	118473 or 118709 or P77234	807436 or 806137	
		60-1	60-11	H-51					1/4
		60-2		H-52					1/3
		60-3	60-13	H-53					1/2
		60-4	60-14	H-54					3/4
		60-5	60-15	H-63					1/2
H24-34*	10034	60-6	60-16	H-64	3/4	1/2 x 5/8 or 5/8 x 5/8	186410 or P77237 118476 or P77271	812734 or 816665	
		60-8		H-66					
			60-17	H-65	1				
			60-19	H-67					
H24-32*	10023	Series 1522 1S & 1T thru 17S & 17T		1/4 thru 1/2	1/2 x 1/2 or 1/2 x 5/8	118473 or 118709			
H24-36*	10045	Taco Model	121		CCW	1/2 x 1/2 or 1/2 x 5/8 or 5/8 x 5/8	1624-053RP (Woods 3J or 4J)		
			122	1/4					
			131	1/3					
			132	1/2					
			133	3/4					
			138	1					

* Comes with appropriate bushing(s) for use with shaft sizes indicated

ROTATION INFORMATION

For purposes of this cross-reference, rotation is determined by viewing the motor with the shaft pointing away. In the case of a three phase motor, or a motor that has been repaired, make sure to check motor rotation before installing a new coupling. Running a coupling in the wrong rotation will severely damage the coupling!

GUARANTEE

Spiralink™ couplings are warranted for life when correctly installed in the appropriate circulating pump. If a Spiralink™ coupling should ever fail, simply return it to your place of purchase to receive a free replacement.

Please order by  No.

HYDRONIC GAUGES

Tridicator, Steam, Combination, Altitude, Temperature

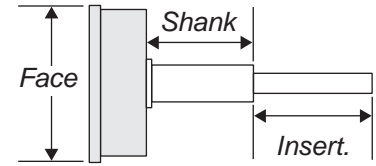

Dimensions and range specifications may vary slightly from those shown

W/P No.	Ref. No.	Type	Mount	Face	Shank	Insert.	Range / Description	Representative Picture
H25	PTA-224C	Tridicator	1/4" CBM	2-5/8"	7/8"	1"	70°- 320°F, 20°- 160°C 0 - 75 PSI, 0 -170 Ft H ₂ O	
H25-1	PTA-234C		1/4" CBM	2-1/2"	2"	1"		
H25-2	PTA-322C		1/2" CBM	3-1/4"	1-1/4"	1-1/8"		
H25-3	PTA-322L		1/2" LM	3-1/4"	1"	3/4"		
H25-10	5495	Steam gauge	1/4" LM	3-1/2"	-	-	30" Hg. - 30 PSI	
H25-12	5549		1/4" LM	4-1/2"	-	-	30" Hg. - 30 PSI	
H25-15	135393	PT 1088	1/4" CBM	2-1/2"	2"	1-5/8"	70°- 320°F, 75 PSI	
H25-16	135392	Combination	1/4" CBM	2-1/2"	.79"	1.73"	60°- 320°F, 75 PSI	
H25-17	144435	temperature	1/2" LBM	4-1/4"	1-3/4"	2"	60°- 260°F, 50 PSI	
H25-18	144434	and pressure	1/2" LM	4-1/4"	1-1/8"	2"	60°- 260°F, 75 PSI	
H25-19	144826	gauge	1/2" LM	4-1/4"	1-1/8"	2"	80°- 320°F, 200 PSI	
H25-20	144827		1/2" LBM	4-1/4"	1-3/4"	2"	70°- 320°F, 200 PSI	
H25-30	46775	Altitude &	1/4" LM	3-1/2"	-	-	100 PSI, 0 - 231 FT	
H25-31	11498	water level	1/4" LM	4-1/2"	-	-	100 PSI, 0 - 231 FT	
H25-35	11937	gauge	1/4" LM	4-1/2"	-	-	0 - 390 FT	
H25-50 ¹	T-571	Hot water	1/2" LM	-	1-5/8"	1-3/8"	40°- 280°F, Vertical	
H25-51 ²	T-571 Brass	glass tube	1/2" LM	-	1-1/8"	1-3/8"	40°- 260°F, Vertical	
H25-52 ¹	HWT-A	thermometer	1/2" LBM	-	1-1/8"	1-3/8"	40°- 280°F, Vertical	
H25-53 ²	T-572 Brass		1/2" LBM	-	1-1/8"	1-3/8"	40°- 280°F, Vertical	
H25-54	T-1050	Hot water thermometer	1/2" LM	3-1/2"	1"	2"	60°- 260°F	
H25-90 ³	HWT-D	Dial	CBM	2-1/2"	3/4"	1-1/4"	32°- 248°F	
H25-92 ⁴	-	Thermometer	CBM	2-1/2"	-	2"	32°- 248°F	
H25-96 ⁵	-		CBM	2-1/2"	-	-	0°- 250°F	

¹ Steel immersion well

² Brass immersion well

³ 1/2"- NPT(M) pipe mount (pictured at right)

⁴ 3/4" CWT sweat mount (detachable mount soldered in place)

⁵ Surface mount (retaining spring for mounting included)

CBM = Center back mount

LBM = Low back mount

LM = Low mount (bottom)

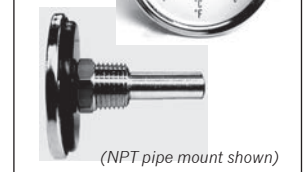

MORE GAUGES in Service Supplies Section starting on page S10

H7

Please order by No.

MISC. PARTS & IMMERSION WELLS

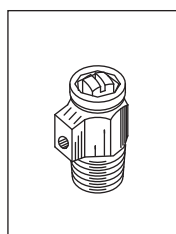

No. H30

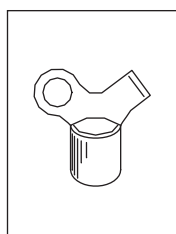

No. H30-1

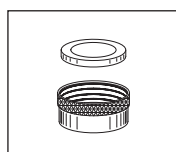

No. H31

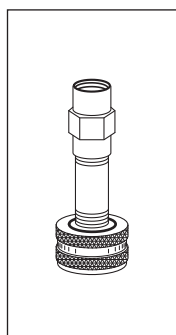

No. H35

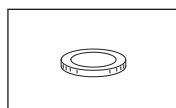

No. H31-1

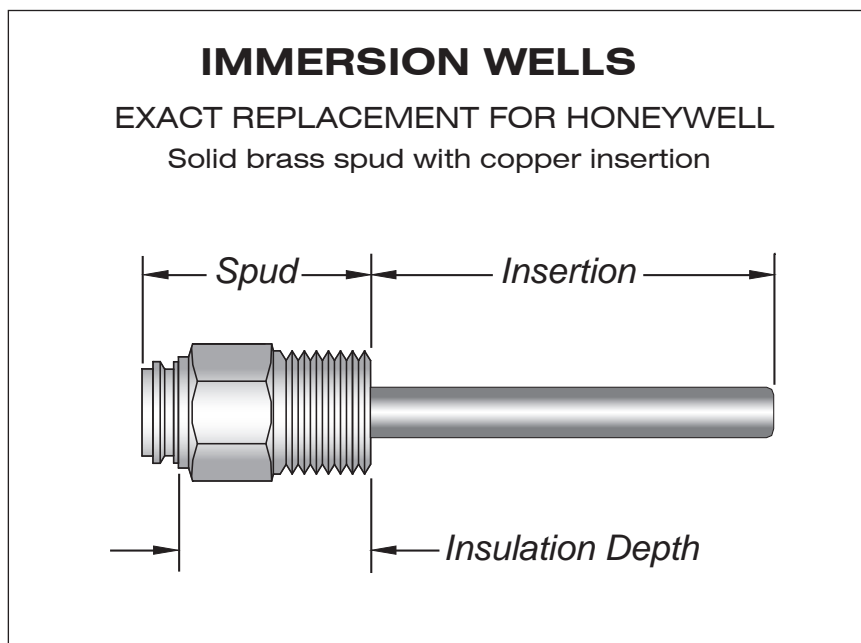

No. H50 (Series)

RADIATOR VENT & KEY, HOSE CAP, HOSE ADAPTOR

No.	Thread Size	Description	QTY PKG
H30	1/8" - NPT	Radiator bleed valve, plated finish, coin/key/screwdriver operated	6
H30-1	-	Radiator bleed key, square socket and screwdriver	6
H31	Garden hose (F)	Garden hose cap, brass with washer	10
H31-1	-	Garden hose washer only	10
H35	Garden hose (F) x 1/4" - NPT (F or M)	Gauge adaptor for measuring water pressure	1

IMMERSION WELLS - Brass spud, copper insertion

No.	Replaces Honeywell	Pipe Size (Male NPT)	Insertion Diameter	Insertion Length	Insulation Depth (ins.)	Comments
H50	121371A 123869A	1/2"	3/8"	3"	1-1/2"	Used with: L4006, L6006, L8124, L8148, R8182D, E, F
H50-1	121371B 123870A	3/4"	3/8"	3"	1-1/2"	Used with: L4006, L6006, L8124, L8148, R8182D, E, F
H50-2	122555A	3/4"	3/8"	3"	4-1/2"	Long spud for water heaters
H50-3	122555E	3/4"	3/8", 5/8"	3"	4-1/2"	Plastic sleeve on insertion
H50-4	121371M	3/4"	3/8"	3"	3"	Long spud for water heaters
H50-5	121371L	1/2"	3/8"	3"	3"	Long spud for water heaters

COMPLETE REPLACEMENT PROBE KITS (Kits contain 1 each of Probe A, B, C, D)

New
Part Numbers
Added!

W/P No.	Ref. No.	Boiler Description	Thread (NPT)	Kit Contains			
				Probe A	Probe B	Probe C	Probe D
H75	FP3-M1	Miniature, 2 & 4 HP (prior to April 5, 1965)	3/8"	H75-850	H75-1000	H75-1125	H75-1200
H75-1	FP3-R1	Regular, 6 to 30 HP (prior to Aug. 1, 1964)	3/8"	H75-625	H75-825	H75-975	H75-1325
H76	FP2-M2	Miniature, 2 & 4 HP (after April 5, 1965)	1/2"	H76-950	H76-1100	H76-1225	H76-1300
H76-1	FP2-R2	Regular, 6 to 30 HP (after Aug. 1, 1964)	1/2"	H76-725	H76-925	H76-1075	H76-1425
H76-2	FP2-E1	Series E, 4 HP	1/2"	H76-950	H76-1100	H76-1225	H76-1300
H76-3	FP2-E2	Series E, 6 to 100 HP	1/2"	H76-725	H76-925	H76-1075	H76-1625
H76-4	-	Oil/Gas fired steam, 4 HP	1/2"	H76-525	H76-725	H76-925	H76-1712
H76-5	-	Oil/Gas fired steam, 6 to 100 HP	1/2"	H76-725	H76-925	H76-1125	H76-1712
H76-6	-	Electric steam, 1.2 to 3.6 HP	1/2"	H76-950	H76-1050	H76-1150	H76-1150
H76-7	-	Electric steam, 5 to 20 HP	1/2"	H76-1150	H76-1300	H76-1500	H76-1500
H76-8	-	Electric steam, 30 to 100 HP	1/2"	H76-725	H76-925	H76-1125	H76-1600
H76-9	-	Pulse VLP, 750kBtu to 1,150kBtu	1/2"	H76-700	H76-800	H76-900	H76-1950
H76-10	-	VMP, 40 to 150 HP	1/2"	H76-725	H76-925	H76-1125	H76-400

INDIVIDUAL REPLACEMENT PROBES

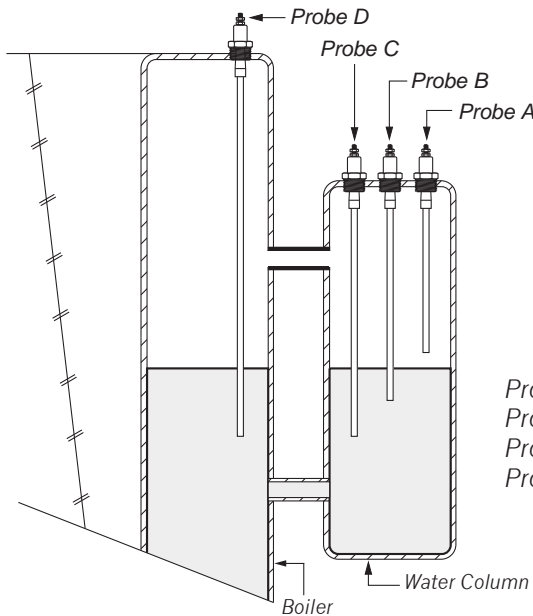
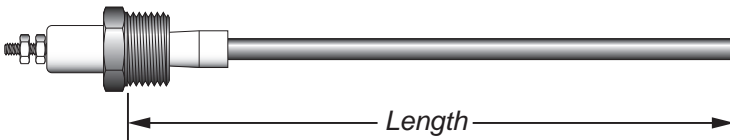

Probe A - Pump off
 Probe B - Pump on
 Probe C - LWC in water column
 Probe D - LWC in boiler

3/8" - NPT	
W/P No.	Length
H75-625	6-1/4"
H75-825	8-1/4"
H75-850	8-1/2"
H75-975	9-3/4"
H75-1000	10"
H75-1125	11-1/4"
H75-1200	12"
H75-1325	13-1/4"

1/2" - NPT	
W/P No.	Length
H76-400	4"
H76-525	5-1/4"
H76-700	7"
H76-725	7-1/4"
H76-800	8"
H76-900	9"
H76-925	9-1/4"
H76-950	9-1/2"
H76-1050	10-1/2"
H76-1075	10-3/4"
H76-1100	11"
H76-1125	11-1/4"
H76-1150	11-1/2"
H76-1225	12-1/4"
H76-1300	13"
H76-1425	14-1/4"
H76-1500	15"
H76-1600	16"
H76-1625	16-1/4"
H76-1712	17-1/8"
H76-1950	19-1/2"



MORE LIQUID LEVEL PROBES on pages E22 - E23

BRAZED PLATE HEAT EXCHANGERS

For radiant heating, domestic hot water, snow melting, heat zoning, fuel pre-heating, and general shell & tube replacement

Westwood

TRANS * TEMP™

- ▶ All 316 Stainless Steel with copper brazing
- ▶ Maximum pressure 450 PSI, temperature 365° F
- ▶ UL Listed (US and Canada), CSA Approved
- ▶ Mounting brackets and insulation kits available



GENERAL APPLICATION Many more sizes and styles available. Consult the factory for detailed specifications

 No.	No. of Plates	BTUH (1,000's)*				Pipe Connections (Male NPT)	Approximate Dimensions & Weight			
		Radiant Heat	Heat Zoning	Domestic Hot Water	Snow Melting		Height (in.)	Width (in.)	Depth (in.)	Weight (lbs.)
H101-10	10	38	38	113	50	3/4"	8	2-7/8	1-1/2	2.8
H101-14	14	52	53	155	70	3/4"	8	2-7/8	1-7/8	3.2
H101-20	20	72	73	220	98	3/4"	8	2-7/8	2-3/8	3.8
H101-30	30	103	103	310	140	3/4"	8	2-7/8	3-5/16	5.0
H103-14	14	85	87	255	115	1"	6-3/4	4-7/8	1-7/8	4.5
H103-20	20	120	122	360	160	1"	6-3/4	4-7/8	2-3/8	5.3
H103-40	40	230	229	685	310	1"	6-3/4	4-7/8	4-1/4	7.8
H104-10	10	41	41	122	55	1"	13	4-7/8	1-1/2	6.2
H104-14	14	57	58	170	76	1"	13	4-7/8	1-7/8	7.2
H104-24	24	97	97	290	130	1"	13	4-7/8	2-3/4	9.8
H104-30	30	120	122	360	160	1"	13	4-7/8	3-5/16	11.4
H104-50	50	195	195	585	260	1"	13	4-7/8	5-1/4	16.6

* Ratings @ temperatures shown in Table 1 on next page.

DOUBLE WALL VENTED - Protects against cross fluid contamination

 No.	No. of Plates	BTUH (1,000's)*				Pipe Connections (Male NPT)	Approximate Dimensions & Weight			
		Radiant Heat	Heat Zoning	Domestic Hot Water	Snow Melting		Height (in.)	Width (in.)	Depth (in.)	Weight (lbs.)
H105-14	14	48	50	147	66	1"	20-7/8	4-7/8	1-7/8	11.8
H105-20	20	70	71	210	95	1"	20-7/8	4-7/8	2-3/8	15.0
H105-30	30	105	106	310	140	1"	20-7/8	4-7/8	3-5/16	20.3
H105-50	50	170	171	510	230	1"	20-7/8	4-7/8	5-1/4	31.0
H105-80	80	255	260	770	340	1"	20-7/8	4-7/8	8	47.0
H105-100	100	300	305	910	410	1"	20-7/8	4-7/8	10	57.5

* Ratings @ temperatures shown in Table 1 on next page.

Please order by  No.

rev. 1-1-09

H10

BRAZED PLATE HEAT EXCHANGERS (CONTINUED)

HIGH CAPACITY

 No.	No. of Plates	BTUH (1,000's)*				Pipe Connections (Male NPT)	Approximate Dimensions & Weight			
		Radiant Heat	Heat Zoning	Domestic Hot Water	Snow Melting		Height (in.)	Width (in.)	Depth (in.)	Weight (lbs.)
H107-20	20	265	270	785	350	2"	20-7/8	10-5/8	2-3/8	38.6
H107-24	24	310	320	940	420	2"	20-7/8	10-5/8	2-3/4	43.8
H107-30	30	380	390	1,150	520	2"	20-7/8	10-5/8	3-5/16	51.8
H107-40	40	500	508	1,500	670	2"	20-7/8	10-5/8	4-1/4	65.0
H107-50	50	590	602	1,785	800	2"	20-7/8	10-5/8	5-1/4	78.2
H107-60	60	685	680	2,000	920	2"	20-7/8	10-5/8	6-3/16	91.4
H107-100	100	885	885	2,600	1,200	2"	20-7/8	10-5/8	10	144.2
H107-120	120	930	925	2,750	1,270	2"	20-7/8	10-5/8	11-7/8	170.6
H107-150	150	960	950	2,850	1,330	2"	20-7/8	10-5/8	14-3/4	210.2

* Ratings @ temperatures shown in Table 1.

AEROFLEX PRESSURE SENSITIVE INSULATION KITS

No. of Plates	Heat Exchanger Series				
	H101	H103	H104	H105	H107
10	H111-10	—	H114-10	—	—
14	H111-14	H113-14	H114-14	H115-14	—
20	H111-20	H113-20	—	H115-20	H117-20
24	—	—	H114-24	—	H117-24
30	H111-30	—	H114-30	H115-30	H117-30
40	—	H113-40	—	—	H117-40
50	—	—	H114-50	H115-50	H117-50
60	—	—	—	—	H117-60
80	—	—	—	H115-80	—
100	—	—	—	H115-100	H117-100
120	—	—	—	—	H117-120
150	—	—	—	—	H117-150



Many more sizes and styles of heat exchangers are available. Call for more information.

TABLE 1 - Temperatures for BTUH ratings shown

Heat Exchanger Connected to	Heat Exchanger			
	Input Side (boiler)		Output Side ¹	
	In	Out	In	Out
Radiant Heat	180°F	140°F	90°F	110°F
Heat Zoning	180°F	160°F	150°F	170°F
Domestic Hot Water	180°F	120°F	60°F	120°F
Snow Melting ²	180°F	140°F	100°F	130°F

¹Output side pressure drop ≈ 2 psi

²40% Glycol in melt loop

NOTE

The heat exchanger BTUH ratings shown are very conservative, and were derived using familiar system temperatures, flow rates, and pressure drops.

For each heat exchanger, the BTUH output can be greatly increased by choosing different system design temperatures and increasing flow rates.

MAX-DRIVE

V-BELTS

OIL & HEAT RESISTANT

Rugged polyester cord and neoprene construction with specially treated natural and synthetic elastomeric compounds make the **MAX-DRIVE** V-belt the ideal choice for heavy loads under extreme heat or for constant exposure to oil.

When replacing a V-belt, always clean pulley grooves and check that shafts are parallel and pulley alignment is correct.

Standard V-Belt Types

	3L	4L	5L
W	3/8"	1/2"	21/32"

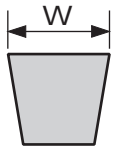

Outside Length (inches)	 No.		
	3L	4L	5L
20	S30-20	S40-20	-
21	S30-21	S40-21	-
22	S30-22	S40-22	-
23	S30-23	S40-23	S50-23
24	S30-24	S40-24	S50-24
25	S30-25	S40-25	S50-25
26	S30-26	S40-26	S50-26
27	S30-27	S40-27	S50-27
28	S30-28	S40-28	S50-28
29	S30-29	S40-29	S50-29
30	S30-30	S40-30	S50-30
31	S30-31	S40-31	S50-31
32	S30-32	S40-32	S50-32
33	S30-33	S40-33	S50-33
34	S30-34	S40-34	S50-34
35	S30-35	S40-35	S50-35
36	S30-36	S40-36	S50-36
37	S30-37	S40-37	S50-37
38	S30-38	S40-38	S50-38
39	S30-39	S40-39	S50-39

Outside Length (inches)	 No.		
	3L	4L	5L
40	S30-40	S40-40	S50-40
41	S30-41	S40-41	S50-41
42	S30-42	S40-42	S50-42
43	S30-43	S40-43	S50-43
44	S30-44	S40-44	S50-44
45	S30-45	S40-45	S50-45
46	S30-46	S40-46	S50-46
47	S30-47	S40-47	S50-47
48	S30-48	S40-48	S50-48
49	S30-49	S40-49	S50-49
50	S30-50	S40-50	S50-50
51	S30-51	S40-51	S50-51
52	S30-52	S40-52	S50-52
53	S30-53	S40-53	S50-53
54	S30-54	S40-54	S50-54
55	S30-55	S40-55	S50-55
56	S30-56	S40-56	S50-56
57	S30-57	S40-57	S50-57
58	S30-58	S40-58	S50-58
59	S30-59	S40-59	S50-59
60	S30-60	S40-60	S50-60



SPECIAL FOR LENNOX BURNER

 No.	Ref. No.	Lennox Burner No.	Belt Type	Outside Length
S20-16	VB-1049	DV-1049	2L - Cogged	16"

Westwood ceramic fibre chambers

SOUND ABSORBING • RED HOT IN SECONDS • FIRES DRY • 2,300° - 3,000°F

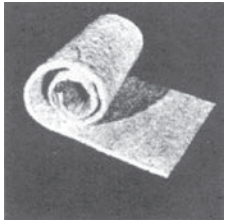

WET COMBUSTION CHAMBER LINERS - Sealed in a plastic bag and individually boxed*

 No.	Ref. No.	Type		GPH	Description and Representative Picture	
S70-9 S70-10 S70-11 S70-12 S70-13 S70-15	#9 #10 #11 #12 #13 #15	Wet	Westwood Round - Preshaped	.50 - .75	9" diameter, 12" high	
				.85 - 1.00	10" diameter, 12" high	
				1.10 - 1.25	11" diameter, 12" high	
				1.35 - 1.50	12" diameter, 12" high	
				1.65 - 1.85	13" diameter, 14" high	
				2.00 - 2.50	15" diameter, 14" high	
S70-25 S70-27	#135 #200	Wet	Westwood Rect. - Preshaped	.75 - 1.35	14" x 11" x 12"	
				1.35 - 2.00	14" x 12" x 12"	
S70-30 S70-35 S70-40 S70-45	#1 #2 #3 #4	Wet	Westwood Flat sheet(s)	1.25	(1) - 14" x 48"	
				2.50	(1) - 14" x 48" (1) - 16" x 16"	
				2.65	(1) - 16" x 48" (1) - 16" x 16"	
				1.25	(1) - 16" x 48"	

*Wet chambers have a shelf life and should be ordered such that they are not held in inventory longer than 6 months.

J-M Cerafelt™ Dry Refractory Liners

DRY COMBUSTION CHAMBER LINERS

 No.	Ref. No.	Type		GPH	Description and Representative Picture	
S70-50 S70-51 S70-53	141608 141612 -	Dry	Cerafelt blanket	-	1/4" x 16" x 8 ft.	
				-	1/4" x 16" x 12 ft.	
				-	1/4" x 48" x 20 ft.	
S70-60	SS Kit	Dry	Cerafelt SS Kit (For lining burned out stainless steel combustion chambers)	.50 - 1.75	(1) - 14" x 48" (1) - 16" x 33" (8) - Stainless Steel Clips	

Westwood

HIGH TEMPERATURE ROPE

NON-ASBESTOS • KNITTED FIBERGLASS

This strong, flexible, resilient knit-braided rope is ideal for industrial boilers, cast iron boilers, wood burning stoves, ovens, and furnaces. Will not "bloom" or untwist like braided twisted glass rope. Made of 100% texturized fiberglass, it will not burn or support combustion. Resists temperatures to 1,000° F.

**NON-ASBESTOS HIGH TEMPERATURE ROPE**

 No.	Type	Description	Length
S70-101	Round	1/4" diameter	10 ft.
S70-102	Round	1/4" diameter	25 ft.
S70-104	Round	3/8" diameter	10 ft.
S70-106	Round	3/8" diameter	25 ft.
S70-108	Round	1/2" diameter	10 ft.
S70-110	Round	1/2" diameter	25 ft.
S70-111	Round	3/4" diameter	10 ft.
S70-112	Round	3/4" diameter	25 ft.
S70-114	Round	1" diameter	10 ft.
S70-116	Round	1" diameter	25 ft.
S70-140	Flat	1" wide x 1/8" thick	25 ft.
S70-142	Flat	1" wide x 1/8" thick with adhesive backing	100 ft.
S70-150	Flat	2" wide x 1/8" thick	25 ft.
S70-152	Flat	2" wide x 1/8" thick with adhesive backing	100 ft.

Other types and sizes of high temperature materials are available on special order. Consult the factory for price and availability.

BECKETT BURNER FLANGE GASKET

 No.	Description
S70-170	Gasket for Beckett and Aero burner flange 8-1/2" OD x 3-5/16" ID

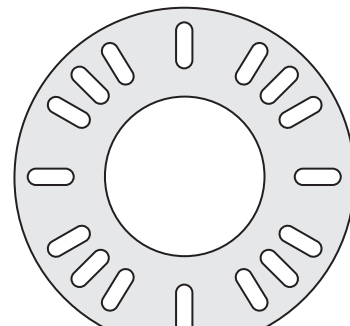

Westwood

ONE PIECE MOTOR COUPLINGS

HEAVY DUTY FOR GENERAL USE ON BURNERS AND MOTOR DRIVEN EQUIPMENT



Rugged, precision machined end pieces are held in place by heavy steel collars. Set screws at each end insure that there is no slippage on the shaft flats. Quiet, noise and vibration absorbing, these premium couplings out-perform conventional couplings where misalignment exists or where punishing service is the norm. Available for 1/2" x 7/16" and 1/2" x 5/16" shaft sizes, or 7/16" shaft x spline socket.

ONE PIECE COUPLINGS

Length	 No.		
	1/2" x 7/16"	1/2" x 5/16"	7/16" x Spline
2"	S80-200*	S81-200*	-
2-3/8"	S80-237	S81-237*	-
2-1/2"	S80-250*	S81-250*	-
3"	S80-300*	S81-300*	S82-300*
3-1/4"	S80-325	S81-325*	S82-325
3-3/8"	S80-337	S81-337*	S82-337
3-1/2"	S80-350*	S81-350	S82-350
4"	S80-400*	S81-400	S82-400*
4-1/2"	S80-450*	S81-450	S82-450
5"	S80-500	S81-500	S82-500*
5-1/2"	S80-550	S81-550	S82-550
6"	S80-600	S81-600	S82-600
6-1/2"	S80-650	S81-650	S82-650
7"	S80-700	S81-700	S82-700
7-1/2"	S80-750	S81-750	S82-750
8"	S80-800	S81-800	S82-800

* Included in One Piece Coupling Kit No. S83-200, shown below

REDUCER BUSHING & COUPLING KIT

 No.	Ref. No.	Description
S83-10	Reducer Bushing	5/16" I.D. x 7/16" O.D. bushing
S83-200	1890	One piece coupling kit containing those couplings marked with an asterisk above, plus (6) S83-10 reducer bushings

Westwood
Nylo-Flex™ BURNER COUPLINGS

EASILY INSTALLED 3 PIECE COUPLING • NO SET SCREWS



Cut

Assemble

Chosen by top service professionals and original equipment (oem) burner manufacturers. Three piece design allows for custom fit in all installations.

Nylo-Flex™ COMPONENTS

 No.	Reference No.	Description and Representative Picture
S85-6	6" Nyloshaft	Nylo-Flex™ 6" Nyloshaft center piece
S85-10	10" Nyloshaft	Nylo-Flex™ 10" Nyloshaft center piece
S85-12	12" Nyloshaft	Nylo-Flex™ 12" Nyloshaft center piece
S85-15	15" Nyloshaft	Nylo-Flex™ 15" Nyloshaft center piece
S85-30	30" Nyloshaft	Nylo-Flex™ 30" Nyloshaft center piece
S85-100	Red End Fitting	Nylo-Flex™ 5/16" shaft size end piece, RED
S85-110	Blue End Fitting	Nylo-Flex™ 7/16" shaft size end piece, BLUE
S85-120	Black End Fitting	Nylo-Flex™ 1/2" shaft size end piece, BLACK
S85-130	TA	Nylo-Flex™ Torrington adapter, 1/2" shaft

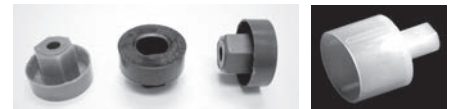

Nylo-Flex™ OEM SPEC COUPLINGS*

Two end pieces, plus a Nyloshaft correctly cut to OEM specs

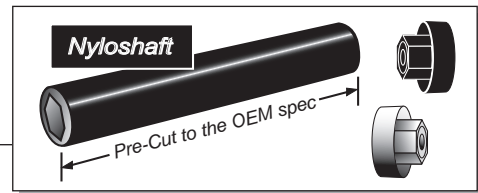

 No.	Description
S85-200	Nylo-Flex™ Pre-cut Coupling for Beckett AF (2454), 1/2" & 5/16" Ends, 3-13/32" Nyloshaft
S85-210	Nylo-Flex™ Pre-cut Coupling for Beckett (2290), 1/2" & 7/16" Ends, 2-7/8" Nyloshaft
S85-220	Nylo-Flex™ Pre-cut Coupling for Carlin 99-100 (99RA10208), 1/2" & 5/16" Ends, 2-3/16" Nyloshaft
S85-222	Nylo-Flex™ Pre-cut Coupling for Carlin (99RA5220), 1/2" & 7/16" Ends, 3-1/16" Nyloshaft
S85-223	Nylo-Flex™ Pre-cut Coupling for Carlin CRDA (1020J), 1/2" & 7/16" Ends, 2-3/4" Nyloshaft
S85-224	Nylo-Flex™ Pre-cut Coupling for Carlin 1020 (A Pump), 1/2" & 5/16" Ends, 2-11/32" Nyloshaft
S85-225	Nylo-Flex™ Pre-cut Coupling for Ducane (B1011503), 1/2" & 5/16" Ends, 3-13/16" Nyloshaft
S85-227	Nylo-Flex™ Pre-cut Coupling for Lennox (65A4101), 1/2" & 5/16" Ends, 3-5/8" Nyloshaft
S85-229	Nylo-Flex™ Pre-cut Coupling for Wayne E (13279), 1/2" & 5/16" Ends, 4-5/16" Nyloshaft
S85-230	Nylo-Flex™ Pre-cut Coupling for Wayne (13424), 1/2" & 5/16" Ends, 3-13/16" Nyloshaft
S85-231	Nylo-Flex™ Pre-cut Coupling for Wayne M, 1/2" & 5/16" Ends, 3-1/4" Nyloshaft

* Each coupling individually sealed in a plastic bag and labeled



Nylo-Flex™ COUPLING KITS on page S6

Please order by  No.

Westwood

Nylo-Flex™ BURNER COUPLINGS

THE WIDEST SELECTION TO MEET ALL SERVICING NEEDS

COUPLING KITS



No. S85-500



No. S85-525



No. S85-510



No. S85-550



No. S85-560

Nylo-Flex™ COUPLING KITS

No.	Ref. No.	Quantity of End Pieces			Nyloshaft Quantity & Length	S85-130 Torrington Adapter	T100-300 Coupler Popper™	T100-310 Coupling Cutter	Molded Plastic Box
		1/2"	7/16"	5/16"					
S85-500	#88	1	1	1	1 - 6"	-	-	-	-
S85-502	-	1	1	1	1 - 12"	-	-	-	-
S85-510	#99A	2	2	1	1 - 6"	-	-	-	-
S85-520	#101	2	1	2	1 - 6"	-	-	-	-
S85-525	-	8	6	5	6 - 6"	-	-	-	-
S85-530	#1240	16	8	8	8 - 9"	-	-	-	YES
S85-540	#1240C	16	8	8	8 - 9"	-	-	-	-
S85-550	#1242	16	8	8	8 - 9"	-	YES	YES	YES
S85-560	#1250	12	12	5	12 - 6"	5	-	-	-
S85-570	#1251	12	12	5	12 - 6"	5	YES	-	-

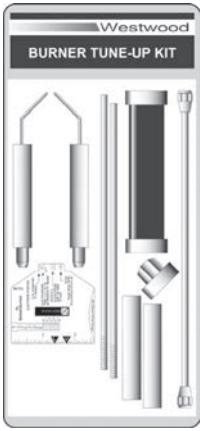

No. S88-14

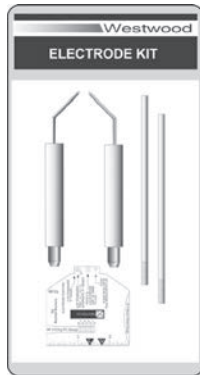

No. S88-20

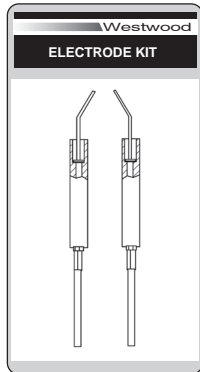

No. S88-36

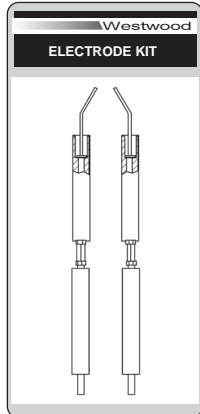

No. S88-38

Westwood BURNER TUNE-UP KITS

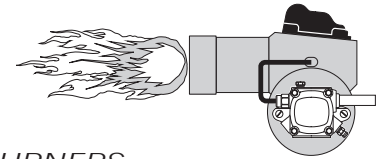

A REAL TIME SAVER FOR THE MOST POPULAR BURNERS

TUNE-UP & ELECTRODE KITS

No.	Ref. No.	Description
S88-10	BK5780	TUNE-UP KIT for Beckett AF, AFG, AR, SF, SR (up to 9" air tube) 2 - Electrode assemblies 1 - 12" oil line assembly 1 - Pump coupling kit S85-500 2 - Extension rods with nuts 1 - TG-99 tip setting gauge 2 - Hex connectors
S88-12	NBK5780	TUNE-UP KIT for Beckett AF, AFG, AR, SF, SR (up to 9" air tube) 2 - Electrode assemblies 1 - 12" oil line assembly 1 - Pump coupling kit S85-500 2 - Extension rods with nuts 1 - TG-99 tip setting gauge 1 - NAS gauge™ B-1 nozzle gauge 2 - Hex connectors
S88-14	BK5782	TUNE-UP KIT for Beckett AF, AFG, AR, SF, SR (over 9" air tube) 2 - Electrode assemblies 1 - 12" oil line assembly 2 - E5-2M4 insulators 1 - Pump coupling kit S85-500 2 - Extension rods with nuts 1 - TG-99 tip setting gauge 2 - Hex connectors
S88-16	NBK5782	TUNE-UP KIT for Beckett AF, AFG, AR, SF, SR (over 9" air tube) 2 - Electrode assemblies 1 - 12" oil line assembly 2 - E5-2M4 insulators 1 - Pump coupling kit S85-500 2 - Extension rods with nuts 1 - TG-99 tip setting gauge 1 - NAS gauge™ B-1 nozzle gauge 2 - Hex connectors
S88-20	W5780	ELECTRODE KIT for Beckett AF, AFG, SF, SR (up to 9" air tube) 2 - Electrode assemblies 2 - Extension rods with nuts 2 - Hex Connectors 1 - TG-99 tip setting gauge
S88-22	W5781	ELECTRODE KIT for Beckett A and S (up to 9" air tube) 2 - Electrode assemblies 2 - Extension rods with nuts 2 - Hex Connectors
S88-24	W5782	ELECTRODE KIT for Beckett AF, AFG, SF, SR (over 9" air tube) 2 - Electrode assemblies 2 - Extension rods with nuts 2 - Insulators 2 - Hex Connectors 1 - TG-99 tip setting gauge
S88-26	W5783	ELECTRODE KIT for Beckett AQ and S (over 9" air tube) 2 - Electrode assemblies 2 - Extension rods with nuts 2 - Insulators 2 - Hex Connectors
S88-28	W5940	ELECTRODE KIT for Beckett MB and MD (up to 9" air tube) 2 - Electrode assemblies 2 - Extension rods with nuts 2 - Hex Connectors 1 - TG-99 tip setting gauge
S88-32	51484U	ELECTRODE KIT for Beckett AF II, HLX (up to 9" air tube) 2 - Electrode assemblies 2 - Extension rods with nuts 2 - Hex Connectors 1 - TG-99 tip setting gauge
S88-34	51670U	ELECTRODE KIT for Beckett AF II, FBX (up to 9" air tube) 2 - Electrode assemblies 2 - Extension rods with nuts 2 - Hex Connectors 1 - TG-99 tip setting gauge
S88-36	BK-1	ELECTRODE KIT for Beckett AF, AFG, AR, SF, SR (up to 9" air tube) 2 - Beckett 1510 electrodes 2 - 3/16" x 6" buss bar rods 2 - 10-32 nuts 2 - Hex Connectors
S88-38	BK-2	ELECTRODE KIT for Beckett AF, AFG, AR, SF, SR (all size air tube) 2 - Beckett 1510 electrodes 2 - 3/16" x 13" buss bar rods 2 - E5-2M4 insulators 2 - 10-32 nuts 2 - Hex Connectors
S88-40		ELECTRODE KIT for Beckett CF500, CF800, up to 9" 2 - Electrode assemblies 1 - Instruction sheet

Packaging may vary from that shown

Please order by No.

Westwood

BURNER TUNE-UP KITS

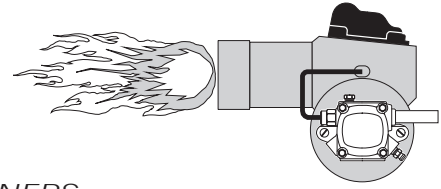

A REAL TIME SAVER FOR THE MOST POPULAR BURNERS
TUNE-UP & ELECTRODE KITS (Continued)

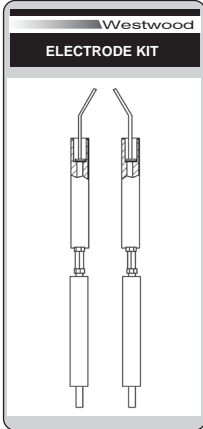

W/P No. **S88-38**



W/P No. **S88-74**



W/P No. **S88-78**

W/P No. **S88-80**

W/P No.	Ref. No.	Description
S88-42		ELECTRODE KIT for Beckett CF500, CF800, over 9"
		2 - Electrode assemblies 1 - Instruction sheet
S88-44		ELECTRODE KIT for Beckett CF1400, CF3500
		2 - Electrode assemblies
S88-46		ELECTRODE KIT for Beckett NX
		2 - Electrode assemblies 2 - Couplings 2 - Rod extensions 4-7/8" long 1 - Instructions 2 - Rod extensions 2-7/8" long
S88-48		ELECTRODE KIT for Beckett CF375
		2 - Electrode assemblies 1 - Instructions 2 - Support insulators
S88-50		TUNE-UP KIT for Carlin 98 - 102, Elite, 201CRD, 301CRD
		2 - Electrode assemblies 1 - Yellow tip setting gauge 1 - 12" oil line assembly 1 - Pump coupling kit S85-500 1 - Red tip setting gauge 1 - Instructions
S88-60	WMK-100	TUNE-UP KIT for Weil McLain burner
		1 - One piece electrode assembly 1 - Coupling 2 - Ignition cable leads 1 - Oil line assembly
S88-70	31156	TUNE-UP KIT for Wayne ER, ERA, EH, EHA, EHASR, M, MSR, MH, OE, OEA
		2 - Electrode stems 1 - Oil line assembly 2 - Electrode assemblies w/insul. 1 - Coupling 2 - Insulator bushings 1 - "J" pump coupling end 2 - Buss bars (8") 1 - 90° nozzle line flare elbow 1 - Buss bar support
S88-72	31156W	TUNE-UP KIT for Wayne ER, ERA, EH, EHA, EHASR, M, MSR, MH, OE, OEA Same components as S88-70, manufactured by Westwood
S88-74	31157	TUNE-UP KIT for Wayne Blue Angel model HS
		2 - Electrode assemblies w/buss bars 1 - Coupling 1 - Electrode support 1 - "J" pump coupling end 1 - Buss bar support 1 - 90° nozzle line flare elbow 1 - Oil line assembly 1 - Gun setting gauge
S88-76	31157W	TUNE-UP KIT for Wayne Blue Angel model HS Same components as S88-74, manufactured by Westwood
S88-78		TUNE-UP KIT for Wayne Blue Angel Plus model HS, up to 6"
		1 - Electrode assemblies w/buss bars 1 - Coupling 1 - Buss bar support 1 - 90° nozzle line flare elbow 1 - Oil line assembly 1 - Gun setting gauge
S88-80		TUNE-UP KIT for Wayne Blue Angel Plus model HS, over 6"
		1 - Electrode assemblies w/buss bars 1 - Coupling 1 - Buss bar support 1 - 90° nozzle line flare elbow 1 - Oil line assembly 1 - Gun setting gauge

S8

Packaging may vary from that shown

rev. 11-29-17

Please order by **W/P** No.



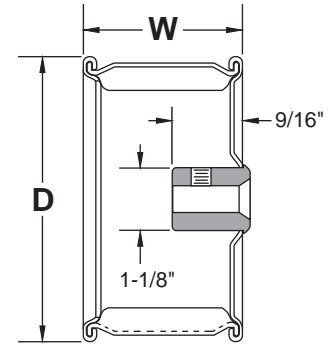

Westwood
BLOWER WHEELS

Precision balanced general purpose blower wheel ideal for oil burners. Blade strip is continuous and roll-locked front and back.





BLOWER WHEELS (Rotation as viewed from closed end)

CW		CCW		D	W	Fits shaft size	Comments
 No.	Ref. No.	 No.	Ref. No.				
STANDARD							
S90-10	4030	-	-	4"	3"	1/2"	
S90-12	4230	-	-	4-1/4"	3"	1/2"	
S90-14	4235	-	-	4-1/4"	3-1/2"	1/2"	
S90-16	4725	-	-	4-3/4"	2-1/2"	1/2"	
S90-18	4729	S91-18	4729-1	4-3/4"	3"	1/2"	
S90-20	4734	S91-20	4734-1	4-3/4"	3-1/2"	1/2"	
S90-22	5220	S91-22	5220-1	5-1/4"	2"	1/2"	
S90-24	5225	S91-24	5225-1	5-1/4"	2-1/2"	1/2"	
S90-26	5229	S91-26	5229-1	5-1/4"	3"	1/2"	
S90-28	5234	S91-28	5234-1	5-1/4"	3-1/2"	1/2"	
S90-30	5729	S91-30	5729-1	5-3/4"	3"	1/2"	
S90-32	5734	S91-32	5734-1	5-3/4"	3-1/2"	1/2"	
S90-34	5738	S91-34	5738-1	5-3/4"	3-7/8"	1/2"	
S90-36	6325	-	-	6-1/4"	2-1/2"	1/2"	
S90-38	6329	S91-38	6329-1	6-1/4"	3"	1/2"	
S90-40	6334	S91-40	6334-1	6-5/16"	3-1/2"	1/2"	
S90-42	6338	S91-42	6338-1	6-1/4"	3-7/8"	1/2"	
S90-44	6342	S91-44	6342-1	6-1/4"	4-1/4"	1/2"	
S90-46	6346	-	-	6-1/4"	4-5/8"	1/2"	
-	-	S91-48	7243-1	7"	4-1/4"	1/2"	
SPECIAL							
S90-60	475-243	-	-	4-3/4"	2-7/16"	1/2"	Outside hub
S90-62	475-287	-	-	5-3/4"	2-7/8"	1/2"	Lovejoy prongs
S90-64	575-287	-	-	5-3/4"	2-7/8"	1/2"	Lovejoy prongs
S90-66	625-400	-	-	6-1/4"	4"	1"	Cast hub
S90-68	951-78	-	-	7"	4-1/4"	5/8"	
S90-70	951-81	-	-	9-3/16"	5-1/4"	5/8"	Heavy braces
-	-	S91-72	951-170	9-3/16"	5-1/4"	7/8"	Heavy braces
-	-	S91-74	951-57	11-3/4"	6-1/4"	1-1/8"	Heavy braces

PRESSURE GAUGES





PRESSURE

 No.	Ref. No.	Mount	Face	Range	 No.	Ref. No.	Mount	Face	Range
S100-100	146010	1/8" CBM	1-1/2"	0-15 PSI	S100-142	47738	1/4" LM	2-1/2"	0-30 PSI
S100-102	146011	1/8" CBM	1-1/2"	0-30 PSI	S100-144	47495	1/4" LM	2-1/2"	0-60 PSI
S100-104	146013	1/8" CBM	1-1/2"	0-100 PSI	S100-146	45331	1/4" LM	2-1/2"	0-100 PSI
S100-106	49488	1/4" CBM	2"	0-30 PSI	S100-148	48365	1/4" LM	2-1/2"	0-160 PSI
S100-108	47615	1/4" LM	2"	0-15 PSI	S100-150	46913	1/4" LM	2-1/2"	0-200 PSI
S100-110	46644	1/4" LM	2"	0-30 PSI	S100-152	45765	1/4" LM	2-1/2"	0-300 PSI
S100-112	45764	1/4" LM	2"	0-60 PSI	S100-154	49611	1/4" LM	2-1/2"	0-400 PSI
S100-114	45330	1/4" LM	2"	0-100 PSI	S100-156	46648	1/4" LM	2-1/2"	0-600 PSI
S100-116	46912	1/4" LM	2"	0-160 PSI	S100-158	5504	1/4" LM	3-1/2"	0-30 PSI
S100-118	47101	1/4" LM	2"	0-200 PSI	S100-160	5506	1/4" LM	3-1/2"	0-60 PSI
S100-120	46778	1/4" LM	2"	0-300 PSI	S100-162	5508	1/4" LM	3-1/2"	0-100 PSI
S100-122	47492	1/4" LM	2"	0-400 PSI	S100-164	5510	1/4" LM	3-1/2"	0-160 PSI
S100-124	47493	1/4" LM	2"	0-600 PSI	S100-166	5512	1/4" LM	3-1/2"	0-200 PSI
S100-126	52420	1/8" LM	2"	0-15 PSI	S100-168	5514	1/4" LM	3-1/2"	0-300 PSI
S100-128	47490	1/8" LM	2"	0-30 PSI	S100-170	5515	1/4" LM	3-1/2"	0-400 PSI
S100-130	52576	1/8" LM	2"	0-60 PSI	S100-172	5516	1/4" LM	3-1/2"	0-600 PSI
S100-132	47491	1/8" LM	2"	0-100 PSI	S100-174	5551	1/4" LM	4-1/2"	0-60 PSI
S100-134	48302	1/8" LM	2"	0-160 PSI	S100-176	5554	1/4" LM	4-1/2"	0-100 PSI
S100-136	46645	1/8" LM	2"	0-200 PSI	S100-178	5561	1/4" LM	4-1/2"	0-200 PSI
S100-138	48363	1/8" LM	2"	0-300 PSI	S100-180	5563	1/4" LM	4-1/2"	0-300 PSI
S100-140	47102	1/4" LM	2-1/2"	0-15 PSI					

PRESSURE GAUGES - LIQUID FILLED - Stainless steel case



PRESSURE



 No.	Ref. No.	Mount	Face	Range	 No.	Ref. No.	Mount	Face	Range
S100-200	166664	1/8" CBM	1-1/2"	0-30 PSI	S100-238	165295	1/4" CBM	2"	0-1000 PSI
S100-202	166665	1/8" CBM	1-1/2"	0-60 PSI	S100-240	165296	1/4" LM	2-1/2"	0-30 PSI
S100-204	166666	1/8" CBM	1-1/2"	0-100 PSI	S100-242	165297	1/4" LM	2-1/2"	0-60 PSI
S100-206	166667	1/8" CBM	1-1/2"	0-160 PSI	S100-244	165298	1/4" LM	2-1/2"	0-100 PSI
S100-208	166668	1/8" CBM	1-1/2"	0-300 PSI	S100-246	165299	1/4" LM	2-1/2"	0-160 PSI
S100-210	166669	1/8" CBM	1-1/2"	0-1000 PSI	S100-248	165300	1/4" LM	2-1/2"	0-300 PSI
S100-212	165282	1/4" LM	2"	0-30 PSI	S100-250	165301	1/4" LM	2-1/2"	0-600 PSI
S100-214	165283	1/4" LM	2"	0-60 PSI	S100-252	165302	1/4" LM	2-1/2"	0-1000 PSI
S100-216	165284	1/4" LM	2"	0-100 PSI	S100-254	165377	1/4" LM	2-1/2"	0-2000 PSI
S100-218	165285	1/4" LM	2"	0-160 PSI	S100-256	165378	1/4" LM	2-1/2"	0-3000 PSI
S100-220	165286	1/4" LM	2"	0-300 PSI	S100-258	165303	1/4" CBM	2-1/2"	0-30 PSI
S100-222	165287	1/4" LM	2"	0-600 PSI	S100-260	165304	1/4" CBM	2-1/2"	0-60 PSI
S100-224	165288	1/4" LM	2"	0-1000 PSI	S100-262	165305	1/4" CBM	2-1/2"	0-100 PSI
S100-226	165289	1/4" CBM	2"	0-30 PSI	S100-264	165306	1/4" CBM	2-1/2"	0-160 PSI
S100-228	165290	1/4" CBM	2"	0-60 PSI	S100-266	165307	1/4" CBM	2-1/2"	0-300 PSI
S100-230	165291	1/4" CBM	2"	0-100 PSI	S100-268	165308	1/4" CBM	2-1/2"	0-600 PSI
S100-232	165292	1/4" CBM	2"	0-160 PSI	S100-270	165309	1/4" CBM	2-1/2"	0-1000 PSI
S100-234	165293	1/4" CBM	2"	0-300 PSI	S100-272	165380	1/4" CBM	2-1/2"	0-2000 PSI
S100-236	165294	1/4" CBM	2"	0-600 PSI	S100-274	165381	1/4" CBM	2-1/2"	0-3000 PSI

1/4" = 1/4" NPT pipe thread
1/8" = 1/8" NPT pipe thread

CBM = Center back mount
LM = Low mount
LBM = Low back mount



S10

LOW PRESSURE DIAPHRAGM GAUGES

 No.	Ref. No.	Mount	Face	Range	 No.	Ref. No.	Mount	Face	Range
S100-300	161963	1/4" LM	2-1/2"	15" WC	S100-318	161971	1/4" LM	2-1/2"	10 PSI
S100-302	161964	1/4" LM	2-1/2"	35" WC	S100-320	161972	1/4" LM	2-1/2"	20 oz.-35" WC
S100-304	162787	1/4" LM	2-1/2"	60" WC	S100-322	21551	1/4" CBM	2-1/2"	15" WC
S100-306	161965	1/4" LM	2-1/2"	100" WC	S100-324	21552	1/4" CBM	2-1/2"	35" WC
S100-308	161966	1/4" LM	2-1/2"	200" WC	S100-326	75995	1/4" CBM	2-1/2"	60" WC
S100-310	161967	1/4" LM	2-1/2"	20 oz.	S100-328	75991	1/4" CBM	2-1/2"	20 oz.
S100-312	161968	1/4" LM	2-1/2"	32 oz.	S100-330	21553	1/4" CBM	2-1/2"	36 oz.
S100-314	161969	1/4" LM	2-1/2"	36 oz.	S100-332	21554	1/4" CBM	2-1/2"	5 PSI
S100-316	161970	1/4" LM	2-1/2"	5 PSI	S100-334	75996	1/4" CBM	2-1/2"	10 PSI



COMPOUND GAUGES

 No.	Ref. No.	Mount	Face	Range	 No.	Ref. No.	Mount	Face	Range
S100-400	47925	1/8" LM	2"	30"-60 PSI	S100-408	46646	1/4" LM	2-1/2"	30"-60 PSI
S100-402	49609	1/8" LM	2"	30"-150 PSI	S100-410	47411	1/4" LM	2-1/2"	30"-150 PSI
S100-404	75260	1/8" LM	2"	30"-300 PSI	S100-412	58156	1/4" LM	2-1/2"	30"-300 PSI
S100-406	47105	1/4" LM	2-1/2"	30"-30 PSI					



GAUGE ADAPTER

 No.	Description
S100-10	1/4"-NPT (F) x 1/8"-NPT (M) Brass gauge adapter

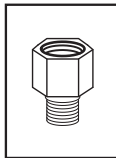

VACUUM GAUGES

 No.	Ref. No.	Mount	Face	Range
S100-498	-	1/8" LM	1-1/2"	0 - 30" Hg
S100-500	47225	1/8" LM	2"	0 - 30" Hg
S100-502	47103	1/4" LM	2"	0 - 30" Hg
S100-504	47104	1/4" LM	2-1/2"	0 - 30" Hg



TEST GAUGES

 No.	Ref. No.	Type	Mount	Face	Range	Refrigerant Scale	For Westwood Tester
S100-280	-	Pressure*	1/8" LM	2"	0 - 300 PSI	-	T10, T11
S100-285	-	Pressure*	1/8" LM	2-1/2"	0 - 300 PSI	-	T20, T22
S100-290	-	Vacuum*	1/8" LM	2"	0 - 30" Hg	-	T15
S100-295	-	Vacuum*	1/8" LM	2-1/2"	0 - 30" Hg	-	T20



* Liquid filled, stainless steel case

1/4" = 1/4" NPT pipe thread
1/8" = 1/8" NPT pipe thread

CBM = Center back mount
LM = Low mount
LBM = Low back mount



PRESSURE & VACUUM TESTERS starting on page T1

Please order by  No.

Westwood
OIL BURNER PUMP STRAINERS & GASKETS
 STAINLESS STEEL MESH • NYLON ENDS • SONICALLY WELDED

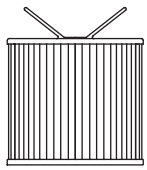
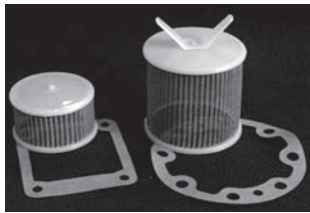

 No. **S150 (Series)**
 Suntec J, H, S



 No. **S160 (Series)**
 Suntec A70

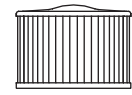

 No. **S170 (Series)**
 Suntec B80, 1-3/8"

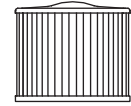

 No. **S180 (Series)**
 Suntec B80, 1-5/8"

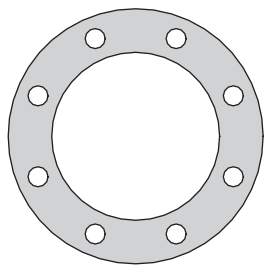

 No. **S150 (Series)**
 Suntec J, H, S

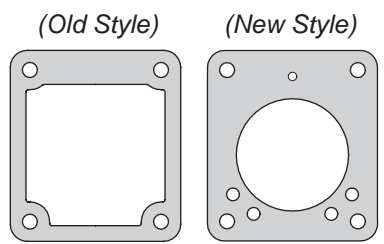

 No. **S190 (Series)**
 Suntec A70 & B80



 No. **S195**
 Riello



 No. **S197**
 Danfoss

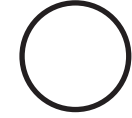

 No. **S195-5**
 Riello

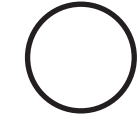

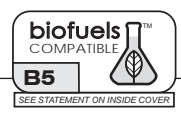

 No. **S197-5**
 Danfoss

 No.	Ref. No.	Description
S150	JHS	Strainer for Suntec J, H, S, individually boxed w/gasket
S150-10	-	Strainer for Suntec J, H, S, individually bagged w/gasket
S150-12	-	"P" Strainer for Suntec J, H, S, high capacity (coarse mesh), individually bagged w/gasket
S150-55	-	Cover gasket for Suntec J, H, S, package of 10 gaskets
S150-60	-	Cover gasket for Suntec J, H, S, package of 50 gaskets
S150-65	-	Cover gasket for Suntec J, H, S, package of 100 gaskets
S160-10	-	Strainer for Suntec A70 single-stage mini pump, individually bagged w/old style gasket
S160-12	-	Strainer for Suntec A70 single-stage mini pump, individually bagged w/new style gasket
S170	-	Strainer for Suntec B80 two-stage mini pump, 1-3/8" long, indiv. boxed w/old style gasket
S170-1	-	Strainer for Suntec B80 two-stage mini pump, 1-3/8" long, indiv. boxed w/new style gasket
S180	-	Strainer for Suntec B80 two-stage mini pump, 1-5/8" long, indiv. boxed w/old style gasket
S180-1	-	Strainer for Suntec B80 two-stage mini pump, 1-5/8" long, indiv. boxed w/new style gasket
S190	-	Cover gasket for Suntec A70 and B80 mini pumps, old style, package of 50 gaskets
S190-1	-	Cover gasket for Suntec A70 and B80 mini pumps, old style, package of 100 gaskets
S190-2	-	Cover gasket for Suntec A70 and B80 mini pumps, old style, package of 10 gaskets
S190-5	-	Cover gasket for Suntec A70 and B80 mini pumps, new style, package of 50 gaskets
S190-6	-	Cover gasket for Suntec A70 and B80 mini pumps, new style, package of 100 gaskets
S190-7	-	Cover gasket for Suntec A70 and B80 mini pumps, new style, package of 10 gaskets
S195	-	Strainer for Riello pump, individually bagged w/'O' ring gasket
S195-5	-	Cover 'O' ring gasket for Riello pump, package of 6 'O' rings
S196	-	Riello strainer w/o-ring and cork gasket
S197	-	Strainer for Danfoss pump, individually bagged w/'O' ring gasket
S197-5	-	Cover 'O' ring gasket for Danfoss pump, package of 6 'O' rings



FUEL SYSTEM PARTS

BY-PASS PLUGS		
 1/16" THREAD For Suntec A, B Webster M	 1/8" THREAD For Suntec J, H Webster R	 METRIC THREAD For RIELLO pump

 No. **S211, -1**

 No. **S211-2, -3**

 No. **S211-4, -5**



 No. **S213 & S214 (Series)**

MILLER FURNACE OIL LINE KIT

- 1 · S213-7 oil line. For Wayne Home Equip. OE, OE-LS, M-LS, MSRH, Nu-Way FM, FM-LS, FS-LS, Beckett AF-15, when burner does not have a Sundstrand A1VA 17J1600 pump.
- 1 · S213-11 oil line. For Wayne Home Equip. OE, OE-LS, Nu-Way FM, FM-LS, when burner has Sundstrand A1VA 17J1600 pump.
- 1 · 1/4" flare x 3/16" flare reducer adapter for certain Wayne OE & OE-LS burners
- 1 · 3/16" flare x 1/8" · NPT elbow for certain Wayne OE & OE-LS burners

 No. **S214-25**

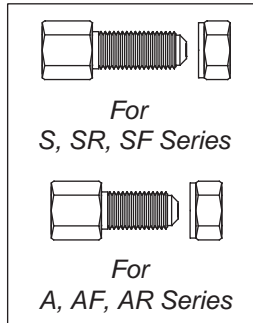

 No. **S215, -1**

MAGIC*PATCH™
FOR TEMPORARY USE ON LEAKING FUEL OIL TANKS

TAKE THE **MAGIC*PATCH™** CHALLENGE

PUT A MAGIC*PATCH AGAINST A REGULAR MAGNETIC PATCH (PAD TO PAD, HELD TOGETHER BY THE MAGNETS) AND LEAVE THEM FOR 24 HOURS. AFTER THAT TIME TEST THE MAGNETS. YOU'LL SEE WHAT MAKES THE MAGIC*PATCH, "MAGIC"

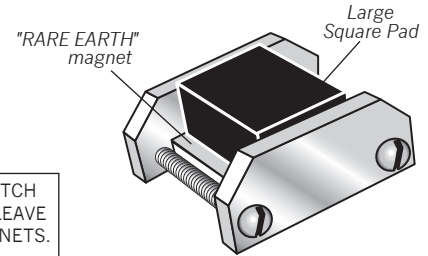

...holds like magic!

 No. **S216**

BY-PASS PLUGS, OIL LINES & FITTINGS, MAGIC-PATCH

 No.	Ref. No.	Description
S211	-	By-Pass Plug for Suntec A, B and Webster M, 1/16"- NPT, package of 10
S211-1	-	By-Pass Plug for Suntec A, B and Webster M, 1/16"- NPT, package of 100
S211-2	-	By-Pass Plug for Suntec J, H and Webster R, 1/8" NPT, package of 10
S211-3	-	By-Pass Plug for Suntec J, H and Webster R, 1/8" NPT, package of 100
S211-4	-	By-Pass Plug for RIELLO pump, (takes 2.5mm hex key), package of 10
S211-5	-	By-Pass Plug for RIELLO pump, (takes 2.5mm hex key), package of 100
S213-5	3605	Nozzle line w/flare nuts, 3/16" O.D. copper tubing, 5" long
S213-7	3607	Nozzle line w/flare nuts, 3/16" O.D. copper tubing, 7" long
S213-8	3608	Nozzle line w/flare nuts, 3/16" O.D. copper tubing, 8" long
S213-11	3611	Nozzle line w/flare nuts, 3/16" O.D. copper tubing, 11" long
S213-12	3612	Nozzle line w/flare nuts, 3/16" O.D. copper tubing, 12" long
S213-16	3616	Nozzle line w/flare nuts, 3/16" O.D. copper tubing, 16" long
S214-12	1412	Nozzle line w/flare nuts, 1/4" O.D. copper tubing, 12" long
S214-16	1416	Nozzle line w/flare nuts, 1/4" O.D. copper tubing, 16" long
S214-25	OL-711	Oil line parts kit for Miller furnaces, (1) S213-7, (1) S213-11, (2) fittings
S215	-	Replacement nozzle line fitting for Beckett S, SR, SF series burners
S215-1	-	Replacement nozzle line fitting for Beckett A, AF, AR series burners
S216	-	MAGIC*PATCH magnetic emergency tank leak patch

Please order by  No.

The Tigerloop[®] Oil De-aerator

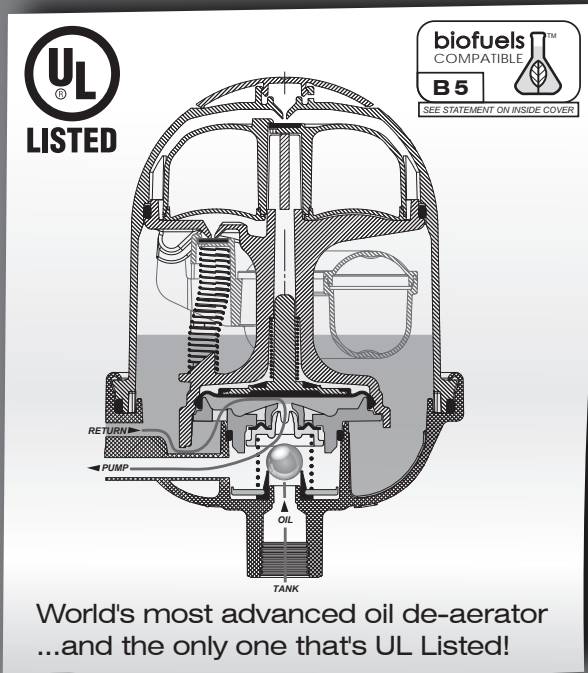

The Tigerloop[®] Oil De-aerator

The Tigerloop[®] is a wonderful device that has many benefits. It is often misunderstood and its workings can be difficult to grasp. Hopefully after reading this you'll come away with at least a basic idea of how the Tigerloop[®] works, and how it can improve the efficiency and extend the life of your oil heating systems.

The Tigerloop[®] combines the benefits of a single pipe system with a two pipe system. With a Tigerloop[®] installed, you need only to transport oil at the nozzle firing rate (i.e. 1 gph). This allows you to use one small line from the tank to the Tigerloop[®], whereas with a 2 pipe installation you have to provision 2 large diameter lines that will handle oil traffic at approximately 20 gph in both directions. One immediate benefit is the cost savings of dropping one line, but there are many more advantages. You filter less oil, 1 gph vs. 20 gph, which extends filter life. You preheat oil because it travels slowly into the house (at 1 gph) and loops through the Tigerloop[®] and pump approx. 20 times, picking up heat before it is fired. Contrast this to a 2 pipe system where cold oil enters the house rapidly (20 gph) and then is immediately sent back outside into the cold tank again (this also stirs up sediment in the tank, which can clog nozzles and filters). With a Tigerloop[®] you also eliminate the risk of a leak from the pressurized return line that is constantly pumping oil back to the tank. You also get a vacuum reduction because you are only pulling 1 gph up the inlet line instead of 20 gph. This is even more critical if you are lifting oil, or have a restricted line or a dirty filter. Imagine trying to pull 20 gph through a small restriction. Installing a Tigerloop[®] cuts the flow rate down to 1 gph, dropping vacuum and improving burner efficiency, while putting less strain on your oil pump and motor. Vacuum pulls vapor right out of the oil even in an "air tight" system. Less vacuum, less air, less problems....higher efficiency.

The Tigerloop[®] takes the good things of a 2 pipe system and improves them. With a 2 pipe system, all of the air and oil in the line flows through the pump, flows by (or out) the nozzle and then gets returned all the way back to the tank. The Tigerloop[®] improves upon this by deaerating the return oil and sending it back to the pump. This can reduce air by 95%. For example if you need 1 gph from the tank, the Tigerloop[®] is supplying 19 gph of de-aerated oil. This means that 19 out of 20 gallons (or 95%) of the oil has been de-aerated, and you get an efficiency bump. The flame will sputter less, the burner will fire cleaner and produce less soot. Soot build-up on the inside of a boiler will interfere with the absorption of heat. With a Tigerloop[®] installed, the heat will be going into the home, instead of up the chimney. In a single pipe system, all air in the line has to go out the nozzle, so installing a Tigerloop[®] will reduce lockouts, flameouts, and sputters. This will give you the efficiency benefits mentioned above.

Now a quick explanation of how the Tigerloop[®] works. Oil gets pulled through a check valve (inside the Tigerloop) and then thru the pump. The pump gives the nozzle what it needs (i.e. 1 gph) and then sends the excess 19 gph back to the Tigerloop[®] to be de-aerated. As oil rises in the Tigerloop[®], air escapes from the top vent until a float lifts and seals the vent. When the vent seals, the Tigerloop[®] builds pressure (about 1/3 psi). The pressure opens a valve sending de-aerated oil back to the pump, creating the loop. If any air reaches the Tigerloop[®], the float drops, the vent opens and the air is removed. The float rises again sealing the Tigerloop[®].

You can see that having a Tigerloop[®] is better than either a single pipe system or a 2 pipe system, and if the Tigerloop[®] saves a service call, you save money (and aggravation). You also improve burner efficiency and gain customer satisfaction, things which are extremely important in today's oil heating marketplace.

S14

Tigerloop® Model TN

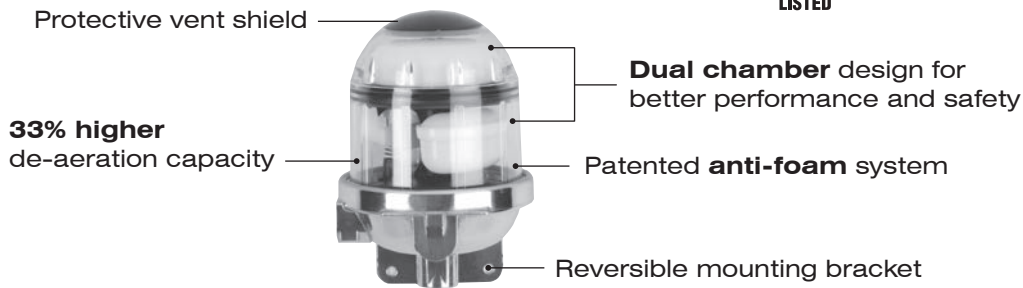

World's most advanced oil de-aerator!

After years of development, the next generation Tigerloop® oil de-aerator has arrived! With over 30 years experience and more than 3.5 million Tigerloops® installed worldwide, Tigerholm is uniquely qualified to take oil de-aeration to the next level.

More than just a problem solver!

For years, Tigerloop® has been primarily thought of as a problem solver, a "band-aid," used to easily cure air and suction line problems. But, that's only part of the story! All systems benefit from Tigerloop's® unique ability to condition the oil prior to burning. Whether it's air elimination, nozzle coking problems, vacuum reduction, oil preheating, or just the elimination of that potentially leaky return line, Tigerloop® is today's safe, economical, environmentally friendly choice for all oil supply systems.

The Advantages of Tigerloop®...

- Safely Handles suction line air leaks.*
- Removes air entrained in oil during transporting and delivery.*
- Reduces running vacuum for clear, foam-free oil at the nozzle.*
- Eliminates potential leak hazard by eliminating the return line.*
- Preheats the oil for cleaner combustion.*
- Extends filter element life.*

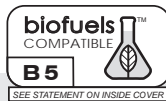

Technical Information

MAX. NOZZLE CAPACITY 29.0 GPH
 MAX. RETURN OIL FLOW 31.7 GPH
 TEMPERATURE RANGE 20° - 105° F
 MAX. INLET PRESSURE 8 PSI
 CONNECTIONS 1/4" - NPT (female)
 FUEL No. 1 & 2 HEATING OIL, B5 BioHeat®
Not for use with E-diesel or any fuel containing Ethanol (alcohol)

 No.	Description
S220*	Tigerloop® oil de-aerator, model TN, UL Listed includes Fiomatic fusible valve.
S220-10	3/8"- NPT Fiomatic fusible valve only w/reducing nipple installed (3/8"- NPT x 1/4"- NPT)
S220-11	Tigerloop® Installation Bundle, oil de-aerator, model TN, UL Listed, w/Fiomatic fusible valve, plus two 36" flexible oil lines.
S220-13	Tigerloop® vent hose kit to re-route vapors.

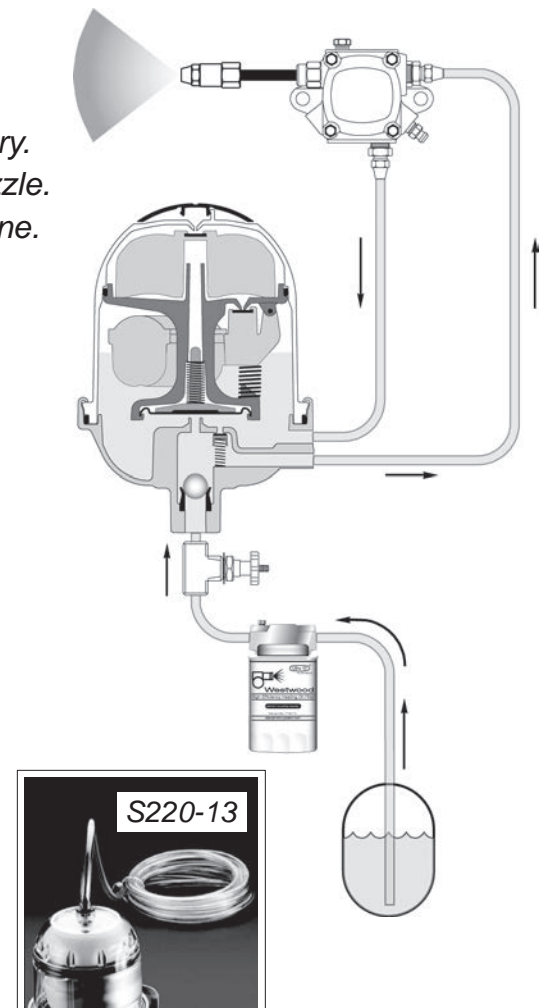

The New

Tigerloop®

ULTRA™

The economical Tigerloop®/Spin-On filter combination that's fast and easy to install. Costs less than installing a Tigerloop® and Spin-On separately! Designed specifically for the demands of American heating systems.

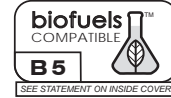

Costs less than installing a Tigerloop® and Spin-On separately!

Technical Information

MAX. NOZZLE CAPACITY 29.0 GPH
 MAX. RETURN OIL FLOW 31.7 GPH
 TEMPERATURE RANGE 20° - 105° F
 MAX. INLET PRESSURE 8 PSI
 CONNECTIONS1/4" - NPT (female)

REPLACEMENT ELEMENT F100-10
 ELEMENT MEDIA 10 Micron
 ELEMENT CANISTER EPOXY INSIDE
 FUEL No. 1 & 2 HEATING OIL, B5 BioHeat®
Not for use with E-diesel or any fuel containing Ethanol (alcohol)

Tigerloop® ULTRA™ OIL DE-AERATOR & SPIN-ON FILTER

 No.	Description
S220-8	Tigerloop® ULTRA™ oil de-aerator & Spin-On filter, UL Listed, includes Fiomatic fusible safety valve.
S220-12	Tigerloop® ULTRA™ Installation Bundle , oil de-aerator, Spin-On filter, UL Listed, w/Fiomatic valve, plus two 36" flexible oil lines.
S220-13	Tigerloop® vent hose kit to re-route vapors (w/30 ft. hose).
F100-10	Replacement Spin-On element only, standard thread, see page F4

Tigerloop[®] Bio[™] **NEW!**

A standard Tigerloop[®] with B100 compatibility!

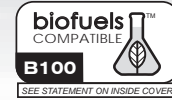

Totally **Metallic** Housing



Technical Information

MAX. NOZZLE CAPACITY 29.0 GPH
 MAX. RETURN OIL FLOW 31.7 GPH
 TEMPERATURE RANGE 20° - 105° F
 MAX. INLET PRESSURE 8 PSI
 CONNECTIONS 1/4" - NPT (female)
 FUEL biofuels up to **B100** BioHeat[®], No. 1 & 2 OIL
Not for use with E-diesel or any fuel containing Ethanol (alcohol)

 No.	Description
S220-1	Tigerloop [®] Bio [™] oil de-aerator for biofuels to B100

Tigerloop[®] ULTRA-**B**[™] **NEW!**

A standard Tigerloop[®] ULTRA[™] with B100 compatibility!

Totally **Metallic** Housing

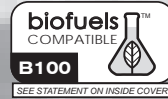

Technical Information

MAX. NOZZLE CAPACITY 29.0 GPH
 MAX. RETURN OIL FLOW 31.7 GPH
 TEMPERATURE RANGE 20° - 105° F
 MAX. INLET PRESSURE 8 PSI
 CONNECTIONS 1/4" - NPT (female)
 REPLACEMENT ELEMENT F100-10
 ELEMENT MEDIA 10 Micron
 ELEMENT CANISTER EPOXY INSIDE
 FUEL . . . biofuels up to **B100** BioHeat[®], No. 1 & 2 HEATING OIL
Not for use with E-diesel or any fuel containing Ethanol (alcohol)



 No.	Description
S220-9	Tigerloop [®] ULTRA [™] - B oil de-aerator & filter

Tigerloop®

Combi 3™

A European Favorite

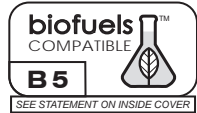

The New **Tigerloop® Combi 3™** now has an integrated shutoff valve. It features a clear plastic bowl which houses a high efficiency sintered plastic filter element with a 50-70 micron rating.

Tigerloop® Combi 3™ OIL DE-AERATOR & FILTER

 No.	Description
S220-3	Tigerloop® Combi 3™ oil de-aerator & filter, 3/8" NPT female tank connection x 1/4" NPT female pump connections.
S220-6	Replacement sintered plastic filter element for S220-3 (Combi 3) & S220-4 (Combi)
S220-7	O-ring for Combi filter cup (Pkg. of 6)

Technical specs are the same as for the S220. See page S15

Tigerloop®

Twin™

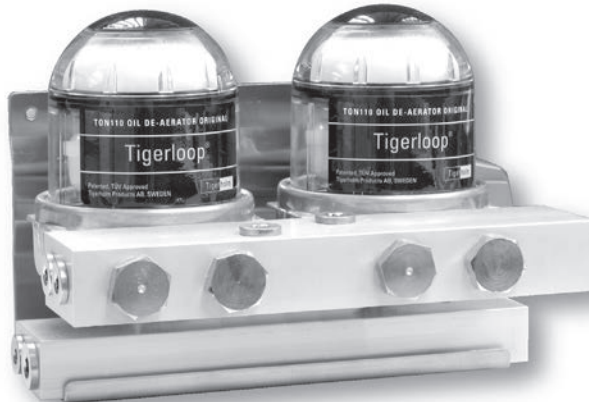

**If something is good...
then two are better!**

The Tigerloop® **Twin™** has twice the capacity for those large commercial jobs. Get all the benefits of Tigerloop's famous de-aeration capabilities...in a bigger way! Comes complete with Westwood's commercial duty Spin-On filter.

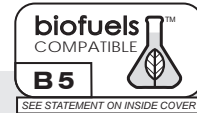

Technical Information

MAX. NOZZLE CAPACITY 52.8 GPH
 MAX. RETURN OIL FLOW 52.8 GPH
 TEMPERATURE RANGE 20° - 105° F
 MAX. INLET PRESSURE 8 PSI
 TANK CONNECTION 3/8" - NPT
 PUMP CONNECTIONS 1/4" - NPT

SPIN-ON FILTER SUPPLIED F100-1
 REPLACEMENT ELEMENT F100-11
 ELEMENT MEDIA 30 Micron
 ELEMENT CANISTER EPOXY INSIDE
 FUEL No. 1 & 2 HEATING OIL, B5 BioHeat®
Not for use with E-diesel or any fuel containing Ethanol (alcohol)

Tigerloop® Twin™ OIL DE-AERATOR & SPIN-ON FILTER

 No.	Description
S220-15	Tigerloop® Twin™ oil de-aerator & commercial duty Spin-On filter
F100-11	Replacement Spin-On element, standard thread, see page F3

GENUINE

Tigerloop®

For use as oil burner pump suction and return lines (not for nozzle line)

FLEXIBLE OIL LINES



For swing-out doors and oil de-aerators

Steel Braided Covering - 24" and 36" Long - 145 PSI - 200 °F
For No. 1 and 2 heating oil, BioHeat® B5 or B20

*** DIN ISO 6806 APPROVED**

FLEXIBLE OIL LINES, Standard

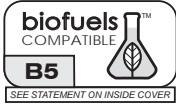
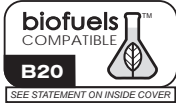
 No.	Description	BioFuels Rating
S220-24	Flexible oil line, braided steel covering, 1/4"- NPT (MxM), 24" long *	 <small>SEE STATEMENT ON INSIDE COVER</small>
S220-36	Flexible oil line, braided steel covering, 1/4"- NPT (MxM), 36" long *	
S220-40	Replacement fitting for flexible oil line, 3/8" inv. flare x 1/4"-NPT	
S222-36	Flexible oil line, braided steel covering, 3/8" Flare (FxF), 36" long *	
S223-24	BioFuels Flexible oil line, braided steel covering, 1/4"- NPT (MxM), 24" long	 <small>SEE STATEMENT ON INSIDE COVER</small>
S223-36	BioFuels Flexible oil line, braided steel covering, 1/4"- NPT (MxM), 36" long	



New!

**FLEXIBLE OIL LINES
SPECIAL FOR RIELLO**

Color coded Red & Blue for easy identification

European thread connects to **RIELLO** pump adaptor

Easy installation & service with two piece swivel connector

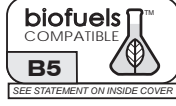

FLEXIBLE OIL LINES, Special for RIELLO burners

 No.	Description	BioFuels Rating
S221-24	Flexible oil line for Riello burner, braided steel outside covering, 1/4"- NPT (M) x 1/4"- BSPP (RIELLO pump adapter thread), 24" long	 <small>SEE STATEMENT ON INSIDE COVER</small>
S221-36	Flexible oil line for Riello burner, braided steel outside covering, 1/4"- NPT (M) x 1/4"- BSPP (RIELLO pump adapter thread), 36" long *	

Service Advisory: All flexible oil lines should be inspected annually for deterioration (i.e. stiffness, cracks, etc.) and replaced every 3 years

 Take a look . . .

For testing RIELLO pumps see page T2 & T3

Please order by  No.

rev. 11-29-17

E-Z Connect ADAPTOR FITTING

One fitting quickly connects the 1/4"-NPT male end of flexible oil lines to 3/8" FLARE!

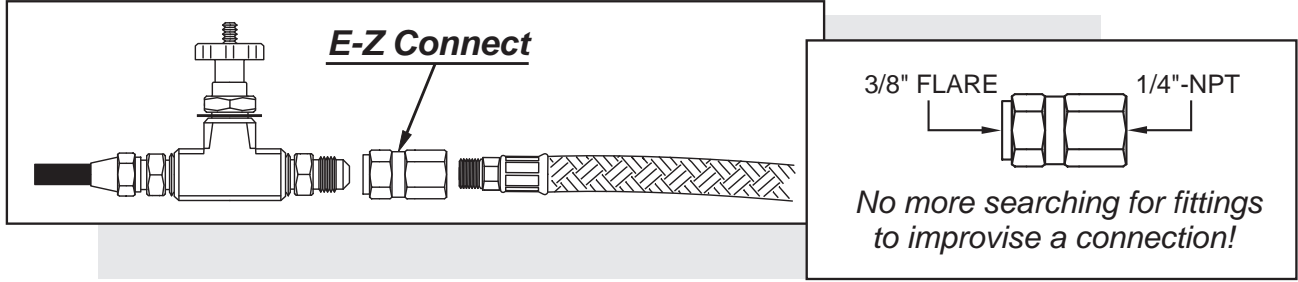

No. S220-50

CHECK VALVES

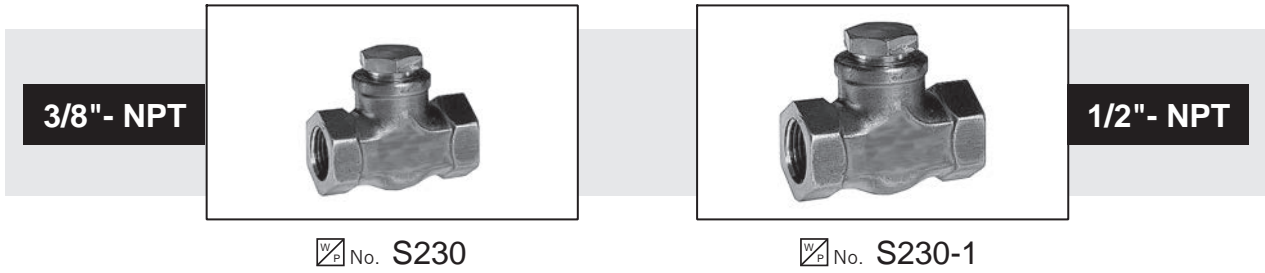

No. S230

No. S230-1

OIL LINE SAFETY VALVES

Isolates burner components from fuel supply line pressure.
Requires pump vacuum to draw oil from the tank.



PRV Oil Line Safety Valve

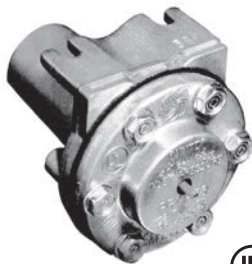

No. S225



Technical Information

MAXIMUM FLOW 20 GPH
 TEMPERATURE RANGE 0 - 160° F
 MAX. INLET PRESSURE 40 PSI
 FUEL No. 2 OR LIGHTER
 APPROVAL UL LISTED
 CONNECTIONS 3/8"- NPT

Tigerholm

AN SPX BRAND

Tigerstop™ Anti-siphon valve

Adjustable for heights up to 13 ft.



No. S224-2

Technical Information

MAXIMUM FLOW
 at 0.58 PSI pressure loss 52.8 GPH
 MAX TEMPERATURE 104° F
 MAX. INLET PRESSURE 87 PSI
 FUEL . biofuels to B20, No.1 & 2 Heating Oil
 CONNECTIONS 3/8"- NPT
 Height adjustable to 13 ft



Westwood



OIL SAFETY VALVE & SPIN-ON FILTER

Combines the Suntec PRV-38P oil safety valve with the Westwood Products Ultra-10™ (10 micron) high efficiency Spin-On filter element number F100-10. This combination provides the ultimate in protection for oil supply systems and costs less than installing an oil safety valve and Spin-On separately!

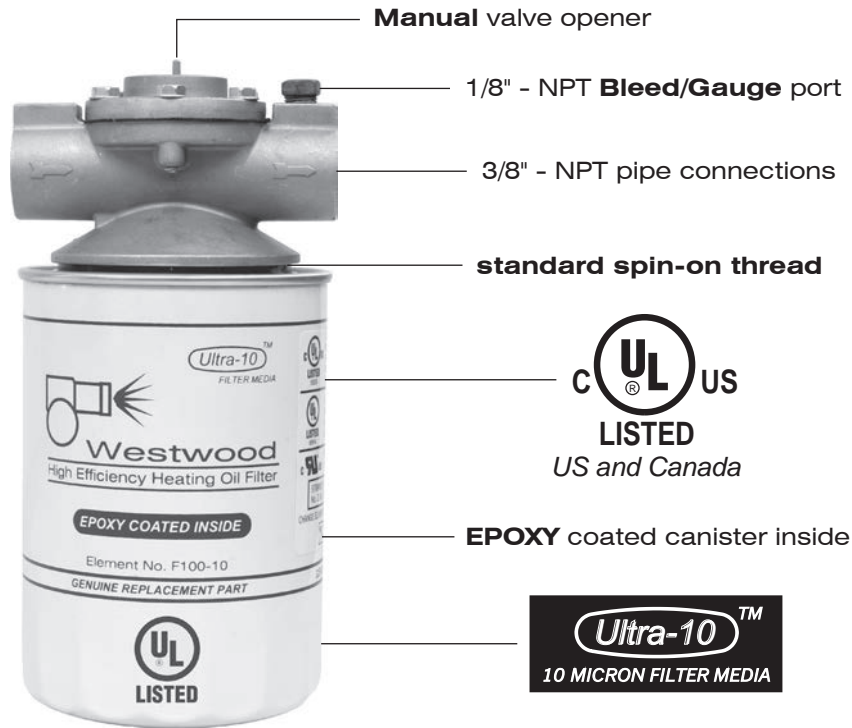

Costs less than installing an Oil Safety Valve and Spin-On separately!

Technical Information

CONNECTIONS 3/8"-NPT	MAXIMUM FIRING RATE 29 GPH
INLET PRESSURE 40 PSI MAX	REPLACEMENT ELEMENT F100-10
TEMPERATURE RANGE 0 - 160° F	ELEMENT MEDIA 10 Micron
FUEL No. 2 OIL OR LIGHTER	ELEMENT CANISTER EPOXY INSIDE
MAXIMUM FLOW 45 GPH	APPROVAL UL LISTED

Westwood OIL SAFETY VALVE & SPIN-ON FILTER



 No.	Description
S226	Westwood oil safety valve and Spin-On filter, UL Listed
F100-10	Replacement Spin-On element, standard thread, see page F3

Westwood

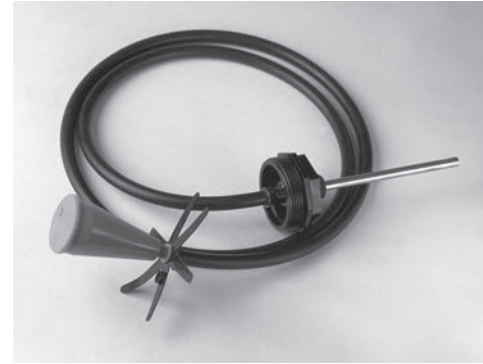
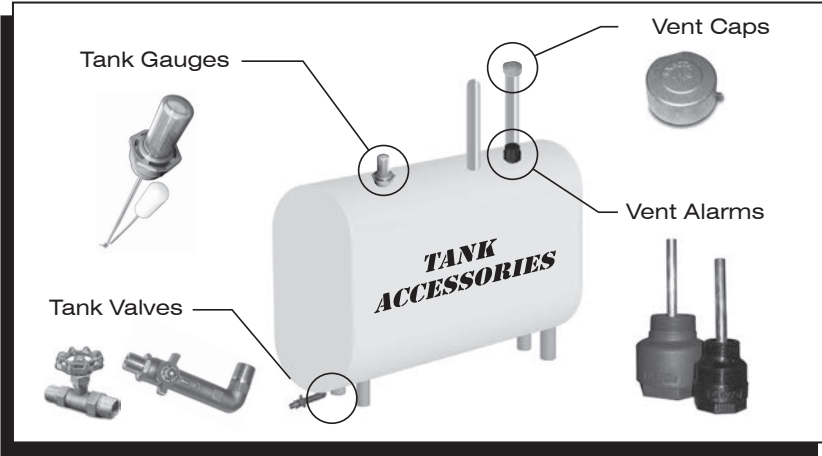
HEATING OIL TANK ACCESSORIES



S260 Tigerflex™ Floating Suction Line

 No.	Description	 No.	Description
S260	Tigerflex™ Floating Suction Line 1-1/2" & 2"	S270-10	2" Aluminum vent cap, set screw, screen
S270	1-1/4" Vent alarm	S270-20	1/2" x 3/8" Oil tank valve, straight
S270-1	2" Vent alarm	S270-22	1/2" x 3/8" Oil tank valve, 90° angle
S270-4	1-1/4" Aluminum vent cap, set screw	S270-24	1-1/2" and 2" Tank gauge, 24"
S270-6	1-1/4" Aluminum vent cap, set screw, screen	S270-44	1-1/2" and 2" Tank gauge, 44"
S270-8	2" Aluminum vent cap, set screw		

S280 Tigex® 150 Draft Stabilizer

Stainless steel design fights soot, moisture, and corrosive chemicals. Gas tight 1100°C superwool seal ensures no leakage of exhaust fumes or ash/soot particles, and quiet function - the damper flap opens and closes quietly during operation as there are no metal parts hitting each other. Easy to install. Self-cleaning door axel. Incredible quality - the top of the line!

Approx Capacity	Max. chimney height	Max. chimney dia. / area
up to 100 kW (341 kBtu)	up to 15 m (49 ft.)	Ø200 mm / 314 cm ² (Ø7-7/8" / 48.7in ²)



Tigex® 150 Draft Stabilizer



Adapter for round flue pipe

Finish Color	Description
Stainless	
S280	Tigex® 150 Draft Stabilizer
S280-130	Adapter for 5" round flue pipe
S280-150	Adapter for 6" round flue pipe
S280-180	Adapter for 7" round flue pipe
S280-200	Adapter for 8" round flue pipe

UNIVERSAL DRAFT REGULATOR

Fits the most popular smoke pipe sizes, 6", 7", 8", galvanized steel.

 No.	Ref. No.	Description
S300-300	#678	3 in 1 combination draft regulator, fits 6", 7", 8" smoke pipe



Westwood

CRANK ARMS - SWIVELS - PUSH RODS

PRECISION MACHINED • HEAVY DUTY • PLATED STEEL

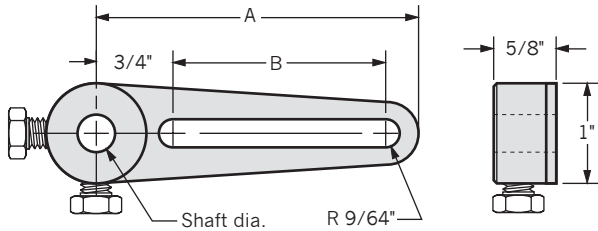

Slotted Crank Arm

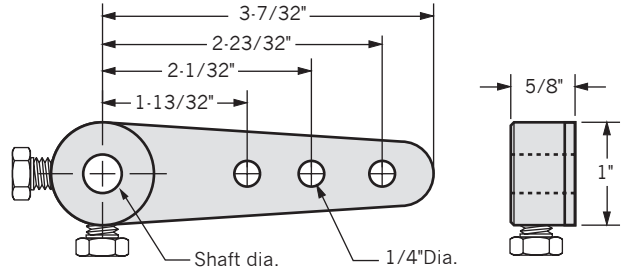

3 Hole Crank Arm

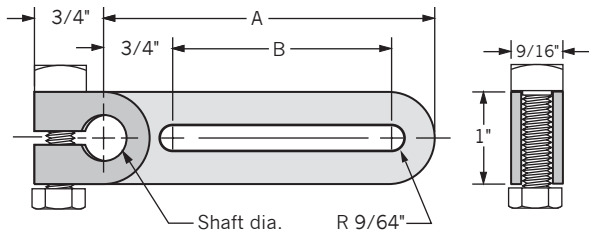

Slotted Crank Arm
(shaft clamping)

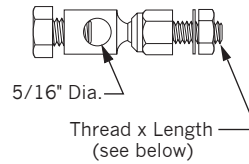

Swivel

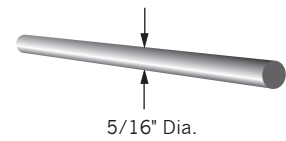

Push Rod

 No.	Ref. No.	Shaft Dia.	A	B	Swivel Thread x Length	Push Rod Length	Description
S300-400	ARM-3S	3/8"	3-3/16"	2-1/8"	-	-	Slotted crank arm
S300-402	ARM-5S	1/2"	3-3/16"	2-1/8"	-	-	Slotted crank arm
S300-404	ARM-3L	3/8"	4-15/16"	3-7/8"	-	-	Slotted crank arm
S300-406	ARM-5L	1/2"	4-15/16"	3-7/8"	-	-	Slotted crank arm
S300-408	ARM-14	3/8"	-	-	-	-	3 hole crank arm
S300-410	ARM-15	1/2"	-	-	-	-	3 hole crank arm
S300-412	ARM-5C	1/2"	3-19/32"	2-3/8"	-	-	Clamping crank arm
S300-414	SW-4	-	-	-	1/4-20 x 7/16"	-	Swivel
S300-416	SW-5	-	-	-	5/16-24 x 41/64"	-	Swivel
S300-418	SW-6	-	-	-	5/16-24 x 33/64"	-	Swivel
S300-420	SW-8	-	-	-	1/4-28 x 9/16"	-	Swivel
S300-422	SW-9	-	-	-	1/4-20 x 9/16"	-	Swivel
S300-424	PR-12	-	-	-	-	12"	5/16" dia. push rod
S300-426	PR-18	-	-	-	-	18"	5/16" dia. push rod
S300-428	PR-24	-	-	-	-	24"	5/16" dia. push rod
S300-430	PR-36	-	-	-	-	36"	5/16" dia. push rod
S300-432	PR-48	-	-	-	-	48"	5/16" dia. push rod

Westwood



HIGH TEMPERATURE GLASSWARE

BOROSILICATE & SODA LIME WINDOW GLASS

**OBSERVATION PORTS****Clear - Soda Lime Window Glass - Male Pipe Thread Mount - 500° F**

 No.	Reference No.	Pipe Thread	Working Pressure
S305-37	OBS-38	3/8"- NPT	3,700 PSI
S305-50	OBS-50	1/2"- NPT	3,500 PSI
S305-75	OBS-75	3/4"- NPT	3,000 PSI
S305-100	OBS-100	1"- NPT	2,500 PSI
S305-125	OBS-125	1-1/4"- NPT	2,000 PSI
S305-150	OBS-153	1-1/2"- NPT	1,500 PSI

ROUND SIGHT GLASSES - Clear - Borosilicate Glass - 400° F

Diameter	 No.			Diameter	 No.		
	1/8" Thick	3/16" Thick	1/4" Thick		1/8" Thick	3/16" Thick	1/4" Thick
1"	S312-100	S318-100	S325-100	2-5/8"	S312-262	S318-262	S325-262
1-1/8"	S312-112	S318-112	S325-112	2-3/4"	S312-275	S318-275	S325-275
1-3/16"	S312-118	S318-118	S325-118	3"	S312-300	S318-300	S325-300
1-1/4"	S312-125	S318-125	S325-125	3-1/8"	S312-312	S318-312	S325-312
1-3/8"	S312-137	S318-137	S325-137	3-3/16"	S312-318	S318-318	S325-318
1-7/16"	S312-143	S318-143	S325-143	3-1/4"	S312-325	S318-325	S325-325
1-1/2"	S312-150	S318-150	S325-150	3-3/8"	S312-337	S318-337	S325-337
1-5/8"	S312-162	S318-162	S325-162	3-7/16"	S312-343	S318-343	S325-343
1-3/4"	S312-175	S318-175	S325-175	3-1/2"	S312-350	S318-350	S325-350
2"	S312-200	S318-200	S325-200	3-5/8"	S312-362	S318-362	S325-362
2-1/8"	S312-212	S318-212	S325-212	3-3/4"	S312-375	S318-375	S325-375
2-3/16"	S312-218	S318-218	S325-218	4"	S312-400	S318-400	S325-400
2-1/4"	S312-225	S318-225	S325-225	4-1/2"	S312-450	S318-450	S325-450
2-3/8"	S312-237	S318-237	S325-237	5"	S312-500	S318-500	S325-500
2-7/16"	S312-243	S318-243	S325-243	6"	S312-600	S318-600	S325-600
2-1/2"	S312-250	S318-250	S325-250				

Special size round, square, rectangular shapes, and colors available. Consult the factory for price and delivery.

BOILER & FURNACE CLEANING ITEMS

"SERVICE-SAW" BOILER SCALE BUSTING TOOL



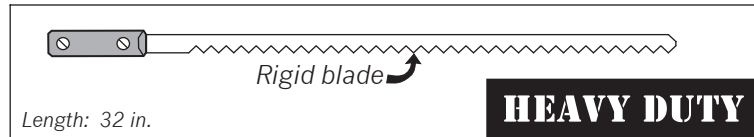

 No. S400

"SOOT SABER" BOILER CLEANING TOOLS



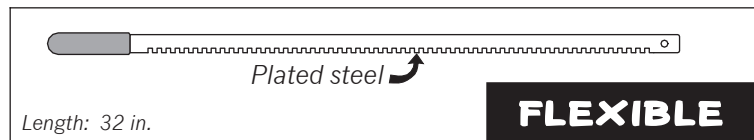

 No. S402

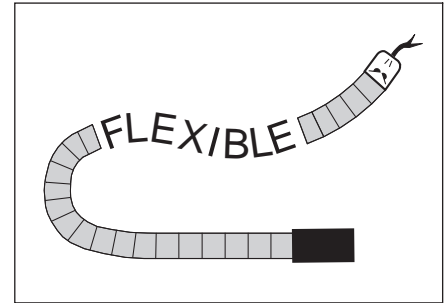

 No. S405

"SOOT SNAKE" VAC HOSE



 No. S410

SOOT SHOVEL

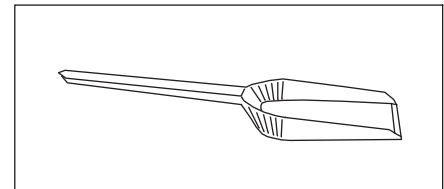

 No. S412

VACUUM CLEANER BAGS - Wrap around seam sealed for strength

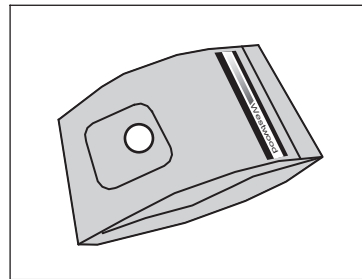

 No. S450-14, -15

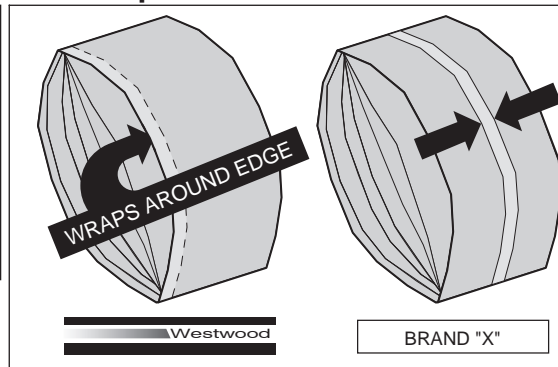

When soot's involved, THE SEAM MATTERS!











WHEN BAGS INFLATE, THE ENTIRE FORCE IS PUT ON THE SEAM HOLDING THE BAG TOGETHER. OTHER BAGS RELY ON A GLUED LAP SEAM THAT CAN GIVE WAY UNDER PRESSURE.

WESTWOOD'S SEAM IS ON THE EDGE, WHICH GIVES A STRONGER, WRAP AROUND SEAL.

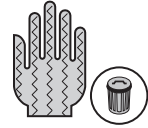
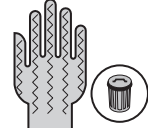
CLEANING TOOLS & VACUUM CLEANER BAGS

 No.	Reference No.	Description
S400	Service-Saw	"Service-Saw" boiler scale cleaning tool, tempered steel saw blade, plastic handle
S402	-	"SOOT SABER" Heavy Duty (rigid) boiler cleaning tool, zinc coated steel, wood handle
S405	-	"SOOT SABER" Flexible boiler cleaning tool, zinc coated steel, soft vinyl handle
S410	-	"SOOT SNAKE" Flexible steel vacuum cleaner hose, 7/8" dia., 48" long, with installed rubber adapter to fit a standard 1-1/2" rubber vacuum cleaner hose
S412	-	Soot Shovel, 4-1/2" wide, 19-1/2" long, steel with black enamel finish
S450-14	-	Style 4464 (3-1/2 gal.) vacuum cleaner bags. Fits Mastercraft 605, 641, 1100, 6500 and others; Sid Harvey S12. Package of 5 bags
S450-15	-	Style 4465 (5 gal.) vacuum cleaner bags. Fits Mastercraft 652, 653, 880, 990, 1005, 1010, 1015, 1200, 7000, 13008, D6508, D6520, D6530, W6508, W6509, W6510, 6513, and others; Sid Harvey S14. Package of 5 bags

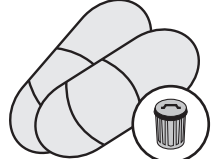
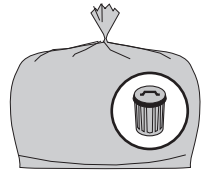
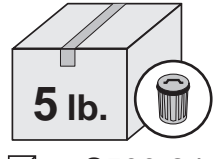
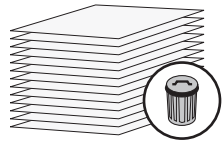
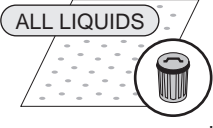
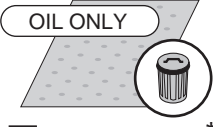
Safety and Spill Cleanup Supplies

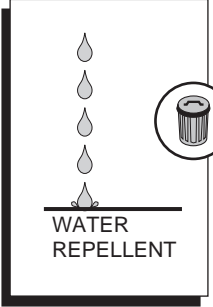
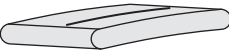
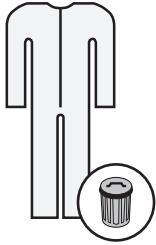
CLOTH	NITRILE GLOVES			MASKS
 <p>No. S500 PAIR Brown jersey gloves man's hand size</p>  <p>No. S500-2 PAIR White canvas gloves cotton/polyester blend man's hand size</p>	 <p>BOX OF 100 Disposable oil resistant blue 5 mil nitrile gloves</p> <p>No. S500-4 LARGE</p> <p>No. S500-6 X-LARGE</p>  <p>No. S500-8* ONE PAIR Reusable heavy duty oil resistant nitrile gloves, man's hand size</p>	 <p>BOX OF 100 MAX-GRIP 6 mil Disposable oil resistant black, 6 mil nitrile gloves, with non-slip textured 4 mil ridges</p> <p>No. S500-5 LARGE No. S500-7 X-LARGE</p>  <p>BOX OF 48 12" LONG NON SLIP GRIP Disposable oil resistant yellow 6 mil nitrile gloves, with non-slip textured 4 mil ridges</p> <p>No. S500-13 LARGE No. S500-15 X-LARGE</p>	 <p>EACH Disposable dust mask, elastic strap</p> <p>No. S500-10 not rated</p> <p>No. S500-12 N95 rated</p>	<p style="text-align: center;">GLASSES</p>  <p>PAIR Safety Glasses adjustable, plastic</p> <p>No. S500-14 clear lenses</p> <p>No. S500-16 smoked lenses</p>
GOGGLES	SHOE COVERS	BAGS	RAGS	WIPES
 <p>No. S500-18* EACH Plastic splash goggles, elastic strap</p>	 <p>No. S500-20 PAIR Disposable non-woven fabric slip-on shoe covers</p>	 <p>No. S500-22* PACKAGE OF 20 7 bu. plastic (3 mil.) contractor disposal bags</p>	 <p>No. S500-24 Rags (t-shirt mat'l) mixed colors</p> <p>No. S500-25 Rags 18" x 18" white cotton</p>	 <p>No. S500-26 PACKAGE OF 100 Flat paper wipes, 13" x 13"</p>
PADS	SOCKS	DROP CLOTH	SPILL KIT	COVERALLS
<p>ALL LIQUIDS</p>  <p>No. S500-28* PACKAGE OF 100 Absorbent pads 15" x 18" x 1/8" thick</p> <p>OIL ONLY</p>  <p>No. S500-30* PACKAGE OF 100 Absorbent pads 15" x 18" x 1/8" thick</p>	<p>ALL LIQUIDS</p>  <p>No. S500-32* PACKAGE OF 40 Absorbent socks 3" dia. x 48" long</p> <p>OIL ONLY</p>  <p>No. S500-34* PACKAGE OF 40 Absorbent socks 3" dia. x 48" long</p>	<p>5' x 8' (Approximately)</p>  <p>No. S500-36 EACH Large non-woven fabric drop cloth, water repellent</p>	 <p>Spill Kit in Heavy Duty Zippered Carrying Bag</p> <p>Contains:</p> <ul style="list-style-type: none"> 1 - splash goggles 1 - pr. nitrile reusable gloves 2 - contractor bags 1 - All liquid absorbent sock 1 - Oil only absorbent sock 5 - All liquid absorbent pads 5 - Oil only absorbent pads 1 - Heavy duty clear plastic zippered carrying bag <p>No. S500-38 EACH Economy Spill Kit in zippered carrying bag</p>	 <p>Full Body Coverall Disposable, white non-woven fabric</p> <p>No. S500-50 LARGE</p> <p>No. S500-60 X - LARGE</p>

* Part of the S500-38 Economy Spill Kit (see listing above for quantities of each included in the kit).

Westwood

"PRESSURE-VIEW" OIL BURNER PUMP TESTER

- ▶ Quick-connect fittings
- ▶ Brass construction
- ▶ Fits popular 3/16"
- ▶ Stainless steel liquid filled gauge
- ▶ Easy-to-follow instructions

SUPERCEDED!!!

by the **NEW T11** "FITZ-ALL" TESTER, see page T2
 (parts for the T10 are still available, see below)

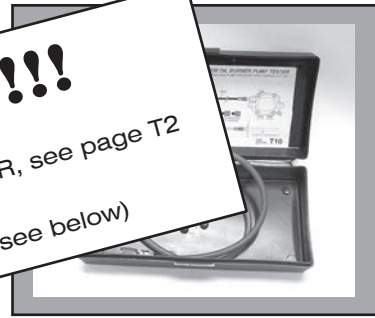

 No. T10

T10 TESTER PARTS

 No.	Description
T10-3	Replacement adaptor fittings for T10 tester, 3/16" X 1/4" flare, Pkg. of 2
T10-4	Replacement rubber quick-connect seats (gaskets) for T10 tester, Pkg. of 12
T10-5	Replacement hose set (2 color coded hoses) with fittings for T10 tester
S100-280	Replacement Liquid Filled 0-300 PSI Pressure Gauge for T10 tester

Westwood

"VACUUM-VIEW" SUCTION LINE ANALYZER

- ▶ Thick clear tubing does not collapse from vacuum
- ▶ All brass with stainless steel tubing clamps
- ▶ Fits popular 3/8" and 1/2" suction line fittings
- ▶ Stainless steel liquid filled gauge, range 0 - 30" Hg
- ▶ Easy-to-follow instructions - rugged carrying case



 No. T15

Analyze suction line problems (ie. air leaks, restrictions, dirt, etc.) using this clear tubing service tool. Vacuum gauge liquid dampens pulsation allowing precise measurement and protects gauge from hydraulic shock damage. Actually see what's happening inside that problem suction line! Complete instructions and "Service Truck Tough" carrying case.

OIL BURNER PUMP VACUUM TESTER

 No.	Description
T15	Complete suction line analyzer w/case, adaptor fittings and instructions
T15-1	Replacement adaptor fittings for T15 tester, 1/2" suction line, Pkg. of 2
T15-2	Replacement clear tubing w/clamps for T15 tester
S100-290	Replacement Liquid Filled 0-30" Hg. Vacuum Gauge for T15 tester



For testing RIELLO pumps see pages T2 & T3

Please order by  No.

rev. 1-1-09

T1



Westwood

"FITZ - ALL" OIL BURNER PUMP TESTER

The first NEW design in pump testers in over 25 years!

Tests: Standard burners
 Beckett w/cover (Burnham AFG, NX, etc.)
 Riello

- ✓ Angle connector for **hard to reach** connection to **Beckett** pumps
- ✓ Quick-connect fittings have built-in seals and require only **finger tightening**
- ✓ Super **flexible** micro diameter color coded high pressure hoses
- ✓ Fits popular 3/16" flare nozzle line fittings - comes with adaptors for **Riello** pumps (European thread) and 1/4" flare nozzle line fittings
- ✓ **Stainless steel liquid filled** gauge with **0 - 300 PSI** range
- ✓ **Rugged** carrying case with easy-to-follow **instructions**

CONNECTS EASILY TO WHAT'S OUT THERE!

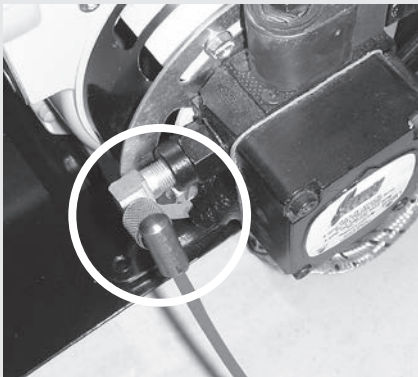

STANDARD
 (90° or straight flare fitting in nozzle port)

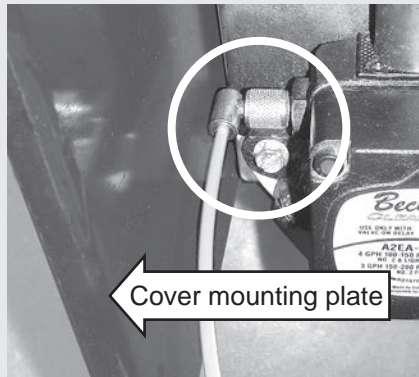

BECKETT with cover
 (hard to reach pump fitting due to cover mounting plate)

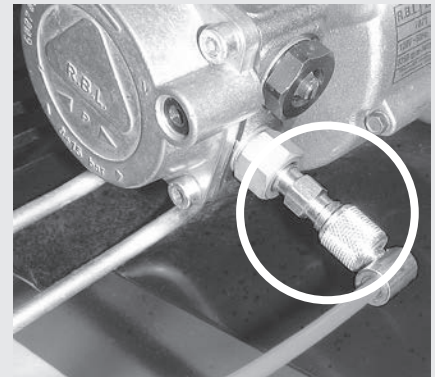

RIELLO
 (European thread adaptor fits in pump bleeder port)

Choose between pressure measurement and cut-off test* with just the turn of the knob - no disconnecting! Fits standard 3/16" flare nozzle line fittings. Includes adaptors for 1/4" flare nozzle line fittings and for Riello pumps (European threads). Super flexible small diameter high pressure tubing and quick-connect fittings allow fast hook-up with just finger tightening. "Service Truck Tough" carrying case with complete instructions.

* Not used for checking cut-off on Riello pumps

"FITZ-ALL" OIL BURNER PUMP PRESSURE & CUT-OFF TESTER



No. T11

No.	Description
T11	Complete oil burner pump tester w/case, adaptors and instructions
T11-3	Replacement adaptors for T11 tester, (2) 3/16" X 1/4" flare, (1) Riello
T11-4	Replacement rubber quick-connect seals (gaskets) for T11 tester, Pkg. of 12
T11-5	Replacement hose set (2 color coded hoses w/fittings) for T11 tester
S100-280	Replacement Liquid Filled 0-300 PSI Pressure Gauge for T11 tester

T2

RIELLO PUMP TESTERS

The first tester specifically designed for the Riello pump! Quick-Connect European thread adaptors mount easily on the pump with just finger tightening. The 24" color coded flexible lines allow the tester to be placed in any convenient location for remote reading of the pump pressure and vacuum.

- ▶ Quick-connect European thread fittings require only finger tightening
- ▶ Liquid Filled gauges dampen pulsation - no hydraulic shock
- ▶ "Service Truck Tough" case

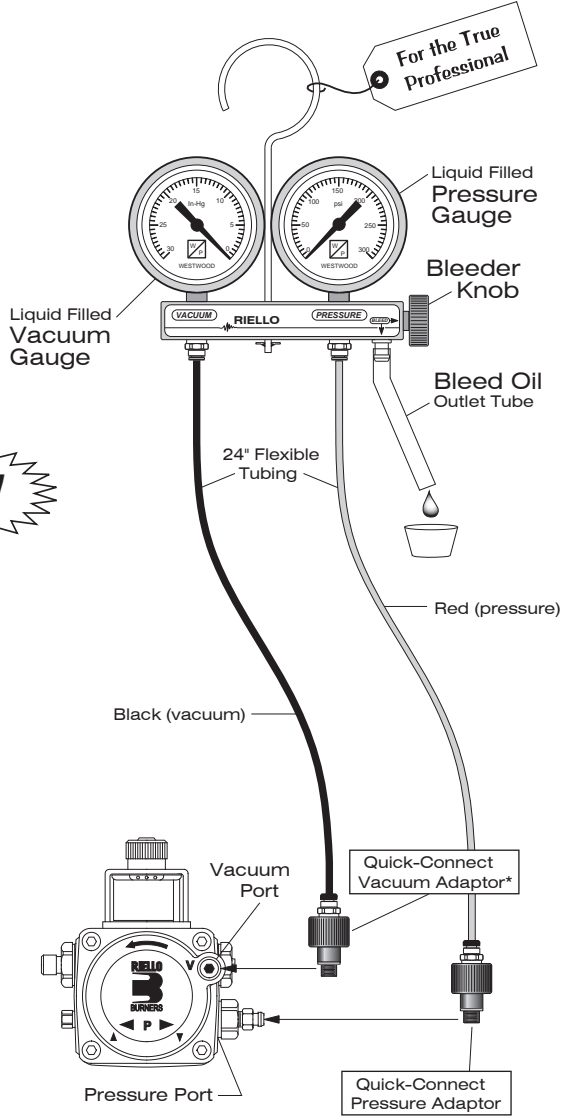
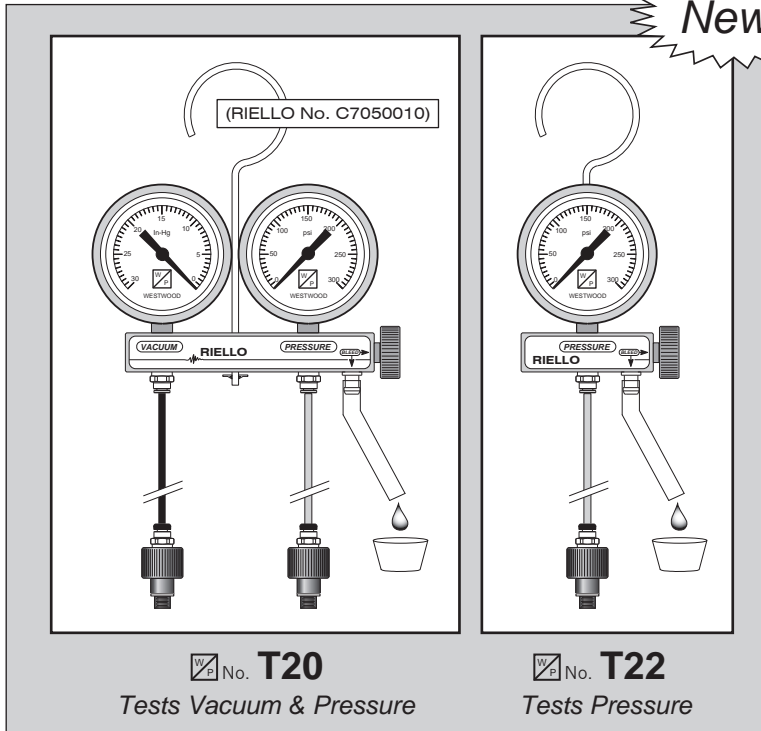

*Can also be used on older pumps that have the vacuum port on the side of the pump.

W/P No.	RIELLO No.	Description
T20	C7050010	Complete RIELLO tester with case, liquid filled gauges, Quick-Connect adaptor fittings
T20-10	-	Replacement hose set (1 ea. Red and Black) for T20 tester (hose only, no fittings)
T20-12	-	3 "O" rings for T20 Bleed Knob and 3 "O" rings for Quick Connect adaptor fittings
T20-14	-	Replacement Nylon washer for T20 and T22 tester Quick-Connect adaptors, Pkg. of 6
T20-16	-	Replacement "Drip Cap" for T20 and T22 tester Quick-Connect adaptors, Pkg. of 6
T20-18	-	Replacement carrying case for T20 tester
T20-20	-	Hose set for T20, Red and Black (includes hoses and fittings)
T22	-	RIELLO pressure tester with case, liquid filled gauge, Quick-Connect adaptor fitting
T22-10	-	Replacement hose (Red) for T22 tester (hose only, no fittings)
T22-18	-	Replacement carrying case for T22 tester
T22-20	-	Hose set for T22 (Red, includes hose and fittings)
S100-285	-	Replacement Liquid Filled 0-300 PSI pressure gauge (2-1/2" face) for T20 and T22
S100-295	-	Replacement Liquid Filled 0-30" Hg. vacuum gauge (2-1/2" face) for T20

Take a look ...

For testing SUNTEC & WEBSTER pumps see pages T1 & T2

Please order by No.

rev. 3-23-17

T3

Westwood

"VAC-PROBE" OIL LINE ACCESS PORT

Allows access to oil lines without opening or disconnecting fittings. Installed in place of the center bolt on the line filter it allows not only vacuum tests to be made quickly and neatly, but also affords easy access to the fuel system for pump priming and connection of a temporary oil line (run outs). One piece solid steel construction.

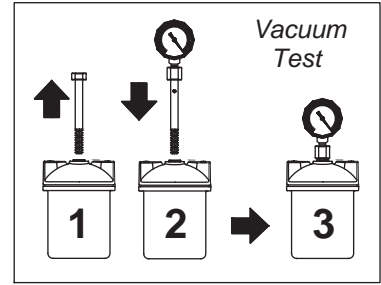

- ▶ Quickly and neatly access fuel system without disconnecting fittings!
- ▶ Liquid filled gauge dampens pulsation allowing precise measurement and protects gauge from hydraulic shock damage
- ▶ Models available for all popular heating oil line filters

 No.	Description
T25	Vac-Probe Kit; (1) Vacuum gauge, (4) Vac-Probes-1 ea.
T25-1	Vac-Probe w/gauge for small General 1A style filter
T25-2	Vac-Probe No. T25-1, less gauge
T25-3	Vac-Probe w/gauge for large General 2A style filter
T25-4	Vac-Probe No. T25-3, less gauge
T25-5	Vac-Probe w/gauge for Fullflo FB4, FB6, FB8, FB10
T25-6	Vac-Probe No. T25-5, less gauge
T25-7	Vac-Probe w/gauge for Firomatic C-40, C-50
T25-8	Vac-Probe No. T25-7, less gauge

STAINLESS STEEL LIQUID FILLED GAUGES

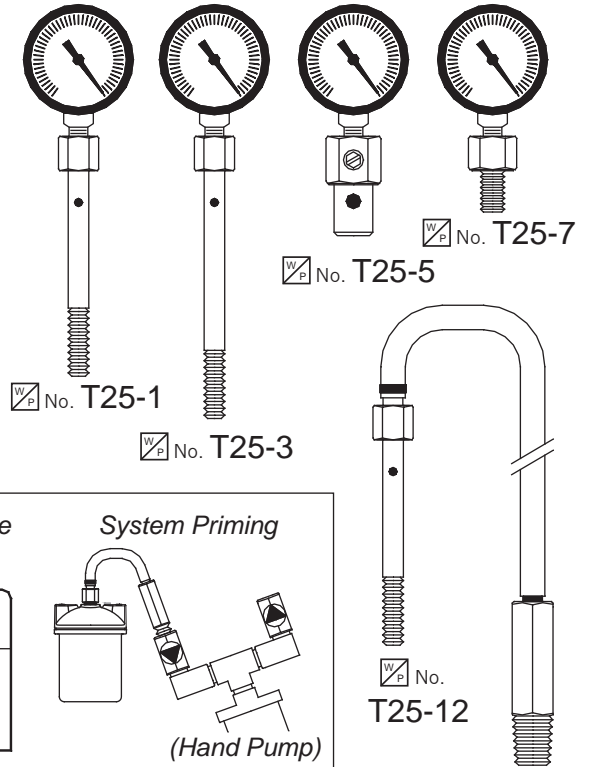

 No.	Vac-Probe Run Out Adaptor*
T25-12	For small General 1A style filter
T25-14	For large General 2A style filter
T25-16	For Fullflo FB4, FB6, FB8, FB10 filters
T25-18	For Firomatic C-40, C-50 filters

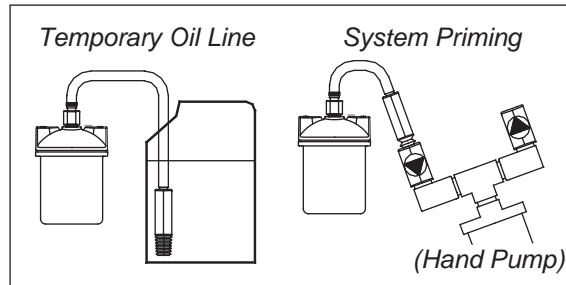

*Vac-Probe w/48" flexible hose connected to a heavy weight 3/8" NPT hand pump connection adaptor. Adaptor easily connects to a hand pump, or serves as a hose end weight when drawing oil from a can.

Westwood

"FLO-THRU"

Sliding Handle

BLEED WRENCH

- ▶ Quickly and neatly bleed oil burner pumps
- ▶ Handle slides side-to-side for easy bleeding

 No.	Description
T28	Bleed Wrench with 12" hose
T28-2	Replacement hose, Pkg. of 6

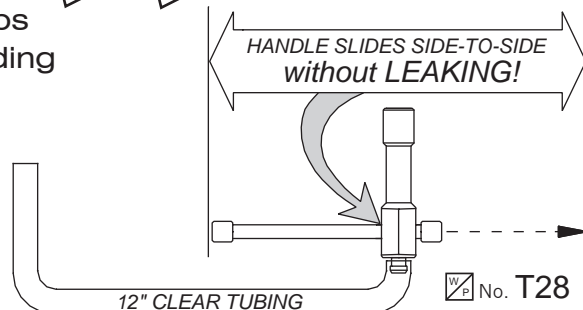

Westwood

"EASY ANGLE" PRESSURE & VACUUM HAND PUMPS

Hand operated piston pumps with built-in check valves for use with liquids and air. Ideal for clearing plugged oil lines, priming pumps, transferring liquids, and adding chemicals to boilers.

- ▶ Unique "EASY ANGLE" 120° valve angle makes connections easy
- ▶ Two Sizes - Standard and High Capacity
- ▶ High Capacity model gives 50% more volume per stroke!
- ▶ Exclusive center port for installation of a compound gauge allows monitoring of the system pressure and vacuum during operation
- ▶ Comfortable "T" handle and protective vinyl sleeve on barrel
- ▶ Quick-connect hose set attaches to hand pump using no tools! (Same, no tools needed connection to all popular hand pumps)



3/8" NPT Fittings
100 PSI max
27" Hg vacuum

No. T30-1
HIGH CAPACITY

No. T30
STANDARD
(gauge optional)

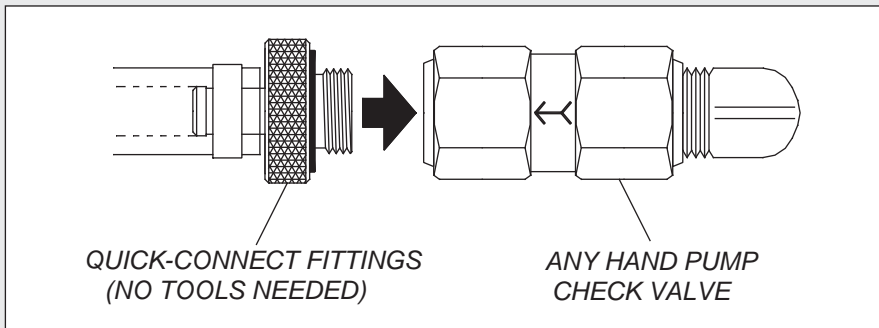

QUICK-CONNECT FITTINGS
(NO TOOLS NEEDED)

ANY HAND PUMP
CHECK VALVE

No. T30-4

QUICK-CONNECT FITTINGS & HOSE SET

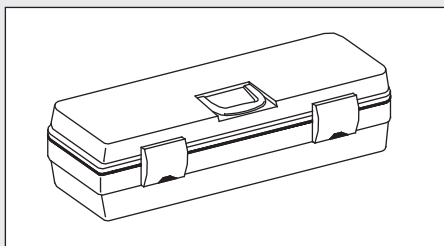

No. T30-6

CARRYING CASE FOR T30 & T30-4



No. S100-402

CENTER PORT COMPOUND GAUGE
30" Hg. - 150 PSI (2" FACE, 1/8" NPT)



No. T30-4

QUICK-CONNECT
FITTINGS & HOSE SET

- Contents:
- 2 - 2 FT Hoses
 - 1 - 1/2" Flare Adapter
 - 1 - Garden Hose Adapter
 - 2 - Hose Caps

No.	Description
T30	Standard hand pump w/1/8" NPT center access port
T30-1	High capacity hand pump w/1/8" NPT center access port
T30-4	Quick-connect, no tools needed fittings and hoses set
T30-6	Plastic carrying case for T30 hand pump, fittings and hoses
T30-8	"O" ring for T30, -1 and all 1-1/4" barrel pumps, Pkg. of 2
S100-402	Compound pressure-vacuum gauge for center access port
S230	Replacement check valve, 3/8" NPT, genuine Firomatic®





Please order by No.

rev. 04-11-17

T5

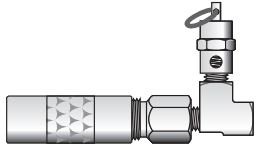
Westwood

CO₂ BLOW OUT GUNS & KITSFOR QUICKLY CLEARING PLUGGED LINES
ALL BRASS CONSTRUCTION

W/P No.	Reference No.	Description & Representative Picture
T32	ML-3	CO ₂ blow out gun for clearing clogged oil lines and instrument transmission lines. Built-in check valve allows spent cartridge to be removed without loss of pressure. 
T32-10	ML-3-150	CO ₂ blow out gun with built-in safety valve. Limits pressure at outlet of gun to 150 PSI. Since CO ₂ cartridges produce approximately 800 PSI, the additional pressure is relieved should a severely restricted line be encountered. 
T32-11	ML-3-150-UPG	150 PSI safety valve upgrade kit for blow out gun (Relief valve and angle adapter, 1/8"-NPT) 
T32-15	ML-3-P1000	CO ₂ blow out gun with 1,000 PSI pressure gauge. Accurately monitors pressure in the line during clearing. Constant pressure indicates line is blocked; falling pressure means blockage is moving; no pressure means line is clear. Complete kit includes blow out gun with gauge, box of CO ₂ cartridges, plastic carrying case, and instructions 
T32-16	ML-3-PQ	CO ₂ blow out gun with Quick-Connect Kit for quickly connecting to different line sizes. Kit includes blow out gun with 1,000 PSI pressure gauge, quick-connect coupling, (1) ea. 3/8" & 1/2" compression connectors, (1) ea. 3/8" & 1/2" flare connectors, plastic carrying case, and instructions 
T32-20	QCK-1 Kit	Quick-Connect Fittings Kit (blow out gun not included). Contains quick-connect coupling, (1) ea. 3/8" & 1/2" compression connectors, (1) ea. 3/8" & 1/2" flare connectors 
T32-25	"O" rings	Replacement "O" ring for blow out gun, package of 6

 Take a look...
CO₂ CARTRIDGES on page T7

rev. 5-1-07

T6Please order by  No.



Westwood
CO₂ CARTRIDGES

 No.	Reference No.	Description
T32-30	CO ₂ Cartridges	CO ₂ cartridges, 8 gram, 800 PSI, Box of 10*

* 36 boxes of 10 cartridges per case

Westwood
FLAME MIRRORS & PILOT LIGHTERS

Telescoping Handle

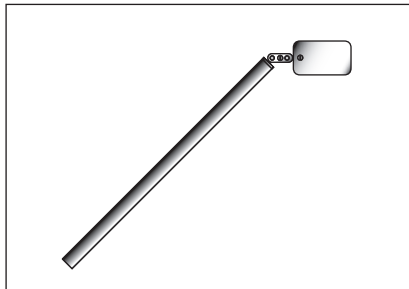

 No. T34-10

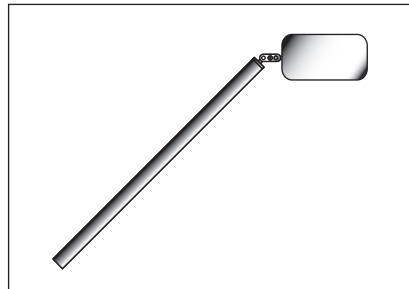

 No. T34-15

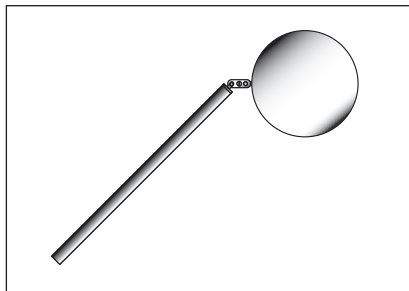

 No. T34-25



 No. T34-35



 No. T34-40

 No.	Reference No.	Description
T34-10	MR-1X2	1-1/4" x 2" telescoping rectangular flame mirror
T34-15	MR-2X3	2" x 3-3/4" telescoping rectangular flame mirror
T34-25	MR-4	4-1/4" diameter telescoping round flame mirror
T34-35	ML-26	24" telescoping pilot lighter
T34-40	12" Lighter	12" pilot lighter, plated handle, non-telescoping

Westwood is proud to introduce the **BRIGON** line of quality combustion test equipment. One of the world's oldest and most respected manufacturers of test equipment for the heating industry, **BRIGON** offers advanced European technology at an affordable price. And while the **BRIGON** name may be unfamiliar in North America, the products will be immediately recognized as interchangeable with test equipment widely used here today.

Westwood

OIL BURNER COMBUSTION TEST KIT

BRIGON

T35 TEST KIT CONTAINS:

- CO₂ Indicator
- CO₂ Indicator sampling assembly
- Stack thermometer - 900° F
- Draft gauge & sampling hose assembly
- Smoke tester with smoke test paper and smoke scale
- Efficiency calculating slide rule
- Steel carrying case



 No. T35

Westwood

OIL BURNER CO₂ INDICATOR KIT

BRIGON

T36 TEST KIT CONTAINS:

- CO₂ Indicator
- CO₂ Indicator sampling assembly
- Efficiency calculating slide rule
- Carrying case



 No. T36

 No.	Description	Replaces Bacharach
T35	BRIGON Oil burner combustion test kit with carrying case	10-5022
T35-1	T35 kit with smoke tester & stack thermometer manufactured by Westwood	10-5022
T36	BRIGON CO ₂ indicator kit with carrying case	10-5000
T36-2	BRIGON CO ₂ indicator only	11-7032
T36-10	Replacement sampling assembly for BRIGON and Bacharach CO ₂ indicator	11-7029
T36-12	Replacement bulb only for BRIGON and Bacharach sampling assembly	11-0120
T36-14	Replacement red (in) check valve for BRIGON and Bacharach sampling assembly	11-0138
T36-15	Replacement green (out) check valve for BRIGON and Bacharach sampling assembly	11-0127
T36-16	Replacement rubber hose for BRIGON and Bacharach sampling assembly	11-0119
T36-18	Replacement filter tube w/yarn for BRIGON and Bacharach sampling assembly	11-0130
T36-20	BRIGON Efficiency calculating charts	-

Westwood

SMOKE TESTER - POLYCARBONATE BARREL

- ▶ Virtually unbreakable Polycarbonate barrel
- ▶ Hardware all Brass and Stainless Steel
- ▶ Sampling tube hooks into smokepipe
- ▶ Fits into **BRIGON** and Bacharach cases
- ▶ Lifetime silicone lubrication

POLYCARBONATE
no dents, no corrosion!

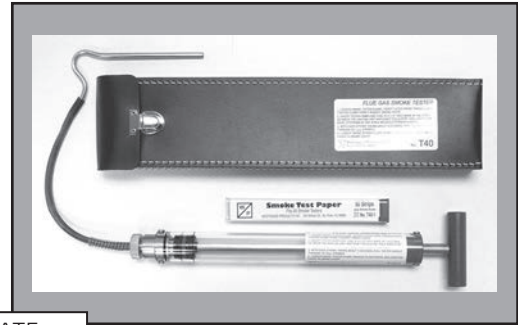

No. T40

Reliable and durable instrument for measuring the smoke number of a flue gas sample. Flue gas is taken from an opening in the flue pipe and drawn through the smoke test paper mounted in the tester. Comparison of the test paper with the smoke scale determines the smoke scale number.

INCLUDES : SMOKE TESTER, SMOKE TEST PAPER, SMOKE SCALE, CARRYING CASE

Westwood

UNIVERSAL SMOKE TEST PAPER

- ▶ Precut strips for use in all smoke testers
- ▶ Includes smoke scale
- ▶ Sturdy dust & dirt proof plastic package



No. T40-1

*Pkg. of 50 strips
with smoke scale*

BRIGON SMOKE TESTER

- ▶ Corrosion proof construction
- ▶ Fits into **BRIGON** and Bacharach cases

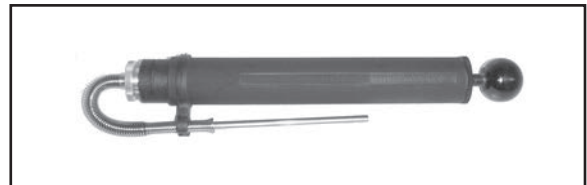

No. T41

No.	Description	Replaces Bacharach
T40	Westwood polycarbonate barrel smoke tester kit with carrying case	21-7006
T40-1	Westwood Universal precut smoke test paper and smoke scale, Pkg. of 50 strips	21-0019
T41	BRIGON smoke tester	21-7006
T41-1	BRIGON smoke test paper, Pkg. of 40 papers	21-0019
T41-2	BRIGON smoke scale	21-0018
T41-5	BRIGON smoke tester lubricant	-

Westwood

STAINLESS STACK THERMOMETER

- Stainless steel construction
- 3" Face - 6" Insertion Probe
- Includes stack mounting clip
- Fits BRIGON and Bacharach cases
- Range: 200° - 1000° F



No. T42

BRIGON

STACK THERMOMETER

- Stainless steel construction
- Fits BRIGON and Bacharach cases
- Range: 0° - 900° F



No. T43

BRIGON

DRAFT GAUGE

- ▶ Precision instrument for accurate readings
- ▶ Tough, lightweight construction
- ▶ High visibility scale, -.25" to +.05" WC
- ▶ Requires no leveling for accurate readings
- ▶ 9' flexible hose with 5" draft probe

This precision instrument measures draft with accuracy not attainable with pocket draft or styrofoam ball and tube type gauges. Its high strength case stands up to daily use and will not damage the way Bakelite cases do.



No. T45

Westwood

CO₂ INDICATOR SERVICE PARTS & FLUID

FOR
BACHARACH & BRIGON
TESTERS



No. T50-2, -5



No. T50-3

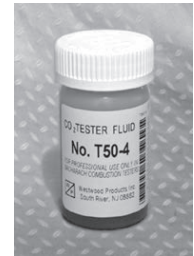

No. T50-4

No.	Description	Replaces Bacharach
T42	Westwood stainless steel stack thermometer	12-7014
T43	BRIGON stack thermometer	12-7014
T45	BRIGON precision draft gauge	13-7019
T45-1	Replacement hose & probe for BRIGON draft gauge	-
T50-2	Westwood CO ₂ Indicator Repair Kit, (1) Bottle CO ₂ Fluid, Valve Plunger Seal, Top Gasket, Diaphragm, Screws, Filtering Material, Nitrile Gloves, for Bacharach	11-7052
T50-3	Westwood CO ₂ Indicator Recharging Kit, (2) Bottles CO ₂ Fluid, Top Gasket, Screws, Filtering Material, Nitrile Gloves, for Bacharach	11-7047
T50-4	Westwood CO ₂ Indicator Fluid, (1) Bottle, for Bacharach and BRIGON	-
T50-5	Westwood Repair Kit for BRIGON CO ₂ Indicator, (1) Bottle CO ₂ Fluid, Valve Plunger Seal, Top Gasket, Diaphragm, Screws, Filtering Material, Nitrile Gloves	-

Westwood

OIL BURNER IGNITION TRANSFORMER TESTER

- ▶ Safely tests from the transformer's primary side
- ▶ Transformer remains on the burner for testing
- ▶ Detects early stages of transformer breakdown
- ▶ Easy access built-in fuse protects meter
- ▶ Simple, easy-to-read meter
- ▶ Plugs into 120 volt outlet (ie. trouble light)
- ▶ "Service Truck Tough" with high impact case

Test standard iron core 10,000 volt oil burner ignition transformers quickly and safely with this rugged, easy-to-use tester. All testing is done from the primary side of the transformer avoiding contact with the high voltage terminals. Tests transformer while mounted right on the burner. (Note: Not for testing solid state igniters)



 No. T60

Westwood

CAD CELL RELAY & EYE TESTER

- ▶ Tests primary control and eye right on the burner
- ▶ Simple, easy-to-read and understand ohmmeter
- ▶ Built-in flame simulators for all popular controls
- ▶ "Service Truck Tough" with high impact case

Test both cad cell primary control and flame detector eye simultaneously without removing components from the burner. Built-in flame simulators for all popular controls insure accurate diagnosis and testing.



 No. T70

Westwood

"AMP-MASTER" THERMOSTAT CIRCUIT METER

- ▶ Accurately measures thermostat control circuit draw to correctly adjust heat anticipator setting
- ▶ Meter dial matches T87F heat anticipator scale
- ▶ "Service Truck Tough" with high impact case

Precisely measures the thermostat control circuit current to allow correct setting of the heat anticipator. Avoids repeat service calls to remedy short cycling or override problems. Connects at either the thermostat or relay.



 No. T80

 No.	Description
T60	Standard 10,000 volt oil burner ignition transformer tester
T70	Cad cell primary control and flame detector eye tester
T80	"AMP-MASTER" thermostat heat anticipator meter

Westwood

"EASY ACCESS" PRESSURE TESTER

0 - 100 PSI PRESSURE GAUGE • ALL BRASS CONSTRUCTION

FOR LEAK TESTING TANKLESS COILS AND PRESSURE TESTING NEW PIPING

The ideal tester for checking tankless coils for leaks, and pressure testing new piping of all types prior to building code inspections. Easily connects to any convenient garden hose thread (ie. boiler drain valve, wash tub faucet, etc.) without disturbing any fittings in the system. Built-in Schrader valve allows system pressurization with just a simple bicycle pump. Comes in a rugged, "Service Truck Tough" high impact case.

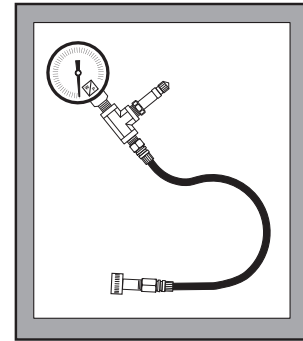
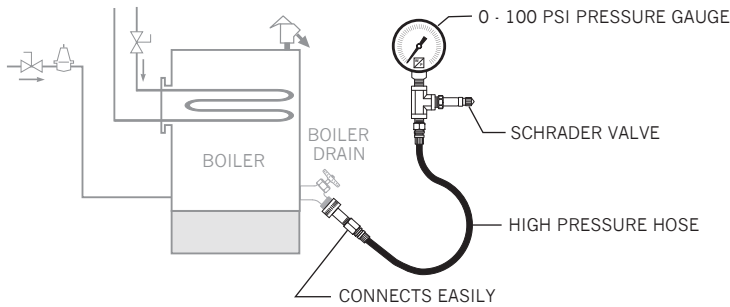

No. T90

Westwood

GAS PRESSURE TESTER

- ▶ Precision 0-15" WC "EZ Read" gauge with color coded dial for natural and L. P. gas
- ▶ 36" flexible hose with 1/8"- NPT brass adaptor
- ▶ "Service Truck Tough" with high impact case

For setting pressure of natural and L. P. gas appliances without the troublesome inconvenience and mess of water filled manometers. Gauge is precision diaphragm type with a 2-1/2" color coded "EZ Read" dial.



No. T91

Westwood

"PILOT PUFFER" LINT & DUST BLOWER

- ▶ Cleans hard-to-reach gas pilot burners and orifices
- ▶ Durable, rust proof 11" brass air tube
- ▶ Flexible, long life flexible rubber bulb

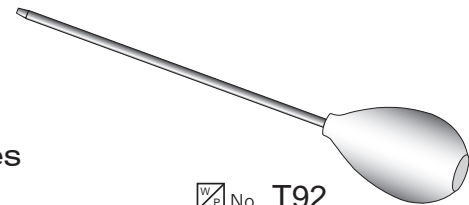

No. T92

No.	Description
T90	"EASY ACCESS" tankless coil and piping pressure tester
T91	Gas pressure tester for natural and L.P. gas
T92	"PILOT PUFFER" gas pilot and orifice lint and dust blower

SMOKE PRODUCTS

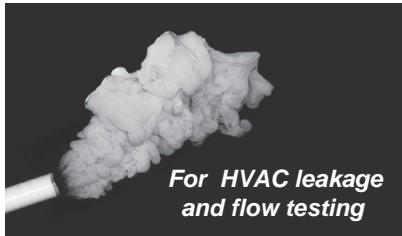

No. T95 (Series)

LOW VOLTAGE TESTER

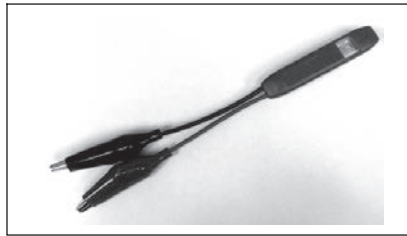

No. T100-10

LINE VOLTAGE TESTER



No. T100-15

CORD & CLIP SET - 8' Long

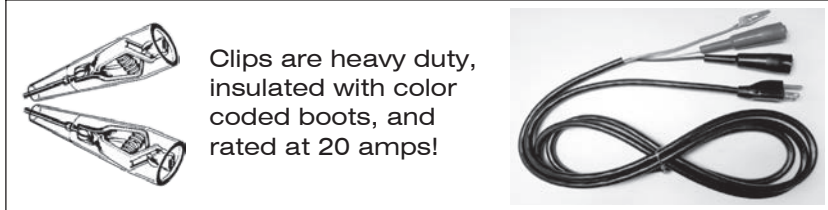

No. T100-50

JUMPERS - Insulated & non-insulated

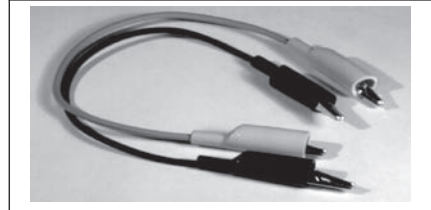

No. T100-70 through -84

POCKET DIGITAL THERMOMETER

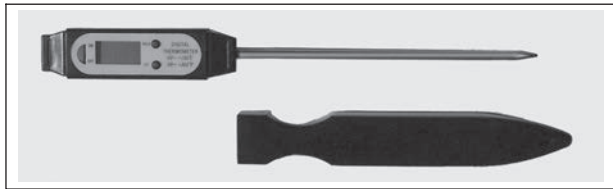

No. T100-120

POCKET DIAL THERMOMETER

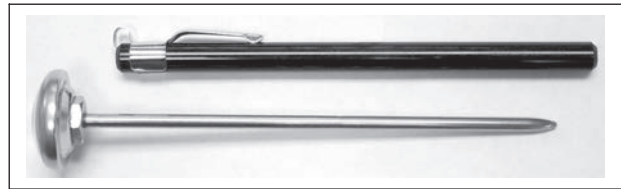

No. T100-125, -130

SMOKE, VOLTAGE TESTERS, CORD & CLIP SET, JUMPERS, POCKET THERMOMETERS

No.	Reference No.	Description
T95-20	-	Smoke emitter sticks, 20 seconds of smoke per stick, package of 25 sticks
T95-22	-	Smoke emitter pen with 6 wicks, 30 seconds of smoke per test, 60 tests per wick
T95-24	-	Smoke emitter pen refill wicks, package of 6 wicks
T95-26	-	Smoke emitter cartridges, 90 seconds of smoke, package of 10 cartridges
T95-28	-	Smoke emitter cartridges, 3 minutes of smoke, package of 5 cartridges
T100-10	LV Tester	Pocket low voltage tester, 5 - 50 VAC/VDC
T100-15	SD Tester	Pocket screwdriver line voltage tester, bright red light, 70 - 250 VAC
T100-50	7328	110 VAC/15A cord & clip set, 8' long cold weather flexible wire, w/ground wire clip
T100-70	JW-12	18 gage stranded wire jumper, non-insulated clips, 12" long
T100-72	JW-18	18 gage stranded wire jumper, non-insulated clips, 18" long
T100-74	JW-36	18 gage stranded wire jumper, non-insulated clips, 36" long
T100-80	IJW-12	18 gage stranded wire jumper, insulated clips, 12" long
T100-82	IJW-18	18 gage stranded wire jumper, insulated clips, 18" long
T100-84	IJW-36	18 gage stranded wire jumper, insulated clips, 36" long
T100-120	HDT 303K	Pocket digital thermometer, range: -58° to +572° F
T100-125	T-160	Pocket dial thermometer, range: -40° to +160° F
T100-130	T-220	Pocket dial thermometer, range: 0° to +220° F

Appearance of testers and thermometers may vary from those shown

Please order by No.

rev. 12-15-15

Westwood

NAS gauge™ NOZZLE ASSEMBLY SETTING GAUGES

NO GUESSWORK • NO BLIND ADJUSTMENTS • NO BURNER REMOVAL

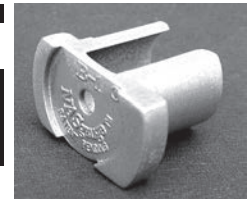

Proper **NOZZLE - COMBUSTION HEAD** relationship without removing the burner!

- ▶ Gauges are made of high impact polystyrene for long service life
- ▶ The B-1 & W-1 gauges are also used to set the electrode tips
- ▶ Available individually or in a complete kit containing all three gauges



B-1 For Beckett
Models AF, AFG, SR,
SF with "F" heads and
SF II with "FBX" head

No. **T100-202**



A-1 For Aero
Models HF-US, SV,
SSV, F-AFC, HF-AFC

No. **T100-204**



W-1 For Wayne
Models EG-1, M-SR,
EH-SR, EHA-SR

No. **T100-206**

No. **T100-200** (Kit containing all 3 gauges)

EASY TO USE:

1. Slide *NAS gauge™* over the nozzle.
2. Insert nozzle assembly until it touches the combustion head.
3. Mark the position of the slide plate and remove *NAS gauge™*

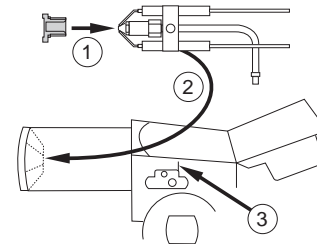

Westwood

ELECTRODE GAUGE



No. **T100-220**

Accurately sets electrode gap and placement from the nozzle based on nozzle spray angle.

Westwood

ELECTRODE BENDERS

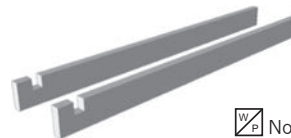

No. **T100-230**

Pair of 5" long case hardened tools designed specifically for bending and adjusting electrode tips.

No.	Reference No.	Description
<i>T100-200</i>	<i>NAS-ABW</i>	<i>NAS gauge™ nozzle assembly setting gauge kit, (3) gauges, instructions</i>
<i>T100-202</i>	<i>NAS-B1</i>	<i>NAS gauge™ nozzle assembly setting gauge for Beckett burners</i>
<i>T100-204</i>	<i>NAS-A1</i>	<i>NAS gauge™ nozzle assembly setting gauge for Aero burners</i>
<i>T100-206</i>	<i>NAS-W1</i>	<i>NAS gauge™ nozzle assembly setting gauge for Wayne burners</i>
<i>T100-220</i>	<i>Ignitor Gage</i>	<i>Electrode tip setting gauge</i>
<i>T100-230</i>	<i>TB-60</i>	<i>Electrode tip benders, 5" long case hardened steel, set of 2 benders</i>

Westwood

Coupler Popper™ with Coupler Aligner / Installer

This handy tool removes coupling ends stuck on the motor shaft from the pump side of the burner. No need to remove the motor! It also measures the proper dimension to cut a new coupling for a perfect fit, installs couplings through the pump side of the burner, and centers the pump end of the coupling for perfect alignment with the pump shaft. A real time saver that no service tech should be without.

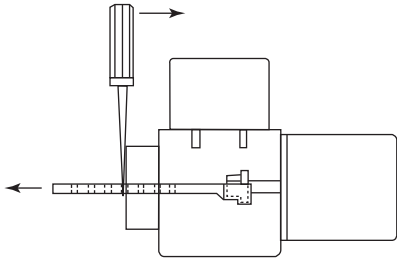

Removing stuck coupling end piece on motor shaft from pump side of burner

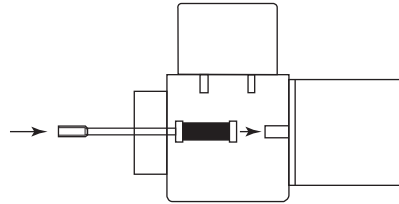

Using Aligner/Installer to install coupling on motor shaft from pump side of burner

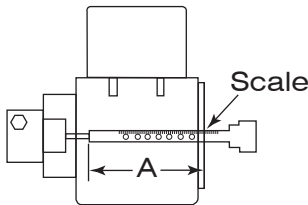

Measuring for proper coupling length (dimension "A" minus 13 marks on the Coupler Popper™ scale)

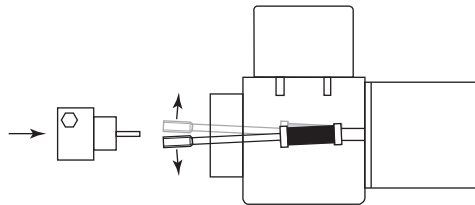

Using Aligner/Installer to center coupling end for perfect alignment with pump shaft

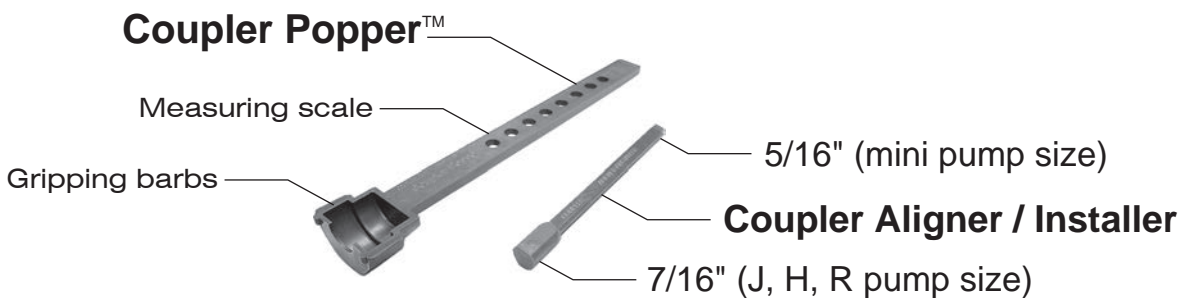

 No.	Ref. No.	Description
T100-300	CP-1	Coupler Popper™ multi purpose coupling tool with Coupler Aligner/Installer

 Take a look . . .

COUPLING CUTTER on page T16

Please order by  No.

rev. 5-1-07

Westwood

COUPLING & GAUGE GLASS CUTTERS**Use the right tool for the job!**

FIELD PROVEN • RUGGED CONSTRUCTION • QUALITY MATERIALS

COUPLING CUTTER

Cuts coupling shafts quickly and cleanly. No twisting or turning necessary. Cuts 1/8" to 1-1/4" O.D. rubber, polyethylene, neoprene, vinyl, PVC, etc. Reversible blade gives twice the blade life. Curved handles are easy on the hands.

 No. T100-310
GAUGE GLASS CUTTERS

Note: Always wear gloves and eye protection when working with glass

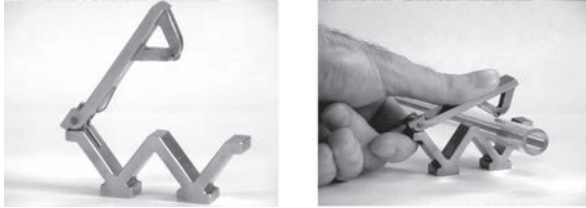
 No. T100-330

The only one recommended for cutting Red Line and High Pressure gauge glass. Cuts easily leaving a clean, straight edge. Just score and snap!

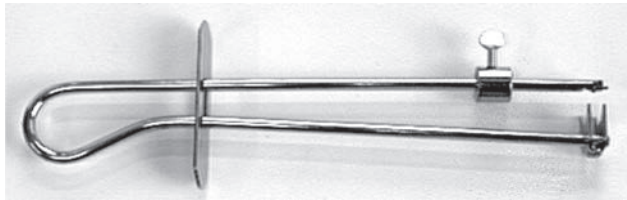
 No. T100-340

For cutting standard gauge glass. Cuts pieces as short as 1/2" or less. Set the stop to the desired length, squeeze the "trigger" and rotate the glass until it snaps cleanly in two.

 No. T100-350

For cutting standard gauge glass. Set the stop to the desired length, squeeze the handles and rotate the glass until it snaps cleanly in two.

 No.	Ref. No.	Description
T100-310	#35	Coupling cutter, heavy duty die cast metal handles, reversible blade
T100-312	#35 Blade	Replacement blade for T100-310
T100-330	WP-1	Gauge glass cutter for standard, Red Line, and High Pressure glass
T100-332	-	Replacement cutting wheel for T100-330
T100-340	#996	Gauge glass cutter with adjustable stop for standard glass
T100-342	#996-W	Replacement cutting wheel for T100-340
T100-350	RD-95	Gauge glass cutter for standard glass, adjustable stop, cast metal handles
T100-352	RD-95-W	Replacement cutting wheel for T100-350

 Take a look...

T100-370 PORCELAIN CUTTER also cuts gauge glass, see page T17

T16

rev. 5-1-07

Please order by  No.

Westwood

PORCELAIN CUTTER

Use the right tool for the job!

FIELD PROVEN • HEAVY DUTY CONSTRUCTION • HARDENED CUTTING WHEELS

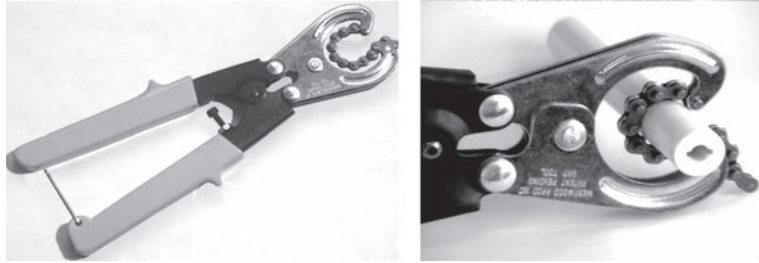

No. T100-370

NEW DESIGN! Easier to use!

Replaces the old tool with external chain - no more wrapping the chain around! Powerful compound lever action snaps even the toughest oil burner porcelain. Hardened and tempered cutting wheels, sure-grip molded handles, hardened steel jaws, locking clasp, adjustable stop.

Westwood

MASTER LINEMAN'S PLIERS & CRIMPER



No. T200-10

The Grandson of the famous Rajah™ Crimping Tool!

A service tech's dream come true! All the features of lineman's pliers, plus the ability to cut, strip, and crimp ignition cable and terminals. Hand fitted and finished to make this professional quality tool a joy to use and a pleasure to look at.

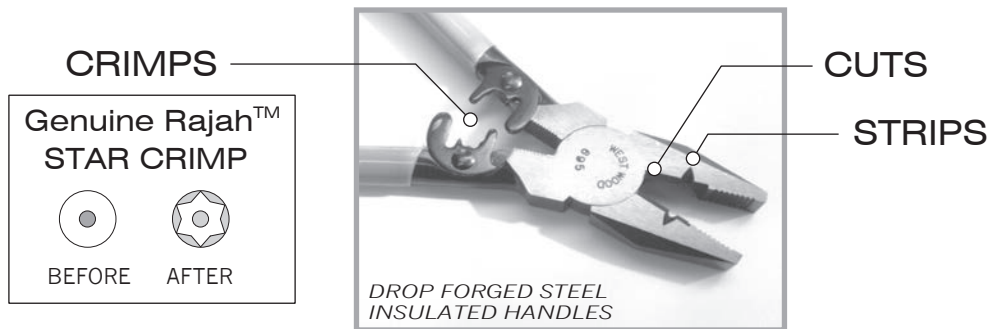

No.	Ref. No.	Description
T100-370	#997	Porcelain cutter, heavy duty chain, hardened wheels & jaws
T100-372	-	Replacement cutting chain for T100-370
T200-10	#695	Master Lineman's Pliers & Terminal Crimper, drop forged steel, 8-1/2" long

Westwood
CRIMPING TOOL

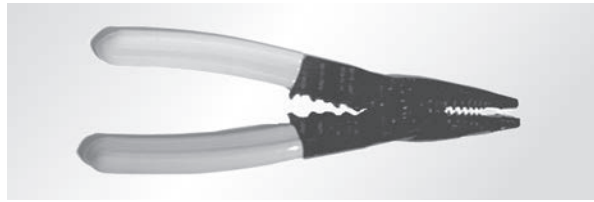

 No. T200-15

Cuts and strips #10 to #22 gage wire. Crimps standard insulated, non-insulated, and 7mm automotive type terminals. (for Rajah™ ignition terminals, see T200-10 Lineman's pliers and crimper on page T17)

Westwood
HEX KEY WRENCH SETS

HEAT TREATED!

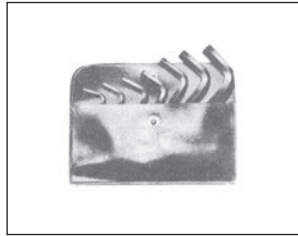

 No. T200-50

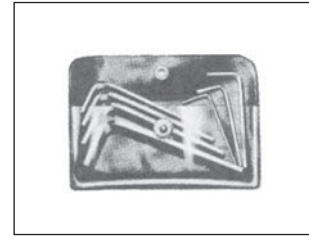

 No. T200-52

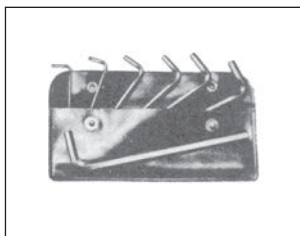

 No. T200-54

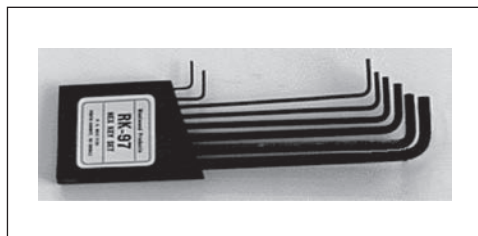

 No. T200-56



 No. T200-58

Westwood
CIRCULATOR FLANGE TOOL

For installing popular B&G and Taco circulator flanges on pipe. Use with a socket or wrench.

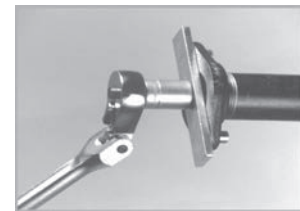

 No. T200-80

 No.	Ref. No.	Description
T200-15	#271	Cutting - Crimping - Stripping tool, for standard wire terminals
T200-50	LK-66	Long hex key set in pouch, 5/64", 3/32", 1/8", 5/32", 3/16", 7/32", 1/4"
T200-52	SK-59	Short hex key set in pouch, 5/64", 3/32", 1/8", 5/32", 3/16", 7/32", 1/4"
T200-54	XK104	6" long hex key set in pouch, 5/64", 3/32", 1/8", 5/32", 3/16", 7/32", 1/4"
T200-56	RK-97	Hex key set in case, .050, 1/16", 5/64", 3/32", 1/8", 5/32", 3/16", 7/32"
T200-58	HK-17	Folding hex key set, .050, 1/16", 5/64", 3/32", 1/8", 5/32", 3/16"
T200-80	FT-1	Circulator flange installation tool, square drive

INDEX

A

Absorbent pads & socks, S26
 Adapter, flexible oil lines, S20
 Adapter, gauge, S11
 Additive, heating oil, C1
 Alligator clip cord set, T13
 Alligator clips, E29
 Altitude gauges, H7
 Amp tester, T11
 AMP-MASTER tester, T11
 Anti-siphon valves, S20, S21
 Aquastat wells, H8
 Assemblies, Auburn, E15 - E23
 Assemblies, cable, E30
 Assemblies, Champion, E24
 Assemblies, filtration, F7
 Auburn products, E15 - E23

B

B&G circulator, couplings for, H5
 Bacharach, repair parts for, T10
 Bags, vacuum cleaner, S25
 Beckett burner flange gasket, S3
 Beckett nozzle line fittings, S13
 Beckett, NYLO-FLEX for, S5
 Beckett, tune-up kits for, S7, S8
 Belts, MAX-DRIVE v-belts, S1
 Benders, electrode, T14
 BIG GUY filter elements, F9
 Black iron steam pig tails, H3
 Bleed wrench, T4
 Bleeder fitting, spin-on filter, F6
 Bleeders, radiator, H8
 Blow down kit for McD & M, H4
 Blow out gun, CO2, T6
 Blower wheels, S9
 Blue Angel tune-up kit, S8
 Boiler probes, Fulton boilers, H9
 Bolts, circulator flange, H4
 Boots, insulating, E29
 Brass steam pig tails, H3
 Brass, buss bars, E27
 Brazed plate heat exchangers, H10
 Brigon combustion testers, T8 - T10
 Bulbs, rough service, E31
 Burner fans, S9
 Burner flange gasket, S3
 Bushings, electrode, E27
 Buss bars, E27
 By-pass plugs, S13

C

Cable assemblies, E30
 Cable ties, E31
 Cable, high voltage, E30
 Cable, ignition, E30
 Cable, red & white silicone, E30
 Cad cell eye, E32
 Cad cell flame detector, E32
 Cad cell tester, T11
 Can, filter upgrade kit, F12
 Canister upgrade kits, F12
 Cap, garden hose, H8
 Carlin, NYLO-FLEX for, S5
 Carlin, tune-up kits for, S8

Cartridges, CO2, T7
 Cast iron top filters, F1, F2
 Cerafelt chamber liners, S2
 Ceramic boots, terminal, E29
 Ceramic spark plug boots, E29
 Chamber liners, S2
 Champion ign. assem, E24
 Charges, CO2, T7
 Check valves, S20
 CHERRY BLAST odor powder, C1
 Circulator couplings, H5
 Circulator flange bolts, H4
 Circulator flange gaskets, H4
 Circulator flange tool, T18
 CLASSIC FELT filter element, F10
 CLASSIC YARN filter element, F11
 Cleanup supplies, S26
 Cleaver Brooks ring, E27
 Cleaver Brooks spring, E27
 Clips, alligator, E29
 Clips, electrical, E29
 Clips, jumper, T13
 CO2 blow out gun, T6
 CO2 cartridges, T7
 CO2 indicators, T8
 CO2 tester fluid & parts, T10
 CO2 testers, T8
 COMBI oil de-aerator, S18
 Combination gauges, H7
 Combustion chamber liners, S2
 Combustion test equip., T8 - T10
 Commercial element, 2A-300, F10
 Commercial spin-on filters, F3 - F6
 Compound gauges, S11
 Connectors, wire, E31
 Copper gaskets, E27
 Copper oil lines, S13
 Cord & clip set, T13
 Coupler Popper tool, T15
 Coupling cutter, T16
 Coupling kits, S4, S6
 Coupling, for B&G circulators, H5
 Couplings, motor, S4
 Couplings, NYLO-FLEX, S5
 Couplings, one piece, S4
 Couplings, SPIRALINK, H6
 Couplings, spline, S4
 Coveralls, disposable, S26
 Crank arm linkage, S23
 Crimpers, terminal, T17, T18
 Cutter, coupling, T16
 Cutter, porcelain, T17
 Cutters, gauge glass, T16

D

Danfoss, strainers for, S12
 DE GREASE IT Plus, solvent, C2
 DE GREASE IT solvent, C2
 De-aerator, oil, S14 - S18
 Degreasers, C2
 Deodorant, C1, C3
 Dial thermometer, H7
 Digital pocket thermometer, T13
 Dirt pocket cap for McD & M, H4
 Disposal bags, S26

Distributor nipple, E29
 Double wall heat exchgrs, H10
 Draft gauge, T10
 Draft regulator, S22
 Draft stabilizer, TIGEX®, S22
 Drop cloth, S26
 Dry comb. chamber liners, S2
 Ducane, NYLO-FLEX for, S5
 Dust masks, S26

E

EASY ACCESS tester, T12
 EASY ANGLE hand pump, T5
 Electrical clips, E29
 Electrode benders, T14
 Electrode kits, E13, E14, S7, S8
 Electrode setting gage, T14
 Electrodes, Auburn, E15 - E23
 Electrodes, Champion, E24
 Electrodes, E1 - E24
 Elements, BIG GUY, F9
 Elements, filter, 10 micron, F5, F10
 Elements, filter, felt, F10
 Elements, filter, Pure-Oil, F9
 Elements, filter, yarn, F11
 Epoxy coated canisters, F1 - F12
 Eye, cad cell, E32
 E-Z CONNECT, S20

F

Fans, S9
 FB10, element for, F9, F11
 FB4, element for, F9, F11
 FB6, element for, F9, F11
 FB8, element for, F9, F11
 Feeder, McD & M, parts for, H4
 Felt filter elements, F10
 Fiberglass braid, E30
 Fiberglass rope, S3
 Filter canister upgrade kit, F12
 Filter elements, 10 micron, F5, F10
 Filter elements, BIG GUY, F9
 Filter elements, felt, F10
 Filter elements, Pure-Oil, F9
 Filter elements, ULTRA-10, F10
 Filter elements, yarn, F11
 Filter Life Indicator, F6
 Filter, canister type, F1, F2
 Filter, canister upgrade kit, F12
 Filters, commercial spin-on, F5
 Filters, dual, F7
 Filters, F1 - F12
 Filters, gaskets for, F11
 Filters, secondary filtration, F7
 Filters, spin-on, F5
 Filters, with BIG GUY element, F2
 Firematic valve, S15
 Firematic, elements for, F9
 Fitting, garden hose, H8
 FITZ-ALL pump tester, T2
 Flame detector, cad cell, E32
 Flame mirrors, T7
 Flame rods, Auburn, E21
 Flange bolts, circulator, H4

Flange gasket material, H4
 Flange gasket, burner, S3
 Flange tool, T18
 Flexible oil lines, S19
 FLEXI-LINK circulator coupling, H5
 Floating suction line, S22
 FLO-THRU pump bleed wrench, T4
 Friction washers, gauge glass, H3
 Fuel filter gaskets, F11
 Fuel oil additive, C1
 Fuel oil treatment, C1
 Fuel oil, filters, F1 - F12
 Fuel stabilizer, C1
 Fuel treatment, C1
 Fulflo FB10, element for, F9, F11
 Fulflo FB4, element for, F9, F11
 Fulflo FB6, element for, F9, F11
 Fulflo FB8, element for, F9, F11
 Fulton boilers, level probes for, H9
 Furnace oil line kit for Miller, S13

G

Garden hose cap & fitting, H8
 Gas pressure tester, T12
 Gasket material, red rubber, H4
 Gasket set, Fulflo, F11
 Gaskets, circulator flange, H4
 Gaskets, dirt pocket cap, H4
 Gaskets, fuel filters, F11
 Gaskets, pump strainer, S12
 Gauge adapter, S11
 Gauge glass cutters, T16
 Gauge glass friction washers, H3
 Gauge glass nuts, H3
 Gauge glass repair kit, H3
 Gauge glass sets, H3
 Gauge glass washers, H1, H2
 Gauge glass, H1, H2
 Gauge glass, high pressure, H2
 Gauge glass, red line, H2
 Gauge glass, standard, H1
 Gauge, draft, T10
 Gauges, altitude, H7
 Gauges, combination, H7
 Gauges, compound, S11
 Gauges, diaphragm, S11
 Gauges, hydronic, H7
 Gauges, liquid filled, S10
 Gauges, pressure, S10
 Gauges, refrigeration test, S11
 Gauges, spin-on filter, F5, F6
 Gauges, steam, H7
 Gauges, tank, S22
 Gauges, temperature, H7
 Gauges, tester, S11
 Gauges, tridicator, H7
 Gauges, vacuum, S11
 Gauges, water level, H7
 General Filters, elmt. for, F9, F10
 Gloves, brown jersey, S26
 Gloves, nitrile, S26
 Gloves, white canvas, S26
 Goggles, splash, S26
 GTO-15 Cable, E30
 Guards, thermostat, E33 - E35

INDEX

H

Hand pump, T5
 Harvey, elements for, F5, F6, F9, F10
 Heat exchangers, H10 - H11
 Heating oil additive, C1
 Heating oil filters, F1 - F12
 Hex key wrenches, T18
 High pressure gauge glass, H2
 High temperature cable, E30
 High temperature boots, E29
 High temperature rope, S3
 High volt terminals, E25 - E29
 High voltage cable, E30
 Honeywell, wells for, H8
 Hose fitting, H8
 Hot water thermometer, H7
 Hydronic gauges, H7
 HY-DRO-SOL water absorber, C3

I

Ignition cable, E30
 Ignition terminals, E25 - E29
 Ignition transformer tester, T11
 Ignition wire, E30
 Ignition, Auburn, E15 - E23
 Ignition, Champion, E24
 Ignitor kits, E13, E14, S7, S8
 Ignitors (electrodes), E1 - E24
 Immersion wells, H8
 Insulation, heat exchgrs, H11
 Insulators, E1

J

Jumpers, T13

K

Key, radiator bleeder (vent), H8
 Keys, hex, T18
 Kit, blow down for McD & M, H4
 Kit, dirt pocket cap, McD & M, H4
 Kit, gauge glass repair, H3
 Kit, Miller furnace oil line, S13
 Kit, spill, S26
 Kits, burner tune-up, S7, S8
 Kits, cad cell flame detector, E32
 Kits, circulator flange bolt, H4
 Kits, circulator flange gasket, H4
 Kits, CO2 blow out gun, T6
 Kits, combustion testing, T8
 Kits, couplings, S4, S6
 Kits, electrode, E13, E14, S7, S8
 Kits, filter canister upgrade, F12
 Kits, heat exchanger insul., H11
 Kits, NYLO-FLEX couplings, S6
 Kits, Rajah terminals, E28
 Leak tester, T12
 Lennox, NYLO-FLEX for, S5
 Light, thermostat, E36
 Line voltage tester, T13
 Lineman's pliers, T17
 Liners, combustion chamber, S2
 Lines, oil (nozzle), S13
 Linkage, crank arm, S23
 Lint and dust blower, T12
 Liq. filled pressure gauges, S10

Liq. level probes Auburn, E23
 Liq. level probes Fulton boilers, H9
 Liq. level probes, stainless, E23
 Low pres. diaph. gauges, S11
 Low voltage tester, T13
 Low water cut off, parts for, H4

M

MAGIC-PATCH tank patch, S13
 Magnetic oil tank patch, S13
 MAX-DRIVE v-belts, S1
 McDonnell & Miller, parts for, H4
 Miller furnace oil line kit, S13
 MINT BLAST, odor absorber, C1
 Mirrors, flame, T7
 Mitco, elements for, F5, F6, F9, F10
 Motor couplings, S4
 Motor, zone valve, E36
 Mounting bkt., spin-on filter, F5, F6

N

NASgauge nozzle tool, T14
 Nitrile gloves, S26
 Nozzle line fitting, Beckett, S13
 Nozzle lines, S13
 Nuts, gauge glass, H3
 Nuts, wire, E31
 NYLO-FLEX couplings, S5

O

Observation ports, S24
 ODOR KILL, odor absorber, C3
 Odor neutralizer, C1, C3
 Oil burner blower wheels, S9
 Oil de-aerator, S14 - S18
 Oil line access port, T4
 Oil line kit for Miller furnace, S13
 Oil line safety valve, S20, S21
 Oil lines, copper, S13
 Oil lines, flexible, S19
 Oil tank patch, S13
 OSV valve, S20, S21

P

Pads, absorbent, S26
 Paper wipes, S26
 Paper, smoke test, T9
 Petro ignition assembly, E24
 Pig tails, steam, H3
 Pilot cleaner, T12
 Pilot lighters, T7
 PILOT PUFFER lint blower, T12
 Plastic bags, S26
 Plate heat exchanger, H10 - H11
 Pleated paper elements, F10
 Pliers, lineman's, T17
 Plugs, by-pass, S13
 Pocket thermometers, T13
 Porcelain cutter, T17
 Porcelains, E1
 Ports, observation, S24
 Pour point reducer, C1
 Pres. tester, EASY ACCESS, T12
 Pressure gauges, S10
 Pressure-Vac. hand pump, T5

Probes, stainless steel, E23
 Pump bleed wrench, T4
 Pump cover gaskets, S12
 Pump strainers, S12
 Pump test, Suntec & Web., T2
 Pump tester, Riello, T2, T3
 Pump testers, T1 - T3
 Pump, hand pressure-vac., T5
 Pure-Oil filter elements, F9
 Purolator, elements for, F9
 Push rods, linkage, S23
 PV pump, T5

R

Radiator bleeder (vent) key, H8
 Radiator bleeders (vent), H8
 Rags, polo, S26
 Rajah terminal kits, E28
 Rajah terminals, E25 - E28
 Ray burner bakelite shield, E27
 Red Line gauge glass, H2
 Red rubber gasket material, H4
 Reducer bushing, S4
 Refractory chamber liners, S2
 Refrigeration test gauges, S11
 Riello by-pass plug, S13
 Riello pump tester, T3
 Riello, strainer for, S12
 Rope, high temperature, S3
 Rough service bulbs, E31
 Rubber couplings, S4
 Rubber gask. material, red, H4

S

Safety and spill supplies, S26
 Safety glasses, S26
 Sampling assem, CO2 test., T8
 Saws, soot, S25
 Screwdriver line volt tester, T13
 Secondary filtration assem., F7
 SERVICE-SAW tool, S25
 Set, hex key wrenches, T18
 Sets, gauge glass, H3
 Shoe covers, S26
 Shovel, soot, S25
 Sid Harvey, elements for, F5-F10
 Sight glasses, S24
 Silicone rubber boots, E29
 Sliding handle bleed wrench, T4
 Sludge solvent, C1
 Smoke cartridges (candles), T13
 Smoke pen, T13
 Smoke sticks, T13
 Smoke test paper, T9
 Smoke testers, T9
 Socks, absorbent, S26
 Solderless terminal kit, E31
 Solderless terminals, E31
 Solvents, C2
 SOLVIT GREEN spray solvent, C2
 SOLVIT spray solvent, C2
 Soot remover, C2
 SOOT SABER cleaning tool, S25
 Soot saws, S25
 Soot shovel, S25
 SOOT SNAKE vacuum hose, S25

Soot spray, C2
 Soot stick, C2
 SOOTAWAY spray, C2
 SOOTAWAY stick, C2
 Spark plugs, Champion, E24
 Spill cleanup supplies, S26
 Spill kit, S26
 Spin-on filter bleeder fitting, F5, F6
 Spin-on filter gauges, F5, F6
 Spin-on filter mounting brkt, F5, F6
 Spin-on filter wrench, F6
 Spin-on filters, F5, F6
 SPIRALINK couplings, H6
 Splash goggles, S26
 Spring terminals, E27
 Stack thermometers, T10
 Stainless heat exchangers, H10, H11
 Stainless steel probes, E23
 Standard electrodes, E1
 Steam boiler parts, H3, H4
 Steam gauges, H7
 Steam pig tails, H3
 Strainers, pump, S12
 Strippers, wire, T17, T18
 Suntec by-pass plugs, S13
 Suntec, strainers for, S12
 Swivels, linkage, S23
 System pressure tester, T12

T

Tank gauges, S22
 Tank patch, S13
 Tank valves, S22
 Tank, floating suction line, S22
 Tankless coil gask. material, H4
 Tankless coil tester, T12
 Telescoping flame mirrors, T7
 Telescoping pilot lighters, T7
 Temperature gauges, H7
 Terminal crimpers, T17, T18
 Terminal, ceramic boots, E29
 Terminals, high volt, E25 - E28
 Terminals, ignition, E25 - E28
 Terminals, Rajah, E25 - E28
 Terminals, solderless, E31
 Terminals, spring, E27
 Test equip, combustion, T8 - T10
 Test gauges, refrigeration, S11
 Tester gauges, S11
 Tester, AMP-MASTER, T11
 Tester, cad cell, T11
 Tester, draft, T10
 Tester, gas pressure, T12
 Tester, ignition trans., T11
 Tester, line voltage, T13
 Tester, low voltage, T13
 Testers, CO2, T8
 Testers, pump, T1 - T3
 Testers, smoke, T9
 Thermometer, dial, H7
 Thermometer, dig. pocket, T13
 Thermometer, pocket, T13
 Thermometers, stack, T10
 Thermostat circuit tester, T11
 Thermostat guards, E33 - E35
 Thermostat light, E36
 TIGERFLEX™ floating suction line, S22

INDEX

TIGERLOOP ULTRA-B™, S17
 TIGERLOOP ULTRA™, S16
 TIGERLOOP® Bio, S17
 TIGERLOOP® Combi, S18
 TIGERLOOP® installation bundles,
 S15, S16
 TIGERLOOP® oil de-aerator, S15
 TIGERLOOP® Twin, S18
 TIGERLOOP® ventilation hose kit,
 S15, S16
 TIGERSTOP™ anti-siphon valve, S20
 TIGEX® Draft Stabilizer, S22
 Tool, circulator flange, T18
 Tool, Coupler Popper, T15
 Tool, crimping, T17, T18
 Tool, gauge glass cutting, T16
 Tool, nozzle assembly, T14
 Tool, porcelain cutting, T17
 Torrington NYLO-FLEX adpt., S5
 Transformer tester, T11
 TRANS-TEMP heat exchng., H10, H11

Treatment, heating oil, C1
 Tridicator gauges, H7
 Tubing, copper oil lines, S13
 Tune-Up kits, S7, S8

U

UL Listed filters, F1 - F5
 UL Recognized filter canisters, F12
 UL Recognized filter elmts., F8-F11
 ULTRA-10 filter elements, F10
 ULTRAGLO thermo. light, E36
 Unifilter 77, elmts. for, F9, F10
 Unifilter 99, elmts. for, F9, F10
 Upgrade kits, filter canister, F12

V

VAC-PROBE oil line fitting, T4
 Vacuum cleaner bags, S25
 Vacuum cleaner hose, S25
 Vacuum gauges, S11
 VACUUM-VIEW pump tester, T1

Valves, check, S20
 Valves, tank, S22
 V-Belts, S1
 Vent alarms, S22
 Vent caps, S22

W

Washers, gauge gl. friction, H3
 Washers, gauge glass, H1, H2
 Water absorber, C3
 Water dispersant, C1
 Water level gauges, H7
 Water temperature gauges, H7
 Wayne, NYLO-FLEX for, S5
 Wayne, tune-up kits for, S8
 Webster by-pass plugs, S13
 Weil McLain electrode, E12
 Wells, aquastat, H8
 Wells, immersion, H8
 Wet combustion chambers, S2
 White filter elements, F9

Wipes, paper, S26
 Wire connectors, E31
 Wire nuts, E31
 Wire strippers, T17, T18
 Wire, ignition, E30
 WP-3 fuel oil additive, C1
 Wrench, hex key, T18
 Wrench, pump bleeder, T4
 Wrench, spin-on filter, F4, F5

Y

Yarn filter elements, F11
 Yarn filters, F2, F11

Z

Zone valve motor, E36



 Take a look ...

ELECTRODE KITS and BURNER TUNE-UP KITS in Service Supplies Section pages S7 - S8

Westwood



Representation WORLDWIDE...



<i>United States</i>	<i>Representative</i>	<i>Phone Number</i>	<i>FAX Number</i>
NY Metro, West. Cnty, L.I. NY State, above NY Metro No. NJ, Rockland Cnty NY MA, CT, RI ME, NH, VT East PA, So. NJ, DE, MD Western PA, West Virginia IN, N. IL, MN, N. MI, WI KS, MO NC, SC OH, KY IA, NE	Chapman Equip., Bob Chapman Davenport Associates, Mark Riggi Advanced Hydronics Sales Inc., David Vaccari Heat Tech Assoc., Tony Audia Edward B. "Spike" Lingel John Stack Sales Company, Gary Stack The Weaver Agency, Gary Weaver G. Miller Company, Gary Miller Halfpenny Sales, Inc., Bill Halfpenny United Components, Inc., Bob Bradley Thomas J. Finnegan Company, Gregg Finnegan Lambert Company, Mike Lambert	(516) 579-4494 (585) 538-6786 (201) 573-0606 (860) 482-6321 (781) 235-8044 (888) 466-4328 (412) 793-5021 (815) 964-5692 (816) 776-2967 (336) 786-8952 (859) 363-0000 (563) 588-2393	(516) 579-0257 (585) 538-6787 (201) 573-0499 (860) 482-9601 (781) 237-8999 (866) 634-7737 (412) 795-3532 (815) 964-5770 (816) 470-5514 (336) 786-6543 (859) 363-0900 (563) 588-2452
<i>Outside the US</i>	<i>Representative</i>	<i>Phone Number</i>	<i>FAX Number</i>
Canada Export Distributor Areas not listed	E.S. Gallagher Sales Ltd., Andy Gallagher George Nikiforov Inc., George Nikiforov Westwood Products Inc.	(416) 789-5385 (212) 473-4555 (800) 442-1630	(416) 781-6734 (212) 473-5925 (888) 651-7798



Westwood Products Inc.
 330 William Street, South River, NJ 08882
 Tel: (732) 651-7700 Fax: (732) 651-7798

Toll Free 1-800-442-1630

Toll Free Fax 1-888-651-7798