

CLICK ANYWHERE on THIS PAGE to RETURN to NEST THERMOSTAT INSTALLATION, INSTRUCTIONS & GUIDES at InspectApedia.com

Nest Learning Thermostat

Pro Installation & Configuration Guide



Last updated: November 2017

Version: 1.1

Table of Contents

General Information	2
Nest Learning Thermostat Installation Features	2
HVAC System Compatibility	3
Technical Specifications	3
How to use Pro Setup	4
Installation Overview	5
Supported Wiring	7
Nest Thermostat Connectors	7
Wiring Diagrams: Conventional Heating/Cooling Systems	8
Wiring Diagrams: Heat Pump Systems	12
Wiring Diagrams: Multi-Speed Fans	17
Wiring Diagrams: Humidifiers and Dehumidifiers	18
Configuring Nest Thermostat with Pro Setup	19
How to use Pro Setup	19
How to Configure Complex Systems	20
Troubleshooting	23
Handling Unusual Thermostat Wiring	23
Reference Materials	26
How To Quick Reference Guide	26
Wiring Error Quick Reference Guide	29
Troubleshooting Quick Reference Guide	32
Humidifier/Dehumidifier Configurations	34
Where to Find Additional Help	36

General Information

Nest Learning Thermostat Installation Features

No jumper wires needed

The Nest Thermostat does not use jumper wires, it will automatically jump terminals for you. Do not connect jumper wires to the Nest Thermostat. Before removing any wires from the old thermostat, including jumper wires, take a picture of the existing wiring configuration in case you or the homeowner need to reinstall it.

System Match

When you first install the Nest Thermostat, it checks to see what wires you've inserted into the base's connectors and prompts you for additional information where needed.

Pro Setup

Pro Setup lets Nest Pros configure advanced settings in order to set up complex systems, including dual-fuel systems, humidifiers/dehumidifiers and multi-speed fans. Pro Setup also activates a customer's extended warranty if the Nest Thermostat is purchased from and installed by a Pro.

Silent relays

Nest Thermostats use solid state switching instead of relays so there's no noise when it switches on or off. You will *not* hear any "clicking" during system testing and activation.

Press connectors

Connecting the HVAC system wiring to the Nest Thermostat base is easy using the press connectors. Simply insert the wire into the connector as far as it will go until the press connector stays in the down position.

Multifunctional Star connector

The Star connector on the Nest Thermostat can control a number of different applications. If you insert a wire into this terminal, the Nest Thermostat will ask you to select the application and will control it based on your selection. For a list of compatible applications that can be inserted into the Star connector, see the wiring diagrams below.

HVAC System Compatibility

System Compatibility:

- Works with 95% of 24V systems: gas, electric, oil, forced air, heat pump & radiant
- Heating: 1, 2 and 3 stages (W1, W2, W3)
- Cooling: 1 and 2 stages (Y1, Y2)
- Power (C, Rh, Rc)
- Fan (including multi-speed) (G or G1,G2,G3)
- Humidifier or dehumidifier (HUM, DEHUM)
- Heat pump: with auxiliary/alternate and emergency heat (O/B, AUX, ALT, E)

Connectors:

- Y1
- Y2
- G
- O/B
- Rc
- W1
- W2/AUX
- C
- *
- Rh

Networking requirements:

- Wi-Fi is required for software updates and remote control with the Nest App
- Wi-Fi 802.11 b/g/n, 2.4 GHz
- Secure: AES-128, SSL/TLS, WEP, WPA/WPA2

Technical Specifications



Power:

- No external power required
- No common wire required with most installations
- Built in lithium-ion battery
- Uses less than 1 kWh/month
- Voltage requirement: 20-30V AC

Display:

- 24-bit color LCD
- 480x480 resolution at 229 pixels per inch (PPI)
- 5.3 cm (2.08 in) diameter

Sensors:

- Temperature (10 sensors) +/- .5°F
- Humidity +/- 3%RH
- Near-field activity
- Far-field activity
- Ambient light
- Nest utilizes local weather data over Wi-Fi instead of outdoor temperature sensors

Green:

- Energy Star
- CEC Title 20
- CEC Title 24 Residential
- CEC Title 24 Nonresidential
- Recyclable packaging

Box contents:

- Display
- Base
- Trim kit
- Mounting screws
- Wire labels
- Installation guide
- Welcome guide

Size and weight:

Display:

- Mass = 205.4 g / 7.25 oz
- Diameter = 8.4 cm / 3.30"
- Height = 2.69 / 1.06"

Base:

- Mass = 38.3 g / 1.35 oz
- Diameter = 7.6 cm / 3"
- Height = 1.1 cm / 0.42"

How to use Pro Setup

When going through setup on the Nest Thermostat, the first question in the Equipment section asks if you're a Homeowner or Pro. Selecting Pro will take you through Pro Setup, which has additional options to help professional installers setup more complex systems. In Pro Setup, you can configure advanced settings such as alternate and primary heating sources, lockout temperatures, fan activation and more. Pro Setup is required to set up dual-fuel systems as well as whole-home humidifiers and dehumidifiers.

How to give your customer an extended Pro Warranty

Customers who purchase a Nest Thermostat from a Nest Pro and have it installed can get an extended Pro Warranty. The Pro Warranty adds an additional 3 years of coverage for a total of 5 years. Entering your Pro ID in Pro Setup will automatically activate your customer's extended warranty as long as all of the following are true:

- You must sell and install the thermostat for your customer
- You must enter your Pro ID during the setup installation
- The thermostat must be connected to Wi-Fi and added to the customer's Nest Account

If all of the above are completed your customer will get the extended warranty automatically.

Installation Overview

1. Confirm system compatibility

Before opening the Nest Thermostat package, check all of the wires connected to the current thermostat against the list of available connectors on the Nest Thermostat box, or use the Compatibility Checker at <http://nest.com/works> to show you exactly where to connect each wire.

2. Briefly test the HVAC system

Test the heating, cooling, fan and other system features with the current thermostat before installing the Nest thermostat so you can address any existing issues.

At times, outdoor weather conditions may prohibit testing of heating or cooling. In those cases, inform the customer that you cannot test and ask the customer about the system's operation and performance.

3. Turn off power to the HVAC system

Turn off the power to the system to protect yourself and the equipment. Locate the circuit box and check to see if the circuits are labeled or if there is a circuit directory. Turn off all HVAC system circuits.

If you cannot determine which circuits belong to the HVAC system turn off the main circuit breaker after obtaining permission from your customer. Confirm the power is off by attempting to activate the HVAC system using the existing thermostat.

4. Remove the old thermostat

Before removing the old thermostat, take a quick picture of the wiring with your phone in case you need it for reference. Disconnect the wiring and remove the old thermostat. Use the wire labels included in Nest Thermostat Installation Guide if needed. Be sure to leave the original thermostat, hardware and any jumper wires with the customer.

5. Offer the customer installation finishing options

You may need to cover up holes, old paint or marks left by the old thermostat. Ask your customer if they prefer to repair the wall themselves or if they want to have the Nest trim plate installed. Let the customer know that the trim plate can be painted to match the wall.

6. Install the Nest Thermostat

Run the wires through the center of the Nest Thermostat base and attach it to the wall using the screws provided. Do not use a power drill on the screws. Over tightening the screws can damage the circuitry in the Nest base. For paneling, plaster-and-lath, or if there is a stud behind the thermostat, pre-drill a hole using a 3/32" bit first.

Use the built-in level for proper alignment. Trim or re-strip any wires as necessary and connect them to their corresponding terminals on the base. Make sure the wire is straight and the connector button stays down after inserting it.

7. Walk through the Setup Interview with your customer

Most of the Pro Setup questions are easy for a professional to answer, but your customer should answer some of the questions like preferred temperatures and Wi-Fi passwords.

8. Allow the Nest Thermostat to update

If there's a necessary software update, the Nest Thermostat will start downloading it as soon as it connects to the internet. The update can take several minutes depending on the speed of the internet connection, so take advantage of this time to explain some of Nest Thermostat's key features to your customer.

9. Test heating and cooling

This is vital to any installation in order to prevent a callback. After setting up the Nest Thermostat, run each part of the system for a few minutes. This will ensure that the Nest Thermostat is installed correctly and there aren't any HVAC compatibility issues. See page 26 for additional details on performing post-installation testing.

10. Help your customer pair the Nest Thermostat with the Nest App

If your customer already has a Nest product and is using the Nest App, show them how to add the thermostat to their Nest account. If it's your customer's first Nest product, show them how to download the Nest App, create an account and then add the Nest Thermostat.

Supported Wiring

Nest Thermostat Connectors

Conventional connectors:		Heat pump connectors:	
Y1	Stage 1 compressor relay	Y1	Stage 1 compressor relay
Y2	Stage 2 compressor relay, 2nd-speed fan relay	Y2	Stage 2 compressor relay
G	Fan relay	G	Fan relay
O/B	Not used	O/B	Changeover valve relay
Rc	24VAC power from cooling transformer*	Rc	Not used
W1	Stage 1 heat relay	W1	Stage 1 heat relay
W2/AUX	Stage 2 heat relay	W2/AUX	Auxiliary heat relay
C	24VAC common wire	C	24VAC common wire.
Star *	Stage 3 heat (W3), humidification (HUM), or dehumidification (DEHUM), 3rd-speed fan relay	Star *	Emergency heat (E), humidification (HUM), or dehumidification (DEHUM)
Rh	24VAC power from heating transformer*	Rh	24VAC power from transformer*

* No jumper wires required. You don't need to hang on to any old jumper wires going from Rh (sometimes just called R) to Rc. Nest will automatically jump these two connectors.

Wiring Diagrams: Conventional Heating/Cooling Systems

Conventional 1 Stage Heating

Label:	Function:
Y1	Compressor Relay (Stage 1)
Y2	Compressor Relay (Stage 2), 2nd-speed fan relay
G	Fan Relay*
O/B	Heat Pump Changeover Valve
Rc	24VAC power from cooling transformer
W1	Heat Relay (Stage 1)
W2/AUX	Heat Relay (Stage 2) / Auxiliary Heat Relay
C	24VAC Common Wire †
*	Star: W3, E, HUM/DHUM, 3rd-speed fan relay
Rh	24VAC power from heating transformer ‡

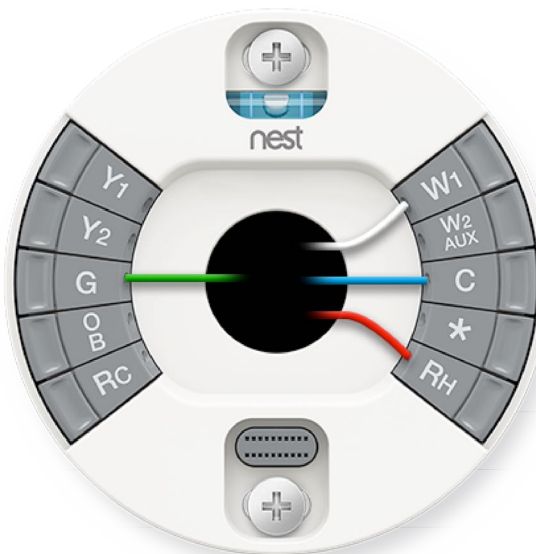

Conventional 2 Stage Heating

Label:	Function:
Y1	Compressor Relay (Stage 1)
Y2	Compressor Relay (Stage 2), 2nd-speed fan relay
G	Fan Relay*
O/B	Heat Pump Changeover Valve
Rc	24VAC power from cooling transformer
W1	Heat Relay (Stage 1)
W2/AUX	Heat Relay (Stage 2) / Auxiliary Heat Relay
C	24VAC Common Wire †
*	Star: W3, E, HUM/DHUM, 3rd-speed fan relay
Rh	24VAC power from heating transformer ‡

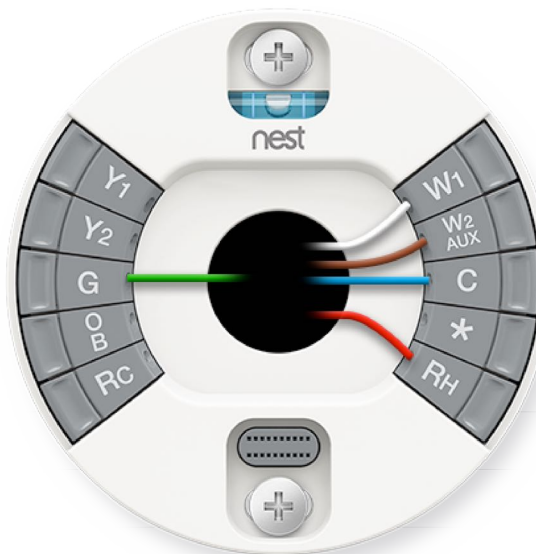

* Fan relay (G) is optional. However, without a G wire, Nest will not be able to control the fan independent of heating.

† Common wire (C) not required in most cases, but strongly recommended.

‡ Use Rh or Rc in single transformer systems; no jumper wire required. For dual transformer systems, use Rh for the heating transformer and Rc for the cooling transformer

Conventional 3 Stage Heating

Label:	Function:
Y1	Compressor Relay (Stage 1)
Y2	Compressor Relay (Stage 2), 2nd-speed fan relay
G	Fan Relay*
O/B	Heat Pump Changeover Valve
Rc	24VAC power from cooling transformer
W1	Heat Relay (Stage 1)
W2/AUX	Heat Relay (Stage 2) / Auxiliary Heat Relay
C	24VAC Common Wire †
*	Star: W3, E, HUM/DHUM, 3rd-speed fan relay
Rh	24VAC power from heating transformer ‡

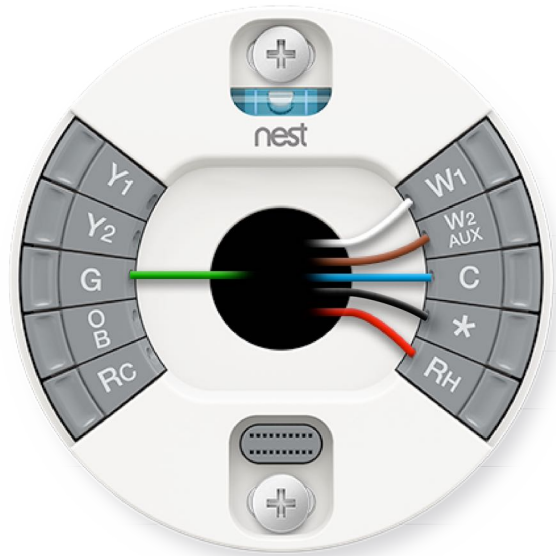

Conventional 1 Stage Heating, 1 Stage Cooling

Label:	Function:
Y1	Compressor Relay (Stage 1)
Y2	Compressor Relay (Stage 2), 2nd-speed fan relay
G	Fan Relay*
O/B	Heat Pump Changeover Valve
Rc	24VAC power from cooling transformer
W1	Heat Relay (Stage 1)
W2/AUX	Heat Relay (Stage 2) / Auxiliary Heat Relay
C	24VAC Common Wire †
*	Star: W3, E, HUM/DHUM, 3rd-speed fan relay
Rh	24VAC power from heating transformer ‡

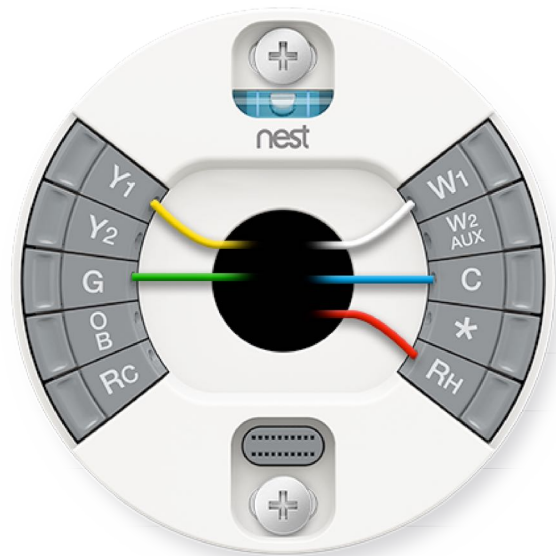

Conventional 2 Stage Heating, 1 Stage Cooling

Label:	Function:
Y1	Compressor Relay (Stage 1)
Y2	Compressor Relay (Stage 2), 2nd-speed fan relay
G	Fan Relay*
O/B	Heat Pump Changeover Valve
Rc	24VAC power from cooling transformer
W1	Heat Relay (Stage 1)
W2/AUX	Heat Relay (Stage 2) / Auxiliary Heat Relay
C	24VAC Common Wire †
*	Star: W3, E, HUM/DHUM, 3rd-speed fan relay
Rh	24VAC power from heating transformer ‡

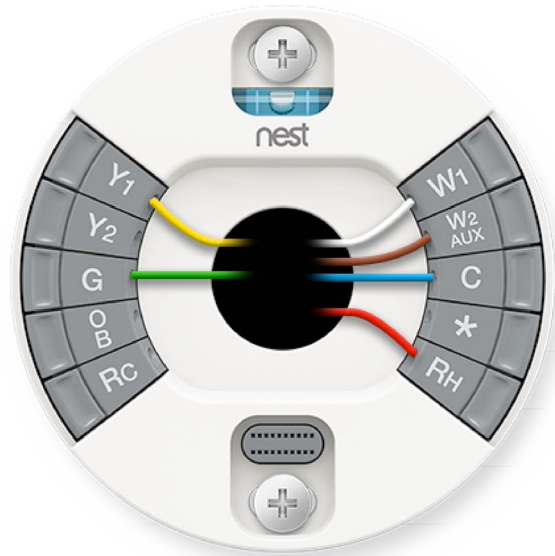

Conventional 2 Stage Heating, 2 Stage Cooling

Label:	Function:
Y1	Compressor Relay (Stage 1)
Y2	Compressor Relay (Stage 2), 2nd-speed fan relay
G	Fan Relay*
O/B	Heat Pump Changeover Valve
Rc	24VAC power from cooling transformer
W1	Heat Relay (Stage 1)
W2/AUX	Heat Relay (Stage 2) / Auxiliary Heat Relay
C	24VAC Common Wire †
*	Star: W3, E, HUM/DHUM, 3rd-speed fan relay
Rh	24VAC power from heating transformer ‡

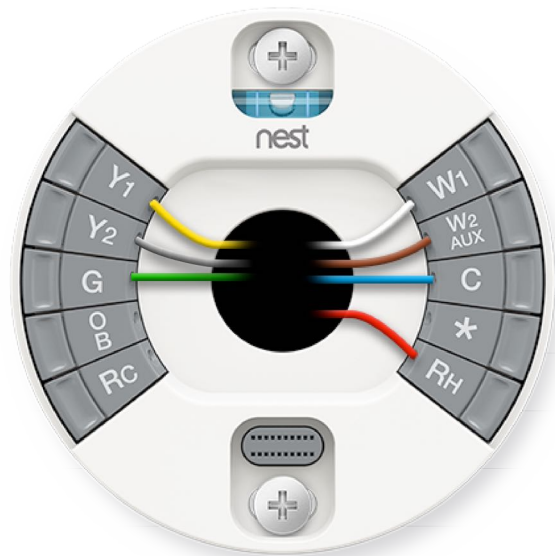

Conventional 3 Stage Heating, 2 Stage Cooling

Label:	Function:
Y1	Compressor Relay (Stage 1)
Y2	Compressor Relay (Stage 2), 2nd-speed fan relay
G	Fan Relay*
O/B	Heat Pump Changeover Valve
Rc	24VAC power from cooling transformer
W1	Heat Relay (Stage 1)
W2/AUX	Heat Relay (Stage 2) / Auxiliary Heat Relay
C	24VAC Common Wire †
*	Star: W3, E, HUM/DHUM, 3rd-speed fan relay
Rh	24VAC power from heating transformer ‡

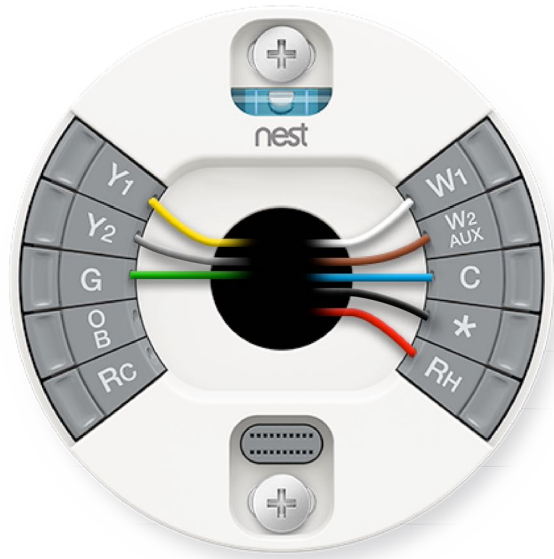

Conventional 1 Stage Heating, 2 Stage Cooling

Label:	Function:
Y1	Compressor Relay (Stage 1)
Y2	Compressor Relay (Stage 2), 2nd-speed fan relay
G	Fan Relay*
O/B	Heat Pump Changeover Valve
Rc	24VAC power from cooling transformer
W1	Heat Relay (Stage 1)
W2/AUX	Heat Relay (Stage 2) / Auxiliary Heat Relay
C	24VAC Common Wire †
*	Star: W3, E, HUM/DHUM, 3rd-speed fan relay
Rh	24VAC power from heating transformer ‡

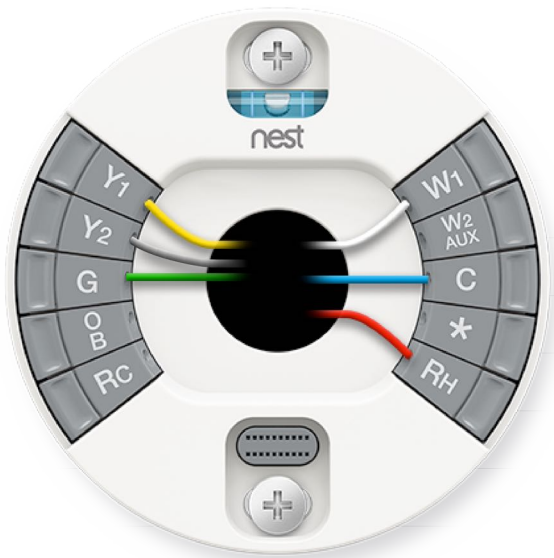

Wiring Diagrams: Heat Pump Systems

1 Stage Heat Pump

Label:	Function:
Y1	Compressor Relay (Stage 1)
Y2	Compressor Relay (Stage 2), 2nd-speed fan relay
G	Fan Relay*
O/B	Heat Pump Changeover Valve
Rc	24VAC power from cooling transformer
W1	Heat Relay (Stage 1)
W2/AUX	Heat Relay (Stage 2) / Auxiliary Heat Relay
C	24VAC Common Wire †
*	Star: W3, E, HUM/DHUM, 3rd-speed fan relay
Rh	24VAC power from heating transformer ‡

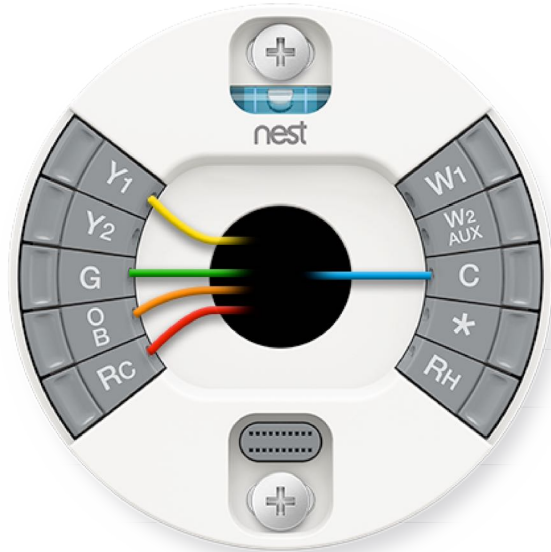

1 Stage Heat Pump with Aux Heat

Label:	Function:
Y1	Compressor Relay (Stage 1)
Y2	Compressor Relay (Stage 2), 2nd-speed fan relay
G	Fan Relay*
O/B	Heat Pump Changeover Valve
Rc	24VAC power from cooling transformer
W1	Heat Relay (Stage 1)
W2/AUX	Heat Relay (Stage 2) / Auxiliary Heat Relay
C	24VAC Common Wire †
*	Star: W3, E, HUM/DHUM, 3rd-speed fan relay
Rh	24VAC power from heating transformer ‡

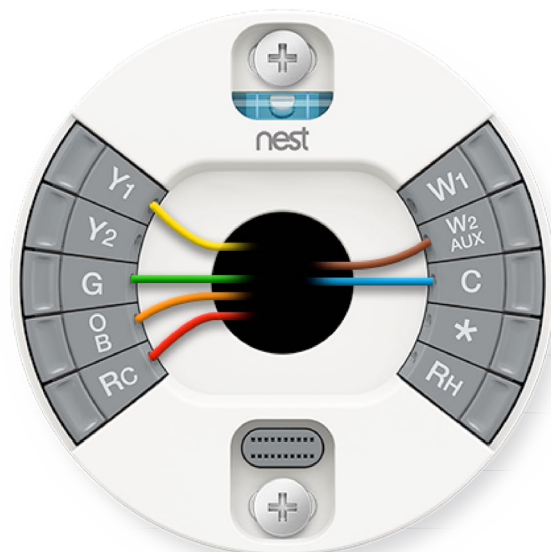

1 Stage Heat Pump with Aux heat and Emergency Heat

Label:	Function:
Y1	Compressor Relay (Stage 1)
Y2	Compressor Relay (Stage 2), 2nd-speed fan relay
G	Fan Relay*
O/B	Heat Pump Changeover Valve
Rc	24VAC power from cooling transformer
W1	Heat Relay (Stage 1)
W2/AUX	Heat Relay (Stage 2) / Auxiliary Heat Relay
C	24VAC Common Wire †
*	Star: W3, E, HUM/DHUM, 3rd-speed fan relay
Rh	24VAC power from heating transformer ‡

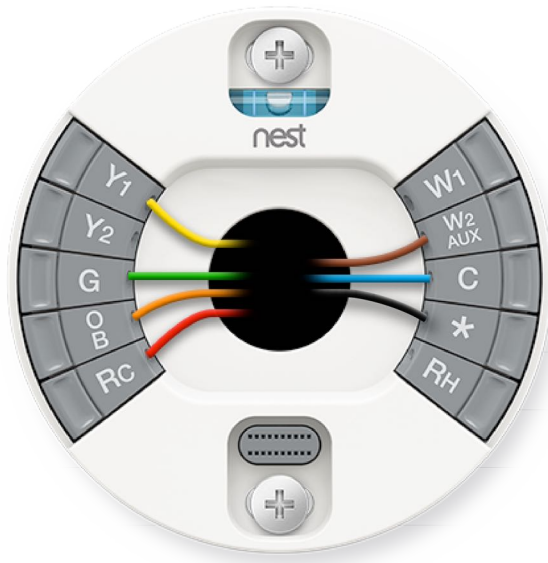

2 Stage Heat Pump

Label:	Function:
Y1	Compressor Relay (Stage 1)
Y2	Compressor Relay (Stage 2), 2nd-speed fan relay
G	Fan Relay*
O/B	Heat Pump Changeover Valve
Rc	24VAC power from cooling transformer
W1	Heat Relay (Stage 1)
W2/AUX	Heat Relay (Stage 2) / Auxiliary Heat Relay
C	24VAC Common Wire †
*	Star: W3, E, HUM/DHUM, 3rd-speed fan relay
Rh	24VAC power from heating transformer ‡

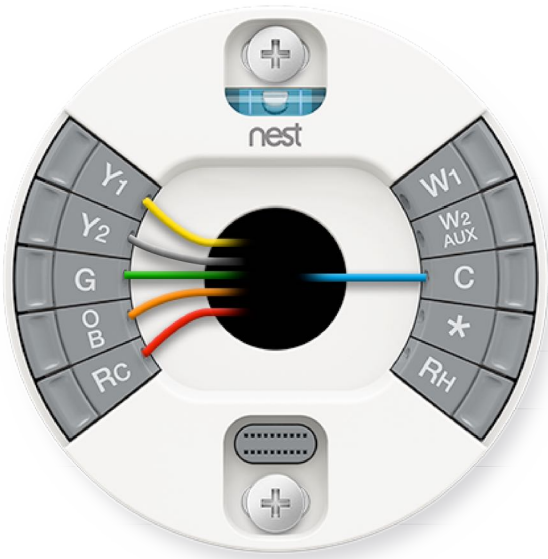

2 Stage Heat Pump with Aux Heat

Label:	Function:
Y1	Compressor Relay (Stage 1)
Y2	Compressor Relay (Stage 2), 2nd-speed fan relay
G	Fan Relay*
O/B	Heat Pump Changeover Valve
Rc	24VAC power from cooling transformer
W1	Heat Relay (Stage 1)
W2/AUX	Heat Relay (Stage 2) / Auxiliary Heat Relay
C	24VAC Common Wire †
*	Star: W3, E, HUM/DHUM, 3rd-speed fan relay
Rh	24VAC power from heating transformer ‡

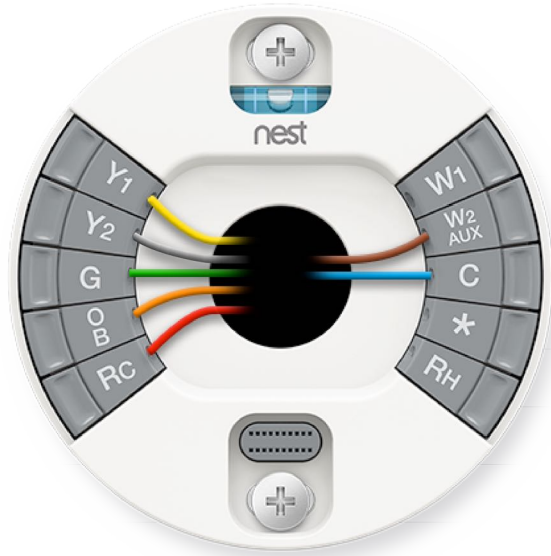

Dual Fuel - 1 Stage Heat Pump, 1 Stage Heat

Label:	Function:
Y1	Compressor Relay (Stage 1)
Y2	Compressor Relay (Stage 2), 2nd-speed fan relay
G	Fan Relay*
O/B	Heat Pump Changeover Valve
Rc	24VAC power from cooling transformer
W1	Heat Relay (Stage 1)
W2/AUX	Heat Relay (Stage 2) / Auxiliary Heat Relay
C	24VAC Common Wire †
*	Star: W3, E, HUM/DHUM, 3rd-speed fan relay
Rh	24VAC power from heating transformer ‡

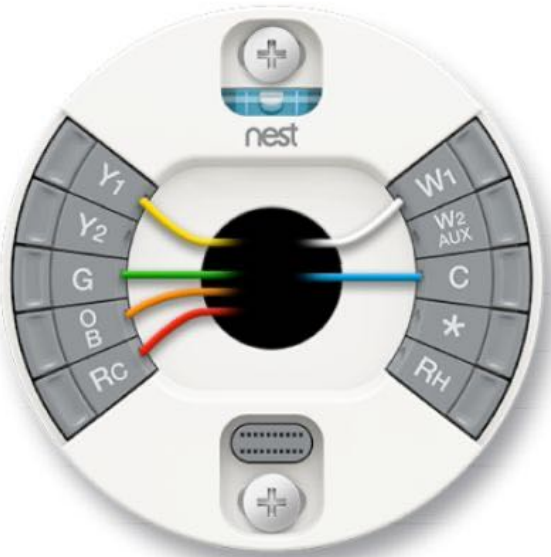

Dual Fuel - 2 Stage Heat Pump, 1 Stage Heat

Label:	Function:
Y1	Compressor Relay (Stage 1)
Y2	Compressor Relay (Stage 2), 2nd-speed fan relay
G	Fan Relay*
O/B	Heat Pump Changeover Valve
Rc	24VAC power from cooling transformer
W1	Heat Relay (Stage 1)
W2/AUX	Heat Relay (Stage 2) / Auxiliary Heat Relay
C	24VAC Common Wire †
*	Star: W3, E, HUM/DHUM, 3rd-speed fan relay
Rh	24VAC power from heating transformer ‡

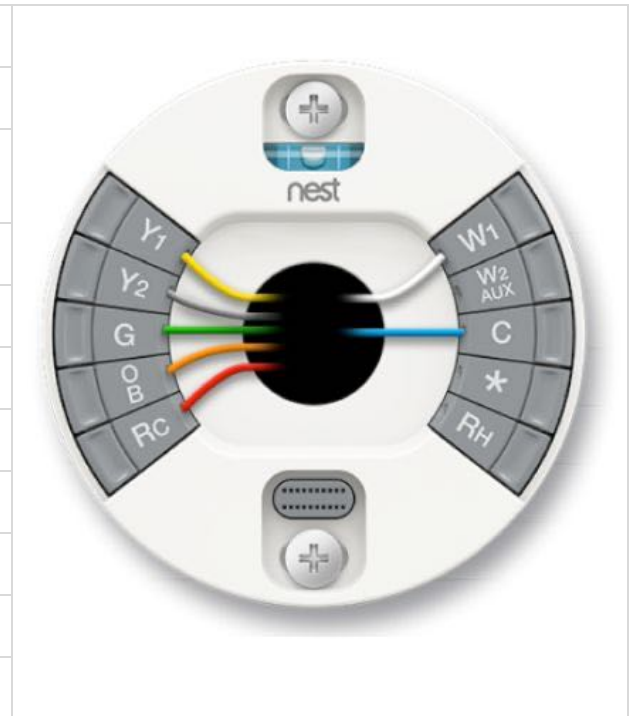

Dual Fuel - 1 Stage Heat Pump, 2 Stage Heat

Label:	Function:
Y1	Compressor Relay (Stage 1)
Y2	Compressor Relay (Stage 2), 2nd-speed fan relay
G	Fan Relay*
O/B	Heat Pump Changeover Valve
Rc	24VAC power from cooling transformer
W1	Heat Relay (Stage 1)
W2/AUX	Heat Relay (Stage 2) / Auxiliary Heat Relay
C	24VAC Common Wire †
*	Star: W3, E, HUM/DHUM, 3rd-speed fan relay
Rh	24VAC power from heating transformer ‡

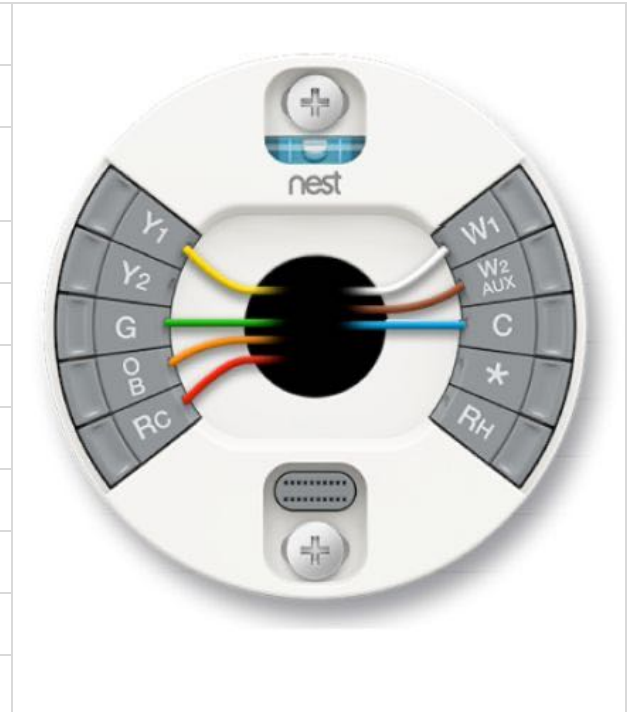

Dual Fuel - 2 Stage Heat pump, 2 Stage Heat

Label:	Function:
Y1	Compressor Relay (Stage 1)
Y2	Compressor Relay (Stage 2), 2nd-speed fan relay
G	Fan Relay*
O/B	Heat Pump Changeover Valve
Rc	24VAC power from cooling transformer
W1	Heat Relay (Stage 1)
W2/AUX	Heat Relay (Stage 2) / Auxiliary Heat Relay
C	24VAC Common Wire †
*	Star: W3, E, HUM/DHUM, 3rd-speed fan relay
Rh	24VAC power from heating transformer ‡

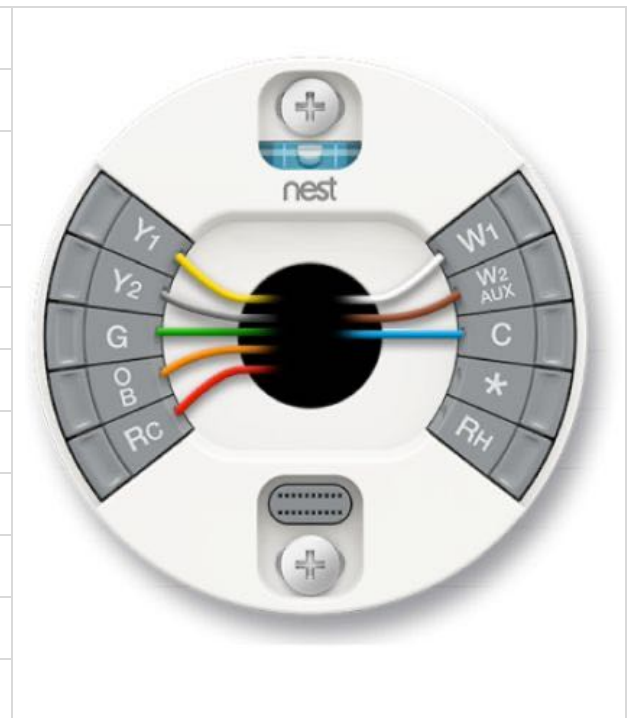

Wiring Diagrams: Multi-Speed Fans

2 Speed

Label:	Function:
Y1	Compressor Relay (Stage 1)
Y2	Compressor Relay (Stage 2), 2nd-speed fan relay
G	Fan Relay*
O/B	Heat Pump Changeover Valve
Rc	24VAC power from cooling transformer
W1	Heat Relay (Stage 1)
W2/AUX	Heat Relay (Stage 2) / Auxiliary Heat Relay
C	24VAC Common Wire †
*	Star: W3, E, HUM/DHUM, 3rd-speed fan relay
Rh	24VAC power from heating transformer ‡

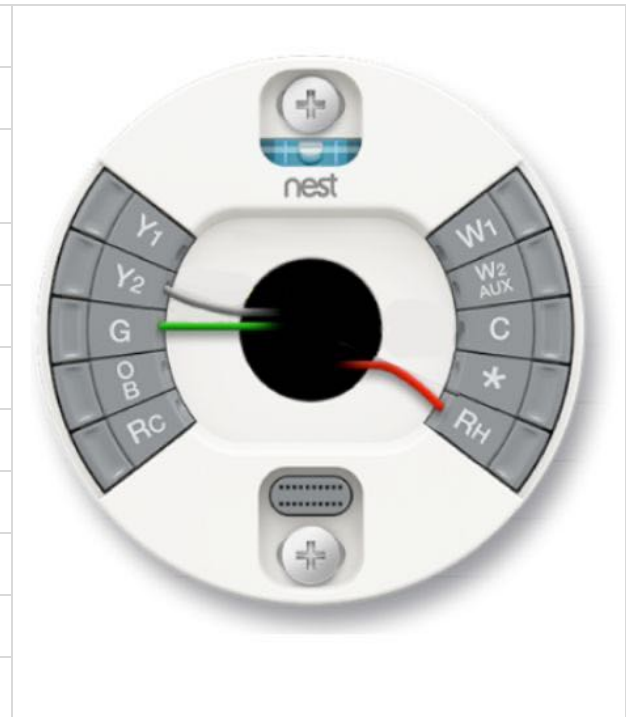

3 Speed

Label:	Function:
Y1	Compressor Relay (Stage 1)
Y2	Compressor Relay (Stage 2), 2nd-speed fan relay
G	Fan Relay*
O/B	Heat Pump Changeover Valve
Rc	24VAC power from cooling transformer
W1	Heat Relay (Stage 1)
W2/AUX	Heat Relay (Stage 2) / Auxiliary Heat Relay
C	24VAC Common Wire †
*	Star: W3, E, HUM/DHUM, 3rd-speed fan relay
Rh	24VAC power from heating transformer ‡

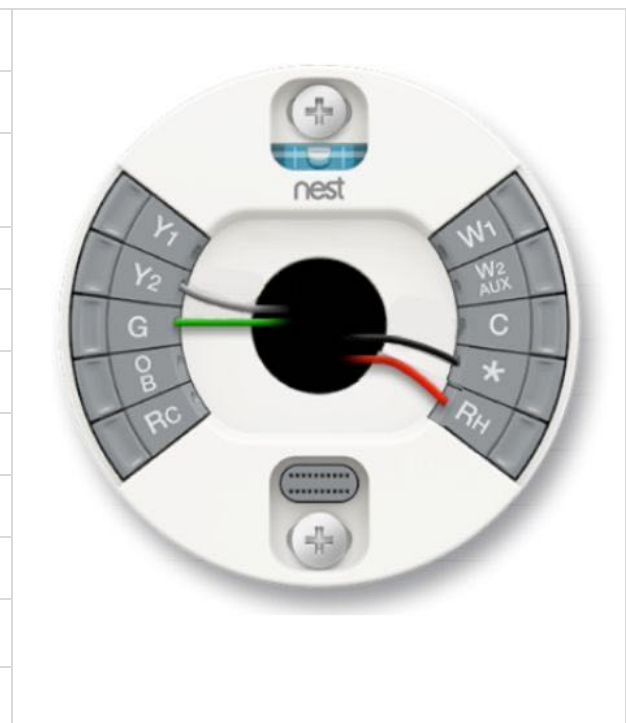

Wiring Diagrams: Humidifiers/Dehumidifiers

Label:	Function:
Y1	Compressor Relay (Stage 1)
Y2	Compressor Relay (Stage 2), 2nd-speed fan relay
G	Fan Relay*
O/B	Heat Pump Changeover Valve
Rc	24VAC power from cooling transformer
W1	Heat Relay (Stage 1)
W2/AUX	Heat Relay (Stage 2) / Auxiliary Heat Relay
C	24VAC Common Wire †
*	Star: W3, E, HUM/DHUM, 3rd-speed fan relay
Rh	24VAC power from heating transformer ‡

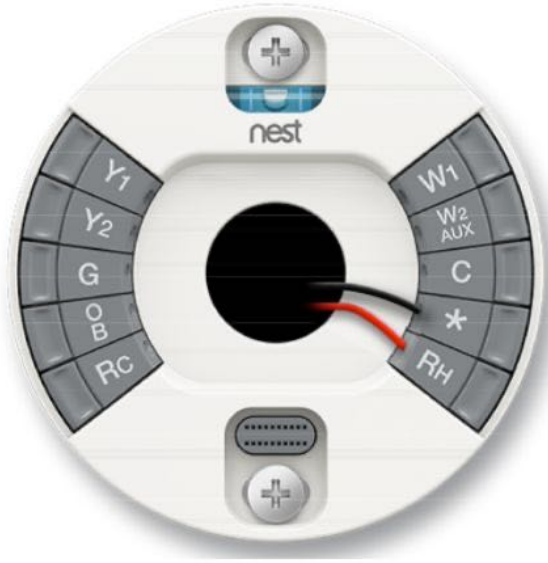

Configuring Nest with Pro Setup

How to use Pro Setup

When you set up the Nest Thermostat for the first time, you'll be asked if you're a professional installer. If you answer "PRO," you'll receive Pro Setup options. Pro Setup can also be accessed at any time after the Nest Thermostat is installed through the SETTINGS menu. To enter Pro Setup on the Nest Thermostat after the initial setup go to SETTINGS > EQUIPMENT > CONTINUE > CONTINUE > PRO SETUP. In both cases you will need to enter your Pro ID which can be found next to your username on the Nest Pro website.

Pro Setup lets you configure how the Nest Thermostat controls each wire connected to it. When you first enter Pro Setup, you'll see an image of the connectors on the Nest base. Connectors with wires will be highlighted in green or yellow. Green indicates that the wire has only one setting. Connectors highlighted yellow have multiple options. The Nest Thermostat selects default settings for these connectors, but you'll want to verify or modify these settings to make sure it is controlling each wire appropriately.

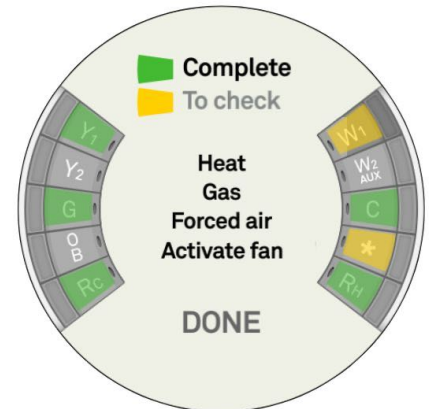

To configure a wire, just turn the thermostat ring to highlight a connector and press to select it. Each wire will show **Type**, which describes the function of that wire. In most cases the Type cannot be changed - it's dictated by the wiring configuration and by whether or not the system is dual fuel. The Type for the Star connector is always customizable.

Connectors that control a heating or cooling function will also have a **Source** setting (to identify the type of fuel used to heat or cool), a **Delivery** setting (to describe how heating or cooling is distributed throughout the home) and a **Fan** setting (to activate the fan if required). Depending on the wire configuration, the **Source** or **Delivery** settings may have only one default option.

The **Fan** default is **Don't activate**. This means that the Nest Thermostat will rely on the system to activate the fan when the furnace (W1) is running. If you test the furnace and notice that the fan is not activating, change this option to **Activate**. The **Fan** setting will only change fan activation when the furnace (W1) is running, the fan will continue to activate normally during other functions.

Source options:	Delivery options:	Fan options:
<ul style="list-style-type: none">• Gas• Electric• Oil• Propane (LP)• Geothermal	<ul style="list-style-type: none">• Forced air• In-floor radiant• Radiators• Electric baseboard (electric source only)	<ul style="list-style-type: none">• Activate• Don't activate

It's recommended that all connectors highlighted in yellow be reviewed to ensure that the options chosen are right for that system. After selecting the yellow-highlighted connector, any fields needing attention will be outlined in blue. Press the Thermostat face to enter that field (the entire field will turn blue). Then turn the ring to select the correct option for your installation. You must complete this process for every yellow-highlighted connector and every field outlined in blue within those connectors. If there are no connectors highlighted in yellow you can turn the ring and select DONE at any time to exit Pro Setup.

How to Configure Complex Systems

Dual Fuel Systems

If there's an O/B wire and one or more W wires connected to the Nest thermostat (which indicates that the system uses a heat pump with an additional heating source), Pro Setup will first ask if the heating system is dual fuel or single fuel.

For single fuel, any wires inserted into the W1, W2/AUX, or Star (if W3 is chosen) connectors will be treated as auxiliary heat that will be used simultaneously with the heat pump when needed.

Pro Setup will automatically configure the auxiliary heat wire for an electric forced air system. The 3rd generation Nest Thermostat can only support one wire for auxiliary heat; additional auxiliary heat wires are not supported.

For dual fuel, any wires inserted into the W1, W2/AUX, or Star (if W3 is chosen) connectors will be treated as alternate heat that will be used instead of the heat pump when needed. Use Pro Setup to indicate the source (gas, electric, geothermal, etc) as well as the delivery mechanism (forced air, radiant, etc) for each of the W wires connected. The Nest Thermostat supports two wires for alternate heat; additional alternate heat wires are not supported.



Humidifiers and Dehumidifiers

The Nest Thermostat supports whole-home humidifiers and dehumidifiers that connect to it with one or two low voltage wires. There are multiple Pro Setup settings for the wire in the Star connector to control a humidifier or dehumidifier. Whenever a humidifier/dehumidifier is attached you'll need to select whether or not the fan should activate.

Compatible wires have one of the following labels:

- H, Hum, Hum1, H2, Hum2
- D, DH, Dhum, Dehum, D2, DH2, Dhum2, Dehum2

Regardless of whether your customer's humidifier or dehumidifier has one wire or two, you will need to figure out if it can be activated on its own or if it requires heating or cooling to be on at the same time. You'll also need to determine other settings, such as whether the fan is required during operation.

The Nest Thermostat's Star terminal is a powered terminal. If you're connecting a humidifier/dehumidifier that requires unpowered terminals, add a 24 VAC relay suitable for HVAC equipment use. Consult humidifier/dehumidifier installation manual for wiring requirements.

Important Note: In dual transformer installations (installations with both Rc and Rh wires) it's important to note that different wires attached to the thermostat will use different power sources. The Rc wire will provide power to the Y1, Y2, G, and O/B terminals. The Rc wire will also charge the thermostat using the C terminal. The Rh wire will provide power to W1, W2/AUX, and Star connectors. Never connect wires from dual transformer systems to connectors from the opposite transformer.



Humidifier

Pro Setup will show an Activate setting to specify whether heat needs to be activated for humidification to turn on. Bypass humidifiers should use the Hum. + heat option while steam, independent, or on-demand humidifiers should use the Hum. only option.

Dehum with A/C

Also known as AC integrated dehumidifiers, these systems require cooling to be activated to turn on dehumidification.

Dehum Standalone

These dehumidifiers can be turned on independently and do not require heating or cooling to be active. Pro Setup will show a “To dehum” option where you can choose whether the Star wire should be energized or not to turn on dehumidification.

Multi-Speed Fans

The Nest Learning Thermostat is compatible with most multi-speed fans (up to 3 speeds) on systems that use standard 24 volt wiring. It will control the fan differently depending on how many fan wires are connected.

If your customer has a multi-speed fan with a single wire, the system will control the fan speed, not the Nest thermostat. This means they'll be able to use the Nest Learning Thermostat to adjust the temperature and turn the fan on or off, but they won't be able to manually control the fan speed.

If there's more than one fan wire installed, the Nest Learning Thermostat will automatically set the fan speed. Your customer will also be able to select a speed in the Fan menu.

Not all multi-speed fan wires are compatible with Nest thermostats. Compatible wires will have labels similar to the following: **G, G1, G2, G3, GL, GM, or GH**

When using multiple fans speeds some HVAC functions will become unavailable. For example, since the Y2 connector is used for fan speed 2 a second stage of cooling cannot be configured. Stage 3 heat, emergency heat and humidifier/dehumidifier will become unavailable when a third fan speed is used.

Variable speed fans, high voltage forced air systems with fans, and proprietary systems with fans are **not** compatible with the Nest Thermostat.

Two Stage Heat Pumps

The Nest Thermostat will automatically recognize your customer's system as a two-stage heat pump if you've connected Y1, Y2, and O/B wires. Nest Thermostat assumes the Y1 wire will be used to activate 1st stage heating and cooling for your heat pump.

Use Pro Setup to configure the Y2 wire to be used for 2nd stage cooling and heating, 2nd stage cooling only, or 2nd stage heating only as well as specify the delivery mechanism (such as forced air or radiant).



Forced Air HVAC Systems - Fan Activation

Depending on your fuel source selection, you'll need to determine when the fan activates for your customer's heating system. Some systems will activate the fan automatically when the thermostat calls for heat. Some systems will rely on the thermostat to activate the fan.

The default setting for fan control on the W1 wire is **Don't activate** because most forced air gas heating systems will activate the fan automatically when the furnace (W1) is activated.

If you test the furnace and the fan doesn't activate, change this option to **Activate**. The thermostat will then call for both the furnace (W1) and fan (G) when heating.



Troubleshooting

Handling Unusual Thermostat Wiring

When a B or X wire is a common wire

Most thermostat manufacturers use **C** to designate the connector for the common wire. However there are some Trane, American Standard, and York thermostats use **B** for the common wire.

The NEMA standard designated the **B** wire as one of the change-over wires for some heat pump manufacturers. This is a simple issue to address:

1. If you're installing a Nest thermostat to control a heat pump system and the current thermostat has both an **B** and a **C**, connect to **B** to the Nest **O/B** connector and connect the **C** to the Nest **C** connector.
2. If you're installing a Nest thermostat to control a heat pump system and the current thermostat has both an **O** and a **B**, connect to **O** to the Nest **O/B** connector and connect the **B** to Nest's **C** connector.
3. If you're installing a Nest thermostat to control a heat pump system and the current thermostat only has a **B** wire, connect to **B** to the Nest **O/B** connector.
4. If you're installing a Nest thermostat to control a conventional system (non heat pump) and you see a **B** wire connected to the current thermostat, that **B** is a common wire and should be connected to the **C** connector on the Nest base.

Important Note: If you have a **B** wire that is actually a common wire, not following the rules above can lead to blowing a fuse on your HVAC controller board and, most likely, damaging the Nest Thermostat.

When X, W1 or W2 is an AUX wire

Some heat pump installations may have the auxiliary heat connection labelled as **X**, **W1** or **W2** on the thermostat.

You should verify that the **X** wire on the old thermostat is not a common wire. Once you're sure, you can assume that the **X** is the auxiliary heat and should be inserted into the **AUX/W2** connector on the Nest Thermostat.

Compressor and Auxiliary Heat Lockout Temperatures for Heat Pumps Requires Wi-Fi

Both auxiliary and compressor lockout temperatures can be changed in the Heat Pump section of the Equipment menu.

The lockout temperatures are only enforced when the Nest Thermostat is connected to Wi-Fi so it can track outdoor temperatures. If Wi-Fi is not enabled, Auxiliary heat will come on automatically when it takes longer than expected to reach the current target temperature.

Search nest.com/support for **auxiliary heat** for more details.

If the Nest thermostat isn't getting enough power from W or Y and there is no Common ("C") wire

While we find that in the vast majority of homes the Nest Thermostat can charge its built in battery by power sharing from the regular heating and cooling wires. But in some rare cases a common wire is needed to deliver consistent power to the Nest Thermostat while allowing normal operation of the heating and cooling system. If there is a common (C) wire installed the Nest Thermostat will not power share.

Symptoms of a power sharing issue

In conventional heating and cooling or cooling only systems:

- Cooling is always on or on intermittently when the thermostat is not calling for cooling.
- Cooling does not activate when the thermostat calls for cooling.
- Cooling intermittently deactivates while the thermostat is still calling for cooling.

In conventional heating only systems:

- Heating is always on or on intermittently when the thermostat is not calling for heating.
- Heating does not activate when the thermostat calls for heating.
- Heating intermittently deactivates while the thermostat is still calling for heating.
- There is a unusual noise coming from the customer's heating system.

In heat pump systems:

- Heating or cooling is always on or on intermittently when the thermostat is not calling for it.
- Heating or cooling does not activate when the thermostat calls for it.
- Heating or cooling intermittently deactivates while the thermostat is still calling for it

In these situations, the thermostat can't successfully charge from the Y or W wires without interfering with the normal operation of the heating and cooling system. There are three options:

Use a spare wire as common wire

The easiest way to solve the problem is by using a spare wire in the thermostat wire as a common wire. Simply connect one end of the the unused wire to the Common ("C") terminal in the HVAC controller and the other end to the thermostat's C connector.

Add a resistor to an existing Y or W wire

We've found that many Y and W wire circuits that cannot supply enough power can be strengthened by bridging the Common terminal at the HVAC equipment to W or Y through a 220-ohm, 5W resistor.

In a heat-only system, you need to bridge from common C to W. In a HVAC system with a Y wire, you must bridge from common C to Y. (Nest can only charge from W when Y is not connected.)

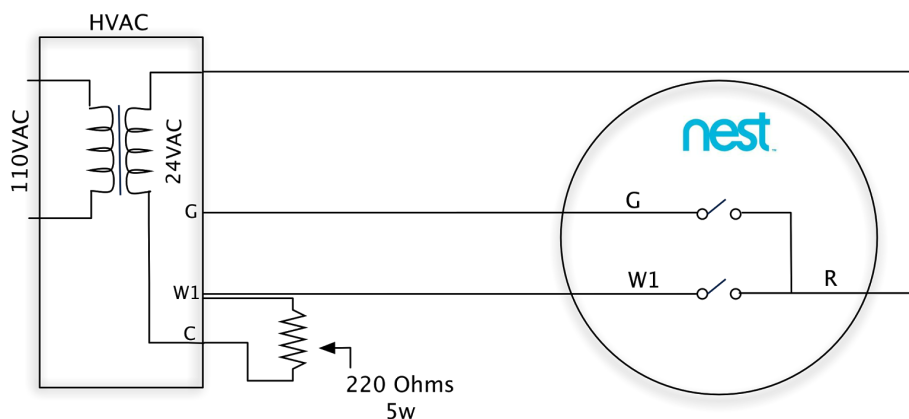

Heat only systems

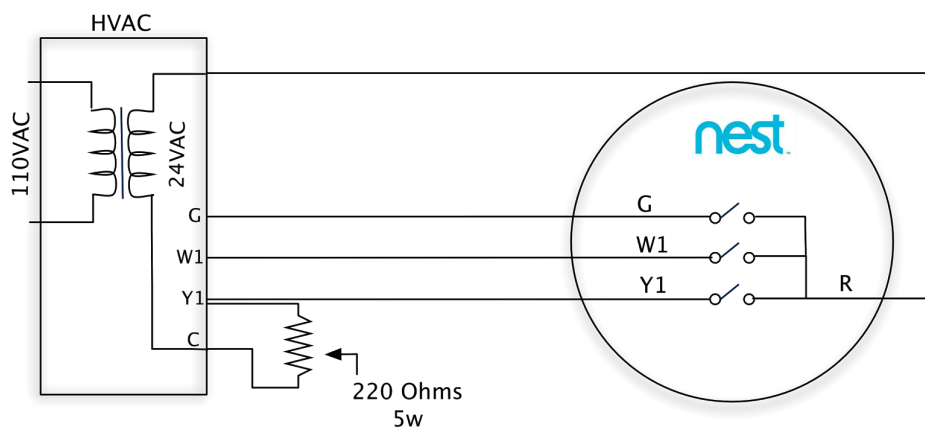

Heating and cooling systems

The heat call is detected by the controller board when the W wire is shorted to the R wire, which causes the 24V AC voltage to be detected. When the Nest thermostat is taking power, a small voltage is generated between W and C (typically less than 8 volts) which can cause a false heat call in a small number of systems. The addition of a 220 Ohm resistor at the furnace provides another current path to the thermostat, which reduces the voltage input at the detect circuit to prevent false heat calls.

Note that this resistor will draw a couple of watts during call for heat (or cool, if the resistor is added to Y) and it will become warm. Make sure to mount the resistor so that it is not in contact with any wires or system components. Between heat or cool calls, the resistor will dissipate less than a ¼ watt.

Pull a new C wire

Replace the thermostat wiring bundle to provide an extra wire to be used as common. Advise your customer that this will require extra work and therefore an additional cost.

Reference Materials

“How To” Quick Reference Guide

Action:	Steps:
Configuring Nest Thermostat for the installation location and HVAC system	<p>Just after installation, the Nest Thermostat will guide you through a set up interview, where you will configure it for the heating and cooling system it's controlling and for the home or business where it's installed.</p> <p>To help with HVAC configuration, the Nest Thermostat mechanically and electrically detects the wires inserted into its press connectors. When the Nest Thermostat senses which wires have been connected to its base, it will automatically configure its software for the system type it has detected.</p> <p>As an example, if it's a heat only system, the Nest Thermostat won't show any cooling options. If it's a heat pump, the Nest Thermostat will know and do a special test to check the orientation of the O/B wire.</p> <p>The set up interview will also guide you through connecting to the customer's Wi-Fi network, establishing the location through zip code, and establishing if the place of installation is a home or business. All of this information helps the Nest Thermostat to build a schedule that is best suited for the customer's needs.</p>
Use Pro Setup to configure your customer's HVAC system	<p>Pro Setup allows professionals to configure how the Nest Thermostat controls each wire connected to the base. Pro Setup is required when using dual fuel systems (e.g. heat pump with furnace), humidifiers and dehumidifiers.</p> <p>Pro Setup also offers configuration choices for other types of systems such as two-stage heat pumps and emergency heat. It is available to installation professionals during and after installation and allows them to specify how the Nest Thermostat should control the HVAC system.</p>
Testing the basic operation after installation	<p>Activate heating and cooling Simply turn the ring to set the current set point above or below the current ambient temperature in the room. You'll need to switch to and from heating and cooling modes as you do this.</p> <p>Switching modes To switch to and from heating and cooling modes, follow these steps:</p> <ol style="list-style-type: none">1. Press the ring to bring up the menu2. Select the Heating and Cooling icon3. Turn the ring to select HEAT or COOL4. Press the ring again to select <p>Note: To protect the heating and cooling systems it controls, Nest Thermostat's minimum on-off times for manual temperature adjustments are 2.5 minutes for heat pumps and air conditioning systems.</p>
Testing second stage or auxiliary heat after installation	<p>Conventional Heating Before Nest Thermostat activates Time-to-Temperature, second stage heat will turn on when the setpoint is 4°F or greater than the room's ambient temperature.</p> <p>Heat Pumps Auxiliary heat will turn on when the setpoint is 4°F and the outdoor temperature is below 50°F, the default auxiliary heat lockout temperature. Auxiliary lockout can be turned off in the Heat Pump section of Equipment Settings in order to test auxiliary heat.</p> <p>To test second stage or auxiliary heat at installation, just raise the temperature 4°F in heating mode with the auxiliary lockout turned off. Once Time to Temperature is activated, the Nest Thermostat will use this feature to manage second stage and auxiliary heat.</p>

<p>Switch between Heating, Cooling, and Range modes</p>	<p>To switch to and from heating and cooling modes, follow these steps:</p> <ol style="list-style-type: none"> 1. Press the ring to bring up the menu 2. Select the Heating and Cooling icon 3. Turn the ring to select HEAT, COOL, HEAT • COOL, or OFF 4. Press the ring again to select
<p>Heat Pump: Setting compressor and auxiliary lockout temperatures</p>	<p>Both auxiliary and compressor lockout temperatures can be changed in the Heat Pump section of the Equipment Settings menu. By default, the Nest Thermostat will lock out the auxiliary heater when the outdoor temperature is above 50°F but will not lockout the compressor at any temperature.</p> <p>The lockout temperatures are only enforced when the Nest Thermostat is connected to Wi-Fi so it can track outdoor temperatures.</p> <p>To access the Heat Pump section of Equipment settings:</p> <ol style="list-style-type: none"> 1. Press the ring to bring up the menu 2. Turn the ring and select SETTINGS 3. Turn the ring and select EQUIPMENT 4. Turn the ring and select HEAT PUMP
<p>Heat Pump: Change heat pump valve orientation</p>	<p>Follow these steps:</p> <ol style="list-style-type: none"> 1. Press the ring to bring up the menu 2. Turn the ring and select SETTINGS 3. Turn the ring and select EQUIPMENT 4. Turn the ring and select HEAT PUMP
<p>Adjust ECO Heating and Cooling Temperatures</p>	<p>These temperatures are set as the final step during the setup interview. But if the Nest Thermostat is already configured, here are the steps:</p> <ol style="list-style-type: none"> 1. Press the ring to bring up the menu 2. Turn the ring and select SETTINGS 3. Turn the ring and select ECO <p>Turn the ring to set the HEAT TO temperature. Press the ring to set the COOL TO temperature. Press the ring again when done.</p>
<p>Adjust Safety Temperatures</p>	<p>No matter the schedule, the Nest Thermostat will never let the home go above or below the safety temperatures. To adjust them, follow these steps:</p> <ol style="list-style-type: none"> 1. Press the ring to bring up the menu 2. Turn the ring and select SETTINGS 3. Turn the ring and select EQUIPMENT 4. Turn the ring and select SAFETY TEMP
<p>Restart or reset the settings on the thermostat</p>	<p>You may need to reset the settings if:</p> <ul style="list-style-type: none"> • You need to restart the thermostat • Reset Nest Sense features • To help with troubleshooting Wi-Fi issues • The thermostat needs to be reconfigured <p>Follow these steps to access the RESET settings:</p> <ol style="list-style-type: none"> 1. Press the ring to bring up the menu 2. Turn the ring and select SETTINGS 3. Turn the ring and select RESET 4. Select one of the following options: CANCEL, RESTART, SCHEDULE, AUTOAWAY, NETWORK, ALL SETTINGS

Setting fan speeds for systems with multi-speed fans

Follow these steps:

1. Press the ring to bring up the menu
2. Select the Fan icon
3. Choose System fan speed
4. Select the fan speed you'd like to use when your system is heating or cooling your home. You can choose Low, Medium, High or Auto, depending on your system's wiring.
5. Choose Done to set your system's fan speed

Downloading the Nest App, creating an account and pairing the Nest Thermostat

To download the Nest App and create an account follow these steps:

1. Download the Nest App on your customer's phone or tablet from the [Apple App Store](#) or [Google Play](#)
2. Open the Nest App and tap Sign up
3. Enter the customer's email address
4. Have your customer enter a password
5. Read and agree to the Nest Terms of Service
6. Have your customer check their email for a "Welcome to Nest" message and instruct them to tap on the included link to activate their Nest Account

To pair the Nest Thermostat with the customer's account follow these steps:

1. Press the thermostat's ring to open the Quick View menu
2. Choose SETTINGS
3. Turn the ring to Nest Account and press the ring to select it
4. Select Get Entry Key and write it down
5. Open the Nest App
6. From the home screen, tap the Settings icon
7. Tap Add product
8. Scan the QR code on the back of the thermostat or tap Continue without scanning and then Nest Thermostat
9. Follow the Nest App's instructions, when prompted type in the entry key you obtained in step 4

You'll see the thermostat appear on the Nest App home screen. Tap the thermostat icon to control it and change settings.

Tips on providing a "Nesty" experience

- Demonstrate how to use the Nest Thermostat:
 - basic temp changes
 - home/eco mode manual switching
 - switching between heat/cool modes, etc.
 - changing the temperature schedule
 - running the fan
- Demonstrate how to use the Nest App
- Explain features like Energy History and Home Report

Wiring error quick reference guide

If the Nest Thermostat senses a problem with the wiring, you'll receive an "E" error. These errors must be fixed before setup can continue. "N" errors are not as critical and setup will continue but certain features may not work. "W" errors indicate there is an issue with the Wi-Fi connection.

"E" errors related to wires not being detected can be the result of a wire not being fully inserted into the connector or terminal. Ensure all wires are fully inserted and the connector buttons are in the down position before performing additional troubleshooting.

Error #	Description:	What's going on?
E72	- No power wires detected - Rh or Rc wire is required	You'll see this error when either a Rh or Rc wire was not installed or the Rh or Rc wire that was installed isn't powered.
E73	- No power to Rc wire detected	You'll see this error if you've installed both an Rc wire and The Nest Thermostat isn't electrically detecting it.
E74	- No power to Rh wire detected	You'll see this error if you've installed both an Rh wire and The Nest Thermostat isn't electrically detecting it.
E75	- No heating or cooling wires detected - W1 or Y1 wire is required	The Nest Thermostat cannot detect any wires inserted into W1 or Y1. At least one of these is required.
E77	- Y1 wire not detected. Heat pump requires a Y1 wire	The Nest Thermostat is physically detecting a wire in the O/B connector. This connector is exclusively used for heat pumps which also require a Y1 wire to be attached.
E78	- Additional wire(s) required. AUX/W2 detected by itself	The Nest Thermostat is physically detecting a wire in the AUX/W2 connector. Supported configurations that use this connector also include a W1 wire or an O/B + Y1 wire.
E79	- No power to C wire detected	The Nest Thermostat is physically detecting a wire in the C connector, but isn't detecting any power to it.
E80	- No power to Y1 wire detected	The Nest Thermostat is physically detecting a wire in the Y1 connector but isn't detecting any power to it.
E82	- No power to W1 wire detected	The Nest Thermostat is physically detecting a wire in the W1 connector but isn't detecting any power to it.
E83	- Heat pump can have at most one auxiliary heat wire	The Nest Thermostat was previously setup as a single fuel system with auxiliary heat but it's detecting both W1 and AUX/W2 wires that aren't supported in that configuration.
E84	- Dual fuel requires an alternate heat wire	The Nest Thermostat was previously setup as a dual fuel system but it's not detecting a W1, AUX/W2 or * (W3) wire that is required to have alternate heat.
E85	- Dual fuel can have at most two alternate heat wires	The Nest Thermostat was set up as a dual fuel system, but the W1, AUX/W2 and * (W3) wires are configured as alternate heat wires.
E86	- Heat pump can have at most one auxiliary heat wire	The Nest Thermostat was previously setup as a single fuel system with auxiliary heat, but it's detecting W1, AUX/W2 and * (W3) wires that aren't supported in that configuration.

E87	- Heat pump can have at most one auxiliary heat wire	The Nest Thermostat was previously setup as a single fuel system with auxiliary heat, but it's detecting W1 and * (W3) wires that aren't supported in that configuration.
E88	- Heat pump can have at most one auxiliary heat wire	The Nest Thermostat was previously set up as a single fuel system with auxiliary heat, but it's detecting AUX/W2 and * (W3) wires that aren't supported in that configuration.
E89	- Y2 wire without Y1 wire	The Nest Thermostat is physically detecting a Y2 wire but not a Y1 wire that is required for 2 stage conventional cooling systems or 2 stage heat pumps.
E90	- W3 wire without W2/AUX wire	The Nest Thermostat is physically detecting a * (W3) wire but not a W2/AUX wire that is required for 3 stage conventional heating systems.
E91	- E wire without O/B wire	The Nest Thermostat is physically detecting a * (E) wire but not an O/B wire. O/B is a heat pump wire and Nest only supports the use of emergency heat with heat pump systems.
E92 E93 E94 E95 E96 E97 E98 E99 E100 E101	- Your Nest may have tripped an internal fuse and Nest needs to be replaced	The Nest Thermostat either has wires that aren't fully inserted into the connectors or has tripped an internal fuse.
E102 E103 E104 E105 E106 E107 E108	- The Nest Thermostat has an overcurrent error	The Nest Thermostat may be wired incorrectly, or your system may be incompatible.
E109	- G2 detected. G1 wire is also required	The Nest Thermostat is physically detecting a G2 (fan) wire in the Y2 connector, but it's not detecting a wire in the G connector. Both wires are required for a multi-speed fan.
E110	- G2 wire detected. Remove W2/AUX wire	The Nest Thermostat is physically detecting a wire in the W1 connector, a wire in the AUX/W2 connector, and a G2 (fan) wire in the Y2 connector. This indicates you have more than one stage of heat and more than one fan speed. The Nest Thermostat does not support multiple stages of heat and multiple fan speeds at the same time.
E111	- G2 wire detected. Remove E wire	The Nest Thermostat has detected a G2 (fan) wire in the Y2 connector, and an emergency heat wire in the connector. The Nest Thermostat doesn't support a multi-speed fan and emergency heat together.
E112	- G wire detected. G1 and G2 also required	The Nest Thermostat is physically detecting a G3 (fan) wire in the connector, but it isn't detecting a G2 (fan) wire in the Y2 connector or a wire in the G connector. All three wires are required for a three speed fan.
E113	- G2 and O/B wire conflict	The Nest Thermostat has detected a G2 (fan) wire in the Y2 connector, and a wire in the O/B connector. This wiring indicates a multi-speed fan and a heat pump. The Nest Thermostat doesn't support this kind of system.
N71	- Power wire Rc detected. Not connected	The Nest Thermostat isn't electrically detecting the Rc wire, but one is connected to the Nest base.

	to equipment	
N72	- Power wire Rh detected. Not connected to equipment	The Nest Thermostat isn't electrically detecting the Rh wire, but one is connected to the Nest base.
N73	- No power to W1 wire detected	The Nest Thermostat isn't electrically detecting the W1 wire, but one is connected to the Nest base.
N74	- No power to Y1 wire detected	The Nest Thermostat isn't electrically detecting the Y1 wire, but one is connected to the Nest base.
N75	- No power to AUX/W2 wire detected	The Nest Thermostat isn't electrically detecting the AUX/W2 wire, but one is connected to the Nest base.
N76	- No power to G wire detected	The Nest Thermostat isn't electrically detecting the G wire, but one is connected to the Nest base.
N77	- No power to O/B wire detected	The Nest Thermostat isn't electrically detecting the O/B wire, but one is connected to the Nest base.
N78	- No power to Y2 wire detected	The Nest Thermostat isn't electrically detecting the Y2 wire, but one is connected to the Nest base
N79	- No power to * wire detected	The Nest Thermostat isn't electrically detecting the * wire, but one is connected to the Nest base.
W1	- Nest can't continue to connect to your Wi-Fi network	The Wi-Fi access point may now fully support a Wi-Fi standard known as power saving mode.
W2	- Failed to connect	The Wi-Fi access point may have security settings enabled that prevent the Nest Thermostat from connecting.
W3	- Failed to connect	The Wi-Fi access point is not providing a network IP address to the Nest Thermostat.
W4	- Failed to connect	The Nest Thermostat is connected to the wireless network but not to the internet.

Important Note:

These errors may change with future software updates. Visit nest.com/support for the latest information.

Troubleshooting Quick Reference Guide

Symptom:	What's going on:	Steps to fix:
<p>Nest doesn't turn on after installation</p> <p>Red LED blinking on front</p>	<p>The internal battery is low and needs to charge.</p>	<p>If you leave it where it is, it will slowly charge and eventually turn on. This can take an hour or two.</p> <p>If you have a micro-USB cable and wall charger you can charge it more quickly over USB.</p>
<p>Nest doesn't turn on after installation</p> <p>No LED blinking on the front of the unit</p>	<p>The power was never turned back on.</p>	<p>Use normal electrical troubleshooting techniques to isolate the issue to either the fuse/breaker box or a fuse on the HVAC controller board.</p>
<p>Unit seems to be running backwards (HEAT PUMP)</p>	<p>If it is heating when it is supposed to be cooling and visa versa, the orientation of the heat pump is probably incorrect.</p>	<p>Follow these steps to change the heat pump orientation:</p> <ol style="list-style-type: none"> 1. Press the ring to bring up the menu 2. Turn the ring and select SETTINGS 3. Turn the ring and select EQUIPMENT 4. Turn the ring and select HEAT PUMP
<p>Fan doesn't come on</p>	<p>Either there is an issue with the air handler or with the Nest Thermostat.</p>	<p>First, check the wiring to make sure the wires are in the right place and the wire tips are straight and fully inserted into the connectors.</p> <p>If that doesn't work, turn off HVAC breakers and pull out the Rh and the G wires. Carefully hold them together with the copper ends touching for 10-20 seconds.</p> <p>If the fan turns on there may be a hardware issue with the device, so please contact us.</p> <p>If the fan did not turn on, there is an issue with the heating and cooling system unrelated to the Nest thermostat.</p>
<p>Your customer is seeing a question mark on their Nest Thermostat when they use one of the Nest apps</p>	<p>The Nest app will show a question mark over the thermostat when the Nest servers can't communicate with the device. This may happen if:</p> <ol style="list-style-type: none"> 1. The customer's Internet Service Provider is down 2. The customer's router is incompatible with the Nest Thermostat 3. The Nest servers are down or undergoing maintenance 	<p>First, you should verify that the customer's internet connection is working and that their Wi-Fi network is online.</p> <p>If it is, check the Nest system status in the upper right of nest.com/support. Nest will publish maintenance or outage information there.</p> <p>The last thing to check is if the customer's Wi-Fi router is compatible with the Nest Thermostat.</p> <p style="text-align: right;"><i>continued...</i></p>

		Wi-Fi troubleshooting help can be found here: https://nest.com/support/article/Troubleshooting-Wi-Fi-and-connection-issues
Forgot Lock Code	Customer has forgotten the lock code to their Nest Thermostat	The Nest Thermostat can be remotely unlocked by logging onto the Nest Account paired with their device from the Nest Web app or from the Nest Mobile app.

Humidifier Configurations

Stand Alone Humidifier, 1 Wire

- This system has a humidifier that is separate from the HVAC system.
- Install the hum wire directly into the * terminal.
- Correctly ground the other wire from the Humidifier.
- No relay is recommended.

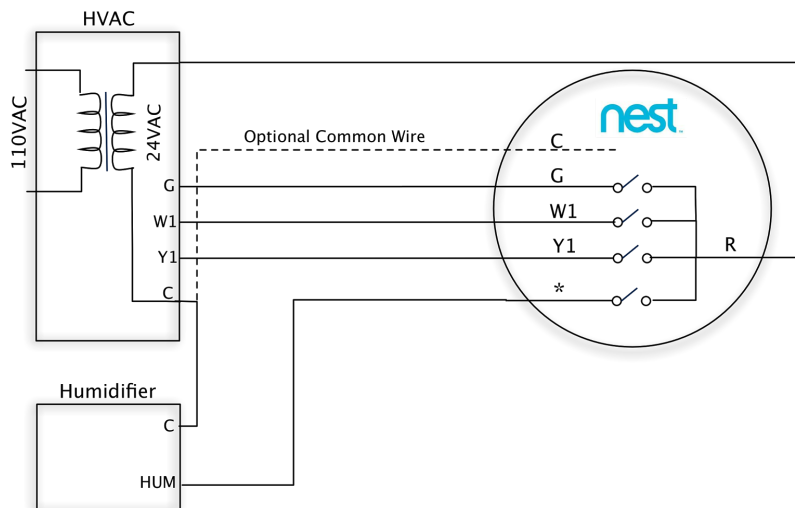

Stand Alone Humidifier, 2 Wire

- This system has a humidifier that is separate from the HVAC system.
- Install the 2 hum wires directly into the relay.
- Run the single wire from the relay to the * terminal.
- Nest recommends the White Rogers 90-290Q or similar 24VAC HVAC relay.

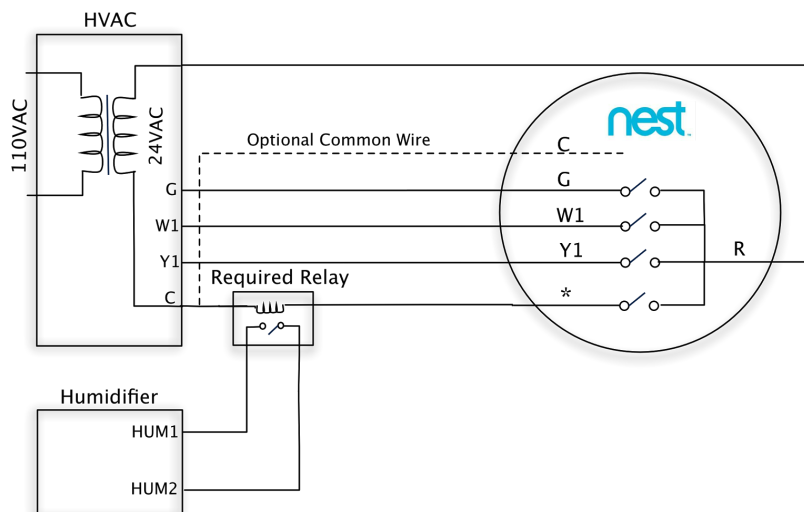

Where to Find Additional Help

- Help online: <https://nest.com/support/thermostat/>
- Nest Pro Tech Support: 1-855-VIP-NEST (1-855-847-6378)
Dedicated Pro Support Hours: 6am-6pm (pacific), 9am-9pm (eastern)