

CLICK ANYWHERE on THIS PAGE to return to NEST THERMOSTAT INSTALLATION & WIRING at [InspectApedia.com](https://www.InspectApedia.com)



Learning Thermostat  
Installation Guide

## Compatibility

Based on Nest's online compatibility checker data, the Nest Thermostat works with most 24V systems, including gas, electric, oil, forced air, variable speed, heat pump and radiant. It can control:

- Heating: one, two and three stages (W1, W2, W3)
- Cooling: one and two stages (Y1, Y2)
- Heat pump: with auxiliary and emergency heat (O/B, AUX, E)
- Fan (G)
- Power (C, Rh, Rc)
- Humidifier or dehumidifier (HUM, DEHUM)

The Nest Thermostat's \* connector can accept only one of these wires: W3, E, HUM or DEHUM.

The Nest Thermostat is designed to work even if your home doesn't have a common C wire. Rarely, installing a new C wire may be required.

Professional installation recommended for:

- Dual fuel systems (heat pump with furnace)
- Whole-home humidifiers and dehumidifiers

Go to [nest.com/works](https://nest.com/works) to make sure the Nest Thermostat will work in your home and find out if you need professional installation.

## Watch the video

Before you start, watch our installation video at [nest.com/support](https://nest.com/support)

## Contents

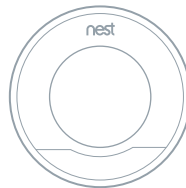

Display

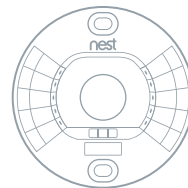

Base



Screwdriver

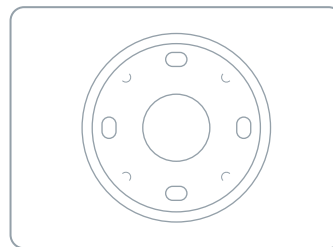

Optional trim plate

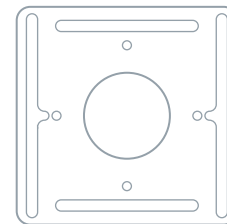

Optional steel plate



Wall screws



Optional steel plate screws

## 1. Switch off power

This protects you and avoids blowing a fuse in your equipment. Adjust the temperature on your old thermostat to make sure your system is off.

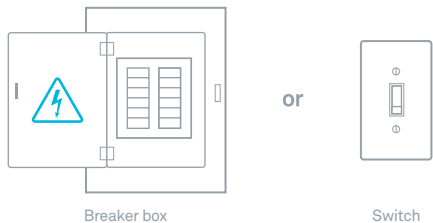

## 2. Remove cover

Some covers pop off, while others need to be unscrewed.

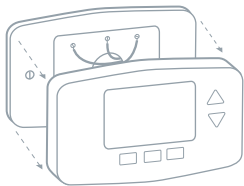

## 3. Check your system

If your old thermostat is labeled 120V or 240V or has thick wires with wire nuts, your system is high voltage. Not sure? Contact support.

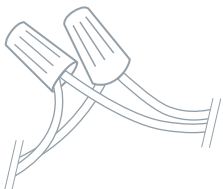

**⚠ CAUTION:** Do not connect Nest to high voltage wires.

## 4. Remove any jumper wires

Jumper wires are short wires between two connectors. You won't need them. An R wire can go into either Rc or Rh.

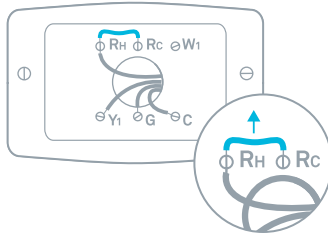

## 5. Label wires

Peel off the blue labels and attach them to your wires. Use the white labels if you have a E, W3, HUM or DEHUM wire. You can connect only one of these wires to the \* connector.

See two labels for each connector?  
Visit [nest.com/2labels](https://nest.com/2labels) for help.

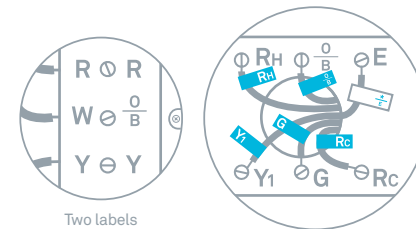

Tip: Take a picture of the wires on your old thermostat to help you remember.

## 6. Disconnect wires and remove base

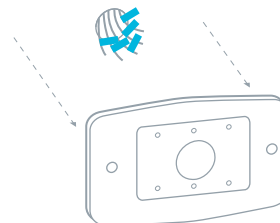

**⚠ Remember, the power to your HVAC system must be off to avoid blowing a fuse in your equipment.**

## 7. Mark where screws will go

Use the bubble level to make sure the Nest Thermostat is level.

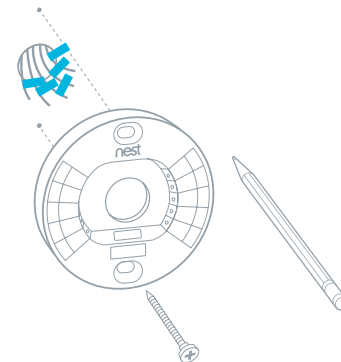

Optional in most homes

## Use trim plate if needed

You can cover up holes or marks left by your old thermostat with the optional trim plate.

Snap the base and trim plate together, then screw them to the wall.

You'll find the trim plate in the bottom of the box.

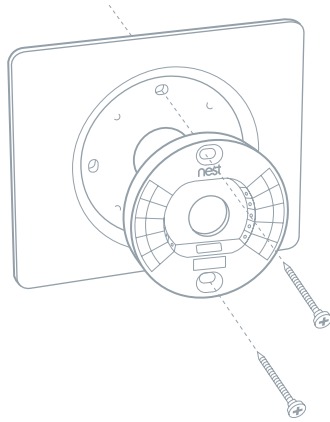

Optional in most homes

## Mounting on an electrical box

Electrical boxes aren't common, but if you have one, secure the steel plate to the electrical box with two of the short steel plate screws. Insert the screws into the long slots on the steel plate.

Use the other two short screws to attach the Nest base and trim plate to the steel plate.

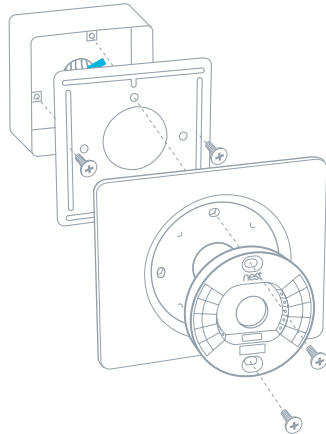

## 8. Attach base

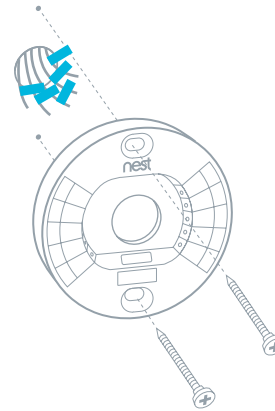

## 9. Connect wires

After all the wires are connected, make sure they're flush with the wall.

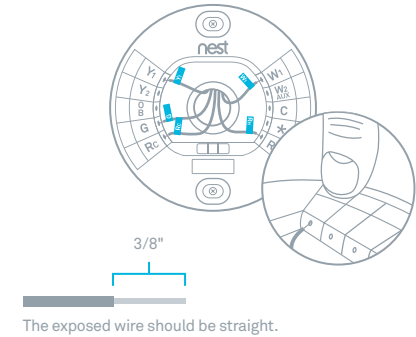

## 10. Attach display

Press the display until it clicks into place.

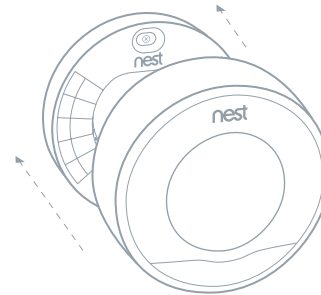

## 11. Switch power back on

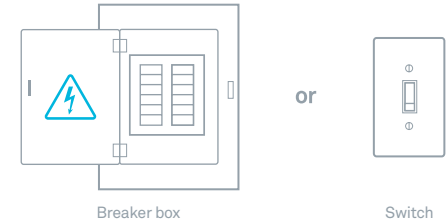

## 12. Setup and Nest Account

The Nest Thermostat will turn on and walk you through setup. Just turn the ring and press to select. During setup, you can connect the thermostat to Wi-Fi.

Go to [nest.com/account](https://nest.com/account) or download the Nest app and create a Nest Account. Your thermostat will connect to your account automatically.

Questions about adding a thermostat to your Nest Account? Visit [nest.com/pairing](https://nest.com/pairing)



## Nest Labs, Inc. Limited Warranty Learning Thermostat

IMPORTANT INFORMATION ABOUT YOUR RIGHTS AND OBLIGATIONS, AS WELL AS LIMITATIONS AND EXCLUSIONS THAT MAY APPLY TO YOU.

### YOUR RIGHTS AND THIS LIMITED WARRANTY

This Limited Warranty gives you specific legal rights. You may also have other legal rights that vary by state, province or jurisdiction. The disclaimers, exclusions, and limitations of liability under this Limited Warranty will not apply to the extent prohibited by applicable law. For a full description of your legal rights you should refer to the laws applicable in your jurisdiction and you may wish to contact a relevant consumer advisory service.

**1. WHAT THIS LIMITED WARRANTY COVERS; PERIOD OF COVERAGE**  
Nest Labs, Inc. ("Nest Labs"), 900 Hansen Way, Palo Alto, California USA, warrants to the owner of the enclosed product that the product contained in this box ("Product") will be free from defects in materials and workmanship for a period of two (2) years [one (1) year for Factory Refurbished Products] from the date of delivery following the original retail purchase (the "Warranty Period"). If the Product fails to conform to this Limited Warranty during the Warranty Period, Nest Labs will, at its sole discretion, either (a) repair or replace any defective Product or component; or (b) accept the return of the Product and refund the money actually paid by the original purchaser for the Product. Repair or replacement may be made with a new or refurbished product or components, at Nest Labs' sole discretion. If the Product or a component incorporated within it is no longer available, Nest Labs may replace the Product with a similar product of similar function, at Nest Labs' sole discretion. This is your sole and exclusive remedy for breach of this Limited Warranty. Any Product that has either been repaired or replaced under this Limited Warranty will be covered by the terms of this Limited Warranty for the longer of ninety (90) days from the date of delivery or the remaining Warranty Period. This Limited Warranty is transferable from the original purchaser to subsequent owners, but the Warranty Period will not be extended in duration or expanded in coverage for any such transfer.

### 2. TOTAL SATISFACTION RETURN POLICY

If you are the original purchaser of the Product and you are not satisfied with this Product for any reason, you may return it in its original condition within thirty (30) days of the original purchase and receive a full refund.

### 3. WARRANTY CONDITIONS; HOW TO GET SERVICE IF YOU WANT TO CLAIM UNDER THIS LIMITED WARRANTY

Before being able to claim under this Limited Warranty, the owner of the Product must (a) notify Nest Labs of the intention to claim by visiting <http://support.nest.com> during the Warranty Period and providing a description of the alleged failure, and (b) comply with Nest Labs' return shipping instructions, and (c) ship the Product at



For more information visit [nest.com](https://nest.com)

You can also find answers in the Nest Community at [nest.com/community](https://nest.com/community)



Recycle your old thermostat: see [nest.com/responsibility](https://nest.com/responsibility)

Please recycle Nest's 100% recyclable packaging.

owner's cost (except where prohibited by applicable law) to Nest Labs for repair or replacement. Nest Labs will have no warranty obligations with respect to a returned Product if it determines, in its reasonable discretion after examination of the returned Product, that the Product is an Ineligible Product (defined below). Nest Labs will bear all costs of return shipping to owner, except with respect to any Ineligible Product, for which owner will bear all shipping costs.

#### **4. WHAT THIS LIMITED WARRANTY DOES NOT COVER**

This warranty does not cover the following (collectively "Ineligible Products"): Products marked as "sample" or sold "AS IS"; or Products that have been subject to: (a) modifications, alterations, tampering, or improper maintenance or repairs; (b) handling, storage, installation, testing, or use not in accordance with the Installation Guide or other instructions provided by Nest Labs; (c) abuse or misuse of the Product; (d) breakdowns, fluctuations, or interruptions in electric power or the telecommunications network; or (e) Acts of God, including lightning, fire, flood, tornado, earthquake, or hurricane. This warranty does not cover consumable parts, including batteries, unless damage is due to defects in materials or workmanship of the Product, or software (even if packaged or sold with the product). Nest Labs recommends that you use only authorized service providers for maintenance or repair. Unauthorized use of the Product or software can impair the Product's performance and may invalidate this Limited Warranty. Nest Labs does not warrant that operation of the Product will be error-free or uninterrupted or that the Product will in every case process all data correctly.

#### **5. DISCLAIMER OF WARRANTIES**

EXCEPT AS STATED ABOVE IN THIS LIMITED WARRANTY, AND TO THE MAXIMUM EXTENT PERMITTED BY APPLICABLE LAW, NEST LABS DISCLAIMS ALL EXPRESS, IMPLIED, AND STATUTORY WARRANTIES AND CONDITIONS WITH RESPECT TO THE PRODUCT, INCLUDING THE IMPLIED WARRANTIES OF MERCHANTABILITY, FITNESS FOR A PARTICULAR PURPOSE. TO THE MAXIMUM EXTENT PERMITTED BY APPLICABLE LAW, NEST LABS ALSO LIMITS THE DURATION OF ANY IMPLIED WARRANTIES OR CONDITIONS TO THE DURATION OF THIS LIMITED WARRANTY.

#### **6. LIMITATION OF DAMAGES**

IN ADDITION TO THE ABOVE WARRANTY DISCLAIMERS, IN NO EVENT WILL NEST LABS BE LIABLE FOR ANY CONSEQUENTIAL, INCIDENTAL, EXEMPLARY, OR SPECIAL DAMAGES, INCLUDING ANY DAMAGES FOR LOST DATA OR LOST PROFITS, ARISING FROM OR RELATING TO THIS LIMITED WARRANTY OR THE PRODUCT, AND NEST LABS' TOTAL CUMULATIVE LIABILITY ARISING FROM OR RELATED TO THIS LIMITED WARRANTY OR THE PRODUCT WILL NOT EXCEED THE AMOUNT ACTUALLY PAID FOR THE PRODUCT BY THE ORIGINAL PURCHASER.

#### **7. LIMITATION OF LIABILITY**

NEST LABS DISCLAIMS ALL LIABILITY OF ANY KIND OF NEST LABS' SUPPLIERS. THE NEST LABS ONLINE SERVICES ("SERVICES") PROVIDE YOU INFORMATION ("PRODUCT INFORMATION") REGARDING YOUR ENERGY USE AND YOUR HVAC EQUIPMENT OR OTHER PERIPHERALS CONNECTED TO YOUR PRODUCT ("PRODUCT PERIPHERALS"). THE TYPE OF PRODUCT PERIPHERALS THAT MAY BE CONNECTED TO YOUR PRODUCT MAY CHANGE FROM TIME TO TIME. THE SERVICES MAY BE USED TO CONTROL YOUR HEATING, VENTILATION, AND AC SYSTEM OR PRODUCT PERIPHERALS VIA THE PRODUCT. WITHOUT LIMITING THE GENERALITY OF THE DISCLAIMERS ABOVE, ALL PRODUCT INFORMATION IS PROVIDED FOR YOUR CONVENIENCE, "AS IS", AND "AS AVAILABLE". NEST LABS DOES NOT REPRESENT, WARRANT, OR GUARANTEE THAT PRODUCT INFORMATION WILL BE AVAILABLE, ACCURATE, OR RELIABLE OR THAT PRODUCT INFORMATION OR USE OF THE SERVICES OR PRODUCT WILL DECREASE THE ENERGY CONSUMPTION OF YOUR HOME. YOU ARE SOLELY RESPONSIBLE FOR ALL ENERGY BILLS INCURRED BY YOUR HOME. YOU USE ALL PRODUCT INFORMATION, THE SERVICES, AND THE PRODUCT AT YOUR OWN DISCRETION AND RISK. YOU WILL BE SOLELY RESPONSIBLE FOR (AND NEST LABS DISCLAIMS) ANY AND ALL LOSS, LIABILITY, OR DAMAGES, INCLUDING TO YOUR HVAC SYSTEM, PLUMBING, HOME, PRODUCT, PRODUCT PERIPHERALS, COMPUTER, MOBILE DEVICE, AND ALL OTHER ITEMS AND PETS IN YOUR HOME, RESULTING FROM YOUR USE OF THE PRODUCT INFORMATION, SERVICES, OR PRODUCT. PRODUCT INFORMATION PROVIDED BY THE SERVICES IS NOT INTENDED AS A SUBSTITUTE FOR DIRECT MEANS OF OBTAINING THE INFORMATION. FOR EXAMPLE, A TEMPERATURE READING IN THE PRODUCT INFORMATION PROVIDED BY THE SERVICES IS NOT INTENDED AS A SUBSTITUTE FOR READING THE TEMPERATURE AS DIRECTLY DISPLAYED BY THE PRODUCT.

#### **8. VARIATIONS THAT MIGHT APPLY TO THIS LIMITED WARRANTY**

Some jurisdictions do not allow limitations on how long an implied warranty lasts or exclusions/limitations on incidental or consequential damages, so some of the limitations set out above may not apply to you.