

INSTALLATION AND OPERATION MANUAL

EPET SERIES EXPLOSION PROOF THERMOSTATS

The Columbus Electric EPET Series thermostat is designed to control heating only, cooling only, heating and cooling or ventilation systems in oil refineries, grain elevators, munitions plants, hospital operating rooms and other hazardous locations.

The switching mechanism is enclosed in a 1/2" thick cast aluminum case which is dust proof and dust resistant. A reliable sensing element provides accurate response to temperature change and does not require leveling during installation.

The casing is tapped top and bottom for 3/4" conduit. A 1/2" adapter is included.

SPECIFICATIONS

Electrical Ratings: 22 Amp @ 125 - 277 VAC
3/4 HP @ 125VAC
1 1/2 HP @ 250 - 277 VAC

Dimensions: 5.62" x 6.37" x 4.43"
Approvals: UL and CSA
Class I Groups C & D
Class II Groups E, F & G
Temperature adjustment range: 50-90°F

Differential : Heat- 2°F / Cool- 4°F

INSTALLATION

ALL WIRING MUST COMPLY WITH NFPA-70 (NEC), LOCAL AND STATE CODES.

Locate the thermostat approximately five feet (5') above the floor in a location that will best sense the average temperature of the area to be controlled. Do not mount the thermostat adjacent to water pipes, in drafty areas, or other locations that would adversely affect the operation of the thermostat.

- 1) Remove the thermostat cover assembly from the base by removing the four corner screws. Set the cover assembly aside. **CAUTION: Marring of the mating surfaces of the enclosure could destroy the integrity of the seal causing unsafe conditions during thermostat operation.**
- 2) Mount the thermostat base on the surface selected. See Fig. 1 for dimensions.
- 3) The base is tapped for 3/4" conduit; a 1/2" conduit adapter and a 3/4" plug is provided. Two threaded openings are provided for wiring. Unused openings must be properly plugged with the plug provided prior to applying power to the unit.
- 4) Connect the conduit to the mounted base and pull the required wires into the base.
- 5) Connections are to be made to the switch terminals on the rear of the cover assembly. See Fig. 2. The cover assembly can then be attached to the base using the four mounting screws. **TIGHTEN TO A MINIMUM OF 40 INCH POUNDS.**
- 6) The installer must seal each conduit run within 18" of the thermostat enclosure. This seal must be a suitable, listed hazardous location fitting.

DIAGRAMS

FIG. 1

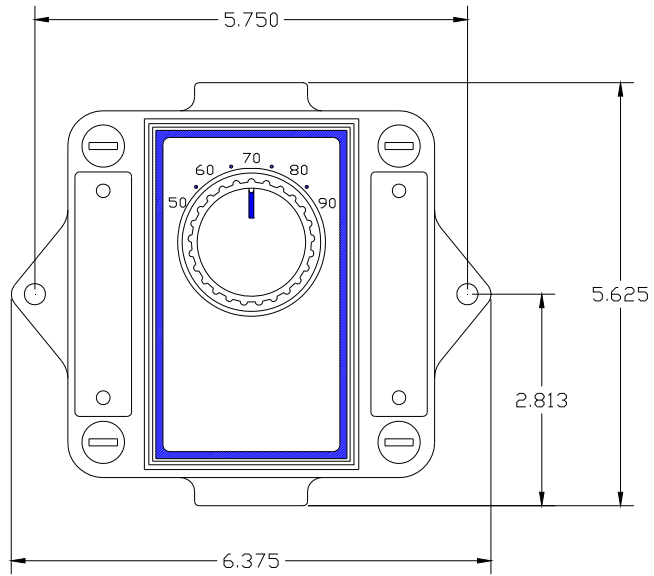
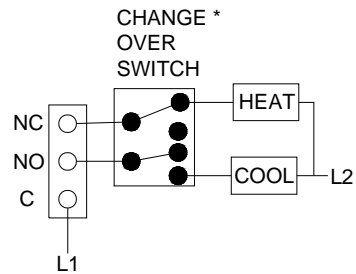
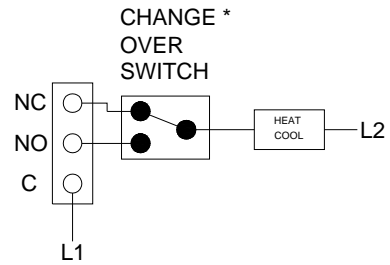
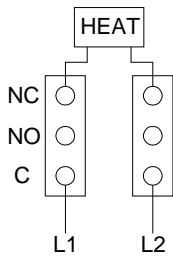
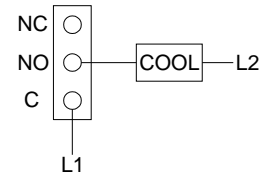
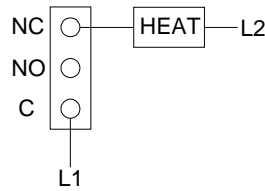
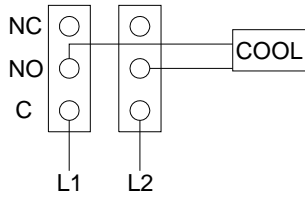

FIG. 2

TYPICAL WIRING DIAGRAMS



* TO BE PROVIDED BY OTHERS