



Burner Manual Supplement

for Weil-McLain Boilers

GOLD Oil

Nozzle selections and burner settings

1. See Table 1 for recommended oil nozzle selections and initial burner settings. Follow Burner Manual and Boiler Manual for installation of nozzle if not supplied with boiler/burner.
2. Where the table calls for an oil pump pressure other than as shipped, adjust the pump pressure to the setting shown, following pump manufacturer's instructions.

Specifications

1. See Table 1 for parts and burner settings.

WARNING

Installer/servicer — Except where specifically stated otherwise, this Supplement must be used only by a **qualified service technician**. Follow all guidelines in the Burner Manual and Boiler Manual. Failure to comply with this or other requirements in this manual could result in severe personal injury, death or substantial property damage.

Table 1 Burner specifications and settings for Weil-McLain GOLD Oil Boilers

Boiler model	Burner model	Primary control			Ignitor	Fuel unit	Oil valve	Motor	Air tube & welded flange					Comb. head	Air band
		Carlin model	Prepurge	Postpurge					Part no.	Tube	UTL	Pitch	Flange		
GO-2	EZ-1HPW	60200-02	10 sec	10 sec	41000	Suntec A2VA-3006	Built into fuel unit	PSC 1/6 HP 115V/1Ph 98022	84863	5" 77727	3 1/8"	1 1/2°	7 3/4" 83055 Gasket 40212	5" 77958	EZ-1HPW
GO-3	EZ-1HPW														
GO-4	EZ-1HPW														
GO-5	EZ-1HPW														
GO-6	EZ-2HPW								84871	5" 83816					EZ-2HPW

Boiler model	Burner model	Input	Nozzle specifications				Oil pump pressure	Head bar	Air shutter	Air band setting	Draft overfire
			GPH	Size	Type	Manufacturer					
GO-2	EZ-1HPW	0.70	0.65	70B	Delavan	140	0.60 – 0.65	EZ-1	0.65	– 0.01 to – 0.02	
GO-3	EZ-1HPW	0.95	0.85	60B	Delavan	140	0.85 – 1.00		0.85		
GO-4	EZ-1HPW	1.20	1.10	60B	Delavan	140	1.10 – 1.25		1.10		
GO-5	EZ-1HPW	1.45	1.25	60B	Delavan	140	1.10 – 1.25		1.25		
GO-6	EZ-2HPW	1.75	1.50	60B	Delavan	140	1.50		EZ-2		1.50



MODEL **EZ-1/2/3**TM Oil burners

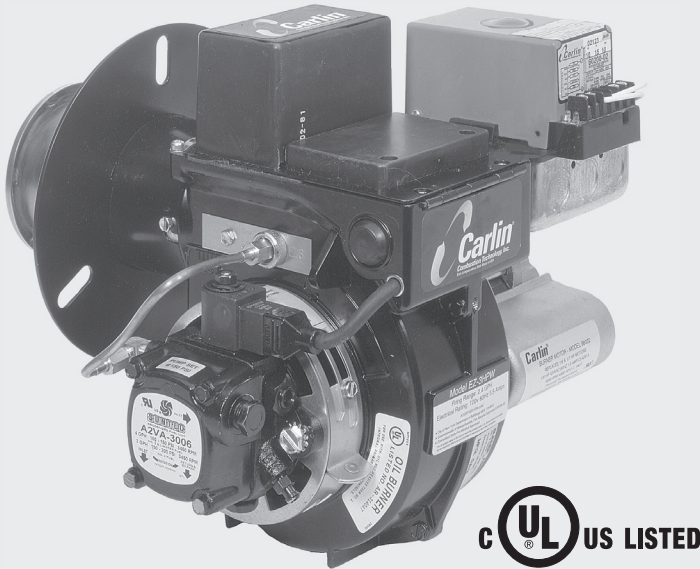

Ratings

Input:	EZ-1, EZ-1-HP.....0.50 to 1.65 GPH
	EZ-2, EZ-2-HP..... 1.50 to 2.25 GPH
	EZ-3, EZ-3-HP..... 2.00 to 2.60 GPH
Fuels:No. 1 or No. 2 heating oil (ASTM D396)
Fuel unit:Suntec
	EZ-1,-2 or -3.....100 PSIG NOZZLE PRESSURE
	EZ-1,-2 or -3-HP..... Over 100 PSIG NOZZLE PRESSURE
Electrical:	Power..... 120V/60 Hz/1-PHASE
	Motor..... Carlin PSC, 1/6 HP, 3450 RPM
	Current..... Approx. 2.5 AMPS
Ignition: Carlin Model 41000 electronic — 14,000 VOLTS
Control: U.L. Group I or II primary safety control
Agencies: UL Listed (US and Canada)

WARNING **Installer/servicer** — Except where specifically stated otherwise, this manual must be used only by a *qualified service technician*. Failure to comply with this or other requirements in this manual could result in severe personal injury, death or substantial property damage.

WARNING **User** — Refer only to User's Information booklet for information regarding operation of this burner. The burner Instruction Manual is intended only for your service technician. The burner and heat exchanger must be inspected and started at least annually by your service technician.

Instruction manual

Contents

PLEASE read this first.....	2
Codes and standards.....	2
EZ-1/2/3 application information	3
Prepare site • assemble burner • mount burner	5
Prepare burner	10
Wire burner • start burner — 48245 primary control ...	14
Wire burner • start burner — 40200/42230 primary	16
Wire burner • start burner — 50200 primary control ...	18
Wire burner • start burner — 60200 primary control ...	20
Adjustment and verification	22
Annual start-up and service.....	23
Repair parts.....	24
Maintenance procedures.....	26
Limited warranty	27
User care and maintenance	Rear cover

© Copyright 2010 — Carlin Combustion Technology, Inc.

Carlin Combustion Technology, Inc.
70 Maple Street East Longmeadow, MA 01028
Ph 413-525-7700 Fx 413-525-8306

TECH SUPPORT 800-989-2275

carlincombustion.com

PLEASE read this first . . .

Special attention flags

Please pay particular attention to the following when you see them throughout this manual.

DANGER Notifies you of hazards that *WILL* cause severe personal injury, death or substantial property damage.

WARNING Notifies you of hazards that *CAN* cause severe personal injury, death or substantial property damage.

CAUTION Notifies you of hazards that *WILL* or *CAN* cause minor personal injury or property damage.

NOTICE Notifies you of special instructions on installation, operation or maintenance that are important, but are not normally related to injury or property damage hazards.

General information

Burner applications

Follow all instructions in this manual, the primary control data sheet and the appliance manual. Verify the burner is correct for the appliance being used and for all applicable codes/standards.

Damage or shortage claims

The consignee of the shipment must file damage or shortage claims immediately against the transportation company.

When calling or writing about the burner . . .

Please provide us with the UL serial number and burner model number to assist us in locating information. This information can be helpful when troubleshooting or obtaining replacement parts.

WARNING

Should overheating occur:

- (1) Shut off the oil supply to the burner.
- (2) **DO NOT** shut off the control switch to the circulator or blower.

WARNING

Follow the guidelines below to avoid potential severe personal injury, death or substantial property damage.

Burner options . . .

Optional Burner Cover with air intake adapter

- Carlin's optional EZ-burner cover is available on all EZ-1/2/3 models.
- Combustion air can be taken from the room or can be piped to the burner cover when the optional air intake adapter is installed. (Requires Field CAS-1 combustion air system.)
- See separate instructions provided with the cover for installation and special instructions required with the cover.

Optional P/N 97406 Air Intake System (EZ-1 only)

- Carlin's 97406 Air Intake System may be supplied with model EZ-1 burners only. (Also requires Field CAS-1 combustion air system.)
- The air intake adapter is bolted to the burner housing. The adapter includes air shutter and indicator.
- See separate instructions provided with the cover for installation and special instructions required with the cover.

Installer/service technician . . .

- Read all instructions before proceeding. Perform all procedures, and in the order given to avoid potential of severe personal injury, death or substantial property damage.
- Before leaving the site after startup or service, review the *User's information* page with the user. Make the user aware of all potential hazards and perform the training outlined below.

Train the user . . .

- To properly operate the burner/appliance per this manual and the appliance instructions see *User's information*.
- To keep this manual at or near the burner/appliance for ready access by the user and service technician.
- To contact the service technician or oil dealer if he encounters problems with the burner/appliance.
- To keep the appliance space free of flammable liquids or vapors and other combustible materials.
- Do not use laundry products, paints, varnishes or other chemicals in the room occupied by the burner/appliance.
- To contact the service technician at least annually for startup and burner/appliance service.

When servicing the burner . . .

- Disconnect the electrical supply to the burner before attempting to service to avoid electrical shock or possible injury from moving parts.
- Burner and appliance components can be extremely hot. Allow all parts to cool before attempting to handle or service to avoid potential of severe burns.

1. EZ-1/2/3 application information

Codes and standards

Certification

EZ-1/2/3 burners are U.L. listed for the U.S. and Canada, certified to comply with ANSI/UL 296, for use with #1 or #2 heating oil (per standard ASTM D396).

Burner labels list compliance, when required, with special local, state or provincial approvals.

NOTICE Install this burner in accordance with all local codes and authorities having jurisdiction. Regulations of these authorities take precedence over the general instructions provided in this manual.

United States installations

Burner/appliance installations in the United States must comply with the latest editions of NFPA 31 (Standard for the Installation of Oil-Burning Equipment), ANSI/NFPA 70 (National Electrical Code), and all applicable local codes.

Canadian installations

Burner/appliance installations in Canada must comply with the latest editions of CSA B139 (Installation Code for Oil Burning Equipment), CSA standard C22, Part 1 (Canadian Electrical Code), and all applicable local codes.

Conversion burners

General information – conversion burners

Carlin Elite burners are shipped for general distribution, with fuel units set for 100 PSIG. Burners are usually shipped assembled, with a universal slip-on flange. Air tubes and housings will be installed or shipped in separate boxes for field assembly.

Before installing the burner, follow guidelines in this manual to ensure you are using the correct nozzle, head-positioning bar and air tube length.

Oil nozzle selection – conversion burners

If oil nozzle selection information for the application is not available from appliance documents, you can use Table 1, page 4, for an initial nozzle selection for the application. Specific applications may require testing more than one nozzle to obtain both clean combustion and a good match of flame shape to the combustion chamber.

OEM burners

General information – OEM burners

Elite burners manufactured for heating appliance manufacturers (OEM's) are generally identical to conversion burners (distributed through supply houses) with one or more of the following differences:

- Burners may be fully assembled, with a welded flange set at the proper insertion depth and pitch for the appliance.
- Burners may be installed on the appliance or shipped in a separate carton.
- Burner nozzles may be installed in the burner, bagged or tied onto the burner chassis, or located in the appliance packaging.
- Head positioning bars may be installed or bagged to the burner chassis. Up to seven bars may be supplied. Use the bar with a range that includes the nozzle size used.

Elite burners with the “-HP” suffix are only supplied through the heating appliance manufacturer (OEM) market. These burners differ from standard models as follows:

- Fuel unit pressure is factory-set between 130 and 150 PSIG. Check heating appliance manufacturer's specifications for the correct pressure setting.
- The air band scale is calibrated for the fuel unit pressure. Set the air band to match the nozzle size installed. See page 11 in this manual for further information.

Installing OEM burners

- Burner flanges are welded to the air tube to ensure the correct pitch. Do not attempt to adjust the pitch using the air tube locking screws.
- Burners shipped installed on the heating appliance are supplied with four extra shipping screws in the air tube. These screws do not need to be removed, and can remain in the air tube for the life of the burner.

Oil nozzle selection – OEM burners

- Use only the nozzle specified in the heating appliance manufacturer's manual or burner supplement.

1. EZ-1/2/3 application information *(continued)*

Table 1 Apply the guidelines below to select a nozzle when appliance-specific nozzle data is not available from the manufacturer (see notes at end of table for application tips). DO NOT apply for EZ-1-HP, EZ-2-HP or EZ-3-HP models — see information supplied with appliance/burner.

EZ-1 Burner nozzle selections														
Brand	Spray	Angle & pattern	Head positioning bars (GPH)											Flame length needed
			0.50	.60 to .65		0.75	0.85 to 1.00		1.10 to 1.25		1.35 to 1.50		1.65	
			Nozzle rating, GPH											
			0.50	0.60	0.65	0.75	0.85	1.00	1.10	1.25	1.35	1.50	1.65	
Delavan	Hollow	600A				•	•	•	•					Medium
	Hollow	700A	•	•	•	•	•	•						Short
	Semi-solid	600SS	•	•	•	•	•							Short
	Solid	600B						•	•	•	•	•	•	Very long
	Solid	700B							•	•	•	•	•	Long
Hago	Hollow	600H	•	•	•	•	•	•						Short
	Hollow	700H	•	•	•	•	•							Short
	Semi-solid	600SS	•	•	•	•	•	•	•	•	•	•		Short
	Solid	600ES	•	•	•	•	•	•	•	•	•	•	•	Medium
	Solid	700ES	•	•	•	•	•	•						Medium
	Solid	600B							•	•	•	•	•	Long
	Solid	700B							•	•	•	•	•	Long
Monarch	Hollow	600NS	•		•	•	•	•	•					Short
	Hollow	700NS	•	•	•									Short
	Semi-solid	600AR			•	•	•	•	•	•	•			Medium
	Semi-solid	700AR				•	•							Short
	Solid	600R			•	•	•	•	•	•	•	•	•	Medium
	Solid	700R		•	•	•	•							Medium
Danfoss	Hollow	600AH	•	•	•	•	•	•	•					Short
	Semi-solid	600AB				•	•	•	•	•	•	•	•	Medium
	Solid	600AS		•	•	•	•	•	•	•	•	•	•	Medium

EZ-2 Burner nozzle selections								
Brand	Spray	Angle & pattern	Head positioning bars (GPH)				Flame length needed	
			1.50	1.65 to 1.75		2.00		2.25
			Nozzle rating, GPH					
			1.50	1.65	1.75	2.00	2.25	
Delavan	Hollow	600A	•	•	•	•	•	
	Solid	600B	•	•	•	•	•	
	Semi-solid	600SS	•	•	•	•	•	
Hago	Semi-solid	600SS	•	•	•	•	•	
	Solid	600B	•	•	•	•		
	Solid	600ES	•	•	•			
	Solid	600P				•	•	
Monarch	Solid	600R	•	•	•	•	•	
	Semi-solid	600AR	•	•	•	•	•	
	Hollow	600AS	•	•	•			
Danfoss	Hollow	600AH	•	•	•	•	•	
	Semi-solid	600AB	•	•	•	•	•	
	Solid	600AS	•	•	•	•	•	

EZ-3 Burner nozzle selections						
Brand	Spray	Angle & pattern	Head positioning bars (GPH)			Flame length needed
			2.00	2.25	2.50	
			Nozzle rating, GPH			
			2.00	2.25	2.50	
Delavan	Hollow	600A	•	•	•	Medium
	Solid	600B	•	•	•	Long
	Semi-solid	600SS	•	•	•	Medium
Hago	Semi-solid	600SS	•	•	•	Medium
	Solid	600P	•	•	•	Long
	Solid	600B	•			Long
Monarch	Solid	600R	•	•	•	Medium
	Semi-solid	600AR	•	•	•	Medium
Danfoss			•	•	•	Medium
	Hollow	600AH	•	•	•	Short
	Semi-solid	600AB	•	•	•	Medium
	Solid	600AS	•	•	•	Long

- In general, all the nozzles shown above will burn well. However, in short combustion chambers, solid nozzles are not recommended because the flame may impinge on the back wall.
- If the nozzle selected for a retrofit application results in a smoky fire, you can sometimes determine the best nozzle to use by observing the flame. To do this, slowly cover the air band slots with your fingers while the burner is firing. The flame will begin to smoke in the area where there is more fuel than air. If the smoke begins on the outer edges, try a narrower or more solid nozzle spray pattern. If the flame begins to smoke at the tips, try a wider or more hollow nozzle spray pattern.
- For a packaged appliance application on which the burner has been tested, use the nozzle given in the appliance manufacturer's instructions or supplement for the best results.

2. Prepare site • assemble burner • mount burner

Inspect/repair/replace vent system

WARNING Do not install this burner unless you have verified the entire vent system and the appliance are in good condition and comply with all applicable codes. And ...
 The vent and chimney must be sized and constructed in accordance with all applicable codes.
 Do not install or use an existing manual damper in the breeching (vent connector) or chimney.
 Do not connect the appliance vent connector to a chimney or vent serving a fireplace, incinerator or solid-fuel-burning apparatus.
 In a cold climate, do not vent into a masonry chimney that has one or more sides exposed to the outside. Install a listed stainless steel liner to vent the flue products.
 A defective vent system could result in severe personal injury, death or substantial property damage.

Prepare vent/chimney

- Secure all metal vent joints with screws, following the vent manufacturer's instructions. Seal all joints in the vent system and chimney. Repair masonry chimney lining and repair all mortar joints as needed.
- Install a double-acting barometric draft regulator in the vent piping if specified in the appliance manual. (The damper must be located in the same space as the appliance.)
- Provide support for the vent piping. Do not rest the weight of any of the vent piping on the appliance flue outlet.

Combustion/ventilation air openings

WARNING *Even if combustion air is piped to an (optional) burner air intake adapter*, the boiler room must still have the minimum air openings listed in Table 2 and described in the following paragraphs. This is to provide needed ventilation to keep the burner and appliance cool and to avoid the boiler room developing negative pressure.

The combustion air openings **MUST** be sized based on the total input of **all appliances in the room**.

Check appliance manual and applicable codes for required sizing/design/ placement of combustion/ventilation air openings. You can use the following general guidelines, taken from NFPA 31, provided they meet all local requirements.

Louvers/screens

- Air opening sizes are always given in free area. This means after deduction for louver obstruction. If you can't find the louver reduction for the grilles used, assume free area is 20% of total for wood louvers, or 60% of total for metal louvers.
- Screens can be no finer than ¼-inch mesh, and must be accessible for cleaning.

Residential installations

Unconfined spaces (at least 7,000 cubic feet per GPH)

- An unconfined space means a room with at least 7,000 cubic feet volume for each GPH input (or 50 cubic feet per MBH) of **all appliances in the room**. Example: For each 1 GPH oil input, the room must have 7,000 cubic feet (875 square feet with an 8-foot ceiling height.)

- Open basements and crawl spaces are usually large enough, and will generally allow enough air infiltration so special provisions will seldom be required.
- If the building is tightly constructed, you will have to provide outside air openings into the building. The total free area of the openings must be at least 1 square inch per 5,000 Btuh (28 square inches per GPH) of all appliances in the space.
- See Table 2 for summary.

Air openings to confined spaces (less than 7,000 cubic feet per GPH)

- Air taken from inside building only —
- Provide two openings — one near floor, the other near ceiling. Provide free area of 140 square inches per GPH input. If building is tightly constructed, provide air opening(s) into building providing 30 square inches per GPH as well.
- Air taken from outside —
 - Direct through outside wall or vertical ducts: Provide two openings — one near floor, the other near ceiling. Provide free area of 35 square inches per GPH input.
 - Through horizontal ducts: Provide two openings — one near floor, the other near ceiling. Provide free area of 70 square inches per GPH input.
- Ventilation air from inside/combustion air from outside
 Size openings to interior to provide 140 square inches free area per GPH input.
 Size outside air duct to provide 28 square inches free area per GPH.
- See Table 2 for summary.

Table 2 Minimum combustion/ventilation air openings

Source of air	Minimum free area of opening(s)	Total grill area, typical (sq. in.) for firing rates of:					
		1 GPH		2 GPH		3 GPH	
		Wood	Metai	Wood	Metai	Wood	Metai
Residential installations, unconfined spaces (7,000 cu. ft. volume per GPH)							
From inside building, typical construction	No special openings required if natural infiltration is sufficient.						
From inside building, tight construction	1 or more grilles 30 Sq. in./ GPH	150	50	300	100	450	150
Residential installations, confined spaces							
From inside building through interior walls	2 openings, each 140 Sq. in./ GPH	700	234	1400	467	2100	700
From outside building direct through outside wall	2 openings, each 35 Sq. In./ GPH	175	59	350	117	525	175
From outside building through vertical ducts	2 openings, each 35 Sq. In./ GPH	175	59	350	117	525	175
From outside building through horizontal ducts	2 openings, each 70 Sq. In./ GPH	350	117	700	234	1050	350
Ventilation through interior walls, with an opening to outside	2 Int. openings, each 140 Sq. In./ GPH	700	234	1400	467	2100	700
	1 Exterior opening 28 Sq. In./ GPH	140	47	280	94	420	140
Commercial installations							
From outside building direct through adjacent outside wall	One opening through outside wall, providing free area of at least 28 Square inches per GPH input						
Other conditions	Size openings per local codes/jurisdictions						

2. Prepare site • assemble burner • mount burner *(continued)*

Combustion/ventilation air checklist

WARNING

The burner may operate successfully under momentary downdraft conditions, but sustained downdraft is unsafe. This can occur with an inadequate or incorrectly installed chimney/vent. It can also occur in rooms/buildings equipped with exhaust fans or unsealed return air ducts.

Always check operation of the burner under all conditions to verify vent system operates correctly.

Combustion/ventilation air openings:

Always provide combustion/ventilation air to the appliance room sufficient to prevent any negative pressure in the space — if necessary, install new or additional air openings. See instructions in this manual.

Piped combustion air applications:

Burners with piped combustion air require the Field CAS-1 combustion air system. This includes a vacuum relief valve that will cause combustion air to be taken from the room if the combustion air piping becomes blocked or if any condition causes a vacuum in the air piping. The equipment room must have adequate air openings to provide combustion air should this occur. See instructions in this manual for combustion air openings.

Failure to correct downdraft or negative room pressure operation could result in severe personal injury, death or substantial property damage.

- Verify that openings are unobstructed.
- Verify that appliance space and air source spaces are free of:
 - Gasoline or other flammable liquids or vapors.
 - Combustible materials.
 - Air contaminants and chemicals, such as laundry products, paint, thinner, varnish, etc.
- Confirm with the building owner that the area will be kept free of these materials at all times and that air openings will be kept unobstructed.

Optional air intake systems

- Combustion air can be piped to the burner from outside if the burner is fitted with either a Burner Cover or P/N 97406 Air Intake System.
- You must use a Field Controls Model CAS-1 Combustion Air Supply Duct Kit or equivalent, and install as per kit manufacturer's instructions and any associated instructions in the Burner Cover or 97406 Air Intake System instructions.

WARNING

Even if using an (optional) air intake system, make sure the space provides enough ventilation to prevent overheating of the appliance, burner and controls. The equipment room must have combustion air/ventilation openings sized large enough to provide air for cooling the equipment and for combustion when needed. Failure to comply can result in severe personal injury, death or substantial property damage.

Air piping

WARNING

Follow all manufacturers' instructions carefully when installing the air intake duct assembly. Failure to carefully follow all instructions can result in hazardous operating conditions.

1. Install the optional air inlet adapter if the burner is fitted with a Burner Cover.

NOTICE

Air piping must be 4-inch diameter metal or PVC. Install a 4x3 reducer at the air adapter (if using a burner cover).

2. Connect air piping to the Field Controls Model CAS-1 Combustion Air Supply Duct Kit and install as per Field Controls' instructions.)

Maximum air piping length

1. USE ONLY 4-inch air piping.
2. **DO NOT exceed 80 equivalent feet of air piping. NOTE:** Install **vent piping** as specified in appliance manufacturer's instructions.
3. Reduce maximum length by 10 equivalent feet for each elbow in the air piping.
4. Example: The air piping could consist of (3) elbows (equals 30 equivalent feet) and 50 feet of straight piping; or (4) elbows (equals 40 equivalent feet) and 40 feet of straight piping.

Burner adjustments with optional Burner Cover

1. Follow the instructions in this manual for final adjustments to the burner using combustion test instruments.
2. Once combustion is initially set, re-install the cover and test again. If necessary, remove the cover and readjust the burner. Repeat the process until combustion is correct with the cover in place.
3. You must also measure air inlet temperature during start-up to properly set combustion. Follow the instructions in this manual.

Burner adjustments with optional Air Intake System

1. Follow the instructions in this manual and in the Air Intake System instructions for adjustments to the burner using combustion test instruments.
2. You must also measure air inlet temperature during start-up to properly set combustion. Follow the instructions in this manual.

2. Prepare site • assemble burner • mount burner *(continued)*

Verify clearances

Verify that the burner/appliance will maintain all clearances from combustible construction and clearances for service/maintenance as required in the appliance manual and applicable codes.

Verify that the vent system components maintain all necessary clearances to combustible construction, including the correct design of thimbles and insulation where penetrating combustible walls.

Verify combustion chamber

General guidelines

- If retrofitting the burner to an appliance, install the burner in accordance with the appliance instruction manual, when available. If no specific application data is available from the appliance manufacturer, apply the guidelines in Table 3 to check whether the burner is likely to work acceptably in the application.
- Clean all appliance flues and heating surfaces thoroughly, removing all soot and scale.

Seal all joints and gaps using furnace cement to prevent excess air infiltration.

Minimum combustion chamber dimensions

- Illustrations A to C in Table 3 show different chamber configurations.

- Do not attempt to fire the burner in a chamber with dimensions smaller than shown in Table 3 unless the application has been specifically tested and listed by the appliance manufacturer and/or Carlin.
- Please notice the special requirements given in Table 3 notes.

Using chamber linings and lightweight chambers

- When using refractory liners or lightweight chambers, use insulating-type refractory rated 2300°F minimum.
- You must install a target wall liner if flame length is close to the length of the chamber.
- Use a floor liner when possible. The floor liner will improve firing in most applications. Extend floor liner 3 to 4 inches up side wall.
- Target wall liners — Corbel the top of target wall liners 1½ to 2½ inches deep and extend at least 3 to 4 inches above the center of the flame.
- Use pre-formed chamber liners when available.
- For firing rates below 0.75 GPH, it is best to apply in a refractory-lined or stainless tube (designed for application) chamber. Lining the floor and target wall of the chamber with lightweight insulating refractory will accomplish the same.
- When conversion firing coal-fired units, install a combustion chamber in the ashpit area, or fill ashpit with sand up to 2 inches above the “mud ring” of a boiler (firing through the door). Install a lightweight refractory liner on the target wall as in Table 3, Figure C. Make sure the minimum dimensions comply with those listed.

Table 3 Burner retrofit applications — guidelines and minimum dimensions for combustion chambers

1 Firing rate GPH	2 L Inches	3 W Inches (3)	4 C Inches	5 H Inches	6 DV Inches (5)
0.50	7	6	3	8	7
0.65	7.5	7	3.5	9	7.5
0.75	8	7	3.5	9	8
0.85	9	7	3.5	9	8.5
1.00	10	8	4	10	9
1.10	11	8	4	10	9.5
1.25	12	8	4	10	10
1.35	13	8	4	10	11
1.50	14	8	4.5	11	12
1.65	15	9	4.5	11	13
1.75	16	9	4.5	11	14
2.00	17	9	4.5	11	15
2.25	18	10	5	12	16
2.50	19	10	5	12	17
Notes					
1	Some tested appliances operate well with dimensions other than above.				
2	Generally, the application should be acceptable for dimensions as large as 50% greater than the above.				
3	Horizontal cylinder chambers should have a diameter at least as large as the dimension in column 3. Horizontal steel cylinder chambers should have diameters at least 1 to 4 inches larger than the dimension in column 3.				
4	Wing walls are not recommended. Corbels can be beneficial to heat distribution in some appliances.				
5	DV is the minimum diameter for vertical cylinder chambers.				

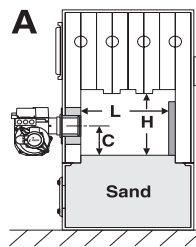

A. Conversion firing coal-fired units

1. Install a combustion chamber in the ashpit area, or fill ashpit with sand up to 2 inches above the “mud ring” of a boiler (firing through door).
2. When firing through door, install a lightweight refractory “target” on the rear wall, as shown.

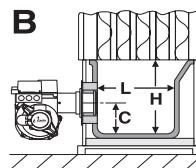

B. Conversion firing dry-base units

1. Applies to brick, refractory, precast and preformed refractory fiber chambers. Lightweight, insulating-type materials are preferred because of their quick warm-up. Use material rated at least 2300°F.
2. Dimensions in the table can be exceeded without much effect for dry-base units.

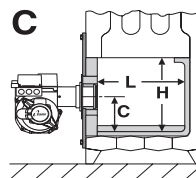

C. Conversion firing wet-based units

1. Apply recommendations here to prevent flame from impinging on surfaces or being cooled too much by the cool walls of the heat exchanger. Do not exceed dimensions of table more than 50% to avoid flame chilling.
2. Install a ceramic fiber floor liner (extended 3 to 4 inches up the side walls) and a ceramic fiber rear target the full width of the back wall as well. Corbel the top of the target 1½” to 2½” deep and extend at least 3 to 4 inches above the center of the flame. Use preformed chambers and/or target walls if available.
3. Set the fuel unit pressure for approximately 150 PSIG and use a nozzle rated about 20% less than the firing rate to compensate for the higher pressure. This will improve atomization, making the flame more intense, shorter and hotter. Use a head bar matched for the nozzle size, but set the air band to match the firing rate.

2. Prepare site • assemble burner • mount burner *(continued)*

Inspect burner and components

- Check the air tube length. Verify the usable length of the tube UTL will be long enough (see “Mount burner in appliance”).
- Visually inspect all burner components and wiring.
- Verify that wiring is intact and leads are securely connected.

- Verify that all burner components are in good condition.

WARNING

Do not install or operate the burner if any component is damaged or if burner does not comply with the specifications of Table 1, page 3, and other guidelines of this manual and the appliance manual.

Assemble burner (when required)

Welded-flange burners

1. Verify the bolt pattern on the appliance chamber matches the flange pattern.
2. Verify the insertion depth (UTL) matches the depth of the appliance opening (so the end of the air tube is flush with, or slightly short of, the inside surface of the combustion chamber).

4. Level the air tube using a spirit level.
5. Mark the air tube position with a pen or pencil around the circumference of the tube.
6. Remove air tube from the opening.

Universal (adjustable) flange burners

1. Verify the flange mounting slots line up with the appliance bolts. See Figure 1.
2. Slip the adjustable flange onto the air tube.
3. Measure the distance from the inside of the combustion chamber to the outside of the appliance mounting plate.
4. Position the universal flange at this distance from the end of the air tube.
5. Tighten the locking screws finger tight.
6. Insert the air tube/flange assembly into the appliance opening and level the air tube with a spirit level. Adjust flange if needed.
7. The end of the air tube should be flush, or almost flush, with the inside of the combustion chamber wall.
8. Verify the air tube is level and inserted the corrected depth. Adjust if necessary. Then tighten the flange locking screws securely.
9. Remove the flange/air tube assembly from the opening.

Figure 1 Universal flange mounting dimensions

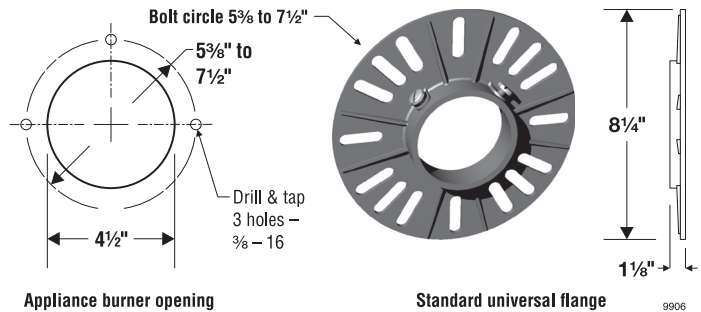

Pedestal-mounted burners

1. Check the diameter of the appliance opening. If larger than 4 1/2 inches, rebuild the opening so the open is reduced to 4 1/2 inches maximum.
2. Insert the air tube into the appliance opening as in Figure 2. Do not attach air tube to housing yet.
3. Slide the tube in until the end of the tube is flush with, or up to 1/4 inch short of, the inside of the combustion chamber.

Figure 2 Mark insertion depth on air tube when using universal flange mounting

When correctly positioned, the end of the air tube will be flush with, or just short of, the inside wall of the combustion chamber. Before tightening flange screws, level the air tube with a spirit level.

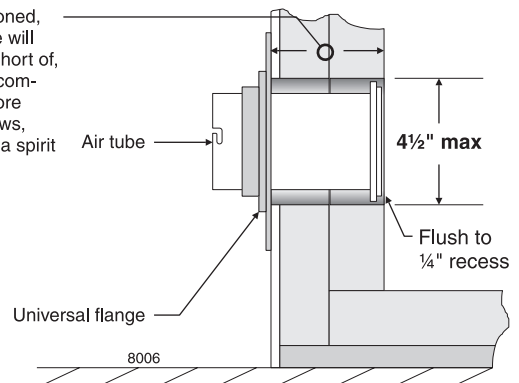

2. Prepare site • assemble burner • mount burner (continued)

Attach air tube to housing

1. The burner chassis is supplied with two screws mounted into the housing.
2. Loosen these screws about three turns.
3. Slide the air tube onto the housing, aligning the J-notches in the tube with the housing screws (Figure 3).
4. Turn the tube to engage the J-notches.
5. Insert the two mounting screws into the TOP TWO air tube holes.
6. Tighten the screws.

Figure 3 Attaching air tube to burner chassis

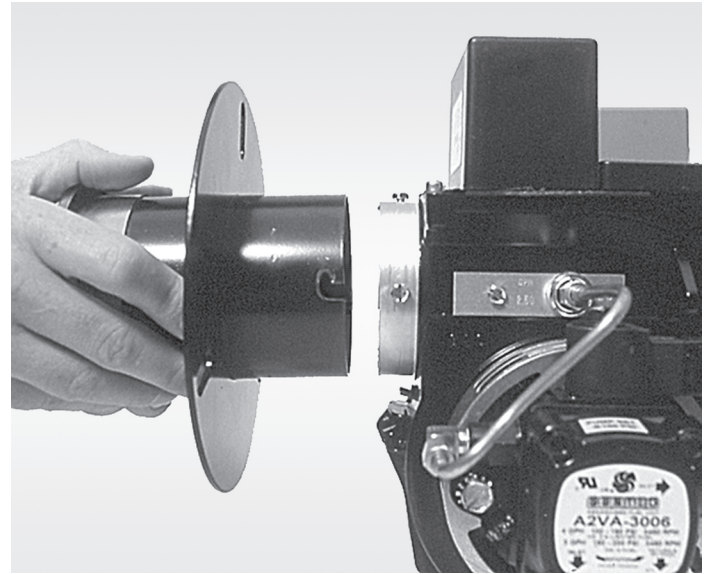

Mount burner in appliance

Welded flange-mounted burner

1. Place gasket over burner air tube and insert burner into appliance opening. Secure in place with hardware supplied with appliance.

WARNING Universal flange or pedestal mount — these insertion methods are intended only for negative overfire pressure. For pressurized firing, you must obtain a burner with a welded flange, designed for use with the specific appliance. Failure to comply could result in severe personal injury, death or substantial property damage.

Universal flange-mounted burner

1. Place gasket over burner air tube.
2. Insert burner into appliance.
3. Verify burner is seated level and straight. Adjust flange slightly if necessary.
4. Secure flange to appliance with hardware supplied with appliance.

Pedestal mounted burner

1. Adjust the pedestal legs so the air tube is level and the center of the tube is at the same height as the center of the appliance opening.
2. Tighten the pedestal leg jam nuts.

3. Insert the burner/air tube into the appliance opening until pen/pencil line is even with appliance front (so end of air tube is flush with, or slightly short of, the inside of the chamber).
4. Seal the space around the air tube with furnace cement or equivalent (Figure 4).

Figure 4 Seal opening around burner air tube when pedestal mounting (burner shown with tube attached to housing and installed)

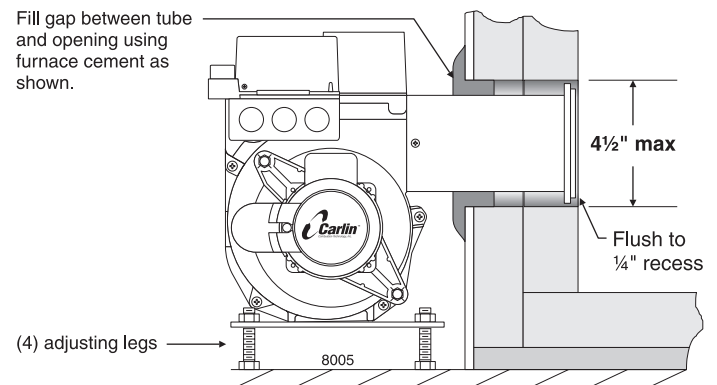

3. Prepare burner

Removing/installing head assembly

WARNING Use care when handling burner components after the burner has been firing. Components can be hot and could cause severe personal injury.

You will need to remove the combustion head assembly for inspection of the assembly, replacement of the oil nozzle or adjustment of electrodes.

To remove the assembly:

1. Loosen, and then rotate the two screw clamps securing the ignitor in place. Swing the ignitor plate open.
2. Disconnect the nozzle line heater harness.
3. Unscrew the oil line fitting and thumb nut at the burner housing.
4. Pull the threaded end of the oil tube into the blower housing (Figure 5).
5. Rotate the assembly 180° so the electrodes are upside down. This places the electrode insulators out of the way for easy removal.
6. Remove the combustion head assembly, as shown in Figure 6, by pulling the assembly up and out of the housing.
7. Handle the assembly with care to avoid bending/moving the electrodes, or damaging the electrode ceramic insulators.
8. Inspect the gasket on the bottom of the ignitor plate. The gasket prevents air from escaping from the housing. Replace the gasket if not in good condition.
9. Inspect the ignitor contact clips. Clean or replace if necessary to ensure reliable contact with the electrodes.

Figure 5 Inserting/removing combustion head assembly

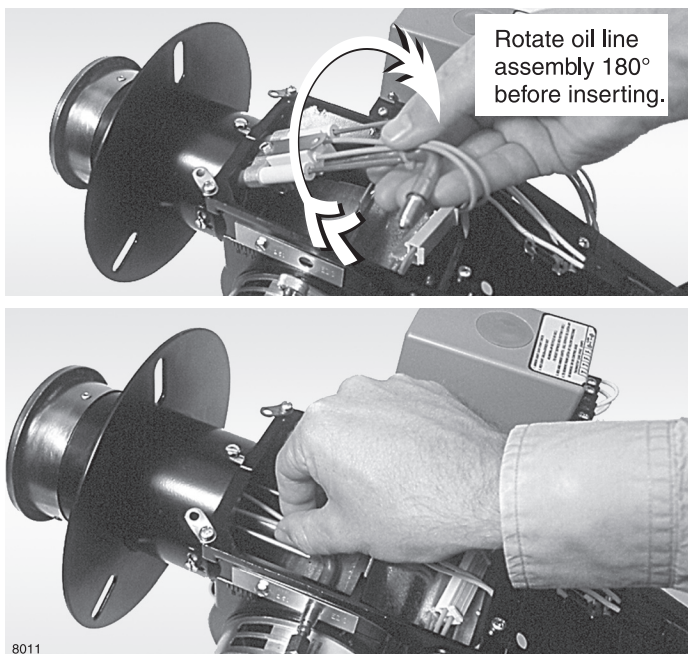

To replace the combustion head assembly, reverse the sequence above.

- Remember to put the assembly in upside down, so the electrode insulators are out of the way.
- See Figure 6. You will have to lift the end of the assembly to guide it through the reduced diameter throttle cone at the end of the air tube. **DO NOT FORCE.**

CAUTION Use care when tightening the oil line fitting to oil tube extension. Tighten securely, but do not cross-thread or over-tighten.

Figure 6 Inserting combustion head assembly

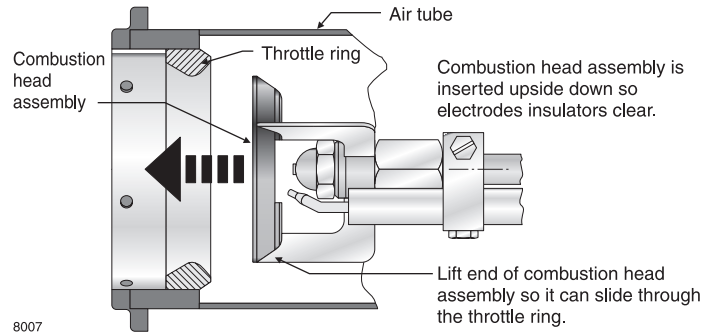

Install nozzle/check electrodes

1. Loosen the clamp screw on the retention ring assembly (see Figure 7). Slide the retention ring assembly off of the nozzle adapter.
2. Install and tighten the nozzle shown in Table 1, page 4, for retrofit applications. Install the nozzle given in the appliance manual when application information for the EZ-1/2/3 oil burner is given.
3. Hold the nozzle adapter securely when removing or replacing the nozzle (Figure 8). Take care not to damage the electrode insulators or to bend the electrodes in the process.

Figure 7 Electrode placement, retention ring assembly and nozzle adapter

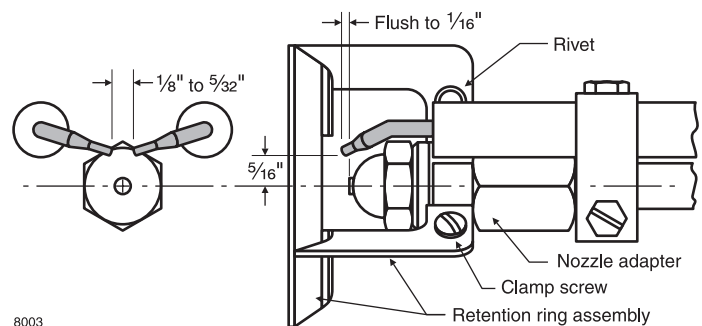

WARNING Inspect the nozzle adapter before replacing the nozzle. If the threads have been damaged or shows score marks, replace the nozzle line/adaptor assembly.

3. Prepare burner *(continued)*

- Replace the retention ring assembly by slipping one of the riveted arms through the gap between the electrode tips. Align this arm straight up, with the ring clamp firmly against the nozzle adapter shoulder. Then tighten the clamping screw.
- Check the electrode settings. Position the electrodes as shown in Figure 7. These settings are critical in ensuring a reliable ignition. Once the electrodes are set, check all clamps to be sure they are securely tightened.

Figure 8 Carefully support the nozzle adapter when removing or installing nozzle



Install head positioning bar

- The burner is supplied with up to seven calibrated bars that properly position the head in the air tube. See the table below for head positioning bars available.
- The head positioning bars are stamped with a nozzle size range. Use a positioning bar with the range that includes the nozzle size installed.
- See Figure 9. Remove the existing bar (if installed) and replace with the correct one.
- Store any remaining bars in the rear of the burner to allow future change, if needed.

Model	Range	Head positioning bars available
EZ-1 EZ-1-HP	0.50 – 1.65 GPH	7 options: 0.50 / 0.60-0.65 / 0.75 0.85-1.00 / 1.10-1.25 / 1.10-1.25 / 1.35-1.50 / 1.65
EZ-2 EZ-2-HP	1.50 – 2.25 GPH	4 options: 1.50 / 1.65-1.75 2.00 / 2.25
EZ-3 EZ-3-HP	2.00 – 2.50 GPH	3 options: 2.00 / 2.25 / 2.50

Adjust air band (initial setting)

- The burner pump pressure is factory set. The pump pressure is indicated on a label affixed to the pump only if it is something other than

100 psi. The air band divisions match the nozzle size regardless of the pump pressure setting. Loosen the lock screw and move the air band until the pointers line up with the setting indicated in the OEM Set-up Table or to a setting that matches the nozzle size (for a retrofit burner). See figure 10.

- NOTE:** For high altitude installations above 2,000 feet, increase the air supply setting 4% for each 1,000 feet above 2,000 feet above sea level.
- The burner is now adjusted to the approximate air band setting for the nozzle size indicated. When you check combustion with instruments during start-up or servicing, you may have to adjust the air band slightly to achieve the desired combustion readings. See “Adjust burner using test instruments,” page 22.

Figure 9 Installing head positioning bar

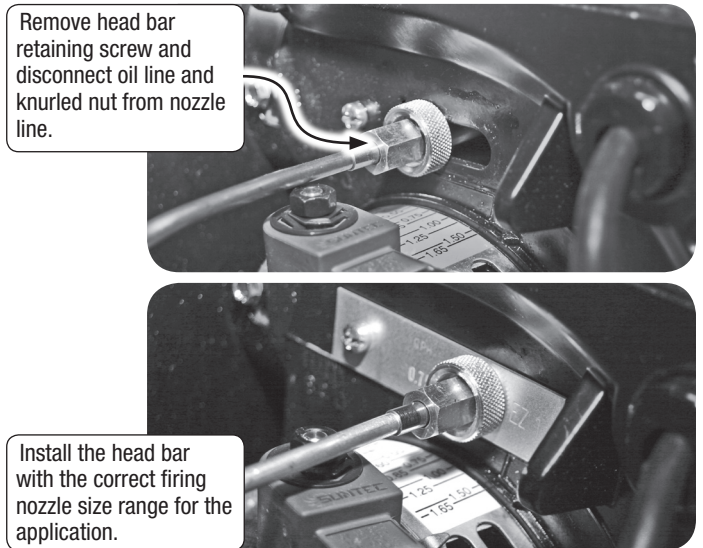
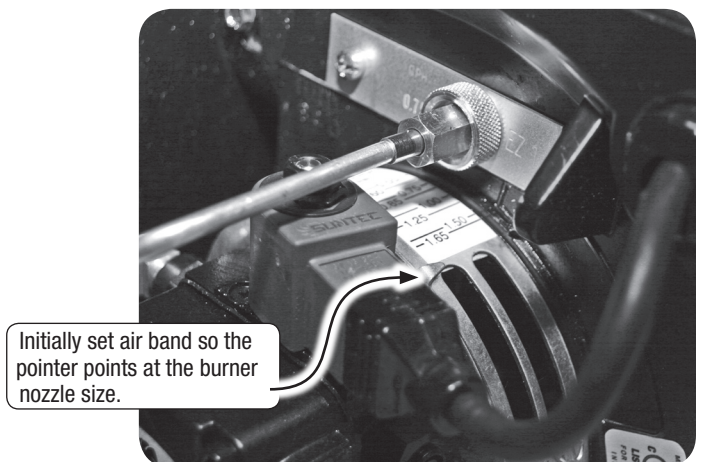

Figure 10 Initial setting of air band



3. Prepare burner *(continued)*

Inspect/install fuel supply

CAUTION Inspect the oil supply system. Ensure that the fuel lines are correctly sized and installed and that the fuel flow is unobstructed, the oil tank is clean and only # 1 or # 2 heating oil are supplied. Failure to supply a reliable oil flow could result in loss of heat and potential severe equipment damage.

General guidelines:

- When installing oil lines, use continuous runs of heavy-wall copper tubing if possible.
- Check fuel unit (oil pump) data sheet for recommended line sizing, lift limitations and maximum length.
- Check all connections and joints to ensure they are air-tight.
- Use flare fittings. Do NOT use compression fittings.
- Never use pipe sealing tape. Fragments can break off and plug fuel line components.
- Install a shut-off valve at the tank and one near the burner. (Use fusible handle design valves when possible or when required by codes.)
- Install a large capacity fuel filter (rated for 50 microns or less) near the burner.

Fuel unit bypass plug

WARNING The fuel unit is shipped ready for a one-line oil system (bypass plug is shipped loose). Install the bypass plug only if connecting to a two-line oil system. Operating with the plug in place on a one-line system will damage the fuel unit and could lead to oil leakage and fire hazard.

WARNING If the fuel line or fuel supply is above burner, never exceed 3 PSIG pressure at the fuel unit inlet. Install a suitable OSV to reduce the pressure. Operating the fuel unit with higher inlet pressure could result in fuel unit seal damage, oil leakage and potential fire hazard.

Nozzle line heater

- Oil burners often operate in spaces where temperatures tend to be cool, typically 60°F or lower. Cool oil has higher viscosity, which can affect atomization, ignition, combustion and fuel consumption. The nozzle line heater avoids this problem by heating the nozzle line oil to between 120°F and 130°F, resulting in smoother ignition and improved combustion.

- The nozzle line heater needs power when the burner is in standby (no call for heat from the appliance). Make sure the nozzle line heater is powered directly from the 120 VAC HOT line, not through the appliance operating control circuit. The nozzle line heater wiring should be shown on the wiring diagram supplied with the appliance/burner unit.
- The nozzle line heater is supplied with an electrical disconnect harness, allowing removal of the combustion head assembly without disconnecting wires. Position the heater harness disconnect in the rear of the blower housing, above the blower access cover. The wire leads to the disconnect route through the side of the housing into the junction box.

NOTICE When first starting the burner, or after the service switch has been off for some time, the heater requires about 15 minutes to bring the oil to operating temperature.

One-line fuel system requirements

See Figure 11. The standard burner fuel unit is a single-stage, 3450-RPM oil pump. Apply this fuel unit only on one-line systems where the fuel supply is on the same level with, or higher than, the burner. This ensures oil flow by gravity. Also make sure the total lift does not exceed 8 feet (height difference from bottom of oil tank to fuel unit). For other conditions, you must provide a two-line fuel system. You may also have to change the fuel unit to a two-stage type.

Figure 11 One-line fuel system

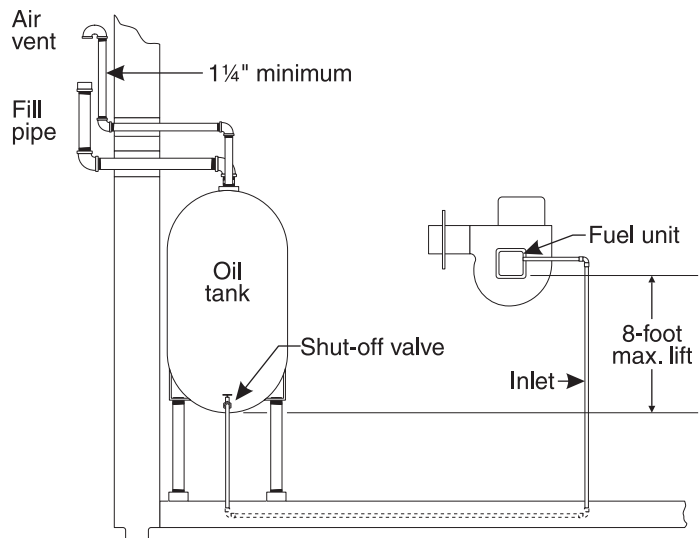

3. Prepare burner *(continued)*

Two-line fuel system requirements

See Figure 12 and Table 4. Use Table 4 only for burners equipped with Suntec fuel units. For burners using other fuel units, read the fuel unit manufacturer’s data sheet to determine maximum lengths and lifts.

The standard burner fuel unit is a single-stage, 3450-RPM oil pump. Use this fuel unit only on two-line oil systems that do not exceed the total tubing lengths allowed in Table 4 (for Suntec fuel units only). For longer systems (or where lift exceeds 10 feet), replace the one-stage fuel unit with a two-stage unit.

Always size fuel lines using an oil flow rate based on the fuel unit gearset capacity, not the burner firing rate. See fuel unit data sheet for information.

NOTICE Install the fuel unit bypass plug when connecting to a two-line system. The plug is shipped in a bag attached to the fuel unit, along with a fuel unit data sheet.

Table 4 Two-line fuel system maximum lengths for 3/8” and 1/2” OD copper tubing distribution. Use only for burners equipped with Suntec fuel units. See fuel unit data sheet for any other fuel unit.

Lift (feet)	Max. total length of tubing, feet (including both horizontal and vertical)			
	Single-stage fuel unit		Two-stage fuel unit	
	3/8” tubing	1/2” tubing	3/8” tubing	1/2” tubing
0	84	100	93	100
2	73	100	85	100
4	63	100	77	100
6	52	100	69	100
8	42	100	60	100
10	31	100	52	100
12	NOT recommended — use two-stage fuel unit		44	100
14			36	100
16			27	100
18			-	76

Figure 12 Two-line fuel system

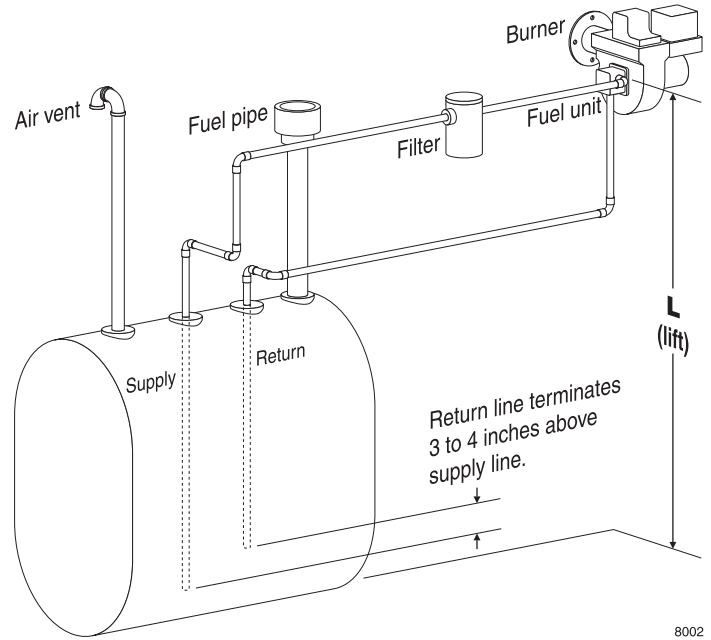

Perform checkout procedures

Verify before starting burner:

- WARNING** Should overheating or an emergency occur, immediately:
- Shut off oil supply line valve.
 - Under some circumstances power should remain on for water pumps or blowers. Determine proper response before attempting start-up.
 - If burner fails ignition on several attempts, use burner blower to purge appliance chamber before restart.

Checklist

- Burner/appliance installed per appliance instruction manual?
- Burner nozzle and head positioning bar verified against Table 1, page 4, or appliance manufacturer’s instructions?
- Burner/appliance installed per all applicable codes?
- Installation site has adequate combustion/ventilation air openings and vent system?
- Fuel supply line in good condition and sized/designed correctly?
- Oil tank has oil and oil line valves are open.
- Wiring installed per burner/appliance instructions?
- Burner, appliance and all components inspected and in good condition?

4. Wire burner • start burner – 48245 primary control

WARNING Turn off power to appliance when servicing burner. Failure to comply could result in severe personal injury, death or substantial property damage.

Wire burner – 48245 primary control

- All wiring must comply with:
 - In the U.S — the National Electrical Code, ANSI Z223.1/NFPA 54.
 - In Canada — the Canadian Electrical Code Part 1, CSA standard C22.1.
 - All applicable local codes/standards.
- Wire the burner following Figure 13 and any special instructions or wiring diagram provided with the appliance, burner or other components.
- The burner requires a 120 VAC/60 HZ/single-phase power supply, with at least a 5-AMP fuse. The current draw (equipped with Carlin PSC motor) will be approximately 2.5 AMPS.
- The 48245 thermostat terminals provide a power source. Never apply external power to these terminals under any circumstances. To avoid this problem when using zone valves, disconnect field wires from 48245 thermostat terminals. Then connect a voltmeter across wires. Operate all zones and verify that there is never a voltage reading at the meter. A voltage reading indicates incorrect wiring that must be corrected before attempting to operate the burner.
- Make sure the burner and appliance are correctly wired and the line switch is properly fused for the load.

To start burner

WARNING Do not start the burner if the combustion chamber contains oil or oil vapor.

- Turn service switch OFF.
- Perform inspections and checkouts on pages 14 and 15.
- Slip one end of a 3/16-inch I.D. clear plastic hose over end of bleed valve, the other end into a container. Then open bleed valve.
- Set thermostat (operating controls) to call for heat.
- Turn service switch ON.
- Bleed oil line until plastic line is free of bubbles; then another 15 seconds longer. (Should the primary control timing cause a lockout during purging, restart the burner following the primary control data sheet instructions.)
- Close bleed valve. The burner should cycle through the sequence given in the primary control data sheet.
- Perform primary control flame failure lockout and safety timing tests per instructions in primary control data sheet.
- Should control/burner fail to operate correctly, see page 15 for suggestions in troubleshooting.

Figure 13 Burners up to 3.0 GPH only, wiring using Carlin 48245 primary control (see appliance manual or separate wiring information for burner equipped with a primary control not covered in this manual)

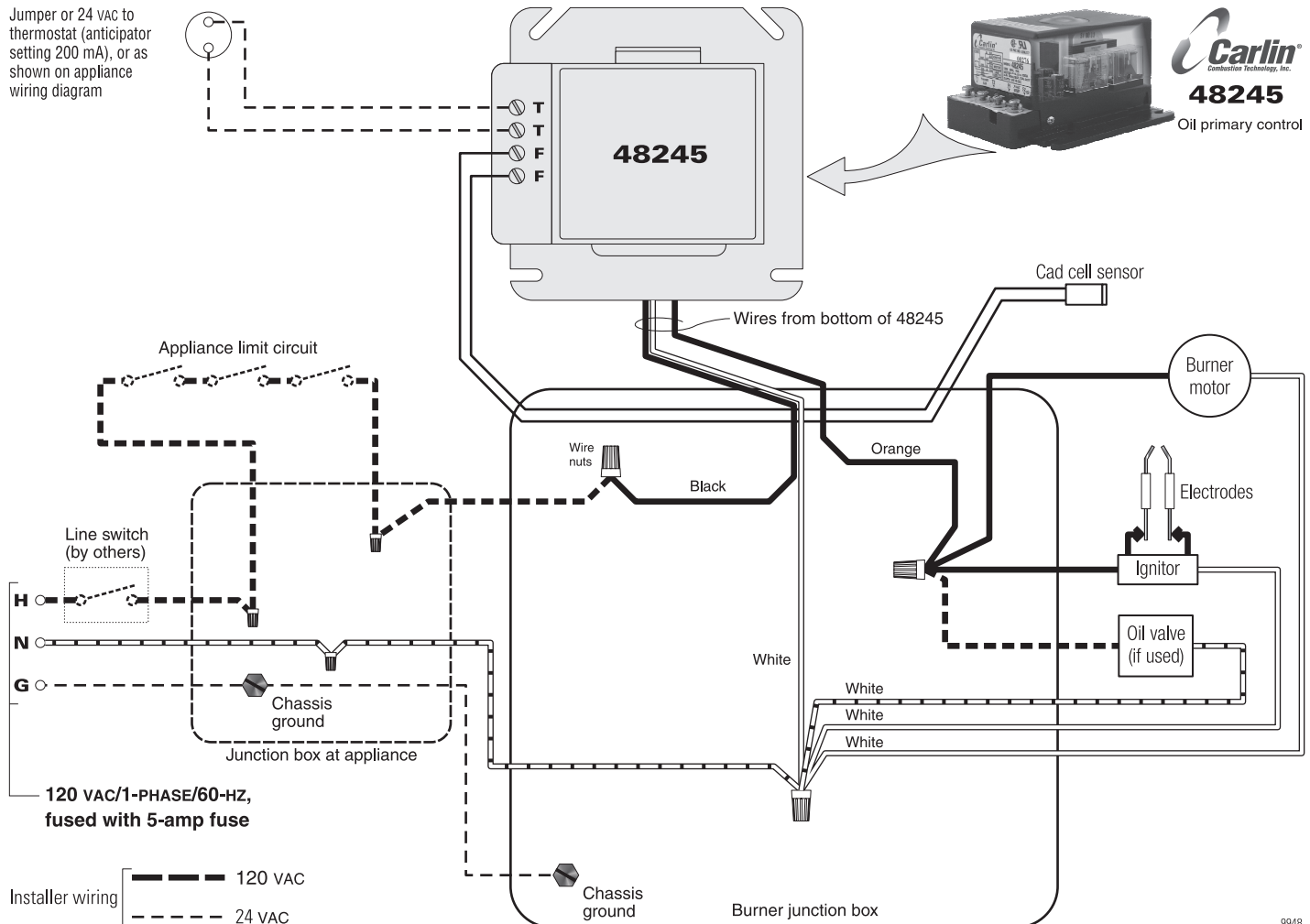

Start-up & operation

WARNING	Do not start the burner if the combustion chamber contains oil or oil vapor.
NOTICE	Per UL requirements, the control will not turn on if the cad cell senses flame during the self-test. If the cad cell sees light (flame) at the beginning of a cycle, the control will wait until it no longer senses the problem.
Power ON	Open all manual oil line valves. Close the line switch.
Reset	Press and hold the reset button for 3 seconds, then release. This will reset the control at any time during its operation.
Stand-by	(No call for heat) Control waits for power to be applied to the black wire (from appliance limit circuit). The circuit across terminals T-T will also have to close for burner to start.
Call for heat	Set thermostat (or aquastat) to call for heat. The limit circuit must provide power to the black wire and the circuit between terminals T-T must be closed.
Burner on	The <i>ignitor</i> and <i>motor</i> start. (The ignitor remains on throughout the call for heat cycle.)
TFI	The cad cell must sense flame within the control's trial for ignition (TFI) timing — 45 seconds.
Run	The burner continues firing during call for heat if the cad cell senses flame.
Lockout	If cad cell does not sense flame within the TFI timing (45 seconds), lockout occurs. The red LED indicator turns on.
WARNING	Red LED fully on indicates lockout (approximately 20 seconds after motor and ignitor turn off). If power is interrupted to the control before the Red LED turns fully on, the control will reset without the reset button being pushed.
To Reset	To reset after lockout, push in and hold reset button for 3 seconds, then release. This will reset control at any time during operation.
Flame failure	If the cad cell loses flame signal during operation (after the TFI), control will lockout if flame is not established within 45 seconds.
Burner off	Set thermostat (or aquastat) to stop call for heat. The burner shuts off within 2 seconds after end of call for heat.
Stand-by	Control remains in stand-by mode until limit circuit sends power to the black wire and T-T circuit closes (call for heat).
Power loss	If power to control/burner is interrupted during a normal run cycle, the control will begin a normal cycle again after power is restored.

Service & Troubleshooting

Burner (control) will not come on

No power to control

- Check line voltage to the control (at least 102 vac).
- Check all electrical connections.

Control is in lockout (red LED on)

- Press the reset button for 3 seconds.

CAD cell seeing light

- Remove one lead from FF terminal on the control. Press and hold the reset button for 3 seconds. If voltmeter shows power between control white and black wires, and T-T circuit is closed, but control does not start, replace the control. If control does not start when receiving power on the black wire and T-T circuit is closed, check for:

- light is leaking into the burner housing, *OR*
- CAD cell is defective, *OR*
- there is a problem with the CAD cell wiring or holder.
- If appliance was recently shut down, CAD cell may see residual hot spots in chamber.

To troubleshoot:

- **Check CAD cell** by unplugging it and measuring the resistance across its pins: dark resistance at least 50 KOHMS; room light resistance less than 10 KOHMS. Replace if necessary. If the CAD cell functions properly, reinstall the cell and close the burner housing.
- **Check for stray light** by measuring the CAD cell resistance looking into the inactive combustion chamber. It should read at least 50 KOHMS.

Control will not reset

- If the control will not reset, the Safety Monitoring Circuit may be detecting an internal control problem. Replace the control.

Repeated flame failures (burner lights, but shuts down)

Check for:

- CAD cell is defective.
- Air leaking into oil line causing flame out — Check oil line connections and filter gasket.
- Defective nozzle causing flame to be erratic — Change nozzle.

Check for proper air band setting and draft.

- Excessive back pressure causing flame to be erratic — Check appliance and flue for sooting/plugging.

Control locks out after TFI

Check for:

- No oil to burner — Check oil supply, filter, lines.
- Shorted electrodes — Inspect for cracked porcelain and replace as needed.
- Poor spark — Check electrode spacing and condition per burner manual. Replace or realign if necessary.
- Nozzle clogged — Replace nozzle.
- Airflow too high — Check air band setting.
- Ignitor module defective — Replace if no spark.
- CAD cell defective.
- Oil valve (if used) stuck in closed position.
- Check wiring connections.

4. Wire burner • start burner – 40200 or 42230 primary control

WARNING Turn off power to appliance when servicing burner. Failure to comply could result in severe personal injury, death or substantial property damage.

Wire burner – 40200 primary control 42230 primary control

- All wiring must comply with:
 - In the U.S — the National Electrical Code, ANSI Z223.1/NFPA 54.
 - In Canada — the Canadian Electrical Code Part 1, CSA standard C22.1.
 - All applicable local codes/standards.
- Wire the burner following Figure 14 and any special instructions or wiring diagram provided with the appliance, burner or other components.
- The burner requires a 120 v_{ac}/60 Hz/single-phase power supply, with at least a 5-AMP fuse. The current draw (equipped with Carlin PSC motor) will be approximately 2.5 AMPS.
- The 40200 or 42230 thermostat terminals provide a power source. Never apply external power to these terminals under any circumstances. To avoid this problem when using zone valves, disconnect field wires from 40200 or 42230 thermostat terminals. Then connect a voltmeter across wires. Operate all zones and verify that there is never a voltage reading at the meter. A voltage reading indicates incorrect wiring that must be corrected before attempting to operate the burner.
- Make sure the burner and appliance are correctly wired and the line switch is properly fused for the load.

To start burner

WARNING Do not start the burner if the combustion chamber contains oil or oil vapor.

- Turn service switch OFF.
- Perform inspections and checkouts on pages 16 and 17.
- Slip one end of a 3/16-inch I.D. clear plastic hose over end of bleed valve, the other end into a container. Then open bleed valve.
- Set thermostat (operating controls) to call for heat.
- Turn service switch ON.
- Bleed oil line until plastic line is free of bubbles; then another 15 seconds longer. (Should the primary control timing cause a lockout during purging, restart the burner following the primary control data sheet instructions.)
- Close bleed valve. The burner should cycle through the sequence given in the primary control data sheet.
- Perform primary control flame failure lockout and safety timing tests per instructions in primary control data sheet.
- Should control/burner fail to operate correctly, see page 17 for suggestions in troubleshooting.

Figure 14 EZ-123 burners wiring using Carlin 40200 or 42230 primary control (see appliance manual or separate wiring information for burner equipped with a primary control not covered in this manual)

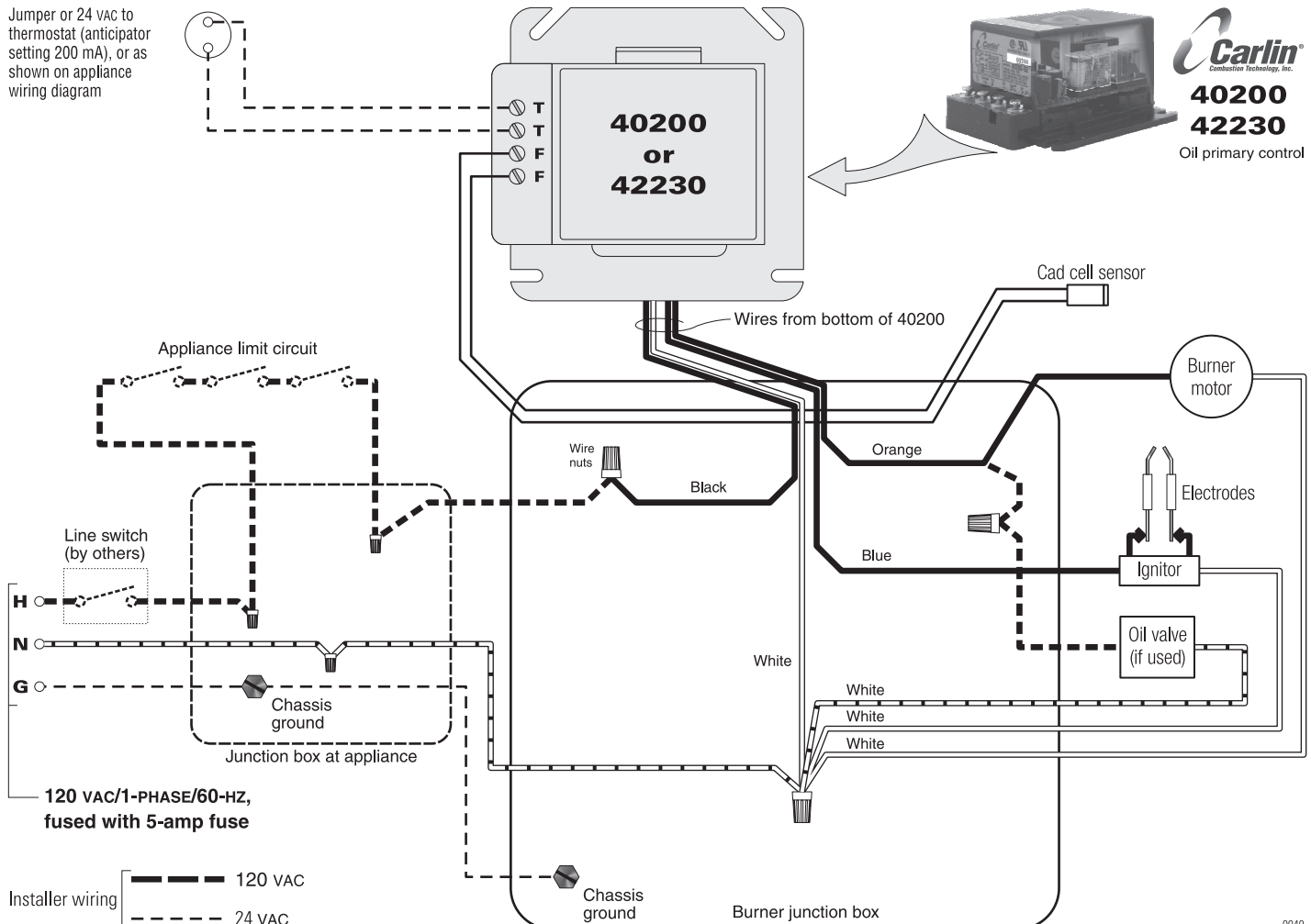

9940

Start-up & operation

WARNING	Do not start the burner if the combustion chamber contains oil or oil vapor.
NOTICE	Per UL requirements, the control will not turn on if the cad cell senses flame during the self-test. If the cad cell sees light (flame) at the beginning of a cycle, the control will wait until it no longer senses the problem.
Power ON	Open all manual oil line valves. Close the line switch.
Reset	Press and hold the reset button for 3 seconds, then release. This will reset the control at any time during its operation.
Stand-by	(No call for heat) Control waits for power to be applied to the black wire (from appliance limit circuit).
Call for heat	Set thermostat (or limit) to call for heat. Thermostat circuit must be closed and power coming to black wire from limit circuit.
Burner on	The <i>ignitor</i> and <i>motor</i> start.
TFI	The cad cell must sense flame within the control's trial for ignition (TFI) timing — 15 seconds for 40200 control or 30 seconds for 42230 control. After cad cell senses flame, the ignitor stays on another 10 seconds (flame stabilization period).
Run	The burner continues firing during call for heat if the cad cell is sensing flame.
Lockout	If cad cell does not sense flame within the TFI timing (15 or 30 seconds), lockout occurs.
To Reset	Push in and hold reset button for 3 seconds, then release. This will reset control at any time during operation.
Flame failure	If the cad cell loses flame signal during operation (after the TFI), the burner shuts off within 1.3 seconds. Recycle: After 60 to 90 seconds the control will restart (Burner on mode).
Burner off	Set thermostat (or aquastat) to stop call for heat. The burner shuts off within 2 seconds after end of call for heat.
Stand-by	Control remains in stand-by mode until limit circuit sends power to the black wire and T-T circuit closes (call for heat).
Power loss	If power to control/burner is interrupted during a normal run cycle, the control will begin a normal cycle again after power is restored.

Service & Troubleshooting

Burner (control) will not come on

No power to control

- Check line voltage to the control (at least 102 VAC).
- Check all electrical connections.

Control is in lockout

- Press the reset button for 3 seconds.

CAD cell seeing light

- Remove one lead from FF terminal on the control. Press and hold the reset button for 3 seconds. If voltmeter shows power between control white and black wires, and T-T circuit is closed, but control does not start, replace the control.

If control starts when receiving power on the black wire and T-T circuit is closed, check for:

- light is leaking into the burner housing, *OR*
- CAD cell is defective, *OR*
- there is a problem with the CAD cell wiring or holder.
- If appliance was recently shut down, CAD cell may see residual hot spots in chamber.

To troubleshoot:

- **Check CAD cell** by unplugging it and measuring the resistance across its pins: dark resistance at least 50 KOHMS; room light resistance less than 10 KOHMS. Replace if necessary. If the CAD cell functions properly, reinstall the cell and close the burner housing.
- **Check for stray light** by measuring the CAD cell resistance looking into the inactive combustion chamber. It should read at least 50 KOHMS.

Control will not reset

- If the control will not reset, the Safety Monitoring Circuit may be detecting an internal control problem. Replace the control.

Repeated flame failures (burner lights, but shuts down)

Check for:

- CAD cell is defective.
- Air leaking into oil line causing flame out — Check oil line connections and filter gasket.
- Defective nozzle causing flame to be erratic — Change nozzle.
- Excessive airflow or draft causing flame to leave burner head

Check for proper air band setting and draft.

- Excessive back pressure causing flame to be erratic — Check appliance and flue for sooting/plugging.

Control locks out after TFI

Check for:

- No oil to burner — Check oil supply, filter, lines.
- Shorted electrodes — Inspect for cracked porcelain and replace as needed.
- Poor spark — Check electrode spacing and condition per burner manual. Replace or realign if necessary.
- Nozzle clogged — Replace nozzle.
- Airflow too high — Check air band setting.
- Ignitor module defective — Replace if no spark.
- CAD cell defective.
- Oil valve (if used) stuck in closed position.
- Check wiring connections.

4. Wire burner • start burner – 50200 primary control

WARNING Turn off power to appliance when servicing burner. Failure to comply could result in severe personal injury, death or substantial property damage.

Wire burner – 50200 primary control

- All wiring must comply with:
 - In the U.S — the National Electrical Code, ANSI Z223.1/NFPA 54.
 - In Canada — the Canadian Electrical Code Part 1, CSA standard C22.1.
 - All applicable local codes/standards.
- Wire the burner following Figure 15 and any special instructions or wiring diagram provided with the appliance, burner or other components.
- The burner requires a 120 VAC/60 HZ/single-phase power supply, with at least a 5-AMP fuse. The current draw (equipped with Carlin PSC motor) will be approximately 2.5 AMPS.
- The 50200 thermostat terminals provide a power source. Never apply external power to these terminals under any circumstances. To avoid this problem when using zone valves, disconnect field wires from 50200 thermostat terminals. Then connect a voltmeter across terminals. Operate all zones and verify that there is never a voltage reading at the meter. A voltage reading indicates incorrect wiring that must be corrected before attempting to operate the burner.
- Alarm terminals provide a 24 VAC-rated dry contact, suitable for use with security/fire alarm systems such as Carlin SecureHeat™.
- Make sure the burner and appliance are correctly wired and the line switch is properly fused for the load.

To start burner

WARNING Do not start the burner if the combustion chamber contains oil or oil vapor.

- Turn service switch OFF.
- Perform inspections and checkouts on pages 18 and 19.
- Slip one end of a 3/16-inch I.D. clear plastic hose over end of bleed valve, the other end into a container. Then open bleed valve.
- Set thermostat (operating controls) to call for heat.
- Turn service switch ON.
- Bleed oil line until plastic line is free of bubbles; then another 15 seconds longer. (Should the primary control timing cause a lockout during purging, restart the burner following the primary control data sheet instructions.)
- Close bleed valve. The burner should cycle through the sequence given in the primary control data sheet.
- Perform primary control flame failure lockout and safety timing tests per instructions in primary control data sheet.
- Should control/burner fail to operate correctly, see page 19 for suggestions in troubleshooting.

Figure 15 EZ-123 burners wiring using Carlin 50200 primary control (see appliance manual or separate wiring information for burner equipped with a primary control not covered in this manual)

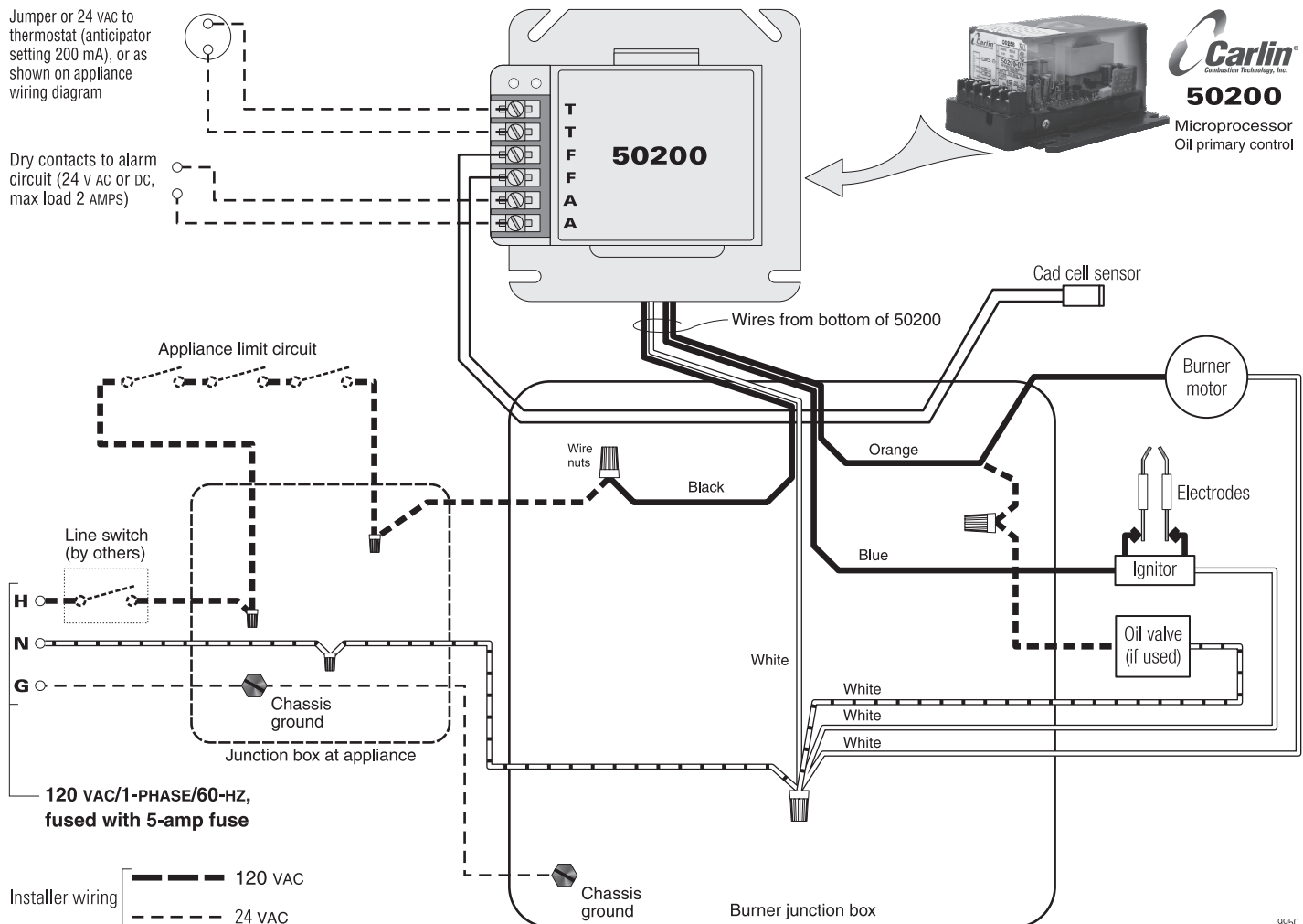

9950

Start-up & operation

WARNING

Do not start the burner if the combustion chamber contains oil or oil vapor.

NOTICE

Per UL requirements, the control will not turn on if the cad cell senses flame during the self-test. If the cad cell sees light, the control will remain in self-test mode until the cad cell no longer senses light (flame). The amber LED will remain on, but blink off momentarily (A) every 3 to 4 seconds.

NOTICE

Check 50200 control label for trial for ignition (TFI) timing.

(A) (R) Power ON

Open all manual oil line valves. Close the line switch. (If Red light turns on constant (R), control is in lockout. See below to reset.)

(A) (R) Self-test 1

(Revision B controls only) Each time the limit circuit sends power to the black wire, the control performs a "boot-up" test to verify internal operation. About 4 seconds after power application, the amber LED turns on. The test continues for about 6 more seconds. If the test fails, the control turns the amber LED off and repeats this test sequence until successful. (This test occurs on every call for heat cycle if burner is operated by a limit control (terminals "T-1" jumpered).

(A) (R) Stand-by

(Thermostat circuit open, limit circuit closed) If Self-test 1 is successful, amber LED turns off and control waits for thermostat circuit to close.

(A) (R) Call for heat

Set thermostat to call for heat. Thermostat circuit must close (and black wire must receive power from the limit circuit).

Self-test 2

The amber LED turns on. For the first 3 to 4 seconds, the control performs a self-test. If the cad cell senses flame, the control repeats this test until flame is no longer detected. During this time, the amber LED remains on, but blinks off momentarily (A) every 3 to 4 seconds. If the control detects motor contacts closed, lockout occurs.

(A) (R) Burner on

After the self-test, amber LED turns off. The *ignitor* starts, followed 1 second later by the *motor*. (This delay compensates for sluggish start-up of some AC transformers.)

(A) (R) TFI

The cad cell must sense flame within the TFI time limit (trial for ignition). After cad cell senses flame, the ignitor stays on another 10 seconds (flame stabilization period).

(A) (R) Run

The burner continues firing during call for heat if the cad cell senses flame. LED's are off during normal running.

(A) (R) Lockout

If cad cell does not sense flame within 15 seconds after burner starts, **lockout** occurs. The control turns the red LED on constant, and closes the **alarm** contact.

To Reset

Push in and hold reset button for 1 second, then release.

(A) (R) Latch-up

If the control locks out **3 times** during a single call for heat, **latch-up** occurs. The control turns on both the amber and red LED's constant. You must use the special procedure below to reset the control after latch-up.

WARNING

Reset after latch-up — Only a qualified service technician should attempt to reset the control after latch-up. The problem that caused the repeated burner problems must be corrected before returning the burner to normal operation.

(A) (R)

Push in and hold the reset button for about 10 seconds. The amber and red LED's will begin to flash alternately.

(A) (R)

After the LED's begin flashing, continue holding the reset button for about another 20 seconds. The LED's will turn off. Release the reset button and the control will restart. (Releasing the button before the LED's turn off will cause the control to remain in latch-up.)

NOTICE

The 50200 control will not reset from lockout or latch-up if power is interrupted.

(A) (R) Flame failure

If the cad cell loses flame signal during operation (after the TFI), the red LED flashes. The burner shuts off within 2 seconds.

Recycle: Control waits for 65 seconds (with red LED flashing), then begins again at **Self-test 2**. Red LED goes off (R).

(A) (R) End cycle

Set thermostat (or aquastat) to stop call for heat. The burner shuts off within 2 seconds after end of call for heat.

(A) (R) Stand-by

Control remains in stand-by mode until limit circuit sends power to the black wire (call for heat).

Model 50200 diagnostic LED's

(R) – Red OFF

(R) – Red ON

(R) – Red FLASHING

(A) – Amber OFF

(A) – Amber ON

(A) – Amber FLASHING

(A) – Amber **BLINKING** (blinks off momentarily every 3 to 4 seconds)

Service & Troubleshooting

Burner (control) will not come on

(A) (R)

No power to control

- Check line voltage to the control (at least 102 VAC).
- Check all electrical connections.

(A) (R)

Control is in lockout

- Red LED will be on. Press the reset button for 1 second.
- If the control returns immediately to lockout, The Safety Monitoring Circuit may have detected an internal control problem. Replace the control.

(A) (R)

CAD cell seeing light

- Amber LED blinks off each 3 to 4 seconds. Remove one yellow lead from FF terminal on the control.

If the amber **LED remains on** (A) with a wire detached, the control is defective.

If amber **LED goes off** (A), control is OK, and:

- light is leaking into the burner housing, *OR*
- CAD cell is defective, *OR*
- there is a problem with the CAD cell wiring or holder.
- If appliance was recently shut down, CAD cell may see residual hot spots in chamber.

To troubleshoot:

- **Check CAD cell** by unplugging it and measuring the resistance across its pins: dark resistance at least 50 KOHMS; room light resistance less than 10 KOHMS. Replace if necessary. If the CAD cell functions properly, reinstall the cell and close the burner housing.
- **Check for stray light** by measuring the CAD cell resistance looking into the inactive combustion chamber. It should read at least 50 KOHMS.

Repeated flame failures (A) (R) flashing red LED)

Check for:

- CAD cell is defective.
- Air leaking into oil line causing flame out — Check oil line connections and filter gasket.
- Defective nozzle causing flame to be erratic — Change nozzle.
- Excessive airflow or draft causing flame to leave burner head — Check for proper air band setting and draft.
- Excessive back pressure causing flame to be erratic — Check appliance and flue for sooting/plugging.

Control locks out after TFI (A) (R) red LED on)

Check for:

- No oil to burner — Check oil supply, filter, lines.
- Shorted electrodes — Inspect for cracked porcelain and replace as needed.
- Poor spark — Check electrode spacing and condition per burner manual. Replace or realign if necessary.
- Nozzle clogged — Replace nozzle.
- Airflow too high — Check air band setting.
- Ignitor module defective — Replace if no spark.
- CAD cell defective.
- Oil valve (if used) stuck in closed position.
- Check wiring connections.

4. Wire burner • start burner – 60200 primary control

WARNING Turn off power to appliance when servicing burner. Failure to comply could result in severe personal injury, death or substantial property damage.

Wire burner – 60200 primary control

- All wiring must comply with:
 - In the U.S — the National Electrical Code, ANSI Z223.1/NFPA 54.
 - In Canada — the Canadian Electrical Code Part 1, CSA standard C22.1.
 - All applicable local codes/standards.
- Wire the burner following Figure 16 and any special instructions or wiring diagram provided with the appliance, burner or other components.
- The burner requires a 120 VAC/60 HZ/single-phase power supply, with at least a 5-AMP fuse. The current draw (equipped with Carlin PSC motor) will be approximately 2.5 AMPS.
- The 60200 thermostat terminals provide a power source. Never apply external power to these terminals under any circumstances. To avoid this problem when using zone valves, disconnect field wires from 60200 thermostat terminals. Then connect a voltmeter across terminals. Operate all zones and verify that there is never a voltage reading at the meter. A voltage reading indicates incorrect wiring that must be corrected before attempting to operate the burner.
- Alarm terminals provide a 24 VAC-rated dry contact, suitable for use with security/fire alarm systems such as Carlin SecureHeat™.
- Make sure the burner and appliance are correctly wired and the line switch is properly fused for the load.

To start burner

WARNING Do not start the burner if the combustion chamber contains oil or oil vapor.

- Turn service switch OFF.
- Perform inspections and checkouts on pages 20 and 21.
- Slip one end of a 3/16-inch I.D. clear plastic hose over end of bleed valve, the other end into a container. Then open bleed valve.
- Set thermostat (operating controls) to call for heat.
- Turn service switch ON.
- Bleed oil line until plastic line is free of bubbles; then another 15 seconds longer. (Should the primary control timing cause a lockout during purging, restart the burner following the primary control data sheet instructions.)
- Close bleed valve. The burner should cycle through the sequence given in the primary control data sheet.
- Perform primary control flame failure lockout and safety timing tests per instructions in primary control data sheet.
- Should control/burner fail to operate correctly, see page 21 for suggestions in troubleshooting.

Figure 16 EZ-123 burners wiring using Carlin 60200 primary control (see appliance manual or separate wiring information for burner equipped with a primary control not covered in this manual)

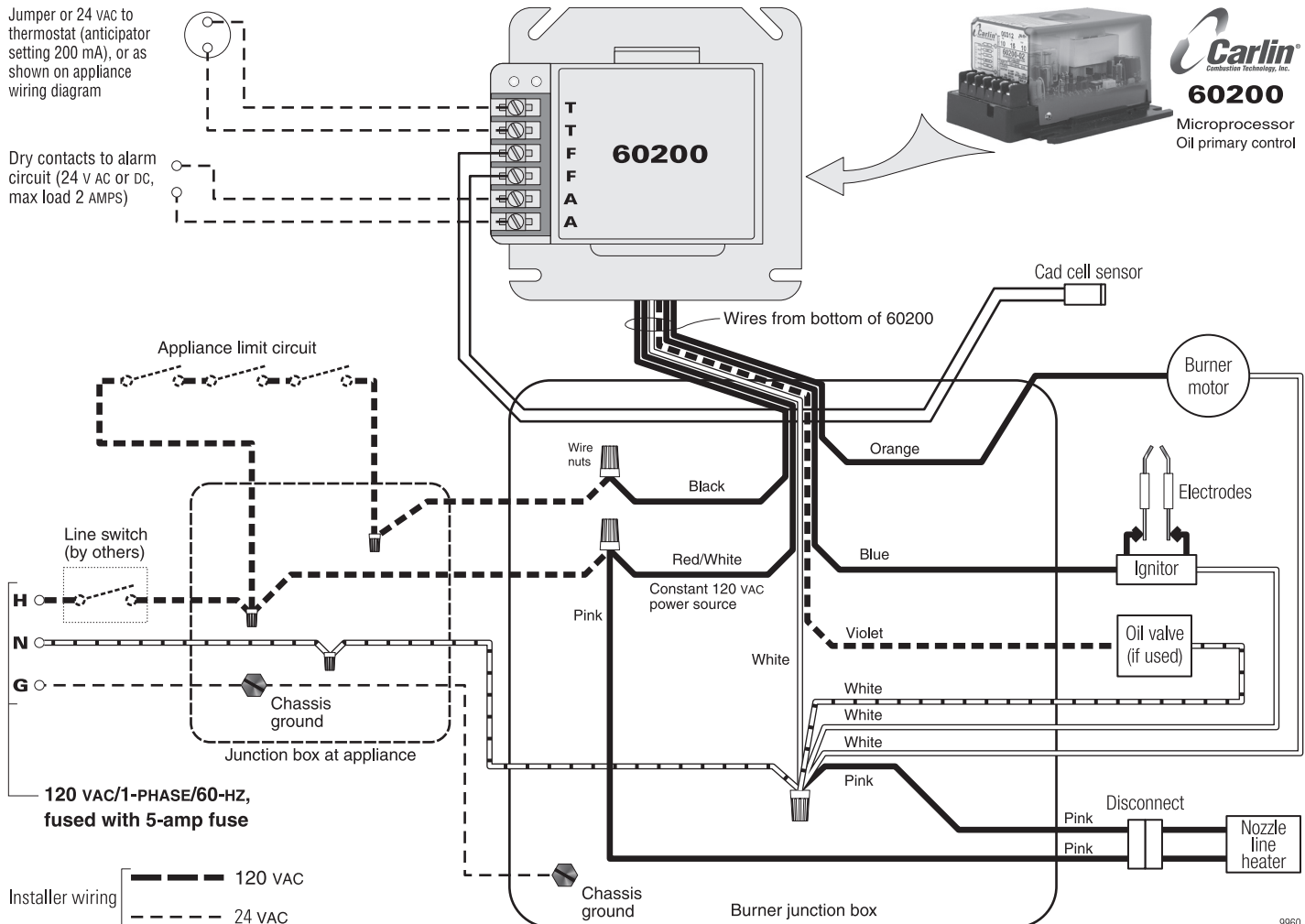

Start-up & operation

WARNING





















Do not start the burner if the combustion chamber contains oil or oil vapor.

NOTICE

Per UL requirements, the control will not turn on if the cad cell senses flame during the self-test. If the cad cell sees light, the control will remain in self-test mode until the cad cell no longer senses light (flame). The amber LED will remain on, but blink off momentarily  every 3 to 4 seconds.

NOTICE

Check 60200 control label for trial for ignition (TFI), pre-purge and post-purge timings.

-   **Power ON** Open all manual oil line valves. Close the line switch. (If Red LED turns on constant , control is in lockout. See below to reset.)
-   **Self-test 1** (*Revision B controls only*) The control performs a “boot-up” test to verify internal operation each time power is applied to the red/white wire. About 4 seconds after power application, the amber LED turns on. The test continues for about 6 more seconds. If the test fails, the control turns the amber LED off and repeats this test sequence until successful.
-   **Stand-by** (No call for heat) If Self-test 1 is successful, amber LED turns off and control waits for heat call.
-   **Call for heat** Set thermostat (or limit) to call for heat. Thermostat circuit must be closed and power coming to black wire from limit circuit.
- Self-test 2** The amber LED turns on. For the first 3 to 4 seconds, the control performs a self-test. If the cad cell senses flame, the control repeats this test until flame is no longer detected. During this time, the amber LED will remain on, but blink off momentarily  every 3 to 4 seconds. If the control detects motor contacts closed, lockout occurs.
-   **Burner on** After the self-test, amber LED turns off. The *ignitor* starts, followed 1 second later by the *motor*. (This delay compensates for sluggish start-up of some AC transformers.)
-   **Pre-purge** The *oil valve* opens after the valve delay-on period (pre-purge). (For oil valve delay on operation, wire oil valve to the violet lead. If not using an oil valve, cap the violet lead to automatically disable pre-purge and post-purge.)
-   **TFI** The cad cell must sense flame within the TFI time limit (trial for ignition). After cad cell senses flame, the ignitor stays on another 10 seconds (flame stabilization period).
-   **Run** The burner continues firing during call for heat if the cad cell senses flame. Both LED's are off during normal running.
-   **Lockout** If cad cell does not sense flame within the TFI time limit after burner starts, **lockout** occurs. The control turns the red LED on constant, and closes the *alarm* contact.
- To Reset Push in and hold reset button for 1 second, then release.
-   **Latch-up** If the control locks out **3 times** during a single call for heat, **latch-up** occurs. The control turns on both the amber and red LED's constant. You must use the special procedure below to reset the control after latch-up.

WARNING

Reset after latch-up — Only a qualified service technician should attempt to reset the control after latch-up. The problem that caused the repeated burner problems must be corrected before returning the burner to normal operation.









Push in and hold the reset button for about 10 seconds. The amber and red LED's will begin to flash alternately.









After the LED's begin flashing, continue holding the reset button for about another 20 seconds. The LED's will turn off. Release the reset button and the control will restart. (Releasing the button before the LED's turn off will cause the control to remain in latch-up.)

NOTICE

The 60200 control will not reset from lockout or latch-up if power is interrupted.









-   **Flame failure** If the cad cell loses flame signal during operation (after the TFI), the red LED flashes. The *oil valve* closes within 2 seconds. The *motor* remains on for the motor delay off period, then shuts off. (If no oil valve is wired to the control, the burner shuts down within 2 seconds.) **Recycle:** Control waits for 65 seconds (with red LED flashing), then begins again at **Self-test 2**. Red LED goes off .
-   **Post-purge** Set thermostat (or aquastat) to stop call for heat. The *oil valve* (if installed) will turn off within 2 seconds. The *motor* remains on for the motor delay off period (post-purge), then turns off. (If no oil valve is wired to the control, the burner shuts off within 2 seconds after end of call for heat. There is no post-purge.)
-   **Stand-by** Control remains in stand-by mode until limit circuit sends power to the black wire and thermostat circuit closes (call for heat).

Model 60200 diagnostic LED's

-  – Red OFF  – Red ON  – Red FLASHING
-  – Amber OFF  – Amber ON  – Amber FLASHING
-  – Amber BLINKING (blinks off momentarily every 3 to 4 seconds)

Service & Troubleshooting

Burner (control) will not come on

-   **No power to control**
 - Check line voltage to the control (at least 102 vac).
 - Check all electrical connections.
-   **Control is in lockout**
 - Red LED will be on. Press the reset button for 1 second.
 - If the control returns immediately to lockout, the Safety Monitoring Circuit may have detected an internal control problem. Replace the control.
-   **CAD cell seeing light**
 - Amber LED blinks off each 3 to 4 seconds. Remove one yellow lead from FF terminal on the control. If the amber **LED remains on**  with a wire detached, the control is defective.
 - If amber **LED goes off** , control is OK, and:
 - light is leaking into the burner housing, *OR*
 - CAD cell is defective, *OR*
 - there is a problem with the CAD cell wiring or holder.
 - If appliance was recently shut down, CAD cell may see residual hot spots in chamber.

To troubleshoot:

- **Check CAD cell** by unplugging it and measuring the resistance across its pins: dark resistance at least 50 KOHMS; room light resistance less than 10 KOHMS. Replace if necessary. If the CAD cell functions properly, reinstall the cell and close the burner housing.
- **Check for stray light** by measuring the CAD cell resistance looking into the inactive combustion chamber. It should read at least 50 KOHMS.

Repeated flame failures (flashing red LED)

Check for:

- CAD cell is defective.
- Air leaking into oil line causing flame out — Check oil line connections and filter gasket.
- Defective nozzle causing flame to be erratic — Change nozzle.
- Excessive airflow or draft causing flame to leave burner head — Check for proper air band setting and draft.
- Excessive back pressure causing flame to be erratic — Check appliance and flue for sooting/plugging.

Control locks out after TFI (red LED on)

Check for:

- No oil to burner — Check oil supply, filter, lines.
- Shorted electrodes — Inspect for cracked porcelain and replace as needed.
- Poor spark — Check electrode spacing and condition per burner manual. Replace or realign if necessary.
- Nozzle clogged — Replace nozzle.
- Airflow too high — Check air band setting.
- Ignitor module defective — Replace if no spark.
- CAD cell defective.
- Oil valve stuck in closed position.
- Check wiring connections.

5. Adjustment and verification

Perform combustion test

WARNING **COMBUSTION MUST BE VERIFIED WITH THE (OPTIONAL) BURNER COVER IN PLACE —**

Remove the burner cover if installed. Set up and adjust the burner using the following procedure. Replace the burner cover, allow the burner/appliance to run at least 15 minutes, then check combustion again. Readjust the burner is necessary. **The CO₂ will increase when the cover is put on**, particularly if combustion air is piped to the burner.

WARNING **If air is ducted to an (optional) air adapter, combustion must be set based on the air inlet temperature.** Air temperature variations will change how much air enters the burner, so the combustion must be set to anticipate the variations. Follow the guidelines below.

Adjust burner using test instruments

1. Operate burner for 15 minutes before making final adjustments using test equipment.
2. Check for leaks in fuel piping.

WARNING Inspect fuel piping system for leaks. Repair any leaks to avoid fire hazard from oil leakage or combustion problems due to air infiltration into oil.

3. Inspect flame
 - Look at flame through appliance combustion chamber observation port. The flame should be well-defined and should not impinge on any appliance surface. (If you make air or gas pressure changes later, inspect the flame again.)

WARNING Do not attempt to confirm combustion simply by inspecting the flame visually. You must use combustion test instruments. Failure to properly verify/adjust combustion could allow unsafe operation of the burner, resulting in severe personal injury, death or substantial property damage.

4. Insert test probe into vent or appliance flue damper sample opening to sample flue products.

WARNING Heating units designed for natural draft operation are normally set for a slightly negative pressure, usually -0.01 to -0.02 inches w.c. draft at the combustion chamber test port. Appliances designed for forced draft (positive pressure in the chamber) must be air-tight to prevent exfiltration of harmful combustion products. Failure to properly set draft for the appliance could result in severe personal injury or death.

5. Use combustion test equipment to verify that the burner is properly set up for your installation. Appliances with positive pressure in the chamber may require a wider air opening. See appliance instructions for details. Verify/adjust settings by testing with instruments.

- With the EZ burner equipped with the correct positioning bar, oil nozzle and initial air band setting, the flue products will usually contain between 11½%

and 12½% CO₂ (5.9% and 3.8% O₂) and zero (Bacharach) smoke. (Based on air inlet temperature of 70°F — see Table 5 for the proper values at other air temperatures for burners with ducted combustion air.)

- Depending on length of air piping (when used) and on air temperature, CO₂ may change one per cent or more with the cover in place.
- Check smoke. It should be zero on the Bacharach scale.
- Set the appliance flue damper or barometric draft regulator so the draft or pressure in the vent complies with the appliance manufacturer's instructions.

Re-install (optional) burner cover and check combustion again

1. Allow the burner to operate with the cover on for at least 15 minutes. (Insert a temperature probe to measure incoming combustion air temperature if combustion air is ducted to the burner.)

- Retest CO₂ (or O₂) and smoke again. The values will change when the cover is installed. Depending on length of air piping and on air temperature, CO₂ may change one per cent or more with the cover in place.
- Make sure the CO₂ (or O₂) values are in the range given in Table 5 for the inlet air temperature measured. IF NOT, remove the cover and adjust the air band more open to decrease CO₂ (increase O₂) or close the air band slightly to increase CO₂ (decrease O₂).
- Tighten air band clamping screw.

WARNING All installations should be checked after one to two weeks of operation to ensure the appliance/burner units are operating correctly.

Table 5 **Burners using inside air for combustion —** Use “65°F or higher” row in table below.
Burners with ducted combustion air — MEASURE incoming combustion air temperature and set the CO₂ (or O₂) using the following chart:

Incoming combustion air temperature during setup	CO ₂ Max and O ₂ Min @ setup			
	No. 2 Fuel oil combustion			
	CO ₂ min	CO ₂ max	O ₂ max	O ₂ min
-20 °F to 0 °F	9.6	10.6	7.8	6.4
5 °F to 30 °F	10.3	11.3	6.8	5.5
35 °F to 60 °F	10.8	11.8	6.2	4.8
65 °F or higher	11.5%	12.5 %	5.2%	3.9 %

5. Adjustment and verification *(cont.)*

Verify burner/appliance operation

Check burner/appliance/controls operation

- Test operating and limit controls on appliance as specified in appliance instructions.
- Check operation of the primary control by forcing lockout to occur. For primary controls that enter latch-up after multiple lockouts, force latch-up to occur as well. Reset primary control per control data sheet instructions after each test.
- Start and stop the burner several times, allowing the primary control to sequence through normal operation. Verify correct operation of burner and primary control throughout.

Verify vent system operation

- Verify vent is operating correctly and flue products are properly exhausted from building. If the building contains any exhaust fans or conditions that could affect vent performance, check burner/appliance/vent operation with exhaust fans (or other conditions) operating.

Combustion/ventilation air

- Verify combustion/ventilation air openings are not/will not be obstructed.
- Verify air opening louvers are full open.
- If louvers are motor-operated, verify motor and end switch are interlocked with appliance/burner wiring to prevent operation of the burner if the air louvers are not fully opened.

Prepare burner for normal operation

- Cycle burner off with appliance controls.
- Turn off power to the appliance.
- Seal the appliance flue damper test opening.
- Verify all components and wires are in place and burner is ready for operation.
- Restore power to the appliance.

Train the user

- Train the user to operate the burner and appliance under normal conditions.
- Explain procedure to shut down burner/appliance when required.
- Review rear cover of this manual (and the appliance manual) with the user.
- Verify the user is aware of all procedures specified in the manuals.
- Verify user will not store or use combustible liquids or materials or contaminants in the vicinity of the burner/appliance.

6. Annual start-up and service

Annual start-up & service

Perform the following

WARNING This burner must be started and serviced at least annually by a qualified service technician. Failure to properly maintain and service the burner could result in severe personal injury, death or substantial property damage.

- Discuss burner/appliance operation with user to determine any problems that may have occurred during the previous season and to verify user is aware of proper operation and care of the burner/appliance.
- Review proper operation of the appliance/burner unit with the user.
- Turn off power to appliance.
- Remove combustion head assembly to clean and adjust if necessary. (See procedure on page 10.)
- If the inside surface of the air tube and/or retention ring need to be cleaned, clean them with a vacuum cleaner with brush attachment while the combustion head assembly is out of the burner.
- Replace the oil nozzle with the correct size.
- Inspect and adjust the ignition electrodes and insulators per instructions on pages 10 and 11 of this manual. Replace if proper spacing cannot be achieved or if components are damaged.
- Close the housing cover plate and secure in place.
- Inspect the fuel line oil filter. Replace if necessary.

NOTICE Oil line filters — Use a non-bypassing filter to prevent nozzle plugging caused by poor oil filtration. Non-bypassing filters prevent small foreign particles from bypassing the filter, a common problem with fiber element type filters. Another problem of some filters is the fiber from filter element tears can break away and plug the nozzle or fuel unit.

- Perform the complete checkout procedures of pages 10 to 13, including system inspection and checks.
- Inform the user of any problems found.

7. Repair parts

Item	Description	Part No.	Item	Description	Part No.
1	Air tube, 4" nominal, approx. 4-3/8" oal (EZ -1), universal flange	77719	13	Head positioning bar kit w/7 bars & thumb screw (EZ -1, EZ-1-HP)	98078
	Air tube, 5" nominal, approx. 5-3/8" oal (EZ -1), universal flange	77727		Head positioning bar kit w/4 bars & thumb screw (EZ -2, EZ-2-HP)	84715
	Air tube, 7" nominal, approx. 7-3/8" oal (EZ -1), universal flange	77735		Head positioning bar kit w/3 bars & thumb screw (EZ -3, EZ-3-HP)	86389
	Air tube, 9" nominal, approx. 9-3/8" oal (EZ -1), universal flange	77743	14	Combustion head assembly 4"	77941
	Air tube, 11" nominal, approx. 11-3/8" oal (EZ -1), universal flange	77750		Combustion head assembly 5"	77958
	Air tube, 5" nominal, approx. 5-1/4" oal (EZ -2 & 3), universal flange	83816		Combustion head assembly 7"	77966
	Air tube, 7" nominal, approx. 7-1/4" oal (EZ -2 & 3), universal flange	83824		Combustion head assembly 9"	77974
	Air tube, 9" nominal, approx. 9-1/4" oal (EZ -2 & 3), universal flange	83832	15	Combustion head assembly 11"	77982
	Air tube, 11" nominal, approx. 11-1/4" oal (EZ -2 & 3), universal flange	83840		Electrode bracket	23135
	Air tube with welded flange, for specific appliance (contact factory)	—		16	Bracket, nozzle line heater
2	Motor, 1/6 hp, 3450 rpm, Carlin PSC	98022	17	Nozzle line heater w/electrical disconnect	66787
	Motor, 1/7 hp, 3450 rpm, for Suntec A/B, Webster M/2M, and Danfoss pumps	27490	18	C-ring for nozzle line	31633
	Motor, 1/6 hp, 3450 rpm, for Suntec J/H pumps	27631	19	Thumb nut, nozzle line	62885
3	Electrode wire, set of 2, 4" nominal, approx. 5-1/2" oal (EZ -1 only)	82750	20	Gasket, transformer	40167
	Electrode wire, set of 2, 5" nominal, approx. 6-1/2" oal	82768	21	Cad cell	4002400A
	Electrode wire, set of 2, 7" nominal, approx. 8-1/2" oal	82776	22	Transformer terminal kit, (2 terminals & nuts)	24463
	Electrode wire, set of 2, 9" nominal, approx. 10-1/2" oal	82784	23	Transformer hold-down tab, two required	44842
	Electrode wire, set of 2, 11" nominal, approx. 12-1/2" oal	82792	24	Junction box, 4"x4", w/grommet and lockwasher	44586
4	Nozzle line/adaptor assembly, 4" nominal, approx. 5-3/4" oal (EZ -1 only)	56804	25	Blower wheel, 5-1/16d x 2w	77933
	Nozzle line/adaptor assembly, 5" nominal, approx. 6-3/4" oal	56820	26	Primary control (consult factory for other controls)	60200
	Nozzle line/adaptor assembly, 7" nominal, approx. 8-3/4" oal	56861	27	Welded flange, when supplied (contact factory)	—
	Nozzle line/adaptor assembly, 9" nominal, approx. 10-3/4" oal	57315	27a	Mounting flange, 3-1/2 id x 8-1/4 od Universal flange	81364
	Nozzle line/adaptor assembly, 11" nominal, approx. 12-3/4" oal	56754	28	Gasket, mounting flange	40287
5	Ignitor, Carlin electronic	41000	29	Pedestal w/hardware	23317
6	Oil valve, instant opening	40857	30	Screw, head positioning bar	98349
	Oil valve kit, instant opening, w/fittings & oil lines	24638	31	Flame retention ring assembly	77438
	Oil valve, instant opening, Carlin	SVC10FF	32	Nozzle (obtain locally)	—
	Oil valve kit with fitting, Carlin	98289	33	Housing, w/84939 access cover	7781801
7	Fuel unit, std. single stage, Suntec A2VA-7116, w/fitting	22996	34	Plug-in wire harness, when supplied (contact factory)	—
	Fuel unit, std. two stage, Suntec B2VA-8216, w/fitting	23002	35	Elbow, 3/16 flare x 1/8 NPT	29926
	Fuel unit, std. single stage, Webster M34D, w/fitting	23143			
	Fuel unit, std. two stage, Webster 2M34D, w/fitting	23176			
	Fuel unit, std. single stage, Danfoss BFPH w/fitting (ez-1)	27183			
	Fuel unit, opt. single stage, Suntec JA2BB-300, w/fitting (Note 1)	23127			
8	Fuel unit, opt. two stage, Suntec HA2BB-300, w/fitting	23069			
	Oil line, 3/16 od, std. fuel unit to oil valve	34397			
8a	Oil line, 3/16 od, opt. fuel unit (J/H pump) to oil valve	34413			
	Oil line, 3/16 od, oil valve to nozzle line	34439			
9	Oil line, 3/16 od, std. fuel unit to nozzle line	34470			
	Oil line, 3/16 od, opt. fuel unit (J/H pump) to nozzle line	34512			
10	Coupling, for std. fuel units, approx. 2-3/8" oal	75564			
	Coupling, for opt. fuel units (J/H pumps), approx. 2-3/16" oal	28704			
11	Air band (EZ-1), with 100 PSIG scale	98055			
	Air band (EZ -2), with 100 PSIG scale	98087			
	Air band (EZ -3), with 100 PSIG scale	98089			
12	Air shutter, blank (EZ-1)	97780			
	Air shutter, one slot (EZ -1)	98052			
	Air shutter, three slots (EZ -2)	98109			
	Air shutter, four slots (EZ -3)	98108			

For parts not shown or listed, contact factory and/or check separate documentation supplied with appliance/burner unit.

Note 1: Requires 1/6 hp motor (item 2) and special coupling

7. Repair parts *(continued)*

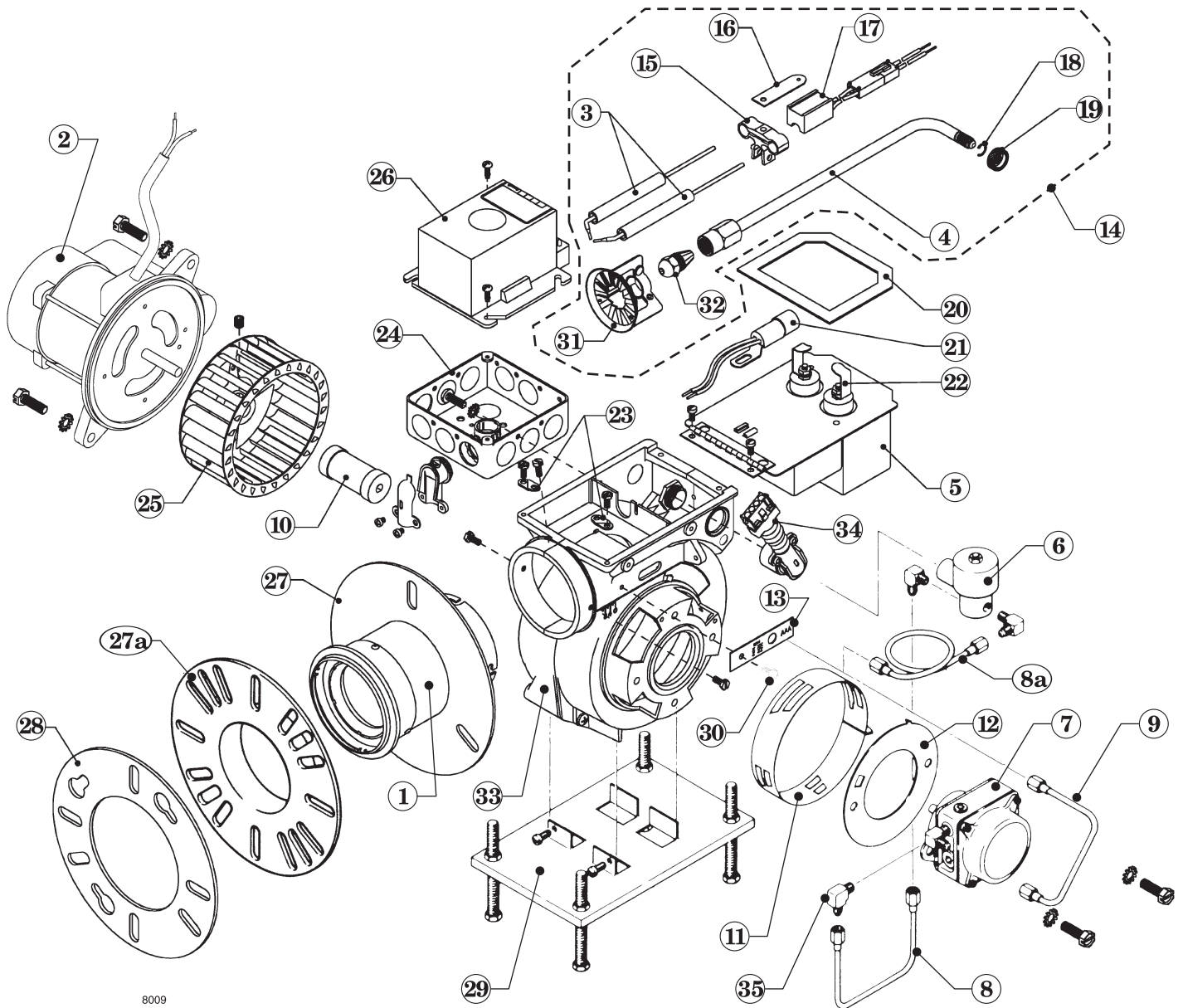

8. Maintenance procedures

Maintenance/service procedures

WARNING Turn off power to appliance when servicing burner. Failure to comply could result in severe personal injury, death or substantial property damage.

Cleaning blower wheel

1. The blower wheel accumulates dust and debris from normal operation. You will need to clean the wheel blades periodically to prevent reduction in airflow.
 - Inspect the blower wheel by removing the blower wheel access cover. See Figure 18.
 - To remove the cover, open the ignitor plate and loosen the blower wheel access cover screw about three turns.
 - Inspect the blower wheel to see if it needs to be cleaned. Dirt and lint on the wheel reduce air flow, and must be removed if the burner is to operate correctly.
2. To clean blades, remove the two bolts securing the motor to blower housing.
 - a. Slide the motor out and rotate to remove and access blower wheel.
 - b. Use a brush and vacuum to clean each blade and the blower housing interior.
 - c. Replace motor/wheel in blower housing and secure with the two bolts.
 - d. Push wire slack back into junction box.

Figure 18 Remove blower access cover to inspect blower wheel

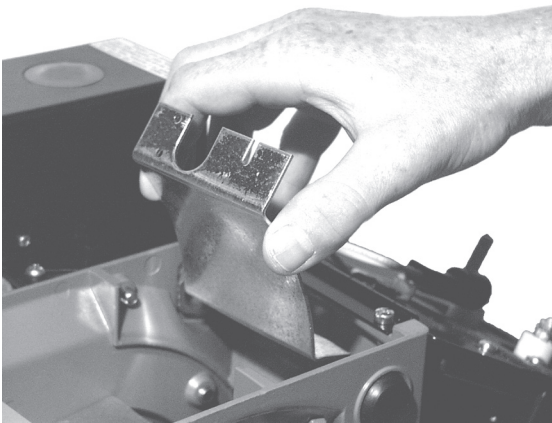

Replacing blower motor or wheel

1. If either the blower wheel or motor must be replaced, remove the two bolts securing the motor to housing.
2. Disconnect the motor wires in the burner junction box.
3. Loosen the Allen screw securing the blower to the motor shaft and remove the wheel.
4. When assembling the replacement assembly, slide the wheel onto the motor shaft and use feeler gauges to set a space of 3/64 inch between the blower wheel and the motor face.
5. Replace the motor/wheel assembly in the housing, wire the motor leads and secure the motor with the two bolts.

Motor maintenance

- The Carlin PSC motor is constructed with permanently-lubricated bearings, and requires no oiling. Should you replace the original motor with another type of motor, occasional oiling may be required, depending on motor design and manufacturer's recommendations.
- Any time you replace a component or disassemble any part of the burner for service/maintenance, perform a complete operational test after reassembly to verify the burner operates correctly. Failure to verify operation could result in severe personal injury, death or substantial property damage.

Checking ignitor

WARNING Never test an ignitor by placing a screwdriver (or other metallic object) across the high voltage clips. Check 40700 & 40900 ignitors only by observing spark at appliance ignition electrodes, with fuel supply OFF. Using any other method could cause ignitor damage and severe personal injury.

1. Checking 41000 ignitors only:
 - Disconnect electrical power to burner.
 - Remove hold down clips or screws. Lift ignitor mounting plate to the full-open position. Set high voltage clips to a 1/2" to 3/4" gap.
 - Carefully energize ignitor and check for spark arcing at the high voltage terminals. If spark jumps the gap, ignitor is good.

Ceramic fiber materials

WARNING The appliance may contain ceramic fiber and/or fiberglass materials. Ceramic fiber materials, such as chamber liners, may contain carcinogenic particles (chrysothalites) after exposure to heat. Airborne particles from fiberglass or ceramic fiber components have been listed as potentially carcinogenic by the State of California. Take the following precautions when removing, replacing and handling these items.

Avoid breathing dust and avoid contact with skin or eyes. Wear long-sleeved, loose-fitting clothing, gloves and eye protection. Use a NIOSH N95 certified respirator. This respirator meets requirements for protection from chrysothalites. Actual job requirements or NIOSH regulations may require other or additional protection. For information, refer to the NIOSH website, <http://www.cdc.gov/niosh/homepage.html>.

Ceramic fiber removal: To prevent airborne dust, thoroughly wet ceramic fiber with water before handling. Place ceramic fiber materials in a plastic bag and seal to dispose.

Avoid blowing, tearing, sawing or spraying fiberglass or ceramic fiber materials. If such operations are necessary, wear extra protection to prevent breathing dust.

Wash work clothes separately from other laundry. Rinse clothes washer thoroughly afterwards to prevent contamination of other clothing.

NIOSH First aid procedures:

Eye exposure — irrigate immediately

Breathing — fresh air.



Limited Warranty

Carlin Combustion Technology, Inc. (Carlin) warrants its products, to the original purchaser, to be free from defects in material and workmanship, under normal use and service for 36 months from the date of manufacture, except for commercial Products (over 3 GPH) that are warranted for 12 months from the date of manufacture; and except for EZ-Pro™ Burners that are warranted for 36 months from the date of manufacture, plus an extended period of two (2) additional years (total of five (5) years).

This warranty does not extend to equipment subjected to misuse, neglect, accident or water damage; nor does this warranty apply unless the product covered by it is properly installed by a qualified, competent technician, who is licensed where state or local codes require, and who is experienced in making such installations, in accordance with NFPA No. 31 of the National Fire Protection Association and in accordance with all applicable local, state and national codes. Parts that are defective in material or workmanship and within the warranty period will be repaired or replaced as follows:

1. Motors, fuel units, transformers and other non-Carlin products should be sent for repair or replacement to an authorized service point or distributor of the manufacturer of such components when reasonably available in the Customer's locality.
2. Where such local service is not available with respect to the above listed components, or where Carlin components are involved, or for component parts of EZ-Pro Burners that fall within the extended warranty period, such defective parts should be returned, freight prepaid to Carlin. The repaired component or replacement part will be provided to the Customer freight prepaid by Carlin unless the returned part is determined by Carlin to be out of warranty or not to be defective, in which case it will be provided to the customer F.O.B., Carlin, East Longmeadow, Massachusetts.
3. Contact Carlin Customer Service for warranty return procedures.
4. The return of a burner is not covered by this warranty. Contact Carlin Tech Service for assistance before replacing any burner.
5. Carlin is not responsible for any labor cost for removal and replacement of equipment.
6. Equipment that is repaired or replaced will carry the unexpired portion of the original equipment warranty.
7. If inspection by Carlin does not disclose any defect covered by this warranty, the equipment may be repaired or replaced at the expense of the Customer, and Carlin's regular charges will apply.
8. Non-Carlin components are warranted for 12 months from date of installation or 18 months from date of manufacture, whichever date occurs first.

This warranty is limited to the precise terms set forth above, and provides exclusive remedies expressly in lieu of all other remedies and in particular there shall be excluded the implied warranties of merchantability and fitness for a particular purpose. In no event will Carlin Combustion Technology, Inc. be liable for any incidental or consequential damage of any nature. Carlin neither assumes nor authorizes any person to assume for Carlin any other liability or obligations in connection with the sale of this equipment. Carlin's liability and Customer's exclusive remedy being limited to repairs or replacement as set forth above.

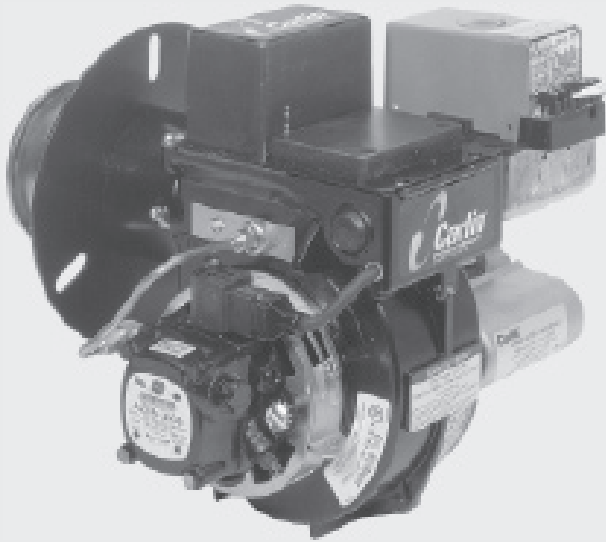

WARNING The burner must be cleaned, tested and adjusted annually by a qualified oil burner service technician.

WARNING **Should overheating occur:**

- (1) shut off the oil supply to the burner.
- (2) DO NOT shut off the control switch to the circulator or blower.
- (3) contact your oil dealer or service technician and the fire department (if needed).

EZ-1/2/3 oil burner User care and maintenance

WARNING Refer only to the information on this page, intended for your use. The remainder of this manual is intended only for your service technician. Failure to comply could result in severe personal injury, death or substantial property damage.

For other than routine maintenance, contact a qualified service company. Perform the following as needed.

- Keep the area around the burner clear and free from combustible vapors and liquids.
- Do not obstruct the flow of combustion and ventilating air.
- Most motors currently used on residential type burners use permanently-lubricated bearings, and do not require field lubrication. Read the label on the motor to determine oiling needs, if any. Do not over-lubricate. This can cause as much trouble as not lubricating at all.

WARNING Never attempt to use gasoline as a fuel for this burner, as it is more combustible and could result in a serious explosion. Never attempt to burn refuse or use any fuel other than # 1 or # 2 heating oil (ASTM D396).