

## Mineral Commodity Profiles—Asbestos

CLICK ANYWHERE on THIS PAGE to RETURN TO ASPHALT ROOF SHINGLE  
ASBESTOS at [InspectApedia.com](http://InspectApedia.com)

Circular 1255—KK

# **Mineral Commodity Profiles—Asbestos**

By Robert L. Virta

Circular 1255–KK

**U.S. Department of the Interior**  
**U.S. Geological Survey**

**U.S. Department of the Interior**  
Gale A. Norton, Secretary

**U.S. Geological Survey**  
P. Patrick Leahy, Acting Director

U.S. Geological Survey, Reston, Virginia: 2005

For product information:

World Wide Web: <http://www.usgs.gov/pubprod>

Telephone: 1-888-ASK-USGS

For more information on the USGS--the Federal source for science about the Earth, its natural and living resources, natural hazards, and the environment:

World Wide Web: <http://www.usgs.gov>

Telephone: 1-888-ASK-USGS

Any use of trade, product, or firm names is for descriptive purposes only and does not imply endorsement by the U.S. Government.

Although this report is in the public domain, permission must be secured from the individual copyright owners to reproduce any copyrighted materials contained within this report.

Suggested citation:

Virta, R.L., 2005, Mineral commodity profiles—Asbestos: U.S. Geological Survey Circular 1255–KK, 56 p.

# Contents

Overview .....	1
Historical background .....	2
Chemical identity .....	8
Serpentine asbestos .....	8
Amphibole asbestos.....	8
Commercial forms, grades, shapes, and specifications.....	9
Amosite, chrysotile, and crocidolite.....	9
Grades, shapes, and specifications .....	9
Grade specifications for products.....	11
Asbestos-cement products .....	11
Asbestos paper and millboard .....	11
Asphalt products .....	12
Caulking compounds and nonbituminous sealants and coatings.....	12
Friction materials.....	12
Gaskets.....	12
Plastics.....	12
Textiles.....	13
Physical, chemical, and engineering properties.....	13
Physical properties .....	13
Chemical properties.....	13
Uses .....	15
Present uses.....	15
Patterns of use.....	16
Historical end-use consumption.....	16
Asbestos substitutes.....	19
Dissipative uses.....	19
Sources .....	19
Principal deposits.....	19
Origin and modes of geologic occurrence.....	20
Reserves and resources .....	21
Mining and processing.....	23
Exploration techniques.....	23
Mining.....	24
Processing.....	24
Coproducts and byproducts .....	25
Recycling .....	25
Environmental impact.....	26

Industry structure .....	26
Producers.....	26
Consumers .....	27
Employment .....	35
Market-size and reach.....	36
Prices.....	40
Supply and demand.....	41
Components of supply.....	41
International trade .....	42
Strategic considerations .....	43
Sustainability.....	43
Economic factors.....	44
Production and transportation .....	44
Energy requirements.....	45
Environmental, health, and safety issues .....	47
Liability.....	48
Tariffs and taxes .....	49
Tariffs.....	49
Depletion provisions.....	49
Government programs .....	49
Outlook.....	49
References cited.....	49
Appendix—Definitions of reserves, reserve base, and resources.....	56

## Figures

1. Estimated world production of asbestos in 2003.....	1
2. World consumption of asbestos, by region.....	3
3. U.S. apparent consumption of asbestos from 1900 to 2003.....	3
4. World production of asbestos, by type, from 1900 to 2003 .....	4
5. World production of asbestos, by country, from 1900 to 2003 .....	5
6. Estimated world consumption of asbestos in 2003.....	16
7. Major U.S. asbestos end uses in 1973, 1980, and 2003.....	17
8. World asbestos resources.....	20
9. Generalized block caving method used in underground mining of asbestos .....	24
10. Generalized flowsheet for asbestos milling process.....	25
11. Average unit values of asbestos produced in an imported into the United States from 1932 to 2003 .....	41
12. U.S. supply and demand relationship for asbestos in 2003 .....	42
13. Asbestos export patterns in 2003 for annual shipments greater than 10,000 metric tons .....	43

## Tables

1. Early developments in the asbestos industry.....	2
2. World asbestos production, all types.....	6
3. Types of asbestos.....	8
4. Quebec asbestos grading system.....	9
5. Grades for milled chrysotile from Zimbabwe.....	10
6. Grades for milled chrysotile from Swaziland.....	10
7. Classification of chrysotile in Russia.....	10
8. Grades for amosite from South Africa.....	10
9. Grades for crocidolite from the Cape region of South Africa.....	11
10. Grades for crocidolite from the Transvaal region of South Africa.....	11
11. Properties of asbestos fibers.....	14
12. Major-oxide composition of commercial chrysotile samples.....	15
13. Major-oxide composition of amphibole asbestos.....	15
14. World consumption of asbestos in 1974 and 1988.....	17
15. End uses for asbestos in the United States from 1965 to 2003.....	18
16. Asbestos substitutes.....	19
17. Examples of asbestos substitutes and alternative products.....	20
18. Property resource information as of January 1982.....	22
19. Asbestos production, trade, and consumption in 1960.....	27
20. Asbestos production, trade, and consumption in 1975.....	29
21. Asbestos production, trade, and consumption in 2000.....	32
22. Asbestos production, trade, and consumption in 2003.....	36
23. Changes in estimated apparent consumption.....	39
24. Mining methods and operating costs, January 1982.....	44
25. Estimated mill-to-market fiber transportation costs in January 1982.....	46
26. Energy used by the U.S. asbestos mining industry in 1985.....	46
27. Energy consumed in the production of cleaned and graded chrysotile asbestos.....	47

## Conversion Factors

<b>Multiply</b>	<b>By</b>	<b>To obtain</b>
	Area	
square foot (ft <sup>2</sup> )	0.09290	square meter (m <sup>2</sup> )
	Volume	
gallon (gal)	3.785	liter (L)
	Mass	
ton, short (2,000 lb)	0.9072	megagram (Mg)
	Pressure	
bar	100	kilopascal (kPa)
pound per square inch (lb/in <sup>2</sup> )	6.895	kilopascal (kPa)
	Energy	
kilowatthour (kWh)	3,600,000	joule (J)

Temperature in degrees Celsius (°C) may be converted to degrees Fahrenheit (°F) as follows:

$$^{\circ}\text{F}=(1.8\times^{\circ}\text{C})+32$$

Temperature in degrees Fahrenheit (°F) may be converted to degrees Celsius (°C) as follows:

$$^{\circ}\text{C}=(^{\circ}\text{F}-32)/1.8$$

# Mineral Commodity Profiles—Asbestos

By Robert L. Virta

## Overview

Asbestos is a generic name given to six fibrous minerals that have been used in commercial products. It is an industry term rather than a mineralogical term that is applied to specific fibrous mineral particles that possess high tensile strengths, large length-to-width ratios, flexibility, and resistance to chemical and thermal degradation. Asbestos also exhibits high electric resistance, and many forms can easily be woven into textiles (Bowles, 1935, p. 5-7; Rosato, 1959, p. 46-52; Meylan and others, 1978, p. 2-12; Virta, 2001).

The six types of asbestos that have been used commercially are actinolite asbestos, amosite (cummingtonite-grunerite asbestos), anthophyllite asbestos, chrysotile, crocidolite (riebeckite asbestos), and tremolite asbestos. Chrysotile is a serpentine group mineral. The other five varieties of asbestos are amphibole group minerals (Campbell and others, 1977, p. 5-17, 33; Ross, Kuntze, and Clifton, 1984; Skinner, Ross, and Frondel, 1988, p. 30-32, 35). Magnesioriebeckite asbestos from Bolivia was used commercially in the past. Other varieties of amphibole asbestos, including richterite asbestos and potassian winchite asbestos, have been recognized but have not been used commercially (Wylie and Huggins, 1980;

Hodgson, 1986, p. 110). Chrysotile has been the most commonly used form of asbestos, followed by crocidolite, amosite, and then anthophyllite asbestos. Relatively small amounts of tremolite asbestos and actinolite asbestos have been produced and used.

About 2.15 million tons (Mt) of asbestos with a value exceeding an estimated \$500 million was produced in 17 countries in 2003. The major producing countries, in decreasing order of production, were Russia, China, Canada, Brazil, Kazakhstan, and Zimbabwe (fig. 1). These countries accounted for about 96 percent of world production. In 2003, there were about 30 producing companies operating worldwide, not including China, which had an indeterminate number of small producers (Virta, 2005). Essentially all the asbestos mined today is chrysotile. A few thousand tons of tremolite asbestos may have been produced in a few locations (Moore, 2004).

The most common use for asbestos worldwide in 2003 was in asbestos-cement (A/C) products, such as A/C corrugated and flat sheet, A/C fittings, and A/C pipe. These products accounted for more than 85 percent of world consumption. Other uses for asbestos were in asphalt roof coatings, brake pads and shoes, clutches, gaskets, electrical and thermal

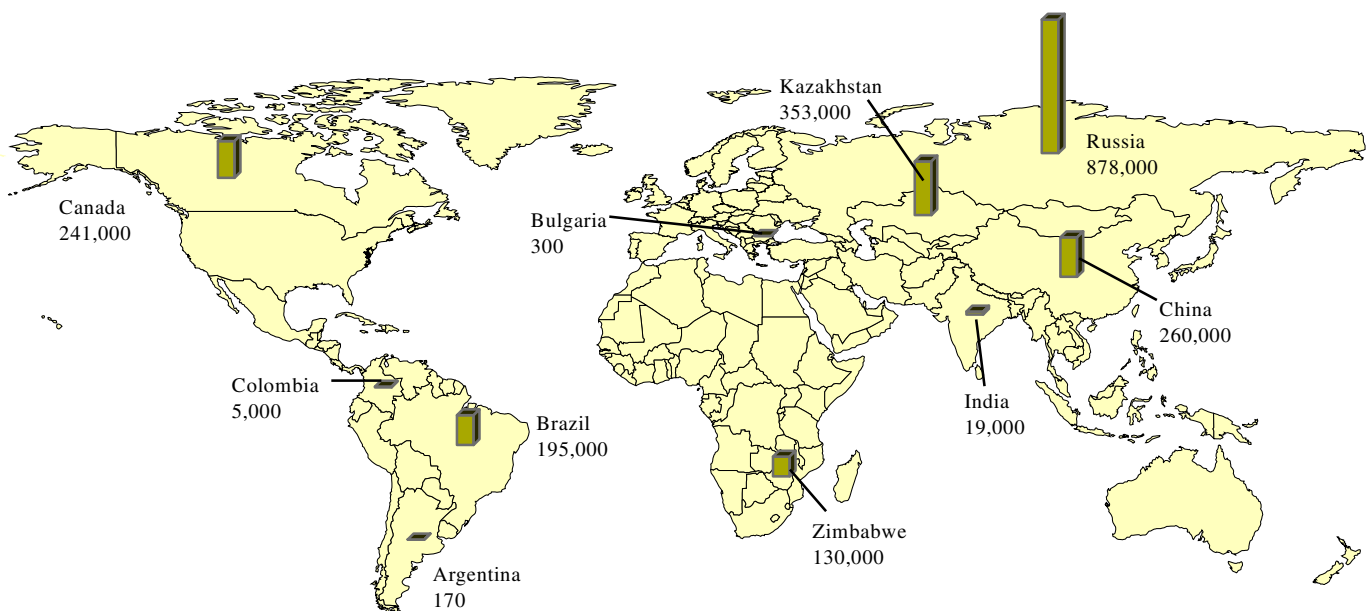

**Figure 1.** Estimated world production of asbestos in 2003. Figures listed are in metric tons. Afghanistan, North Korea, Romania, and Slovakia also produced small amounts of asbestos estimated to be 10 metric tons for each.



## 2 Mineral Commodity Profiles—Asbestos

insulation, millboard and paper (mostly used in insulation applications), plastics, and textiles. The major markets for asbestos in the United States were asphalt roof coatings and coatings and compounds (Moore, 2004; Virta, 2005).

World asbestos consumption was estimated to be 2.15 Mt in 2003. Use of asbestos was estimated to be greatest in China, India, Kazakhstan, Russia, Thailand, and Ukraine. These countries were believed to have accounted for between 60 and 70 percent of world consumption based on trade data reported by the United Nations and world production between 2000 and 2003 (United Nations, 2004; Virta, 2005).

The volume of trade in asbestos has decreased in past 30 years as opposition to its use has increased worldwide. Brazil and Canada are the only two Western Hemisphere producers. These two countries export primarily to Asian and South American markets. Production from Africa, Eastern Europe, and China is used primarily in Eastern European and/or Asian countries (Perron, 2003; United Nations, 2005).

### Historical Background

Asbestos has been used for more than 3,000 years. Some of the earliest uses were crematory shrouds, lamp wicks, and incombustible napkins and tablecloths (Anonymous, 1928, p. 14-16; Bowles, 1935, p. 2-4; Sinclair, 1959, p. 277; Selikoff and Lee, 1978, p. 3-5; Gross and Braun, 1984, p. 9; Alleman and Mossman, 1997).

The modern asbestos industry began in the early 1800s when a textile industry was established in Italy to produce such items as fabrics, string, and book covers (Bowles, 1946, p. 14; Sinclair, 1959, p. 277; Alleman and Mossman, 1997). With increased industrialization, new uses that took advantage of the strength, heat resistance, and flexibility of asbestos fibers were developed. These included packings for steam glands on high-temperature machines, insulation for boilers and steam pipes, and fireproof roofing and wall materials. Textiles remained a small yet valuable market during this period of expanded use (Anonymous, 1953, p. 4-6; Sinclair, 1959, p. 278-279; Selikoff and Lee, 1978, p. 17; Alleman and Mossman, 1997).

As the asbestos manufacturing industry grew worldwide in the late 1800s, concerns over supply arose because production in Italy, the world's primary supplier of asbestos, and other countries totaled only a few thousand tons per year (Bowles, 1934, p. 7-24; Howling, 1937, p. 59; Selikoff and Lee, 1978, p. 14). The discovery and development of large asbestos deposits in Canada, Russia, and South Africa in the late 1800s resolved the supply issue (Sinclair, 1959, p. 3; Selikoff and Lee, 1978, p. 8-9).

In 1900, the development of the Hatschek machine for making A/C flat and corrugated panels resulted in a significant increase in demand for asbestos products (Rosato, 1959, p. 63; Sinclair, 1959, p. 279). This technology enabled the mass production of inexpensive fireproof building materials. This

was followed in 1929 by development of a process for the mass production of A/C pipe, enabling its widespread use in water supply and waste lines (Rosato, 1959, p. 78-79; Sinclair, 1959, p. 279; Selikoff and Lee, 1978, p. 17). Simultaneously, the rise of the automobile industry resulted in an increased demand for asbestos for the manufacture of brakes, clutch components, and engine gaskets (Sinclair, 1959, p. 278). These developments resulted in a rapid increase in the use of asbestos worldwide. By 1910, world production exceeded 80,000 metric tons (t), an increase of 300 to 400 percent from that of 1900. At that time, the United States was the leading user of asbestos in the world, accounting for an estimated 55 percent of world consumption (Virta, 2003, p. 21).

Production and consumption declined during World War I and the Great Depression of the 1930s. Immediately after both events, there was rapid growth in construction and other market sectors, which continued into the 1940s. Sales and use of asbestos increased throughout the world to meet the demands of new and expanding markets (table 1; figs. 2, 3). In addition to automotive and A/C products, demand grew for asbestos millboard and paper for electrical panels; textiles for

**Table 1.** Early developments in the asbestos industry

[Data from Anonymous, 1953, p. 4-6; Selikoff and Lee, 1978, p. 17-18]

1857-1880	First packings and flat seals using asbestos
1866	First bonded and molded asbestos product for heat insulation
1868-1869	First use of asbestos in roofing felt and cement in the United States
1866-1876	Start of systematic textile processing in Italy
1878	Asbestos paper first made in the United States
1882	Concept of asbestos-containing magnesia insulation developed
1890	Textile processing begins in Canada
1893	First spinning of crocidolite in South Africa
1896	First woven brake bands made in the United Kingdom
1899	Wet machine process of making asbestos-cement developed
1900	Hatschek machine for manufacturing asbestos-cement pipe developed
1903	Asbestos-cement pipe industry begins in the United States
1904	Flat asbestos-cement board manufactured in the United States
1906	Asbestos first used as brake lining
1918	Molded clutch facing developed
1931	Technique for spraying asbestos developed in the United Kingdom
1940s	Asbestos-cement pipe introduced in the United Kingdom
1944	Spraying of deck heads and bulkheads began in British ships

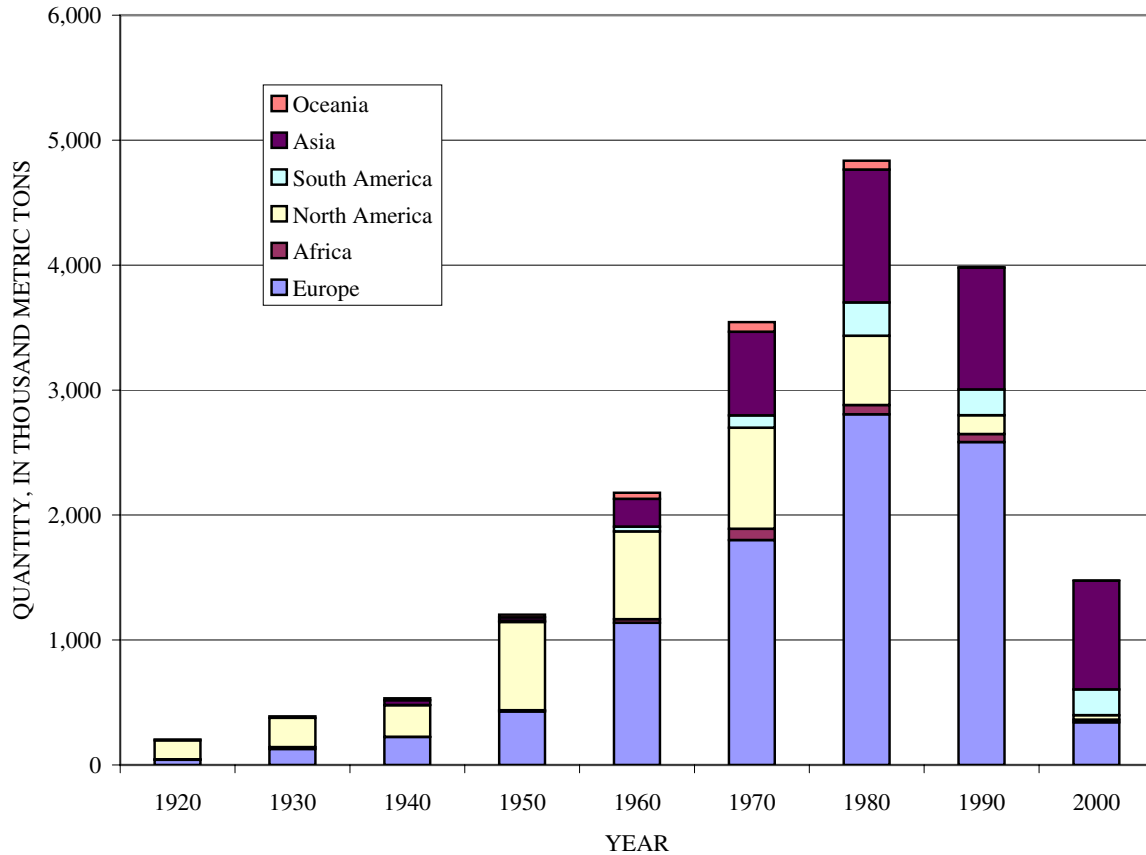

Figure 2. World consumption of asbestos, by region. Data from Virta, 2003b, p. 27.

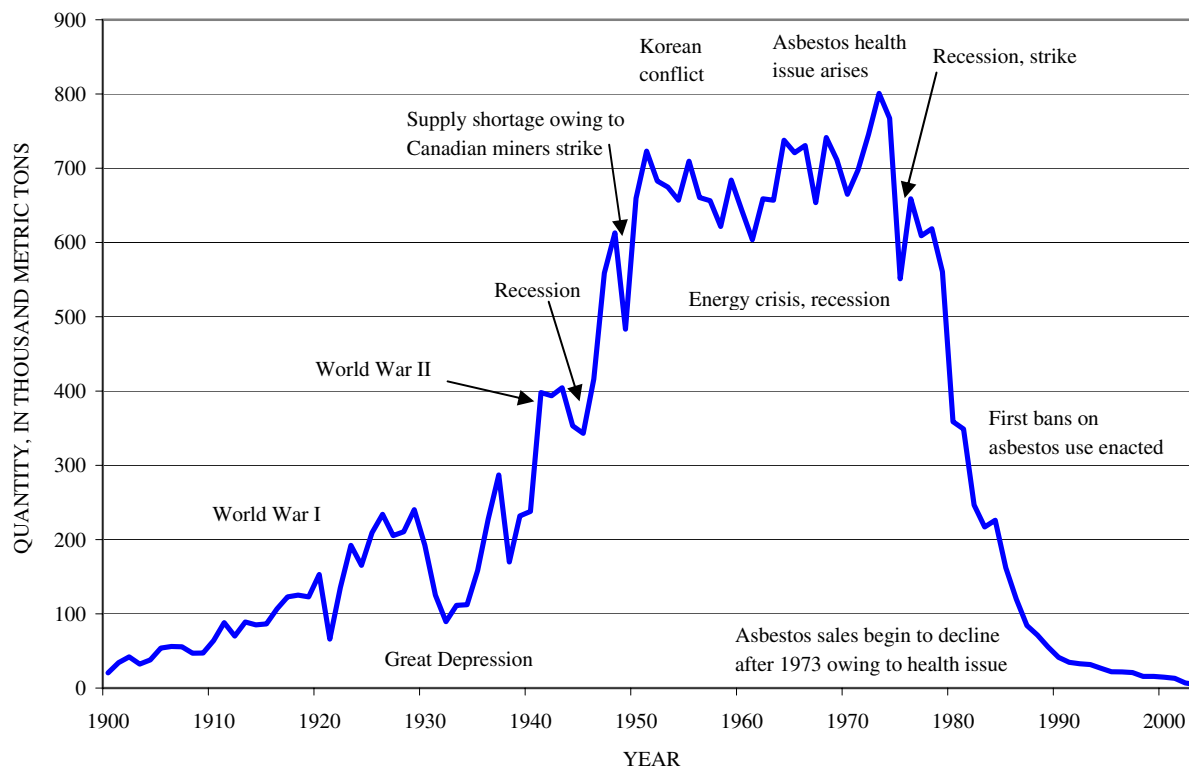

Figure 3. U.S. apparent consumption of asbestos from 1900 to 2003. About 282,000 metric tons (t) of amosite, 90,000 t of anthophyllite, 25.6 million metric tons of chrysotile, and 365,000 t of crocidolite were consumed in the United States between 1900 and 2003. Sources: Buckingham and Virta, 2002; Virta, 2003b, p. 21-22.

## 4 Mineral Commodity Profiles—Asbestos

insulating electrical wiring; spray-on asbestos products for protecting steel girders in buildings; reinforcing, heat-resistant fillers for plastics; fire-resistant roofing materials, such as asbestos felts, shingles, and asphalt roofing compounds; inexpensive, durable, and dimensionally stable flooring products, such as vinyl asbestos tile and flooring felts; heat- and acid-resistant gaskets and packings; thermal insulation on boiler systems for buildings and homes; fireproof suits for firefighters; reinforcement for plasters and caulking compounds; and filler and reinforcer in paints and asphalt road surfacing (Anonymous, 1953, p. 9-15; Rosato, 1959, p. 22-27; Cossette and Delvaux, 1979, p. 104-107; Roskill Information Services Ltd., 1990, p. 99-126).

The onset of World War II resulted in declining production in most regions of the globe except Canada, South Africa, and the United States. While asbestos production and use declined worldwide, U.S. war demands absorbed much of the increased production from Canada, South Africa, and the United States. U.S. consumption increased to about 77 percent of world production in 1942 from 41 percent in 1934. However, postwar reconstruction and recovering economies again resulted in increased world demand for asbestos, and production of asbestos increased to supply these demands.

By 1958, it was reported that asbestos was used in about 3,000 applications (Quebec Asbestos Information Service, 1959). The myriad uses of asbestos resulted in a continued increase in demand for asbestos. Peak demand for asbestos

was achieved in the mid 1970s, when about 25 countries were producing 5 Mt of asbestos, and about 85 countries were manufacturing asbestos products (Virta, 2003, p. 15, 40-41).

In the United States and many European countries, demand for asbestos began to decline in the 1970s (Alleman and Mossman, 1997). First, the asbestos industry had penetrated most large-volume markets by 1970 and probably had reached a mature stage, where sales to markets tend to level off. A more important factor, however, was the health issue. While health research from the 1920s to 1940s demonstrated an association between exposure to asbestos and asbestosis, it wasn't until the late 1950s and early 1960s that an association between asbestos exposure and lung cancer was conclusively demonstrated (Selikoff and Lee, 1978, p. 26-28; Gross and Braun, 1984, p. 58-60; Skinner, Ross, and Frondel, 1988, p. 104; U.S. Department of Health and Human Services, 1992, p. 14-17). Additional studies through the 1970s further confirmed the association (Skinner, Ross, and Frondel, 1988, p. 105-107). With this finding, public opposition to the use of asbestos arose and has strengthened since then.

Liability also became a major issue for producers and manufacturers. In the United States, asbestos producers and manufacturers of asbestos products began facing an increasing number of large class action lawsuits filed on behalf of those suffering from asbestos-related diseases (Virta, 2002b, p. 11). This liability contributed to a shift by product manufacturers to asbestos substitutes, such as aramid fiber, cellulose

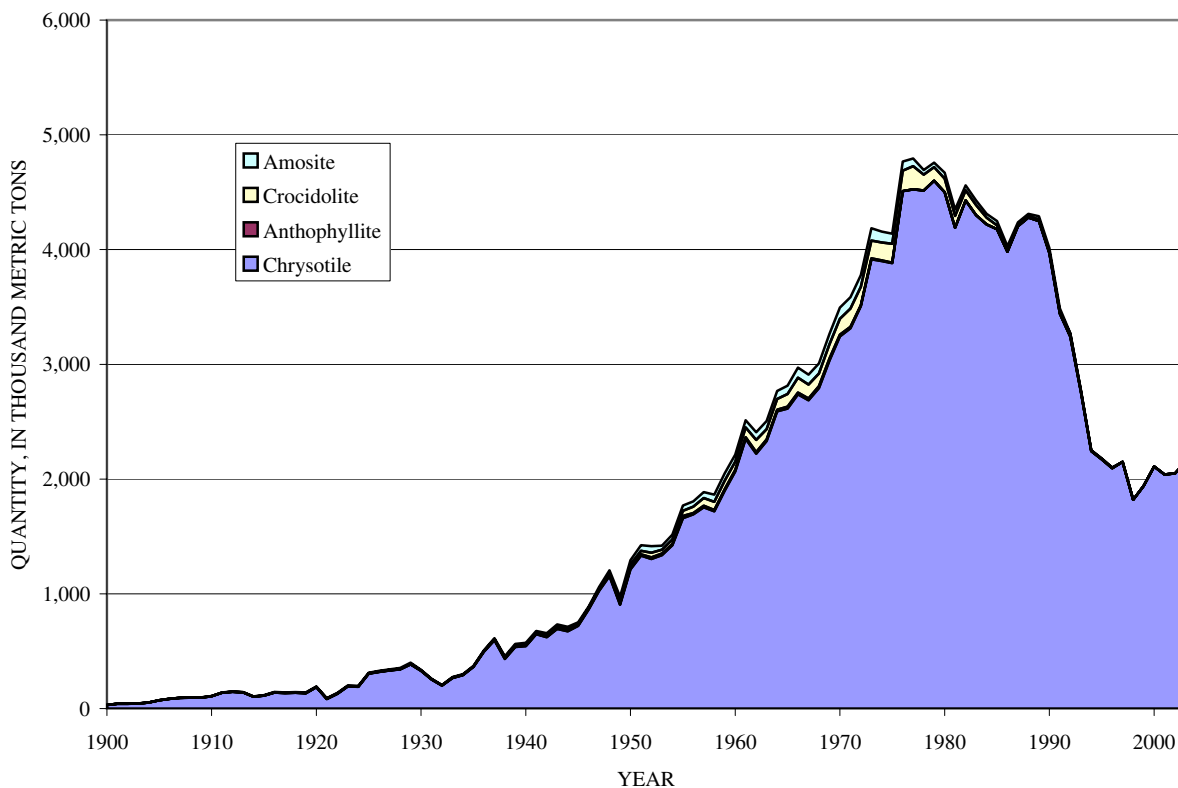

**Figure 4.** World production of asbestos, by type, from 1900 to 2003. About 2.81 million metric tons (Mt) of amosite, 460,000 metric tons of anthophyllite, 173 Mt of chrysotile, and 3.92 Mt of crocidolite were produced from 1900 to 2003. Sources: U.S. Geological Survey, 1901-1921, 1924-1932, 1997-2005; U.S. Bureau of Mines, 1934-1996.

fiber, polyvinyl alcohol fibers, or wollastonite or alternative products, such as aluminum siding, ductile iron and polyvinyl chloride pipe, fiberglass shingles, graphite packings, metallic disk brake pads, and mineral wool insulation (Hodgson, 1989, p. 1-2; Pye, 1989a, p. 342-370; 1989b, p. 67-69; Virta, 1994). Similar movements toward the use of nonasbestos products followed in most countries, particularly those in Western Europe. As a result, U.S consumption declined to 4,650 t in 2003 from a peak of 800,000 t in 1973. World consumption also declined to an estimated 2.15 Mt in 2003 from a peak of about 4.36 Mt (which probably included sales of serpentinite tailings from processing asbestos ore) in the 1975 to 1977 timeframe (Virta, 2003, p. 40-41; 2005, p. 8.6).

Between 1900 and 2003, product manufacturing required about 181 Mt of asbestos. Chrysotile accounted for an estimated 173 Mt of this total. About 2.81 Mt of amosite and 3.92 Mt of crocidolite were mined to satisfy industry needs during this same time period. Most of the amosite and crocidolite was mined in South Africa. Small amounts of crocidolite also were mined in Australia and Bolivia. An estimated 460,000 t of anthophyllite was used between 1900 and 2003. Most of the anthophyllite was mined in Finland and the United States.

Small but unknown amounts of actinolite asbestos, anthophyllite asbestos, and tremolite asbestos have been produced in such countries as Bulgaria, India, Italy, Pakistan, Romania, South Africa, Turkey, and perhaps others since 1900 (Virta, 2003, p. 26). Historical production of asbestos, by type, is shown in figure 4.

The leading source of this asbestos for most of the 20th century was Canada. Before 1950, Canadian mines satisfied more than half of the world's demand for asbestos. By 1975, however, the combined production of Kazakhstan and Russia surpassed that of Canada. Around the time of peak world production and consumption in the middle 1970s, the major producing countries were, in decreasing order by tonnage, Kazakhstan and Russia (combined), Canada, South Africa, Zimbabwe, China, Italy, Brazil, the United States, and Australia. Canada, Kazakhstan, and Russia accounted for about 71 percent of world production.

The 1980s and 1990s brought about many changes in the world supply pattern. Canadian production declined as asbestos fell into disfavor in Europe and the United States. Demand in China increased, boosting the country's output of asbestos and prompting greater imports. In Brazil, an asbes-

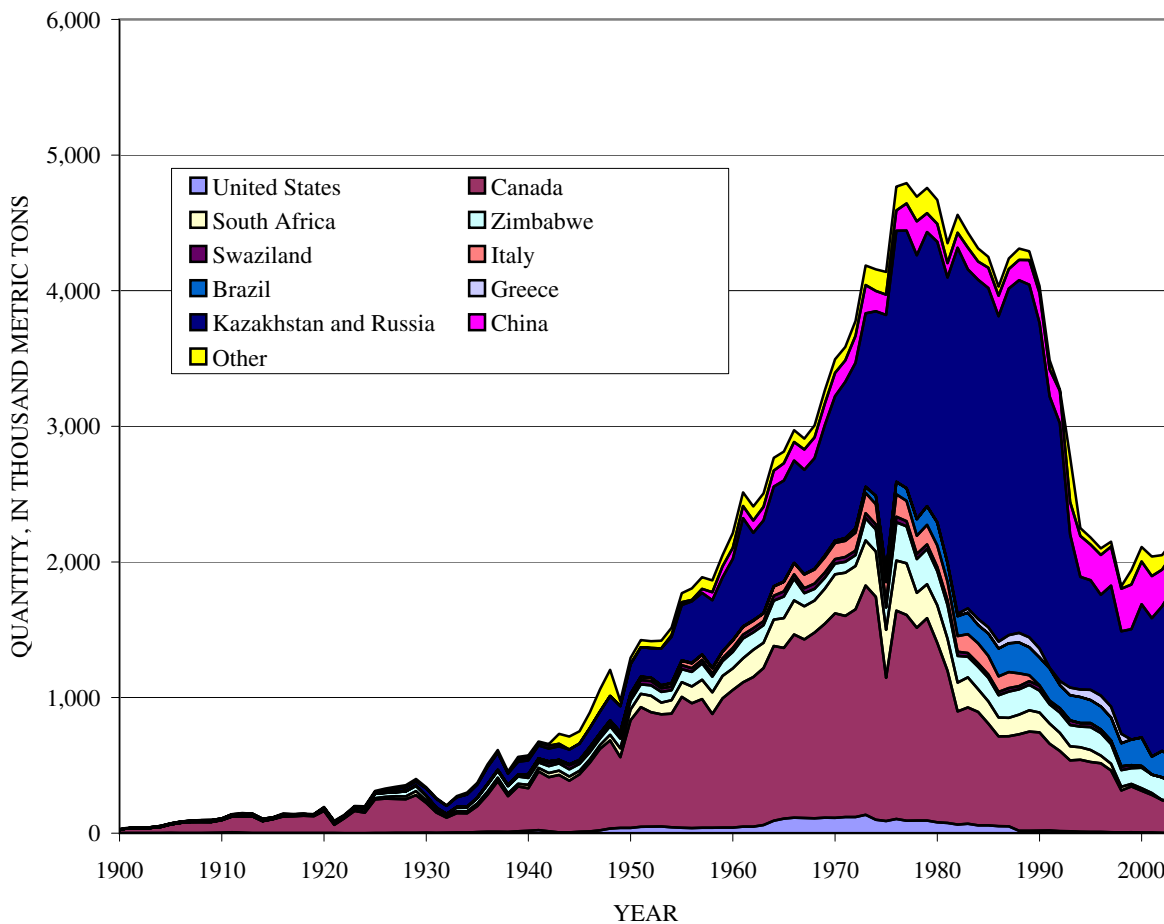

**Figure 5.** World production of asbestos, by country, from 1900 to 2003. Total production from 1900 to 2003 was Brazil, 5.12 million metric tons (Mt); Canada, 61.2 Mt; China, 8.57 Mt; Greece, 0.92 Mt; Italy, 3.87 Mt; Kazakhstan and Russia (combined), 70.4 Mt; South Africa, 9.93 Mt; Swaziland, 1.80 Mt; the United States, 3.29 Mt; Zimbabwe, 9.14 Mt; and other countries combined, 6.42 Mt. Sources: Virta, 2003b, p. 25-27; 2004b.

## 6 Mineral Commodity Profiles—Asbestos

**Table 2.** World asbestos production, all types

[In metric tons. °, estimated; NA, not available; W, withheld to avoid disclosing company proprietary data; --, zero. Data from U.S. Bureau of Mines, 1934-1996; U.S. Geological Survey, 1901-1921; U.S. Geological Survey, 1924-1932; Virta, 1997-2005]

Year	United States	Australia	Brazil	Canada	China	Kazakhstan and Russia	Greece	Italy	South Africa	Swazi-land	Zimba-bwe	Other	World production <sup>1</sup>
1900	956	--	--	26,436	NA	NA	--	NA	158	--	NA	3,937	31,487
1901	678	--	--	36,484	NA	NA	--	NA	90	--	NA	4,517	41,769
1902	912	--	--	36,665	NA	NA	--	NA	41	--	NA	4,506	42,124
1903	805	--	--	37,809	NA	5,248	--	NA	277	--	NA	16	44,155
1904	1,343	--	--	43,967	NA	7,479	--	NA	373	--	NA	186	53,348
1905	2,820	--	--	61,927	NA	7,244	--	NA	455	--	NA	22	72,468
1906	1,538	--	--	74,557	NA	7,997	--	NA	474	--	NA	1,223	85,789
1907	592	--	--	82,033	NA	8,837	--	NA	548	--	NA	1,683	93,693
1908	849	--	--	82,348	NA	10,827	--	NA	1,149	--	NA	1,647	96,820
1909	2,799	--	--	79,197	NA	13,294	--	NA	1,519	--	NA	405	97,214
1910	3,350	--	--	92,728	NA	11,070	--	NA	1,346	--	NA	611	109,105
1911	6,898	--	--	115,588	NA	15,487	--	167	1,149	--	NA	1,191	140,479
1912	3,994	--	--	119,077	NA	16,455	--	169	2,115	--	NA	6,574	148,383
1913	905	--	--	124,239	NA	17,494	--	175	873	--	263	93	144,042
1914	1,026	--	--	87,580	NA	15,691	--	171	1,079	--	442	11	106,000
1915	1,424	--	--	100,826	NA	9,779	--	163	1,940	--	1,823	1,045	117,000
1916	1,217	37	--	121,053	NA	8,192	--	82	4,224	--	5,586	4,875	145,229
1917	1,385	280	--	122,925	378	--	--	85	5,643	--	8,675	1,909	141,000
1918	825	2,900	--	128,331	243	NA	--	60	3,333	--	7,778	3,430	144,000
1919	955	106	--	124,070	69	NA	--	98	3,567	--	8,889	2,647	140,295
1920	1,356	839	--	162,038	5	1,478	--	165	6,452	--	17,076	4,430	193,000
1921	754	1,201	--	61,083	169	2,604	--	420	4,647	--	17,716	3,707	91,100
1922	61	754	--	109,128	197	3,215	--	540	3,982	--	12,926	5,951	136,000
1923	206	331	--	164,014	128	4,780	--	1,538	7,614	--	18,474	4,246	201,000
1924	272	79	--	150,768	127	8,456	--	2,160	6,569	--	23,715	5,933	198,000
1925	1,141	51	--	248,136	213	12,330	--	2,105	9,224	--	31,161	7,690	312,000
1926	1,232	112	--	253,469	NA	18,334	--	2,900	12,789	--	30,249	10,027	329,000
1927	2,704	11	--	249,273	241	21,156	--	3,840	20,106	--	30,097	14,583	342,000
1928	2,031	12	--	247,690	NA	26,492	NA	4,950	21,821	--	36,251	14,765	354,000
1929	2,862	260	--	277,647	277	29,520	NA	2,847	29,971	--	38,677	17,913	399,714
1930	3,848	144	--	219,641	315	54,083	2	851	17,491	--	34,260	7,572	338,063
1931	2,928	130	--	149,047	264	64,674	10	632	14,221	--	21,810	5,849	259,435
1932	3,229	132	112	111,562	250	59,800	9	1,284	10,950	5	14,303	3,895	205,399
1933	4,305	283	99	143,667	239	71,700	14	3,267	14,412	NA	27,381	8,991	274,075
1934	4,615	157	NA	141,502	290	92,200	30	2,252	15,960	NA	29,224	13,140	299,213
1935	8,092	179	NA	190,931	70	95,500	2	4,320	20,600	NA	38,644	13,871	372,030
1936	10,037	243	NA	273,322	69	125,117	1	6,113	22,894	NA	51,116	18,291	506,960
1937	10,958	168	NA	371,967	NA	125,000	2	6,393	25,975	NA	51,722	20,925	612,942
1938	9,471	176	120	262,894	700	86,000	85	6,860	21,025	NA	53,352	14,839	455,346
1939	14,024	325	45	330,642	18,015	°95,000	2	6,765	20,003	7,233	52,900	18,388	563,017
1940	18,198	498	500	313,504	20,015	°102,000	NA	8,271	24,850	18,873	50,809	17,098	573,728
1941	22,127	256	13	433,492	20,515	°95,000	NA	10,766	25,655	19,166	40,037	9,786	676,557
1942	14,044	334	NA	398,669	20,615	°95,000	NA	11,695	31,351	23,219	50,623	11,298	656,514
1943	5,456	699	NA	423,831	20,000	°100,000	NA	8,459	32,347	17,179	52,749	72,979	733,000

**Table 2.** World asbestos production, all types—Continued

[In metric tons. <sup>e</sup>, estimated; NA, not available; W, withheld to avoid disclosing company proprietary data; --, zero. Data from U.S. Bureau of Mines, 1934-1996; U.S. Geological Survey, 1901-1921; U.S. Geological Survey, 1924-1932; Virta, 1997-2005]

Year	United States	Australia	Brazil	Canada	China	Kazakhstan and Russia	Greece	Italy	South Africa	Swazi-land	Zimba-bwe	Other	World production <sup>1</sup>
1944	6,048	3,022	NA	380,349	NA	<sup>e</sup> 110,000	NA	7,238	31,372	29,628	52,882	94,483	712,000
1945	11,091	4,071	2,723	423,559	NA	<sup>e</sup> 120,000	NA	5,222	25,597	21,243	51,068	91,497	752,000
1946	12,769	629	1,214	506,371	NA	<sup>e</sup> 140,000	4	8,814	25,597	29,155	50,686	115,390	890,000
1947	21,804	1399	2,631	600,391	NA	<sup>e</sup> 160,000	40	10,719	27,344	25,360	49,073	162,638	1,060,000
1948	33,649	1,348	1,499	650,239	NA	<sup>e</sup> 180,000	9	13,044	41,490	29,421	62,502	193,147	1,205,000
1949	39,360	1,671	1,415	521,543	NA	191,000	9	15,877	64,335	30,814	72,246	38,401	975,000
1950	38,496	1,811	844	794,100	NA	217,725	30	21,433	79,301	29,635	64,888	46,289	1,292,740
1951	46,852	2865	1,321	882,871	NA	217,725	34	22,612	97,403	31,719	70,456	53,291	1,424,282
1952	48,865	4,546	1,305	843,083	NA	217,725	24	23,938	121,417	31,542	76,961	50,351	1,415,210
1953	49,402	5,567	1,231	826,651	NA	272,156	1	20,397	86,017	27,309	79,597	56,985	1,419,746
1954	43,201	4,789	2,555	838,345	13,608	340,195	2	23,784	99,020	27,344	72,542	54,405	1,515,000
1955	40,431	5,437	2,834	965,066	20,865	408,234	3	32,101	108,421	29,586	95,491	65,980	1,769,012
1956	37,478	8,808	3,392	920,112	10,886	453,593	5	35,785	123,849	27,102	107,932	85,165	1,805,300
1957	39,601	13,308	2,408	948,994	29,937	453,593	8	36,615	142,858	27,875	119,863	85,195	1,886,947
1958	39,897	14,125	3,462	839,447	58,967	498,952	--	38,555	159,342	22,916	115,319	87,409	1,864,267
1959	41,240	16,216	3,357	952,934	81,647	544,311	--	47,662	165,475	22,504	108,591	82,520	2,050,240
1960	41,026	14,164	3,538	1,014,647	81,647	598,743	--	54,914	159,540	29,054	121,529	108,895	2,213,533
1961	47,912	15,192	3,084	1,064,759	90,719	798,324	--	56,975	176,687	27,934	146,613	99,899	2,512,905
1962	48,253	16,707	4,445	1,102,969	90,719	644,102	--	55,211	200,762	29,783	128,999	103,335	2,408,578
1963	60,234	12,133	1,306	1,157,143	99,790	684,925	67	57,167	186,648	30,255	129,053	98,860	2,505,449
1964	91,709	12,288	1,297	1,288,069	117,934	734,821	63	68,556	195,582	36,162	139,210	94,330	2,767,733
1965	107,297	10,493	1,092	1,259,366	127,006	745,000	--	71,928	218,407	37,089	159,802	87,097	2,814,085
1966	114,240	12,217	1,651	1,350,850	136,078	755,000	--	82,325	250,925	32,788	160,003	87,411	2,971,271
1967	111,755	666	2,256	1,317,328	149,686	769,000	--	101,062	243,563	36,427	97,302	81,201	2,909,580
1968	109,488	812	4,360	1,369,578	154,222	816,467	--	103,437	236,350	38,960	86,184	88,550	3,007,596
1969	114,247	838	12,701	1,430,520	158,758	961,617	--	112,526	258,174	39,079	79,832	97,619	3,265,073
1970	113,683	739	16,329	1,507,420	172,365	1,065,943	--	118,536	287,416	33,057	79,832	99,219	3,493,800
1971	118,734	756	19,958	1,482,867	158,758	1,152,126	--	119,568	319,296	35,484	79,834	98,074	3,584,698
1972	119,443	16,838	32,883	1,530,469	199,581	1,220,165	--	131,272	320,628	33,400	79,834	109,553	3,777,227
1973	136,111	43,529	44,868	1,690,065	208,653	1,279,132	--	150,256	332,650	36,900	163,293	143,572	4,185,499
1974	98,966	30,863	61,871	1,643,790	149,686	1,360,779	--	148,099	333,272	37,917	163,293	159,344	4,157,016
1975	89,498	47,922	73,978	1,055,668	149,686	1,896,018	--	146,995	354,710	41,219	163,293	167,692	4,138,756
1976	104,873	60,642	92,703	1,536,091	150,000	1,850,000	NA	164,788	369,840	41,847	281,000	175,929	4,767,071
1977	92,256	50,601	92,773	1,517,360	200,000	1,900,000	NA	149,327	380,164	38,046	273,194	150,331	4,793,451
1978	93,097	62,744	122,815	1,421,808	250,000	1,945,000	NA	135,402	257,325	36,957	248,861	181,952	4,693,217
1979	93,354	79,721	138,457	1,492,719	140,000	2,020,000	NA	143,931	249,187	34,294	259,891	186,189	4,758,022
1980	80,079	92,418	169,173	1,323,000	131,700	2,070,000	NA	157,794	276,734	32,833	250,949	177,038	4,669,300
1981	75,618	45,494	138,417	1,121,845	106,000	2,105,000	457	137,086	235,943	35,264	247,600	146,236	4,349,466
1982	63,515	18,587	145,998	834,249	110,000	2,700,000	17,016	116,410	211,860	30,145	197,682	132,620	4,559,495
1983	69,906	3,909	158,885	857,504	160,000	2,500,000	31,811	139,054	221,111	26,287	153,221	111,088	4,428,867
1984	57,422	--	134,788	836,654	135,000	2,500,000	45,376	147,272	167,389	25,832	165,385	96,724	4,311,842
1985	57,457	--	165,446	750,190	150,000	2,500,000	46,811	136,006	164,247	25,130	173,580	80,121	4,248,988
1986	51,437	--	204,460	662,381	150,712	2,400,000	51,355	115,208	138,862	24,475	163,984	66,490	4,029,364
1987	50,600	--	212,807	664,546	144,673	2,554,600	60,134	118,352	135,074	25,925	193,295	77,116	4,237,122



## 8 Mineral Commodity Profiles—Asbestos

**Table 2.** World asbestos production, all types—Continued

[In metric tons. °, estimated; NA, not available; W, withheld to avoid disclosing company proprietary data; --, zero. Data from U.S. Bureau of Mines, 1934-1996; U.S. Geological Survey, 1901-1921; U.S. Geological Survey, 1924-1932; Virta, 1997-2005]

Year	United States	Australia	Brazil	Canada	China	Kazakhstan and Russia	Greece	Italy	South Africa	Swaziland	Zimbabwe	Other	World production <sup>1</sup>
1988	18,233	--	227,653	710,357	150,000	2,600,000	71,114	94,549	145,678	22,804	186,581	84,020	4,310,989
1989	17,427	--	206,195	732,192	181,000	2,600,000	73,300	44,348	156,594	27,291	187,006	65,011	4,290,364
1990	W	--	205,000	725,000	221,000	2,400,000	66,000	3,860	146,000	35,900	161,000	50,495	4,014,255
1991	20,061	--	237,000	639,000	200,000	2,000,000	4,730	15,000	148,525	13,900	142,000	67,735	3,487,951
1992	15,573	--	170,000	590,641	240,000	1,900,000	30,000	--	133,268	32,301	150,158	9,549	3,271,490
1993	13,704	--	185,000	522,967	240,000	1,130,000	56,945	--	103,994	33,860	156,881	331,844	2,775,195
1994	10,100	--	192,050	531,000	303,000	830,000	55,502	--	92,130	26,720	151,905	57,593	2,250,000
1995	9,000	--	170,000	515,587	263,000	808,400	76,003	--	88,642	28,570	169,256	51,542	2,180,000
1996	9,550	--	170,000	506,000	293,000	743,700	80,213	--	57,120	26,014	165,494	48,909	2,100,000
1997	6,890	--	170,000	455,000	288,000	892,000	63,294	--	49,986	25,888	144,959	37,277	2,150,000
1998	5,760	--	198,332	309,000	314,000	755,400	50,000	--	27,195	27,693	123,295	149,325	1,820,000
1999	7,190	--	188,386	337,366	229,000	814,300	--	--	18,836	22,912	115,000	107,010	1,940,000
2000	5,260	--	209,332	307,000	315,000	983,200	--	--	18,782	12,690	152,000	108,426	2,110,000
2001	5,260	--	132,695	277,000	310,000	1,021,300	--	--	13,393	--	136,327	144,025	2,040,000
2002	2,720	--	194,732	241,000	270,000	1,066,100	--	--	--	--	168,000	107,448	2,050,000
2003	--	--	195,000	241,000	260,000	1,231,000	--	--	--	--	130,000	93,000	2,150,000
Total	3,290,000	751,000	5,146,794	61,203,777	8,569,684	69,174,901	881,000	3,860,000	9,932,589	1,796,224	9,135,235	6,549,533	174,000,000

<sup>1</sup>Some data are rounded to no more than three significant digits, may not add to totals shown.

tos manufacturing industry developed that prompted expansion of asbestos production there. Between 1980 and 2003, many lesser but still significant producing countries, including Australia, Greece, Italy, Swaziland, and the United States, had ceased production. As a result of these changes, Russia was the leading producer in 2003, followed by Kazakhstan, China, Canada, Brazil, and Zimbabwe. Kazakhstan and Russia accounted for 48 percent of world production (Virta, 2004a; fig. 5; table 2).

## Chemical Identity

### Serpentine Asbestos

Chrysotile is the only commercial asbestos mineral that belongs to the serpentine group, which consists of hydrated magnesium silicates (table 3). Moderate amounts of aluminum may substitute for silicon and moderate amounts of iron may substitute magnesium in the crystal structure. Small amounts of calcium oxide (CaO), chromium oxide (Cr<sub>2</sub>O<sub>3</sub>), cobalt oxide (CoO), manganous oxide (MnO), nickel oxide (NiO), potassium oxide, and sodium oxide also have been detected in chrysotile samples (Sinclair, 1959, p. 9-11; Skinner, Ross, and Frondel, 1988, p. 32).

### Amphibole Asbestos

The other five commercial asbestos minerals belong to the amphibole mineral group, which are hydrated silicate minerals. Because of the nature of the crystalline structure of amphiboles, there may be considerable substitution of elements in the crystal lattice. While there are more than 70 chemically distinct amphibole end-members, only 5 have been used commercially as asbestos. These are actinolite asbestos, amosite (cummingtonite-grunerite asbestos), anthophyllite

**Table 3.** Types of asbestos

[Information from Leake and others, 1997, p. 222; Skinner, Ross, and Frondel, 1988, p. 29, 36]

Type	End-member formula
Chrysotile, hydrated magnesium silicate	Mg <sub>3</sub> Si <sub>2</sub> O <sub>5</sub> (OH) <sub>4</sub> .
Crocidolite, complex sodium iron silicate, (riebeckite) commonly called blue asbestos	Na <sub>2</sub> (Fe <sup>+2</sup> <sub>3</sub> Fe <sup>+3</sup> <sub>2</sub> )Si <sub>8</sub> O <sub>22</sub> (OH) <sub>2</sub> .
Amosite (grunerite asbestos), iron silicate with varying amounts of magnesium	Fe <sup>2+</sup> <sub>7</sub> Si <sub>8</sub> O <sub>22</sub> (OH) <sub>2</sub> .
Anthophyllite asbestos, magnesium silicate with varying amounts of iron	Mg <sub>7</sub> Si <sub>8</sub> O <sub>22</sub> (OH) <sub>2</sub> .
Tremolite asbestos, calcium magnesium silicate	Ca <sub>2</sub> Mg <sub>5</sub> Si <sub>8</sub> O <sub>22</sub> (OH) <sub>2</sub> .
Actinolite asbestos, calcium magnesium silicate with varying amounts of iron	Ca <sub>2</sub> (Mg,Fe <sup>+2</sup> ) <sub>5</sub> Si <sub>8</sub> O <sub>22</sub> (OH) <sub>2</sub> .

asbestos, crocidolite (riebeckite asbestos), and tremolite asbestos. Actinolite and tremolite are rich in calcium, iron, and/or magnesium; anthophyllite is rich in magnesium; amosite is rich in iron; and crocidolite is rich in iron and sodium (table 3). A considerable amount of substitution of other elements for calcium, ferric iron, ferrous iron, magnesium, silicon, and sodium can take place in these minerals (Sinclair, 1959, p. 19-31; Skinner, Ross, and Frondel, 1988, p. 37; Leake and others, 1997, p. 221).

## Commercial Forms, Grades, Shapes, and Specifications

### Amosite, Chrysotile, and Crocidolite.

Chrysotile has been the variety of asbestos used most commonly by industry. Chrysotile occurs in larger quantities, and its commercial deposits are more widely distributed than those of amosite, anthophyllite asbestos, crocidolite, and tremolite asbestos. Chrysotile usually has soft fibers that are less harsh than the amphibole varieties of asbestos and also has other properties that make it well suited for most asbestos applications. Chrysotile accounted for about 96 percent of world asbestos production and consumption between 1900 and 2003. Crocidolite accounted for 2.2 percent, amosite for 1.6 percent, and anthophyllite and tremolite asbestos varieties for less than 1 percent of production and consumption (fig. 4).

### Grades, Shapes, and Specifications

Asbestos minerals are graded primarily by length. The Quebec Asbestos Mining Association (QAMA) developed a method for grading chrysotile that has been widely used since its development (Asbestos Textile Institute and Quebec Asbestos Mining Association, 1975, p. A1/1-C5/11). This test is performed on the Quebec standard (QS) testing machine, which consists of a stack of three sieve boxes with 12.7 millimeter (mm) (½ inch), 4-mesh-per-inch, and 10-mesh-per-inch screens, stacked top to bottom, and a bottom box serving as a pan. Exactly 454 grams (16 avoirdupois ounces) of asbestos fiber is placed in the top sieve, and the stack of sieves is shaken using a rotary shaker. After shaking, the weight on each sieve and in the bottom collection pan is measured and used to designate the chrysotile grade. Variations of the QAMA method have been used depending on the source of the chrysotile being mined (tables 4-7).

Other properties that may be tested are air permeability, color, compressibility and recovery, drainage rate, grit content, loose density, kerosene retention, magnetic properties, moisture content, resin sorption, soluble chlorides, surface area, tensile strength, and wet volume (Sinclair, 1959, p. 290-291; Asbestos Textile Institute and Quebec Asbestos Mining

**Table 4.** Quebec asbestos grading system<sup>1</sup>

[In avoirdupois ounces. --, zero. Information from Bowles, 1955, p. 84; Sinclair, 1959, p. 256; American Textile Institute and Quebec Asbestos Mining Association, 1975]

	Guaranteed minimum shipping test			
	½ inch	4 mesh	10 mesh	pan
Group No. 1: No. 1 crude (cross fiber veins having ¾-inch staple and longer).				
Group No. 2: No. 2 crude (cross fiber veins having ¾-inch staple up to ¾-inches; run-of-mine crude consists of unsorted crudes; sundry crudes consist of crudes other than above specified).				
Group No. 3 (commonly referred to as textile or shipping fibers):				
3F	10.5	3.9	1.3	0.3
3K	7	7	1.5	0.5
3R	4	7	4	1
3T	2	8	4	2
3Z	1	9	4	2
Group No. 4 (commonly referred to as asbestos cement fiber):				
4A	--	8	6	2
4D	--	7	6	3
4H	--	5	8	3
4K	--	4	9	3
4M	--	4	8	4
4R	--	3	9	4
4T	--	2	10	4
4Z	--	1.5	9.5	5
Group No. 5 (often referred to as paper stock grades):				
5D	--	0.5	10.5	5
5K	--	--	12	4
5M	--	--	11	5
5R	--	--	10	6
5Z	--	--	8.6	7.4
Group No. 6 (paper and shingle fibers):				
6D	--	--	7	9
6F	--	--	6	10
Group No. 7 (shorts and floats):				
7D	--	--	5	11
7F	--	--	4	12
7H	--	--	3	13
7K	--	--	2	14
7M	--	--	1	15
7R	--	--	0	16
7T	--	--	0	16
7RF and 7TF floats	--	--	0	16
7W	--	--	0	16



**Table 4.** Quebec asbestos grading system—Continued<sup>1</sup>

[In avoirdupois ounces. --, zero. Information from Bowles, 1955, p. 84; Sinclair, 1959, p. 256; American Textile Institute and Quebec Asbestos Mining Association, 1975]

	Guaranteed minimum shipping test				
	½ inch	4 mesh	10 mesh	pan	
Group Nos. 8 and ( sands and gravels)					
8S (minimum 50 pounds per cubic foot)	--	--	--		16
8T (minimum 75 pounds per cubic foot)	--	--	--		16
9T (more than 75 pounds per cubic foot)	--	--	--		16

<sup>1</sup>As of 2005, the grading standards have not been converted to the metric system.

**Table 5.** Grades for milled chrysotile from Zimbabwe

[do, ditto; QAMA, Quebec Asbestos Mining Association. Information from Sinclair, 1959, p. 258]

Grade	Properties
C and G/1	High-grade textile (equal to QAMA group 2).
C and G/2	High-grade textile (equal to QAMA group 3).
C and G/3	Shingle stock.
C and G/4	do.
VRA/2	Similar to C and G/2.
VRA/3	Similar to C and G/3.
VRA/4	Similar to C and G/4.

**Table 6.** Grades for milled chrysotile from Swaziland

[Information from Sinclair, 1959, p. 258]

Grade	Properties
HVL/1	Long spinning fiber.
HVL/2	Short spinning fiber.
HVL/3	Similar to C and G/3.
HVL/3XX	Similar to C and G/4.

**Table 7.** Classification of chrysotile in Russia

[do, ditto; QAMA, Quebec Asbestos Mining Association. Information from Bowles, 1959, p. 26]

Grade <sup>1</sup>	Type	Properties
AA	Crude	More than 18 millimeters.
O-1	Textile	Equal to QAMA 3F or 3K.
O-2	do	Equal to QAMA 3R.
I-2	do	Equal to QAMA 3Z.
G-3	do	do.
O-3	Shingle	Equal to QAMA 4H.

**Table 7.** Classification of chrysotile in Russia—Continued

[do, ditto; QAMA, Quebec Asbestos Mining Association. Information from Bowles, 1959, p. 26]

Grade <sup>1</sup>	Type	Properties
O-4	Shingle	Equal to QAMA 4Z.
I-4	do	Equal to QAMA 4R.
G-4	do	Equal to QAMA 4Z.
WS	do	Not specified.
R-5	Paper	Equal to QAMA 6D.
I-5	do	Equal to QAMA 6D plus.
S-4	do	Equal to QAMA 5DO.
R-6	Shorts	Not specified.
I-6	do	do.
6-A	do	do.

<sup>1</sup>Grades S-4 and WS not completely opened fiber; I grades soft but not completely open; G grades contain more unopened crudes; O and R grades contain much hard, crude fiber.

Associaton, 1975, p. D1/1-G10/1; Cossette and Delvaux, 1979, p. 96-104). These test methods can be used to a limited extent for amosite. Crocidolite is harsher and has longer fibers than chrysotile so the QAMA tests are not particularly useful. Other tests were developed to grade amosite and crocidolite, although visual methods and trial production runs were probably most useful for crocidolite (Cape Asbestos Fibres Ltd., undated, p. 1 • 1/2; Sinclair, 1959, p. 259-261; Cossette and Delvaux, 1979, p. 109). Classification schemes used for amosite and crocidolite are listed in tables 8-10.

**Table 8.** Grades for amosite from South Africa

[do, ditto. Information from Bowles, 1959, p. 25]

Grade <sup>1</sup>	Length range	Designation
D3	2 to 6 inches	Long.
D11	0.5 to 2 inches	Medium.
MD	do.	do.
DX	do.	do.
M	do.	do.
S2	0.18 to 1 inch	Shorts.
R	0.12 to 0.5 inches	Residue.
K3	0.5 to 2 inches	Medium.
SK	0.18 to 1 inch	Shorts.
RK	0.12 to 0.5 inches	Residue.
W3	0.5 to 2 inches	Medium.
SW	0.18 to 1 inch	Shorts.
RW	0.12 to 0.5	Residue.
WEG	0.12 to 3 inches	Medium.

<sup>1</sup>Properties such as fiber size distribution, color, and source also factor in grade designation.

**Table 9.** Grades for crocidolite from the Cape region of South Africa

[Information from Sinclair, 1959, p. 260]

Grade	Length range
X	-0.25 inches, milled.
S	0.25 to 0.5 inches, milled.
A	0.5 to 0.75 inches.
B	0.75 to 1.25 inches, hand cobbled.
C	1.25 to 1.75 inches, hand cobbled.
D	1.75 to 2.25 inches, hand cobbled.
E	+2.25 inches, hand cobbled.

**Table 10.** Grades for crocidolite from the Transvaal region of South Africa

[Information from Sinclair, 1959, p. 261]

Grade	Length range
Crude	+1.5 inches, hand cobbled.
TX	+1.5 inches, milled.
T1	0.84 to 1.5 inches, milled.
T2	0.5 to 0.84 inches, milled.
T3	0.25 to 0.5 inches, milled.
T4	-0.25 inches, milled.

## Grade Specifications for Products

Much of the asbestos fiber selection is based on the properties of the final product rather than the fiber itself, so there is flexibility in the fiber selection. In general, the characteristics of fiber products that have been demonstrated to work effectively in trial manufacturing runs are used as the basis for future fiber sales. The following discussion gives examples of criteria for various uses as cited in Virta and Mann (1994, p. 120-121), test procedures published by ASTM International (formerly the American Society for Testing and Materials), and other applications as cited in the discussion.

## Asbestos-Cement Products

Pressure pipe must conform to industry specifications for corrosion (chemical dissolution of the pipe interior), deflection (leakage with slightly misaligned pipes), flexural strength, modulus of rupture, moisture absorption, and pipe flex. Non-pressure pipe is subject to all of the specifications required for pressure pipe except for those applying to hydraulic testing. A/C pipe is produced using group 4, 5, and 6 fiber. In the past, chrysotile was blended with crocidolite to ensure a good modulus of rupture. Crocidolite, however, is no longer used to manufacture A/C pipe owing to health issues.

Specifications for A/C sheet may include color, efflorescence (the formation of crystalline deposits on walls through water evaporation), finish, flexural and impact strength, and water absorption. Freeze-thaw characteristics also may be specified for applications exposed to temperature extremes. A/C sheet usually is manufactured using group 6 fiber (table 4). Formulations for corrugated sheet generally also include some group 5 fiber to improve adhesion of the wet sheet during the forming process. Asbestos improves the strength, stiffness, and toughness of sheet and shingle. Fibers for A/C products have a low loose density, high filtration rates, and high bulk fiber resilience (Rosato, 1959, p. 62-63; Cossette and Delvaux, 1979, p. 107; U.S. Environmental Protection Agency, 1988, p. 14.1, 15.1, 16.1, 17.1; Ciullo, 1996, p. 19).

Drainage is an important consideration with A/C products manufactured using the wet-machine process because it affects production rates. Fast-filtering, harsh fibers are preferred for these products. Amosite was such a fiber, but it is no longer used in the manufacture of A/C products owing to health issues.

Group 6 or a blend of group 6 and 7 fiber can be used to manufacture shingles using a dry process that meet strength or drainage standards.

Other A/C building products may use fiber from groups 4, 5, 6, and 7.

The asbestos content of pipe was in the range of 15 to 25 percent; of sheet, 20 to 50 percent; and of shingle, 10 to 30 percent (Zielhuis, 1977, p. 27; Meylan and others, 1978, p. 111, 137; U.S. Environmental Protection Agency, 1985, p. A1-A2; 1988, p. 14.1, 15.1, 16.1, 17.1). A few asbestos cement products apparently could contain as much as 70 percent asbestos (National Institutes of Health, 1991, p. 19).

## Asbestos Paper and Millboard

Asbestos fiber is mixed with a binder to manufacture millboard and paper products, including electrical insulation, pipe coverings, and roofing felt. Blends of group 3, 4, 5, and 6 fiber are used for board and paper products, depending upon the desired strength and porosity of the paper. The asbestos content improves corrosion properties, fire and heat resistance, and degradation of the product from exposure to moisture (U.S. Environmental Protection Agency, 1988, p. 3.1-3.2, 4.1-4.2, 6.1, 7.1-7.2). Paper and millboard products usually are tested for adhesive bond if multilayer paper and millboard products are used, efflorescence, flexural strength, thermal resistance, and vapor permeability. For electrical insulation, products may be tested for arc resistance, dielectric strength, expansion, flexural strength, hardness, resistance to impact, and water absorption.

Felt sold as pipeline wrap comprises 85 percent asbestos, cellulose fiber, and binder. Millboard is a heavy cardboard-like material that can contain 60 to 95 percent asbestos. Typical formulations use 70 to 80 percent asbestos. Commercial paper for insulation use, including corrugated paper, can contain up to 98 percent asbestos. Rollboard, which consists

of two layers of asbestos paper glued together with sodium silicate, generally comprises 70 to 80 percent asbestos (U.S. Environmental Protection Agency, 1988, p. 3.1-3.2, 4.1-4.2, 6.1). Some insulation products comprised entirely of asbestos, while magnesia-base pipe coverings contained about 15 percent asbestos (Meylan and others, 1978, p. 166; U.S. Environmental Protection Agency, 1985, p. A1-A2). Average asbestos contents of roofing felts were about 85 percent but could approach 95 percent (Meylan and others, 1978, p. 166; U.S. Environmental Protection Agency, 1988, p. 7.1).

## Asphalt Products

Group 7 asbestos fiber is combined with asphalt and/or various solvents to make such products as asphalt caulking components, spray or brush-on roof coatings, and asphalt road pavements. The primary functions of asbestos are to control the flow of asphalt coatings and compounds, improve resistance to cracking and weathering, increase resistance to sag on angled surfaces, and reduce costs (U.S. Environmental Protection Agency, 1988, p. 29.1; Ciullo, 1996, p. 19-20).

In asbestos products, asbestos content ranged from 1 to 5 percent for adhesives and cement, 5 to 12 percent for bituminous coatings, and 10 to 25 percent for roof putties (Meylan and others, 1978, p. 239-241; U.S. Environmental Protection Agency, 1985, p. A1-A2; 1988, p. 29.1, 30.1).

## Caulking Compounds and Nonbituminous Sealants and Coatings

Some caulks are made with group 3 fiber while others are made using shorter, group 7, 8, and 9 fiber and floats. The fiber is combined with various types of resins and other materials to produce soft plastic caulking compound. Asbestos increases the viscosity of the caulks, reduces the sag, and reinforces the matrix (U.S. Environmental Protection Agency, 1988, p. 30.1-30.3). In paints, asbestos controls viscosity and improves film strength. In spackles, it reinforces the matrix and controls viscosity. Asbestos contents ranged from 5 to 25 percent for caulking, glazing, and patching compounds; 3 to 5 percent for spackles; 2 to 10 percent for plasters; 2 to 15 percent for paints; 1 to 5 percent for liquid sealants; and 1 to 5 percent for adhesives and cement (Meylan and others, 1978, p. 240-241; U.S. Environmental Protection Agency, 1985, p. A1-A2; 1988, p. 30.1).

## Friction Materials

Friction products are made with fiber ranging from group 3 spinning grades to the shorter fiber of group 7, with shorter fiber grades 5, 6, and 7 dominating.

In the past, clutch plates were made using asbestos openweave cloth impregnated with resin and bonded to a steel disk. Most are now manufactured by molding onto a packing plate a dry resin-fiber blend under high temperature and high pres-

sure conditions. For the openweave cloth, group 3 fiber was required. The molding process uses group 5, 6, and 7 fiber.

Most automobile brake linings bonded to a steel shoe are made from group 7 fiber in a semiwet extrusion process. Heavy brake blocks for railcars and large vehicles are made using group 5 or 6 fiber. Group 6 and 7 fiber is used in disk brake-pad formulations. Asbestos serves to improve the flexibility of the lining in the uncured state and the tensile strength in both the uncured and cured states, to provide heat resistance, to reduce lining wear, and to reduce costs (U.S. Environmental Protection Agency, 1988, p. 18.1, 19.1, 20.1, 21.1). The brake components that contain asbestos must exhibit uniform friction characteristics at all temperatures and pressures, bond tightly to the matrix, and the fibers must disperse well in the formulation (Hodgson, 1985, p. 191-192; U.S. Environmental Protection Agency, 1988, p. 18.1; Pye, 1989b, p. 139-145; Jacko and Rhee, 1992; Kobayashi, 2002).

Brakes contain 30 to 70 percent asbestos depending on the application (Rosato, 1959, p. 121; Zielhuis, 1977, p. 27; Meylan and others, 1978, p. 79-80; Pye, 1989b, p. 140; National Institutes of Health, 1991, p. 20). Drum brake linings contained as much as 60 percent asbestos, and disc brake pads, 25 to 30 percent (Hodgson, 1985, p. 192). Brake formulations also are different for cars and trucks. The average brake lining composition in cars was 55 percent asbestos in 1968; that of trucks was 33 percent asbestos (Meylan and others, 1978, p. 79).

## Gaskets

Latex asbestos paper made from group 7 fiber can be used for gaskets, but most sheet packing material is formed using a calendaring process. This calendaring process uses the longer fiber from groups 3, 4, or 5 that has been cleaned and opened. The fiber is blended with natural or synthetic rubber, plasticizers, and other ingredients to form dough that is later calendared into sheets of various thicknesses. Group 6 and 7 fiber may also be used to manufacture gaskets. Product specifications cover bending strength, compression strength, and resistance to breakdown by chemicals and heat.

Asbestos content was generally more than 75 percent and often was as high as 100 percent in some packing products (Meylan and others, 1978, p. 218; U.S. Environmental Protection Agency, 1988, p. 27.2, 28.4).

## Plastics

Asbestos, or a combination of asbestos and fiberglass is used to reinforce some structural plastics. In the past, a mat, paper, or cloth of asbestos was used to form laminates with resins, such as furanes, melamines, phenolics, polyesters, and thermosetting silicones. Group 3, 4, 5, and 6 fiber is used as a filler and extender in plastics. Short group 7 fiber and floats also were used as fibrous filler for the production of molded phenolic resin and polyester parts. In these applications,

freedom from abrasive particles was important to minimize die wear. For applications where asbestos is used to improve the tensile strength of plastics, the fibers are opened. Color is important for some applications, and a white fiber is desirable. Asbestos is used to control resin viscosity, provide heat resistance and dimensional stability, improve electrical resistance, heat deflection, tensile strength, and reduce costs (Cossette and Delvaux, 1979, p. 108; Ciullo, 1996, p. 20;).

Phenolic compounds contained 50 to 60 percent asbestos. Plastics comprising other resins may require as little as 5 percent and as much as 70 percent asbestos (Zielhuis, 1977, p. 27; Meylan and others, 1978, p. 257). Vinyl flooring ranged from 8 to 33 percent asbestos content (U.S. Environmental Protection Agency, 1985, p. A1-A2; National Institutes of Health, 1991, p. 20).

## Textiles

Long spinning grades of chrysotile are used to manufacture textiles for various applications. Group 1, 2, and 3 fiber is used for this process. The most important property of textiles is fire resistance (Bradfield, 1977, p. 20). Abrasion resistance and textile strength also are considered when selecting fiber for textile applications. Textiles typically comprise 65 to 100 percent asbestos (Zielhuis, 1977, p. 27).

# Physical, Chemical, and Engineering Properties

## Physical Properties

Asbestos fibers are characterized by flexibility, high tensile strength, large surface area, and resistance to chemical attack and thermal degradation. Some varieties of asbestos can be woven. Each type of asbestos has different physical characteristics, as do the same asbestos types from different deposits (table 11).

Chrysotile is a white, fibrous material. The fibers are extremely thin, and most are soft and flexible enough to be woven. Individual chrysotile fibrils have diameters ranging from 25 to 50 nanometers (nm) (Yada, 1967). Commercial grades of chrysotile have lengths ranging from a fraction of a millimeter to several centimeters (cm), and chrysotile fiber bundles can have lengths up to 5 cm (Badollet, 1951; Selikoff and Lee, 1978, p. 42-44).

Owing to the extremely small diameters of the individual fibrils, tensile strengths measured are of bundles of asbestos fibers rather than individual fibers. Consequently, there is a wide variation in reported values. Tensile strengths of chrysotile fiber bundles between 1.107 and 4.400 million Pascal (MPa) have been reported, making it one of the stronger asbestos types (Sinclair, 1959, p. 287-289; Hodgson, 1986, p. 97).

Chrysotile is heat resistant, and its products are used in high-temperature applications. Chrysotile begins to lose adsorbed water at around 90° C. Dehydroxylation (loss of the hydroxyl in the structure) begins at 640° C and is complete by 810° C. Above 810° C, the chrysotile structure begins to transform into forsterite and silica (Hodgson, 1986, p. 70-72). The fusion temperature for chrysotile is 1,521° C (Badollet, 1951). Chrysotile has an extremely large surface area, about 13 to 18 square meters per gram (m<sup>2</sup>/g) because of its fibrillar structure (Hodgson, 1986, p. 91-94).

Amphibole asbestos fibers generally are harsher and more brittle than those of chrysotile. They also are more resistant to chemical attack, have high filtration rates and greater hardness (4 to 6 on the Mohs scale), and are comparatively long, as much as several inches in length. Their color ranges from white for tremolite to yellowish-brown for amosite and lavender or blue for crocidolite (Badollet, 1951). Tensile strengths range from 303 MPa for a tremolite asbestos from Pakistan to about 3,089 MPa for a crocidolite from South Africa (Sinclair, 1959, p. 287-289; Aveston, 1969; Hodgson, 1986, p. 95-99). All forms of amphibole asbestos withstand temperatures exceeding several hundred degrees without degradation. The fusion temperature for all asbestiform amphiboles exceeds 1,224° C. The resistance to attack by acids and bases ranges from fair for actinolite asbestos to very good for anthophyllite asbestos (Badollet, 1951).

Amphiboles have a surface area of 2 to 9 m<sup>2</sup>/g (Addison, Neal, and White, 1966; Hodgson, 1986, p. 91-94). Amphibole fibers generally are more variable in width and less symmetrical than chrysotile fibrils. Franco and others (1977) examined samples of crocidolite whose fiber widths ranged from 50 to 150 nm, although widths of up to 350 nm also have been reported for other samples (Wylie, 1979). Lengths of fiber bundles up to 8 cm for crocidolite and 30 cm for amosite have been reported (Selikoff and Lee, 1978, p. 42-44).

## Chemical Properties

The ideal compositions of the asbestos minerals (table 3) frequently differ from those observed in deposits. Chrysotile fibers almost always contain mineral impurities. Magnetite is one of the common impurities and accounts for higher than normal iron concentrations. Other impurities may be brucite, calcite, chromite, dolomite, and magnesite (Hodgson, 1986, p. 55). Measured silicon dioxide content of several chrysotile samples varied from 38 to 42 percent; magnesium oxide was 38 to 42 percent; ferrous oxide, 0.5 to 2.03 percent; and ferric oxide 0.10 to 1.6 percent (Hahn-Weinheimer and Hirner, 1975; Skinner, Ross, and Frondel, 1988, p. 32). Hahn-Weinheimer and Hirner (1975) also reported contents of 0.418 percent aluminum oxide, 0.019 percent CaO, 0.004 percent CoO, 0.006 percent Cr<sub>2</sub>O<sub>3</sub>, 0.052 percent MnO, 0.087 percent NiO, 0.002 titanium oxide, and 13.8 percent water cation in chrysotile samples from Newfoundland and Quebec, Canada (table 12).



**14 Mineral Commodity Profiles—Asbestos**
**Table 11.** Properties of asbestos fibers

[Ca, calcium; Fe, iron; Mg, magnesium; Na, sodium; NA, not available. Information from Badollet, 1951]

Property	Actinolite asbestos	Amosite	Anthophyllite asbestos	Chrysotile	Crocidolite	Tremolite asbestos
Structure	Reticulated long prismatic crystals and fibers	Lamellar or coarse to fine fibrous and asbestiform	Lamellar or fibrous asbestiform	Usually highly fibrous fibers, fine and easily separable	Fibrous in ironstones	Long or prismatic and fibrous aggregates
Veining	Slip or mass fiber	Cross fiber	Slip or mass fiber	Cross and slip fibers	Cross fiber	Slip or mass fiber
Essential composition	Ca, Mg, Fe silicate with some water	Fe, Mg silicate with some water	Mg silicate with some iron	Mg silicate with some water	Na, Fe silicate with some water	Ca, Mg silicate with some water
Crystal system	Monoclinic	Monoclinic	Orthorhombic	Monoclinic	Monoclinic	Monoclinic
Color	Greenish	Ash gray or brown	Grayish white, also brown-gray or green	White, gray, green	Lavender blue, metallic blue	Gray-white, greenish, yellowish, bluish
Luster	Silky	Vitreous to pearly	Vitreous to pearly	Silky	Silky to dull	Silky
Hardness	6±	5.5-6.0	5.5-6.0	2.5-4.0	4	5.5
Specific gravity	3.0-3.2	3.1-3.25	2.85-3.1	2.4-2.6	3.2-3.3	2.9-3.2
Optical properties	Biaxial negative extinction inclined	Biaxial positive, extinction parallel	Biaxial positive, extinction parallel	Biaxial positive extinction parallel	Biaxial positive, negative, extinction parallel	Biaxial negative, extinction inclined
Refractive index	1.63± weakly pleochroic	1.64±	1.61±	1.51-1.55	1.7 pleochroic	1.61±
Length	Short to long	2 to 11 inches, varies	Short	Short to long	Short to long	Short to long
Texture	Harsh	Coarse but somewhat pliable	Harsh	Soft to harsh, also silky	Soft to harsh	Generally harsh, sometimes soft
Specific heat, Joules per kilogram per Kelvin	505	449	488	619	468	493
Tensile strength, thousand pascals	6,895 and less	110,316 to 620,528	27,579 and less	551,581 to 689,476	689,476 to 2,068,427	6,895 to 55,158
Temperature at maximum ignition loss	NA	871° to 982° C	982° C	982° C	648° C	982° C
Filtration properties	Medium	Fast	Medium	Slow	Fast	Medium
Electric charge	Negative	Negative	Negative	Positive	Negative	Negative
Fusion point	1,393° C	1,399° C	1,468° C	1,521° C	1,229° C	1,316° C
Spinnability	Poor	Fair	Poor	Very good	Fair	Poor
Resistance to acids and alkalis	Fair	Good	Very good	Poor	Good	Good
Mineral impurities	Lime and iron	Iron	Iron	Iron, chrome, nickel, and lime	Iron	Lime
Flexibility	Poor	Good	Poor	High	Good	Poor
Resistance to heat	NA	Good, brittle at high temperature	Very good	Good, brittle at high temperature	Poor, fuses	Fair to good

**Table 12.** Major-oxide composition of commercial chrysotile samples

[In weight percent. Information from Skinner, Ross, and Frondel, 1988, p. 32]

	Canada	Russia	Zimbabwe	Swaziland
SiO <sub>2</sub>	38.75	39	39.7	39.93
Al <sub>2</sub> O <sub>3</sub>	3.09	4.66	3.17	3.92
Fe <sub>2</sub> O <sub>3</sub>	1.59	0.54	0.27	0.1
FeO	2.03	1.53	0.7	0.45
MnO	0.08	0.11	0.26	0.05
MgO	39.78	38.22	40.3	40.25
CaO	0.89	2.03	1.08	1.02
K <sub>2</sub> O	0.18	0.07	0.05	0.09
Na <sub>2</sub> O	0.1	0.07	0.04	0.09
H <sub>2</sub> O <sup>+</sup>	12.22	11.37	12.17	12.36
H <sub>2</sub> O <sup>-</sup>	0.6	0.77	0.64	0.92
CO <sub>2</sub>	0.48	1.83	2.13	1.04
Total	99.79	100.2	100.51	100.22

The ideal and observed compositions for asbestiform amphiboles also differ significantly because cations readily substitute for one another in the amphibole crystal structure (table 13). Most commercial amphibole asbestos varieties are actinolite asbestos, amosite, anthophyllite asbestos, crocidolite, and tremolite asbestos as defined by the compositional guidelines developed by the International Mineralogical Association (Leake and others, 1997). Meeker and others (2003) and Wylie and Verkouteren (2000) have also identified asbestiform varieties of magnesioriebeckite, richterite, tremolite, and winchite as accessory minerals in a vermiculite deposit in Libby, Mont. Meeker and others (2003) further indicated that edenite asbestos and magnesioarfvedsonite asbestos also may be present in low concentrations. These asbestiform minerals had been identified as soda tremolite, richterite, soda-rich tremolite, and tremolite asbestos in past studies of the Libby and other vermiculite deposits (Pardee and Larsen, 1929, p. 17, 24-26; Larsen, 1941, p. 34; Boettcher, 1966).

Chrysotile has a surface charge that can be positive or negative depending on its source. Most chrysotile has a positive charge, reflecting the net positive charge of magnesium hydroxide cation (MgOH<sup>+</sup>) layer on the outer surface layer of the fiber. Fibers from which weathering has removed its MgOH<sup>+</sup> layer, exposing the silica-rich layer below, have negative charges (Chowdhry and Kitchener, 1975; Hodgson, 1986, p. 62-65). The surface charge for asbestiform amphiboles is negative (Ralston and Kitchener, 1975; Hodgson, 1979, p. 107). The negative charge is attributed to the silica-rich layers exposed on the fiber surface. Surface charges are important in that they affect the degree that the fiber will disperse in suspension and whether or not the fiber will flocculate during processing. For example, amphiboles maintain their strongly negative surface charge at higher pH levels and remain dis-

**Table 13.** Major-oxide composition of amphibole asbestos

[In weight percent. --, zero. Information from Hodgson, 1979, p. 80-81]

	Amosite	Actinolite <sup>1</sup>	Anthophyllite	Crocidolite	Tremolite
SiO <sub>2</sub>	49.7	53.8	57.2	50.9	55.1
Al <sub>2</sub> O <sub>3</sub>	0.4	1.2	--	Nil	1.14
Fe <sub>2</sub> O <sub>3</sub>	0.03	1.9	0.13	16.85	0.32
FeO	39.7	25.3	10.12	20.5	2
MnO	0.22	0.4	--	0.05	0.1
MgO	6.44	4.3	29.21	1.06	25.65
CaO	1.04	10.2	1.02	1.45	11.45
K <sub>2</sub> O	0.63	0.4	--	0.2	0.29
Na <sub>2</sub> O	0.09	0.1	--	6.2	0.14
H <sub>2</sub> O <sup>+</sup>	1.83	2.6	2.18	2.37	3.52
H <sub>2</sub> O <sup>-</sup>	0.09	Nil	0.28	0.22	0.16
CO <sub>2</sub>	0.09	0.2	--	0.2	0.06
Total	100.26	100.4	100.14	100	99.93

<sup>1</sup>Ferro-actinolite.

persed under conditions that cause chrysotile to flocculate. These properties were used to advantage in highly alkaline cement mixes where the amphibole fibers, which are not being flocculated, helped to disperse the chrysotile, which would normally have flocculated in the cement mix (Hodgson, 1986, p. 84).

Strong acids aggressively attack chrysotile. Chrysotile also dissolves when exposed to strongly caustic solutions at their boiling temperature (Badollet, 1951). Most amphibole fiber varieties are more acid resistant than those of chrysotile, but they can experience weight losses of 2 to 23 percent through dissolution when exposed to concentrated acids at higher temperatures. Actinolite and amosite exhibit greater weight loss when exposed to acids than the other amphibole asbestos varieties owing to their higher iron contents (Hodgson, 1979, p. 83-85; Virta and Mann, 1994, p. 102).

## Uses

### Present Uses

Asbestos continues to be used in a variety of applications. The most commonly produced asbestos products on the market today include A/C corrugated and flat sheet, panels, pipes, tiles, tubes, and tube fittings. Asbestos provides a valuable means of manufacturing these A/C products at low cost in regions throughout the world where production costs are an issue. Asbestos also continues to be used in brakes. Asbestos is used to produce a durable, temperature-resistant lining. The

ready availability of asbestos substitutes and their relatively successful incorporation into brake pads and shoes has resulted in declining markets for asbestos in braking systems in many countries. Asbestos continues to be used in asphalt products, coating and compounds, cord, fiber jointing, gaskets, magnesium carbonate-base insulation, mastics, millboard, paper, textiles, and thread (Moore, 2004; Virta, 2005).

## Patterns of Use

In 2003, 4,650 t of chrysotile was used in the United States. About 80 percent of that amount was used in asphalt roof coatings and sealants; 5 percent, for other coatings and compounds; and the remainder, in miscellaneous applications. World consumption was estimated to be about 2.15 Mt in 2003. Data are lacking on world end-use markets, but A/C products were thought to account for more than 85 percent of world consumption. Brake linings accounted for another 10 percent of the world sales. The remainder was used in a variety of applications (Moore, 2004).

An estimated trade distribution for asbestos manufacturing in 2003, based on trade calculations, is shown in figure 6. Trade data for 2003 suggest that manufacturers in about 65 countries imported asbestos from the major producer countries (United Nations, 2004). Many of the products manufactured in these countries are exported, thus world consumption of asbestos products is more complex. As an example, the United States imported asbestos fiber from 5 countries in 2003 but imported asbestos products, ranging from brake pads and shoes to gaskets to textiles, from a total of 48 countries (U.S. International Trade Commission, 2004b).

## Historical End-Use Consumption

Based on qualitative descriptions of the asbestos manufacturing industries, A/C products are thought to have dominated the asbestos market since the early 1900s. In the 1930s, A/C corrugated and flat sheet, pipe, and roofing tile were the major markets for asbestos. The low cost of A/C products, their reliability, and the unsophisticated technology required to produce A/C products were major factors leading to its widespread use, particularly for developing countries with limited mineral and monetary resources (Griffiths, 1986, p. 37; Moore, 2004). Rosato (1959, p. 63) indicated that in 1959, A/C products for commercial and industrial buildings and private homes consumed the largest quantity of asbestos. In 1980, A/C products were reported to account for about 66 percent of world consumption of asbestos. In regions where there were alternative construction materials, the demand for A/C products was proportionally smaller, and was a much wider variety of other asbestos products was developed. In the United States and Western European countries, A/C products accounted for only 45 percent and 43 percent of the respective markets. With the onset of the asbestos health issue in the 1970s, demand for asbestos products declined in the United States and Western European markets where noncement applications of asbestos dominated at the time. Consequently, the percentage of the world market accounted for by A/C products increased to 80 percent of the asbestos products market in Africa; 76 percent in Asia, Eastern Europe, and South America; and 60 percent in Oceania in 1980 (Roskill Information Services, Ltd., 1983, p. 84-86). With the continued decline in asbestos use in the 1980s and 1990s, markets have shifted even more towards A/C products (the major component of construction products) and away from friction and other products (table 14). In 2003, A/C products accounted for more than 85 percent of the world's consumption of asbestos (Moore, 2004). Other markets for asbestos are asbestos paper, asbestos textiles

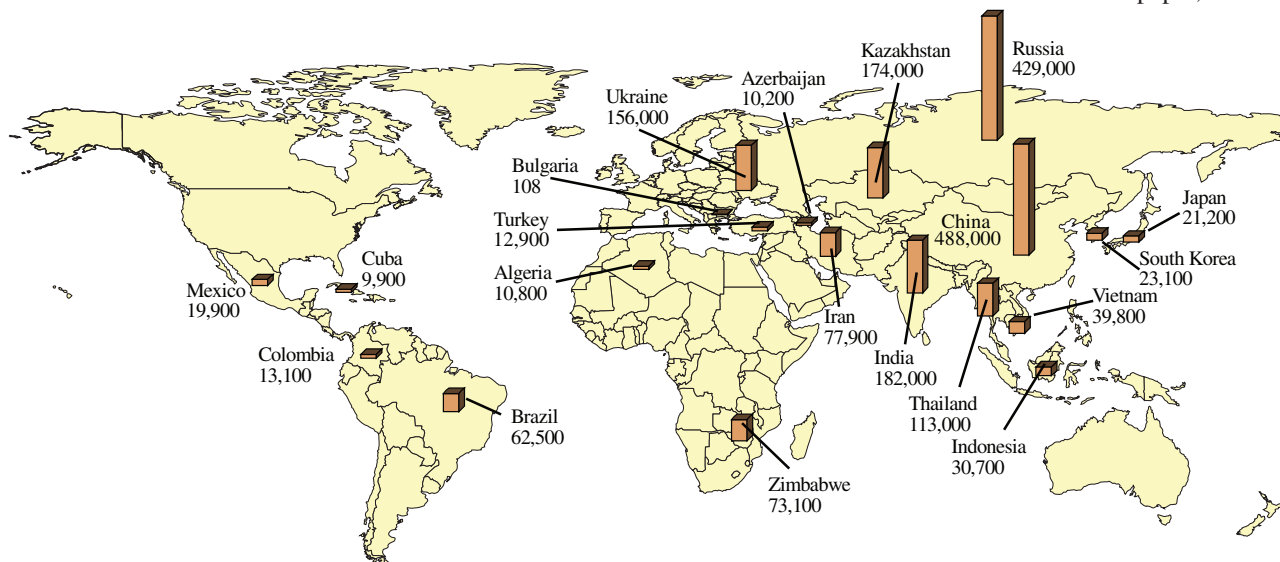

**Figure 6.** Estimated world consumption of asbestos in 2003. Figures listed are in metric tons.

**Table 14.** World consumption of asbestos in 1974 and 1988  
 [In thousand metric tons. Information from Roskill Information Services Ltd., 1990, p. 98]

Region	Construc- tion		Friction products		Other		Total	
	1974	1988	1974	1988	1974	1988	1974	1988
North America	820	90	105	20	225	10	1,150	120
Central and South America	150	190	20	35	20	25	190	250
Western Europe	830	450	60	10	100	20	990	480
Eastern Europe	870	2,100	30	50	150	200	1,050	2,350
Africa	30	40	15	18	5	3	50	61
Asia	680	850	70	18	50	75	800	943
Oceania	170	110	10	1	10	5	190	116
<b>Total</b>	<b>3,550</b>	<b>3,830</b>	<b>310</b>	<b>152</b>	<b>560</b>	<b>338</b>	<b>4,420</b>	<b>4,320</b>

(comprising cloth, rope, tape, thread, or yarn), electrical and thermal insulation, friction products (including brake or clutch

pads), and gaskets. Some specialty plastic products are still manufactured.

About 37 percent of the total U.S. consumption of asbestos has been since 1965, which is the earliest available estimate of U.S. asbestos consumption (fig. 3). Thus, a rough idea of the markets into which a sizable share of the asbestos went throughout most of the history of U.S. asbestos usage can be estimated. Table 15 presents the end-use data for asbestos from 1965 to 2003. The average percentage breakout of the major U.S. markets between 1965 and 2003, in decreasing order by tonnage, was flooring, 22 percent; A/C pipe, 18 percent; roofing products, 12 percent; friction products, 11 percent; A/C sheet, 6 percent; packing and gaskets, 4 percent; paper, 3 percent; coatings and compounds, electrical insulation, and textiles, 2 percent each; plastics and thermal insulation, less than 1 percent each; and other, 18 percent (Clifton, 1976, p. 113; 1980b, p. 63; 1985; Virta, 1985-1996, 1997-2005).

Because of the asbestos health issue, markets changed during this time period. The largest losses in the United States were in A/C pipe and sheet, coatings and compounds, flooring, and insulation. In 1965, before the asbestos health issue intensified, flooring accounted for 25 percent of the market share, followed by A/C pipe, 19 percent; roofing, 9.9 percent; friction products,

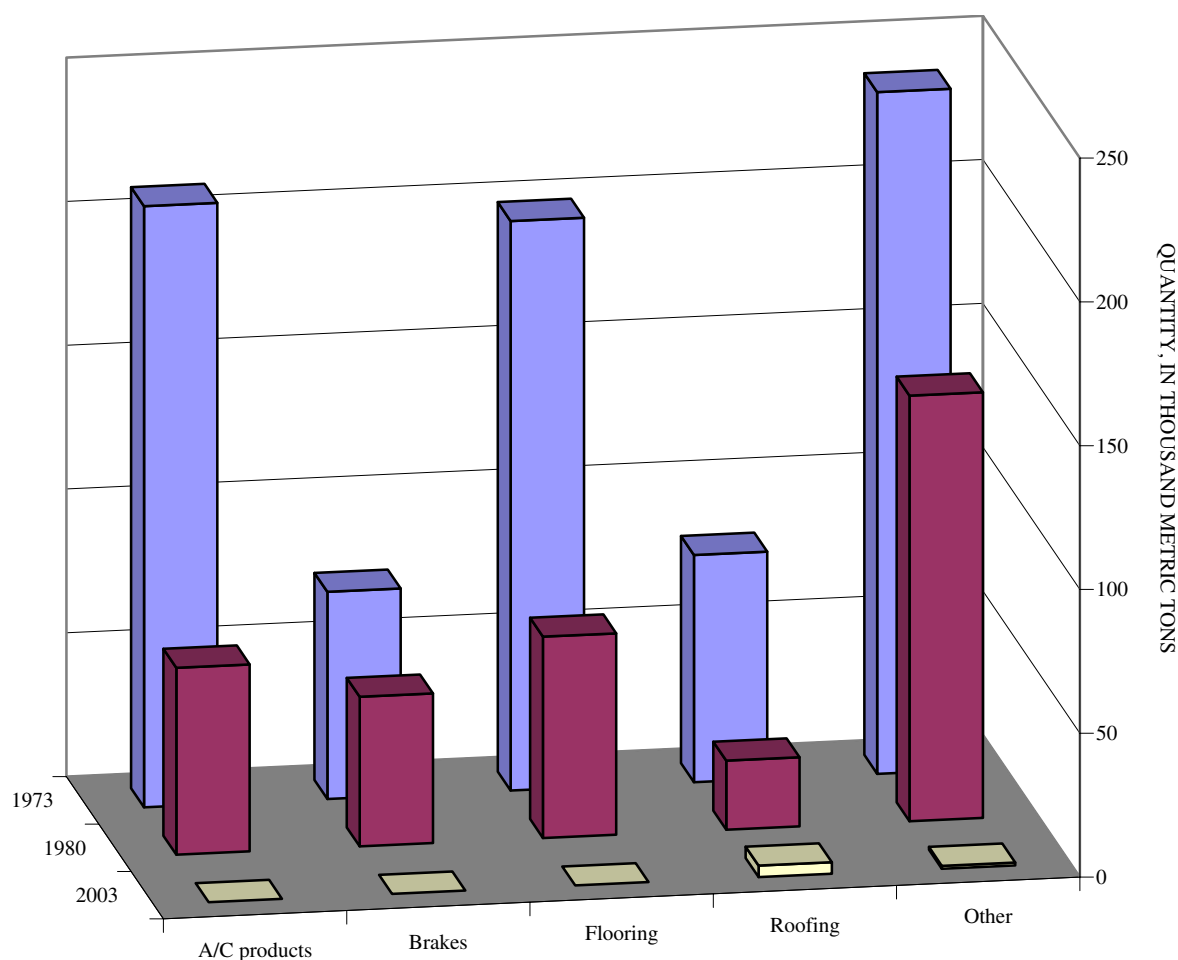

**Figure 7.** Major U.S. asbestos end uses in 1973, 1980, and 2003. Apparent U.S. consumption was 795,000 metric tons (t) in 1973, 359,000 t in 1980, and 5,000 t in 2003. Data from U.S. Bureau of Mines, 1934-1996; Virta, 2005.



Table 15. End uses for asbestos in the United States from 1965 to 2003

[In thousand metric tons. e estimated; --, zero. Data from U.S. Bureau of Mines, 1934-1996; May, 1965; May and Lewis, 1970; Clifton, 1976, 1980, p. 63]

Year	Asbestos cement											Total <sup>3</sup>			
	Pipe	Sheet	Coatings and compounds	Flooring products	Friction products	Electrical insulation	Thermal insulation and gaskets	Packing products	Paper products	Plastics	Roofing products		Textiles	Other <sup>1</sup>	Unknown <sup>2</sup>
1965 <sup>e</sup>	137	50	(4)	181	64	22	(5)	22	15	(4)	72	15	144	--	721
1966 <sup>e</sup>	139	51	(4)	183	65	22	(5)	22	14	(4)	73	15	147	--	730
1967 <sup>e</sup>	122	46	(4)	162	59	20	(5)	20	13	(4)	64	13	132	--	650
1968 <sup>e</sup>	141	52	(4)	185	67	23	(5)	23	15	(4)	74	15	148	--	741
1969 <sup>e</sup>	135	50	(4)	178	64	22	(5)	22	14	(4)	72	14	140	--	711
1970 <sup>e</sup>	126	46	(4)	167	60	20	(5)	20	14	(4)	66	14	133	--	666
1971 <sup>e</sup>	131	48	(4)	173	62	21	(5)	21	14	(4)	69	13	137	--	689
1972	140	52	(4)	183	66	22	(5)	22	15	(4)	73	14	147	--	733
1973	151	58	(4)	198	72	23	(5)	23	16	(4)	79	16	158	--	795
1974	202	86	(4)	139	73	13	(5)	26	57	(4)	69	18	85	--	768
1975	139	40	(4)	123	60	6	(5)	15	60	(4)	42	5	62	--	552
1976	127	21	(4)	104	58	8	(5)	18	28	(4)	231	6	59	--	659
1977	115	27	36	150	57	17	4	28	7	8	70	10	143	--	672
1978	106	25	33	138	53	15	4	25	7	7	64	9	133	--	619
1979	96	22	30	125	48	14	3	23	6	7	58	8	121	--	561
1980	42	23	11	70	52	6	3	12	1	2	24	2	111	--	359
1981	42	20	13	67	51	6	1	19	2	1	16	2	109	--	349
1982	38	11	25	49	53	--	1	14	2	--	7	1	46	--	247
1983	26	10	23	45	48	--	1	12	2	1	6	1	42	--	217
1984	37	12	22	46	48	(6)	2	13	2	1	7	2	33	--	226
1985	28	7	23	7	34	(6)	(6)	6	17	(6)	26	1	5	7	162
1986	20	5	17	5	26	(6)	(6)	5	13	(6)	20	(6)	4	4	120
1987	11	4	3	--	21	(6)	(6)	10	5	1	23	1	2	4	84
1988	12	4	4	(6)	15	(6)	(6)	10	1	(6)	20	(6)	(6)	5	71
1989	8	3	4	--	12	--	--	4	1	1	18	(6)	1	4	55
1990	5	2	2	--	9	--	--	3	(6)	(6)	13	--	1	7	41
1991	4	2	1	--	10	--	--	3	(6)	(6)	15	--	1	1	35
1992	2	(6)	1	--	10	--	--	3	(6)	(6)	16	--	1	(6)	33
1993	1	--	1	--	10	--	--	3	(6)	(6)	16	--	1	(6)	32
1994	--	--	(6)	--	9	--	--	3	(6)	(6)	13	--	1	(6)	27
1995	--	--	(6)	--	7	--	--	3	(6)	(6)	11	--	1	(6)	22
1996	--	--	(6)	--	7	--	--	3	(6)	(6)	11	--	1	(6)	22
1997	--	--	(6)	--	6	--	--	4	(6)	(6)	10	--	1	(6)	21
1998	--	--	(6)	--	3	--	--	2	1	(6)	9	--	1	--	16
1999	--	--	(6)	--	2	--	--	3	--	(6)	10	--	1	--	16
2000	--	--	(6)	--	2	--	(6)	3	--	(6)	9	--	1	--	15
2001	--	--	(6)	--	1	--	--	2	--	(6)	9	--	1	--	13
2002	--	--	(6)	--	(6)	(6)	(6)	1	(6)	--	5	--	(6)	--	7
2003	--	--	1	--	--	--	--	--	--	--	3	--	1	--	5
Total <sup>7</sup>	2,280	776	248	2,680	1,360	279	19	470	339	29	1,490	193	2,250	32	12,400

<sup>1</sup>Includes known end uses that do not fall into specified end-use categories. <sup>2</sup>Undetermined end uses. <sup>3</sup>May not add to total owing to independent rounding.<sup>4</sup>Included in "Electrical insulation." <sup>5</sup>Less than 1/2 unit. <sup>6</sup>Data are rounded to no more than three significant digits.

8.9 percent; A/C sheet, 6.9 percent; electrical insulation and packing and gaskets, 3 percent each; paper and textiles, 2 percent each; coatings and compounds, thermal insulation, and plastics, less than 1 percent each; and unknown uses, 20 percent. By 1980, consumption was 19.5 percent for flooring, followed by friction products, 14.5 percent; A/C pipe, 11.7 percent; roofing, 6.7 percent; A/C sheet, 6.4 percent; packing and gaskets, 3.3 percent; coatings and compounds, 3.1 percent; electrical insulation, 1.7 percent; thermal insulation, 0.8 percent; plastics and textiles, 0.6 percent each; paper, 0.3 percent; and unknown uses, 30.9 percent. In 2003, the end-use markets in the United States were roofing (more than 80 percent), coatings and compounds (less than 3 percent), and unknown uses (about 17 percent) (fig. 7).

This global trend of A/C products accounting for increasingly larger shares of the world asbestos market probably will continue. A/C products are still used in regions where reliable low-cost pipe and sheet products are required. For other product applications, market penetration by asbestos substitutes or alternative products and liability issues almost guarantee a continued decline in those markets.

## Asbestos Substitutes

As with most minerals, asbestos-containing products faced competition from a variety of other materials. The major difference was that the switch to competing materials, namely asbestos substitutes and alternative products, was hastened as a result of environmental and liability issues. Product manufacturers have been replacing asbestos with substitute materials, redesigning old products to eliminate the need for asbestos, or designing new products that require neither asbestos nor asbestos substitutes. Some of the factors considered in developing the substitutes include substitute cost, additional manufacturing costs, product design costs, and product performance (Hodgson, 1985, p. 1-2; Pye, 1989a, p. 372). In the United States, substitutes have almost entirely replaced asbestos in the market. In Europe and a few other locations, bans on most applications for asbestos have all but ensured that little asbestos will be used after about 2005. Examples of materials substituted for asbestos include aramid fiber, cellulose fibers, ceramic fiber, fibrous glass, graphite flake and fiber, mica, polyethylene fiber, polypropylene fiber, polytetrafluoroethylene fiber, steel fibers, and wollastonite. Examples of alternative products include aluminum, vinyl, and wood siding; aluminum pipe and sheet; asphalt coatings; ductile iron pipe; fiberglass sheet; polyvinylchloride pipe; prestressed concrete and reinforced concrete pipe; semimetallic brakes; urethane coatings; and vinyl composition floors (tables 16 and 17; Hodgson, 1985, p. 125-218; U.S. Environmental Protection Agency, 1988, p. 1.1-35.10; Pye, 1989b, p. 342-370; Roskill Information Services, Ltd., 1990, p. 90-126; Harrison and others, 1999). No single substitute has proved to be as versatile as asbestos. In addition, there are few regulations specifically for occupational exposure to substitute fibers, and the potential health effects resulting from long-term exposures to many of the substitute fibers have not been well documented.

**Table 16.** Asbestos substitutes<sup>1</sup>

[Sources: Meylan and others, 1978; Hodgson, 1985, 1989; U.S. Environmental Protection Agency 1988; Harrison and others, 1999]

Acicular to fibrous morphology <sup>2</sup> :	Nonfibrous morphology:
Aramid fiber	Biotite
Carbon fiber	Calcium carbonate
Cellulose fiber	Calcium silicate
Ceramic fiber	Diatomite
Fiberglass	Fibrillated polypropylene
Mineral wool	Graphite
Nylon fiber	Muscovite
Palygorskite (attapulgit)	Perlite
Polyacrylonitrile fiber	Serpentine
Polybenzimidazole fiber	Silica
Polyethylene fiber	Talc
Polypropylene fiber	Vermiculite
Polytetrafluoroethylene fiber	
Polyvinyl alcohol fiber	
Potassium titanate fibers	
Sepiolite	
Steel fiber	
Wollastonite	
Wool	

<sup>1</sup>Materials in bold type are the more commonly used asbestos substitutes.

<sup>2</sup>Dependent on material; for example, wollastonite is acicular and palygorskite (attapulgit) is fibrous, while polytetrafluoroethylene can be manufactured in nonfibrous or fiber shapes.

## Dissipative Uses

Asbestos usage is dissipative as there is no recycling; products that no longer function adequately are discarded. With current opposition to the use of asbestos and even its presence in buildings, many serviceable asbestos products are removed for disposal before reaching their normal functional lifespan.

## Sources

### Principal Deposits

Major chrysotile deposits occur in mountain chains of all ages where there has been widespread metamorphism (fig. 8). Large deposits in the Ural Mountains in Russia and the Appalachian Mountains in Canada and the United States are classic examples.

**Table 17.** Examples of asbestos substitutes and alternative products

[Sources: Meylan and others, 1978; Hodgson, 1985, 1989; U.S. Environmental Protection Agency, 1988; Roskill Information Services Ltd., 1990; Harrison and others, 1999]

Product category	Asbestos substitute or alternative product
Asbestos cement (A/C) pipe	Cellulose fibers, ductile iron, fiberglass, mica, polyacrylonitrile and polyvinyl alcohol fiber, polyvinyl chloride pipe, prestressed concrete, reinforced concrete pipe, wollastonite
A/C sheet	Aluminum siding, cellulose fibers, corrugated fiberglass panels, corrugated polyvinyl chloride panel, fiberglass, fibrillated polypropylene, polyacrylonitrile and polyvinyl alcohol fiber, vinyl siding, wood
Coatings and compounds	Aramid fiber, carbon fiber, cellulose fiber, clay, fiberglass, polyethylene films, limestone, rubber membrane roofing, mica, polyethylene fiber, polypropylene fiber, talc, wollastonite
Flooring	Carpeting, ceramic tile, clay, fiberglass, polyethylene pulp, silica, talc, vinyl compositions, wood
Friction	Aramid fibers, cellulose, ceramic fiber, fiberglass, metal (brass, bronze, copper, iron) fibers, palygorskite (attapulgite), polyacrylonitrile fiber, potassium titanate, semimetallic brakes, sepiolite, steel fibers, vermiculite, wollastonite
Insulation	Calcium silicate board, cement board, ceramic fiber, fiberglass, mica, mineral wool, vermiculite
Packings and gaskets	Aramid fiber, carbon fiber, cellulose fiber, ceramic fiber, cork, fiberglass, graphite, mica, metal gaskets, mineral wool, polytetrafluoroethylene, rubber sheeting
Paper and paperboard	Ceramic fiber, cellulose, fiberglass, mica, polytetrafluoroethylene, vermiculite, wollastonite
Pipe wrap	Nonfibrous minerals, plastic coatings, urethane coatings
Plastics	Aramid fiber, carbon fiber, fiberglass, fumed silica powder, mica, polytetrafluoroethylene, potassium titanate, wollastonite
Tape	Carbon-base tape, cellulose, urethane tape
Textile	Aramid fiber, carbon fiber, ceramic fiber, fiberglass, mineral wool, polybenzimidazole fiber

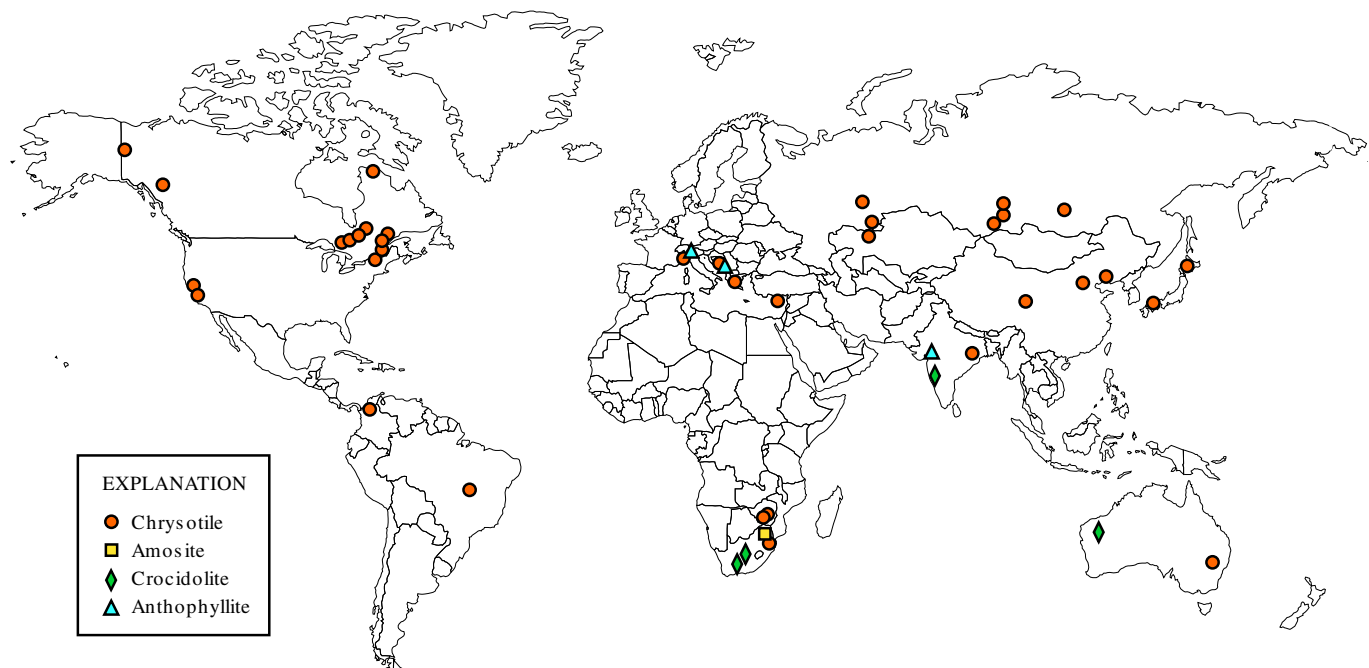

**Figure 8.** World asbestos resources. Sources: Virta and Mann, 1994, p. 104-105.

### Origin and Modes of Geologic Occurrence

The host rock for most of the world’s chrysotile production is ultrabasic in composition (Bates, 1969; Ross and Virta, 2001). These can be categorized as Type I or Type II deposits.

Type I deposits occur in alpine-type ultramafic rocks, including ophiolites and serpentinites. Type II deposits occur in stratiform ultramafic intrusions. The remaining chrysotile production is derived from serpentinitized dolomitic limestone, also called Type III deposit. Amosite and crocidolite are

found in metamorphosed ferruginous sedimentary formations, also referred to as Type IV deposits. Commercially viable deposits are in banded ironstones, ferruginous quartzites, and iron-rich silicified argillite (Ross and Virta, 2001). Tremolite asbestos and anthophyllite asbestos are associated with metamorphosed ultrabasic rocks.

Ultrabasic deposits encompass the Type I and Type II deposits. Type I deposits account for about 90 percent of the world production of asbestos and generally contain cross- or slip-fiber veins of asbestos. Examples of these types of deposits occur throughout the world, with the largest being in Quebec and the Ural Mountains in Russia (Ross, 1984, p. 56). Typical of Type I deposits are the chrysotile deposits in the Eastern Townships area of Quebec. These deposits occur along a major serpentine belt that arcs northeastward into the Gaspé Peninsula and southward into the Appalachian Mountains belt of Vermont (Lamarche and Riordon, 1981; Ross, 1981, p. 296-299). Another variation of Type I deposits is the chrysotile deposits in ultrabasic rock near Coalinga, Calif. Unlike the deposits in Canada and Russia, the Coalinga deposit is a mass fiber deposit of chrysotile. Instead of the fiber being present in veins as cross- or slip-fibers, it is distributed throughout the entire rock mass. Boulders of massive serpentinized material are scattered throughout the loose platy serpentine. Ancient landslides, for which there is evidence, may have contributed to the extreme deformation of the serpentine. The ore contains abundant short chrysotile fiber (Munro and Reim, 1962; Ross, 1981, p. 298).

The most productive of the Type II deposits are in South Africa, Swaziland, and Zimbabwe (Ross, 1981, p. 299-300; 1984, p. 56). The Shabani deposit, east of Bulawayo, Zimbabwe, is a good example of Type II deposits. Chrysotile formed in an altered portion of a lenticular ultrabasic sill (Virta and Mann, 1994, p. 107). This deposit, in particular, is renowned for its low iron content resulting from the low concentration of magnetite in the fiber as well as its long fiber length (Sinclair, 1959, p. 76; Ross and Virta, 2001).

Comparatively small tonnages of asbestos were mined from Type III or serpentinized dolomitic limestones (Hall, 1930, p. 324; Rowbotham, 1970; Ross, 1981, p. 300-301; 1984, p. 56). Much of such fiber is of high quality and free of the magnetite that is commonly associated with most deposits of ultrabasic origin. Chrysotile of this type was mined in the Carolina District in the Transvaal area of South Africa and in the Salt River and Sierra Ancha regions in Arizona. The Arizona deposits, northeast of Globe, are tabular in shape and occur in serpentinized dolomitic limestones, altered through contact metamorphism. Serpentinization occurred during the intrusion of diabase sills. Chrysotile is found in thin discontinuous veins (Wilson, 1928, p. 57-58; U.S. Bureau of Mines, 1945, p. 1; Stewart, 1955, p. 100-113; Li, 1975).

Examples of Type IV deposits occur in South Africa where crocidolite and amosite are found in deposits known as banded ironstone, ferruginous quartzite, or iron-rich silicified argillites formations. Crocidolite is found over a large area of Cape Province in a belt of the Lower Griquatown series of

the Transvaal system. Crocidolite and amosite are found in similar formations near Pietersburg in northern Transvaal. In some places, the two varieties are side by side in the same vein. An amosite-bearing banded ironstone formation crops out for a distance of more than 30 kilometers (km) near Penge in the Lydenburg District of the Transvaal. Thin, persistent sills of dolerite that are conformable with the bedding have intruded this sequence (Hall, 1930; Sinclair, 1959, p. 82-87; Dreyer and Robinson, 1981, p. 26-32; Ross, 1981, p. 288-292; 1984, p. 56).

Of the countries in which anthophyllite asbestos deposits are known, Finland was the most important producer with major deposits at Paakkila in the parish of Tuusniemi in eastern Finland and Maljasalmi in Kuusjarvi Parish. The Finnish anthophyllite asbestos deposits consist of a series of lenses of amphibolitized and serpentinized ultrabasic material (Sinclair, 1959, p. 97; Ross, 1981, p. 292-294; Mann, 1983, p. 456; Ross and Virta, 2001, p. 80).

Most U.S. anthophyllite asbestos production is associated with deposits near Green Mountain in Yancey County, N.C., although other deposits also were mined in the past. The Green Mountain deposits are associated with altered peridotites and pyroxenites. Most of the deposits consist of mass fiber, although cross and slip fiber are more common in other parts of the State. Similar types of deposits also were mined in Georgia in the United States (McCallie, 1910; p. 33-36; Teague, 1956; Conrad and others, 1963, p. 7-21).

Italy has produced some long fiber tremolite from small deposits at Val Malenco in the Sondrio District, 100 km north of Milan. Tremolite fiber has been found in the Aosta District north of Turin in the Italian Alps.

Amphibole asbestos also has been found in Bulgaria, India, Romania, Taiwan, Turkey, and Yugoslavia. Most of the Indian production is from Rajasthan. Some deposits of fibrous actinolite have been reported but production is extremely low.

Worldwide, the amount of asbestos contained in the rock varies widely between deposits. An asbestos content of about 5 percent is typical of most large chrysotile deposits. Ross (1981, p. 298) reported that the chrysotile content of the mass fiber deposit in Coalinga can approach 50 percent. In general, companies mine only the ore that contains higher concentrations of asbestos. Thus, the mill feed will have a 1 to 2 percent greater asbestos content than the mined rock. Worldwide, asbestos concentration in the mill feed is generally in the range of 2 to 10 percent asbestos. Only in a few locations were concentrations lesser or greater (table 18).

## Reserves and Resources

The definitions of reserves and reserve base as published in the U.S. Geological Survey circular titled "Principles of a Resource/Reserve Classification for Minerals" are reprinted in the appendix (U.S. Bureau of Mines and U.S. Geological Survey, 1980). World reserves and reserve base in 1990

**22 Mineral Commodity Profiles—Asbestos**
**Table 18.** Property resource information as of January 1982

[Recoverable fiber in percent and demonstrated recoverable fiber in thousand metric tons. do, ditto. A, amosite; Ch, chrysotile; Cr, crocidolite; N, nonproducer; P, producer; PP, past producer. Information from Anstett and Porter, 1985, p. 7]

Property location and name	Owner	Sta-tus <sup>1</sup>	Fiber grades	Fi-ber type	Recoverable fiber	Demonstrated recoverable fiber
United States:						
Alaska: Slate Creek	Tanana Asbestos Corp.; GCO Minerals	N	4	Ch	6.0-7.9	3,186.40
Arizona: El Dorado	Jaquays Mining Corp.	PP	3, 4, 7	Ch	6.0-7.9	3.7
California:						
Calaveras	Calaveras Asbestos Corp.	PP	4, 5, 6	Ch	2.0-3.9	278.3
Christie	Tenneco Oil Co.	PP	7	Ch	Greater than 11.9	788.3
Santa Rita	Union Carbide	PP	7	Ch	Greater than 11.9	2,926.40
Vermont: Lowell	Vermont Asbestos Company, Inc.	PP	3, 4, 5, 6, 7	Ch	2.0-3.9	534.7
Total						7,717.80
Australia: Woodsreef	Woodsreef Mines Ltd.	PP	4, 5, 6	Ch	6.0-7.9	482.5
Brazil: Cana Brava	S.A. Mineracao de Amianto	P	4, 5, 6	Ch	6.0-7.9	3,621.50
Canada:						
Abitibi	Abitibi Asbestos & Brinco Ltd.	N	4, 5, 6, 7	Ch	2.0-3.9	1,679.40
Asbestos Hill	La Societe National l'Amiante	P	4, 5, 7	Ch	6.0-7.9	1,132.90
Baie Verte	Baie Verte Mines, Inc	PP	4, 5, 6	Ch	2.0-3.9	1,046.30
Bell	La Societe National l'Amiante	P	3, 4, 5, 6, 7	Ch	6.0-7.9	1,084.00
Black Lake	Lac d'Amiante du Quebec Lte. and United Asbestos Corp. Ltd.	P	3, 4, 5, 6, 7	Ch	2.0-3.9	3,299.60
British Canadian	La Societe National l'Amiante	PP	3, 4, 5, 6, 7	Ch	2.0-3.9	1,834.20
Carey Canada	Jim Walters Corp.	PP	4, 5, 6, 7	Ch	8.0-9.9	3,021.30
Cassiar	Brinco Mining Ltd.	PP	3, 4, 5, 6	Ch	8.0-9.9	1,986.00
Jeffrey	Johns-Manville Canada Inc.	PP	4, 5, 6, 7	Ch	6.0-7.9	17,954.90
King-Beaver	La Societe National l'Amiante	P	3, 4, 5, 6, 7	Ch	4.0-5.9	3,712.80
Midlothian	United Asbestos Inc.	PP	4, 5, 6, 7	Ch	6.0-7.9	3,625.40
National	Lac d'Aminante Quebec Lte.	PP	3, 4, 5, 6, 7	Ch	4.0-5.9	983.3
Penhale	La Societe National l'Amiante	N	3, 4, 5, 6, 7	Ch	4.0-5.9	1,173.40
Roberge Lake	McAdam Mining Corp. Ltd.	N	5, 6, 7	Ch	2.0-3.9	2,818.80
Total						45,352.30
Colombia: Las Brisas	Minera Las Brisas S.A.	P	4, 6	Ch	4.0-5.9	362.9
Cyprus: Amiandos	Cyprus Asbestos Mines Ltd.	PP	3, 4	Ch	Less than 1.9	565.2
Greece: Zidani	Asbestos Mines of Northern Greece	PP	4, 5, 6	Ch	2.0-3.9	3,706.60
Italy: Balangero	Amiantifera di Balangero SpA.	PP	4, 5, 6, 7, 8	Ch	4.0-5.9	5,198.40
Mexico: Pegaso	Cia. Minera Pegaso S.A.	N	5, 6, 7	Ch	4.0-5.9	2,185.00
Africa:						
Danielskuil	General Mining Union Corp.	PP	3, 4	Cr	6.0-7.9	70.3
Elcor	do	PP	3, 4	Cr	10.0-11.9	728.5
Emmarentia	Lonhro Ltd.	PP	3, 4	Cr	8.0-9.9	50.2



**Table 18.** Property resource information as of January 1982—Continued

[Recoverable fiber in percent and demonstrated recoverable fiber in thousand metric tons. do, ditto. A, amosite; Ch, chrysotile; Cr, crocidolite; N, nonproducer; P, producer; PP, past producer. Information from Anstett and Porter, 1985, p. 7]

Property location and name	Owner	Sta-tus <sup>1</sup>	Fiber grades	Fi-ber type	Recoverable fiber	Demonstrated recoverable fiber
Penge	do	PP	3, 4	A	Greater than 11.9	802.1
Pomfret	do	PP	3, 4, 6	Cr	6.0-7.9	391.5
Riries	do	PP	3, 4	Cr	6.0-7.9	40
Senekal	do	PP	5, 6, 7	Ch	2.0-3.9	87.4
Wandrag	Lonhro Ltd.	PP	3, 4	Cr	6.0-7.9	61.8
Whitebank	General Mining Union Corp.	PP	3, 4	Cr	8.0-9.9	123.8
Total						3,111.90
Swaziland: Havelock	Turner & Newall, Ltd.; Swazi nation	PP	4, 5	Ch	2.0-3.9	217.8
Zimbabwe:						
Gath's	Turner & Newell, Ltd.	P	4, 5	Ch	2.0-3.9	449.6
King	do	P	4, 5	Ch	6.0-7.9	2,282.00
Shabanie	do	P	2, 3, 4, 5, 6	Ch	4.0-5.9	2,842.60
Total						5,574.20
Grand total						78,096.10

<sup>1</sup>Updated for 2003.

were estimated to be 110 Mt and 143 Mt, respectively (Virta, 1990). Declining demand for asbestos worldwide has resulted in mine closures or reduced production. This has meant a loss of reserves and resources. There have been sizable reserve losses in Australia, Canada, Cyprus, Finland, Greece, Italy, South Africa, Swaziland, and the United States as mines were closed. Anstett and Porter (1985) determined that past producers account for the bulk of the reserves outside of China, Kazakhstan, and Russia (table 18). However, new reserves have been delineated in currently mined ore bodies since 1990. Also, declining markets have resulted in lower mine output and a corresponding extension of reserve life. Reserves and resources in operating mine locations should satisfy future needs for even the distant future.

## Mining and Processing

### Exploration Techniques

Magnetic surveys often are used to locate ultrabasic rock bodies and define potential asbestos ore deposits because of their association with secondary magnetite formed during extensive serpentinization. Many asbestos deposits in ultrabasic rocks contain more magnetite than does barren serpentine.

Once the deposit is discovered and roughly delineated using remote sensing techniques, diamond drilling is used to assess and define the limits of an asbestos deposit, usually

using a wide spacing (often a 61-meter interval). A narrower interval is used when an asbestos-bearing zone is encountered. The spacing is adjusted to account for the shape and orientation of the ore body. Trenching or the use of adits or shafts and lateral workings may be used to assess a deposit when drilling is impractical.

The asbestos deposit then is evaluated for its fiber yield or grade, quality of fiber, and size (Dean and Mann, 1968, p. 281-286; Conn and Mann, 1971; Stewart, 1981). Yield and quality of fiber are evaluated using laboratory and visual methods. The simplest method for determining yield is a visual method using drill-core sections in which the fiber vein width in the core and the core length are used to estimate fiber content.

After the fiber yield of the ore is determined, the value of the fiber, and the per-ton-value of the ore must be estimated. The fiber is graded using the QS Test (Asbestos Textile Institute and Quebec Asbestos Mining Association, 1975). This test is performed on the QS testing machine, as described in the "Grades, Shapes and Specifications" portion of the "Commercial Forms, Grades, Shapes, and Specifications" section. When the weight of the fiber on each screen and in the bottom of the pan has been determined, multiplication factors are applied to the weight in each size fraction, giving a total point score for the sample. The average fiber value is determined by comparing the point score to a graph of point-score-versus-fiber-value that was previously developed for this or similar deposits. Using the average fiber value, the indicated ore value can be calculated.

## Mining

At least an estimated 80 percent of the chrysotile mined in 2003 was extracted using open pit mining techniques. Economy, fiber recovery, grade control, and safety are improved using open pit mining in most cases. Typical open pit mines are designed with multiple bench levels, and the pit width expands as the depth of mining increases. Blasting is required to fracture the ore. Front-end loaders or backhoes are used to load large haulage trucks. An in-pit crusher may be used to simplify handling (Bernier, 1984; Anstett and Porter, 1985, p. 11-13; Virta and Mann, 1994, p. 113).

Underground mining is used when open pit mining is inefficient. Several underground methods have been used (fig. 9). Sublevel stoping and caving may be initiated by blasting holes drilled upward from sublevel cross cuts, starting first on the hanging-wall side and retreating over a considerable width toward the footwall; the same method is used along the strike of the ore. In the sublevel stoping method, a slot also may be opened across the center of the ore body. The holes that are fanned out from the sublevel drifts are blasted toward the slot,

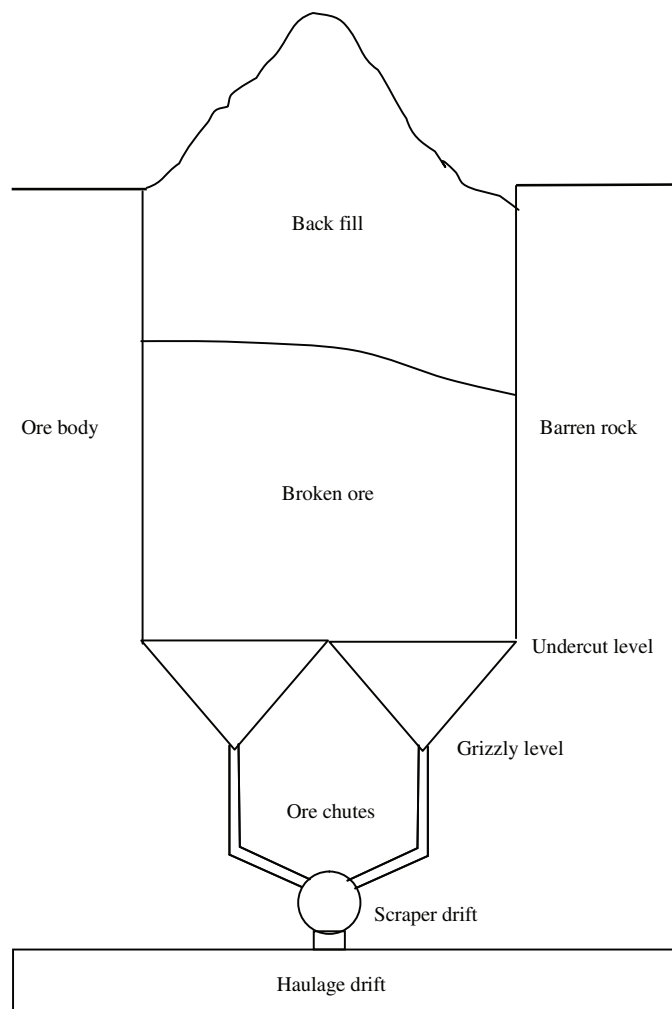

**Figure 9.** Generalized block caving method used in underground mining of asbestos. Adapted from Sinclair, 1959, p. 412.

and mining proceeds as a systematic retreat in two directions away from the opening. Room and pillar mining also has been used in some locations (Dreyer and Robinson, 1981, p. 22-36; Anstett and Porter, 1985, p. 13).

## Processing

Mill feed is derived from the underground or pit operation. Primary crushing may be done in underground stations, in the case of an underground mine, or in a surface plant, in the case of an open pit mine. Jaw or gyratory crushers are used. Some hand sorting may still be used in countries where labor rates are low. Hand sorting removes barren rock and recovers pieces of the larger veins used to produce Nos. 1 or 2 crudes.

Ore concentration is an important step in the milling of chrysotile ore and is particularly important for lower grade ore bodies. It is not uncommon to discard as much as 40 percent of the mine ore through selective crushing and screening in the primary and secondary crushing circuits. Some producers use magnetic pulleys for upgrading the mine ore, although not all asbestos ore bodies are amenable to this type of separation.

The ore is then dried. The two most commonly used dryers are rotary and vertical dryers. Fluidized-bed dryers also have been used. Generally, there is less mechanical damage to the fiber when vertical-tower and fluidized-bed dryers are used than when rotary kiln-type dryers are used. However, rotary dryers are preferable and are more effective for open pit ores that can contain snow and ice.

Chrysotile fiber is released and separated from gangue by successive stages of crushing. Impactors are designed to release the fiber from the host rock and at the same time produce a minimum of fines. Fiber released by crushing is lifted by air suction, leaving most of the rock as a reject to go to the next stage of impacting and eventually to tailings.

The concentrates undergo a series of cleaning operations for the purpose of removing sand and dust. Screens, trommels, and specific-gravity air separators further clean the fiber and separate it into standard-grade lengths.

In the grading mill, the fiber within each grade is further subdivided according to fiber quality. It is then subjected to several stages of screenings by means of shaking screens, gyratory screens, conventional trommels, trommel-like graders, and rotary dusters.

When well-opened or fluffed-out grades are required, the fiber is specially processed in one or more of a variety of machines. These range from graders or Willows mills (a fixed cylindrical casing with a rotating center shaft to which beater arms are attached) to one of several types of high-speed hammer mills, disk grinders, or pulverizers. The type of machine or machines used depends on the length and type of fiber to be processed and the degree of opening or fluffing required. This additional treatment is generally given to the shorter fibers (Bernier, 1984; Sinclair, 1959, p. 176-252; Virta and Mann, 1994, p. 113-118; fig. 10).

Chrysotile may also be processed using a wet process. British patent application WD 83/04190A of 1983 describes a two-stage Australian wet process. In the first stage, crushed chrysotile ore, slurried with water, is crushed and ground to release asbestos fibers and open the fiber bundles. The fibers are then concentrated using screw classifiers and spiral concentrators. In the second stage, the concentrated fibers are cleaned by low-pressure hydrocyclones and then separated into well- and poorly opened fibers by high-pressure hydrocycloning. Poorly opened fibers are mechanically milled and recycled. The well-opened concentrates are dewatered by high-pressure filtration. According to the patent application, the process concentrate yields are at least equal to those obtained by the conventional dry process and the process is suitable for reclaiming fibers from dry process tailings and capable of treating the low-grade ores that the dry process cannot handle (Clifton, 1985).

In the late 1970s and early 1980s, the Société National d'Amiante (SNA), Quebec, attempted to utilize the large amount of tailings from asbestos production. The SNA constructed a plant to extract magnesium metal from the tailings, but the operation was not commercially viable. The SNA also was involved with Noranda Mines Corp. to use asbestos tailings to remove sulfur dioxide from stack emissions, producing a magnesium sulfate for use by the fertilizer and the paper and pulp industries (Roskill Information Services, Ltd., 1983, p. 38). In 1999, interest in magnesium metal extraction was revived, and several plants were designed and/or constructed (Cassiar Mines and Metals Inc., 1999; Heinzl, 1999). Despite the technological advances since the 1980s, extracting magnesium from serpentinite tailings again proved to be unprofitable under current economic conditions, and no extraction plants are operating at this time.

### Coproducts and Byproducts

There has been only limited production of byproducts associated with asbestos production. A byproduct to improve vehicle traction on icy and snowy roads was made using asbestos tailings from a mine in Vermont. The market for this product ended when concerns over the potential fiber content of the product arose.

### Recycling

Recycling of asbestos products is not attempted. Most products were designed with an extremely long life, and the incorporation of the fiber into a matrix makes separation difficult or impossible. There are few asbestos uses, mainly textile, that have uncombined fibers in the end product. There may also be physical and/or chemical changes to the fiber dur-

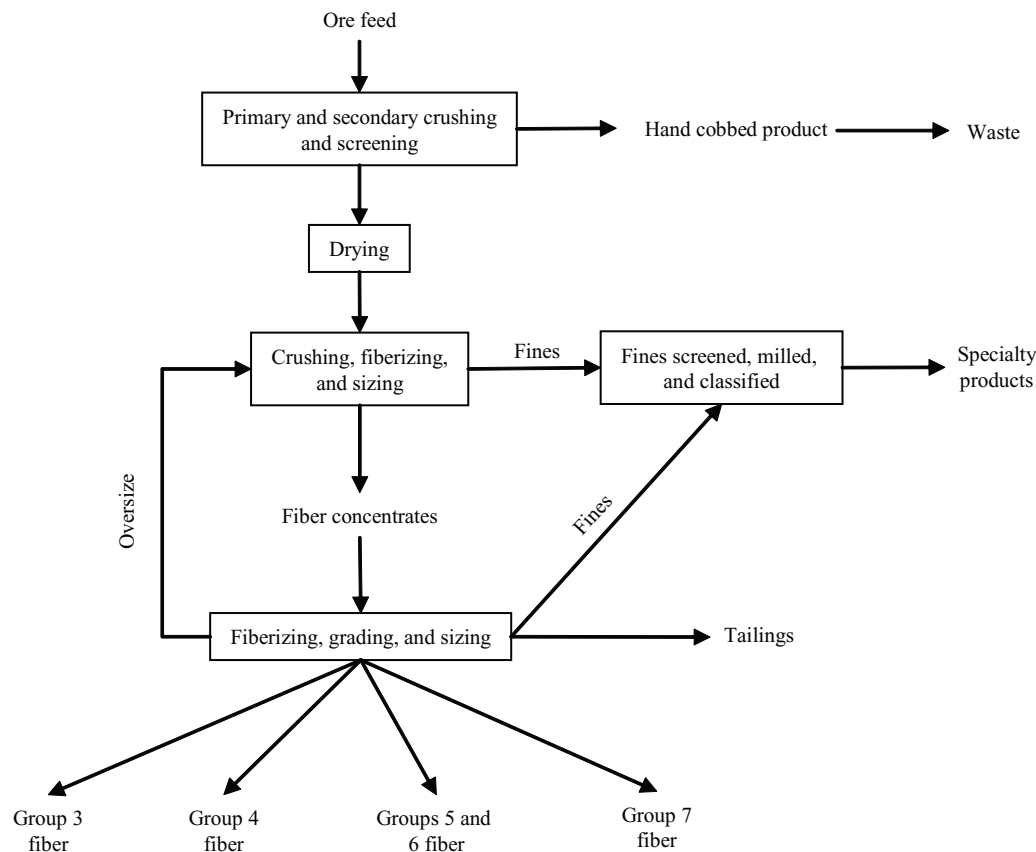

Figure 10. Generalized flowsheet for asbestos milling process. Adapted from Clifton, 1980b, p. 61.



ing manufacture and use, so any recovered fiber would be of less value than the reclamation costs and more costly than virgin fiber (Clifton, 1985). In such products as brake pads and shoes and equipment clutches, the product wears, and asbestos is abraded away, so recycling is not possible.

## Environmental Impact

Asbestos has an environmental impact in several ways. Open pit mines require the clearing of land and extraction of ore. Barren rocks or rocks that are low in fiber content are stockpiled onsite. Mill waste and tailings, similarly, are stockpiled near the mill site. These tailings represent a potential source of fiber release into the atmosphere and in water runoff. While concentrations of fiber generally are low in these tailings, in some locations the concentrations are sufficiently high to consider fiber recovery. Johns-Manville Corp. was recovering short (Group 6) fiber from ore tailing as early as the 1970s at their Asbestos, Quebec, operation. Fiber recovery from the ore tailing was undertaken to improve the efficiency of the mining and milling operation. Recoverable fiber averaged about 5.6 percent (Pit and Quarry, 1970). More recently, consideration was given to recovering fiber from tailings as a means of producing fiber without incurring the expense of mining. Around 2000, Minroc Mines Inc., briefly recovered chrysotile from tailings at a former mine in Cassiar, British Columbia, but stopped recovery of the fiber following a fire in the mill (Canada NewsWire, 2000). Teranov Mining Co. also recovered chrysotile from ore tailings for a short time period at a former chrysotile mine in Newfoundland (Industrial Minerals, 1993). The concentration of recoverable fiber in the tailings of the Newfoundland site was 2.2 percent (Stewart, French, and Anthony, 1990). The mines and mills in British Columbia and Newfoundland are now closed.

In most cases, mining poses minimal threat to the general population because mining operations are located in remote areas; sometimes however, towns were established near the mine or mill sites for the convenience of the workers. Operations in the United States and in many other countries have to comply with environmental standards for fiber release into the air and water. They also have to comply with Government regulations for worker exposure to fibers within the workplace. In the United States, these regulations are enforced by the U.S. Department of Labor and the U.S. Environmental Protection Agency (Mine Safety and Health Administration, 2004; Occupational Safety and Health Administration, 2004; U.S. Environmental Protection Agency, 2004b).

## Industry Structure

The asbestos industry comprises a variety of company types. At one time, large international companies, such as Cape Asbestos Ltd., ETEX Group (formerly known as Eternit

Group), General Mining Union Corp., Jim Walters Corp., Johns Manville Corp., Turner and Newel Ltd., and Union Carbide dominated the industry (Clifton, 1979, p. 3; 1980b, p. 57; 1985, p. 54). Only Eternit Group has maintained a connection with asbestos production through a few small subsidiaries, such as Eternit SA in Brazil (Roskill Information Services, Ltd., 1995, p. 12). Most mines are operated by smaller investment groups, such as LAB Chrysotile, Inc. in Canada, or by subsidiaries of companies not directly involved in the asbestos industry, such as African Resources, Ltd. in Zimbabwe. In China, there are many independent operators with only one or two larger producers. In Kazakhstan and Russia, the mines are operated as joint stock combines (JSC), which now are fundamentally independent operations. These large JSC companies have been operating for most of the 20th century but have been transformed as political changes take place in the former Soviet Union. Most mining companies sell fiber on the open market to nonaffiliated manufacturing entities (Clarke, 1982, p. 31-37; Roskill Information Services, Ltd., 1990, p. 1-64; 1995, p. 1-26; Moore, 2004).

## Producers

Brazil, Canada, China, Kazakhstan, Russia, and Zimbabwe accounted for more than 95 percent of production in 2003 (table 2). Excluding China, about nine companies undertook production in these countries. In China, one major producer accounted for about 20 percent of the production, while numerous small companies accounted for the rest. Asbestos also was produced in Argentina, Bulgaria, Colombia, India, and Iran. Only one or two companies produced asbestos in these countries, except for India, where several small producers accounted for the country's production of primarily tremolite asbestos (Moore, 2004; Roskill Information Services Ltd., 1995, p. 1-26).

In Brazil, the sole producer of asbestos is Sociedadada Anonima Mineração de Amianto Ltda., which is owned by Eternit SA and Brasilit SA. The company mines chrysotile at its Cana Brava mine north of Brasilia.

In Canada, the only producers are Lab Chrysotile Inc. and Jeffrey Mines Inc. Both companies mine only chrysotile. Lab Chrysotile owns Bell Asbestos Mines Ltd., which operates the Bell mine near Thetford Mines, Quebec, and Lac d'Amiante du Quebec Ltee., which operates the Black Lake mine near Thetford Mines. The Black Lake mine was closed for an indefinite period of time starting in 2004 (Mining Engineering, 2004). Jeffrey Mine Inc. operates its Jeffrey mine, near Asbestos, Quebec. In 2004, the mine was operating on a part-time basis (Gazette Montreal, 2003).

In China, Mang Ya Asbestos Mine, operating near Mang Ya, was the largest producer of asbestos (chrysotile) but there also were numerous other small producers of asbestos.

Production in Kazakhstan and Russia is exclusively chrysotile. JSC Kostanaiasbest operates a mine in Dzhetysayrinsk, Kazakhstan. In Russia, JSC Uralasbest operates a mine

in Sverdlovsk; JSC Orenburgasbest operates a mine in Orenburg; and JSC Tuvaasbest operates a mine in Tuva.

African Resources Ltd., through its subsidiary, African Associated Mines, operates the Shabanie chrysotile mine, south of Gweru, Zimbabwe, and the Gaths chrysotile mine, west of Masvingo.

The companies that mine asbestos almost always also process the crude asbestos. Exceptions would be for extremely small producing companies, possibly in China and India. Most companies, however, sell their processed fiber to other companies for the manufacture of products.

## Consumers

During the peak years, manufacturing companies were using asbestos in about 3,000 asbestos products or product categories (Quebec Asbestos Information Service, 1959, p. 19-20). The leading consumers of asbestos were the construction and automobile industries. The construction industry required asbestos for A/C products, flooring, insulation, plasters, roofing, siding, and wallboard. The automobile industry used

asbestos for brake lining and shoes, underbody coatings, and gaskets. Various other industries used asbestos in insulation, packing, and textiles.

The manufacturing industry that produced these materials is a mix of large and small companies. Large, often international, corporations manufacture such products as A/C pipe and sheet, brake pads and shoes, insulation board and paper, vinyl-asbestos tile, and wallboard. Other products, such as packing, asbestos-reinforced plastics, stucco paints, spackles, and textiles, may be manufactured by smaller companies because large economy of scale was not required to be competitive in those segments of the industry. In most countries, use of asbestos products has declined, and major corporations have withdrawn from the industry. However, large national manufacturing companies probably continue to operate in China, Kazakhstan, Russia, Thailand, and Ukraine.

All nations had a need for these asbestos products in the past, so manufacturing facilities are found worldwide. The industry thrived until the asbestos health issue arose. From 1900 through the 1960s, the United States was the leading manufacturer and consumer of asbestos products (table 19).

**Table 19.** Asbestos production, trade, and consumption in 1960

[In metric tons. ° estimated; NA, not available; --, zero. Information from Virta, 2003b, p. 36-37]

Region and country	Production	Imports	Exports	Consumption		
				Apparent <sup>1</sup>	Estimated <sup>2</sup>	
Africa:						
Algeria	--	6,189	--	6,189	NA	
Angola	--	819	--	819	NA	
Botswana	1,163	--	--	1,163	NA	
Egypt	450	6,583	--	7,033	NA	
Kenya	106	--	29	76	NA	
Morocco	--	2,676	--	2,676	NA	
Mozambique	20	720	80	660	NA	
South Africa	159,551	NA	193,696	-34,145	NA	
Swaziland	29,055	--	25,403	3,653	NA	
Tunisia	--	2	--	2	NA	
Uganda	--	830	--	830	NA	
Zimbabwe	121,537		116,060	5,477	NA	
Total	311,883	17,820	335,268	1-5,565	28,580	
Asia and the Middle East:						
Burma	--	468	--	468	NA	
China	81,288	--	--	81,288	NA	
Formosa (Taiwan)	440	1,047	--	1,487	NA	
Hong Kong	--	22	--	22	NA	
India	1,711	21,967	26	23,652	NA	
Indonesia	--	588	--	588	NA	
Iran	--	1,246	--	1,246	NA	

**28 Mineral Commodity Profiles—Asbestos**
**Table 19.** Asbestos production, trade, and consumption in 1960—Continued

[In metric tons. ° estimated; NA, not available; --, zero. Information from Virta, 2003b, p. 36-37]

Region and country	Production	Imports	Exports	Consumption	
				Apparent <sup>1</sup>	Estimated <sup>2</sup>
Asia and the Middle East—Continued:					
Lebanon	--	2,258	--	2,258	NA
Malaysia	--	2,868	--	2,868	NA
Philippines	33	1,236	--	1,268	NA
Thailand	--	6,433	--	6,433	NA
Turkey	216	470	5	682	NA
Total	99,780	122,728	68	222,440	222,440
Europe:					
Austria	--	12,767	63	12,764	NA
Belgium-Luxembourg	--	53,990	297	53,694	NA
Bulgaria	1,118	--	--	1,118	NA
Cyprus	21,153	--	15,575	5,578	NA
Czechoslovakia	--	27,422	--	27,422	NA
Denmark	--	17,440	26	17,414	NA
Finland	9,556	4,446	5,551	8,452	NA
France	25,583	68,592	10,790	83,385	NA
Germany, East	--	e35,000	--	e35,000	NA
Germany, West	--	132,634	226	132,408	NA
Greece	--	48	--	48	NA
Hungary	--	9,804	--	9,804	NA
Iceland	--	37	--	37	NA
Italy	51,123	29,607	7,409	73,322	NA
Netherlands	--	21,725	36	21,690	NA
Portugal	131	2,346	35	2,443	NA
Soviet Union <sup>3</sup>	599,499	--	146,115	453,384	NA
Spain	4	14,453	--	14,457	NA
Sweden	--	17,107	28	17,079	NA
Switzerland	--	8,695	--	8,695	NA
United Kingdom	--	170,893	7,874	163,019	NA
Yugoslavia	5,416	8,727	5,217	8,926	NA
Total	713,644	657,896	199,240	1,172,300	1,172,300
North and Central America:					
Canada	1,014,699	NA	969,372	45,327	NA
El Salvador	--	227	--	227	NA
Guatemala	--	226	--	226	NA
Jamaica	--	35	--	35	NA
Mexico	--	13,421	--	13,421	NA
United States	41,028	607,388	4,955	643,462	NA
Total	1,055,727	621,295	974,326	702,696	702,696

**Table 19.** Asbestos production, trade, and consumption in 1960—Continued

[In metric tons. ° estimated; NA, not available; --, zero. Information from Virta, 2003b, p. 36-37]

Region and country	Production	Imports	Exports	Consumption	
				Apparent <sup>1</sup>	Estimated <sup>2</sup>
South America:					
Bolivia	170	--	170	--	NA
Brazil	13,237	13,670	--	26,906	NA
Colombia	--	6,836	--	6,836	NA
Peru	--	1,813	--	1,813	NA
Venezuela	3,932	2,277	3,661	2,548	NA
Total	17,339	24,596	3,831	38,104	38,104
Grand total	2,212,825	1,486,118	1,520,263	2,178,681	2,212,826

<sup>1</sup>Apparent consumption calculated as production plus imports minus exports, not adjusted to account for changes in Government and industry stocks. Negative apparent consumption indicates sales from stocks.

<sup>2</sup>Estimated consumption excludes negative apparent consumption data and estimated additions to stockpiles for individual countries.

<sup>3</sup>Production and exports include Russia and Kazakhstan.

The leading consumers of the 1970s, the peak consumption years, were in Australia, Brazil, China, East and West Germany, France, India, Italy, Japan, the Republic of Korea, Mexico, Poland, Soviet Union, Spain, Thailand, the United Kingdom, the United States, and Yugoslavia. About 75 countries were importing asbestos for manufacturing purposes in 1975 (table 20; Virta, 2003, p. 40-41). By 2000, asbestos consumption had declined by more than 50 percent from that of 1975. Manufacturing of asbestos products in many countries

has ceased or has been reduced to extremely low levels. Many countries that were major consumers in the 1970s became minor participants in the world market (table 21). In 2003, the leading asbestos consuming nations were Brazil, China, India, Indonesia, Iran, Kazakhstan, Russia, Thailand, Ukraine, Uzbekistan, and Vietnam, based on exports and imports reported by the United Nations and world asbestos production data (United Nations, 2004; Virta, 2005; fig. 6, table 22).

**Table 20.** Asbestos production, trade, and consumption in 1975

[In metric tons. ° estimated; NA, not available; --, zero. Information from Virta, 2003b, p. 40-41]

Region and country	Production	Imports	Exports	Consumption	
				Apparent <sup>1</sup>	Estimated <sup>2</sup>
Africa:					
Algeria	--	4,582	--	4,582	NA
Congo (Kinshasa)	--	672	--	672	NA
Egypt	479	5,477	--	5,956	NA
Ghana	--	13,188	--	13,188	NA
Kuwait	--	5,666	--	5,666	NA
Kenya	--	743	--	743	NA
Libya	--	1,335	--	1,335	NA
Morocco	--	7,160	--	7,160	NA
Mozambique	--	740	1,148	-4081	NA
Nigeria	--	29,024	--	29,024	NA
Senegal	--	1,132	--	1,132	NA
South Africa	354,710	28,560	368,000	15,270	NA
Swaziland	37,601	--	41,219	-36,181	NA
Syria	--	3,391	--	3,391	NA

**30 Mineral Commodity Profiles—Asbestos**
**Table 20.** Asbestos production, trade, and consumption in 1975—Continued

[In metric tons. ° estimated; NA, not available; --, zero. Information from Virta, 2003b, p. 40-41]

Region and country	Production	Imports	Exports	Consumption	
				Apparent <sup>1</sup>	Estima- ted <sup>2</sup>
Africa—Continued:					
Tunisia	--	1,619	--	1,619	NA
Uganda	--	28	--	28	NA
United Arab Emirates	--	°2,000	--	°2,000	NA
Zambia	--	2,765	--	2,765	NA
Zimbabwe	261,542	--	°260,000	1,542	NA
Total	654,332	108,082	670,367	92,047	96,073
Asia and the Middle East:					
China	150,000	--	--	150,000	NA
Hong Kong	--	907	705	202	NA
India	20,312	41,514	--	61,826	NA
Indonesia	--	4,845	--	4,845	NA
Iran	--	24,814	--	24,814	NA
Iraq	--	1,482	--	1,482	NA
Israel	--	856	--	856	NA
Japan	4,612	253,097	2,158	255,551	NA
Korea, North	--	3,300	--	3,300	NA
Korea, Republic of	4,345	56,960	--	61,305	NA
Malaysia	--	19,932	--	19,932	NA
Pakistan	--	°7,000	--	e7,000	NA
Philippines	--	1,899	--	1,899	NA
Saudi Arabia	--	10,405	--	10,405	NA
Singapore	--	10,341	1,670	8,671	NA
Sri Lanka	--	789	--	789	NA
Taiwan	1,737	13,363	--	15,100	NA
Thailand	--	42,521	--	42,521	NA
Turkey	15,496	16,357	--	31,853	NA
Total	196,502	510,382	4,533	702,351	702,351
Europe:					
Austria	--	34,343	183	34,160	NA
Belgium-Luxembourg	--	60,549	1,721	58,828	NA
Bulgaria	--	28,812	--	28,812	NA
Canary Islands	--	288	--	288	NA
Cyprus	31,602	--	28,378	3,224	NA
Czechoslovakia	--	43,494	--	43,494	NA
Denmark	--	24,388	112	24,276	NA
Finland	2,791	10,132	3,512	9,411	NA
France	--	138,637	2,050	136,587	NA
Germany, East	--	65,725	--	65,725	NA

**Table 20.** Asbestos production, trade, and consumption in 1975—Continued

[In metric tons. ° estimated; NA, not available; --, zero. Information from Virta, 2003b, p. 40-41]

Region and country	Production	Imports	Exports	Consumption	
				Apparent <sup>1</sup>	Estimated <sup>2</sup>
Europe—Continued:					
Germany, West	--	386,188	73,770	312,418	NA
Greece	--	13,306	--	13,306	NA
Hungary	--	32,604	--	32,604	NA
Iceland	--	7	--	7	NA
Ireland	--	6,848	--	6,848	NA
Italy	146,984	66,273	81,073	132,184	NA
Netherlands	--	35,852	189	35,663	NA
Norway	--	5,629	--	5,629	NA
Poland	--	94,412	--	94,412	NA
Portugal	--	5,778	--	5,778	NA
Romania	--	41,299	--	41,299	NA
Soviet Union <sup>3</sup>	1,900,000	--	613,303	1,286,697	NA
Spain	--	94,114	--	94,114	NA
Sweden	--	15,529	173	15,356	NA
Switzerland	--	17,262	82	17,180	NA
United Kingdom	--	139,185	1,698	137,487	NA
Yugoslavia	12,336	52,138	3,170	61,304	NA
Total	2,093,713	1,412,792	809,414	2,697,091	2,697,091
North and Central America:					
Canada	1,055,667	5,166	1,085,610	-247,771	NA
Costa Rica	--	2,974	--	2,974	NA
El Salvador	--	3,866	--	3,866	NA
Guatemala	--	1,808	--	1,808	NA
Jamaica	--	1,307	--	1,307	NA
Mexico	--	60,395	--	60,395	NA
Nicaragua	--	1,207	--	1,207	NA
Panama	--	83	--	83	NA
United States	89,497	488,567	33,064	545,000	NA
Total	1,145,164	565,373	1,118,674	591,863	616,640
Oceania:					
Australia	47,922	49,794	24,524	73,192	NA
New Zealand	--	12,484	--	12,484	NA
Total	47,922	62,278	24,524	85,676	85,676
South America:					
Argentina	1,130	15,548	--	16,678	NA
Bolivia	--	°750	--	°750	NA
Brazil	73,978	29,800	--	103,778	NA

**Table 20.** Asbestos production, trade, and consumption in 1975—Continued

[In metric tons. ° estimated; NA, not available; --, zero. Information from Virta, 2003b, p. 40-41]

Region and country	Production	Imports	Exports	Consumption	
				Apparent <sup>1</sup>	Estimated <sup>2</sup>
Europe—Continued:					
Chile	--	°2,000	--	°2,000	NA
Colombia	--	°15,000	--	°15,000	NA
Ecuador	--	°3,000	--	°3,000	NA
Peru	--	°3,500	--	°3,500	NA
Uruguay	--	1,927	--	1,927	NA
Venezuela	--	15,548	--	15,548	NA
Total	75,108	87,073	--	162,181	162,181
Grand total	4,212,741	2,745,980	2,627,512	4,331,209	4,360,012

<sup>1</sup>Apparent consumption calculated as production plus imports minus exports, not adjusted to account for changes in Government and industry stocks. Negative apparent consumption indicates sales from stocks.

<sup>2</sup>Estimated consumption excludes negative apparent consumption data and estimated additions to stockpiles for individual countries.

<sup>3</sup>Production and exports include Russia and Kazakhstan.

**Table 21.** Asbestos production, trade, and consumption in 2000

[In metric tons. °, estimated; --, zero. Information from Virta, 2005; United Nations, 2004]

Country	Production	Imports	Exports	Apparent consumption <sup>1</sup>
Africa:				
Algeria	--	7,611	--	7,611
Angola	--	1,520	--	1,520
Benin	--	52	--	52
Burundi	--	200	--	200
Congo (Kinshasa)	--	122	--	122
Egypt	--	1,912	--	1,912
Ghana	--	1,071	--	1,071
Kenya	--	27	1	27
Malawi	--	15	--	15
Mauritius	--	42	--	42
Morocco	--	2,232	--	2,232
Mozambique	--	128	--	128
Namibia	--	--	(2)	(2)
Niger	--	40	--	40
Nigeria	--	7,222	--	7,222
Senegal	--	1,277	147	1,130
Sierra Leone	--	1	--	1
South Africa	18,782	10,842	34,695	-50,711
Swaziland	12,690	--	6,933	5,757
Tanzania	--	18	--	18
Tunisia	--	2,200	144	2,200

**Table 21.** Asbestos production, trade, and consumption in 2000—Continued[In metric tons. <sup>e</sup>, estimated; --, zero. Information from Virta, 2005; United Nations, 2004]

Country	Production	Imports	Exports	Apparent consumption <sup>1</sup>
Africa—Continued:				
Zambia	--	871	--	871
Zimbabwe	152,000	--	64,583	27,417
Total	183,472	37,404	106,502	54,518
Asia and the Middle East:				
Bangladesh	--	1,445	--	1,445
China	315,000	79,129	11,814	382,315
Hong Kong	--	1,135	--	1,135
India	21,000	124,433	403	145,030
Indonesia	--	42,877	--	42,877
Iran	2,000	38,707	--	40,707
Israel	--	20	--	20
Japan	--	85,440	--	85,440
Korea, Republic of	--	30,135	12	-121
Lebanon	--	975	--	975
Malaysia	--	17,711	--	17,711
Maldives	--	2	--	2
Mongolia	--	690	--	690
Myanmar	--	100	--	100
Nepal	--	<sup>(2)</sup>	--	<sup>(2)</sup>
North Korea	--	848	--	848
Oman	--	1	180	1
Pakistan	--	1,589	--	1,589
Philippines	--	2,631	--	2,631
Saudi Arabia	--	68	9,733	68
Singapore	--	3,014	24	2,990
Sri Lanka	--	12,640	--	12,640
Syria	--	2,010	--	2,010
Thailand	--	109,600	--	109,600
Togo	--	32	--	32
Tokelau	--	212	--	212
Turkey	--	27,569	--	27,569
United Arab Emirate	--	10,221	1	10,221
Vietnam	--	44,150	--	44,150
Yemen	--	172	--	172
Total	338,000	637,555	22,165	933,168
Europe:				
Austria	--	--	5	-5
Azerbaijan	--	7,149	--	7,149
Belarus	--	--	65	65



**34 Mineral Commodity Profiles—Asbestos**
**Table 21.** Asbestos production, trade, and consumption in 2000—Continued

 [In metric tons. <sup>c</sup>, estimated; --, zero. Information from Virta, 2005; United Nations, 2004]

Country	Production	Imports	Exports	Apparent consumption <sup>1</sup>
Europe—Continued:				
Belgium-Luxembourg	--	--	(2)	(2)
Bosnia-Herzegovina	--	21	--	21
Bulgaria	350	391	324	417
Croatia	--	3,655	--	3,655
Cyprus	--	324	(2)	324
Czech Republic	--	1,076	--	1,076
Estonia	--	180	(2)	180
France	--	20	46	-26
Georgia	--	5	--	5
Germany	--	212	--	212
Greece	--	90	8,946	-88,561
Hungary	--	3,456	--	3,456
Ireland	--	--	(2)	(2)
Kazakhstan	233,200	1,252	162,716	71,737
Kyrgyzstan	--	16,486	--	16,486
Latvia	--	1,124	--	1,124
Lithuania	--	1,305	643	643
Macadonia	--	48	--	48
Moldova	--	1,679	--	1,679
Netherlands	--	3	--	3
Norway	--	12	--	12
Poland	--	117	--	117
Portugal	--	3,437	36	3,401
Romania	--	10,658	--	10,658
Russia	750,000	31,656	332,417	449,239
Serbia-Montenegro	563	43	69	537
Slovakia	--	1,201	--	1,201
Slovenia	--	754	--	754
Spain	--	13,060	126	13,060
Sweden	--	--	12	-121
Switzerland	--	--	(2)	(2)
Tajikistan	--	450	--	450
Turkmenistan	--	979	(2)	979
Ukraine	--	80,942	--	80,942
United Kingdom	--	270	2	268
Uzbekistan	--	43,374	--	43,374
<b>Total</b>	<b>984,113</b>	<b>225,426</b>	<b>505,400</b>	<b>704,375</b>
Central and North America:				
Bahamas	--	515	--	515

**Table 21.** Asbestos production, trade, and consumption in 2000—Continued[In metric tons. <sup>c</sup>, estimated; --, zero. Information from Virta, 2005; United Nations, 2004]

Country	Production	Imports	Exports	Apparent consumption <sup>1</sup>
Central and North America— Continued:				
Canada	309,719	22	314,706	-49,651
Costa Rica	--	109	--	109
Cuba	--	5,512	--	5,512
Dominican Republic	--	200	--	200
El Salvador	--	1,460	2	1,460
Guatemala	--	20	2	18
Haiti	--	17	--	17
Honduras	--	2,437	--	2,437
Mexico	--	36,945	1	36,945
Panama	--	1,280	--	1,280
Trinidad	--	--	(2)	(2)
United States	5,260	14,849	18,975	-41,261
Total	314,979	62,851	333,686	38,886
Oceania: Australia	--	1,424	--	1,424
South America:				
Argentina	254	1,843	26	2,097
Bolivia	--	513	--	513
Brazil	209,332	26,362	63,134	172,560
Chile		1,969	158	1,811
Colombia	5,000	12,994	2	17,994
Ecuador	--	4,595	--	4,595
Paraguay	--	396	--	396
Peru	--	1,275	(2)	1,275
Uruguay	--	778	--	778
Venezuela	--	2,943	--	2,943
Total	214,586	53,668	63,320	204,963
Unknown trade destinations	--	14,630	--	14,630
Grand total	2,035,150	1,031,535	1,031,075	1,950,539

<sup>1</sup>Apparent consumption calculated as production plus imports minus exports, not adjusted to account for changes in Government and industry stocks. Negative value indicates sales from stocks.

<sup>2</sup>Less than ½ unit.

## Employment

Employment in asbestos mines and mills is difficult to assess in the world setting. The United States no longer mines asbestos, eliminating employment in that sector. Around 1976, employment in U.S. mines and mills was 265 miners and millers. Production in that year was about 104,000 t or about 390 metric tons per employee for mainly open pit operations (Clifton, 1980a). If productivity worldwide averaged

300 metric tons per year (t/yr) per person, world employment would have been about 7,200 persons in 2003, assuming only open pit mining and equivalent efficiencies in mining worldwide for a world production of 2.15 Mt. Given that there are many smaller underground mines still operating and efficiency probably is not as great in several countries, employment of 8,000 to 10,000 persons probably is a more accurate estimate of the number of miners and millers employed worldwide.

About 18 plants in the United States employed 418 workers to manufacture asbestos products in 1997, when U.S. apparent consumption was 21,000 t. This compares with 123 plants employing 13,900 workers in 1977, when U.S. apparent consumption was about 610,000 t (U.S. Census Bureau, 1999, p. 7; U.S. Department of Commerce, 1995, p. 32E-7; fig. 3). In 2004, probably less than 10 U.S. establishments manufactured asbestos products and employed less than 100 workers. This is roughly equivalent to about 40 to 60 t of apparent consumption per employee. Even using an estimate of 200 t of apparent consumption per employee based on the relative simplicity of producing A/C products, global employment would be between 10,000 to 13,000 persons.

Ironically, there probably is greater employment in many countries in the asbestos abatement field than in asbestos mining, milling, and manufacturing. The asbestos abatement sector expanded rapidly in the 1980s when schools, businesses, churches, and similar entities sought to remove asbestos-containing materials from their buildings. Asbestos abatement slowed as it was realized that containment and maintenance often offered a better and less expensive solution than removal. In 2002, there were about 2,280 workers in the United States involved with asbestos and lead abatement (Bureau of Labor

Statistics, 2004). Currently, most asbestos abatement jobs are associated with building renovations and demolitions.

## Market-Size and Reach

The size of the asbestos market has changed dramatically since the 1970s, when asbestos consumption peaked (figs. 2, 3). Markets for asbestos fiber are estimated to be about 2.15 Mt in 2003, assuming no waste from production and that all reported production was fiber and did not include some tailings used for crushed stone applications. This is an increase from an estimated 1.95 Mt in 2000, but less than half the peak consumption years of the 1970s. The number of countries importing asbestos does not appear to have changed significantly since the mid 1970s but tonnages imported have decreased. In 1975, there were many small countries importing 1,000 to 20,000 t/yr of asbestos. In 2003, estimated imports for many of these same countries declined to 100 to 3,000 t (United Nations, 2004; Virta, 2003, p. 40-41). The largest change in consumption between 1975 and 2003 was in the European Union and the United States, once the two leading consuming regions of the globe. Consumption in these two areas has declined to almost insignificant levels (fig. 6; tables 20-23).

**Table 22.** Asbestos production, trade, and consumption in 2003

[In metric tons. --, zero. Information from Virta, 2005; United Nations, 2004]

Region and country	Production	Imports	Exports	Apparent consumption <sup>1</sup>
Africa:				
Algeria	--	10,756	--	10,756
Angola	--	1,388	--	1,388
Benin	--	99	--	99
Egypt	--	2,382	--	2,382
Ghana	--	65	--	65
Kenya	--	96	(2)	96
Malawi	--	2	--	2
Morocco	--	1,478	--	1,478
Mozambique	--	372	--	372
Namibia	--	--	(2)	(2)
Nigeria	--	565	--	565
Senegal	--	1,628	377	1,251
South Africa	6,218	3,568	4,192	5,593
Sudan	--	91	--	91
Tanzania	--	6	--	6
Togo	--	259	--	259
Tunisia	--	1,020	--	1,020
Uganda	--	(2)	--	(2)
Zambia	--	408	--	408
Zimbabwe	147,000	1	73,854	73,147
Total	153,218	24,184	78,423	98,980

**Table 22.** Asbestos production, trade, and consumption in 2003—Continued

[In metric tons. --, zero. Information from Virta, 2005; United Nations, 2004]

Region and country	Production	Imports	Exports	Apparent consumption <sup>1</sup>
Asia and the Middle East:				
Bahrain	--	(2)	--	(2)
Bangladesh	--	2,802	--	2,802
China	350,000	141,185	3,472	487,714
Fiji	--	1	--	1
Guinea	--	4	--	4
Hong Kong	--	2	--	2
India	19,000	165,424	2,548	181,876
Indonesia	--	30,709	22	30,709
Iran	--	77,936	12	77,936
Iraq	--	12	--	12
Japan	--	21,245	22	21,245
Korea, North	--	1,265	--	1,265
Korea, Republic of	--	23,157	62	23,157
Malaysia	--	11,972	--	11,972
Mongolia	--	310	--	310
Myanmar	--	2	--	2
Nepal	--	25	--	25
Pakistan	--	2,810	--	2,810
Philippines	--	2,445	--	2,445
Saudi Arabia	--	7	--	7
Singapore	--	269	(2)	268
Sri Lanka	--	6,106	--	6,106
Syria	--	1,209	--	1,209
Thailand	--	112,880	127	112,753
Turkey	--	12,922	42	12,880
United Arab Emirates	--	10,241	--	10,241
Vietnam	--	39,832	--	39,832
Total	369,000	664,774	6,307	1,027,585
Europe:				
Austria	--	(2)	--	(2)
Azerbaijan	--	10,181	--	10,181
Belarus	--	--	61	-611
Belgium and Luxembourg	--	111	--	111
Bosnia and Herzegovina	--	--	1	-11
Bulgaria	--	108	(2)	108
Croatia	--	2,313	--	2,313
Czech Republic	--	1,610	(2)	1,610
Denmark	--	--	3	-31
Estonia	--	--	(2)	(2)

**Table 22.** Asbestos production, trade, and consumption in 2003—Continued

[In metric tons. --, zero. Information from Virta, 2005; United Nations, 2004]

Region and country	Production	Imports	Exports	Apparent consumption <sup>1</sup>
Europe—Continued:				
France	--	--	5	-5
Georgia	--	(2)	--	(2)
Germany	--	102	--	102
Greece	--	--	13	-131
Hungary	--	329	--	329
Iceland	--	3	--	3
Ireland	--	--	(2)	(2)
Kazakhstan	354,500	3,514	183,949	174,065
Kyrgyzstan	--	23,652	--	23,652
Lithuania	--	--	(2)	(2)
Macedonia	--	50	--	50
Moldova	--	956	7	956
Netherlands	--	2	--	2
Norway	--	22	--	22
Portugal	--	1,590	(2)	1,590
Romania	--	11,400	113	11,286
Russia	878,000	1,050	450,031	429,020
Slovakia	--	7,400	--	7,400
Spain	--	173	--	173
Switzerland	--	--	(2)	(2)
Tajikistan	--	490	--	490
Turkmenistan	--	1,849	--	1,849
Ukraine	--	156,393	--	156,393
United Kingdom	--	23	(2)	22
Uzbekistan	--	42,362	--	42,362
Total	1,232,500	265,681	634,182	864,006
Central and North America:				
Canada	194,350	209	194,774	-2,151
Cuba	--	9,896	--	9,896
Dominican Republic	--	75	--	75
El Salvador	--	2,600	--	2,600
Guatemala	--	--	(2)	(2)
Mexico	--	19,892	20	19,872
Panama	--	1,080	--	1,080
United States	--	4,557	3,548	1,009
Total	194,350	38,310	198,342	34,318
Oceania: Australia	--	20	1	19
South America:				
Argentina	166	17	--	183

**Table 22.** Asbestos production, trade, and consumption in 2003—Continued

[In metric tons. --, zero. Information from Virta, 2005; United Nations, 2004]

Region and country	Production	Imports	Exports	Apparent consumption <sup>1</sup>
Central and North America—Continued:				
Bolivia	--	1,159	--	1,159
Brazil	194,350	12,525	144,343	62,532
Colombia	5,000	8,118	--	13,118
Ecuador	--	1,458	--	1,458
Peru	--	659	<sup>(2)</sup>	659
Uruguay	--	<sup>(2)</sup>	--	<sup>(2)</sup>
Venezuela	--	1,464	--	1,464
Total	199,516	25,401	144,343	80,574
Unknown trade destinations	--	43,609	--	43,609
Grand total	2,148,584	1,061,980	1,061,598	2,149,091

<sup>1</sup>Apparent consumption calculated as production plus imports minus exports, not adjusted to account for changes in Government and industry stocks. Negative value indicates sales from stocks.

<sup>2</sup>Less than ½ unit.

**Table 23.** Changes in estimated apparent consumption, by decade<sup>1,2</sup>

[In metric tons. NA, data not available; XX, not applicable. Information from Virta, 2003b, p. 28]

	1920	1930	1940	1950	1960	1970	1980	1990	2000
World consumption	205,000	389,000	540,000	1,283,000	2,213,000	3,544,000	4,836,000	3,980,000	1,980,000
Africa	NA	11,200	-13,300	8,180	19,000	61,700	-16,500	-10,800	-8,540
Major changes:									
Algeria		XX	XX	+1,550	+4,640	XX	XX	XX	-9,770
Congo (Kinsasha)		XX	XX	+1,340	XX	XX	XX	XX	XX
Egypt		XX	XX	XX	+5,950	XX	XX	XX	XX
Nigeria		XX	XX	XX		+34,400	XX	-12,000	XX
South Africa		+13,800	-27,000	XX	-21,300	+48,400	-98,000	+78,800	XX
Swaziland		XX	XX	XX	XX	XX	XX	XX	+10,900
Zambia		XX	XX	XX	XX	+15,600	-15,600	XX	XX
Asia and the Middle East	NA	4,770	26,700	-12,900	197,000	447,000	394,000	-88,300	-11,600
Major changes:									
China		XX	XX	XX	+81,200	+91,400	+68,300	-55,300	+197,000
India		XX	+5,520	+5,610	+12,500	+26,100	+47,100	XX	XX
Indonesia		XX	XX	XX	XX	XX	XX	+57,900	XX
Iran		XX	XX	XX	XX	XX	XX	+48,900	-31,500
Japan		+6,230	+15,500	-14,400	80,200	+227,000	+79,400	-106,000	-207,000
Korea, Republic of		XX	+5,590	XX	XX	+36,000	XX	XX	-46,000
Saudi Arabia		XX	XX	XX	XX	XX	+52,200	-50,600	XX

**Table 23.** Changes in estimated apparent consumption, by decade—Continued<sup>1,2</sup>

[In metric tons. NA, data not available; XX, not applicable. Information from Virta, 2003b, p. 28]

	1920	1930	1940	1950	1960	1970	1980	1990	2000
Europe	NA	86,800	102,000	277,000	665,000	627,000	1,010,000	-222,000	-1,880,000
Major changes:									
Belgium and Luxembourg		+18,800	-19,100	+21,500	XX	XX	XX	XX	XX
Cyprus		+6,730	XX	XX	XX	XX	XX	XX	XX
France		XX	+19,100	+19,800	XX	+69,000	XX	XX	-63,600
Germany		+7,060	XX	+80,000	+52,400	XX	+191,000	-351,000	XX
Italy		XX	XX	XX	+48,500	+59,000	+48,200	-118,000	-62,400
Poland		XX	XX	XX	XX	+49,100	XX	XX	-65,500
Soviet Union, former		+36,700	+32,800	+65,300	+317,000	+227,000	+789,000	+681,000	-1,630,000
Spain		+5,480	XX	XX	XX	+62,300	XX	XX	XX
United Kingdom		XX	+71,800	XX	+55,400	XX	-56,400	-77,800	XX
Yugoslavia <sup>3</sup>		XX	XX	XX	XX	XX	XX	XX	-34,900
North and Central America	NA	82,500	18,900	454,000	-4,020	106,000	-255,000	-403,000	-112,000
Major changes:									
Canada		+61,300	-26,300	XX	XX	+50,000	XX	XX	-81,000
Cuba		XX	XX	XX	XX	XX	XX	XX	+4,010
Mexico		XX	XX	XX	XX	+27,000	+39,000	-39,700	XX
United States		+40,700	+44,600	+423,000	-16,700	XX	-309,000	-326,300	-36,600
Oceania	NA	-758	15,500	6,450	26,600	28,900	-6,130	-69,700	-282
Major changes:									
Australia			+14,700	+3,360	+25,700	+25,100	XX	-64,800	XX
South America	NA	-823	739	10,600	26,400	61,100	168,000	-61,200	1,040
Major changes:									
Argentina		XX	XX	XX	XX	+21,100	XX	-14,500	XX
Brazil		XX	XX	8,720	+17,600	XX	+157,000	-32,000	+9,320
Chile		XX	XX	XX	XX	XX	XX	XX	-5,940
Total world consumption change	NA	184,000	151,000	743,000	930,000	1,330,000	1,290,000	-855,000	-2,000,000

<sup>1</sup>Data are rounded to no more than three significant digits; may not add to totals shown.<sup>2</sup>Part of the change in consumption in such major asbestos-producing countries as Canada, the former Soviet Union, and South Africa includes asbestos added to or removed from company stocks in addition to that used in manufacturing.<sup>3</sup>Includes Bosnia, Croatia, Herzegovina, Macedonia, Montenegro, Serbia, and Slovenia.

## Prices

Prices for asbestos are negotiated between suppliers or agents and buyers. Prices are not set by large international markets, as is done for metals. In the United States, prices of domestically produced asbestos increased gradually through about 1970. Slight declines in actual prices were observed in the early 1930s, immediately after World War II, and in the

1960s. Prices rose significantly in the 1970s and remained relatively stable afterwards. The inflationary period of the 1970s and rising liability insurance costs are likely contributors to the large increase in the unit value of domestic asbestos observed after 1973, counter to declining U.S. markets. Except for a slight decline in the 1940s, the value of U.S. asbestos imports increased gradually through the 1970s. From about 1972, unit values increased significantly through the early 1980s after which they declined (fig. 11). Depressed markets and high

producer inventories in the mid-1980s resulted in negotiated asbestos prices being lower than listed prices (Kendall, 1980). Prices worldwide have increased slightly in recent years as a closer balance between supply and demand has been reached;

however, in the mid-1980s and 2000, Asian market declines depressed prices slightly. Mine closures with capacity reductions have helped balance supply and demand and stabilize prices recently.

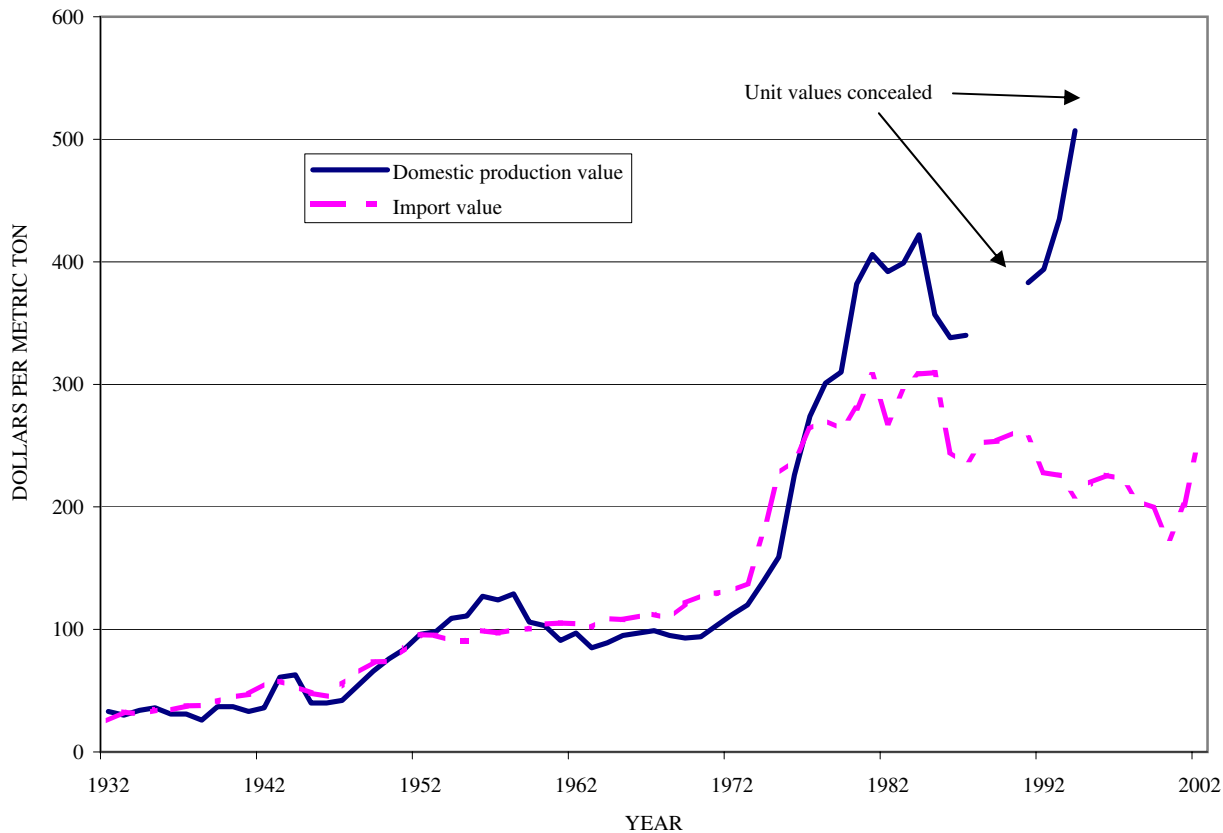

**Figure 11.** Average unit values of asbestos produced in and imported into the United States from 1932 to 2003. Data from U.S. Bureau of Mines, 1934-1996; U.S. Geological Survey, 1997-2005.

Prices for Canadian chrysotile in 2002 were \$144 to \$300 per metric ton for group 7; \$293 to \$420 per ton for group 6; \$472 to \$655 per ton for group 5; \$710 to \$995 per ton for group 4; and \$1,030 to \$1,244 per ton for group 3. Prices for South African chrysotile were \$200 to \$290 per ton for group 7, \$300 to \$350 per ton for group 6, and \$360 to \$440 per ton for group 5 (Industrial Minerals, 2002).

## Supply and Demand

### Components of Supply

Since the mid-1990s, the United States has been almost 100 percent dependent on imports (fig. 12). The bulk of the imports is from Canada, which supplied about 97 percent of asbestos imported into the United States through 2003. Other sources of asbestos are Brazil, South Africa, and Zimbabwe. All the asbestos imported into the United States is chryso-

tile. On a more global scale, Canada, Russia, and Zimbabwe are the leading suppliers of asbestos to world markets (Virta, 2005; fig. 1; table 2). The largest markets are in Asia, Kazakhstan, the Middle East, Russia, and the Ukraine. Brazil, China, and Kazakhstan are major producers of asbestos, but the bulk of their production is used within country (United Nations, 2004; Virta, 2003, p. 16, 58-59; table 21).

Currently, supply is balanced with world demands for asbestos fiber, although capacity is in excess of world needs. Demand is likely to decline because of threats of additional bans on asbestos worldwide and continued public opposition to its use. With six major producing countries of asbestos, shortages in supply in most fiber products probably is not likely in the near future. One supply concern is with the supply of specialty fiber products. This problem already presented itself when the Jeffrey Mine in Thetford, Quebec was closed in 2002. The mine and mill were reopened briefly to provide several years supply of a specialty fiber product to the National Aeronautics and Space Administration in the United States. The fiber was required for booster rocket components used for the U.S. space shuttle program (Perron, 2003).



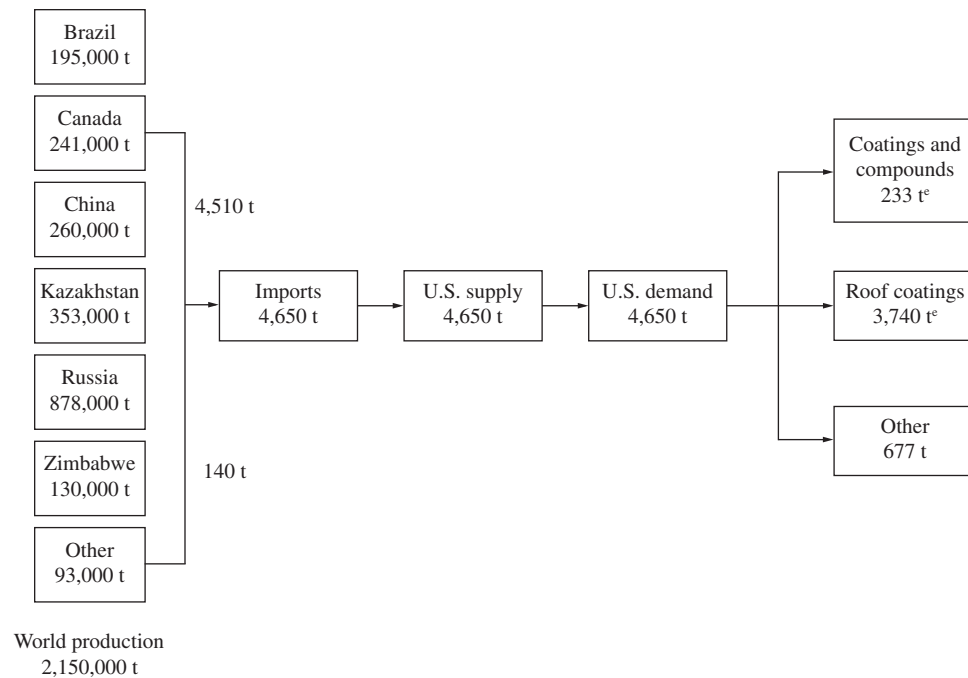

**Figure 12.** U.S. supply and demand relationship for asbestos in 2003. Only chrysotile was imported and used in the United States in 2003. <sup>ε</sup>, estimated; t, metric tons. Data from Virta, 2004b.

## International Trade

Trade of asbestos has shifted considerably throughout the 20th century. The United States was the leading consumer of asbestos worldwide until about 1950, consuming 37 to 99 percent of the world production annually between 1900 and 1950. It was the leading importer of asbestos for much of the 20th century. The major sources of asbestos for the United States were Canada, South Africa, and Zimbabwe.

Canada, the leading producer country through much of the 20th century, supplied most of the asbestos (all of which was chrysotile) used in U.S. markets. Canada eventually became a major supplier of chrysotile to Asia, Europe, and South America. With the downturn in asbestos use in Europe and the United States, Canada's export focus in 2003 was on Southeast Asian countries (India, Indonesia, Japan, and Malaysia) and Mexico.

Kazakhstan and Russia (combined) became major exporters of asbestos by the 1940s, supplying chrysotile to Eastern and Western Europe for decades, with smaller amounts being shipped to Asian countries. With the decline in asbestos usage in Western Europe since the late 1990s and significant declines even in the former Soviet bloc countries in Eastern Europe, export markets for Russia have shifted more towards Asia and the Middle East. China, India, Thailand, and Ukraine were the major markets for exported Russian fiber in 2003. Major markets in 2003 for asbestos exported by Kazakhstan were China, India, Kyrgyzstan, Ukraine, and Uzbekistan (United Nations, 2004).

South Africa was a major producer and supplier of asbestos (with more than 50 percent of production and sales being amosite and crocidolite) to the world. Before 1950, the United

Kingdom and the United States imported about 50 percent of South Africa's exports. Other important markets included Asia, the Middle East, and Europe. By the 1970s, South African export markets had shifted and Japan became the major importing country. In 2003, Asian markets were the leading destination for asbestos exports from South Africa.

Zimbabwe also was a major world supplier of chrysotile. Most of its exports through 1950 were to the United Kingdom, at which time the United States started importing more from South Africa. Other export markets included Asia, Europe, and Latin America. The bulk of exports from Zimbabwe was shipped to Brazil, India, Iran, Japan, Slovakia, and Thailand in 2003 (United Nations, 2004).

During the 1970s and 1980s, most of Brazil's output was used within country, but its markets slowly broadened. Brazil exported small amounts of asbestos worldwide but focused on such countries as China, Colombia, India, Indonesia, Iran, Japan, Malaysia, and Mexico in 2003.

Cyprus, Greece, Italy, and Swaziland once exported lesser amounts of asbestos to Africa, Asia, and Europe, but production and shipments from these countries have ceased.

China, while becoming a major producer of asbestos, has traditionally used most of its output within country. China has relatively small tonnages of exports relative to production.

In general, the downturn in the asbestos industries of Europe and the United States after 1990 has caused a shift in export markets to Asia (China, India, Indonesia, Japan, the Republic of Korea, Malaysia, Thailand, and Turkey), Iran, Mexico, and Ukraine. In 2003, China, India, Iran, Thailand, and Ukraine appear to be the leading asbestos consumers, dependent on imports for much of their manufacturing needs (United Nations, 2004; fig. 13).

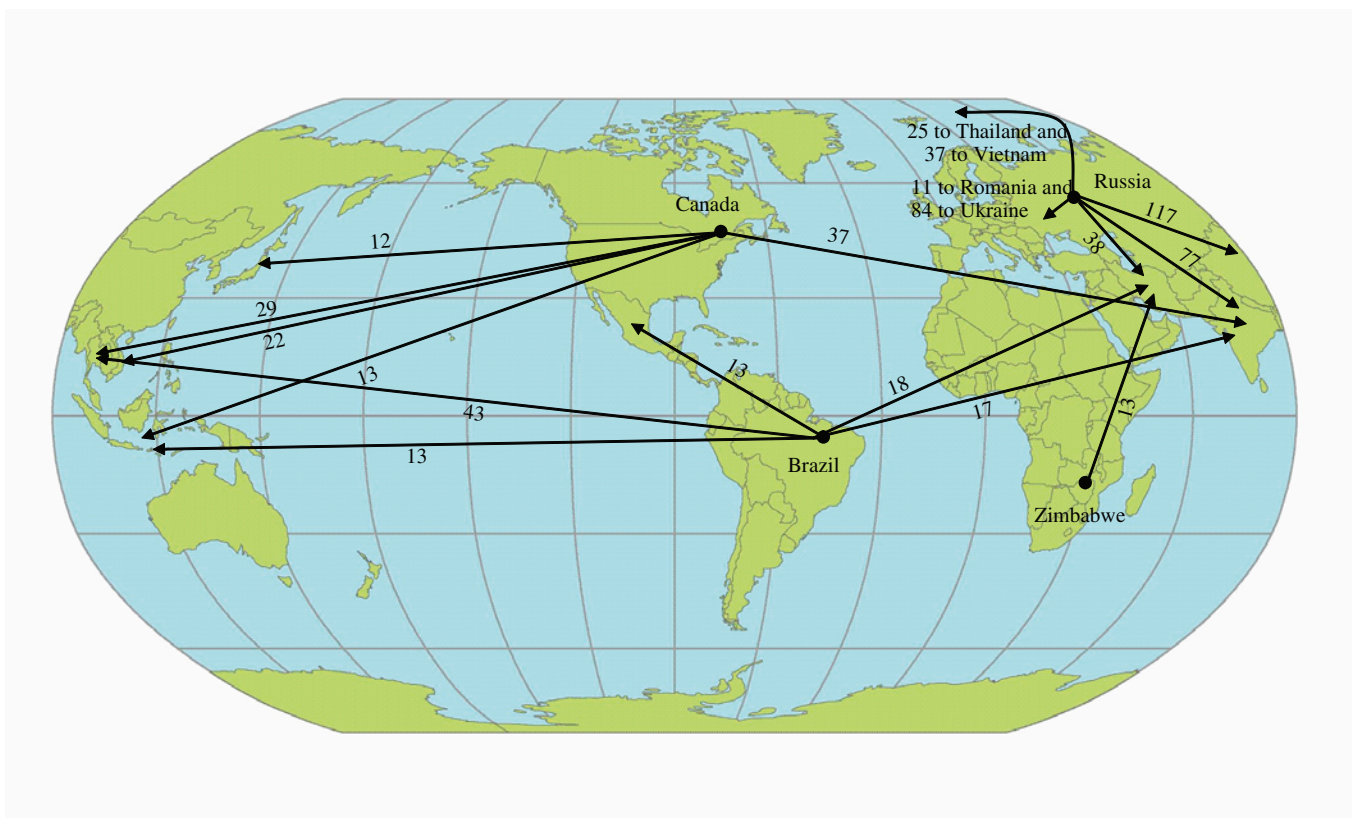

**Figure 13.** Asbestos export patterns in 2003 for annual shipments greater than 10,000 metric tons. Figures listed are in thousand metric tons.

## Strategic Considerations

Asbestos was considered to be essential for strategic military applications during wartime. These applications ranged from use in brakes, clutches, and gaskets on motor vehicles and generators to electrical insulation on aircraft and ships to plate separators in batteries for military and, much later, missile and space applications. Because of these uses, exports of U.S. asbestos were restricted during World War II. The same restrictions were enforced during the Korean conflict (Clifton, 1985). Since the 1980s, military needs for asbestos have declined as substitutes have become increasingly incorporated into commercial products and alternative products have become available. By 2001, the entire U.S. chrysotile stockpile had been sold, and amosite and crocidolite were removed from the stockpile (Virta, 2002a). Nearly all strategic applications for asbestos are now satisfied by asbestos substitutes or alternative products.

## Sustainability

In the United States, Western Europe, Australia, and many countries in South America, asbestos consumption has declined to insignificant levels or even ceased because

of liability issues and public opposition to its use. The only countries that have maintained significant levels of consumption are China, India, Iran, Kazakhstan, Russia, Thailand, and Ukraine. In these and several lesser consuming countries, use of asbestos is still accepted, and liability has not yet become a major issue with manufacturers. China, Kazakhstan, and Russia produce sufficient asbestos to meet their own needs with the exception of a few specialty imports as well as the needs of other countries, so asbestos supply is not a major issue. In Thailand, manufacturing a various products for world needs has resulted in a fairly high level of use of asbestos, an estimated 113,000 t in 2003. Although Thailand is not a producer of asbestos, adequate and reliable supplies are available. Manufacturing demands in India have resulted in increased demand for asbestos in recent years. In 2000, asbestos consumption was estimated to be 145,000 t. In 2003, consumption was estimated to be about 182,000 t, an increase of 26% in only 3 years. Being a larger consumer than producer, India has depended on imports to supply its needs. The increased demands for asbestos in India and Thailand have not resulted in any shortages on the world market. For Canada, global markets for asbestos have declined, so in conjunction, the number of Canadian producers also has declined. In general, sustainability is not a matter of resources and production capability but one of liability issues and social acceptance of asbestos products.

## Economic Factors

### Production and Transportation

Costs for mining and milling asbestos take into consideration capital investments, deposit characteristics (that affect mine type), market prices, payroll, research, and transportation mode distances to markets, and utilities. Costs for exploration, acquisition of land or leases, mine and plant design, and building construction also are considered. In 1962, the cost from design to completion of an asbestos mill near Copperopolis, Calif., was about \$10 million (Huttl, 1962). In 1958, Lake Asbestos of Quebec, Ltd., developed a mine and mill at Black Lake, Quebec. About \$9.2 million was for construction of the mill alone. The total cost to explore, test, design the mine and mill, drain 55 billion gallons of water from Black Lake, and build the mine and mill required about \$36 million (Grindrod, 1959).

Open pit or block caving dominated in chrysotile mines. For the amphibole asbestos, deposits were such that mining was very labor intensive, and mining methods varied considerably; recovery rates, however, were very good. The costs to mine and mill all types of asbestos fiber, as determined in 1982, ranged from \$100 to more than \$700 per ton. At the mine, most cost estimates were in the \$100-to-\$199-per-ton range. At the mill, cost estimates ranged from \$100 to more than \$700 per-ton. Most mill estimates were in the range of \$100-to-\$299-per-ton range (Anstett and Porter, 1985, p. 12). Average costs for mines in major market economy producing countries are presented in table 24. Transportation costs from mine to consuming nation vary considerably depending on the transportation available and the distance from the mill to the market. In some instances, fiber was transported more than 1,500 km by truck. In other instances, it was necessary to use several transportation modes (truck, barge, and freighter) to reach distant markets. Estimated transportation costs as determined in 1982 are presented in table 25.

**Table 24.** Mining methods and operating costs, January 1982

[do, ditto. Am, amosite; C, combined methods; Ch, chrysotile; Cr, crocidolite; N, nonproducer; P, producer; PP, past producer; S, surface; U, underground. Information from Anstett and Porter, 1985, p. 12]

Property name and location	Mining method	Status <sup>1</sup>	Type	Fiber grades	Fiber type	Recoverable fiber		
						Cost at mine (dollars)	Cost at mill (dollars)	
United States:								
Alaska: Slate Creek	Open pit	N	S	4	Ch	100-199	200-299	
Arizona: El Dorado	Room and pillar	PP	U	3, 4, 7	Ch	Greater than 700	500 to 599	
California:								
Calaveras	Open pit	PP	S	4, 5, 6	Ch	100-199	200-299	
Christie	do	PP	S	7	Ch	Less than 199	100-199	
Santa Rita	do	PP	S	7	Ch	Less than 199	Less than 199	
Vermont: Lowell	do	PP	S	3, 4, 5, 6, 7	Ch	100-199	300-399	
Australia: Woodsreef	do	PP	S	4, 5, 6	Ch	500 to 599	Greater than 700	
Brazil: Cana Brava	do	P	S	4, 5, 6	Ch	Less than 199	Less than 199	
Canada:								
Abitibi	Open stope	N	U	4, 5, 6, 7	Ch	300-399	200-299	
Asbestos Hill	Open pit; sublevel cave	P	C	4, 5, 7	Ch	300-399	200-299	
Baie Verte	Open pit	P	S	4, 5, 6	Ch	300-399	100-199	
Bell	Block cave	P	U	3, 4, 5, 6, 7	Ch	100-199	100-199	
Black Lake	Open pit	P	S	3, 4, 5, 6, 7	Ch	100-199	100-199	
British Canadian	do	PP	S	3, 4, 5, 6, 7	Ch	100-199	100-199	
Carey Canada	do	PP	S	4, 5, 6, 7	Ch	Less than 199	Less than 199	
Cassiar	Open pit; sublevel stope	PP	C	3, 4, 5, 6	Ch	100-199	100-199	
Jeffrey	Open pit; stope	PP	C	4, 5, 6, 7	Ch	100-199	100-199	
King-Beaver	Open pit; block cave	P	C	3, 4, 5, 6, 7	Ch	100-199	100-199	

**Table 24.** Mining methods and operating costs, January 1982—Continued

[do, ditto. Am, amosite; C, combined methods; Ch, chrysotile; Cr, crocidolite; N, nonproducer; P, producer; PP, past producer; S, surface; U, underground. Information from Anstett and Porter, 1985, p. 12]

Property name and location	Mining method	Status <sup>1</sup>	Type	Fiber grades	Fiber type	Recoverable fiber	
						Cost at mine (dollars)	Cost at mill (dollars)
Canada—Continued:							
Midlothian	Open pit	PP	S	4, 5, 6, 7	Ch	Less than 199	100-199
National	do	P	S	3, 4, 5, 6, 7	Ch	Less than 199	100-199
Penhale	Block cave; modified cave	N	U	3, 4, 5, 6, 7	Ch	100-199	100-199
Roberge Lake	Open pit	N	S	5, 6, 7	Ch	100-199	100-199
Colombia: Las Brisas	do	P	S	4, 6	Ch	100-199	100-199
Cyprus: Amiandos	do	PP	S	3, 4	Ch	100-199	100-199
Greece: Zidani	do	PP	S	4, 5, 6	Ch	Less than 199	100-199
Italy: Balangero	do	PP	S	4, 5, 6, 7, 8	Ch	Less than 199	100-199
Mexico: Pegaso	do	N	S	5, 6, 7	Ch	Less than 199	100-199
South Africa:							
Danielskuil	Room and pillar; semishrinkage stope	PP	U	3, 4	Cr	300-399	300-399
Elcor	Room and pillar	PP	U	3, 4	Cr	100-199	100-199
Emmarentia	Room and pillar; semishrinkage stope	PP	U	3, 4	Cr	100-199	Less than 199
Klipfontein	Cut and fill	PP	U	3, 4	Cr	100-199	100-199
Msauli	Sublevel cave	PP	U	4, 5, 6, 7	Ch	100-199	100-199
Penge	Breast stope	PP	U	3, 4	Am	100-199	100-199
Pomfret	Room and pillar	PP	U	3, 4, 6	Cr	100-199	100-199
Riries	do	PP	U	3, 4	Cr	200-299	200-299
Senekal	Sublevel stope	PP	U	5, 6, 7	Ch	100-199	100-199
Wandrag	Room and pillar	PP	U	3, 4	Cr	100-199	Less than 199
Whitebank	do	PP	U	3, 4	Cr	100-199	200-299
Swaziland: Havelock	Sublevel cave; shrinkage stope	PP	U	4, 5	Ch	200-299	100-199
Zimbabwe:							
Gath's	Open pit; cave; shrinkage stope	P	C	4, 5	Ch	300-399	100-199
King	Panel retreat cave	P	U	4, 5	Ch	100-199	Less than 199
Shabanie	Prebreak cave	P	U	2, 3, 4, 5, 6	Ch	200-299	300-399

<sup>1</sup>Updated in 2003.

## Energy Requirements

Energy required by the U.S. asbestos mining industry in 1973 averaged an equivalent to 10.6 million British thermal units (MBtu) per metric ton of cleaned and graded chrysotile product. The survey covered all producers in Arizona, California, North Carolina, and Vermont and included estimates of energy content for various fuels used in mining and milling. On a tonnage basis, energy used was equivalent to 1,500 kilowatthours per ton (kWh/t) of usable fiber (table 26). Estimated costs for producing asbestos were \$3.5 million or \$25.86 per ton calculated in 1983 dollars. The ease of mining the Coalinga deposit kept the average U.S. energy require-

ments low (Clifton, 1985). In 1976, energy requirements at a large Canadian mine and mill were higher at 2,725 to 3,110 kWh/t than those of the average U.S. producer requirements (Clifton, 1985; table 27).

A study of the energy content of three cladding materials was done in the United Kingdom in 1979 for the Asbestos Information Centre. The study started at the mines for the raw materials and ended at the building sites. All relevant and significant energy expenditures and credits were calculated. The study determined that 16.42 kilowatthours (kWh) of energy was required to manufacture a square meter of corrugated asbestos cement sheet, 68.92 kWh was required for a square meter of corrugated aluminum sheeting, and 123.5 kWh was

**Table 25.** Estimated mill-to-market fiber transportation costs in January 1982

[In 1982 constant dollars per metric ton. NA, not available; -- zero. Information from Anstett and Porter, 1985, p. 15]

	Cost to destination				
	North America <sup>1</sup>	Central and South America <sup>2</sup>	Europe <sup>3</sup>	Africa and Middle East <sup>4</sup>	Asia <sup>5</sup>
Australia	NA	90	NA	120	80
Brazil	NA	60	NA	NA	NA
Canada:					
Eastern	50	80	120	130	210
Western	210	190	250	270	180
Cyprus	NA	NA	100	--	80
Greece	NA	NA	80	80	130
Italy	NA	NA	50	NA	NA
South Africa:					
Northern Cape	130	180	160	100	150
Northern Transvaal	80	130	110	40	100
Eastern Transvaal <sup>6</sup>	80	130	120	50	100
Zimbabwe	100	150	140	70	130

<sup>1</sup>Major consuming centers for Canadian asbestos are Montreal, New York, and Toronto; major consuming center for all other fiber is New York.<sup>2</sup>Major consuming centers are Brazil, Colombia, and Mexico.<sup>3</sup>Major consuming centers are Belgium, France, and West Germany.<sup>4</sup>Major consuming centers in the Mediterranean area are Egypt and Saudi Arabia; for South African deposits, figures presented reflect transportation to internal markets only.<sup>5</sup>Major consuming centers are Japan and the Republic of Korea.<sup>6</sup>Includes Swaziland.**Table 26.** Energy used by the U.S. asbestos mining industry in 1985

[--, zero. Information from Clifton, 1985]

Source	Used in mining	Used in milling	Total used	Total (thousand kilowatt-hour equivalent)
Heavy fuel oil, thousand gallons	852	1,345	2,197	96,358
Natural gas, million cubic feet	--	168	168	50,736
Electricity, thousand kilowatt-hours	2,641	44,974	47,615	47,615
Diesel oil, thousand gallons	412	133	545	22,147
Liquid petroleum gas, thousand gallons	14	168	182	6,987
Gasoline, thousand gallons	52	12	64	2,343
Total energy, thousand kilowatt-hours	59,192	166,994	226,186	226,186



**Table 27.** Energy consumed in the production of one metric ton of cleaned and graded chrysotile asbestos<sup>1</sup>

[Btu, British thermal unit. Information from Clifton, 1985]

Stage and type of fuel	Amount	Thousand Btu equivalent
Mining: <sup>2</sup>		
Electric	42 kilowatthours	550
Diesel fuel oil	11.12 gallons	1,852
Bunker 6C oil	1.46 gallons	270
Kerosene	0.04 gallon	8
Gasoline	0.51 gallon	77
Total		2,757
Primary crushing: Electric	7 kilowatthours	87
Secondary crushing	75 kilowatthours	983
Drying:		
Electric	42 kilowatthours	550
No. 2 fuel oil	0.54 gallon	90
Bunker 6C oil	15.40 gallons	2,859
Propane	0.12 gallon	13
Total		3,512
Milling and grading: Electric	249 kilowatthours	3,269
Grand total		10,608

<sup>1</sup>Mine-plant transportation not included.<sup>2</sup>Based on a large Quebec mine with 3-to-1 waste-to-ore ratio, 6 percent fiber per ton of ore, and 25 to 30 inches of mine precipitation per year.

required for a square meter of plastic coated corrugated sheet steel (Schatzberger, 1979).

## Environmental, Health, and Safety Issues

Asbestos-related disease is one of the most widely studied subjects of modern epidemiology. Asbestos diseases include asbestosis, a lung fibrosis resulting from long-term, high-level exposures to airborne fibers; lung cancer, usually resulting, from long-term high-level exposures and often correlated with asbestosis; and mesothelioma, a rare form of cancer of the lining (mesothelium) of the thoracic and abdominal cavities (Agency for Toxic Substances and Disease Registry, 2001, p. 17-22; Omenn and others, 1986).

Concerns over its health effect were first raised in the early 1900s in the United Kingdom, but it was not until the early 1960s that researchers established a positive correlation between worker exposure to asbestos fibers and respiratory cancer diseases (Selikoff, Churg, and Hammond, 1964; Murray, 1990). This triggered a significant research effort on the effects of fiber size, shape, durability or persistence in the lung, trace elements, and exposure duration and levels towards health (Churg and Wright, 1994; van Oss and others,

1999; Rice and Heineman, 2003). It is generally agreed that the inhalation of long (length generally greater than or equal to 5 micrometers), thin, and durable fibers in high concentrations over a long period of time pose the greatest health risk. Shorter fibers penetrate deeper into the lung but longer fibers are more difficult to clear (Finkelstein and Dufresne, 1999; Agency for Toxic Substances and Disease Control, 2001, p. 6; Johnson and Mossman, 2001). Fiber solubility is suggested to be the second most critical factor. Chrysotile is more soluble than amphibole asbestos and is removed more rapidly from the lung, reducing its residence time in the lung. Duration of exposure to asbestos is important because long exposure periods increase lung burden; additionally, long and/or high exposure levels counteract the effects of fiber solubility. Different asbestos types also appear to activate phagocytic leukocytes at different levels, with crocidolite and some chrysotile samples being the most active (van Oss and others, 1999). Some research suggests that iron content may be an important factor in asbestos-induced toxicity (Agency for Toxic Substances and Disease Registry, 2001, p. 51).

While still debated, many health scientists believe that there is sufficient evidence to state that the genotoxic and carcinogenic potentials of all asbestos fiber types are not identical; in particular, mesothelial cancer may be most strongly associated with amphibole fibers (Gardner and Powell, 1986; Agency for Toxic Substances and Disease Registry, 2001, p.

6; Gibbs, 2001, p. 165; Wilson and Price, 2001; Bernstein, Chevalier, and Smith, 2003, p. 1387; Bernstein, Rogers, and Smith, 2003, p. 1247).

The issue of asbestos as a contaminant in other types of mined ore bodies also is a concern (Nolan, Langer, and Wilson, 1999; Hull, Abraham, and Case, 2002; Peipins and others, 2003). As a means of defining the types of ore bodies that may contain asbestos as a contaminant, two studies were recently conducted on talc and vermiculite deposits. In the study of U.S. talc deposits, talc formed through hydrothermal processes consistently lacked amphiboles as accessory minerals. In contrast, talc deposits formed through contact or regional metamorphism consistently contained amphiboles, locally as asbestiform varieties (Van Gosen and others, 2004, p. 920). In U.S. vermiculite deposits, preliminary studies suggest that fibrous amphiboles are most likely to be associated with zoned, alkalic/calcic, quartz-poor plutons, as with the vermiculite deposit once mined near Libby (Van Gosen and others, 2002).

More recently, natural occurrences of asbestos have been an issue in California. In the past 5 to 10 years, development has moved into areas of serpentinite outcrops. These outcrops contain veins of chrysotile and some tremolite asbestos. New residents are now concerned about the risk to themselves and their children. This has resulted in a massive effort to map potential asbestos-bearing rock outcrops and analyze the health risk that exposure to the chrysotile may pose (Churchill and Hill, 2000; Clinkenbeard, Churchill, and Lee, 2002, p. 1-7; California Air Resources Board, 2004).

Disposal of asbestos products also has an environmental impact. More fibers may be released into the environment through improper removal and disposal than if the asbestos had remained in place (U.S. Environmental Protection Agency, 2004a).

## Liability

The incidence of disease associated with exposure to high levels of airborne asbestos fibers has resulted in a large liability risk for past and current producers, manufacturers, and installers. Liability became a major issue for companies beginning in the late 1970s. In the United States and elsewhere, asbestos producers and manufacturers of asbestos products began facing an increasing number of large class action lawsuits filed on behalf of those suffering from asbestos-related diseases (Virta, 2002b, p. 15).

Legal expenses and the availability of insurance are major deterrents for companies to maintaining old asbestos markets, generating new ones, and even to remaining involved in the asbestos industry. Johns-Manville Corp. (J-M) was one of the first major companies to face litigation. J-M was the leading producer of asbestos among the market economy countries

and the leading manufacturer of asbestos-containing products in the United States. In 1982, J-M filed a bankruptcy petition under chapter 11 of the Federal Bankruptcy Code to relieve the burden of 16,500 outstanding asbestos-related lawsuits. The outcome was the reorganization of J-M as Manville Corp. and the establishment of a trust fund through which J-M would handle claims. Although financed at \$1.8 billion initially and eligible to receive 20 percent of Manville Corp. profits, the trust had to suspend operations several times owing to the overwhelming debt burden. By 2000, the trust faced nearly 500,000 claims and had paid out \$2.2 billion. Other large companies (including Armstrong World Industries, Inc.; Eagle-Picher Industries Inc.; H.K. Porter Co.; W.R. Grace and Co.; and U.S. Gypsum Corp.) also have filed bankruptcy proceedings for debt relief from asbestos claims (Butler, 2002; White, 2002, p. 23-24). By 2002, companies had already paid an estimated \$21.6 billion to settle asbestos claims. Estimates of costs during the next 20 years have varied from \$3.4 billion to nearly \$200 billion (Butler, 2002). It was hoped that trusts, such as that of J-M, would reduce the cost of litigation by eliminating the need for companies to contest each liability through the use of a fixed compensation for various asbestos diseases. In 1982, much of the expense of asbestos claims was owing to legal expenses. RAND Corp. estimated that the plaintiffs' legal expenses accounted for 30 percent of the amount paid out in compensation and the defendants' legal expenses composed 33 percent. It was estimated that only 37 percent of expenditures were received by claimants as compensation after expenditures (White, 2002, p. 8).

Claimant strategies have also changed in recent years as more companies that used to mine asbestos or manufacture asbestos products have filed for bankruptcy protection. Claims are now being filed against companies with only an ancillary connection to asbestos in an effort to increase the monetary base through which claims are settled. Automobile manufacturers and repair shops that installed asbestos brakes and clutches, oil companies and manufacturing and warehousing facilities that used asbestos products (such as asbestos gaskets, insulations, and roofing on their property), and even corporations that purchased companies that were involved with asbestos (such as Halliburton Corp.) have now routinely been named in suits (White, 2002).

Because of the rash of bankruptcies, bills have been introduced in Congress that would establish a national trust, funded by the insurance industry and companies that mined, manufactured, and sold asbestos or asbestos products, to deal with the asbestos liability issue. The funding for the trust would be in excess of \$100 billion and would establish criteria that claimants must meet to qualify for eligibility consideration under the trust. So far, several attempts to enact these bills in Congress have not met with success and debates over eligibility requirements and compensation levels continued (Virta, 2004b, p. 8.1; 2005).



## Tariffs and Taxes

### Tariffs

No tariffs are levied on imported asbestos, and no special taxes are levied on the asbestos industry (U.S. International Trade Commission, 2004a).

### Depletion Provisions

Producers are granted a depletion allowance of 22 percent on domestic production and 10 percent on foreign production (Internal Revenue Service, 2004).

## Government Programs

Additional costs are incurred for environmental programs established by governments worldwide. The United States and other countries have enacted increasingly strict exposure regulations since the 1970s as concern increased over the health risks posed by low-level exposures to asbestos. More emphasis is being placed on environmental exposures than in the past. Current limits to asbestos exposure are 2.0 fibers per cubic centimeter (f/cm<sup>3</sup>) of air for mine sites for an 8-hour time weighted average and 0.1 f/cm<sup>3</sup> in all other occupational sites for an 8-hour time weighted average. The Occupational Safety and Health Administration (OSHA) proposed the change to 0.1 f/cm<sup>3</sup> 1994 from 0.2 f/cm<sup>3</sup> for sites other than mines. This proposed reduction was estimated to have a cost of compliance of \$14.8 million per year for the general industry sector, \$346.5 million per year for the construction sector, and \$93,000 per year for the shipyard sector (Occupational Safety and Health Administration, p. 40964, 41050).

Handling producers, bag houses, and ventilation are used to control worker exposure to asbestos in the workplace. The U.S. Environmental Protection Agency (EPA) also set standards for the release of fiber in water systems and the air. Criteria for removal and disposal of asbestos and asbestos-containing materials also are in place under EPA and OSHA standards (Occupational Safety and Health Administration, 2004; U.S. Environmental Protection Agency, 2004b).

Some countries have opted for a broader approach and have adopted more severe regulations that ban or restrict asbestos imports and types of applications. Countries that either have banned (either a complete ban or a ban with exemptions) or are phasing out the use of asbestos or asbestos products by 2005, include Argentina, Austria, Belgium, Chile, Denmark, Finland, France, Germany, Italy, the Netherlands, Norway, Poland, Saudi Arabia, Sweden, Switzerland, and the United Kingdom (Virta, 2002b, p. 15; International Ban Asbestos Secretariat, 2004). The European Union banned asbestos use by its members in most applications in 2005.

In the United States in 2003, legislation was introduced into Congress to ban the use of asbestos, with some exceptions. Attempts by Congress to ban asbestos in the United States have not been successful.

## Outlook

The asbestos industry will continue to face strong opposition to the use of asbestos. This opposition has had a significant impact in the form of approximately 50 percent of the 1973 market being lost. The use of asbestos in most countries has declined during the past 20 years. In many countries that use low tonnages of asbestos, consumption has remained relatively unchanged. The trend of declining use is likely to continue in some countries because substitutes are becoming more widely available worldwide and health and liability issues are beginning to arise in countries previously asbestos had not been subject to scrutiny. The rates of decline probably will be less in China, Kazakhstan, Latin America, Russia, and Southeast Asia because of their historically strong dependence on asbestos products and their current economic and political situations favoring the continued use of asbestos. Use in India and Thailand may also continue at current levels for the next few years because those countries have become a source for asbestos product exports to the Southeast Asian community.

## References Cited

- Addison, W.E., Neal, G.H., and White, A.D., 1966, Amphiboles—Part IV—Surface properties of amosite and crocidolite: *Journal of the Chemical Society*, section A, p. 79-81.
- Agency for Toxic Substances and Disease Registry, 2001, Toxicological profile for asbestos: Web site at <http://www.atsdr.cdc.gov/toxprofiles/tp61.html>. (Accessed January 5, 2004).
- Alleman, J.E., and Mossman, B.T., 1997, Asbestos revisited: *Scientific American*, v. 277, no. 1, July, p. 70-75.
- Anonymous, 1928, Asbestos—Its sources, extraction, preparation, manufacture, and uses in industry and engineering: Berlin, Becker & Haag GmbH, 88 p.
- Anonymous, 1953, Asbestos fact book: Willow Grove, Pa., Stover Publishing Co., 19 p.
- Anstett, T.F., and Porter, K.E., 1985, Asbestos availability—Market economy countries: U.S. Bureau of Mines Information Circular 9036, 21 p.
- Asbestos Textile Institute and Quebec Asbestos Mining Association, 1975, Chrysotile asbestos test manual—1974: Quebec, Quebec Asbestos Mining Association, 150 p.

- Aveston, J., 1969, The mechanical properties of asbestos: *Journal of Material Science*, v. 4, no. 3, p. 625-633.
- Badollet, M.S., 1951, Asbestos—A mineral of unparalleled properties: *Transactions of the Canadian Institute of Mining & Metallurgy*, v. 54, p. 151-160.
- Bates, R.L., 1969, Metamorphic minerals—Asbestos, *in* *The geology of industrial minerals and rocks*: New York, Dover Publications, p. 317-328.
- Bernier, C.F., 1984, Mining and processing at Lac d'Amiante du Québec, Ltee.: Littleton, Colo., Society of Mining Engineers, American Institute of Mining, Metallurgical, and Petroleum Engineers, Inc. Preprint 84-27, 5 p.
- Bernstein, D.M., Chevalier, Jörg, and Smith, Paul, 2003, Comparison of Calidria chrysotile asbestos to pure tremolite—Inhalation biopersistence and histopathology following short-term exposure: *Inhalation Toxicology*, v. 15, no. 14, December, p. 1387-1419.
- Bernstein, D.M., Rogers, Rick, and Smith, Paul, 2003, The biopersistence of Canadian chrysotile asbestos following inhalation: *Inhalation Toxicology*, v. 15, no. 13, November, p. 1247-1274.
- Boettcher, A.L., 1966, The Rainy Creek igneous complex near Libby, Montana: University Park, Pa., The Pennsylvania State University PhD. dissertation, 155 p.
- Bowles, Oliver, 1934, Asbestos: U.S. Bureau of Mines Information Circular 6790, June, 24 p.
- Bowles, Oliver, 1935, Asbestos—General information: U.S. Bureau of Mines Information Circular 6817, 21 p.
- Bowles, Oliver, 1946, Asbestos—The silk of the mineral kingdom: New York, Ruberoid Co., 39 p.
- Bradfield, R.E.N., 1977, Asbestos: Surrey, United Kingdom, Atkins Research and Development, January, 101 p.
- Buckingham, D.A. and Virta, R.L., 2002, Asbestos statistics: Web site at <http://minerals.usgs.gov/pubs/of01-066/#data>. (Accessed June 18, 2004).
- Bureau of Labor Statistics, 2004, Hazardous materials removal workers: Web site at <http://www.bls.gov/oco/ocos256.htm>. (Accessed October 12, 2004).
- Butler, Richard, 2002, The cost of asbestos: *Chemistry and Industry*, no. 22, November 18, p. 10.
- California Air Resources Board, 2004, Naturally occurring asbestos—General information: Web site at <http://www.arb.ca.gov/toxics/asbestos/geninfo.htm>. (Accessed November 9, 2004).
- Campbell, W.J., Blake, R.L., Brown, L.L., Cather, E.E., and Sjoberg, J.J., 1977, Selected silicate minerals and their asbestiform varieties: U.S. Bureau of Mines Information Circular 8751, 55 p.
- Canada NewsWire, 2000 (December 27), Cassiar mill damaged by fire: Web site at <http://www.newswire.ca/releases/December2000/27/c6332.html>. (Accessed December 30, 2000).
- Cape Asbestos Fibres Ltd., [undated], Test methods for blue and amosite asbestos fibers: Southwick, United Kingdom, The Grange Press, 39 p.
- Cassiar Mines and Metals Inc., 1999, Cassiar magnesium metal project joint venture with Aluminum of Korea Ltd.—Hyundai Group: Toronto, Cassiar Mines and Metals Inc. press release, July 7, 1 p.
- Chowdhury, S.R., and Kitchener, J.A., 1975, The zeta-potentials of natural and synthetic chrysotiles: *International Journal of Mineral Processing*, v. 2, p. 277-285.
- Churchill, R.K., and Hill, R.L., 2000, A general location guide for ultramafic rocks in California—Areas more likely to contain naturally occurring asbestos: California Department of Conservation, Division of Mines and Geology, Open-File Report 2000-19. (Also available through the Internet at <http://www.consrv.ca.gov>).
- Churg, Andrew, and Wright, J.L., 1994, Persistence of natural mineral fibers in human lungs—An overview, *in* *Biopersistence of respirable synthetic fibers and materials: Environmental Health Perspectives*, v. 102, supplement 5, October, p. 229-233.
- Ciullo, P.A., 1996, Industrial minerals and their uses—A handbook and formulary: Westwood, N.J., Noyes Publications, 632 p.
- Clarke, Gerry, 1982, Asbestos—A versatile mineral under siege: *Industrial Minerals*, no. 174, March, p. 19-37.
- Clifton, R.A., 1976, Asbestos, *in* *Minerals facts and problems*: U.S. Bureau of Mines Bulletin 667, p. 107-121.
- Clifton, R.A., 1979, Asbestos: U.S. Bureau of Mines Mineral Commodity Profiles, 19 p.
- Clifton, R.A., 1980a, Asbestos: U.S. Bureau of Mines Mineral Commodity Summary, July, 1980, p. 14-15.
- Clifton, R.A., 1980b, Asbestos, *in* *Minerals facts and problems*: U.S. Bureau of Mines Bulletin 671, p. 55-71.
- Clifton, R.A., 1985, Asbestos, *in* *Minerals facts and problems*: U.S. Bureau of Mines Bulletin 675, p. 53-64.

- Clinkenbeard, J.P., Chruchill, R.K., and Lee, Kiyong, eds., 2002, Guidelines for geologic investigations of naturally occurring asbestos in California: California Department of Conservation, California Geological Survey Special Publication 124, 70 p.
- Conn, H.K., and Mann, E.L., 1971, Evaluation of asbestos deposits: New York, Society of Mining Engineers, Inc. Preprint 71-H-27, 9 p.
- Conrad, S.G., Wilson, W.F., Allen, E.P., and Wright, T.J., 1963, Anthophyllite asbestos in North Carolina: North Carolina Department of Conservation and Development, Division of Mineral Resources Bulletin 77, 61 p.
- Cossette, M., and Delvaux, P., 1979, Technical evaluation of chrysotile asbestos ore bodies, *in* Ledoux, R.L., ed., Short course in mineralogical techniques of asbestos determination: Ottawa, Mineralogical Association of Canada, v. 4, May, p. 79-110.
- Dean, A.W., and Mann, E.L., 1968, The evaluation of chrysotile asbestos deposits, ore reserve estimation and grade control, *in* Ore reserve estimation and grade control—A Canadian centennial conference: Canadian Institute of Mining & Metallurgy, v. 9, p. 281-286.
- Dreyer, C.J.B., and Robinson, H.A., 1981, Occurrence and exploitation of amphibole asbestos in South Africa, *in* Rioridon, P.H., ed., Geology of asbestos deposits: New York, Society of Mining Engineers Inc., p. 25-44.
- Finkelstein, M.M., and Dufresne, Anne, 1999, Interferences on the kinetics of asbestos deposition and clearance among chrysotile miners and millers: American Journal of Industrial Medicine, v. 35, no. 4, April, p. 401-412.
- Franco, M.A., Hutchison, J.L., Jefferson, D.A., and Thomas, J.R., 1977, Structural imperfections and morphology of crocidolite (blue asbestos): Nature, v. 266, no. 7, April, p. 520-521.
- Gardner, M.J., and Powell, C.A., 1986, Mortality of asbestos cement workers using almost exclusively chrysotile fibre: Journal of the Society of Occupational Medicine, v. 36, no. 4, November, p. 124.
- Gazette Montreal, 2002, Jeffrey Mine pulls plug: Gazette Montreal, October 10, p. B3.
- Gibbs, Graham, 2001, Health effects associated with mining and milling chrysotile asbestos in Quebec and the role of tremolite, *in* Nolan, R.P., Langer, A.M., Ross, M., Wicks, F.J., and Martin, R.F., eds., The health effects of chrysotile asbestos: Ottawa, The Canadian Mineralogist Special Publication 5, p. 165-176.
- Griffiths, Joyce, 1986, Asbestos—Rising in east but setting in west: Industrial Minerals, no. 223, April, p. 21-37.
- Grindrod, John, 1959, Lake Asbestos opencast mine and mill: The Mining Journal, July 3, p. 6-8.
- Gross, Paul, and Braun, D.C., 1984, Toxic and biomedical effect of fibers—Asbestos, talc, inorganic fibers, man-made vitreous fibers, and organic fibers: Park Ridge, N.J., Noyes Publications, 257 p.
- Hahn-Weinheimer, P., and Hirner, A., 1975, Influence of hydrothermal treatment on physical and chemical properties of chrysotile asbestos: Journal and Proceedings of the Royal Society of New South Wales, v. 110, p. 99-110.
- Hall, A.L., 1930, Asbestos in the Union of South Africa: Geological Survey of South Africa, Memoir 12, 324 p.
- Harrison, P.T.C., Levy, L.S., Patrick, Graham, Pigott, G.H., and Smith, L.L., 1999, Comparative hazards of chrysotile asbestos and its substitutes—A European perspective: Environmental Health Perspectives, v. 107, no. 8, August, p. 607-611.
- Heinzl, Mark, 1999, An old mine's rubbish revives a town called Asbestos: The Wall Street Journal, July 22, p. B1, B10.
- Hodgson, A.A., 1979, Chemistry and physics of asbestos, *in* Michaels, L., and Chissick, S.S., eds., Asbestos—Properties, applications and hazards: New York, John Wiley and Sons, Inc., p. 67-114.
- Hodgson, A.A., 1985, Alternatives to asbestos and asbestos products: Crowthorne, United Kingdom, Anjalena Publications Ltd., 230 p.
- Hodgson, A.A., 1986, Scientific advances in asbestos, 1967 to 1985: Crowthorne, United Kingdom, Anjalena Publications Ltd., 186 p.
- Hodgson, A.A., 1989, The alternative raw materials, *in* Hodgson, A.A., ed., Alternatives to asbestos—The pros and cons: New York, John Wiley and Sons, Inc., 195 p.
- Howling, G.E., 1937, Asbestos: London, Imperial Institute, 88 p.
- Hull, M.J., Abraham, J.L., and Case, B.W., 2002, Mesothelioma among workers in asbestiform fiber-bearing talc mines in New York State: Annals of Occupational Hygiene, v. 46, supplement 1, January, p. 132-135.
- Huttl, John, 1962, Jeffrey Lake—California's premier asbestos producer: Engineering and Mining Journal, v. 163, no. 10, October, p. 84-89.
- Industrial Minerals, 1993, Teranov recommences asbestos production: Industrial Minerals, no. 309, June, p. 12.

- International Ban Asbestos Secretariat, 2004, Asbestos regulations/bans: Web site at [http://www.btinternet.com/~ibas/Frames/sf\\_content\\_current\\_bans.htm](http://www.btinternet.com/~ibas/Frames/sf_content_current_bans.htm). (Accessed December 6, 2004).
- Internal Revenue Service, 2004, Percentage depletion rates, *in* Title 26—Internal Revenue Service: National Archives and Records Administration, Office of the Federal Register Code of Federal Regulations, 26 CFR §81.613-2, p. 412-415.
- Jacko, M.G., and Rhee, S.K., 1992, Brake linings and clutch facings, *in* Kirk-Othmer encyclopedia of chemical technology: New York, John Wiley and Sons, Inc., p. 523-536.
- Johnson, N.F., and Mossman, B.T., 2001, Dose, dimension, durability and biopersistence of chrysotile asbestos, *in* Nolan, R.P., Langer, A.M., Ross, Malcolm, Wicks, F.J., and Martin, R.F., eds., The health effects of chrysotile asbestos: Ottawa, Ontario: The Canadian Mineralogist, Special Publication 5, p. 145-154.
- Kendall, Thomas, 1980, Asbestos production: Industrial Minerals, no. 372, September, p. 80-87.
- Kobayashi, Mitsuru, 2002, Nonasbestos friction materials: U.S. Patent 6,413,622, assigned to Nisshinbo Industries, Inc., 9 p.
- Lamarche, R.Y., and Riordon, P.H., 1981, Geology and genesis of the chrysotile asbestos deposits of northern Appalachia, *in* Riordon, P.H., ed., Geology of asbestos deposits: New York, Society of Mining Engineers, American Institute of Mining, Metallurgical, and Petroleum Engineers, Inc., p. 11-23.
- Larsen, E.S., 1941, Alkalic rocks of Iron Hill, Gunnison County, Colorado: U.S. Geological Survey Professional Paper 197-A, 64 p.
- Leake, Bernard, and others, 1997, Nomenclature of amphiboles—Report of the subcommittee on amphiboles of the International Mineralogical Association—Commission on new minerals and mineral names: Canadian Mineralogist, v. 35, part 1, February, p. 219-246.
- Li, T.M., 1975, Environmental compliance assures future production at Jaquays asbestos operation: Mining Engineering, v. 27, no. 3, March, p. 40-45.
- Mann, E.L., 1983, Asbestos, *in* Lefond, S.J., ed., Industrial minerals and rocks, (5th ed.): New York, Society of Mining Engineers, American Institute of Mining, Metallurgical, and Petroleum Engineers, Inc., p. 435-484.
- May, T.M., 1965, Asbestos, *in* Mineral facts and problems: U.S. Bureau of Mines Bulletin 630, p. 81-90.
- May, T.M., and Lewis, R.W., 1970, Asbestos, *in* Mineral facts and problems: U.S. Bureau of Mines Bulletin 650, p. 851-863.
- McCallie, S.W., 1910, A preliminary report on the mineral resources of Georgia: Geological Survey of Georgia Bulletin No. 23, 37 p.
- Meeker, G.P., Bern, A.M., Brownfield, I.K., Lowers, H.A., Sutley, S.J., Hoefen, T.M., and Vance, J.S., 2003, The composition and morphology of amphiboles from the Rainy Creek Complex, near Libby, Montana: American Mineralogist, v. 88, no. 11-12, part 2, November-December, p. 1955-1969.
- Meylan, W.M., Howard, P.H., Lande, S.S., and Hanchett, Arnold, 1978, Chemical market input/output analysis of selected chemical substances to assess sources of environmental contamination—Task III asbestos: U.S. Environmental Protection Agency EPA 560/6-78-005, 313 p.
- Mining Engineering, 2004, Canada's Black Lake asbestos mine to close: Mining Engineering, v. 56, no. 7, July, p. 13.
- Mine Safety and Health Administration, 2004, Asbestos exposure limit—Unified agenda: Web site at <http://www.msha.gov/regs/unified/1219%2Dab24.asp>. (Accessed October 14, 2004).
- Moore, Paul, 2004, Chrysotile in crisis: Industrial Minerals, no. 439, April, p. 56-61.
- Munro, R.C., and Reim, K.M., 1962, Coalinga asbestos fiber—A newcomer to the asbestos industry: Mining Engineering, v. 14, no. 9, September, p. 60-62.
- Murray, Robert, 1990, Asbestos—A chronology of its origins and health effects: British Journal of Industrial Medicine, v. 47, June, p. 361-365.
- National Institutes of Health, 1991, Asbestos—An information resource: National Institutes of Health No. 81-1681, 179 p.
- Nolan, R.P., Langer, A.M., and Wilson, Richard, 1999, A risk assessment for exposure to grunerite asbestos (amosite) in an iron ore mine, *in* Proceedings of National Academy of Sciences Colloquium, Irvine, Calif., November 8-9, 1998: National Academy of Sciences, v. 96, no. 7, March 30, p. 3412-3419.
- Occupational Safety and Health Administration, 1994, Occupational exposure to asbestos—Final rule: Federal Register, v. 59, no. 153, August 10, p. 40964-41162.
- Occupational Safety and Health Administration, 2004, OSHA standards—Asbestos: Web site at <http://www.osha.gov/SLTC/asbestos/standards.html>. (Accessed October 14, 2004).



- Omenn, G.S., Merchant, J.A., Boatman, E., Dement, J.M., Kuschner, M., Nicholson, W., Peto, J., and Rosenstock, L., 1986, Contribution of environmental fibers to respiratory cancer: *Environmental Health Perspectives*, v. 70, December, p. 51-56.
- Pardee, J.T., and Larsen, E.S., 1929, Deposits of vermiculite and other minerals in the Rainy Creek District near Libby, Montana: U.S. Geological Survey Bulletin 805-B, 29 p.
- Peipins, L.A., Lewin, Michael, Campolucci, Sharon, Lybarger, J.A., Miller, Aubrey, Middleton, Daniel, Weis, Christopher, Spence, Michael, Black, Bradley, and Kapil, Vikas, 2003, Radiographic abnormalities and exposure to asbestos-contaminated vermiculite in the community of Libby, Montana, USA: *Environmental Health Perspectives*, v. 111, no. 14, November, p. 1753-1759.
- Perron, Louis, 2003, Asbestos 2002: Web site at <http://www.nrcan.gc.ca/mms/cmty/content/2002/20.pdf>. (Accessed October 20, 2004).
- Pit and Quarry, 1970, Canadian Johns-Manville retreating asbestos ore tailings: Pit and Quarry, November, v. 33, no. 5, p. 111-112.
- Pye, A.M., 1989a, Alternatives to asbestos in industrial applications, *in* Michaels, L., and Chissick, S.S., eds., *Asbestos—Properties, applications, and hazards*: New York, John Wiley and Sons, Inc., p. 339-373.
- Pye, A.M., 1989b, The feasibility of substitution *in* Hodgson, A.A., ed., *Alternatives to asbestos—The pros and cons*: New York, John Wiley and Sons, Inc., 195 p.
- Quebec Asbestos Information Service, 1959, The strangest mineral ever known: Montreal, Quebec Asbestos Information Service, September, [unpaginated].
- Ralston, J., and Kitchener, J.A., 1975, The surface chemistry of amosite asbestos, an amphibole silicate: *Journal of Colloid and Interface Science*, v. 50, no. 2, February, p. 242-249.
- Rice, Carol, and Heineman, E.F., 2003, An asbestos job exposure matrix to characterize fiber type, length, and relative exposure intensity: *Applied Occupational and Environmental Hygiene*, v. 18, no. 7, July, p. 506-512.
- Rosato, D.V., 1959, *Asbestos—Its industrial applications*: New York, Reinhold Publishing Corp., 214 p.
- Roskill Information Services, Ltd., 1983, *The economics of asbestos* (5th ed.): London, Roskill Information Services, Ltd., 188 p.
- Roskill Information Services, Ltd., 1990, *The economics of asbestos* (6th ed.): London, Roskill Information Services, Ltd., 143 p.
- Roskill Information Services, Ltd., 1995, *Asbestos—Market update, analysis & outlook*: London, Roskill Information Services, Ltd., 43 p.
- Ross, Malcolm, 1981, The geologic occurrences and health hazards of amphibole and serpentine asbestos, *in* Veblen, D.R., ed., *Amphiboles and other hydrous pyriboles—Mineralogy*: Washington, D.C., Mineralogical Society of America Reviews in Mineralogy, v. 9A, p. 279-319.
- Ross, Malcolm, 1984, A survey of asbestos-related disease in trades and mining occupations and in factory and mining communities as a means of predicting health risks of nonoccupational exposure to fibrous minerals, *in* Levadie, Benjamin, ed., *Definitions for asbestos and other health-related silicates*: Philadelphia, American Society for Testing and Materials Special Technical Publication 834, p. 51-104.
- Ross, Malcolm, and Virta, R.L., 2001, Occurrence, production, and uses of asbestos, *in* Nolan, R.P., Langer, A.M., Ross, Malcolm, Wicks, F.J., and Marin, R.F., eds., *The health effects of chrysotile asbestos*: Ottawa, Mineralogical Association of Canada, p. 79-88.
- Ross, Malcolm, Kuntze, R.A., and Clifton, R.A., 1984, A definition for asbestos, *in* Levadie, Benjamin, ed., *Definitions for asbestos and other health-related silicates*: Philadelphia, American Society for Testing and Materials Special Technical Publication 834, p. 139-147.
- Rowbotham, P.I., ed., 1970, *World asbestos industry: Industrial Minerals*, no. 28, January, p. 17-29.
- Schatzberger, W.M., 1979, Survey of energy contents of three cladding materials: Stonemarket, United Kingdom, Schape Associates Reference 9706, September 24, 9 p.
- Selikoff, I.J., Churg, J., and Hammond, E.C., 1964, Asbestos exposure and neoplasia: *Journal of the Medical Association*, v. 188, April, p. 22-26.
- Selikoff, I.J., and Lee, D.H.K., 1978, *Asbestos and disease*: New York, Academic Press, 549 p.
- Sinclair, W.E., 1959, *Asbestos—Its origin, production, and utilization*: London, Mining Publications, Ltd., 512 p.
- Skinner, H.C.W., Ross, Malcolm, and Frondel, Clifford, 1988, *Asbestos and other fibrous materials*: New York., Oxford University Press, Inc., 204 p.
- Stewart, L.A., 1955, *Chrysotile-asbestos deposits of Arizona*: U.S. Bureau of Mines Information Circular 7706, 124 p.
- Stewart, R.V., 1981, Geology and evaluation of the Asbestos Hill ore body, *in* Riordon, P.H., ed., *Geology of asbestos deposits*: New York, Society of Mining Engineers, American Institute of Mining, Metallurgical, and Petroleum Engineers, Inc., p. 53-62.

- Stewart, P., French, G., and Anthony, D., 1990, Baie Verte wet process plant: *Industrial Minerals*, no. 273, June, p. 51-55.
- Teague, K.H. 1956, Georgia occurrences described: *Georgia Mineral Newsletter*, v. 9, no. 1, spring, p. 4-7.
- United Nations, 2004, UN commodity trade statistics database: Web site at <http://unstats.un.org/unsd/comtrade>. (Accessed September 15, 2004).
- U.S. Bureau of Mines, 1934-1996, Asbestos in various titled Metals and minerals and metals, minerals, and fuels: U.S. Bureau of Mines Minerals Yearbook, 1932-1994, [variously paginated].
- U.S. Bureau of Mines, 1945, Asbestos mines—Gila County, Arizona: U.S. Bureau of Mines War Minerals Report 370, 18 p.
- U.S. Bureau of Mines and U.S. Geological Survey, 1980, Principles of a resource reserve clarification for minerals: U.S. Geological Survey Circular 831, 722 p.
- U.S. Census Bureau, 1999, 1997 economic census—All other miscellaneous nonmetallic mineral product manufacturing: U.S. Census Bureau Industry Series EC97M-3279E, 27 p.
- U.S. Department of Commerce, 1995, Abrasive, asbestos, and miscellaneous nonmetallic mineral products—1992 census of manufacturers: U.S. Department of Commerce MC92-I-32E, 43 p.
- U.S. Department of Health and Human Services, 1992, Asbestos publications: Cincinnati, U.S. Department of Health and Human Services, June, 190 p.
- U.S. Environmental Protection Agency, 1985, Guidance for controlling asbestos-containing materials in buildings: U.S. Environmental Protection Agency, Office of Pesticides and Toxic Substances, 95 p.
- U.S. Environmental Protection Agency, 1988, Regulatory impact analysis of controls on asbestos and asbestos products: U.S. Environmental Protection Agency, Office of Toxic Substances, v. 3, appendix F, May 6, 497 p.
- U.S. Environmental Protection Agency, 2004a, Asbestos in your home: Web site at <http://www.epa.gov/asbestos/ashome.html>. (Accessed November 9, 2004).
- U.S. Environmental Protection Agency, 2004b, Laws and regulations: Web site at <http://www.epa.gov/asbestos/ashbreg.html>. (Accessed October 14, 2004).
- U.S. Geological Survey, 1901-1921, Asbestos: U.S. Geological Survey Mineral Resources of the United States 1900-1919, pt. II, [variously paginated].
- U.S. Geological Survey, 1924-1932, Asbestos, *in* Metals and minerals: U.S. Geological Survey Minerals Yearbook 1920-1931, [variously paginated].
- U.S. Geological Survey, 1997-2005, Asbestos, *in* Metals and minerals: U.S. Geological Survey Minerals Yearbook 1995-2003, pt. I, [variously paginated].
- U.S. International Trade Commission, 2004a, 2004 tariff database: Web site at <http://dataweb.usitc.gov/scripts/tariff2004.asp>. (Accessed October 20, 2004).
- U.S. International Trade Commission, 2004b, USITC interactive tariff and trade dataweb: Web site at <http://www.itc.gov>. (Accessed October 20, 2004).
- Van Gosen, B.S., Lowers, H.A., Bush, A.L., Meeker, G.P., Plumlee, G.S., Brownfield, I.K., and Sutley, S.J., 2002, Reconnaissance study of the geology of U.S. vermiculite deposits—Are asbestos minerals common constituents?: U.S. Geological Survey Bulletin 2192, 8 p.
- Van Gosen, B.S., Lowers, H.A., Sutley, S.J., and Gent, C.A., 2004, Using the geologic setting of talc deposits as an indicator of amphibole asbestos content: *Environmental Geology*, v. 45, no. 7, May, p. 920-939.
- van Oss, C.J., Naim, J.O., Costanzo, P.M., Giese, R.F. Jr., Wu, W., and Sorling, A.F., 1999, Impact of different asbestos species and other mineral particles on pulmonary pathogenesis: *Clays and Clay Minerals*, v. 47, no. 6, December, p. 697-707.
- Virta, R.L., 1985-1996, Asbestos, *in* Metals and minerals: U.S. Bureau of Mines Minerals Yearbook 1984-1994, v. 1, [variously paginated].
- Virta, R.L., 1990, Asbestos: U.S. Bureau of Mines Mineral Commodity Summaries 1990, p. 24-25.
- Virta, R.L., 1994, Asbestos substitutes, *in* Carr, D.D., ed., *Industrial minerals and rocks* (6th ed.): Littleton, Colo., Society for Mining, Metallurgy, and Exploration, Inc., p. 429-434.
- Virta, R.L., 1997-2005, Asbestos, *in* Metals and minerals: U.S. Geological Survey Minerals Yearbook 1995-2003, v. I, [variously paginated].
- Virta, R.L., 2001, Some facts about asbestos: U.S. Geological Survey Fact Sheet FS-012-01, 4 p.
- Virta, R.L., 2002a, Asbestos: U.S. Geological Survey Mineral Commodity Summaries 2002, p. 26-27.
- Virta, R.L., 2002b, Asbestos—Geology, mineralogy, mining, and uses: U.S. Geological Survey Open-File Report 02-149, 35 p.
- Virta, R.L., 2003, Worldwide asbestos supply and consumption trends from 1900 to 2000: U.S. Geological Survey Open-File Report 03-83, 59 p.
- Virta, R.L., 2004a, Asbestos: U.S. Geological Survey Mineral Commodity Summaries 2004, p. 26-27.

- Virta, R.L., 2004b, Asbestos, *in* Metals and minerals: U.S. Geological Survey Minerals Yearbook 2002, v. I, p. 8.1-8.6. (Also available on the Internet through <http://minerals.usgs.gov/minerals/pubs/commodity/asbestos/>).
- Virta, R.L., 2005, Asbestos, *in* Metals and minerals: U.S. Geological Survey Minerals Yearbook, 2003, v. I, p. 8.1-8.6. (Also available on the Internet through <http://minerals.usgs.gov/minerals/pubs/commodity/asbestos/>).
- Virta, R.L., and Mann, E.L., 1994, Asbestos, *in* Carr, D.D., ed., Industrial minerals and rocks (6th ed.): Littleton, Colo., Society for Mining, Metallurgy, and Exploration, Inc., p. 97-124.
- White, M.J., 2002, Why the asbestos genie won't stay in the bankruptcy bottle: Web site at <http://weber.ucsd.edu/~miwhite>. (Accessed July 7, 2004).
- Wilson, E.D., 1928, Asbestos deposits of Arizona: Arizona Bureau of Mines, University of Arizona Bulletin, Mineral Technology Series No. 31, 97 p.
- Wilson, R., and Price, P., 2001, Trends in incidence of mesothelioma and evaluation of exposure to asbestos, *in* Nolan, R., Langer, A.M., Ross, Malcolm, Wicks, F.J., and Martin, R.F., eds., The health effects of chrysotile asbestos: Ottawa, The Canadian Mineralogist Special Publication 5, p. 53-62.
- Wylie, A.G., 1979, Fiber length and aspect ratio of some selected asbestos samples, *in* Selikoff, I.J., and Hammond, E.C., eds., Health hazards of asbestos exposure: New York, New York Academy of Sciences, v. 330, issue 1, p. 605-610.
- Wylie, A.G., and Huggins, C.W., 1980, Characteristics of a potassium winchite asbestos from the Allamoore talc district, Texas: Canadian Mineralogist, v. 19, February, p. 101-107.
- Wylie, A.G., and Verkouteren, J.R., 2000, Amphibole asbestos from Libby, Montana—Aspects of nomenclature: American Mineralogist, v. 85, no. 10, October, p. 1540-1542.
- Yada, K., 1967, Study of chrysotile asbestos by a high resolution microscope: Acta Crystallogica, v. 23, November, p. 704-710.
- Zielhuis, R.L., ed., 1977, Public health risks of exposure to asbestos: Oxford, Pergamon Press Ltd., 149 p.



## Appendix

### Definitions of Reserves, Reserve Base, and Resources

The term “resources,” as applied to metals, refers to those concentrations of metal-bearing minerals in the Earth’s crust that are currently or potentially amenable to the economic extraction of one or more metals from them. “Reserves” and “reserve base” are subcategories of resources. “Reserves” refers to the in-place metal content of ores that can be mined and processed at a profit given the metal prices, available technology, and economic conditions that prevail at the time the reserves estimate is made.

“Reserve base” is a more inclusive term that encompasses not only reserves proper, but marginally economic reserves and a discretionary part of subeconomic resources—“those parts of the resources that have a reasonable potential for becoming economically available within planning horizons beyond those that assume proven technology and current economics” (U.S. Bureau of Mines and U.S. Geological Survey, 1980).