

# **Final Report on Electric Clothes Dryers and Lint Ignition Characteristics May 2003**

## **Abstract**

In FY 2002, U.S. Consumer Product Safety Commission staff completed a test program to evaluate residential electric clothes dryers under various test conditions. The test program included measurements of temperature and airflow characteristics for different electric clothes dryer designs under normal operating conditions and conditions of partially-blocked and fully-blocked exhaust ducting. The ignition characteristics of lint in relation to electric clothes dryer operation were also evaluated. The test program produced data on different dryer operating and design characteristics that can be used to help reduce the risk of lint ignition in a clothes dryer and help prevent fires.

The experiments described in this research report were undertaken to support future advances in clothes dryer safety. This report should not be used to suggest that current clothes dryers are unsafe or defective.

## **IMPORTANT**

**All airflow measurements are reported in Standard Feet per Minute (SFPM). These measurements are referenced to 25°C and 29.92 inches Hg.**

FINAL REPORT ON  
**ELECTRIC CLOTHES DRYERS**  
AND LINT IGNITION CHARACTERISTICS  
May 2003

The experiments described in this research report were undertaken to support future advances in clothes dryer safety. This report should not be used to suggest that current clothes dryers are unsafe or defective.



**U.S. CONSUMER PRODUCT SAFETY COMMISSION**  
**4330 EAST WEST HIGHWAY, BETHESDA, MARYLAND 20814**

U.S. CONSUMER PRODUCT SAFETY COMMISSION

DIRECTORATE FOR ENGINEERING SCIENCES



FINAL REPORT ON

**ELECTRIC CLOTHES DRYERS  
AND LINT IGNITION CHARACTERISTICS**

May 2003

Arthur Lee  
Electrical Engineer

Division of  
Electrical Engineering

Directorate for  
**E**ngineering  
**S**ciences

## **ACKNOWLEDGMENTS**

This project was completed with the help of CPSC staff in the Directorate for Laboratory Sciences; Directorate for Engineering Sciences; Directorate for Economics Analysis; and Directorate for Epidemiology.

Frank Dunmore, Ph.D., Directorate for Laboratory Sciences, provided technical expertise in all aspects of the project, and specifically in coordinating and implementing Task 3 - Monitor Lint Distribution. He also authored the section of this report that discusses Task 3.

Timothy Smith, Directorate for Engineering Sciences - Division of Human Factors, conducted an analysis of consumer behavior with regard to clothes dryers, particularly related to abnormal operating conditions.

Sheela Kadambi, Directorate for Engineering Sciences, Division of Electrical Engineering, conducted the initial work on clothes dryers in 1998, which set the foundation for this project.

Terrance R. Karels, Directorate for Economic Analysis, provided information on the clothes dryer market over the past 10 years.

Mark Levenson, Ph.D., Directorate for Epidemiology – Division of Hazard Analysis, developed estimates of clothes dryer fire losses for a 10-year period and analyzed in-depth investigations of fire incidents associated with clothes dryers.

## EXECUTIVE SUMMARY

The U.S. Consumer Product Safety Commission (CPSC) initiated a project in Fiscal Year 2002 to investigate possible conditions that may lead to dryer fires and to develop recommendations for revisions and/or additions to the voluntary standards to address potential hazards. In 1998, CPSC estimates that there were approximately 15,600 clothes dryer fires resulting in 20 deaths, 370 injuries and \$75.4 million in property damage<sup>1</sup>.

CPSC staff tested clothes dryers to evaluate the effects of lint accumulation and above-normal operating temperatures and determine whether such conditions may result in lint ignition and/or dryer fires. The data was used to help determine if dryer fires result from a single event or a combination of events.

The basic approach was to conduct several tasks that could link the cause of lint accumulation to possible dryer fires and/or lint ignition. The tasks included:

- Task 1. Inspect and Record Dryer Design
- Task 2. Document Dryer Operating Characteristics
- Task 3. Monitor Lint Distribution
- Task 4. Determine Characteristics Required for Lint Ignition

Although selected dryer designs were used to document the variety of temperature and airflow patterns in a dryer, the conclusions are based on and can be applied to general dryer designs.

Tests included examining the effects of restricted and unrestricted airflow on dryer operation. Airflow restriction was created by placing an iris – which created blockages of 25, 50 and 75 percent – in the exhaust duct. A blast plate covering the exhaust opening was used to create a fully blocked exhaust vent (100 percent blockage). Hot wire anemometers were used to measure the airflow entering and exiting the dryers. Thermocouples were placed at the heater intake, heater housing, heater exhaust, tumbler intake, blower intake, and dryer exhaust.

The results of the CPSC staff tests showed that lint that accumulates inside the dryer can ignite if the lint contacts certain areas of the heater housing, if the lint is in proximity to the heater, or if the lint is ingested by the heater box. Observations made for each task during testing include:

### Task 1. Inspect and Record Dryer Design

- ◆ All four dryer designs used the same method and order (heater, tumbler, lint screen, blower, and exhaust duct) for moving the air through the dryer.

---

<sup>1</sup> Mah, J., "Table 1, Estimated Residential Structure Fires Selected Equipment 1998," *1998 Residential Fire Loss Estimates*, Directorate for Epidemiology, US Consumer Product Safety Commission, 1998.

- ◆ The length of the dryer's exhaust duct extending out of the dryer may not allow the house duct to slide far enough onto the dryer's exhaust duct to provide a secure pressure fit.
- ◆ Using rigid external ducting does not allow for a secure pressure fit around the dryer's male duct.

### Task 2. Document Dryer Operating Characteristics

- ◆ The temperatures within a dryer, under both normal and abnormal conditions, were similar for the four different dryer designs tested, with only slight variations due to dryer internal configurations.
- ◆ The temperatures measured inside the heater box, heater intake, and intake into the tumbler increased when the exhaust vent was partially blocked or fully blocked. The temperatures inside the tumbler, blower and exhaust vent decreased when the exhaust vent was partially blocked or fully blocked.
- ◆ When the exhaust vent was blocked up to 50 percent, the temperatures inside the dryer were similar to those measured when there was no blockage of the exhaust vent. When the exhaust vent was 75 percent or 100 percent blocked, temperatures in certain areas inside the dryer increased significantly.
- ◆ Under normal operation, the airflow inside the exhaust vent decreased dramatically as the lint screen became blocked with lint particles.
- ◆ In general, the dryers only cycled on the high-limit thermostat when the exhaust vent was 75 or 100 percent blocked, which caused the temperatures near the heater to increase significantly.
- ◆ When the primary thermostat was bypassed (simulating a thermostat failure), the dryer operated at higher than normal temperatures – temperatures similar to those measured when the exhaust vent was blocked 50 to 75 percent. In general (3 of the 4 dryer designs tested), a failed-closed primary thermostat did not cause the dryer to cycle on the high limit thermostat for the unblocked exhaust vent condition.

### Task 3. Monitor Lint Distribution

- ◆ Lint begins to accumulate inside a dryer chassis upon first use. Lint accumulates on the dryer's components, including the heater and the dryer floor. This accumulation occurs even when the dryer's lint screen has been cleaned after each usage, and the dryer is properly exhausted.
- ◆ Seals in the dryer's interior exhaust venting may not be adequate to prevent linty air from escaping into the dryer's interior.

Task 4. Determine Characteristics Required for Lint Ignition

- ◆ Lint that accumulates on the heater housing can easily ignite under conditions of a failed high-limit thermostat and a blocked exhaust vent.
- ◆ Lint accumulating near the heater intake can ignite before the high-limit thermostat switches the heater element off.
- ◆ Lint ingested by the heater and embers expelled from the heater outlet can easily ignite additional lint or fabric in the air stream, resulting in additional embers in the dryer system and exhaust vent.

The CPSC staff noted the following during testing and analysis:

- ◆ The high-limit thermostat may prematurely fail when subjected to high ambient temperatures.





US CONSUMER PRODUCT SAFETY COMMISSION  
FINAL REPORT ON ELECTRIC CLOTHES DRYERS AND LINT IGNITION CHARACTERISTICS  
May 2003

2.2.7.2 <i>Dryer Design D – Airflow</i> .....	60
2.2.7.3 <i>Dryer Design D – Primary Thermostat Bypassed</i> .....	64
2.3 Task 3: Monitor Lint Distribution .....	66
2.3.1 Test Setup.....	66
2.3.2 Test Description .....	67
2.3.2.1 <i>Method 1 – Weight Loss of Load</i> .....	67
2.3.2.2 <i>Method 2 – Visual Examination</i> .....	68
2.3.3 Examination of Dryer Design A.....	69
2.4 Task 4: Determine Characteristics Required for Lint Ignition .....	71
2.4.1 Test Setup.....	71
2.4.2 Instrumentation Setup .....	71
2.4.3 Phase I – Ignition Characteristics of Lint On and Near the Heater Box .....	75
2.4.3.1 <i>Top of Heater Housing</i> .....	75
2.4.3.2 <i>Side of the Heater Housing</i> .....	79
2.4.3.3 <i>Lint Samples at the Heater Intake</i> .....	83
2.4.4 Phase II – Ignition Characteristics of Lint Ingested into the Heater Box .....	89
2.4.4.1 <i>Part 1 – Lint Samples Ingested by the Heater Box</i> .....	89
2.4.4.2 <i>Part 2 – Ignition of Target Materials Downstream from the Heater Exhaust</i> .....	90
3.0 DISCUSSION .....	95
3.1 Task 1: Inspect and Record Dryer Design .....	95
3.2 Task 2: Document Dryer Operating Characteristics.....	95
3.2.1 Normal Operation (Unblocked Exhaust Vent) .....	95
3.2.2 Partially-Blocked and 100%-Blocked Conditions .....	99
3.3 Task 3: Monitor Lint Distribution .....	108
3.3.1 Dryer Design A at Positive Pressure.....	108
3.3.2 Other Dryer Designs at Positive Pressure .....	109
3.4 Task 4: Determine Characteristics Required for Lint Ignition .....	111
3.4.1 Lint on the Heater Housing .....	111
3.4.2 Lint Samples at the Heater Intake .....	111
3.4.2.1 <i>High-Limit Thermostat Bypassed and No Airflow</i> .....	111
3.4.2.2 <i>High-Limit Connected in Series and No Airflow</i> .....	116
3.4.2.3 <i>High-Limit Connected in Series and Airflow</i> .....	119
3.4.3 Lint Samples Ingested into the Heater .....	121
3.4.4 Ignition of Target Material Downstream from the Heater Exhaust .....	122
3.4.5 High-Limit Thermostat Analysis .....	122
3.4.5.1 <i>High-Limit Thermostat 1 (HLT1) Analysis</i> .....	123
3.4.5.2 <i>High-Limit Thermostat 2 (HLT2) Analysis</i> .....	127
4.0 SUMMARY AND CONCLUSIONS .....	133
Appendices A to J.....	A-J

## LIST OF FIGURES

Figure 1. Dryer Design Characteristics .....	6
Figure 2. Heating Element in a Heater Box Configuration .....	7
Figure 3. Circular Heating Element in Dryer Design D .....	7
Figure 4. Exhaust Vent Setup .....	9
Figure 5. Thermocouple Response Before Task 2 Testing .....	11
Figure 6. Thermocouple Response After Task 2 Testing .....	11
Figure 7. Average Responses per Oven Set Temperatures and Day .....	12
Figure 8. Dryer Design A Intake and Exhaust .....	14
Figure 9. Dryer Design A – Thermocouple and Airflow Measurements with a Wet Load .....	16
Figure 10. Dryer Design A – T1 Heater Intake Comparison .....	17
Figure 11. Dryer Design A – T3 Heater Housing Comparison .....	18
Figure 12. Dryer Design A – T2 Heater Exhaust Comparison .....	19
Figure 13. Dryer Design A – Intake Air Velocity .....	21
Figure 14. Dryer Design A – Exhaust Air Velocity .....	22
Figure 15. Dryer Design A – Average Airflow Velocities (High Heat and Dry Load) .....	23
Figure 16. Dryer Design A – Average Airflow Velocities (No Heat and No Load) .....	24
Figure 17. Dryer Design A – Primary Thermostat Bypassed .....	26
Figure 18. Dryer Design B – Air Flow Through the Tumbler .....	27
Figure 19. Dryer Design B – Thermocouple and Airflow Measurements (Wet Load) .....	30
Figure 20. Dryer Design B – T1 Heater Intake Comparison .....	31
Figure 21. Dryer Design B – T3 Heater Housing Comparison .....	32
Figure 22. Dryer Design B – T5 Intake into the Blower Comparison .....	33
Figure 23. Dryer Design B – Intake Air Velocity .....	35
Figure 24. Dryer Design B – Exhaust Vent Air Velocity .....	36
Figure 25. Dryer Design B – Average Airflow Velocities (High Heat and Wet Load) .....	37
Figure 26. Dryer Design B – Primary Thermostat Bypassed .....	39
Figure 27. Dryer Design C – Airflow through the Tumbler .....	40
Figure 28. Dryer Design C – Thermocouple and Airflow Measurements (Wet Load) .....	43
Figure 29. Dryer Design C – T1 Heater Intake Comparison .....	44
Figure 30. Dryer Design C – T3 Heater Housing Comparison .....	45
Figure 31. Dryer Design C – T5 Intake into the Blower Comparison .....	46
Figure 32. Dryer Design C – Intake Air Velocity .....	48
Figure 33. Dryer Design C – Exhaust Vent Air Velocity .....	49
Figure 34. Dryer Design C – Average Airflow Velocities (High Heat and Wet Load) .....	50
Figure 35. Dryer Design C – Primary Thermostat Bypassed .....	52
Figure 36. Dryer Design D – Airflow Through the Tumbler .....	53
Figure 37. Setup with a Relay and Battery for T2 Analog .....	54
Figure 38. Dryer Design D – Thermocouple and Airflow Measurements (Wet Load) .....	56
Figure 39. Thermocouple, Airflow and Relay (T2 Analog) Measurements .....	57
Figure 40. Dryer Design D – T1 Heater Intake Comparison .....	58
Figure 41. Dryer Design D – T3 Heater Housing Temperature Comparison .....	59
Figure 42. Dryer Design D – Intake Air Velocity .....	61
Figure 43. Dryer Design D – Exhaust Vent Air Velocity .....	62
Figure 44. Dryer Design D – Average Airflow Velocities (High Heat and No Load) .....	63
Figure 45. Dryer Design D – Primary Thermostat Bypassed .....	65
Figure 46. Dryer Design A Used in Task 3 Testing .....	66

US CONSUMER PRODUCT SAFETY COMMISSION  
FINAL REPORT ON ELECTRIC CLOTHES DRYERS AND LINT IGNITION CHARACTERISTICS  
May 2003

Figure 47. Lint Accumulated at Bottom of Dryer After 100 cycles .....	68
Figure 48. Lint Accumulated on Interior of Dryer After 48 Cycles .....	69
Figure 49. Lint Accumulated on Interior of Dryer After 100 Cycles .....	69
Figure 50. Lint Build-up at Blower Housing Seal and Dryer Floor .....	70
Figure 51. Test Setup for Lint Ignition .....	73
Figure 52. Test Setup for Lint Ignition .....	74
Figure 53. Location of Lint Samples on the Housing .....	75
Figure 54. Lint Sample on Heater Housing at Location A .....	76
Figure 55. Sample Smoldering at Location A .....	77
Figure 56. Sample s5-8 at Location B .....	78
Figure 57. Thermocouple Data for Sample s5-8 .....	78
Figure 58. Sample s2-7 on the Side of the Heater Housing at Location C .....	80
Figure 59. Sample s2-7 Thermocouple Traces .....	80
Figure 60. Sample s2-2 Tested at Location D .....	81
Figure 61. Sample s2-6 Tested at Location E .....	82
Figure 62. Thermocouple Traces for Sample s2-6 at Location E .....	83
Figure 63. Lint Sample at Heater Intake .....	84
Figure 64. Infrared Camera Setup .....	84
Figure 65. Sample s3-10, Video Camera and Infrared Camera .....	87
Figure 66. Sample s3-10 – Thermocouple and Airflow Data .....	88
Figure 67. Setup with Glass Tube .....	89
Figure 68. Setup with Target Material in the Glass Tube .....	91
Figure 69. Target Sample Igniting During Test 1 .....	93
Figure 70. Test 1 – Thermocouple and Airflow Measurements Task 4- Test 1 .....	94
Figure 71. Dryer Design Comparison for T1, Heater Intake .....	97
Figure 72. Dryer Design Comparison for T3, Heater Housing .....	97
Figure 73. Dryer Design Comparison for T5, Blower Intake .....	98
Figure 74. Dryer Design Comparison for T4, Exhaust Vent .....	98
Figure 75. Maximum Temperatures Measured at Location .....	99
Figure 76. Intake into the Heater .....	101
Figure 77. Heater Exhaust Temperature .....	101
Figure 78. Heater Housing Temperature .....	102
Figure 79. Exhaust Vent Temperature .....	102
Figure 80. Intake into the Blower Temperature .....	103
Figure 81. Intake into the Tumbler Temperature .....	103
Figure 82. Maximum Temperatures for All Dryers at Each Location and Condition .....	105
Figure 83. Comparison of Exhaust Air Velocity for all Dryer Designs .....	107
Figure 84. Calculated Average Exhaust Air Velocity .....	107
Figures 85 (a) and (b). Dryer Design A – Blower Assembly .....	108
Figure 86. An Illustration of Airflow through the Dryer and Blower .....	109
Figure 87. Junction Between the Blower and Exhaust Vent .....	110
Figure 88. Lint Samples Tested 3 Inches from the Heater Housing Edge .....	112
Figure 89. T1 Only - 3 Inches from the Heater Housing Edge .....	113
Figure 90. T2 Only - 3 Inches from the Heater Housing Edge .....	113
Figure 91. T3 Only - 3 Inches from the Heater Housing Edge .....	114
Figure 92. Lint Samples Tested 4 Inches from the Heater Housing Edge .....	115
Figure 93. Ignition Time for 2 and 3 Inches from Heater Edge .....	116
Figure 94. Lint Samples s3-16 and s3-17 Tested 1 Inch from the Heater Edge .....	117
Figure 95. Lint Samples s3-14 and s3-18 Tested 2 Inches from the Heater Edge .....	118
Figure 96. High Limit Activation Time Comparison at Sample 2 and 3 inches .....	119

Figure 97. Lint Samples Tested 1 Inch from the Heater Edge with Airflow .....	120
Figure 98. Samples Tested at 1 Inch, With and Without High-Limit Thermostat.....	121
Figure 99. Sample s3-13 Test with the High Limit Thermostat in Series .....	123
Figure 100. Failed Thermostat compared to a Replacement Thermostat.....	124
Figure 101. X-ray Images of High-Limit Thermostat 1 (HLT1).....	125
Figure 102. Contacts for High-Limit Thermostat 1 (HLT1).....	125
Figure 103. Contact Pads for High-Limit Thermostat 1 (HLT1).....	126
Figure 104. Sample s5-14 with High Limit Thermostat in Series .....	127
Figure 105. High-Limit Thermostat 2 (HLT2) before and after Failure .....	128
Figure 106. X-ray Images of High-Limit Thermostat 2 (HLT2).....	129
Figure 107. Internal View for High-Limit Thermostat 2 .....	129
Figure 108. Setup for Testing High-Limit Thermostats .....	130
Figure 109. New High Limit Thermostat.....	130
Figure 110. Thermocouple Data for the New High-Limit Thermostat.....	131
Figure 111. Second Failed High Limit Thermostat, HLT2.....	131
Figure 112. Comparison between New and Failed High Limit Thermostats .....	132

## LIST OF TABLES

Table 1. Unrestricted and Restricted Duct Configurations.....	9
Table 2. Equivalent Linear Duct Length .....	10
Table 3. General Locations of Thermocouples and Anemometers.....	12
Table 3-continued. General Locations of Thermocouples and Anemometers .....	13
Table 4. Dryer Design A Measurement Data (°C and sfpm).....	15
Table 5. Dryer Design B Statistics (°C and sfpm).....	28
Table 6. Dryer Design C – Statistics (°C and sfpm).....	41
Table 6. Thermocouple Location and Setup.....	71
Table 7. Testing on Top of the Heater Housing at Location A .....	76
Table 8. Testing on Top of the Heater Housing at Location B. ....	77
Table 9. Testing on the Side of the Heater Housing at Location C .....	79
Table 10. Testing on Top of the Heater Housing at Location D .....	81
Table 11. Testing on the Side of the Heater Housing at Location E .....	82
Table 12. Lint Samples at the Heater Intake .....	86
Table 13. Lint Samples for Task 4 - Phase II Testing.....	90
Table 14. Target Materials for Task 4 - Phase II Testing.....	91
Table 15. Change in Minimum Temperature .....	106
Table 16. Change in Average Temperature .....	106
Table 17. Change in Maximum Temperature .....	106
Table 18. Ignition Times at Heater Intake .....	115
Table 19. Approximate High Limit Thermostat Activation Times .....	118
Table 20. Life History of Failed High-Limit Thermostats .....	123

## 1.0 INTRODUCTION

### 1.1 General

Over the years, the number of safety devices included in clothes dryers to reduce the incidence of fire has increased. The increased safety of dryers has likely contributed to the slowed growth rate in dryer fires. However, there were an estimated 15,600 clothes dryer fires resulting in 20 deaths, 370 injuries and \$75.4 million in property damage in 1998<sup>2</sup>.

In 1998, 56.2% of all U.S. households had an electric clothes dryer, and 17.9% had a gas dryer<sup>3</sup>. In total, over 74% of all U.S. households had at least one clothes dryer in 1998. There are just over 100 million US households; thus, there are over 74 million clothes dryers in use in the U.S. Over the period 1990 through 1998, shipments (gas, electric, and compact dryers) increased 41% overall, from almost 4.6 million units to almost 6.5 million units<sup>3</sup>. In 2001, the number of dryer shipments was over 6.7 million units<sup>4</sup>. There was a consistent growth in the sales of clothes dryers in the U.S. from 1990 to 2001.

The U.S. Consumer Product Safety Commission (CPSC) initiated a project in Fiscal Year (FY) 2002 to investigate possible conditions that may lead to dryer fires and to assess the adequacy of the applicable voluntary standards in addressing potential hazards.

Four years earlier, in FY 1998, CPSC staff began an initial evaluation of clothes dryers. The results of the tests conducted during that evaluation showed that, when the dryer exhaust was blocked, some areas of the dryer would run cooler than normal and other areas would run hotter. CPSC staff believed that long-term operation of a dryer under conditions of restricted airflow, such as that caused by lint accumulation, could eventually lead to premature failure of components that may result in a fire.

### 1.2 Project Objective

The CPSC clothes dryer project was initiated to determine the cause(s) for clothes dryer fires and to develop recommendations for revisions and/or additions to the voluntary standards to address those causes and help prevent dryer fires.

### 1.3 Focus Objective

The focus objective of this project was to evaluate the effects of lint accumulation and above-normal operating temperatures in electric clothes dryers and determine whether such conditions may result in dryer fires and/or lint ignition.

---

<sup>2</sup> Mah, J., "Table 1, Estimated Residential Structure Fires Selected Equipment 1998," *1998 Residential Fire Loss Estimates*, Directorate for Epidemiology, US Consumer Product Safety Commission, 1998.

<sup>3</sup> *Appliance Magazine*, Statistically Review, A Dana Chase Publication, May 1999

<sup>4</sup> *Appliance Magazine*, U.S. Shipment Statistics, A Dana Chase Publication, March 2002

## **1.4 Technical Approach**

The overall goal was to determine whether lint accumulation could result in clothes dryer fires and/or lint ignition. To accomplish this large task, smaller tasks were designed to link the cause of lint accumulation to possible dryer fires and/or lint ignition. The tasks were set up to eliminate as many dryer design variables as possible.

Tests were conducted with sample clothes dryers at both normal and above-normal operating temperatures; with dryers operating in the high-limit cycle mode (caused by either a fully or partially blocked exhaust vent); with bypassed temperature limiting devices (simulating component failure); and without any safety temperature limiting devices.

The following four smaller tasks were defined to accomplish the main objective:

### **1.4.1 Task 1: Inspect and Record Dryer Design**

The objective of this task was to record the types and locations of the internal components and layout for each sample dryer and to photograph the internal configuration of each dryer. The airflow path throughout each dryer was illustrated and the locations of the heater, blower, and lint screen were documented. Based on the results of the examination of the dryers, the location of instrumentation was determined for Task 2 - Document Dryer Operating Characteristics.

### **1.4.2 Task 2: Document Dryer Operating Characteristics**

The objective of this task was to characterize the airflow patterns and temperatures inside each dryer design during normal (unblocked) and restricted (blocked) airflow through the exhaust vent. The dryers were characterized by operating according to the manufacturer's instructions with a (wet and/or dry) clothes load and without a load (a dryer may have been fully characterized with a wet load if the test data developed for a dry load and wet load, with no exhaust blockage, were not comparable.) The data in this task was used to set the test variables in Task 4 - Determine the Characteristics for Lint Ignition.

### **1.4.3 Task 3: Monitor Lint Distribution**

The objective of this task was to monitor lint distribution and accumulation in areas within a clothes dryer during operation with normal airflow. The load for these tests consisted of 10 wet (washed and spun dry) bath towels. A dryer was operated according to the manufacturer's instructions and subjected to normal use drying cycles. The dryer was operated for a total of 100 cycles. After 48 cycles, the accumulation of lint was recorded near the heater housing, internal exhaust duct, and internal dryer floor. The dryer was examined at the end of 100 cycles.

Lint accumulation was characterized in one dryer. An analysis of potential causes for lint accumulation in other dryer designs was conducted.

#### 1.4.4 Task 4: Determine Characteristics Required for Lint Ignition

This task had two objectives: Evaluate the ignition characteristics of lint samples on and near the heater box, and evaluate the ignition characteristics of lint when samples were ingested into the heater box. The lint samples used in these tests were 100% cotton and were taken from the lint that accumulated during tests conducted in Task 3, unless otherwise noted.

##### *1.4.4.1 Ignition of Lint on and near the Heater Housing*

The heat output and airflow through a heater were varied. Lint samples were placed at various locations on and near the heater box. Power to the heating element was introduced instantaneously or was stepped up to observe the different effects on the lint samples. Some tests were conducted with the high limit thermostat in series with the heating element, and some were conducted with the thermostat bypassed. The test results were categorized as one of the following: no ignition, charred only, smoldered, or ignition (flames).

##### *1.4.4.2 Ignition of Lint Ingested into the Heater*

Lint was introduced into the airflow of the heater intake. The lint samples were placed in front of the heater opening and restrained until ready for release. The system (heater, temperature, and air velocity) was stabilized for 5 minutes before proceeding. When the system had stabilized, the lint samples were released. The results were observed for 15 minutes, or less if the samples were consumed.

### **1.5 Organization of the Report**

This report is presented in two parts. The first part discusses the overall testing program and includes pertinent test descriptions and resultant data, analysis, findings and conclusions. The organization is such that each task is headed as a major test phase.

The second part contains appendices that present expanded test data to support the findings and the conclusions. The appendices are also contained on the compact disk (CD), which can be accessed through a sub menu.

### **1.6 Statement of Test Methodology**

The test program was designed to identify and eliminate as many dryer design variables as possible for Task 4 testing. During the tests, temperature and airflow characteristics of each dryer design were recorded. Observations regarding dryer designs that may have caused variances in the test data are noted in the report.

A large amount of test data was collected during this test program. Only the pertinent data for each task are presented. All data collected are noted in the report but may not be presented if the data are not pertinent to the discussion or conclusions.

The clothes dryers used in this test program were selected by design, cost and features available. Different dryer designs were selected to demonstrate the variety of temperature and



airflow patterns in a dryer. The dryers selected were in the price range of \$300 to \$400 and included similar selectable dryer settings and features.

Although only electric dryers were tested in this program, many of the conclusions may be applicable to gas-fueled clothes dryers.

## 1.7 Global Terminology

Lint	100% cotton fibers that were expelled from a clothes load of cotton terry towels during the drying process. The lint material may refer to the material collected from the lint screen or the material that accumulated inside the cabinet (housing) of the dryer.
Units	Unless otherwise specified, all temperatures reported are in degrees Celsius (°C), all airflow measurements are in standard feet per minute (sfpm), and all weight measurements are in grams (g), and length in inches (in) and feet (ft).
Top	The side of the dryer that is viewed from above.
Front	The side of the dryer containing the door.
Rear	The side of the dryer containing the dryer's exhaust vent and power cord.
Floor	The internal side of the bottom of the dryer that rests on the building floor.
Inside	The interior of the dryer containing the motor, drum, blower, and heater.
Smolder	May contain one or more of the following: smoke, embers, or charring with no evidence of flames.
Ignition	Flames are visible.
Test Load	The load of towels used in the dryer, either dry or wet load.
Wet Load	Ten 100% cotton terry towels that were washed and spun dry in a washing machine, unless otherwise specified. No detergent was used.
Dry Load	Ten 100% cotton terry towels that were dry to the touch, unless otherwise specified.
Damp Load	Ten 100% cotton terry towels that were wet to the touch, but weighed substantially less than a wet load, unless otherwise specified. No detergent was used.
High Limit Thermostat	The thermostat located near the heating element of the dryer (High-Limit Switch).

**Primary Thermostat**

The thermostat located between the lint screen and the blower (Operating Switch, Operating Thermostat).

**Thermostat Opened**

The thermostat reached its upper set point temperature and separated the contacts.

**Thermostat Closed**

The thermostat reached its lower set point temperature and closed the contacts.

**Abnormal Operating Condition**

The dryer operating or cycling on the high-limit thermostat, or tests conducted with all devices bypassed.

**Normal Operating Condition**

The dryer operating or cycling on the primary thermostat.

**High-Limit Cycling**

The dryer operating or cycling on the High-Limit Thermostat.

**Exhaust Vent**

The venting from the dryer to the outside of the building. All venting material was 4-inch rigid metal duct. All joints were sealed with foil tape except for the connection to the dryer; the exhaust vent was secured to the dryer using a 4-inch duct (hose) clamp.

**Fully Blocked Exhaust**

The exhaust vent was completely obstructed with a blast plate (100% blocked).

**Partially Blocked Exhaust**

The airflow in the exhaust vent was restricted by an iris opening less than 4 inches in diameter (25%, 50%, and 75% blocked).

**Unblocked Exhaust**

The exhaust vent contained no obstruction.

**Heater**

The mechanism to warm the air flowing through the dryer (the heating element).

**Heater Box**

A rectangular shaped housing containing the heating element.

## 2.0 DESCRIPTION OF TESTS AND TEST RESULTS

### 2.1 Task 1: Inspect and Record Dryer Design

To form the basis for the analysis to characterize lint ignition, the operating characteristics of four different dryer designs were examined. The pattern of airflow; the locations of the heater, safety devices, and lint screen; and the tumbler and fan design were examined for each dryer design.

#### 2.1.1 Airflow Pattern

All four dryer designs had the same basic path for airflow. Air is pulled into the dryer through any gaps in the dryer housing, particularly through rear vents. Air is drawn over the heater, which warms the air, and then enters the tumbler. The air exits the tumbler and is directed through the lint screen. It then passes through a duct and into the fan. The fan forces the air through an exiting duct to the rear of the dryer. Figure 1 shows the airflow patterns for each of the dryer designs tested.

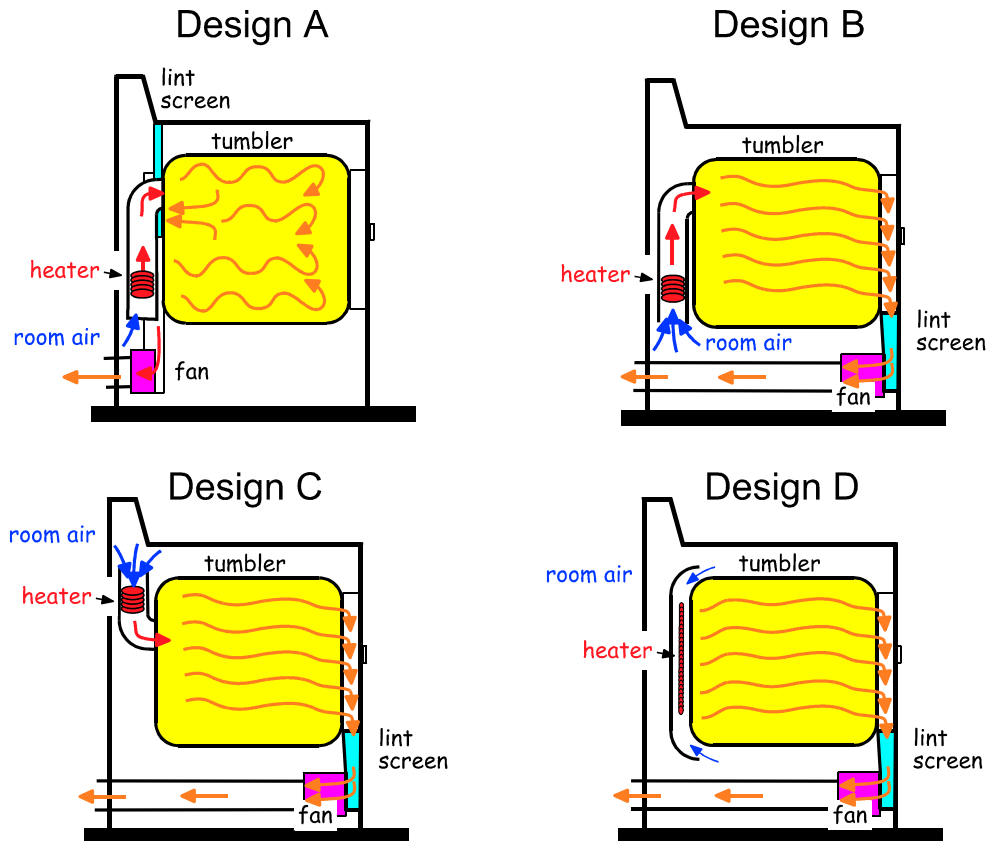

Figure 1. Dryer Design Characteristics  
(Not to scale)

### 2.1.2 Heater Location and Configuration

In all four clothes dryers, the heaters were located at the rear of the dryer. In three of the dryer designs, the heating element was contained in a rectangular metal enclosure, or “heater box” (Dryer Designs A, B and C). The location of the heater box varied among these three dryers. In two dryers, the heater boxes were oriented with the air intake directed towards the floor of the dryers (Dryer Designs A and B); and in the other dryer, the heater box was located near the top and the air intake directed towards the top of the dryer (Dryer Design C). The heating elements contained either one or two rows inside the heater box, as shown in Figure 2. The fourth dryer (Dryer Design D) had a circular heating element configuration as shown in Figure 3. The circular heating element was located behind the tumbler.

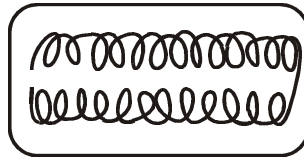

Figure 2. Heating Element in a Heater Box Configuration  
(Does not represent any specific dryer design)

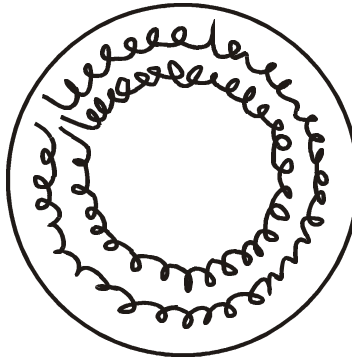

Figure 3. Circular Heating Element in Dryer Design D  
(Not to Scale)

### 2.1.3 Lint Screen Location

In three of the four dryers, the lint screen was located at the front of the dryer and was accessible at the bottom of the door opening (Dryer Designs B, C and D). The lint screen of the fourth dryer was located at the rear of the dryer and was accessible from the top of the dryer (Dryer Design A).

### 2.1.4 Tumbler Design

The tumbler designs and sizes were similar for all four dryers with several noted differences. All the tumblers contained gaskets at the front and rear of the tumbler. Three of

the tumbler designs contained three baffles each that were spaced evenly. The other tumbler contained two baffles and a hump, evenly spaced.

#### 2.1.5 Blower (Fan) Design

All four dryers used a centrifugal-type fan. The centrifugal fan drew air through the center and forced it outward. All the fan “blades” were constructed of plastic or plastic reinforced with fibers.

#### 2.1.6 Operating Features

All dryer designs offered a choice of drying cycles: Timed Dry, Air Dry and Auto Dry. To eliminate any possible design variance in drying times during testing, only the Timed Dry cycle was used.

#### 2.1.7 Safety Device Locations

The locations of the safety devices on the dryers were similar. All four dryers had a minimum of two safety devices. One temperature switch (the primary or operating thermostat) was located after the lint screen and before the blower air intake. The second temperature switch (the high-limit thermostat) was located near the heater air intake.

### **2.2 Task 2: Document Dryer Operating Characteristics**

The main objective of this task was to record any similar or varying characteristics of a clothes dryer during normal and abnormal operations. The normal operation test was conducted with unrestricted airflow in the exhaust vent. Abnormal operation was defined as the dryer not cycling on the primary thermostat or cycling on the high-limit thermostat. The effects of a restricted exhaust vent were examined. The effects of a bypassed primary thermostat (to simulate thermostat failure) were also characterized.

#### 2.2.1 Exhaust Vent Setup

The same length and configuration of exhaust duct was used to vent each dryer design during testing. All venting material was 4-inch rigid metal duct. All joints were sealed with foil tape except the connection from the ducting to the dryer, which was secured using a 4-inch duct (hose) clamp. The exhaust vent was connected to a 4” angled wall cap. The wall cap contained a rodent screen with a grid of ¼-inch square openings. Figure 4 illustrates the setup used to vent the dryers.

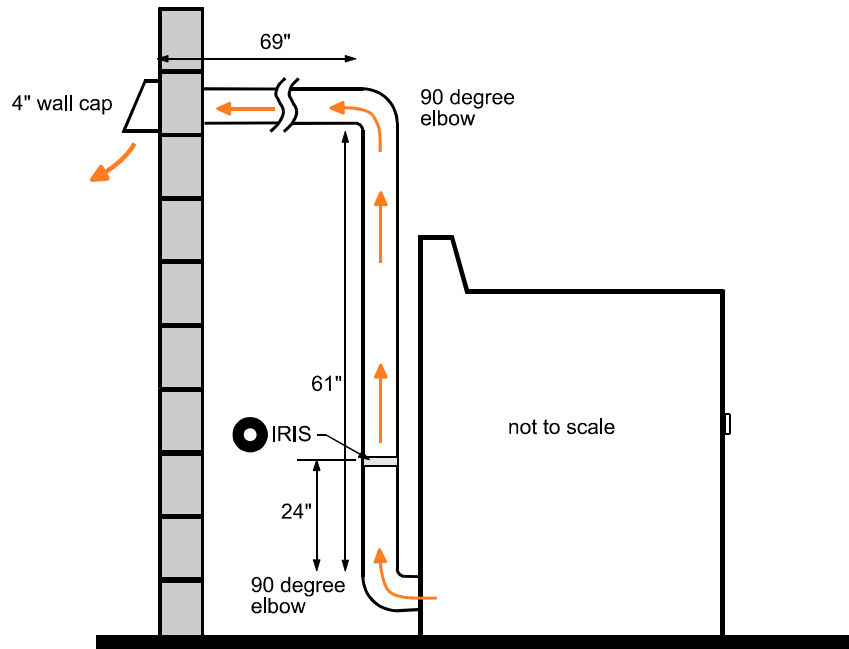

Figure 4. Exhaust Vent Setup

For tests in which airflow was restricted, an iris – placed in series with the exhaust duct between the first and second 90-degree elbows – was used to create a partially-blocked exhaust vent condition. Blockages of 25%, 50% and 75% were created using the iris. The percentage of blockage was calculated from that part of the cross section of the 4-inch duct that remained unblocked, as shown in Table 1.

A blast plate covering 100% of the opening was used to create a fully-blocked exhaust vent (100% blockage). The blast plate was placed in the same location as the iris in the exhaust vent.

Table 1. Unrestricted and Restricted Duct Configurations

	d (inches)	Blockage (%)
	4	0 unrestricted
	3.46	25 partially
	2.83	50 partially
	2	75 partially
	0	100 blocked

Table 2 is a guide to determine the equivalent linear length of exhaust duct used in the testing. The table references were taken from *Engineering and Design – Clothes Dryer Exhaust Venting* published by the Department of the Army, Army Corps of Engineers, 23 March 1998, No. 1110-3-483. For every 90-degree elbow, the document specifies an equivalent length of 8 or 10 linear feet. Based on the calculated equivalent linear feet shown below, the exhaust vent configuration used in the test set up was within dryer manufacturer recommendations for installation for all dryers tested.

Table 2. Equivalent Linear Duct Length

	<b>Equivalent Linear Duct Length (feet)</b>	
	<i>8' equivalent for elbows</i>	<i>10' equivalent for elbows</i>
<i>Elbow 1</i>	8	10
<i>Straight 1</i>	5	5
<i>Elbow 2</i>	8	10
<i>Straight 2</i>	5.75	5.75
<i>Wall Cap*</i>	6	6
<b>TOTAL</b>	<b>32.75</b>	<b>36.75</b>

\* Conversion taken from dryer installation manuals

### 2.2.2 Instrumentation Setup

Each dryer was instrumented with six thermocouples and two hot wire anemometers. One additional thermocouple was used to record the ambient room temperature. All seven thermocouples were 24 gauge, K type. The 24 gauge thermocouple is relatively stiff and resulted in good stability in positioning the thermocouples. In addition, with a sampling rate of one sample per second, the response time of the thermocouples was adequate.

The thermocouples were calibrated using a thermocouple oven before each dryer design was tested. The sampling rate during calibration was one sample every 1/10 second. Figure 5 shows the responses of the thermocouples versus the set oven temperature, recorded on November 14, 2001, before Task 2 (Document Dryer Operating Characteristics) testing began. The figure shows a close match to the oven temperature except near the upper temperatures.

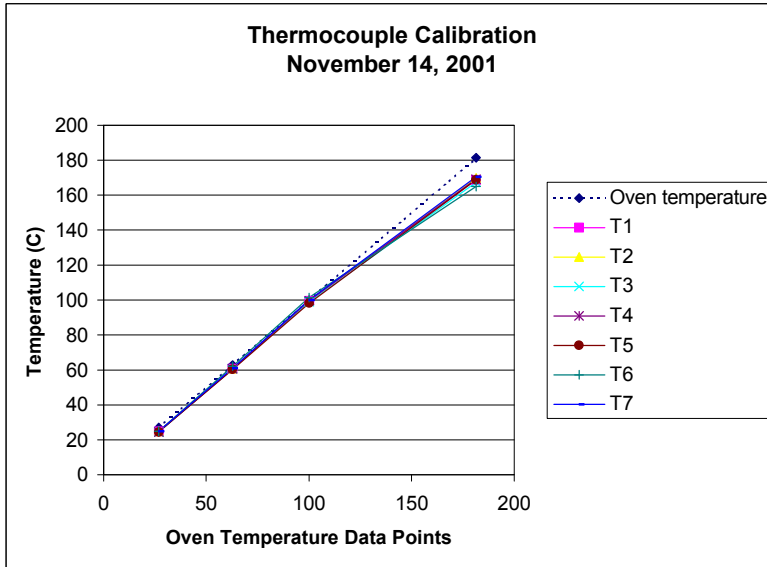

Figure 5. Thermocouple Response Before Task 2 Testing

At the end of this task, the thermocouples were re-checked, as shown in Figure 6. Figure 6 shows the high temperature closely follows the oven set temperature. The calibration/check tests taken in December 2001 and early January 2002 also have similar responses.

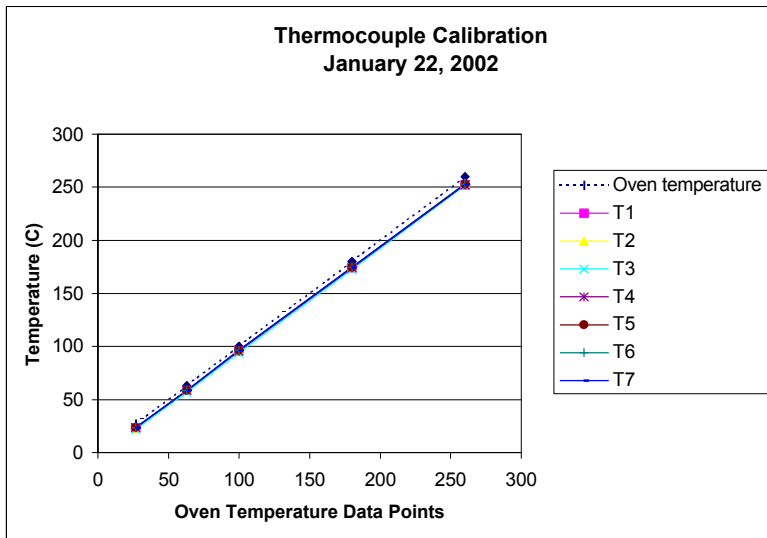

Figure 6. Thermocouple Response After Task 2 Testing

Figure 7 shows the average temperatures for all thermocouples compared to the oven temperatures for the days they were calibrated. The responses of the thermocouples show they are slightly below the oven set temperatures. The data presented in this document do not incorporate any correction factors in the thermocouple readings.



US CONSUMER PRODUCT SAFETY COMMISSION  
 FINAL REPORT ON ELECTRIC CLOTHES DRYERS AND LINT IGNITION CHARACTERISTICS  
 May 2003

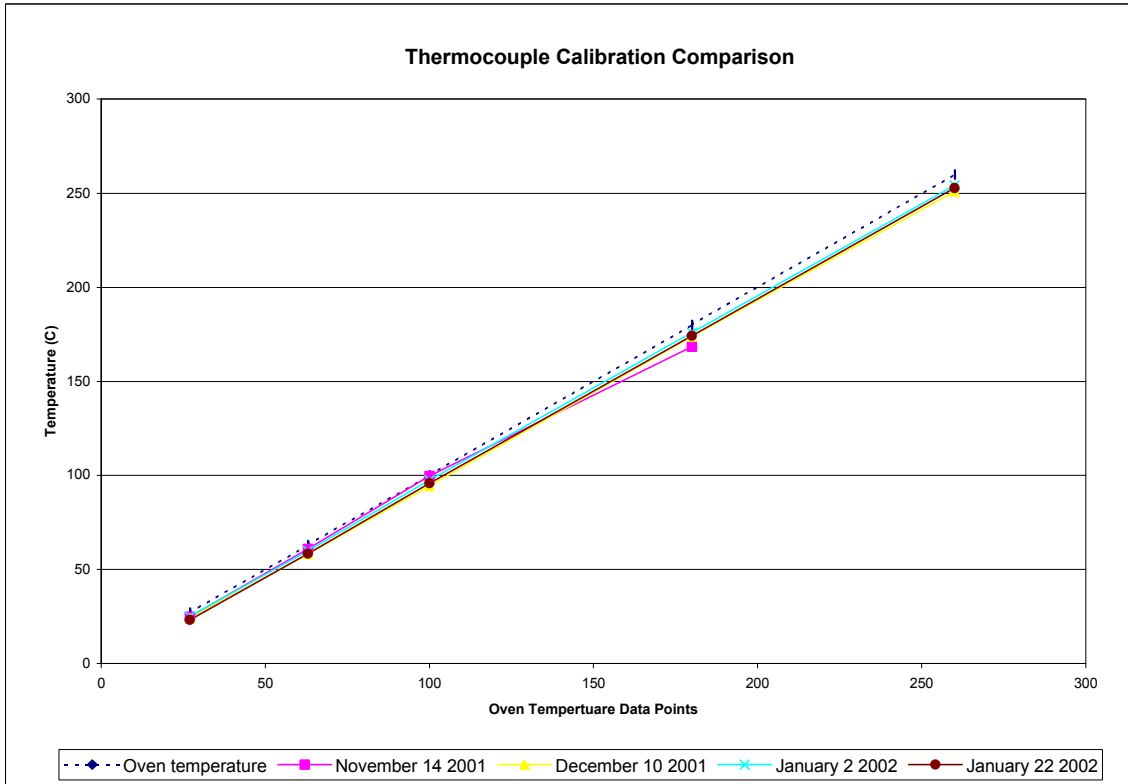

Figure 7. Average Responses per Oven Set Temperatures and Day

Table 3 lists the general locations of the thermocouples and anemometers in the dryers. Depending on the dryer design, the actual location may have varied slightly.

Two hot wire anemometers were used to measure the airflow entering and exiting each dryer. One anemometer was placed at the intake into the heater, and the second anemometer was placed in the exhaust vent. Because of instrumentation limits, the sampling rate for the anemometers was one sample every 2 seconds. However, this was adequate since the analysis only needed to show trends in airflow.

Table 3. General Locations of Thermocouples and Anemometers

Thermocouple Number	Location
T1	Heater Intake
T2	Heater Exhaust
T3	Heater Housing
T4	Vent Exhaust
T5	Intake into Blower
T6	Intake into the Tumbler
T7	Ambient Room

Table 3-continued. General Locations of Thermocouples and Anemometers

Anemometer Number	Location
V1	Heater Intake
V2	Dryer Exhaust

### 2.2.3 Global Test Procedure and Setup

All dryers were tested at the high heat settings with no test load, with a dry load and with a wet load, unless otherwise specified. All dryers were tested with 25%, 50%, 75%, and 100% blockage in the exhaust vent with no test load and with a dry load, unless otherwise specified.

Some of the clothes dryer instruction manuals specified a maximum load. The smallest of those was chosen as the test load. The standard test load was 10 bath towels of white 100% cotton terry, 45" long by 25.5" to 27" wide, each weighing approximately 570g (1.25 lbs.). For wet loads, the loads were washed and spun dry in a standard size washing machine set for Hot/Cold (hot wash/cold rinse) and Regular 10 [minutes]. No detergent was used in the wash.

The clothes dryers were set for drying times of 60 minutes for wet loads and 15 minutes for dry loads using the Timed Dry feature.

To accelerate the test process, the data for dry loads with no exhaust vent blockage was compared with data for wet loads with no exhaust vent blockage. If the thermocouple and airflow data were similar, additional tests with fully-blocked or partially-blocked exhaust vents were conducted using dry loads only (unless otherwise noted).

The rodent screen was checked and cleaned after each set of dryer design tests.

## 2.2.4 Dryer Design A

Dryer Design A was configured with the heater at the rear bottom of the dryer and the lint screen at the rear top of the dryer. The heated air entered one opening at the rear of the tumbler, and the moist air exited through a separate opening at the rear of the tumbler, as shown in Figure 8.

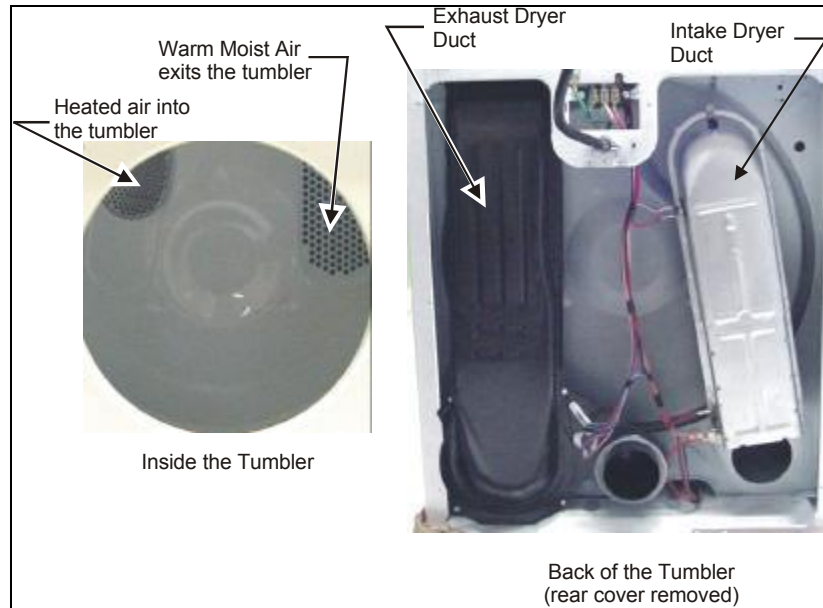

Figure 8. Dryer Design A Intake and Exhaust

### 2.2.4.1 *Dryer Design A – Temperature and Airflow Characteristics, Blocked and Unblocked Exhaust Vent Conditions*

The dryer was tested at the high heat setting with no test load, with a dry load and with a wet load. Figure 9 (at the end of this section) shows a graph of the thermocouple and airflow measurement data for Dryer Design A with a wet load. (Similar graphs of data for the tests with no load and with a dry load are contained in Appendix A.) As can be seen in the graph, the dryer was started approximately 120 seconds after data collection began. The primary thermostat disconnected power to the heater approximately 3183 seconds into the test.

It was observed that the exhaust vent airflow ( $V_2$ ) steadily decreased as the dryer operated. This was caused by the lint screen progressively becoming blocked with lint.

Table 4 below lists the average, minimum, and maximum temperatures recorded during the main drying phase. The data listed in the table cover the period between 120 seconds after the dryer was started to 120 seconds before the primary thermostat removed power from the heating element (to eliminate any unstabilized readings from energizing and de-energizing the heating element).

Table 4. Dryer Design A Measurement Data (°C and sfpm)

Temp	Min	Average	Max	Flow	Min	Average	Max
T1	43	62	73	V1	718	825	952
T2	249	285	323	V2	871	1034	1234
T3	81	109	127				
T4	33	56	70				
T5	37	58	84				
T6	198	236	262				
T7	21	23	24				

The dryer was tested with a partially-blocked exhaust vent (25%, 50%, 75% blockage), and a 100% blocked exhaust vent. For these tests, dry loads were used, since the temperature data from the thermocouples were similar for both dry and wet loads for the unblocked condition. (Appendix A shows the comparison between the dry and wet towel loads with no blockage in the exhaust vent.)

Figures 10 through 12 (at the end of this section) show a comparison of temperature measurement data for thermocouples T1, T3 and T2 for unblocked, partially-blocked, and fully-blocked vent conditions. (Appendix A contains graphs of the temperature data for the remaining thermocouples, T4, T5, T6 and T7.)

In Figure 10, it can be seen that the dryer began to operate on the high limit thermostat only when the exhaust duct was fully (100%) blocked. For the 25% and 50% blocked exhaust vent conditions, the temperatures measured were similar to those measured for the unblocked exhaust vent condition.

With a 75% blocked exhaust vent, the dryer still operated on the primary thermostat but at elevated temperatures; Figure 11 shows the heater box reached up to 150°C. In the unblocked condition or with exhaust vent blockages of 25% or 50%, the temperature of the heater box reached slightly over 100°C.

At exhaust vent blockages of 100% and 75%, the peak heater exhaust temperatures were similar – around 325°C to 375°C – as shown in Figure 12. However, the period during which the heater exhaust operated near the peak temperature differed for the two conditions. At 100% blockage, the temperature was not maintained at the peak temperature very long because the high limit thermostat cycled the heating element more rapidly. At 75% blockage, the duration the heater exhaust stayed near the peak temperature was approximately 100 to 300 seconds – until the primary thermostat switched the heating element off

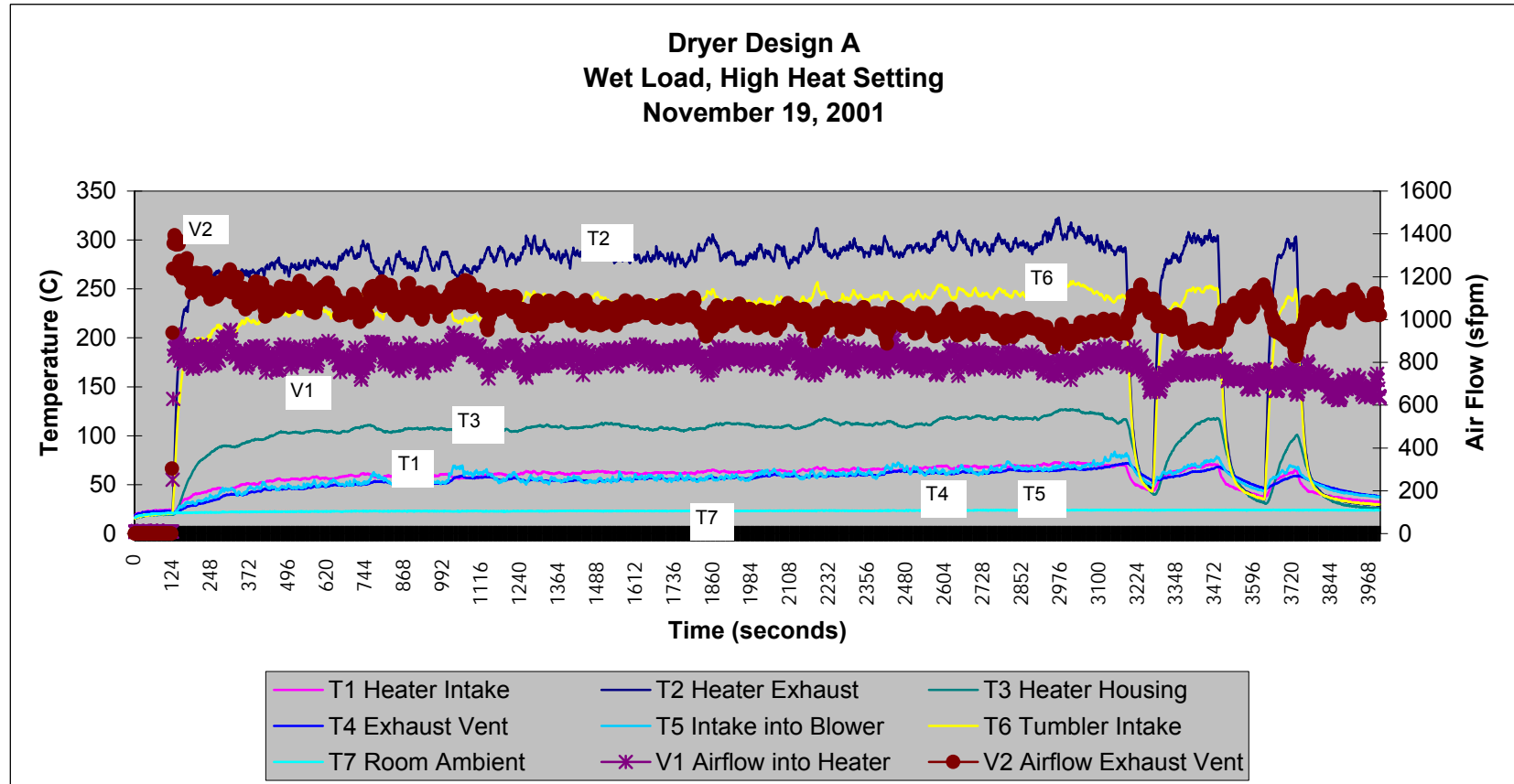

Figure 9. Dryer Design A – Thermocouple and Airflow Measurements with a Wet Load

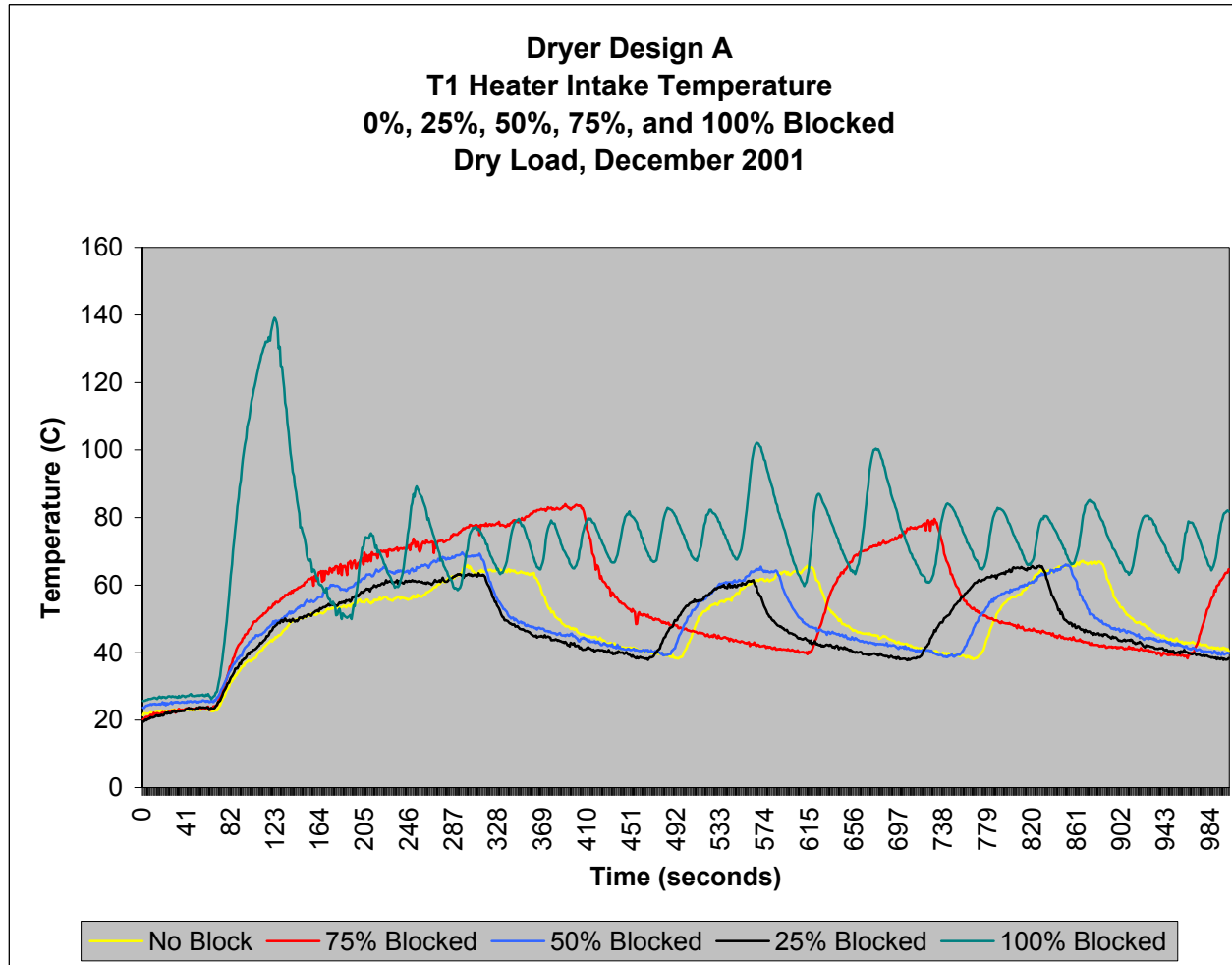

Figure 10. Dryer Design A – T1 Heater Intake Comparison

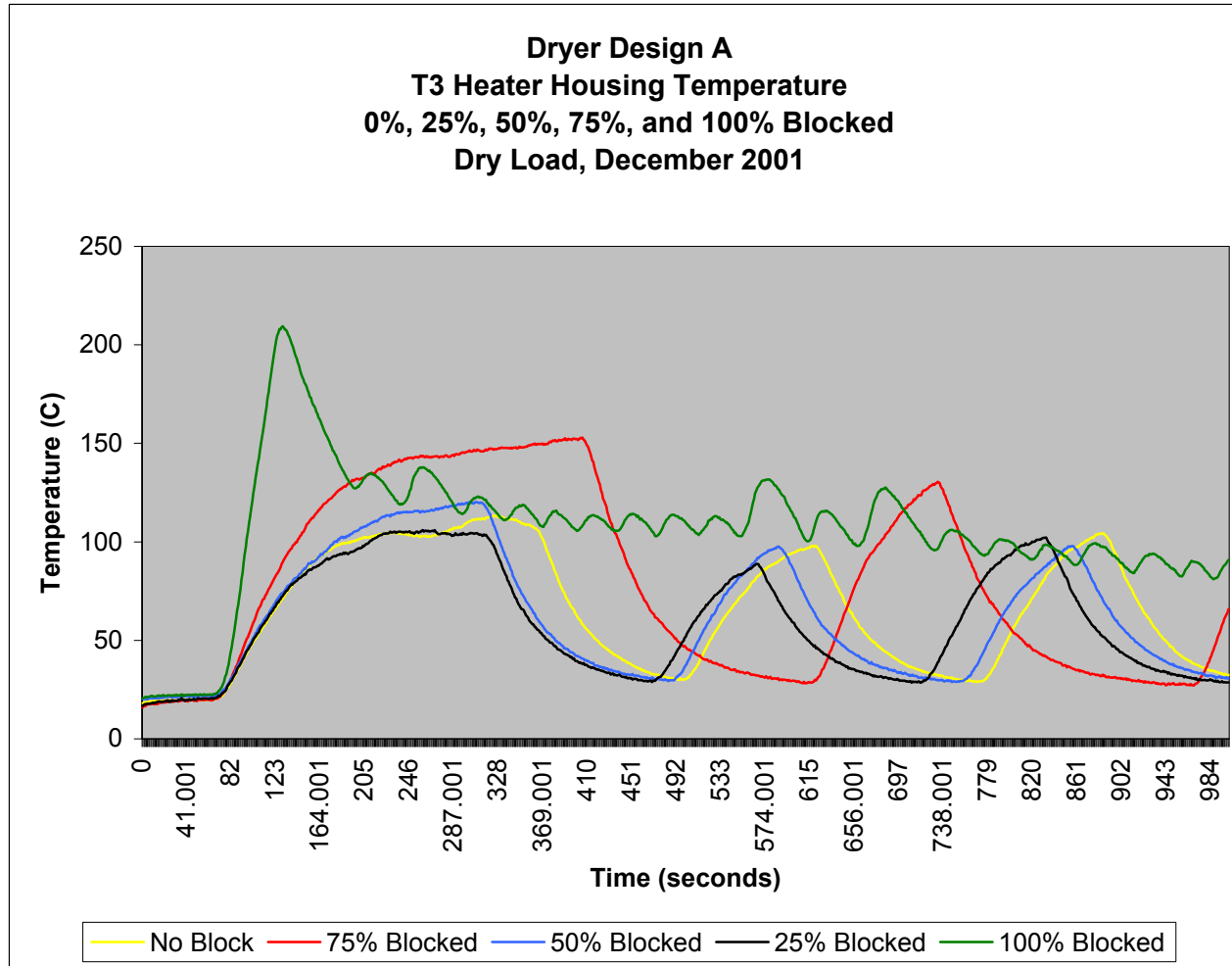

Figure 11. Dryer Design A – T3 Heater Housing Comparison

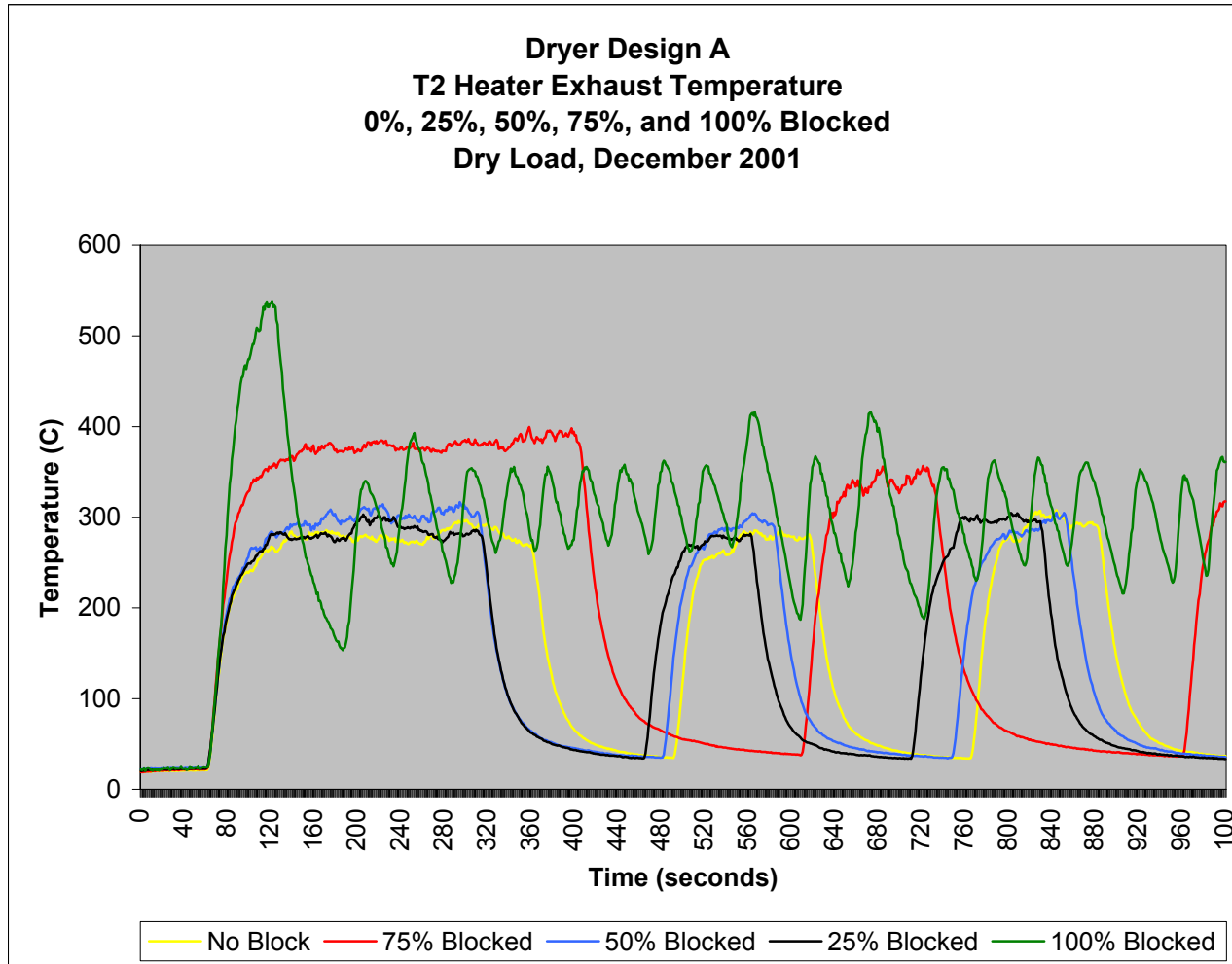

Figure 12. Dryer Design A – T2 Heater Exhaust Comparison



#### 2.2.4.2 Dryer Design A – Airflow

Airflow was measured using hot wire anemometers placed at the intake of the heater box and in the exhaust vent. Both anemometers were placed in the center of the cross-section of the air streams. The anemometer placed in the exhaust vent was positioned 36" after the first elbow to avoid circular turbulence effects from the dryer blower. As mentioned earlier, the iris and blast plate for the partially-blocked and 100% blocked conditions, respectively, were placed before the hot wire anemometer located in the exhaust vent.

Figure 13 shows comparisons of intake air velocities when the exhaust vent was unblocked, partially blocked, and fully blocked, and the dryer contained a dry load. The intake velocities were similar for the unblocked and 25% and 50% blocked conditions. There was a slight drop in the air velocity for the 75% blocked condition, but it was not significant enough to cause the dryer to operate in the high-limit cycling mode (as can be observed from the thermocouple data in Figure 12). With a 100% blocked exhaust vent, the air intake velocity dropped to about 200 sfpm.

Figure 14 is a graph comparing exhaust air velocities when the exhaust vent was unblocked, partially blocked, and fully blocked, and the dryer contained a dry load. The graph shows a slight overshoot in air velocity at initial startup of the dryer. The size of the overshoot decreased as the blockage increased. This was expected, since the anemometer was positioned after the blockage, which created a dampening effect. There was a slight increase in the velocity around 400 seconds, which was when the primary thermostat de-energized the heater. (This was also seen in Figure 9 – Thermocouple and Airflow with a Wet Load, when the dryer began cycling.) This was caused by the hot wire anemometer not responding fast enough to the change in temperature.

Figure 15 shows the average intake and exhaust air velocities for the different conditions of exhaust blockage. The data from 120 seconds to 1000 seconds were averaged. This excluded the initial overshoot when the blower was first powered. The intake air velocity stayed fairly constant for the unblocked, 25% and 50% blocked conditions; however, it began to decrease more rapidly when the exhaust vent was 50% and 75% blocked. At 100% blockage, the exhaust air velocity was near zero, as expected, and the average intake velocity was 179 sfpm.

Figure 16 is a graph similar to Figure 15 except that the dryer was operated with no test load and with no heat. The graph shows increased intake and exhaust air velocities when the tumbler was not filled as expected. Compared to Figure 15, there was a slightly more dramatic effect in the decrease of the air velocities as the exhaust vent was progressively blocked.

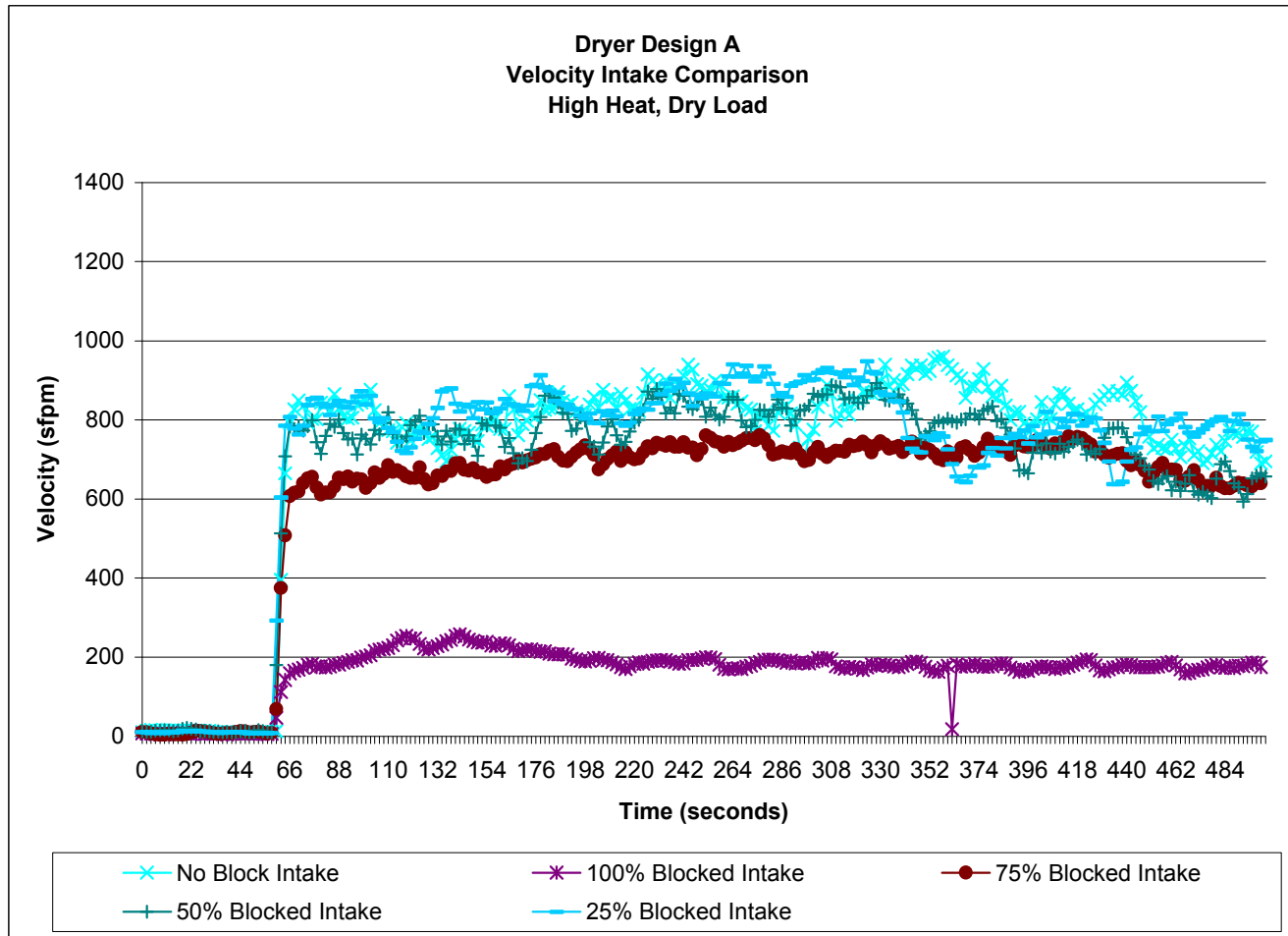

Figure 13. Dryer Design A – Intake Air Velocity

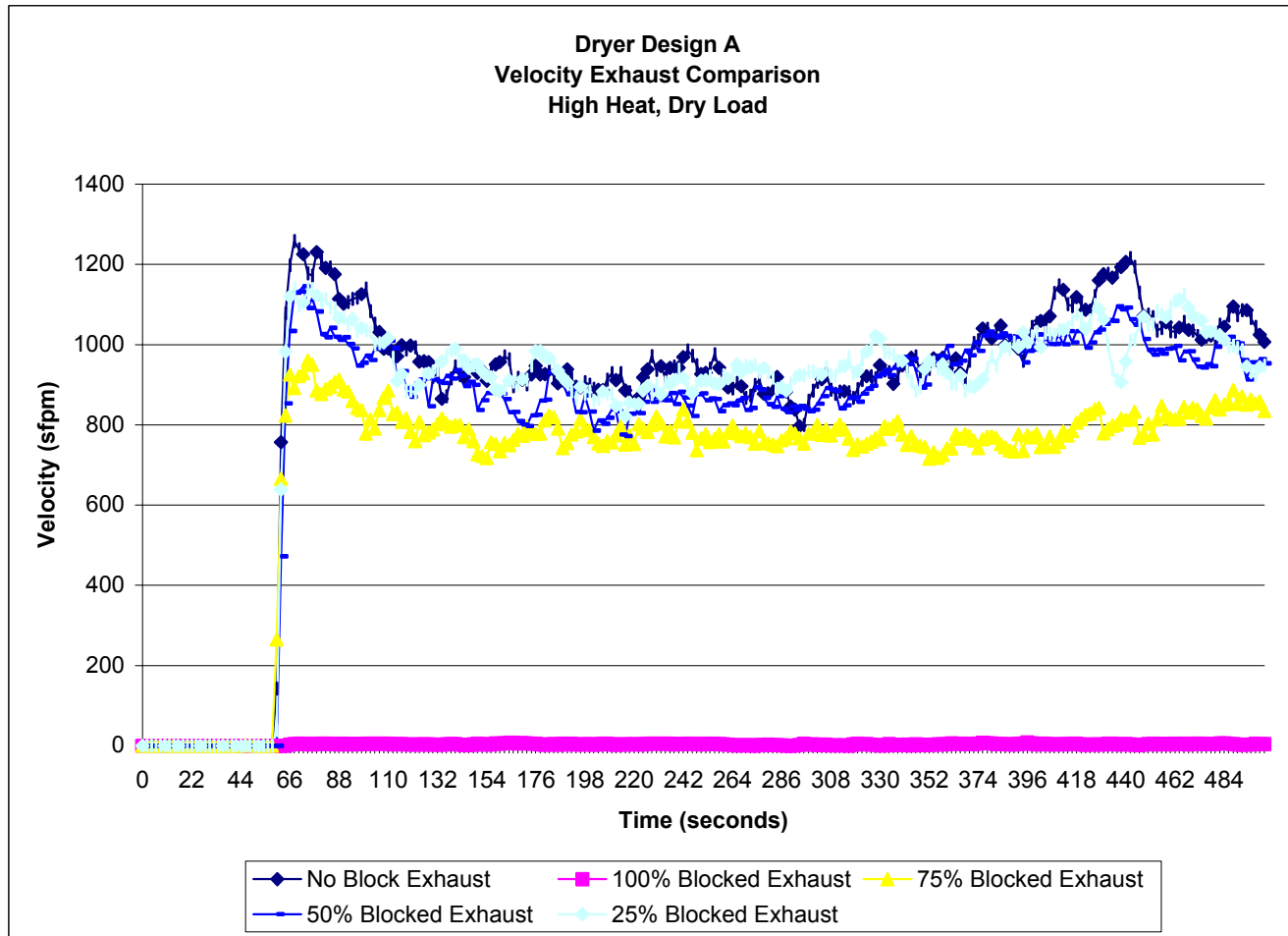

Figure 14. Dryer Design A – Exhaust Air Velocity

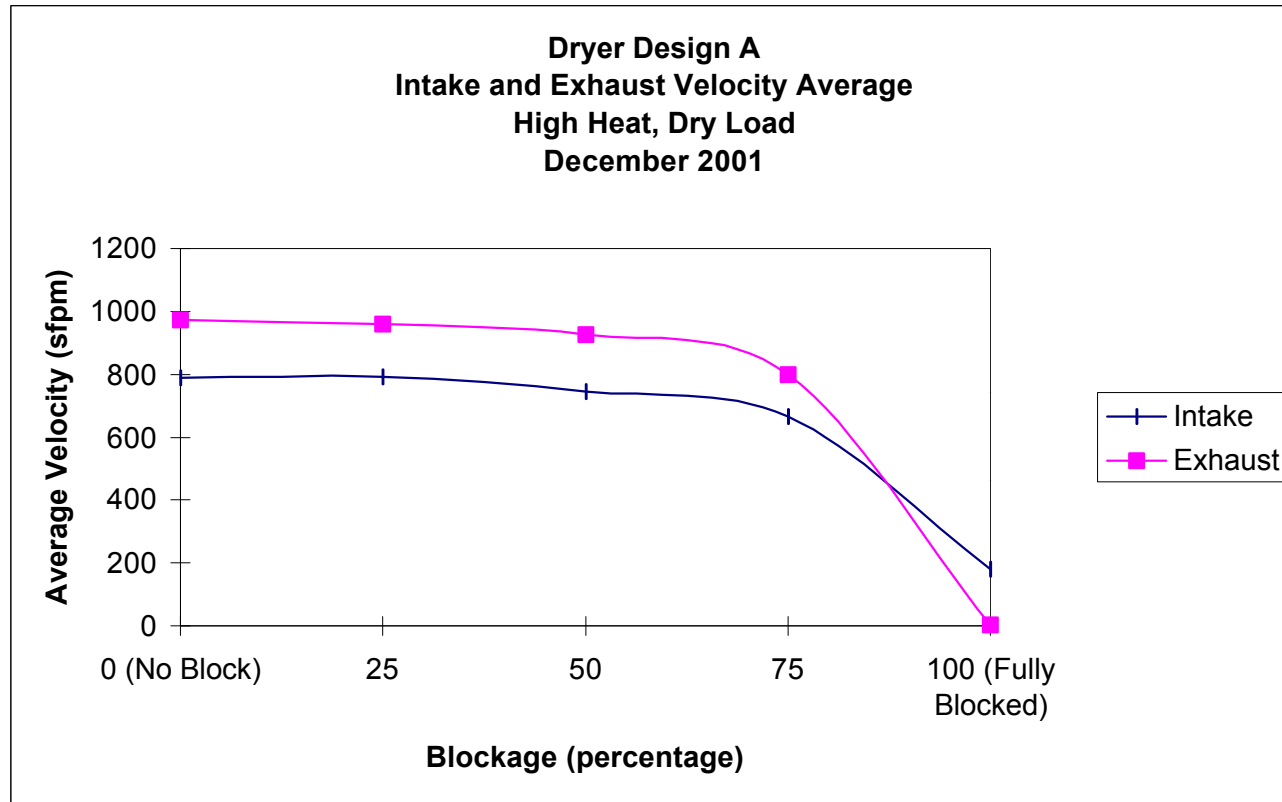

Figure 15. Dryer Design A – Average Airflow Velocities (High Heat and Dry Load)

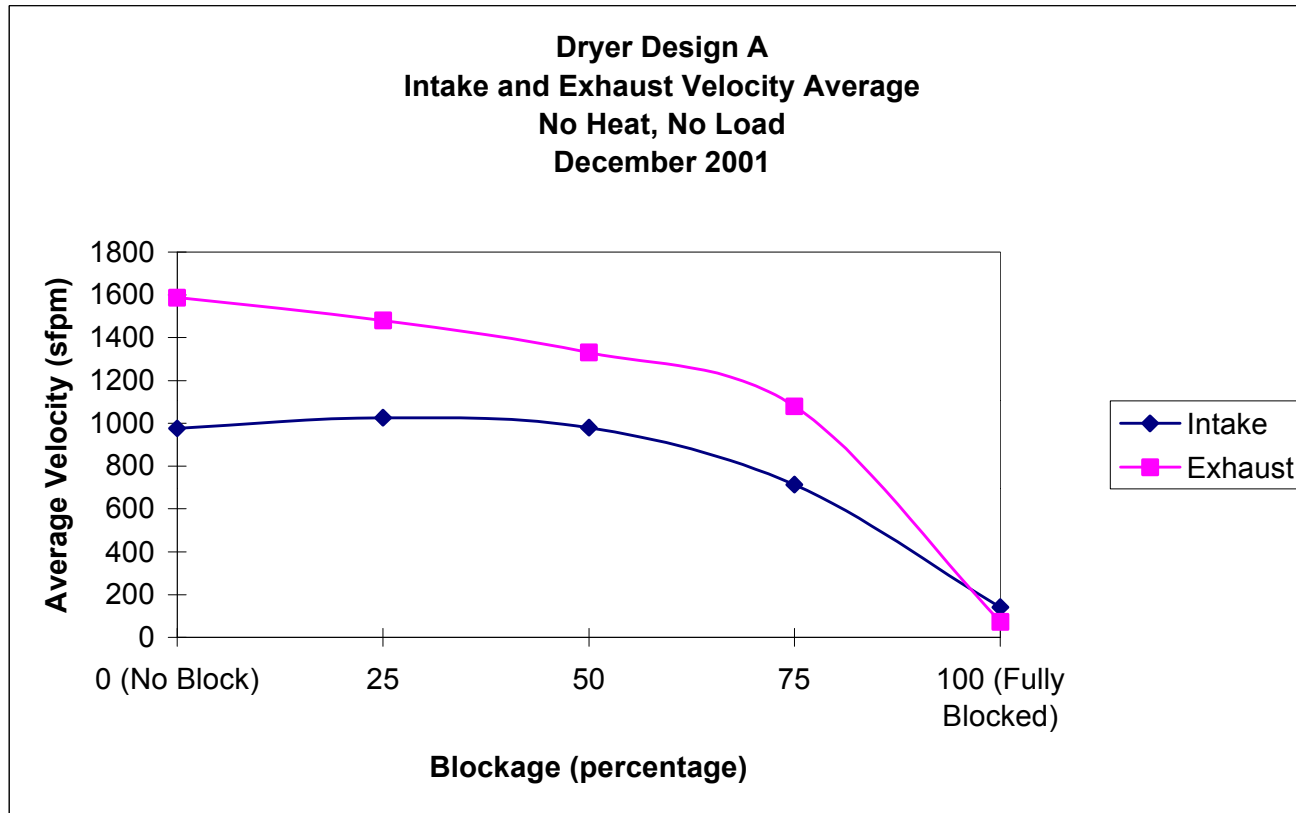

Figure 16. Dryer Design A – Average Airflow Velocities (No Heat and No Load)

#### *2.2.4.3 Dryer Design A – Primary Thermostat Bypassed*

The primary thermostat was bypassed to simulate a failure mode in which it failed closed. The thermostat was removed from the intake blower housing, and the hole it left was covered with foil tape. The thermostat was placed in a cool part of the dryer to prevent it from switching open. The dryer was operated with full airflow (no exhaust vent blockage) and a dry load.

Figure 17 shows the temperature and airflow data for Dryer Design A with a bypassed thermostat. The dryer was switched to Air Dry at approximately 1500 seconds into the test. The temperature at the heater intake appeared to level out at 95° C and would not have triggered the High-Limit Thermostat.

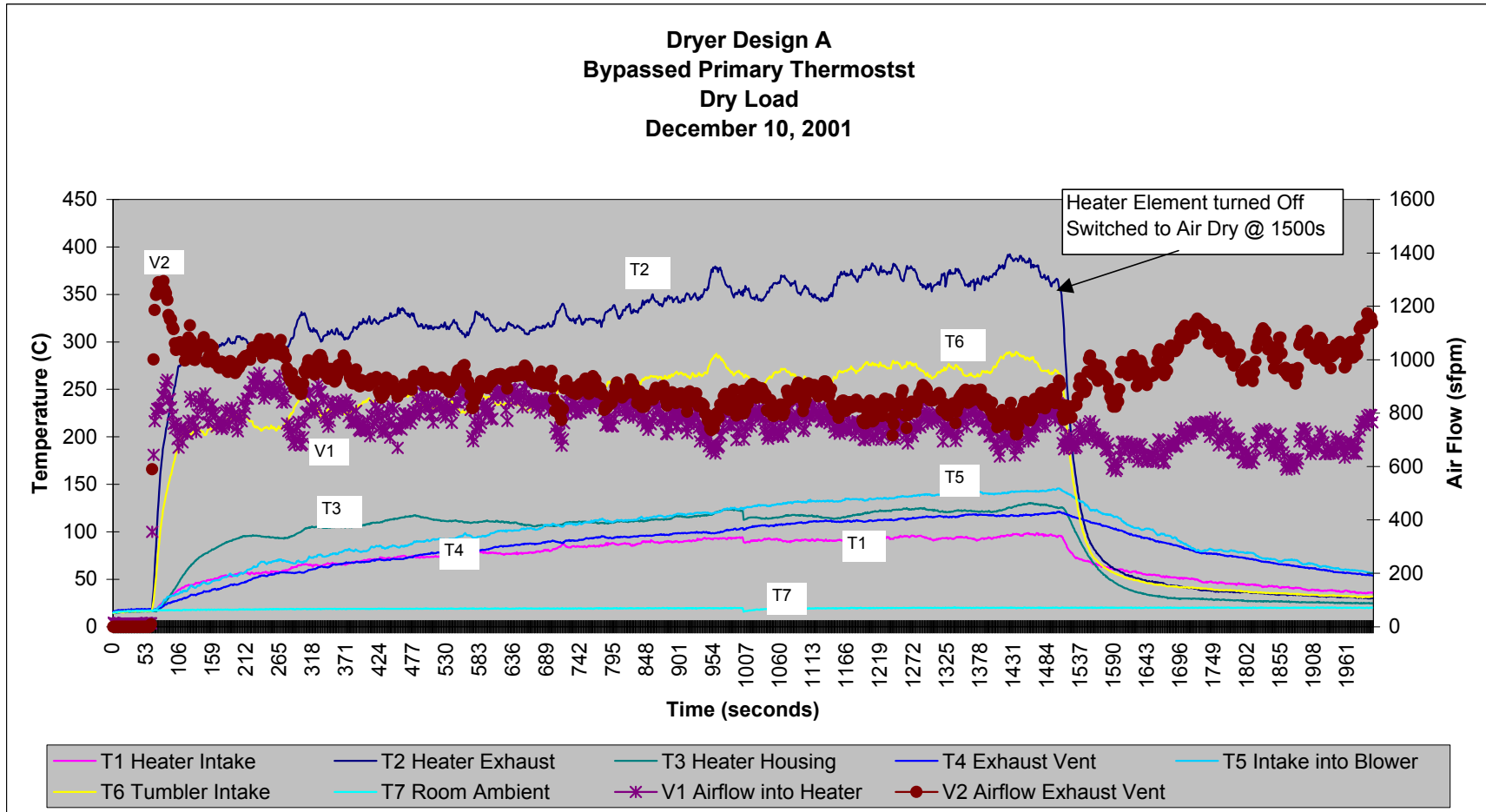

Figure 17. Dryer Design A – Primary Thermostat Bypassed

### 2.2.5 Dryer Design B

Dryer Design B was configured with the heating element at the rear bottom of the dryer and the lint screen at the front of the dryer. The heated air entered the rear of the tumbler, and the moist air exited through an opening at the top of the lint screen, as shown in Figure 18.

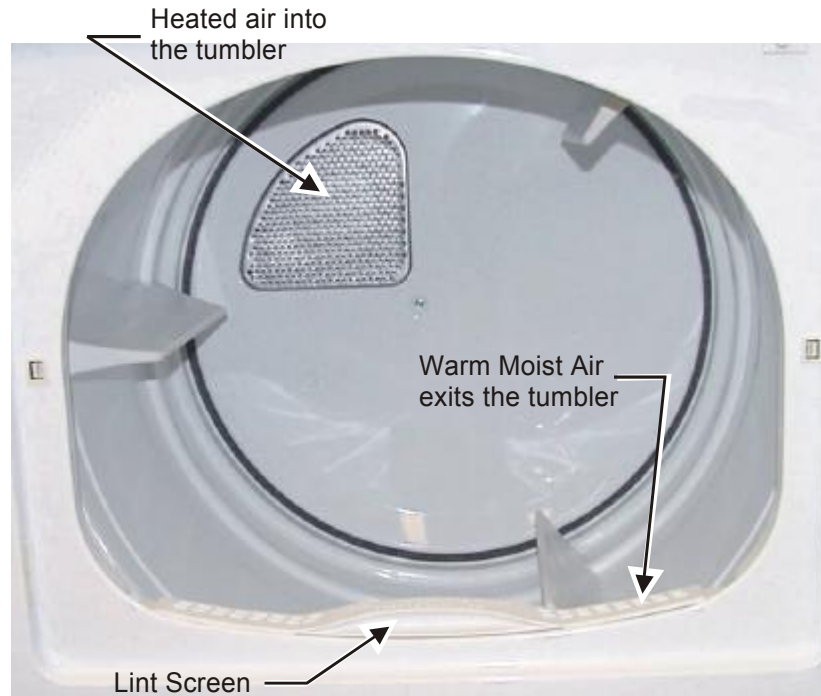

Figure 18. Dryer Design B – Air Flow Through the Tumbler

#### 2.2.5.1 *Dryer Design B – Temperature and Airflow Characteristics, Blocked and Unblocked*

The clothes dryer was tested at the high heat setting with no test load, with a dry load and with a wet load. Figure 19 (at the end of this section) shows a graph of the thermocouple and airflow measurement data for Dryer Design B with a wet load. (Graphs of data for similar tests with no load and with a dry load are contained in Appendix B.) As can be seen in the graph, the clothes dryer was started approximately 30 seconds after data collection began. The primary thermostat disconnected power to the heater approximately 3721 seconds into the test.

It can be observed that the exhaust vent (V2) airflow significantly decreased over time as the dryer was operating. This was caused by the lint screen becoming progressively blocked with lint. This graph shows a larger drop in exhaust airflow than previously observed for Dryer Design A. In Dryer Design A, the exhaust air velocity dropped from approximately 1300 to 950 sfpm, or a delta of 350 sfpm. In Dryer Design B, the exhaust air velocity dropped from approximately 1400 sfpm to 800 sfpm, or a delta of 600 sfpm.

Table 5 below lists the average, minimum, and maximum temperatures recorded during the main drying phase. The data listed in the table cover the period between 120 seconds after



the dryer was started to 120 seconds before the primary thermostat removed power from the heating element (to eliminate any unstabilized readings during energizing and de-energizing of the heating element).

Table 5. Dryer Design B Statistics (°C and sfpm)

Temp	Min	Average	Max	Flow	Min	Average	Max
T1	35	48	57	V1	307	375	483
T2	214	252	282	V2	796	1181	1432
T3	61	81	92				
T4	31	50	67				
T5	31	51	73				
T6	140	167	183				
T7	22	24	26				

The dryer was tested with a partially-blocked exhaust vent (25%, 50%, 75% blockage) and 100% blocked exhaust vent. For these tests, wet towels (washed and spun dry) were used, since there was enough variation in the temperature data between dry and wet loads. (Appendix B shows the comparison between the dry and wet towel loads with no blockage in the exhaust vent.)

Figures 20 to 22 (at the end of this section) show comparisons of temperature data for thermocouples T1, T3, and T5 for unblocked, partially-blocked, and fully-blocked vent conditions. (Appendix B contains graphs of the temperature data for the remaining thermocouples, T2, T4, T6, and T7.)

In Figure 20, it can be seen that the dryer began to operate on the high limit thermostat only when the exhaust duct was either 75% or 100% blocked. For the 25% and 50% blocked exhaust vent conditions, the temperatures measured were similar to those measured for the unblocked exhaust vent condition.

With a 75% and 100% blocked exhaust vent, the dryer operated on the high-limit thermostat. However, in the 75% blocked vent condition, the dryer operated at a higher temperature than that seen for the 100% blocked condition. Figure 21 shows the heater box reached up to 150°C for the 75% blocked condition whereas, for the 100% blocked condition, the high-limit thermostat periodically switched the temperature at approximately 125°C.

The period at which the high-limit thermostat switched on and off also differed for the 75% and 100% blocked exhaust vent conditions. This was most likely caused by the difference in airflow for the two conditions. With the 75% blockage, the additional airflow resulted in an increase in the time required for the high-limit thermostat to reach its set point for opening. In addition, the periodic rate at which the thermostat switched on and off changed during the course of the test; the high limit thermostat began switching at a faster rate around 2850 seconds. This was most likely caused by the lint screen becoming progressively blocked, which further reduced airflow through the dryer.

Figure 20 also shows that the temperatures measured for the unblocked, 25% blocked and 50% blocked exhaust vent conditions are similar – both in value and signature – until 2331

seconds. The graph for the 50% blocked condition shows the heating element began switching rapidly on the primary thermostat, which is explained in the next paragraph.

Figure 21 shows that the temperature at which the operating thermostat switches on and off is nearly equal for the unblocked, 25% blocked and the 50% blocked conditions. The rapid switching of the primary thermostat was caused by the load no longer tumbling, although the drum was still rotating. (More on this phenomenon is discussed under Dryer Design D.) This effect was more evident for the 50% blocked exhaust condition, as shown in Figure 22.

US CONSUMER PRODUCT SAFETY COMMISSION  
 FINAL REPORT ON ELECTRIC CLOTHES DRYERS AND LINT IGNITION CHARACTERISTICS  
 May 2003

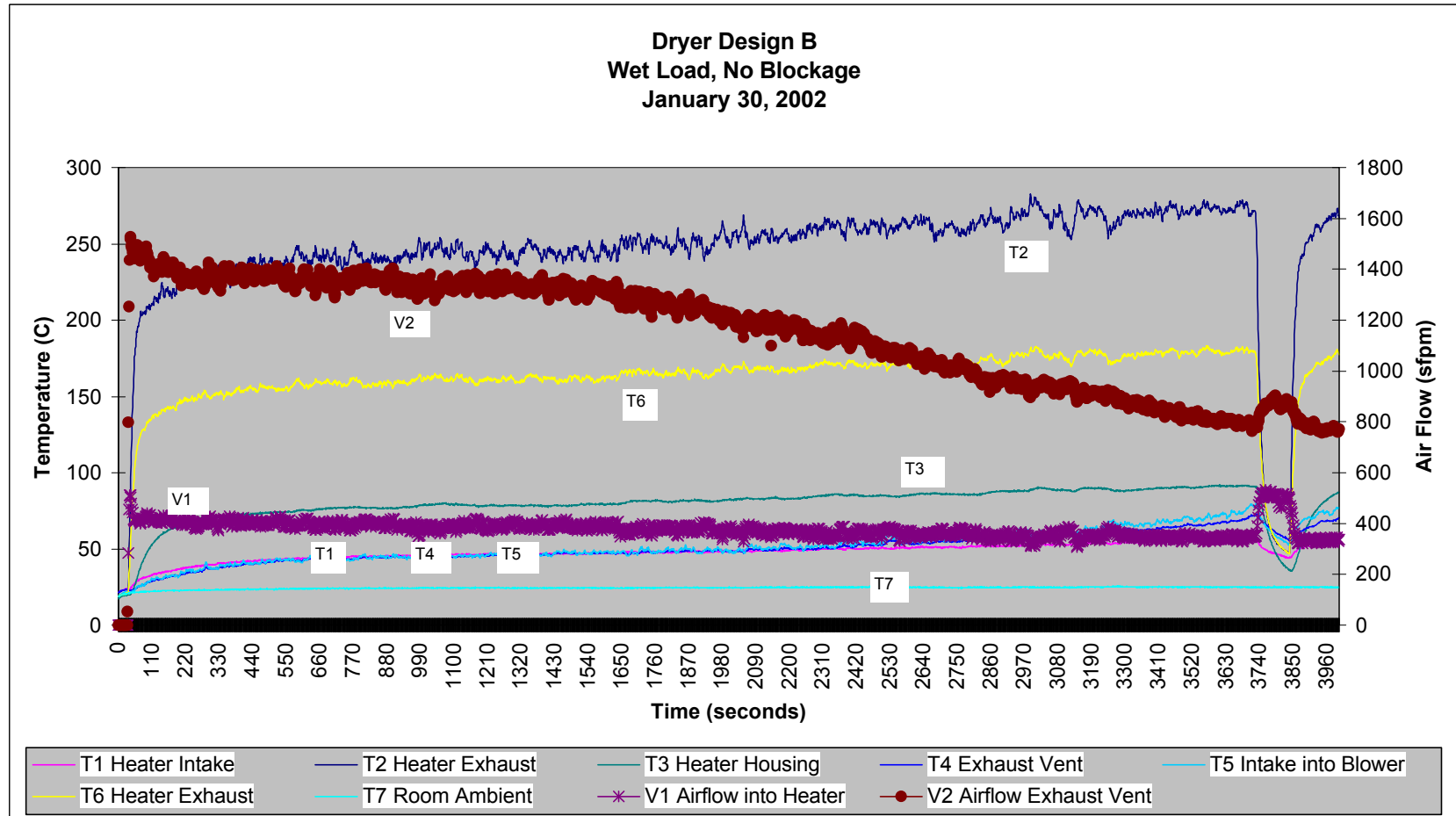

Figure 19. Dryer Design B – Thermocouple and Airflow Measurements (Wet Load)

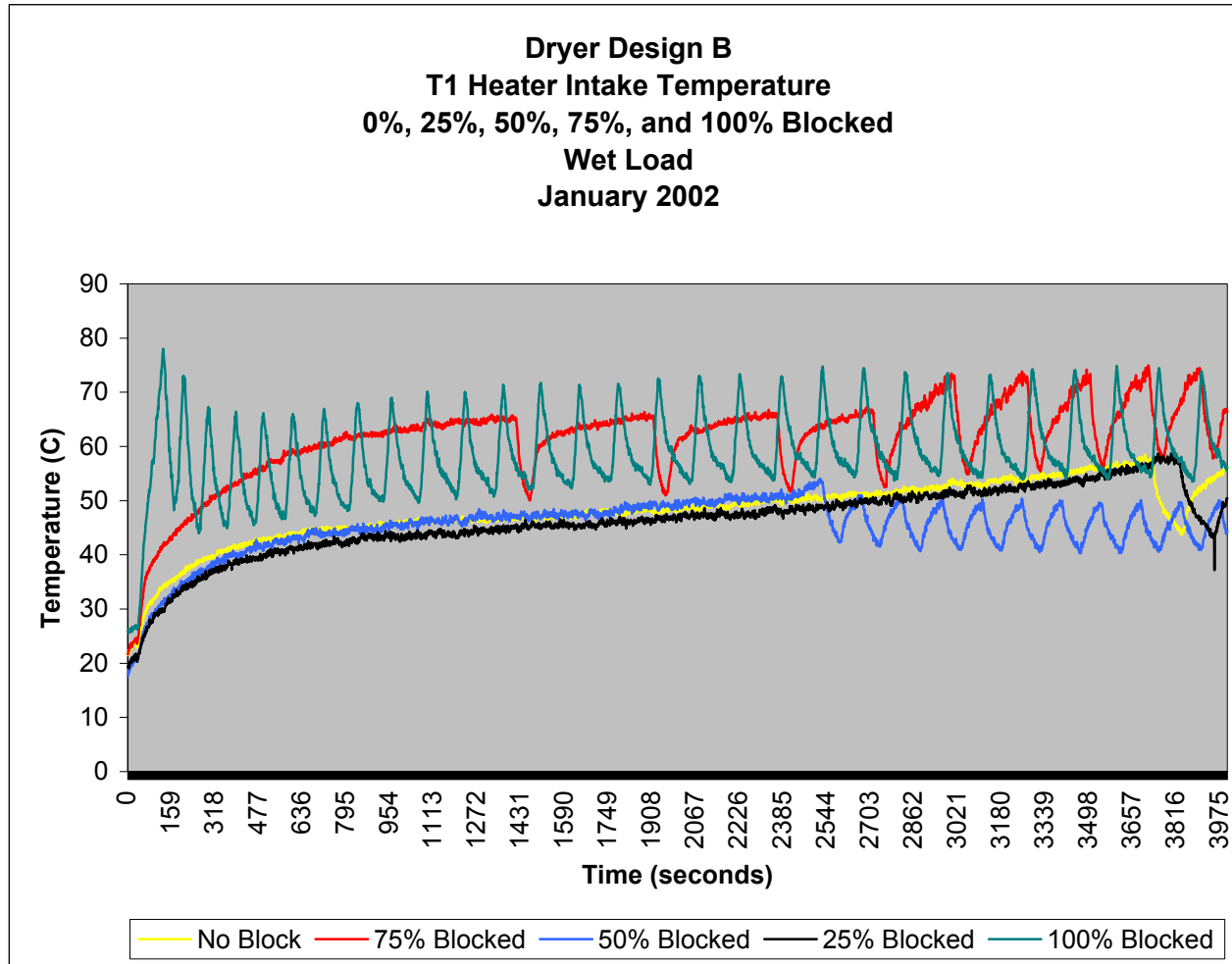

Figure 20. Dryer Design B – T1 Heater Intake Comparison

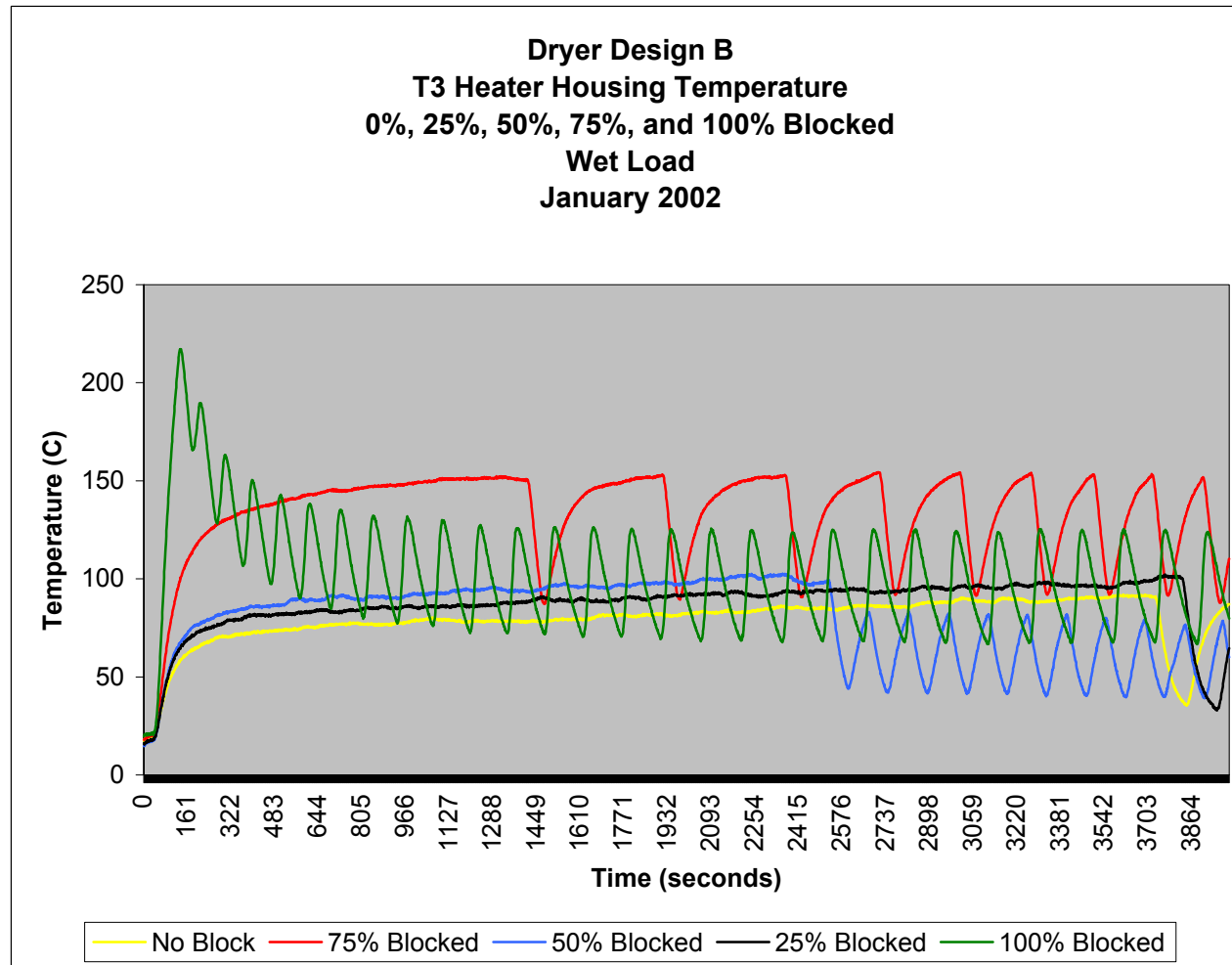

Figure 21. Dryer Design B – T3 Heater Housing Comparison

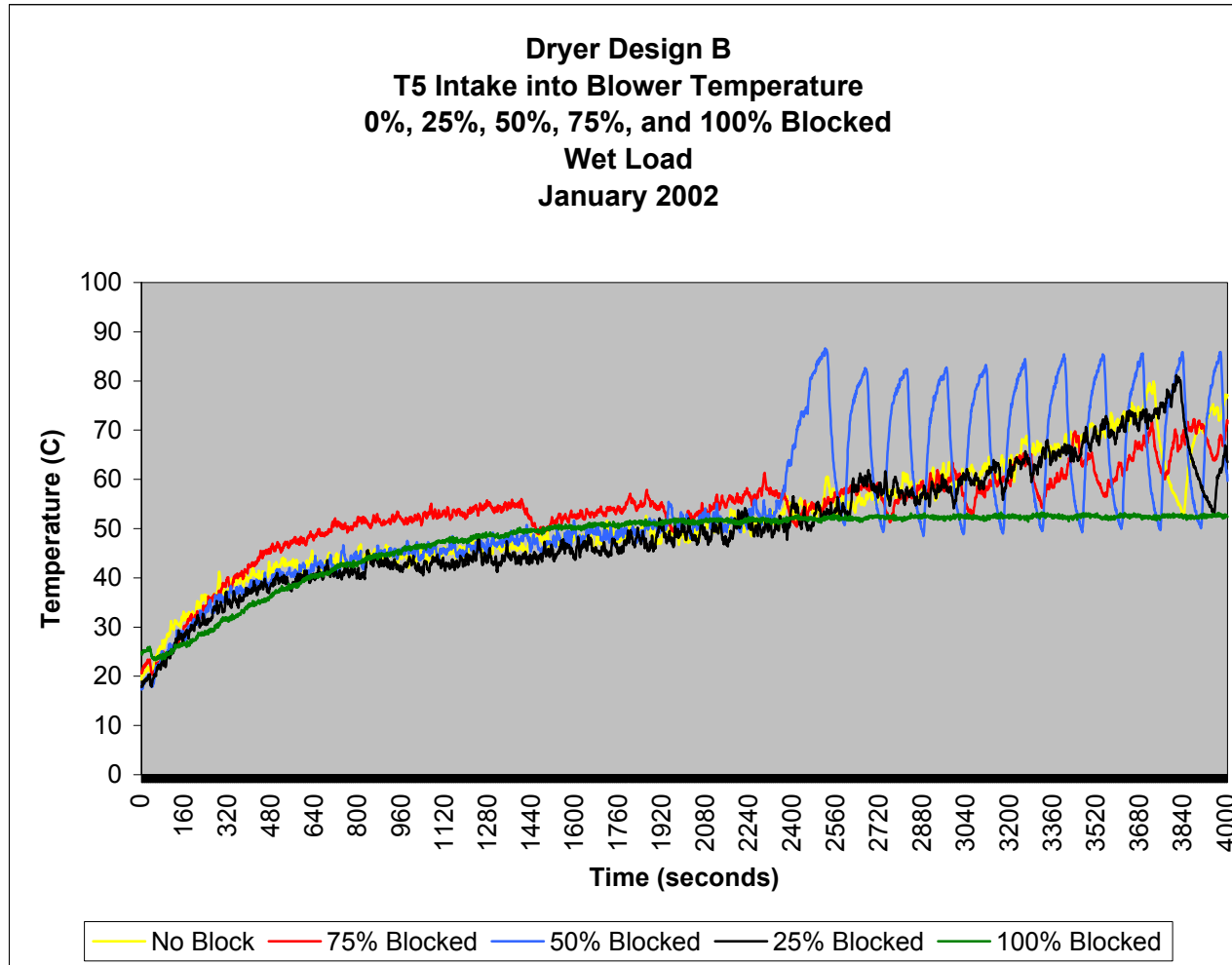

Figure 22. Dryer Design B – T5 Intake into the Blower Comparison

### 2.2.5.2 Dryer Design B – Airflow

The airflow was measured using hot wire anemometers placed at the air intake into the heater box and in the exhaust vent. Both anemometers were placed in the center of the cross-section of the air streams. The anemometer placed in the exhaust vent was positioned 36" after the first elbow to avoid circular turbulence effects from the dryer blower. As mentioned earlier, the iris and blast plate for the partially and 100% blocked conditions, respectively, were placed before the hot wire anemometer.

Figure 23 shows the intake air velocity comparisons for the unblocked, partially blocked, and fully blocked exhaust vent conditions. The intake air velocities were similar for the unblocked, 25% and 50% blocked conditions. There was a slight drop in the velocity for the 75% blocked condition that was significant enough to cause the dryer to operate in the high-limit cycling mode, as seen in the thermocouple data (shown previously in Figure 21). When the exhaust vent was 100% blocked, the intake air velocity fluctuated between near zero to about 200 sfpm. The fluctuation to 200 sfpm coincided with the heating element being de-energized by the high-limit thermostat. This was caused by the anemometer not responding fast enough to the change in temperature at the heater intake.

Figure 24 shows the exhaust air velocity comparisons for the unblocked, partially blocked, and fully blocked exhaust vent conditions. The graph shows a slight overshoot at initial startup of the dryer, but it was not as prominent as that seen in Dryer Design A. The size of the overshoot decreased as the blockage increased, as expected, since the second anemometer, in the exhaust vent, was located after the iris.

Figure 25 shows the average intake and exhaust air velocities for the different blockage conditions. The data from 120 seconds to 1000 seconds were averaged. This avoided the initial overshoot when the blower was first powered. The intake velocity stayed steady until the exhaust vent was 25% blocked, and it began to decrease more rapidly between 25% and 50% blockage. When the exhaust vent was 100% blocked, the exhaust velocity was near zero, as expected, and the average intake air velocity was 90 sfpm.

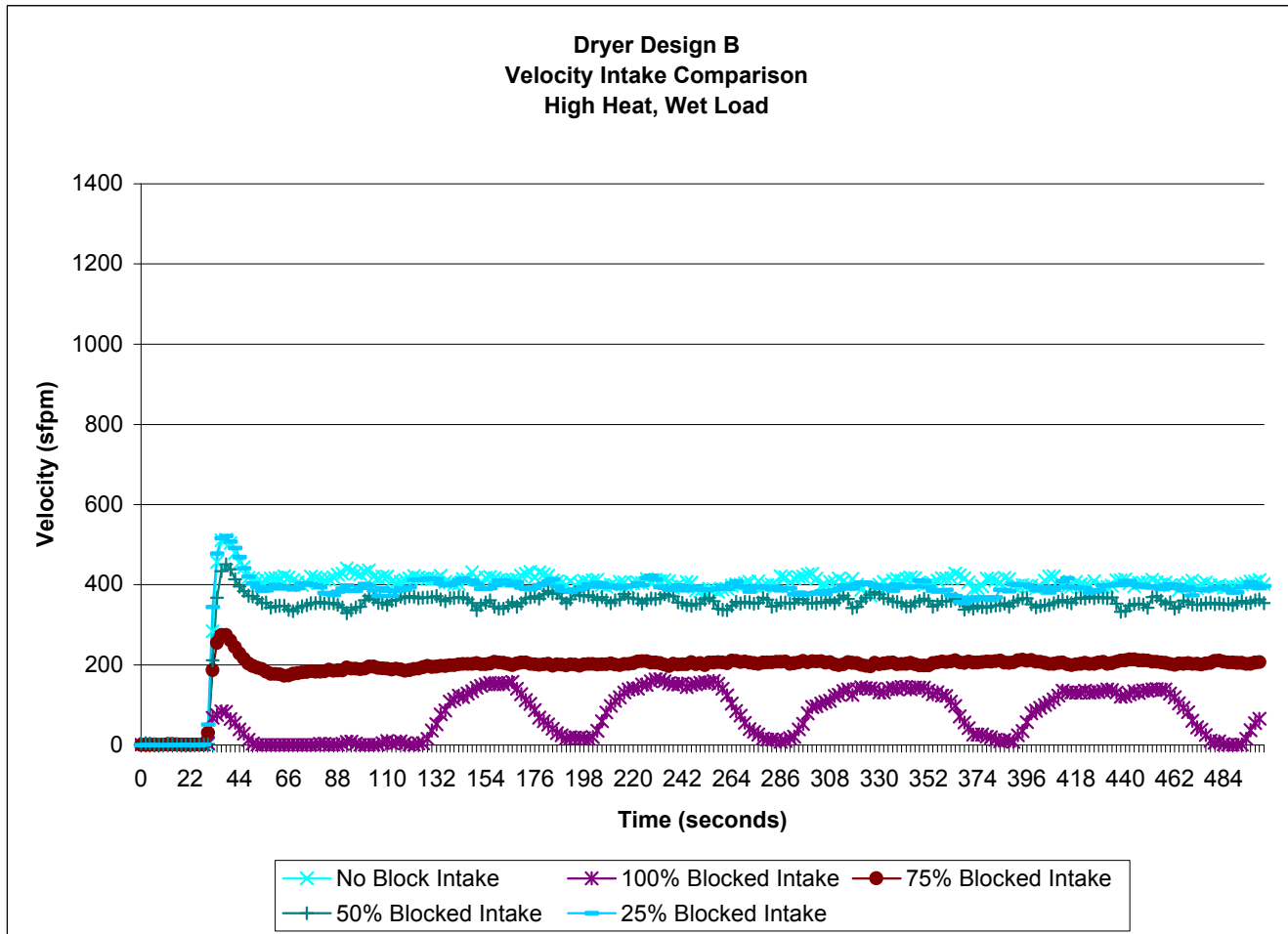

Figure 23. Dryer Design B – Intake Air Velocity



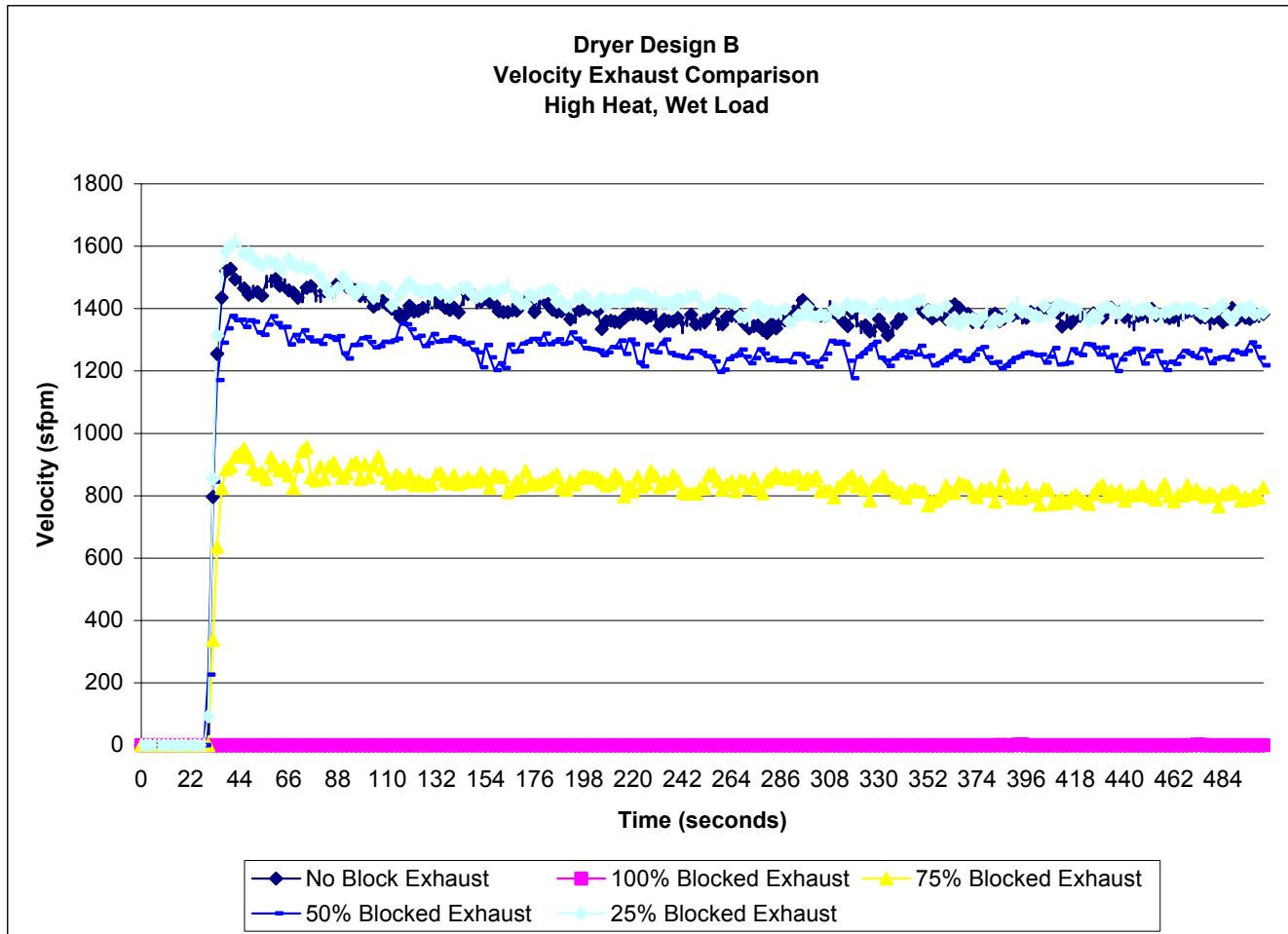

Figure 24. Dryer Design B – Exhaust Vent Air Velocity

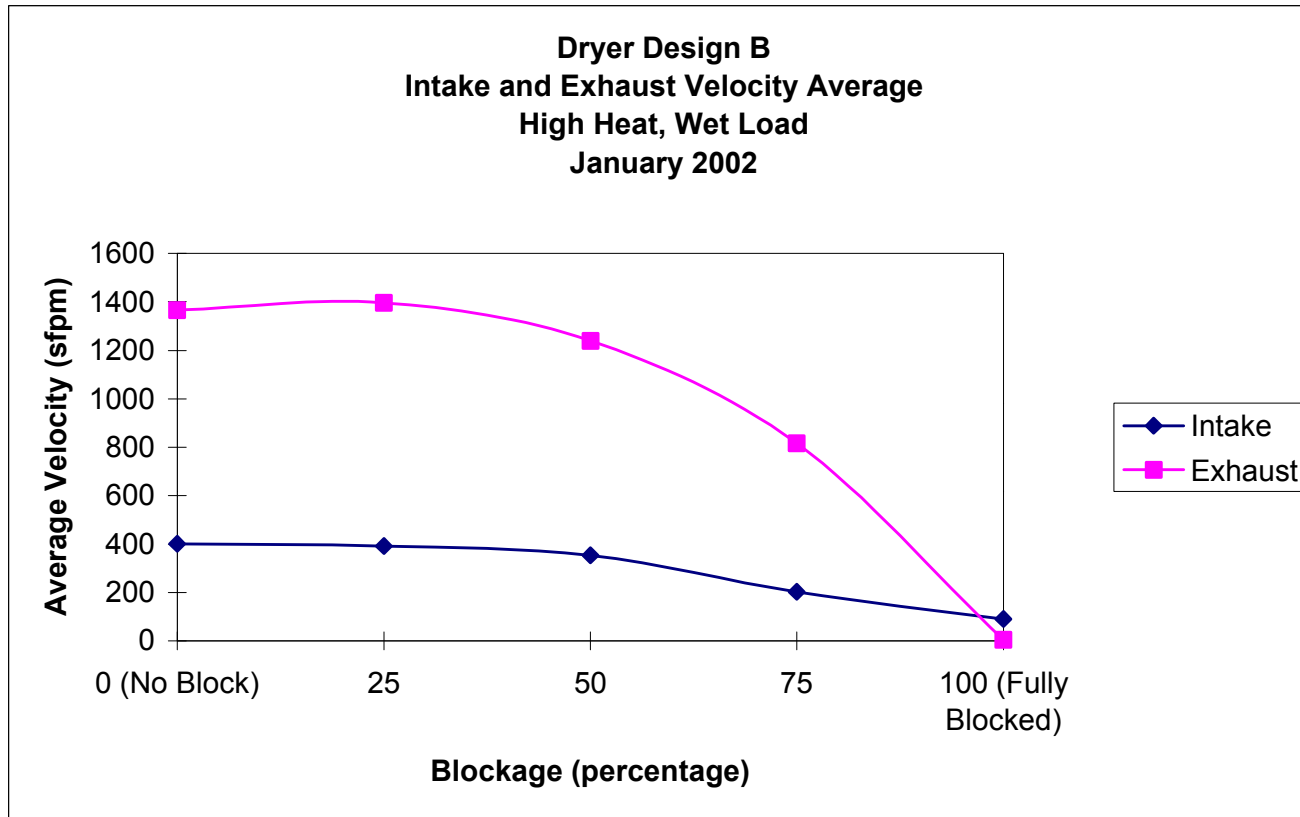

Figure 25. Dryer Design B – Average Airflow Velocities (High Heat and Wet Load)

### *2.2.5.3 Dryer Design B – Primary Thermostat Bypassed*

The primary thermostat was bypassed to simulate a failure mode in which it had failed closed. The thermostat was removed from the intake blower housing, and the hole it left was covered with foil tape. The thermostat was placed in a cool part of the dryer to prevent it from switching open. The dryer was operated with full airflow and with a wet load.

Figure 26 shows the thermocouple and airflow measurement data for Dryer Design B when the thermostat was bypassed. The dryer's Timed Dry feature shut off at approximately 4000 seconds. The dryer was restarted for an additional 30 minutes with the Timed Dry feature. The temperature at the heater box intake appeared to level out at approximately 65° C and would not have triggered the High-Limit Thermostat.

US CONSUMER PRODUCT SAFETY COMMISSION  
 FINAL REPORT ON ELECTRIC CLOTHES DRYERS AND LINT IGNITION CHARACTERISTICS  
 May 2003

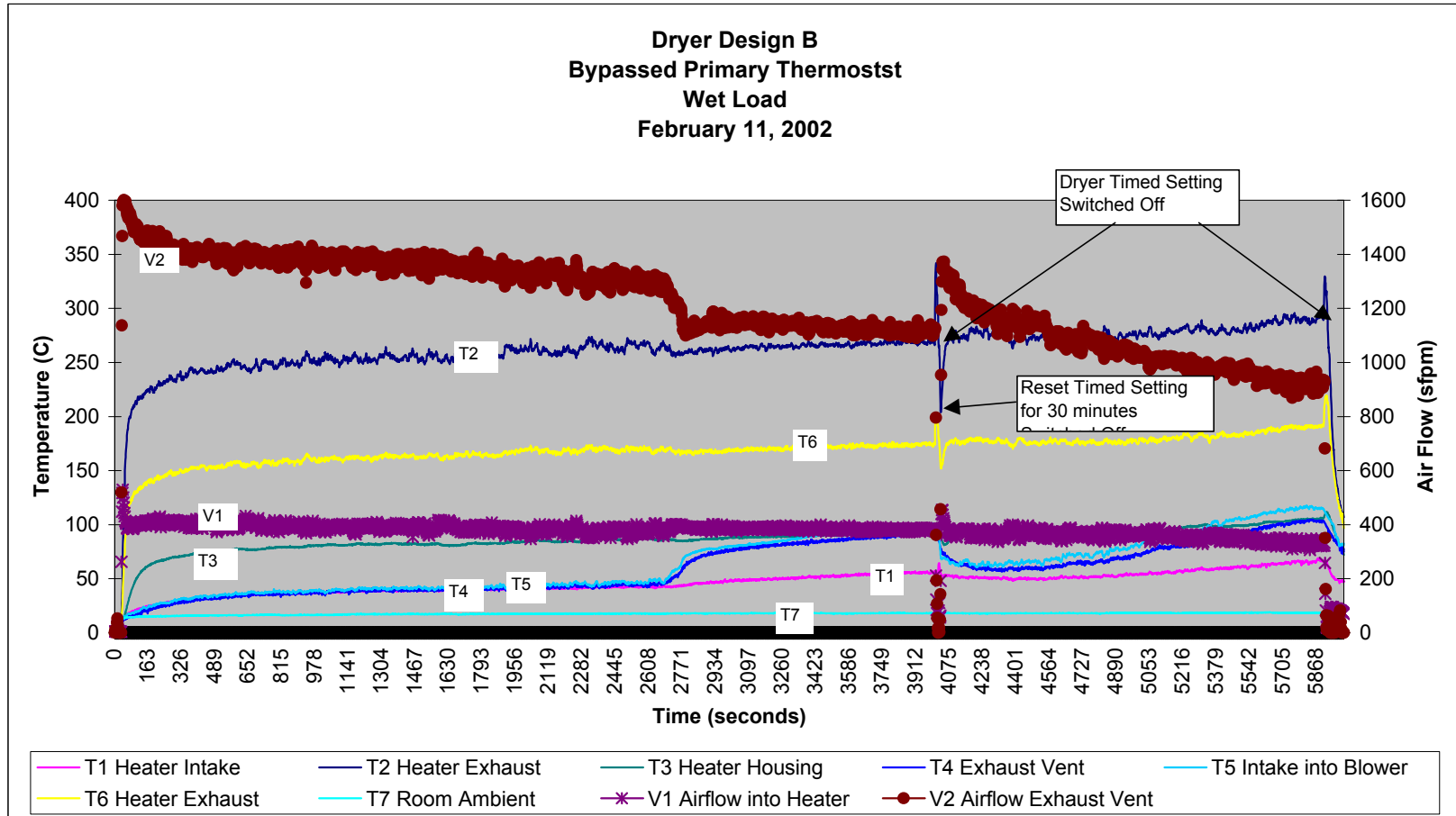

Figure 26. Dryer Design B – Primary Thermostat Bypassed

### 2.2.6 Dryer Design C

Dryer Design C was configured with the heating element at the rear-top of the dryer and the lint screen at the front of the dryer. The heated air entered the rear of the tumbler, and the moist air exited through openings inside the front cover that led to the lint screen, as shown in Figure 27.

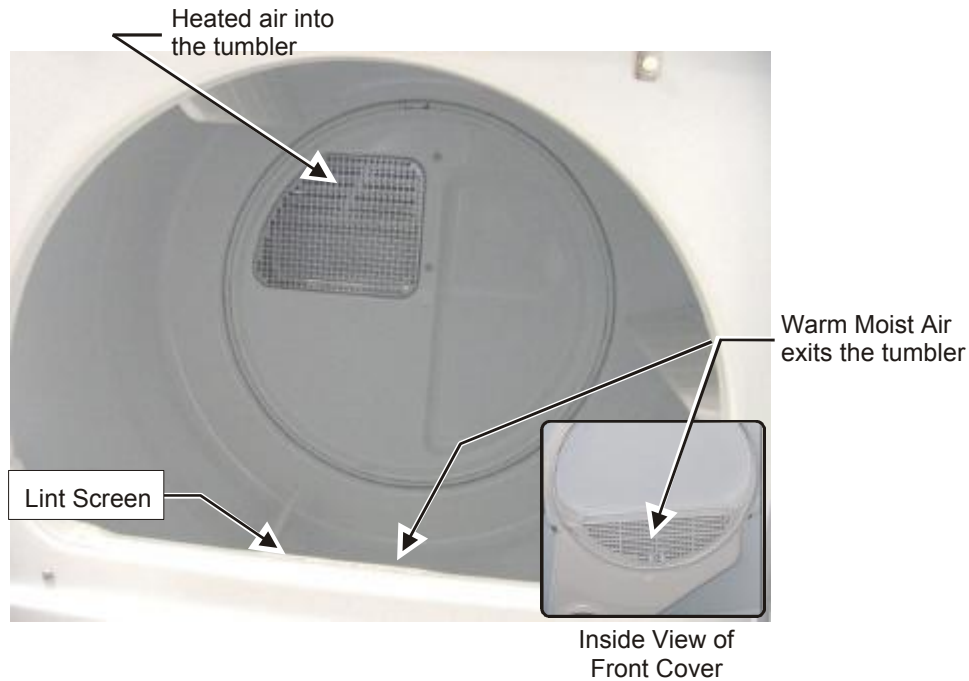

Figure 27. Dryer Design C – Airflow through the Tumbler

#### 2.2.6.1 *Dryer Design C – Temperature and Airflow Characteristics, Blocked and Unblocked*

The dryer was tested at the high heat setting with no load, with a dry load and with a wet load. Figure 28 shows the thermocouple and airflow measurement data for Dryer Design C with a wet load. (Graphs of data obtained for the tests with no load and with a dry load are contained in Appendix C.) The dryer was started approximately 60 seconds after data collection began. The primary thermostat disconnected power to the heating element at approximately 3664 seconds into the test.

This graph shows a significant decrease in the exhaust air velocity as the dryer continued to operate. As seen in Dryer Designs A and B, this was caused by the lint screen becoming progressively blocked with lint. In Dryer Design C, the exhaust air velocity dropped from approximately 1400 sfpm to 700 sfpm, a delta of 700 sfpm.

Table 6 below lists the average, minimum, and maximum temperatures recorded during the main drying phase. The data listed in the table cover the period from 120 seconds after the dryer was started to 120 seconds before the primary thermostat removed power from the

heating element (to eliminate any instability in the readings from energizing and de-energizing the heating element).

Table 6. Dryer Design C – Statistics (°C and sfpm)

Temp	Min	Average	Max	Flow	Min	Average	Max
T1	36	54	72	V1	111	197	296
T2	106	140	177	V2	654	1023	1450
T3	34	50	67				
T4	31	48	61				
T5	31	48	63				
T6	146	185	228				
T7	20	21	22				

The dryer was tested with a partially-blocked exhaust vent (25%, 50% and 75% blockage) and a 100% blocked exhaust vent. For these tests, wet towels (washed and spun dry) were used. (A comparison of temperature and airflow data obtained for the dry and wet towel loads with no blockage in the exhaust vent are contained in Appendix C.)

Figures 29 through 31 (at the end of this section) show a comparison of the temperature measurement data for thermocouples T1, T2, and T5 for unblocked, partially-blocked, and fully-blocked vent conditions. (Appendix C contains graphs of the temperature measurement data for unblocked, partially-blocked, and fully-blocked vent conditions for the remaining thermocouples, T3, T4, T6, and T7.)

Figure 29 shows that the dryer operated on the high-limit thermostat only when the exhaust duct was 75% or 100% blocked. For the 25% and 50% blocked exhaust vent conditions, the temperatures measured were similar to those measured when the exhaust vent was unblocked.

Figure 29 also shows that, with 75% and 100% exhaust vent blockages, there appeared to be a difference in the temperature at which the high-limit thermostat operated. At 75% blockage, upper high-limit switching occurred around 195°C; however, for a 100% blocked exhaust vent, upper high limit switching appeared to have occurred at 225°C. This discrepancy in the data was caused by the location of the T1 thermocouple and the orientation of the heater box. As mentioned previously, Dryer Design C drew intake air into the heater box from the top and directed it downward toward – and eventually into – the tumbler. When the exhaust vent was 75% blocked, there was slight airflow over the heating element to direct some heat away from the T1 thermocouple and the high-limit thermostat. With 100% blockage, convective heat caused the T1 thermocouple to read a higher value – a higher temperature than was actually present at the high-limit thermostat when it opened.

Figure 30 shows that when the exhaust vent was either partially or fully blocked, the heater housing temperature was only slightly above the maximum temperature for the unblocked vent condition. The operation of the high-limit thermostat prevented the heater box temperature from increasing much higher than 80°C.

Figure 31 shows the air temperature at the intake to the blower reached around 50°C in the unblocked and partially-blocked conditions, until around 2100 seconds. For the unblocked, 25% and 50% blocked conditions, the temperature continued to increase to over 60°C. With the exhaust vent 75% blocked, switching of the high-limit thermostat prevented the temperature of the air entering the blower from increasing to the set point at which the primary thermostat would open.

US CONSUMER PRODUCT SAFETY COMMISSION  
 FINAL REPORT ON ELECTRIC CLOTHES DRYERS AND LINT IGNITION CHARACTERISTICS  
 May 2003

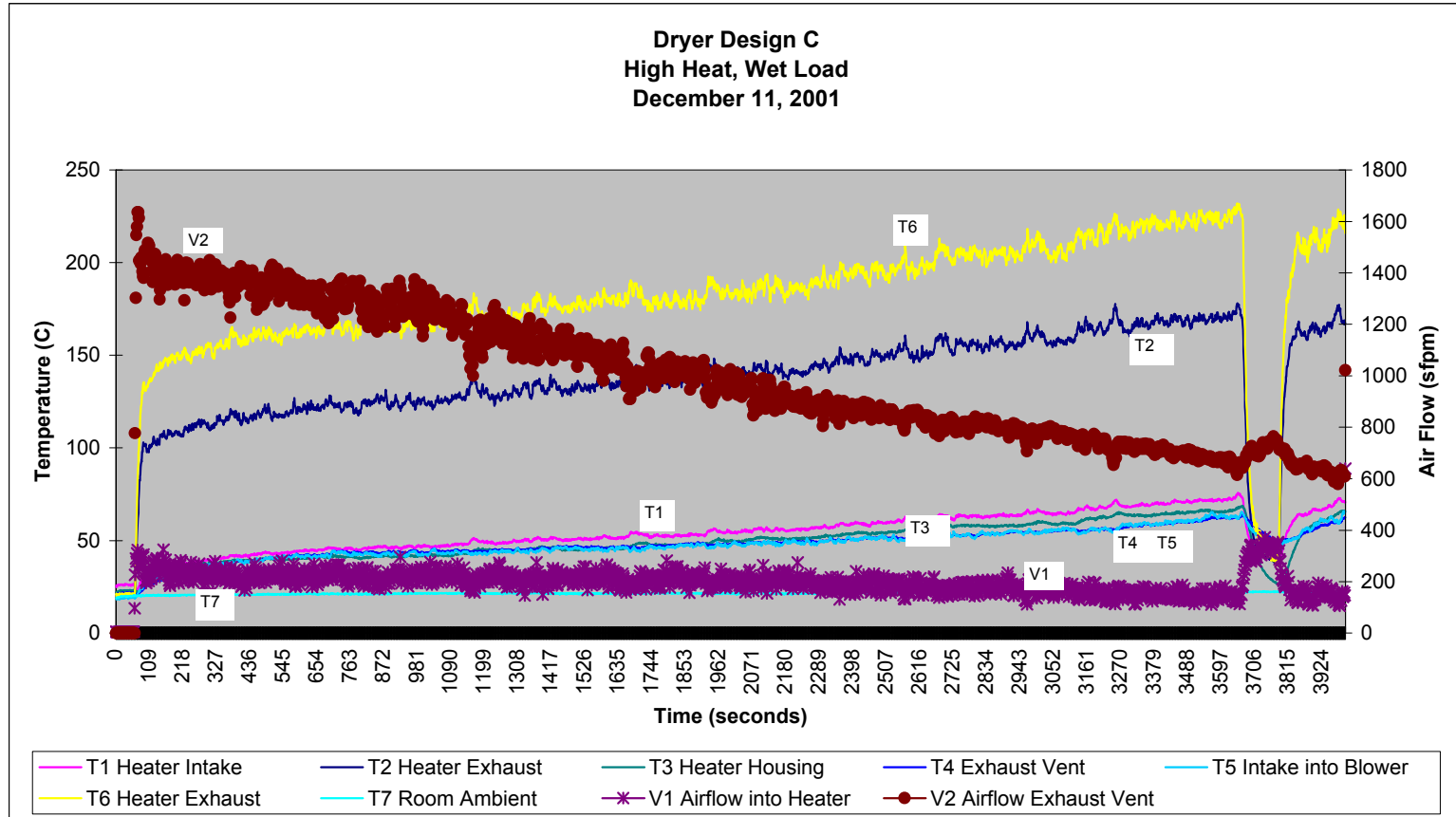

Figure 28. Dryer Design C – Thermocouple and Airflow Measurements (Wet Load)



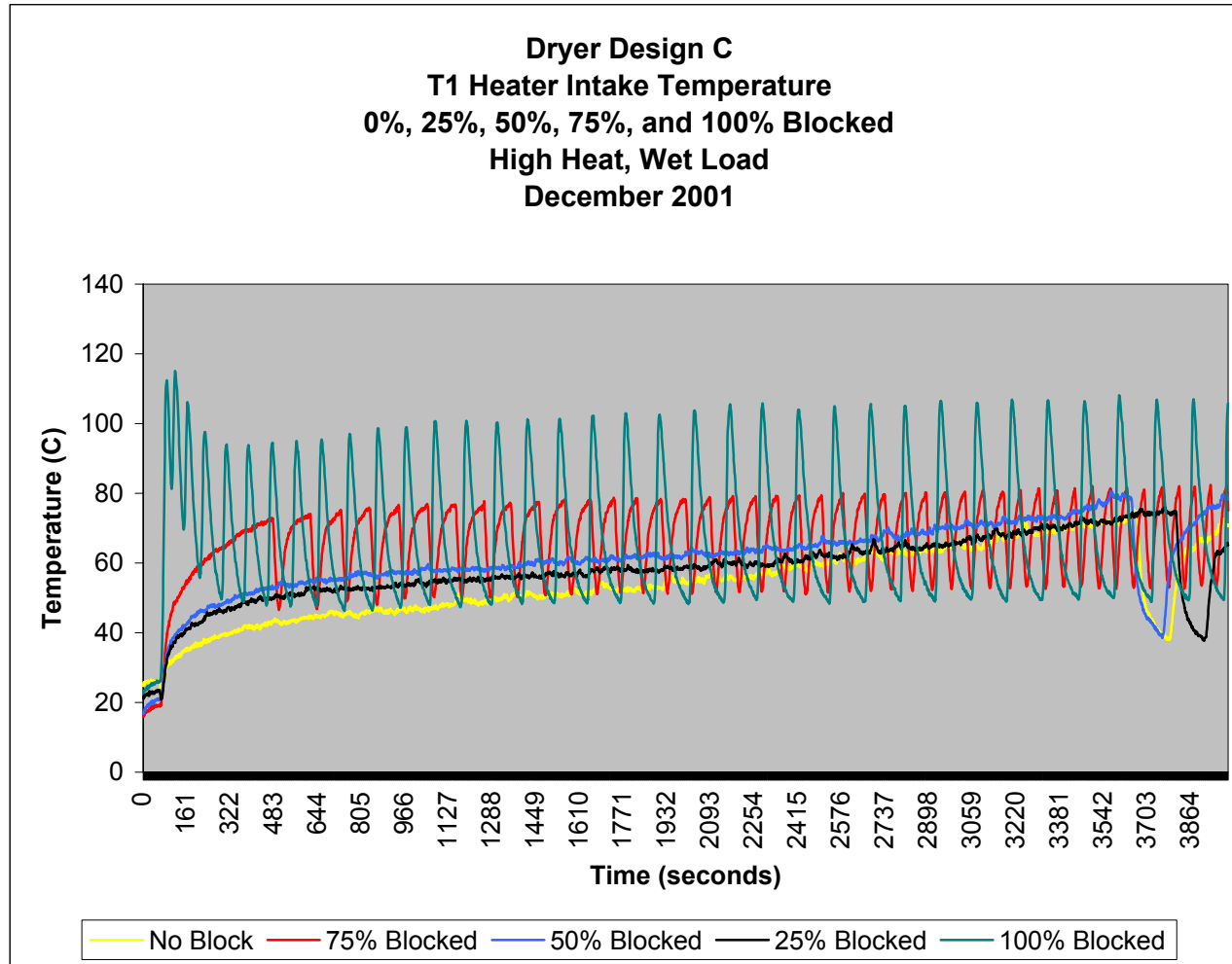

Figure 29. Dryer Design C – T1 Heater Intake Comparison

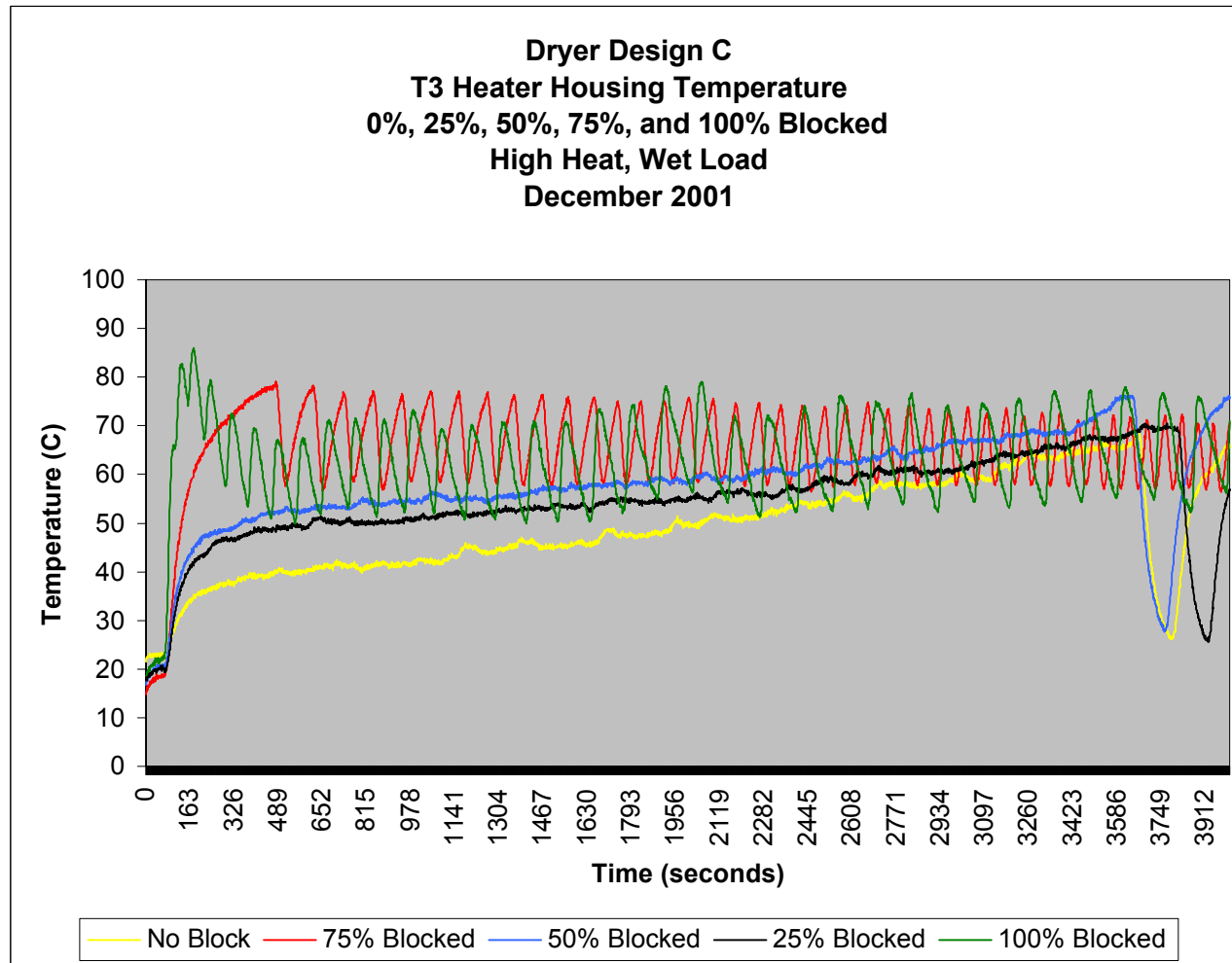

Figure 30. Dryer Design C – T3 Heater Housing Comparison

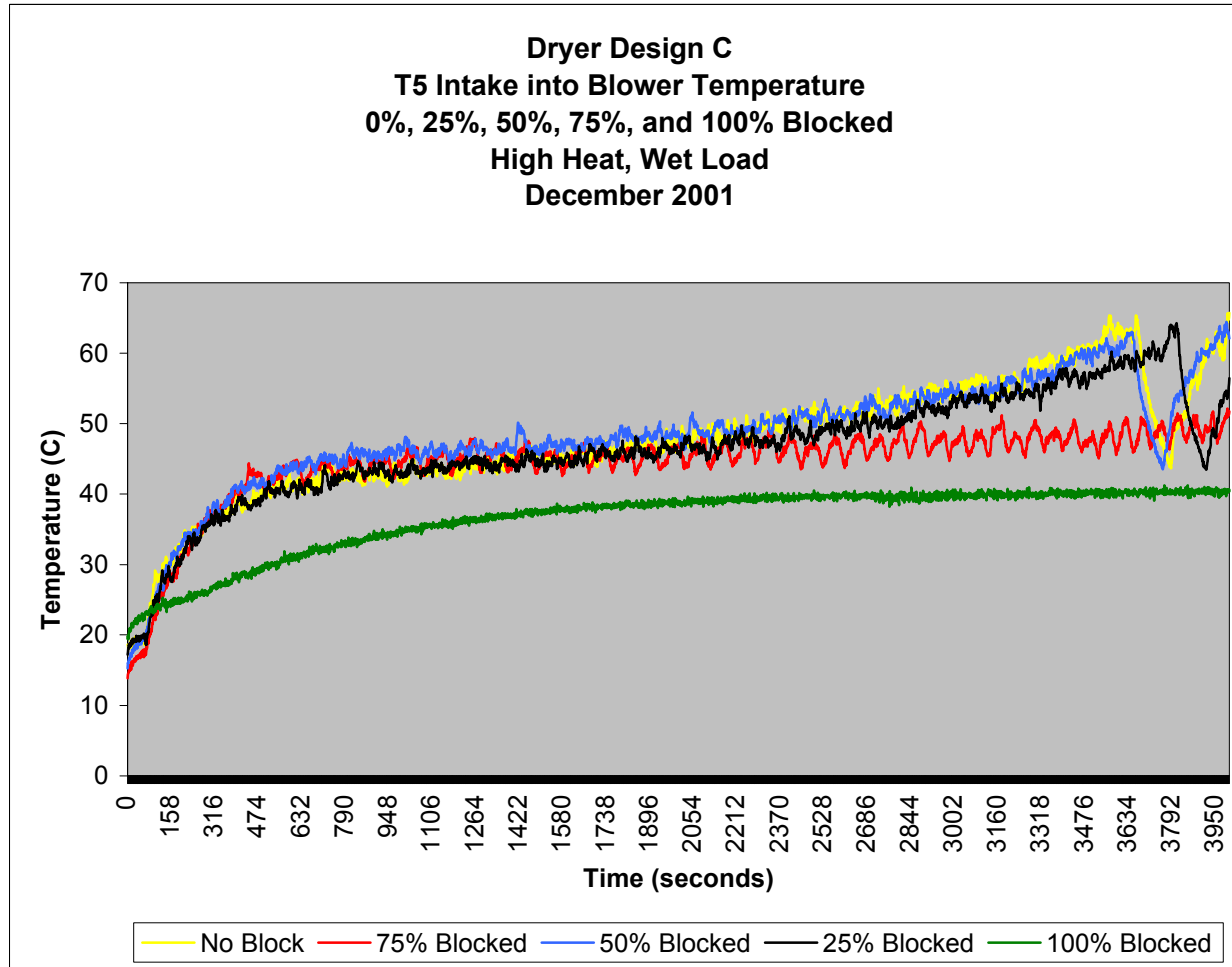

Figure 31. Dryer Design C – T5 Intake into the Blower Comparison

### 2.2.6.2 Dryer Design C – Airflow

The airflow was measured using hot wire anemometers placed at the intake airflow into the heater box and in the exhaust vent. Both anemometers were placed in the center of the cross-section of the air streams. The anemometer placed in the exhaust vent was positioned 36” after the first elbow to avoid circular turbulence effects from the dryer blower. As mentioned earlier, the iris and blast plate for the partially- and fully-blocked conditions, respectively, were placed before the hot wire anemometer located in the exhaust vent.

Figure 32 shows the intake air velocity comparisons for unblocked, partially-blocked, and fully-blocked exhaust vent conditions. The intake air velocity appeared to have very low readings; this was caused by the presence of side louvers in the heater box. The anemometer did not measure the air intake from the side louvers. As seen previously when the exhaust vent was 100% blocked, the intake air velocity fluctuated between near zero to about 200 sfpm. The fluctuation to 200 sfpm coincided with the heating element being de-energized by the high-limit thermostat. This was caused by the anemometer not responding fast enough to the temperature change when the heater was de-energized.

Figure 33 shows the exhaust air velocity comparisons for unblocked, partially-blocked, and fully-blocked exhaust vent conditions. The graph shows a slight overshoot at initial startup of the dryer, but it is not as prominent as that seen for Dryer Design A. The size of the overshoot decreased as the blockage increased, as expected, since the second anemometer was located after the exhaust vent blockage. The exhaust air velocity decreased when the exhaust vent was 25% and 50% blocked, and it decreased further when the exhaust vent was 75% blocked.

Figure 34 shows the average intake and exhaust air velocities for the different blockage conditions. The data from 120 seconds to 1000 seconds were averaged. This avoided the initial overshoot when the blower was first powered.

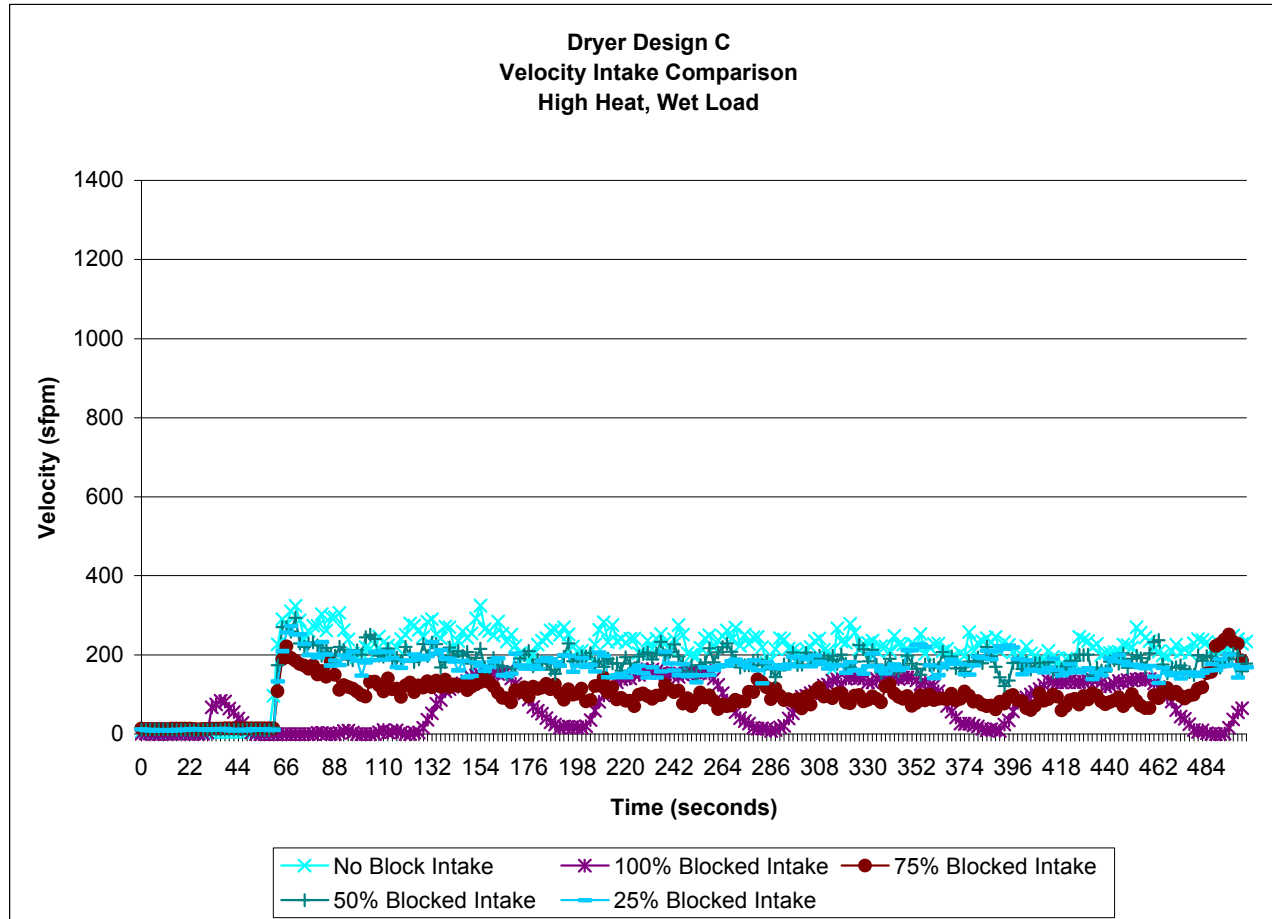

Figure 32. Dryer Design C – Intake Air Velocity

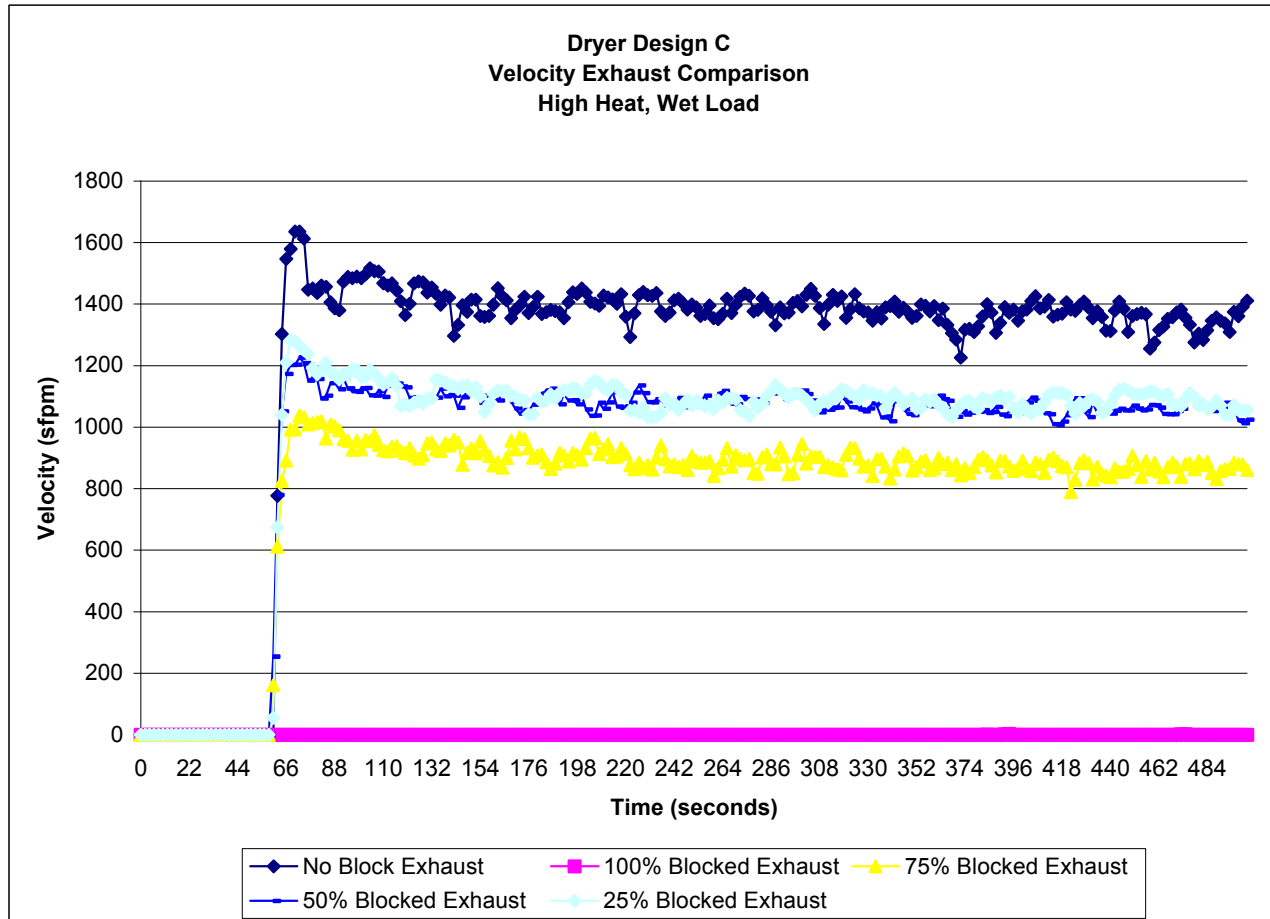

Figure 33. Dryer Design C – Exhaust Vent Air Velocity

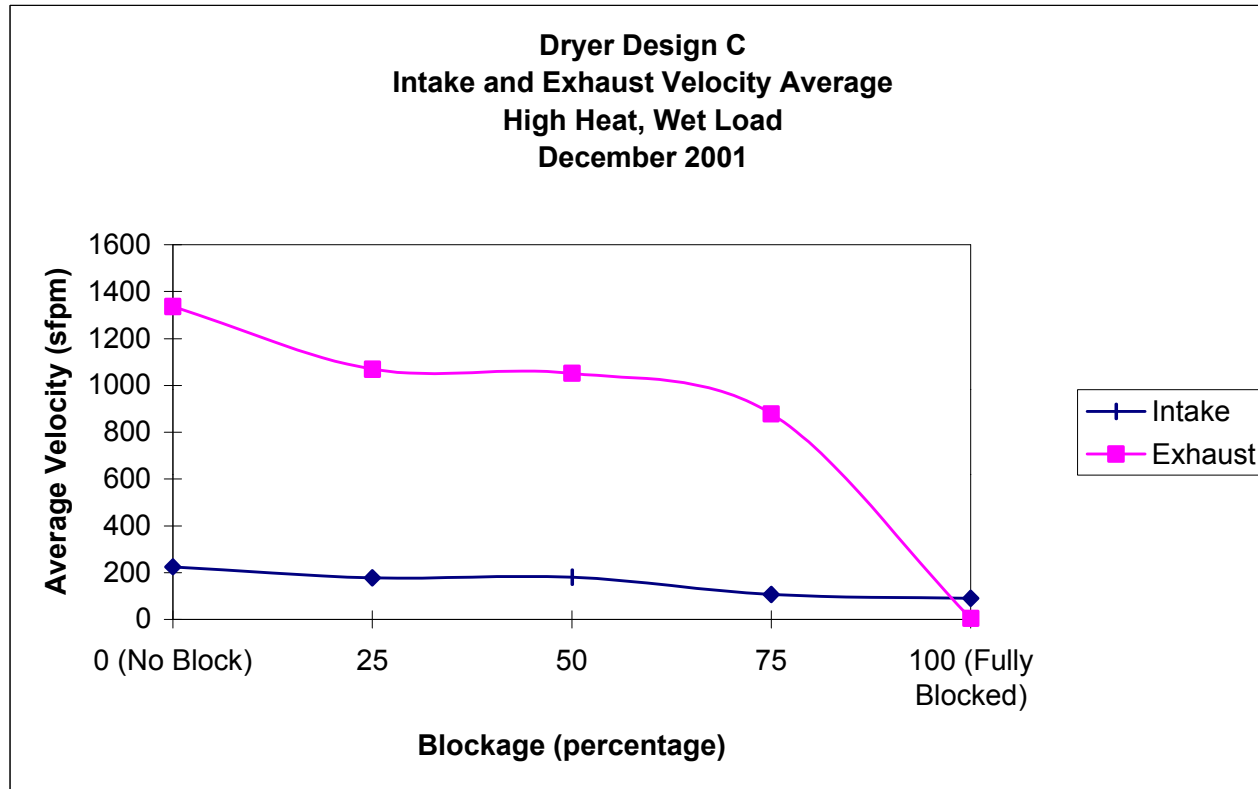

Figure 34. Dryer Design C – Average Airflow Velocities (High Heat and Wet Load)

### *2.2.6.3 Dryer Design C – Primary Thermostat Bypassed*

The primary thermostat was bypassed to simulate a failure mode in which it failed closed. The thermostat was removed from the intake blower housing, and the hole it left was covered with foil tape. The thermostat was placed in a cool part of the dryer to prevent it from switching open. The dryer was operated with full airflow (no exhaust blockage) and with a dry load.

Figure 35 shows the thermocouple and airflow measurement data for Dryer Design C with a bypassed primary thermostat. The graph shows that the dryer began operating on the high-limit thermostat. Since evaluations of Dryer Designs A and B did not result in high-limit cycling when the primary thermostat was bypassed, inspection for a blocked exhaust vent was conducted. It was determined that lint on the rodent screen at the vent hood reduced airflow sufficiently to cause the dryer to operate in the high-limit cycling mode. The lint (approximately 0.69 grams and distributed evenly) was removed at approximately 2000 seconds into the test. For the remainder of the test, the dryer no longer cycled on the high-limit thermostat.



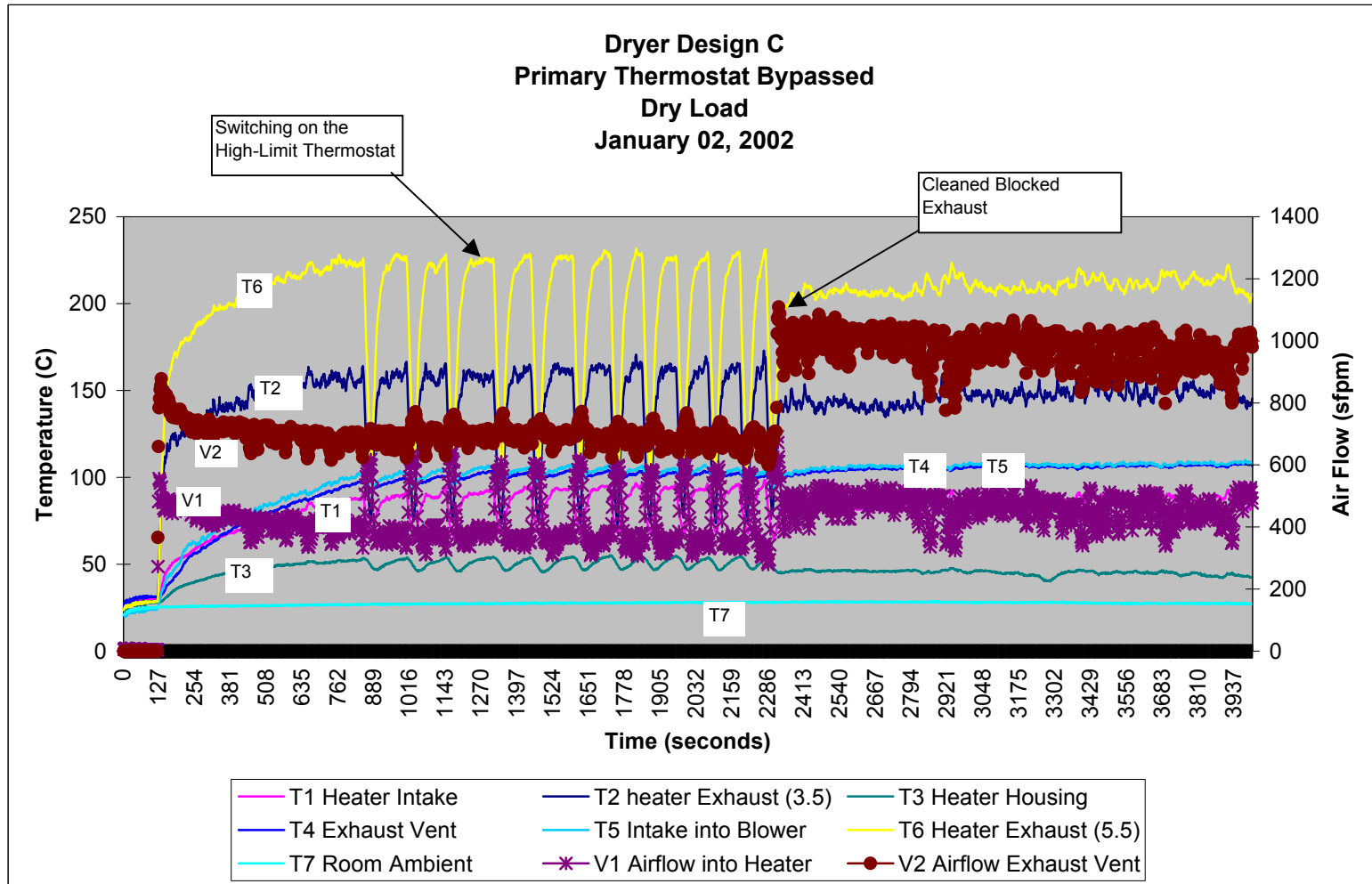

Figure 35. Dryer Design C – Primary Thermostat Bypassed

### 2.2.7 Dryer Design D

Dryer Design D was configured with the heating element behind the tumbler and the lint screen at the front of the dryer. The heated air entered the rear of the tumbler, and the moist air exited through openings at the rear of the front cover leading to the lint screen, as shown in Figure 36.

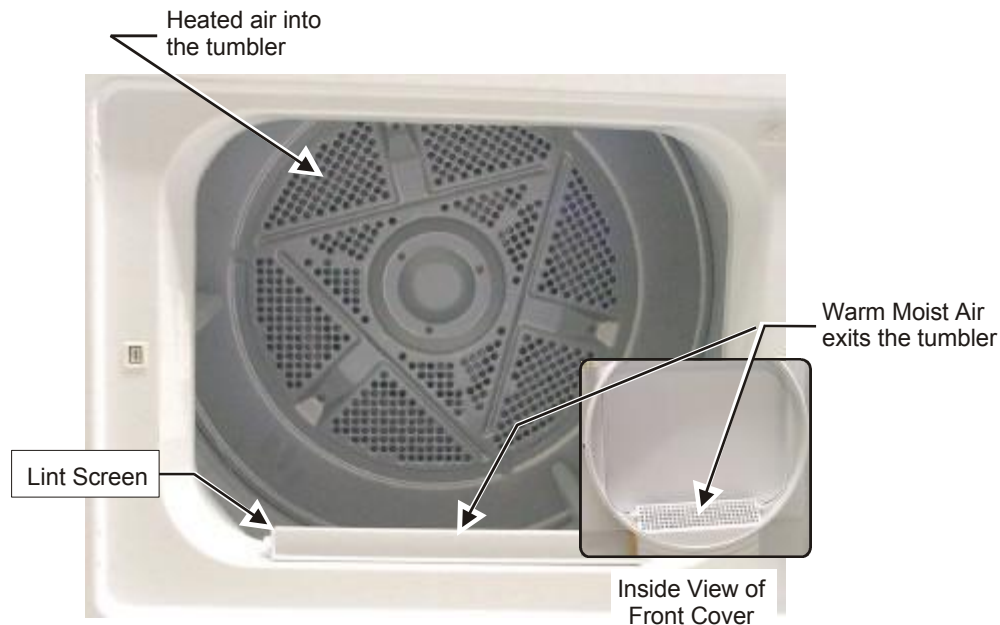

Figure 36. Dryer Design D – Airflow Through the Tumbler

#### 2.2.7.1 *Dryer Design D – Temperature and Airflow Characteristics, Blocked and Unblocked*

Limited testing of this clothes dryer at the high heat settings with no load, with a dry load and with a wet load was conducted. At the end of the wet load testing (60 minutes on Timed Dry), the load was still very damp and had two different cycling periods as shown later.

To determine why the heater had two different cycling periods and the load was still damp at the end of the test, a relay and a 9-volt battery were placed in parallel with the heating element and the high-limit thermostat, as shown in Figure 37. The T2 thermocouple was replaced with the signal from the 9-volt battery. The relay monitored the voltage between the primary and high-limit thermostats. If both thermostats were in their normally-closed positions, the relay would apply 9-volts (actually ~ 7 volts) to the T2 input of the data acquisition system. If the primary thermostat opened, the relay would close and the signal to the data acquisition system would be near zero. If the high-limit thermostat opened, the relay would still be powered and a 9-volt signal would be recorded on the data acquisition system – and the thermocouples would indicate that the heating element was cooling down.

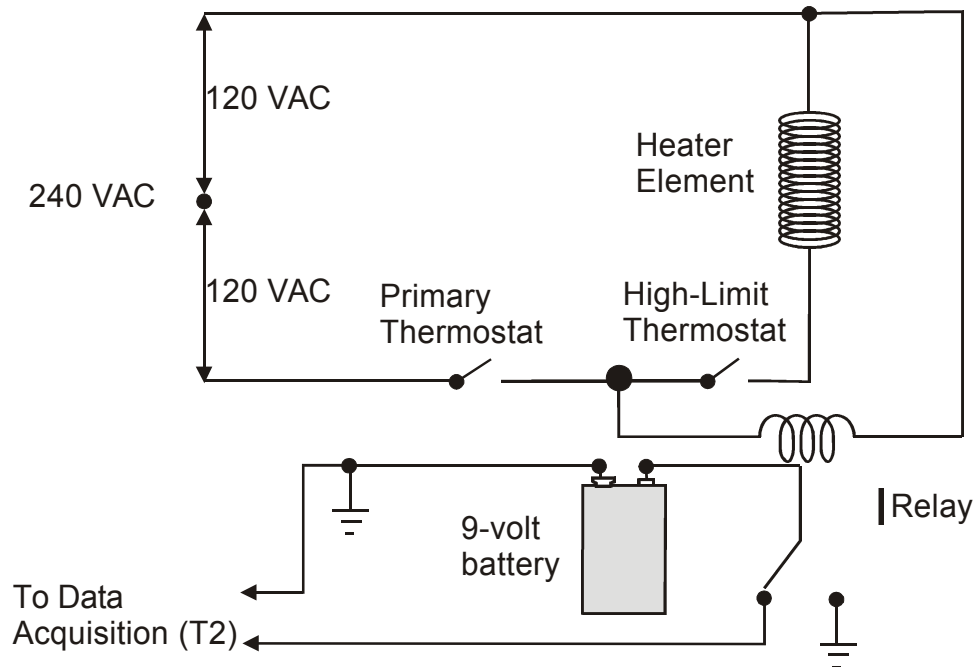

Figure 37. Setup with a Relay and Battery for T2 Analog

Figure 38 shows the thermocouple and airflow measurement data for Dryer Design D with a wet load before setup, as shown in Figure 37. The primary thermostat first disconnected power to the heater at approximately 779 seconds into the test. The heater cycled approximately every 374 seconds, until 3133 seconds into the test. After 3133 seconds, it began to cycle approximately every 190 seconds. At the end of the test – 60 minutes on Timed Dry – the load was still very damp (Lists of the tests and additional figures for Dryer Design D are located in Appendix D.)

The standard load of 10 towels was tested again, but with the T2 analog signal/relay. Figure 39 shows the thermocouple, airflow, and T2 analog data for a wet load. The graph shows that the dryer behaved the same as it had in the previous test; i.e., it exhibited the phenomenon of two periodic cycles for the thermostats. In this case, however, it could be determined from the T2 signal that the first periodic cycling was caused by the high-limit thermostat, and the second periodic cycling was caused by the primary thermostat. As before, the towels were still very damp at the end of the 60-minute (Timed Dry) drying cycle.

The most likely cause for the dryer to begin operating on the high-limit thermostat in the unblocked exhaust vent condition was inadequate airflow through the tumbler. The dryer appeared to be responding to an overload condition in which the load restricted the airflow through the tumbler.

To determine why the primary thermostat began cycling later in the test, the dryer door was removed and replaced with a sheet of rigid clear plastic. It was observed that, after a period, the load stopped tumbling and began to ride along the sides of the rotating drum. This explained why the dryer began cycling on the primary thermostat. When the load was riding on the rotating drum, this allowed the heated air to pass freely through the tumbler and into the lint

screen/blower. The primary thermostat was able to detect the increase in temperature, causing it to open or cycle the heater off. When the tumbler temperature cooled, the primary thermostat closed or cycled the heater on. This also explained why the load was still damp at the end of the 60-minute drying cycle. This same phenomenon occurred when the dryer was tested with wet or damp loads of 10, 7, or 5 towels, as shown in Appendix D. (A video clip demonstrating this phenomenon is included in Appendix J.) This phenomenon also occurred with Dryer Design B, but it was not as repeatable as it was with Dryer Design D.

The thermocouple and airflow measurement data for Dryer Design D are not listed here. The data would not be meaningful because of the operating characteristics of the dryer; i.e., immediate high-limit cycling due to overloading and the phenomenon of the load riding along the sides of the rotating drum.

To obtain steady and consistent data, the dryer was tested with no load with a partially-blocked exhaust vent (25%, 50%, 75% blockage), and a 100% blocked exhaust vent.

Figures 40 and 41 show comparisons of temperature measurement data for unblocked, partially-blocked, and fully-blocked exhaust vent conditions for T1 and T3 thermocouples. (Appendix D contains graphs of the temperature data for the remaining thermocouples, T2, T4, T5, T6, and T7.)

Figure 40 shows that the dryer began to operate on the high-limit thermostat when the exhaust duct was 75% or 100% blocked. For the 25% and 50% blocked exhaust vent conditions, the temperatures measured were similar to those measured when the exhaust vent was unblocked. For the 75% and 100% exhaust vent blockage conditions, the graph shows two different periodic rates at which the high-limit thermostat cycled. With the exhaust vent 75% blocked, the lower set point temperature for the high-limit thermostat was 50° C; when the exhaust vent was 100% blocked, it appeared to be switching at 100° C. It could not be determined why the high-limit thermostat was cycling at two different lower set points for the 75% and 100% blocked conditions.

Figure 41 shows comparisons of temperature data at the heater box T3 thermocouple, for unblocked, partially-blocked, and fully blocked exhaust vent conditions. The housing temperature increased to approximately 50°C for the unblocked, 25% and 50% blocked vent conditions. At blockages of 75% and 100%, the housing temperature increased to approximately 150°C.

US CONSUMER PRODUCT SAFETY COMMISSION  
 FINAL REPORT ON ELECTRIC CLOTHES DRYERS AND LINT IGNITION CHARACTERISTICS  
 May 2003

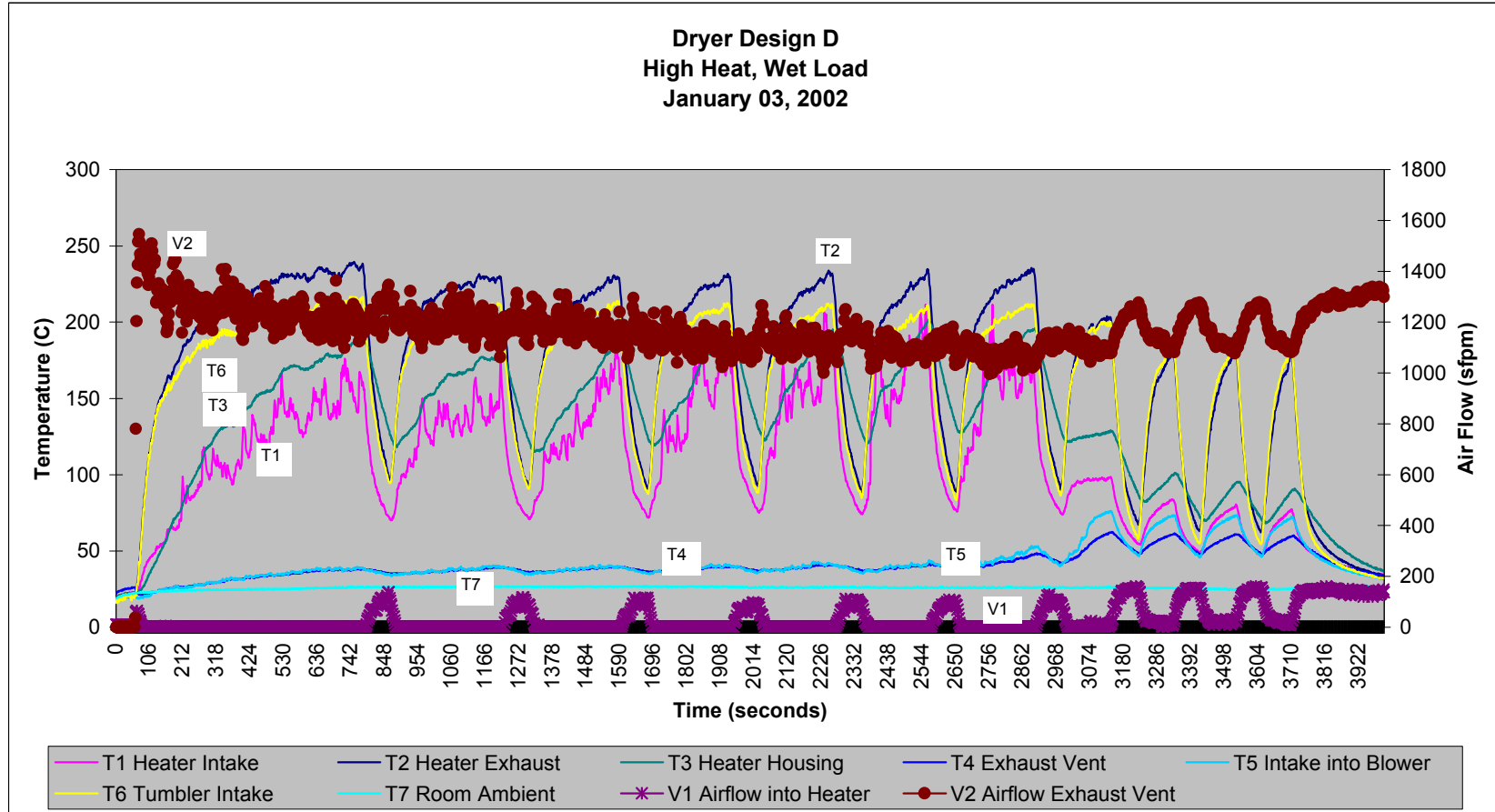

Figure 38. Dryer Design D – Thermocouple and Airflow Measurements (Wet Load)

US CONSUMER PRODUCT SAFETY COMMISSION  
 FINAL REPORT ON ELECTRIC CLOTHES DRYERS AND LINT IGNITION CHARACTERISTICS  
 May 2003

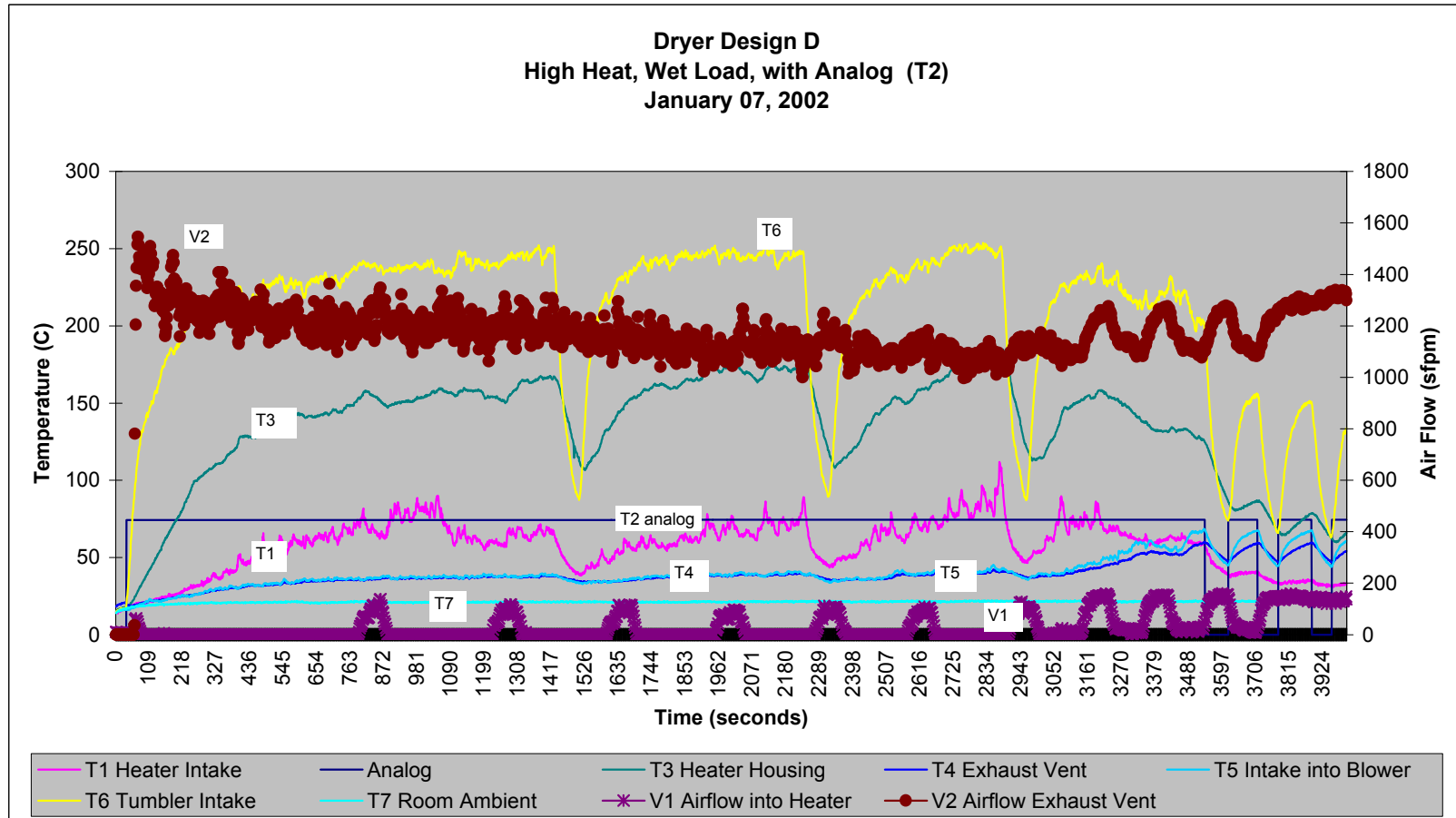

Figure 39. Thermocouple, Airflow and Relay (T2 Analog) Measurements

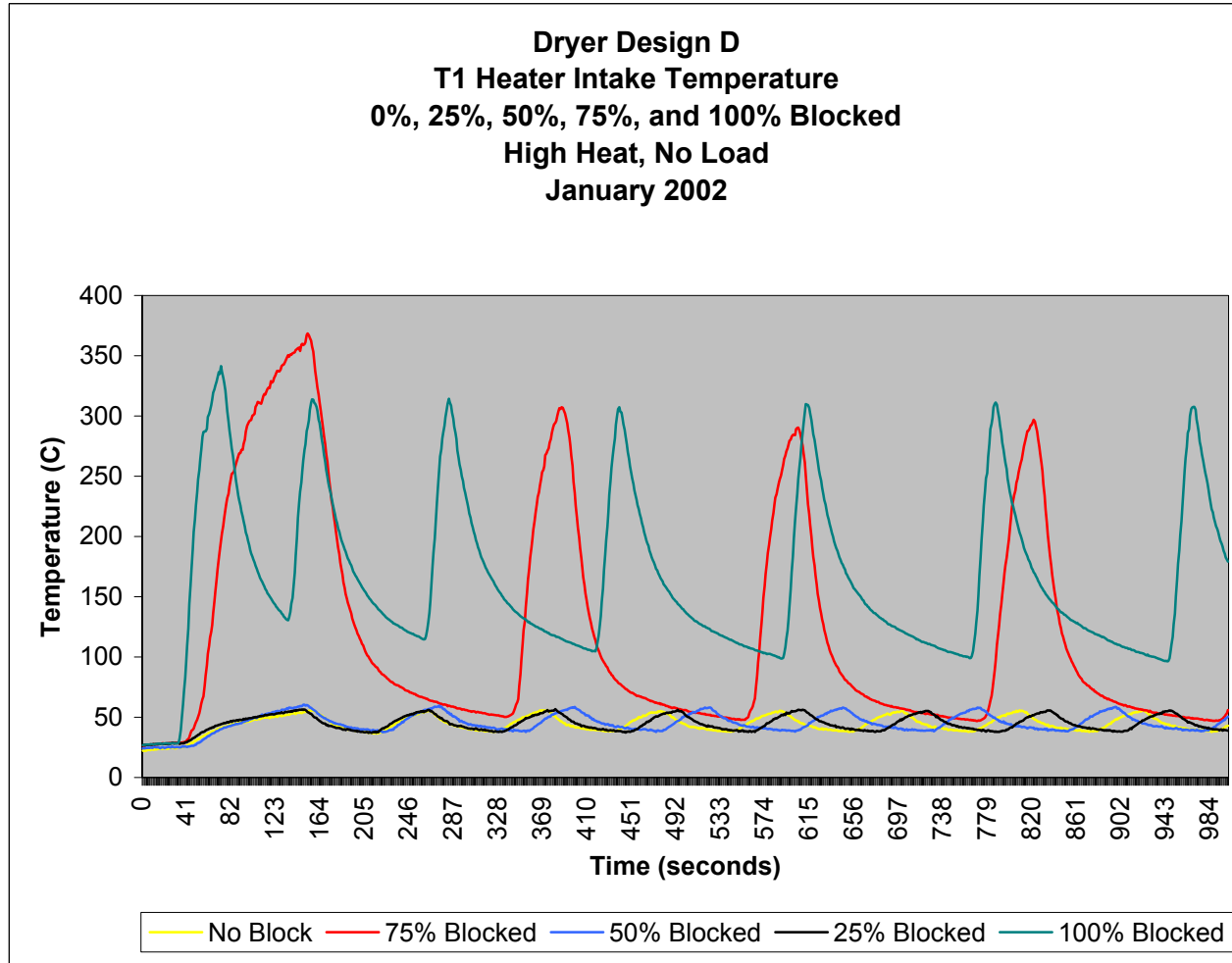

Figure 40. Dryer Design D – T1 Heater Intake Comparison

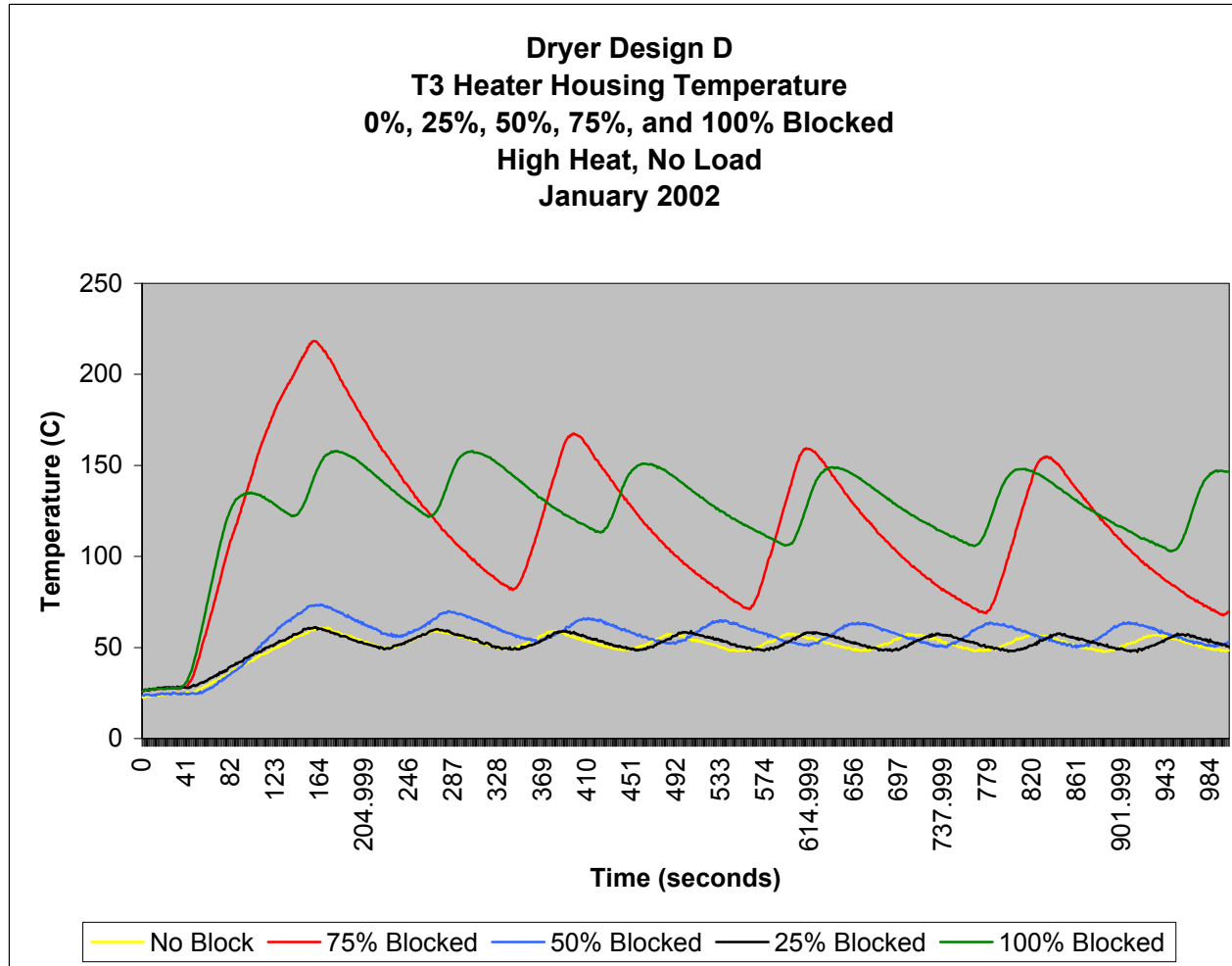

Figure 41. Dryer Design D – T3 Heater Housing Temperature Comparison



### 2.2.7.2 *Dryer Design D – Airflow*

The airflow was measured using hot wire anemometers placed at the intake airflow into the heater and in the exhaust vent. The anemometer at the exhaust vent was placed in the center of the cross-section of the air stream. The other anemometer was placed at top-center of the circular heater intake. The anemometer placed in the exhaust vent was positioned 36" after the first elbow to avoid circular turbulence effects from the dryer blower. As mentioned earlier, the iris and blast plate for the partially-blocked and fully-blocked conditions, respectively, were placed before the hot wire anemometer located in the exhaust vent.

Figure 42 shows the intake air velocity comparisons for the unblocked, partially-blocked, and fully-blocked exhaust vent conditions with no load. Due to the configuration of the heating element, the intake air velocity measurement data were not as accurate as the exhaust air velocity data. The air intake was configured in a 360° ring behind the tumbler, with a long narrow slot. The shape and surface area of the heater intake caused the airflow velocity to be below the resolution of the anemometer instrumentation.

Figure 43 shows the exhaust air velocity comparisons for the unblocked, partially-blocked, and fully-blocked exhaust vent conditions with no load. The graph shows a slight overshoot at initial startup of the dryer, which was caused by the blower being energized, as seen with the other dryer designs. There were periodic increases in exhaust airflow, which corresponded to the heating element cycling off when the primary thermostat opened. The increase in exhaust airflow was caused by the anemometer responding slowly to the sudden temperature changes.

Figure 44 shows the average intake and exhaust air velocities for the different blockage conditions. The data from 120 seconds to 1000 seconds were averaged. This would avoid the initial overshoot when the blower was first powered. The 25% and 50% blocked exhaust conditions displayed a more pronounced, higher exhaust airflow velocity than did the unblocked condition; this was not seen during examination of the other dryer designs.

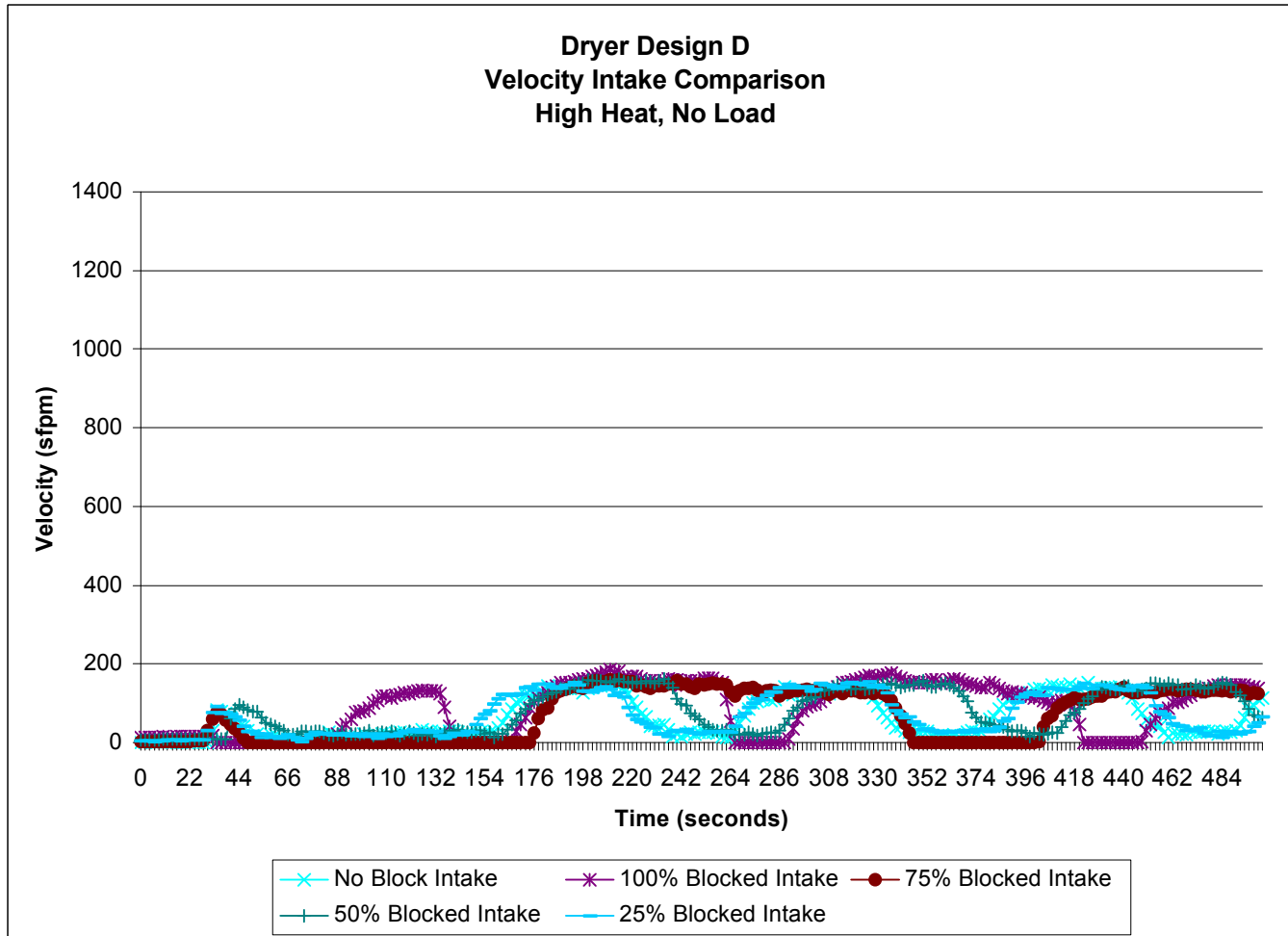

Figure 42. Dryer Design D – Intake Air Velocity

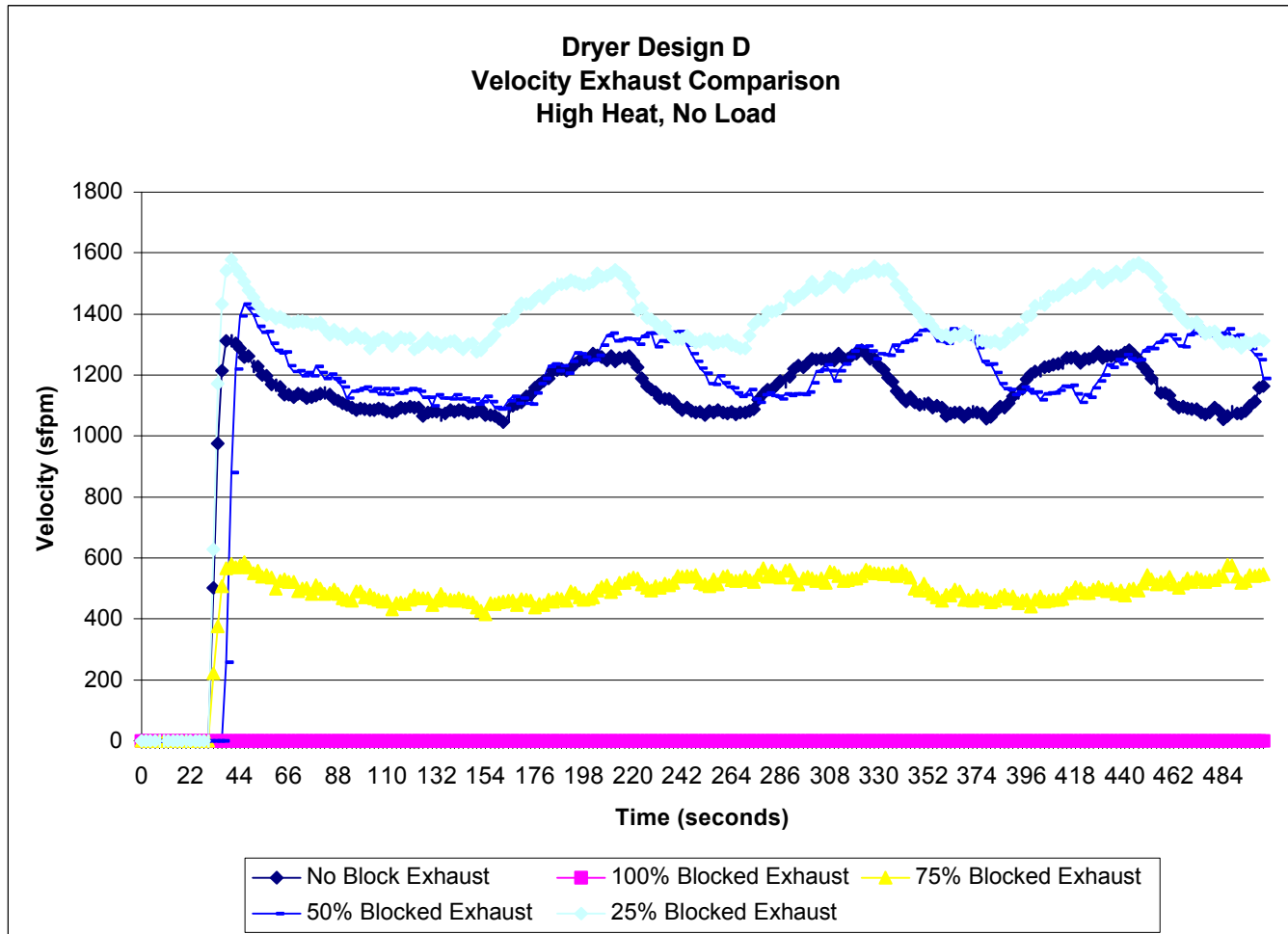

Figure 43. Dryer Design D – Exhaust Vent Air Velocity

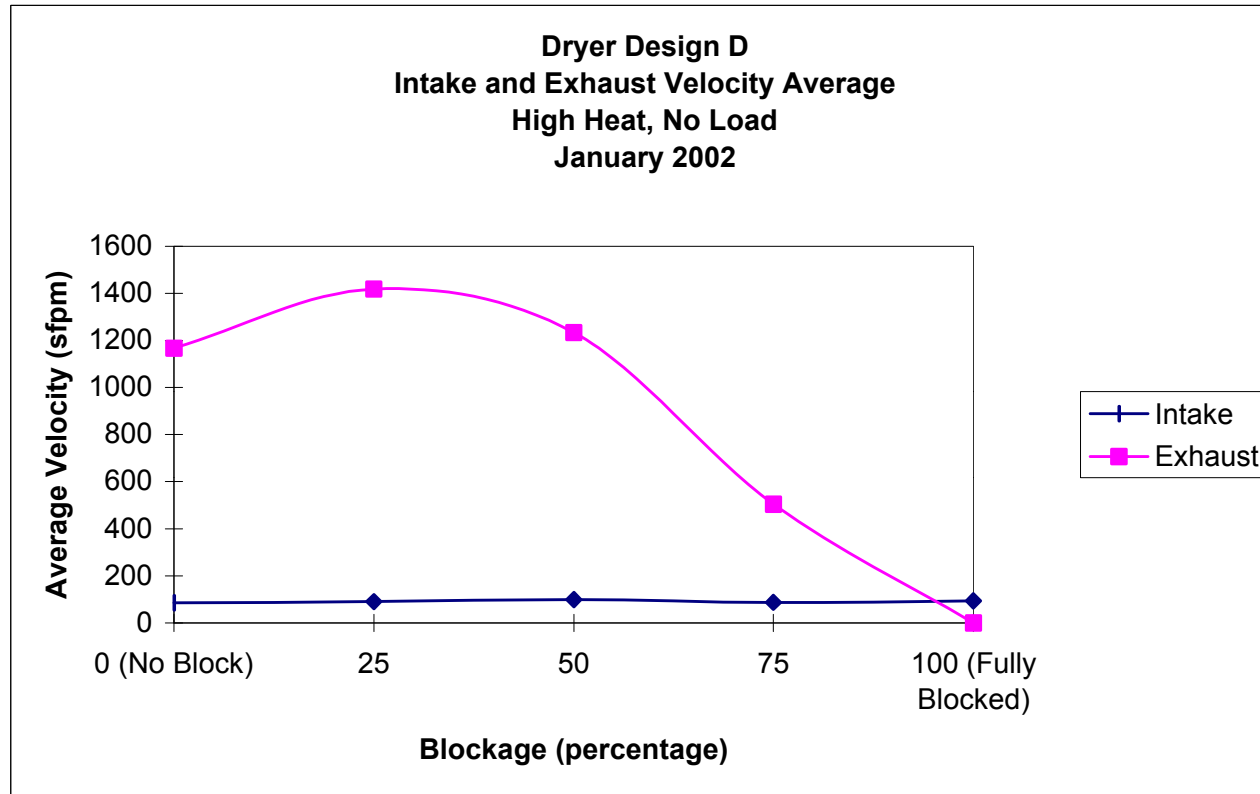

Figure 44. Dryer Design D –Average Airflow Velocities (High Heat and No Load)

### *2.2.7.3 Dryer Design D – Primary Thermostat Bypassed*

The primary thermostat was bypassed to simulate a failed closed primary thermostat. The thermostat was removed from the intake blower housing, and the hole was covered with foil tape. The thermostat was placed in a cool part of the dryer to prevent it from switching open. The dryer was operated with full airflow (no exhaust blockage) and a wet (washed and spun dry) load. To avoid the phenomenon where the load stopped tumbling after a period, the dryer load was reduced to six cotton towels. Five of the six towels were of the same size as used before. The sixth towel was a different size, approximately 25% larger, to help prevent the load from riding the tumbler. The T2 analog signal was used to determine if either the primary or the high-limit thermostat opened.

Figure 45 shows the thermocouple and airflow measurement data for Dryer Design D with a bypassed primary thermostat. The load began to ride the sides of the tumbler at approximately 1900 seconds after the dryer was started. Approximately 3000 seconds after the dryer was started, the high-limit thermostat opened, as shown by the graph of the T2 analog signal. For unknown reasons, the T1 thermocouple became very erratic just before the high-limit switch opened. The test was stopped at approximately 3250 seconds after the dryer was started.

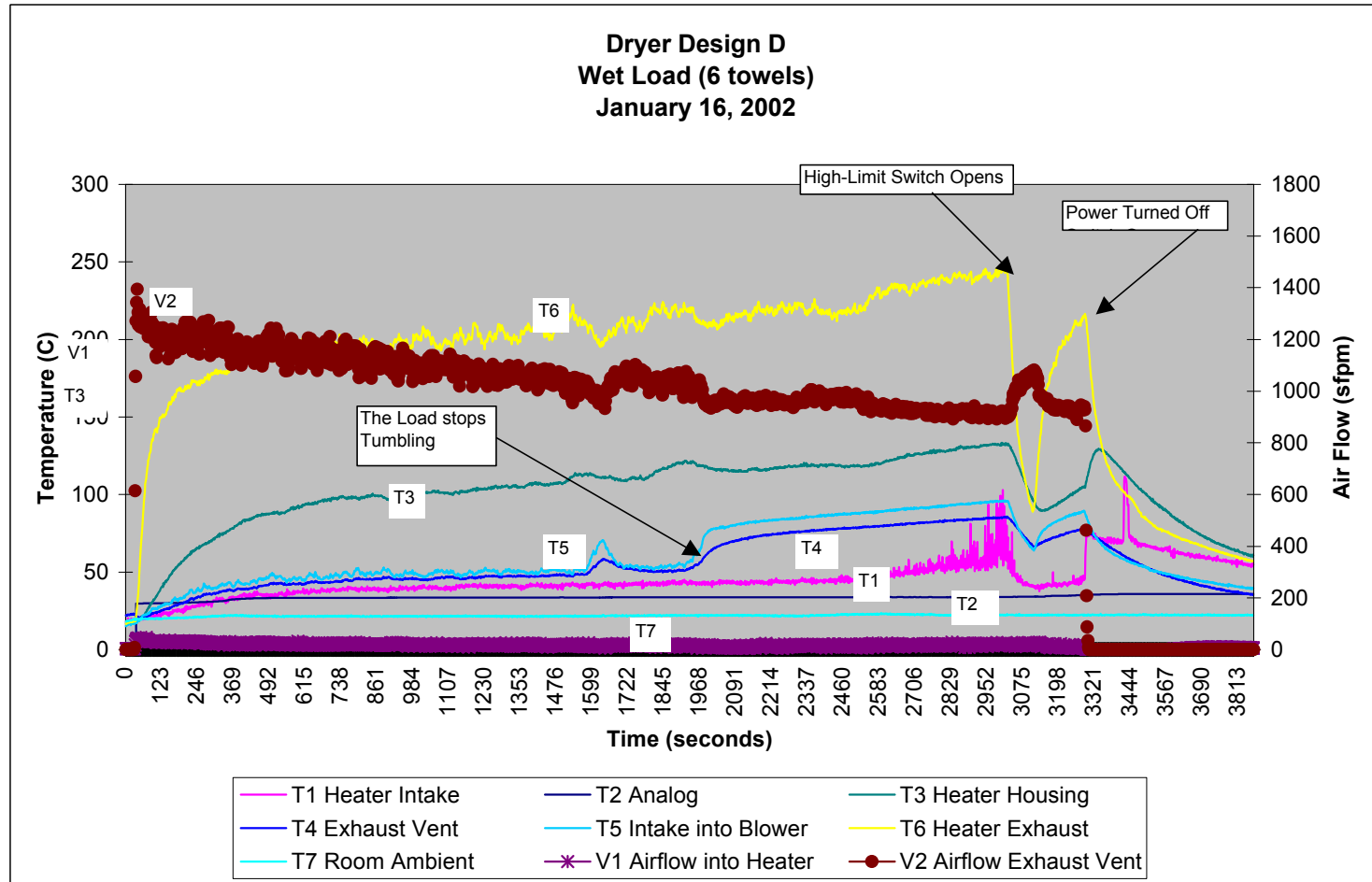

Figure 45. Dryer Design D – Primary Thermostat Bypassed

### 2.3 Task 3: Monitor Lint Distribution

The objective of this task was to monitor lint distribution and accumulation in areas within a clothes dryer during operation with normal airflow. Lint accumulation was characterized in one dryer, and an analysis of potential causes for lint accumulation in other dryer designs was conducted.

#### 2.3.1 Test Setup

Dryer Design A was selected for testing. It provided the most convenient access to the interior of the dryer without removing or disturbing any interior dryer components.

Two view ports of clear plastic were installed on opposite sides of the dryer chassis (one is shown in Figure 46(a)). One view port measured 3.5 inches by 19.5 inches; the other measured 3.5 inches by 23 inches. A silicone-type caulk was used to seal the edges of the view ports. During testing, the back panel of the dryer was installed; however, it was temporarily removed, as shown in Figure 46(b), to inspect the lint accumulation before, during, and after testing.

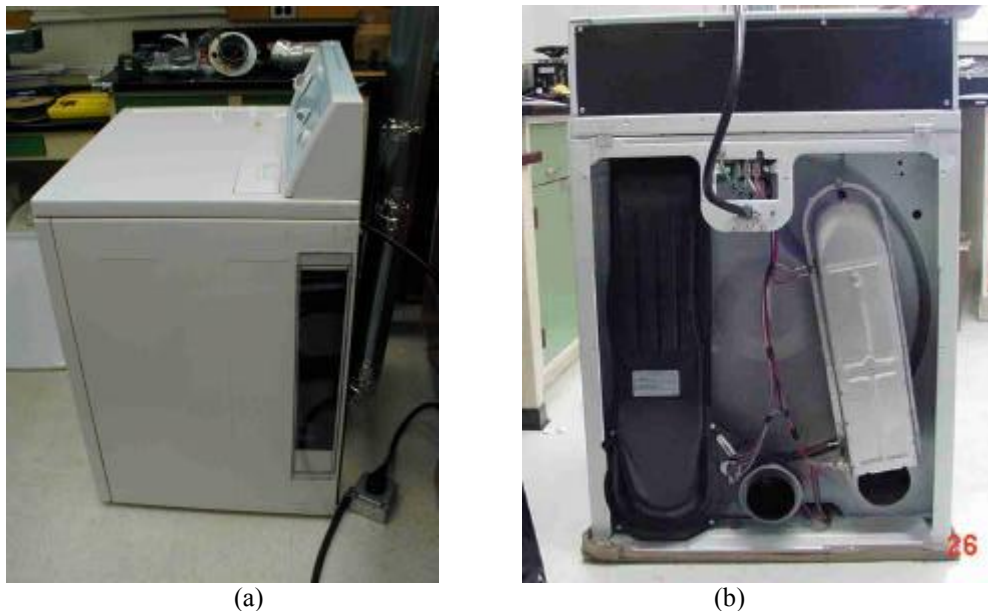

Figure 46. Dryer Design A Used in Task 3 Testing

The dryer was vented to the outside of the building. All venting material was 4-inch rigid metal duct. All joints were sealed with foil tape except for the connection to the dryer; the exhaust vent was secured to the dryer using a 4-inch duct (hose) clamp.

### 2.3.2 Test Description

For this task, loads of towels were alternately washed in detergent-free hot water and spun dry, then dried for approximately 60 minutes in the dryer using the Timed Dry feature (one washing followed by drying equals one cycle). A total of 100 cycles was completed. After 48 and 100 cycles, the interior of the dryer was inspected and the presence of any lint accumulation was documented.

Four loads of towels were used in Task 3 testing; a load consisted of 10 white cotton towels. During the first 48 cycles, two of the four loads were used for the test. For cycles 49 through 100, the remaining two loads were used.

Before each cycle, a load was conditioned overnight (for approximately twelve hours) in a conditioning chamber with a controlled relative humidity (RH) of  $50 \pm 5\%$  and a temperature of  $23^\circ$  to  $25^\circ$  C.

Two test methods to record the amount of lint accumulation in the dryer were attempted. Method 1 was to record the weight loss of a load resulting from the washing and drying cycles. Method 2 was to visually inspect the interior of the dryer for lint accumulation.

#### 2.3.2.1 *Method 1 – Weight Loss of Load*

Method 1 was used to estimate the amount of towel material lost (as lint) into the interior of the test dryer by recording the weight loss of a load resulting from the washing and drying cycles. The weight of a conditioned load was recorded before the start of a cycle. The amount of towel material lost during washing, the amount that accumulated on the lint screen during drying, and the amount lost through the dryer vent were recorded. The remainder of any lost material was assumed to have escaped into the interior of the dryer chassis.

This method proved to be unsuitable for two reasons. The first was the fluctuation in the humidity level in the conditioning chamber, which varied by  $\pm 5\%$  RH. The second was the rate at which the towels lost moisture outside the conditioning chamber, depending on the humidity.

To determine the weight variation in the conditioned load due to the fluctuation in relative humidity of the conditioning chamber, a load of towels was stored overnight in a room with approximately 25% RH. The load was then transferred to the conditioning chamber. After conditioning for a minimum of 14 hours, the towel load was weighed. The consequent weight gain was approximately 100g, or 4g per 1% RH. With the conditioning chamber having a variation of  $\pm 5\%$  RH, the weight of a 5000g load could vary by  $\pm 20$ g.

The difference in humidity between the conditioning chamber and the test room caused the weight of the towels to vary more significantly than the amount of lint lost. The towels were weighed in the test room after they were removed from the conditioning chamber. During the time that the towels were weighed, moisture in the towels could evaporate. The relative humidity levels in the test room and the conditioning chamber were 20-30% RH and  $50 \pm 5\%$  RH, respectively.

The average weights of lint samples collected during one cycle were 0.6g (after wash), 0.4g (in the lint screen), and 0.2g (in the dryer vent), or a combined weight of 1.2g. The



uncertainty in the weight of a load ( $\pm 20\text{g}$ ) due to changes in humidity was much greater than measurable lint loss due to the washing and drying cycle. It can also be assumed that the uncertainty in the weight of a load would be even greater than the measurable lint lost in the dryer chassis interior per cycle.

The unsuitability of this test method was further verified by calculating the standard deviation of the load weight before wash. The standard deviation was  $\pm 100\text{g}$ , and the standard deviation of the mean was  $\pm 20\text{g}$ . In order to detect a loss of lint during the drying process, it would be necessary to resolve a weight differential of less than  $1.0\text{g}$  and a relative humidity of 1%. This was not possible with the available test conditions (load weight varying by  $\pm 20\text{g}$  and fluctuation of  $\pm 5\%$  RH in the conditioning chamber).

### 2.3.2.2 Method 2 – Visual Examination

Method 2 was to visually observe any accumulation of lint inside the dryer chassis before, during, and after testing. After 48 cycles (using the first two loads of towels), a preliminary count of accumulated lint and dust particles was performed. Some lint accumulation, as well as some towel degradation, was observed. The lint accumulation test continued for another 52 cycles using the second two loads of new towels. A total of 100 cycles was completed.

After 100 cycles, visible evidence of lint accumulation was detected (as shown in Figure 47). A lint ball approximately one inch in diameter was observed inside the chassis. The lint was white and, therefore, it was inferred that it was from the towel material. There appeared to be no significant admixture of room dust, which was not likely to have been white in color.

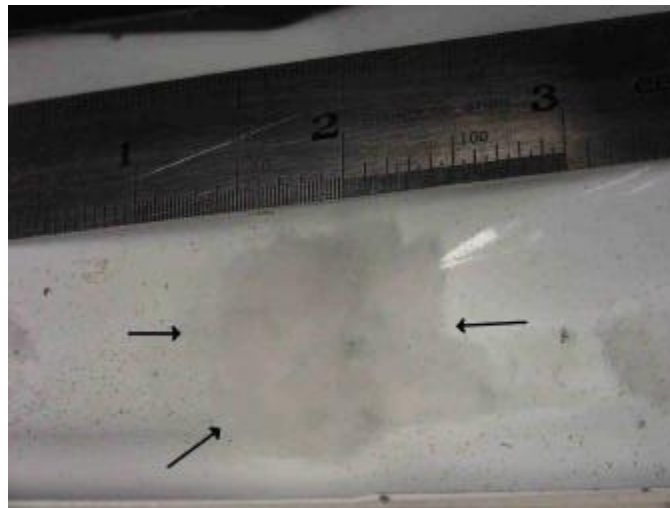

Figure 47. Lint Accumulated at Bottom of Dryer After 100 cycles

Figure 48 shows lint that accumulated on the interior dryer vent after 48 cycles. Figure 49 shows the same area after 100 cycles. An increase in the number of lint particles was noticeable.

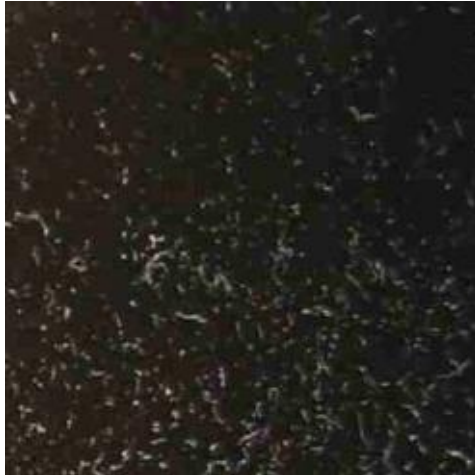

Figure 48. Lint Accumulated on Interior of Dryer After 48 Cycles

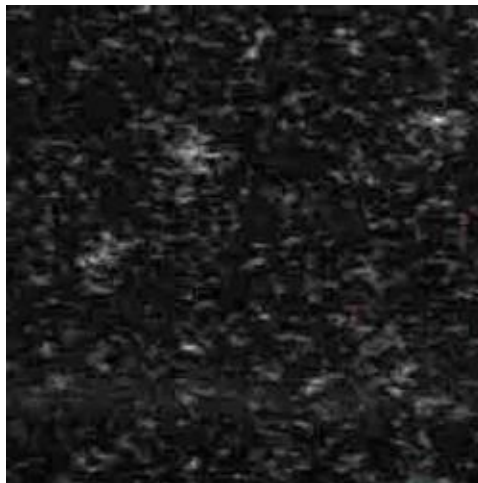

Figure 49. Lint Accumulated on Interior of Dryer After 100 Cycles  
(same location as shown in Figure 48)

The number of lint particles in an approximately half-inch square shown in Figures 48 and 49 was estimated. Approximately 83 particles were counted after 48 cycles; there were approximately 250 particles after 100 cycles. Some areas of the dryer did not show an observable gain in lint coverage, while other areas had significant gains.

### 2.3.3 Examination of Dryer Design A

Figure 50 shows an area of the blower fan housing after 100 cycles. A significant accumulation of lint was observed at a sealed joint for the blower housing (shown by white arrow), and a lint ball was observed on the dryer floor (shown by black arrow). This accumulation was not apparent at the start of Task 3 testing or after 48 cycles.



Figure 50. Lint Build-up at Blower Housing Seal and Dryer Floor

## 2.4 Task 4: Determine Characteristics Required for Lint Ignition

The main objective of this task was to record the ignition characteristics of lint on, near, and ingested into the heater. The test variables used in the Task 4 testing were developed from data collected in *Task 2. Document Dryer Operating Characteristics*. The testing was divided into two phases. Phase I consisted of examining the ignition characteristics of lint on and near the heater. Phase II consisted of examining the ignition characteristics of lint that was ingested into the heater.

### 2.4.1 Test Setup

A test apparatus was constructed to house the heater box/element (from Dryer Design A) and venting material for the heater exhaust, as shown in Figures 51 and 52. The test setup allowed precise control of the test conditions. Two fans and irises were installed to independently control the airflow external and through the heater box. The heater was wired to a variable transformer to control the heat output, if needed. All venting material was 4-inch rigid metal duct. All joints were sealed with foil tape. Appendix F illustrates the dimensions of the test setup used in Task 4.

Although a heater from one of the dryer designs was used, the test setup removed many of the design variables found in any particular dryer design, and staff believes the test results may be applied to the other dryer designs.

### 2.4.2 Instrumentation Setup

The test setup was instrumented with six thermocouples and two hot wire anemometers. One additional thermocouple was used to record the ambient room temperature. All seven thermocouples were 24 gauge, K type. The same thermocouples used in the Task 2 testing were used in this phase of testing.

Table 6 lists the locations of the thermocouples. The T3 thermocouple was cemented to the heater housing using a ceramic based cement.

Table 6. Thermocouple Location and Setup

Thermocouple	Location
<i>T1</i>	Heater Intake
<i>T2</i>	Heater Exhaust
<i>T3</i>	Heater Housing or Lint Sample*
<i>T4</i>	Intake into Blower/Heater Exhaust
<i>T5</i>	Intake into Blower/Outside Heater
<i>T6</i>	Chamber Temperature
<i>T7</i>	Ambient Room

\* Location may differ, as specified in the report

US CONSUMER PRODUCT SAFETY COMMISSION  
FINAL REPORT ON ELECTRIC CLOTHES DRYERS AND LINT IGNITION CHARACTERISTICS  
May 2003

Two anemometers were used in this phase of testing. One anemometer was placed at the heater box intake. The second anemometer was placed near the top of the heater box to measure the airflow over the heater box housing.

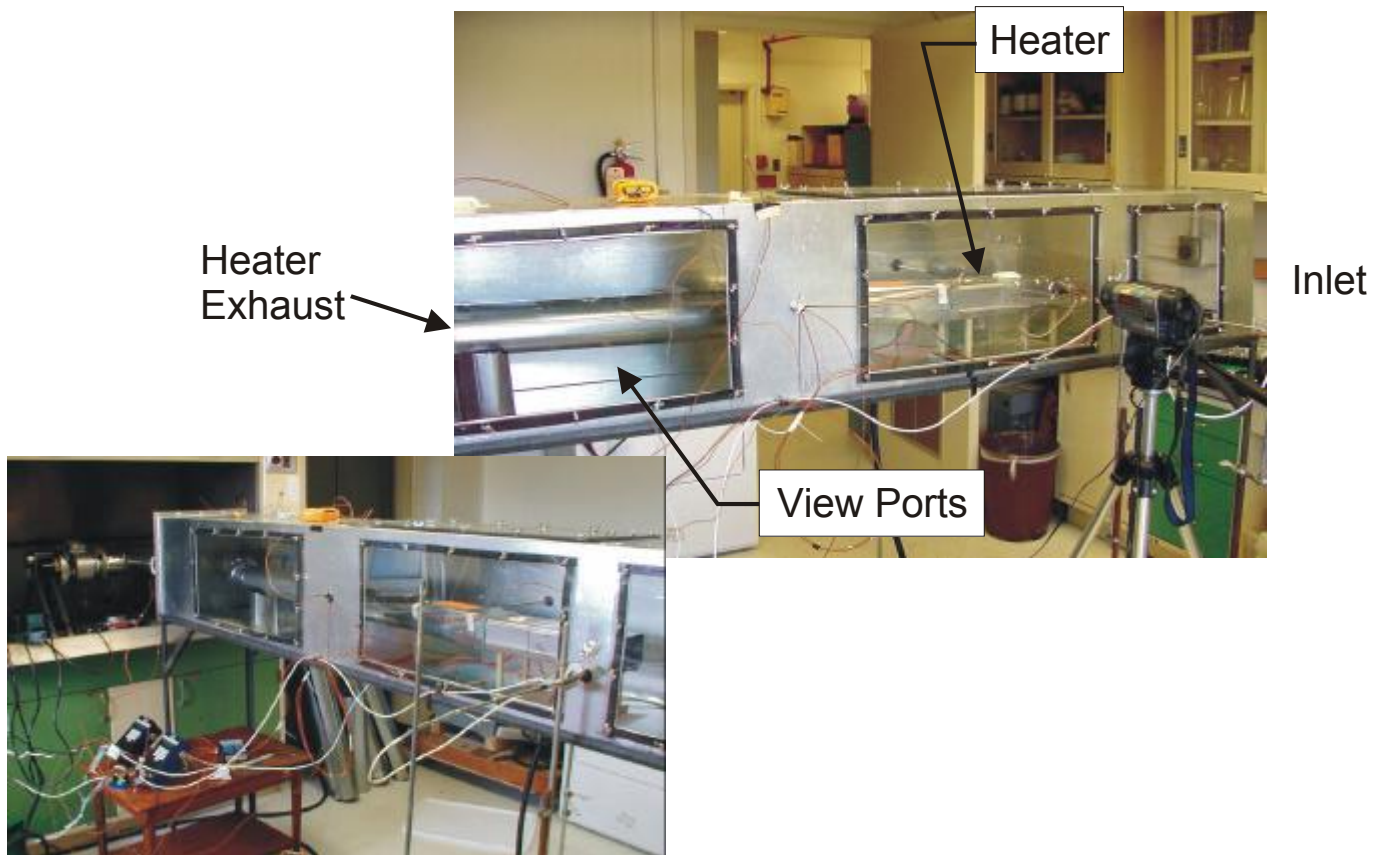

Figure 51. Test Setup for Lint Ignition

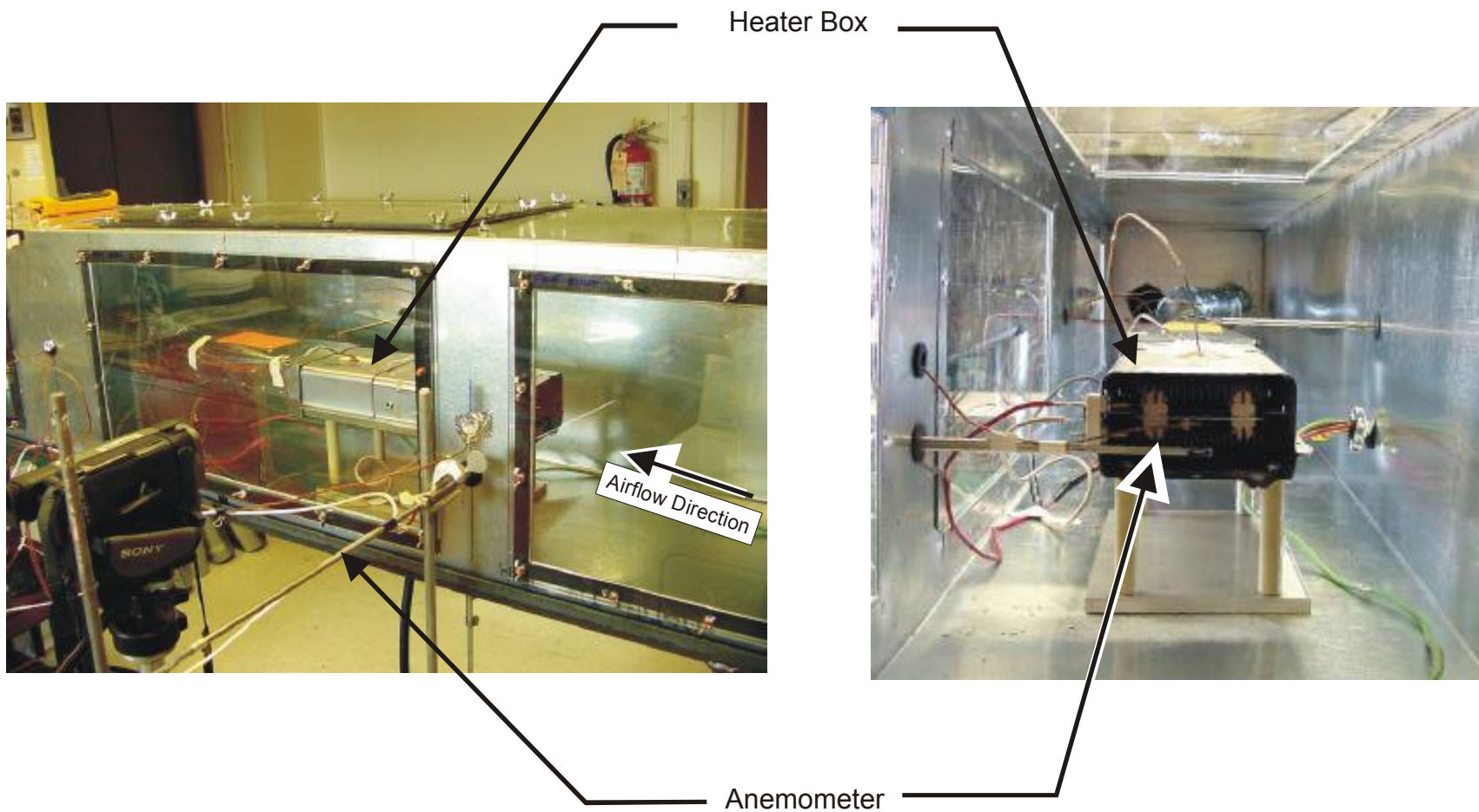

Figure 52. Test Setup for Lint Ignition

### 2.4.3 Phase I – Ignition Characteristics of Lint On and Near the Heater Box

In this phase of testing, lint samples were placed on top of the heater housing, at one side of the heater housing, and at the heater intake. All lint samples were conditioned for a minimum of 24 hours at 23°C to 25°C and 50% to 55% relative humidity.

The lint samples were tested at five different locations on the heater housing as shown in Figure 53. Lint samples were tested in two locations on top of the heater housing, locations A and B. Lint samples were tested at three locations on one side of the housing, locations C, D and E.

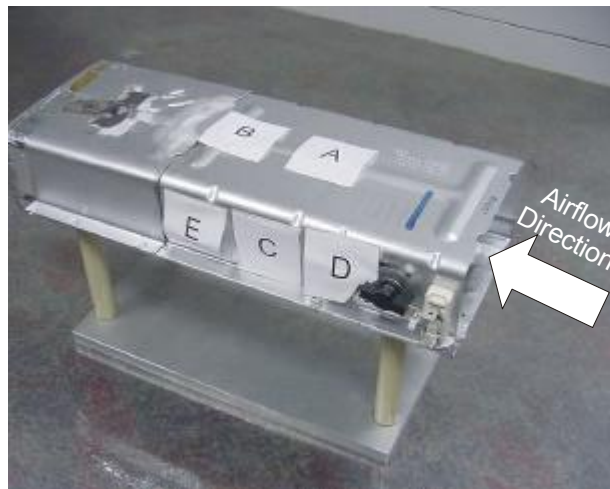

Figure 53. Location of Lint Samples on the Housing

#### 2.4.3.1 Top of Heater Housing

The first series of tests was conducted with lint samples placed on top of the heater housing at location A, as shown in Figure 54. The high-limit thermostat was bypassed for this series of tests.

The lint samples measured approximately 2 x 2 x ¼ inches and weighed approximately 0.30 grams. The samples were 100% cotton lint collected from the lint screen during Task 3 testing.



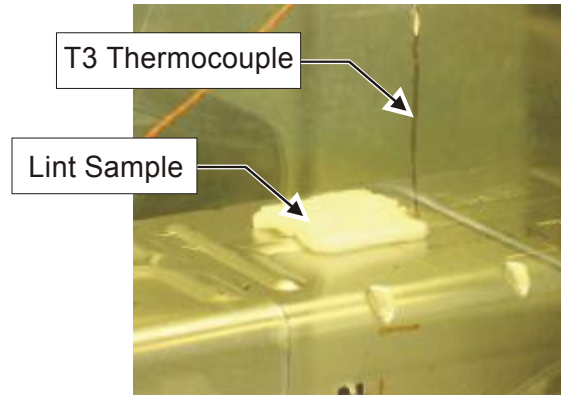

Figure 54. Lint Sample on Heater Housing at Location A

Table 7 provides a list of the lint ignition tests that were conducted at location A on top of the heater housing. The table includes the weights of the lint samples tested, test conditions, and the observed results.

Table 7. Testing on Top of the Heater Housing at Location A

Location	Number	Weight (grams)	Power	Intake Airflow (sfpm)	Outside Airflow (sfpm)	High-Limit Thermostat	Result
A	s1-1	0.32	step	0	0	bypassed	smolder
A	s1-2	0.33	step	0	0	bypassed	smolder
A	s1-3	0.33	step	0	40	bypassed	smolder
A	s1-4	0.34	instant	0	40	bypassed	smolder
A	s1-5a	0.32	instant	0	40	bypassed	smolder
A	s2-8	0.30	instant	0	40	bypassed	smolder
A	s5-1	0.32	instant	650 → 0@400s	40	bypassed	smolder

The samples either smoldered or charred during the tests, as shown in Figure 55. In the first three tests (Sample Numbers s1-1, s1-2, and s1-3), the power to the heater was incrementally increased. In the next three tests (s1-4, s1-5a, s2-8), power was applied instantaneously to the heating element. In all these tests, the samples smoldered but did not ignite. In test s5-1, the airflow through the heater was initially 650 sfpm until 400 seconds when it was decreased to zero sfpm. The sample charred and smoldered.



Sample 1-5a

Before

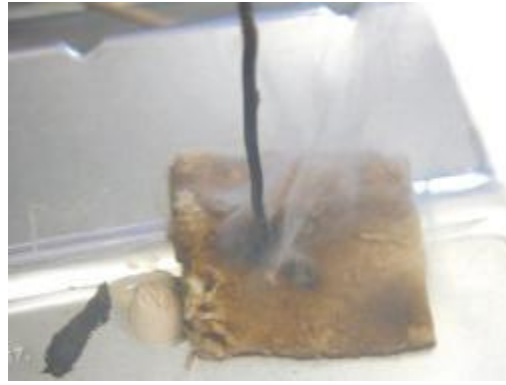

Sample 1-5a

Smoldering

Figure 55. Sample Smoldering at Location A

Table 8 provides a list of the lint ignition tests that were conducted at location B on top of the heater housing. The lint samples measured approximately 2 x 2 x ¼ inches and weighed approximately 0.30 grams. The samples were 100% cotton lint collected from the lint screen during Task 3 tests. The table includes the weights of the lint samples tested, test conditions, and the observed results.

Table 8. Testing on Top of the Heater Housing at Location B.

Location	Number	Weight (grams)	Power	Intake Airflow (sfpm)	Outside Airflow (sfpm)	High-Limit Thermostat	Result
B	s5-8	0.34	instant	0	40	bypassed	ignited
B	s5-9	0.28	instant	0	40	bypassed	ignited
B	s5-10	0.34	instant	0	40	bypassed	ignited
B	s5-11	0.32	instant	0	40	series	smolder
B	s5-12	0.34	instant	300	40	series	smolder
B	s5-13	0.34	instant	200	40	series	smolder

In three of the six tests conducted at location B, the high-limit thermostat was bypassed; in the other three, the high-limit thermostat was connected in series with the heating element. The airflow through the heater was set at either 200 or 300 sfpm in the last two tests. In the first three tests at location B (s5-8, s5-9, and s5-10), the samples ignited. Figure 56 shows sample s5-8 igniting during the test. Figure 57 shows a graph of the thermocouple data for sample s5-8. The sample ignited approximately 30 seconds after power was applied to the heating element.

US CONSUMER PRODUCT SAFETY COMMISSION  
 FINAL REPORT ON ELECTRIC CLOTHES DRYERS AND LINT IGNITION CHARACTERISTICS  
 May 2003



Figure 56. Sample s5-8 at Location B

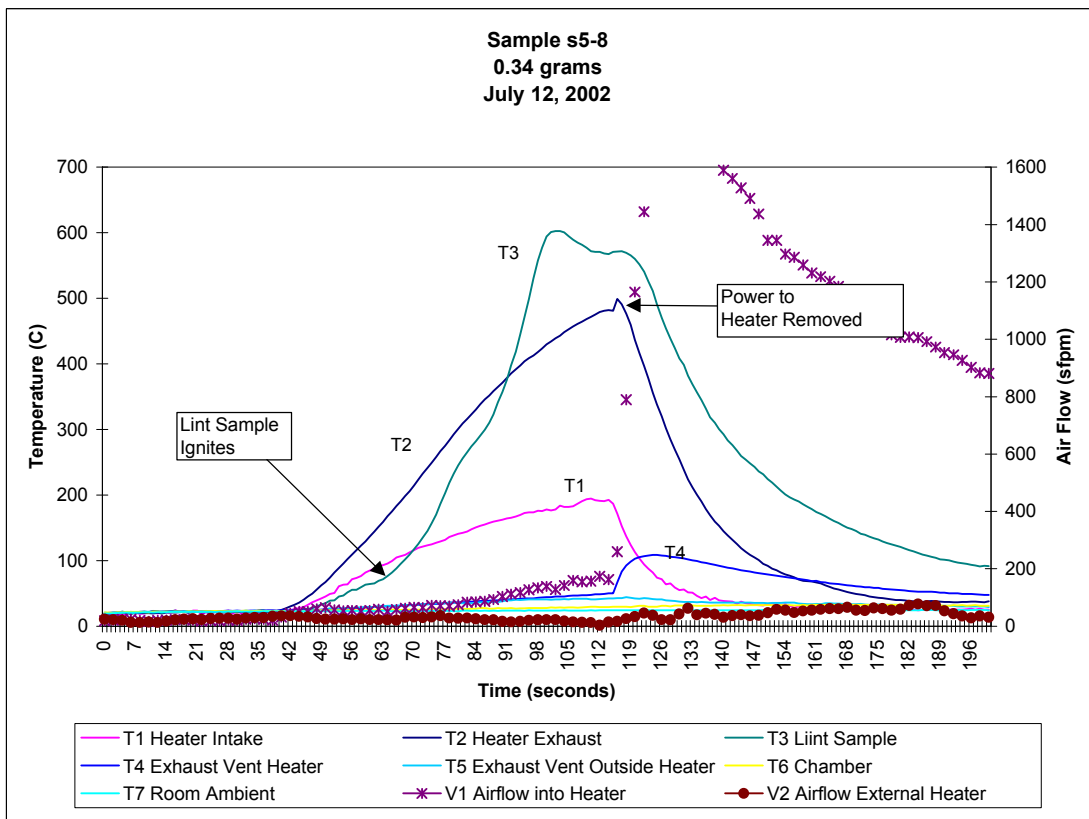

Figure 57. Thermocouple Data for Sample s5-8

In the last three tests, the high-limit thermostat was connected in series with the heating element. In the test for sample s5-11, the power was applied instantaneously to the heating element, and the sample smoldered until the high-limit thermostat opened and disconnected power to the heating element. For samples s5-12 and s5-13, the intake airflow into the heater

was 300 and 200 sfpm, respectively. The samples smoldered until the high-limit thermostat opened and disconnected power to the heating element.

#### 2.4.3.2 Side of the Heater Housing

Twenty-two tests were conducted with samples placed at three different locations (C, D, and E) on one side of the heater housing. All the samples were held in place with a finger probe. Three of the tests were conducted using lint samples obtained from a consumer's dryer and are labeled as "hl" in Tables 10 and 11 below.

Table 9 provides a list of the lint ignition tests that were conducted at location C on the side of the heater housing. The high-limit thermostat was bypassed in all tests conducted at location C. The lint samples used measured approximately 2 x 2 x ¼ inches and weighed approximately 0.30 grams. The samples were 100% cotton lint taken from the lint screen collected during Task 3 testing. The table includes the weights of the lint samples tested, test conditions, and the observed results.

Table 9. Testing on the Side of the Heater Housing at Location C

Location	Number	Weight (grams)	Power	Intake Airflow (sfpm)	Outside Airflow (sfpm)	High-Limit Thermostat	Result
C	s2-7	0.32	instant	650 → 0@400s	40	bypassed	ignited
C	s5-2	0.32	instant	0	40	bypassed	smolder
C	s5-3	0.32	instant	650 → 0@400s	40	bypassed	smolder
C	s5-4	0.30	instant	650 → 0@400s	40	bypassed	smolder

Four samples were tested at location C. Three of the samples (s5-2, s5-3 and s5-4) smoldered, and one (s2-7) ignited.

Lint sample s2-7 was tested at location C, as shown in Figure 58. The T3 thermocouple was placed above the sample as an indicator of ignition. Figure 59 graphs the temperatures and airflow obtained during the test. Sample s2-7 was tested with 650 sfpm airflow (V1) initially through the heater box. At 400 seconds, the blower for the V1 airflow was stopped, and the temperature inside the heater rose rapidly, as expected. The sample ignited approximately 90 seconds after the blower was stopped.

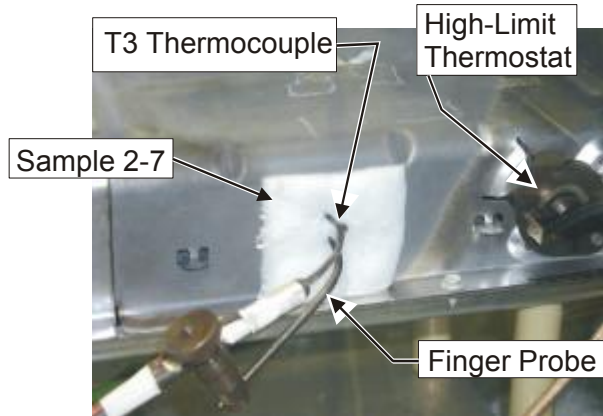

Figure 58. Sample s2-7 on the Side of the Heater Housing at Location C

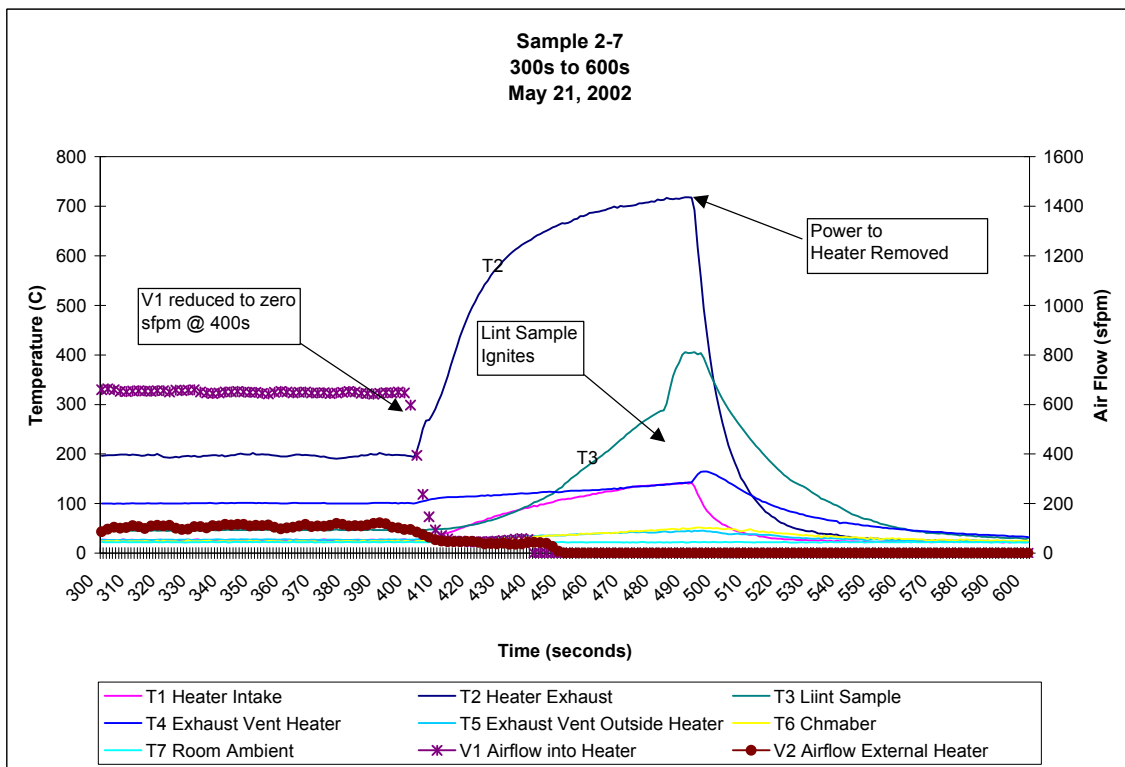

Figure 59. Sample s2-7 Thermocouple Traces

Table 10 provides a list of the lint ignition tests that were conducted at location D, which was adjacent to the high-limit thermostat. The table includes the weights of the lint samples tested, test conditions, and the observed results.

Table 10. Testing on Top of the Heater Housing at Location D

Location	Number	Weight (grams)	Power	Intake Airflow (sfpm)	Outside Airflow (sfpm)	High-Limit Thermostat	Result
D	s1-5	0.30	instant	0	43	bypassed	ignited
D	s2-1	0.35	instant	650, 0@500s	43	series	charred
D	s2-1f	0.35	instant	0	43	bypassed	smolder
D	s2-2	0.35	instant	0	43	bypassed	smolder
D	hl1-1*	0.36	instant	0	43	bypassed	smolder
D	s5-5	0.31	instant	0	40	bypassed	smolder

\* Consumer lint

Six lint samples were tested at Location D, as shown in Figure 60. The samples were held in place using a single finger probe. The T3 thermocouple was placed on the lint sample as an indicator of lint ignition. Four of the samples smoldered, one charred, and one ignited.

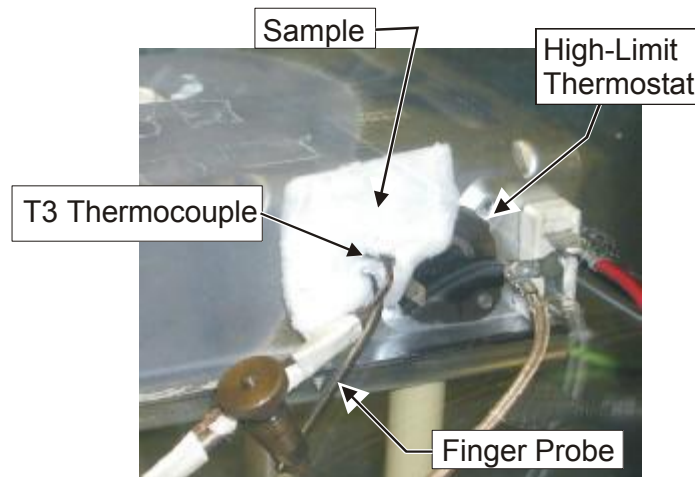

Figure 60. Sample s2-2 Tested at Location D

In five of the tests, including one using lint material from a consumer's home, the high-limit thermostat was bypassed, and there was no airflow through the heater box. Four of the tests resulted in smoldering of the lint sample (s2-1f, s2-2, hl1-1, and s5-5), and in one test, the sample ignited (s1-5).

In a sixth test with the high limit thermostat in series with the heater, the lint sample charred (s2-1). The initial airflow was at 650 sfpm; at 400 seconds, the airflow was dropped to 0 sfpm. The sample charred until the high-limit thermostat opened and disconnected power to the heating element.

Table 11 below provides a list of the lint ignition tests that were conducted at location E, which was at a tab opening (punch-out) used to hold the heating element. Twelve tests were conducted at this location. The table includes the weights of the lint samples tested, test conditions, and the observed results.

Table 11. Testing on the Side of the Heater Housing at Location E

Location	Number	Weight (grams)	Power	Intake Airflow (sfpm)	Outside Airflow (sfpm)	High-Limit Thermostat	Result
E	s1-6	0.35	instant	0	43	bypassed	ignited
E	s1-7	0.31	instant	800	40	bypassed	charred
E	s1-7f	0.31	instant	step down	40	bypassed	smolder
E	s2-3	0.36	instant	0	43	bypassed	ignited
E	hl1-2*	0.26	instant	0	43	bypassed	ignited
E	s2-4	0.37	instant	0	43	bypassed	ignited
E	hl1-3*	0.40	instant	650 → 0@400s	43	bypassed	smolder
E	s2-5	0.38	instant	650 → 0@400s	43	bypassed	ignited
E	s2-6	0.39	instant	650 → 0@400s	43	bypassed	ignited
E	s3-1	0.35	instant	0	43	bypassed	ignited
E	s5-6	0.29	instant	0	40	bypassed	ignited
E	s5-7	0.39	instant	0	40	bypassed	ignited

\* Consumer lint

In seven of the tests, including one using consumer lint material, the airflow into the heater was 0 sfpm, and power to the heating element was applied instantaneously. All seven samples ignited (s1-6, s2-3, hl1-2, s2-4, s3-1, s5-6 and s5-7).

Three tests were conducted with the airflow initially set at 650 sfpm; and at 400 seconds, airflow was dropped to 0 sfpm. Two samples (s2-5, s2-6) ignited, and the consumer lint sample (hl1-3) smoldered.

Figure 61 shows sample s2-6 before and after it ignited. Figure 62 shows the thermocouple traces for sample s2-6. The T3 thermocouple shows when the lint sample ignited by the rapid increase in temperature. The sample ignited approximately 60 seconds after the blower was turned off.



Sample 2-6

Before



Sample2-6

Ignition

Figure 61. Sample s2-6 Tested at Location E

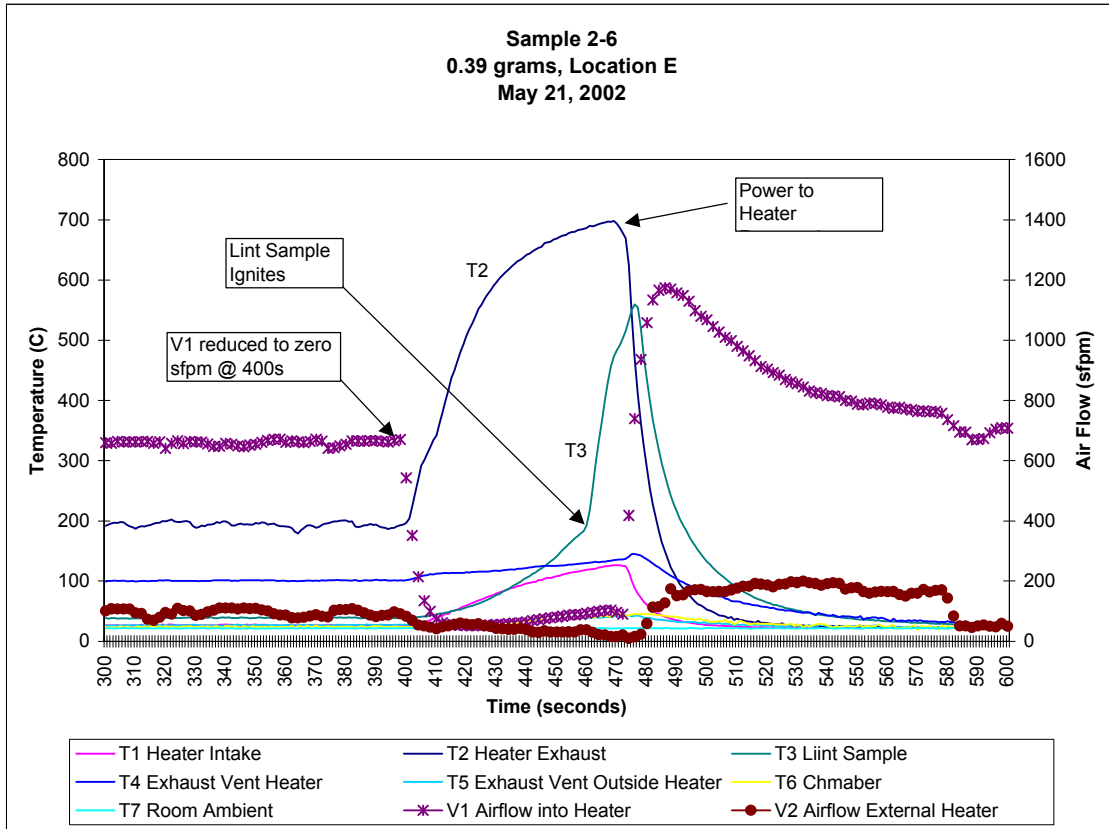

Figure 62. Thermocouple Traces for Sample s2-6 at Location E

A single test was conducted with the airflow set at 800 sfpm. The sample (s1-7) charred slightly. The last test was conducted with the voltage to the heating element stepped down incrementally; the sample (s1-7f) smoldered (Appendix F shows the temperature and airflow data for sample s1-7f).

#### 2.4.3.3 Lint Samples at the Heater Intake

Lint samples were placed at various distances from the heater intake, as shown in Figure 63. The samples were approximately 1" x 1" x 1/4" and weighed approximately 0.20 grams. The samples were held in place by a finger probe. The T3 thermocouple was placed above the sample as an indicator of ignition (Appendix G illustrates the setup).

The lint samples were placed at 1-inch increments from the front edge of the heater housing. The distance from the heating element to the edge of the heater housing was 2 inches.



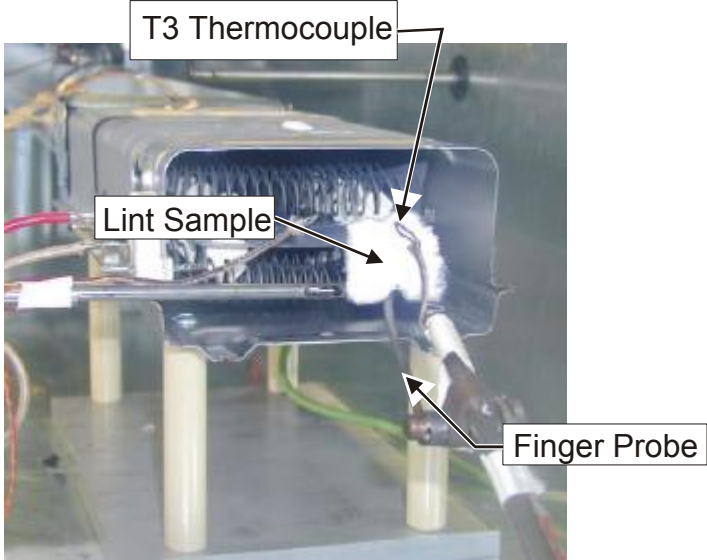

Figure 63. Lint Sample at Heater Intake

An infrared camera was positioned to view the lint samples, as shown in Figure 64, and was used to capture the temperature of the lint during the test. Infrared data was not captured for all of the lint samples tested.

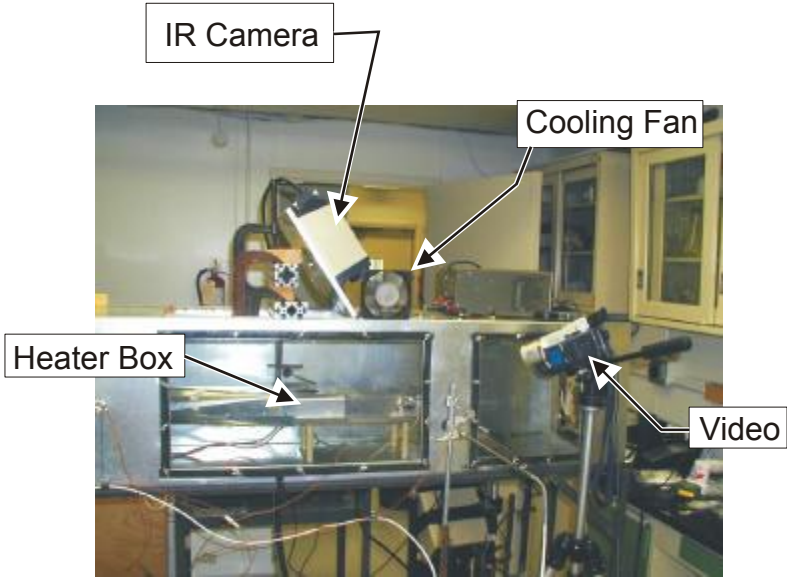

Figure 64. Infrared Camera Setup

US CONSUMER PRODUCT SAFETY COMMISSION  
FINAL REPORT ON ELECTRIC CLOTHES DRYERS AND LINT IGNITION CHARACTERISTICS  
May 2003

For the following test series, the airflow outside the heater boxes for the different dryer designs measured between 0 and 43 sfpm depending on whether the exhaust vent was blocked or unblocked. The airflow over the heater box/housing was set at approximately 43 sfpm to simulate a slight airflow caused by the drum rotating and intake into the heater.

The first series of tests was conducted with no airflow through the heater box and the high-limit thermostat bypassed. In this series of tests, the lint samples ignited at a distance ranging from 3 to 4 inches from the housing edge.

A second series of tests was conducted similar to the first set, except that the high-limit thermostat was connected in series with the heating element. The samples ignited at a distance between 1 to 2 inches from the housing edge.

A third series of tests was conducted similar to the second series but with airflow through the heater box. The lint samples were fixed at a distance of one inch from the heater edge. The samples ignited when the airflow at the heater intake was between 300 and 400 sfpm.

A single test was conducted with a lint sample placed 1-inch from the edge of the heater housing, the high-limit thermostat bypassed, and the airflow through the heater box set at 400 sfpm. The lint sample ignited.

Table 12 lists the tests conducted with lint samples at the heater intake. The list is presented in chronological order (the order in which the tests were conducted). The distance is the number of inches from the heater housing edge to the front face of the sample. The column labeled High-Limit Thermostat indicates whether the thermostat was connected in series with the heating element or not ("yes" means the thermostat was connected in series; "no" means the thermostat was bypassed.)

Table 12. Lint Samples at the Heater Intake

Lint Sample #	Weight (grams)	Distance (inches)	High-Limit Thermostat	Airflow (sfpm)	Result
s3-2	0.19	2	no	0	ignition
s3-3	0.20	3	no	0	ignited
s3-4	0.18	4	no	0	no ignition
s3-5	0.19	2	no	0	ignited
s3-6	0.18	2	no	0	ignited
s3-7	0.19	2	no	0	ignited
s3-8	0.18	2	no	0	ignited
s3-9	0.19	3	no	0	ignited
s3-10	0.16	3	no	0	ignited
s3-11	0.21	4	no	0	no ignition
s3-12	0.16	4	no	0	no ignition
s3-13*	0.19	2	yes	0	ignited
s3-14	0.16	2	yes	0	no ignition
s3-15	0.19	0	yes	0	ignited
s3-16	0.18	1	yes	0	ignited
s3-17	0.17	1	yes	0	ignited
s3-18	0.18	2	yes	0	no ignition
s3-19	0.19	1	yes	200	ignited
s3-20	0.21	1	yes	400	no ignition
s1-8	0.21	1	yes	300	ignited
s1-9	0.20	0	yes	400	no ignition
s1-10	0.21	1	no	400	ignited

\* The high-limit failed; s3-13 is later discussed in the Discussion Section, Task 4

Figure 65 shows a sequence of images from the infrared camera and a video camera for Sample s3-10. The figure shows the lint sample began to ignite at approximately 452° C. Figure 66 shows the thermocouple data for sample s3-10. The sample ignited 1 minute 11 seconds into the test. The sample ignited approximately 40 seconds after the heater was energized.

US CONSUMER PRODUCT SAFETY COMMISSION  
FINAL REPORT ON ELECTRIC CLOTHES DRYERS AND LINT IGNITION CHARACTERISTICS  
May 2003



Sample 3-10

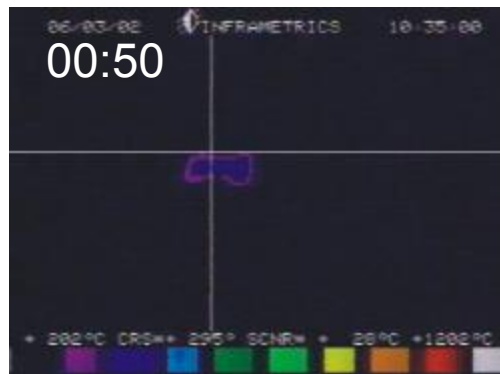

Sample 3-10



Sample 3-10

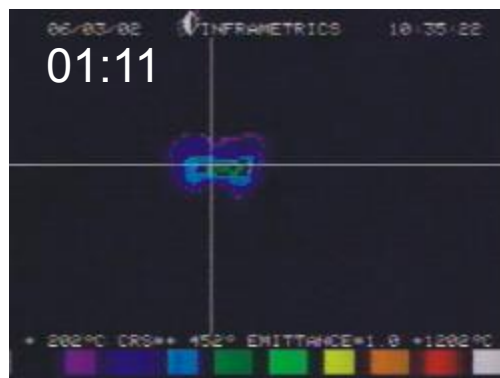

Sample 3-10

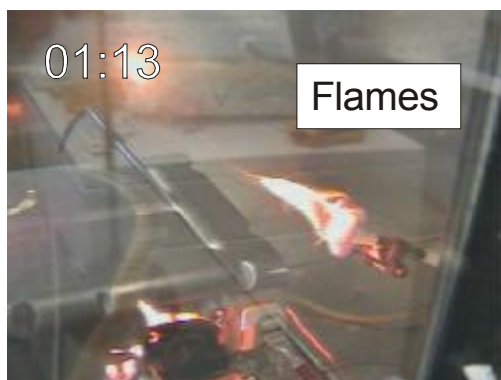

Sample 3-10

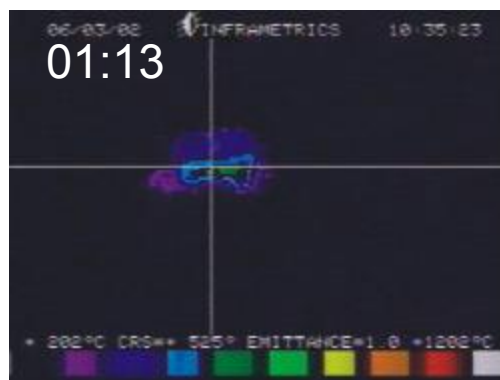

Sample 3-10

Figure 65. Sample s3-10, Video Camera and Infrared Camera

US CONSUMER PRODUCT SAFETY COMMISSION  
FINAL REPORT ON ELECTRIC CLOTHES DRYERS AND LINT IGNITION CHARACTERISTICS  
May 2003

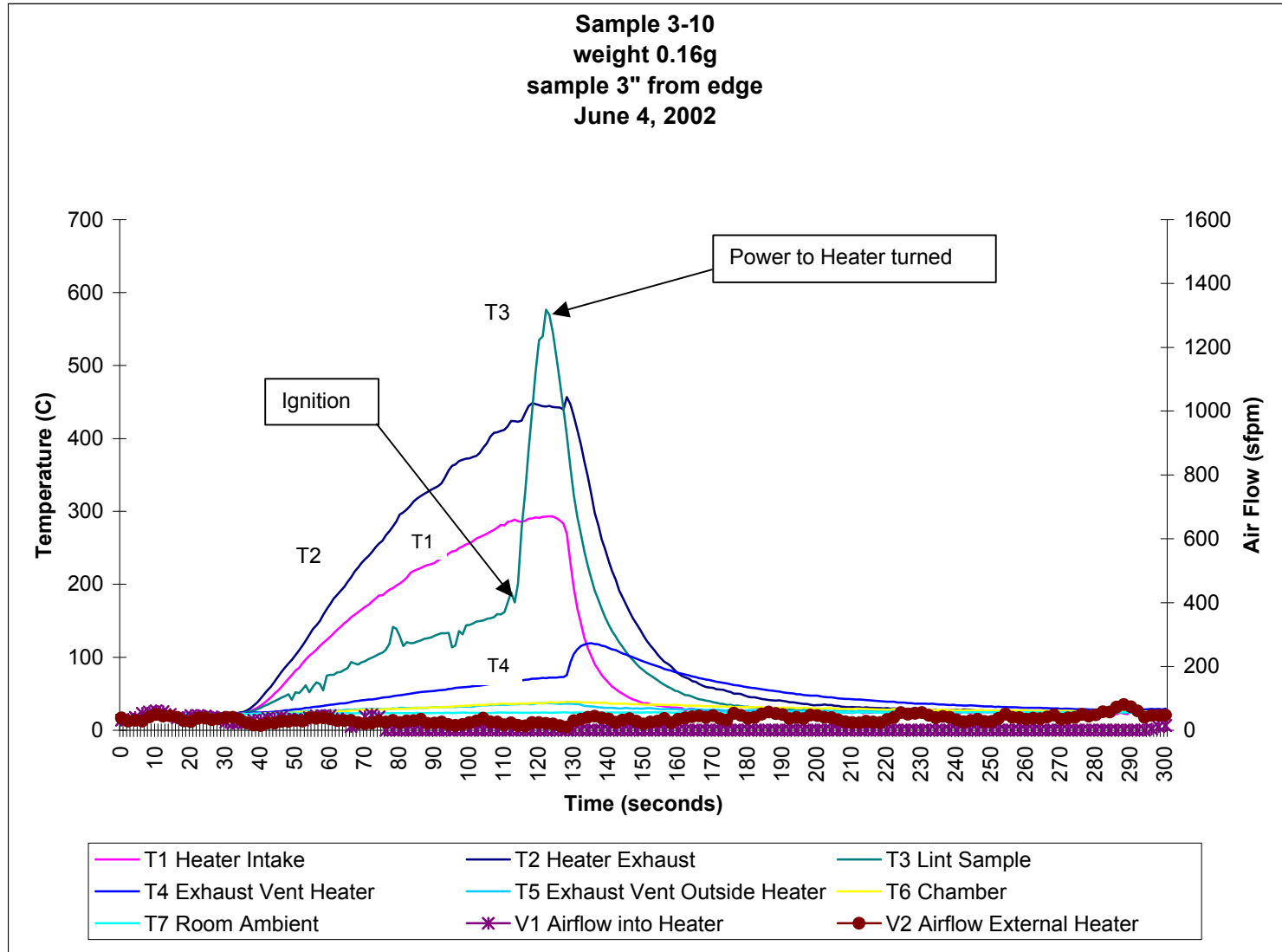

Figure 66. Sample s3-10 – Thermocouple and Airflow Data

#### 2.4.4 Phase II – Ignition Characteristics of Lint Ingested into the Heater Box

This phase of testing was divided into two parts. Part 1 of the tests involved observation of the heater exhaust as the lint samples of varying weights and sizes were ingested into the heater box. Part 2 was to observe whether target materials downstream of the heater exhaust could be ignited by embers as they exited the heater exhaust.

The test setup was designed to allow the airflow into the heater intake to carry lint samples past the heating element and exhaust any embers through the ducts. To observe the heater exhaust, a 28-inch section of the metal duct from Phase I tests was replaced with a 4” diameter high-temperature glass tube, as shown in Figure 67. (The actual dimensions for the test setup can be found in Appendix H.)

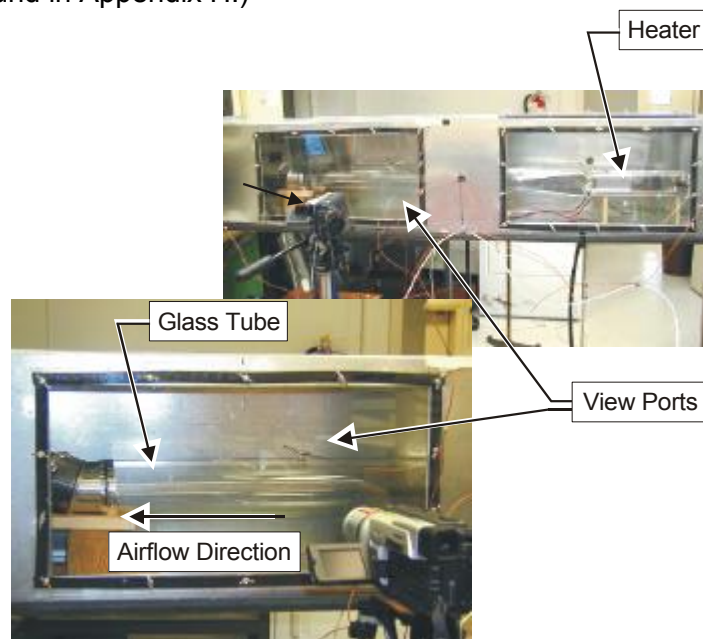

Figure 67. Setup with Glass Tube

##### 2.4.4.1 *Part 1 – Lint Samples Ingested by the Heater Box*

For these tests, different weights and sizes of lint were drawn into the heater box. Six series of tests were completed:

1. The first series included 5 samples weighing between 0.24g and 0.77g.
2. The second series consisted of 8 samples weighing between 0.04g and 0.18g.
3. The third series consisted of 5 samples weighing between 0.14g and 0.48g.
4. The fourth series consisted of 10 samples at  $0.10 \pm 0.10$  grams.
5. The fifth series consisted of 10 samples at  $0.20 \pm 0.10$  grams.
6. The sixth series consisted of 10 samples at  $0.30 \pm 0.10$  grams.

Table 13 below lists the six series of tests and the lint sample weights used in each.

Table 13. Lint Samples for Task 4 - Phase II Testing  
 (Observation of Samples Ingested into Heater Box)

Series Number	Sample Number	Weight (grams)
1	1	0.24
	2	0.37
	3	0.38
	4	0.64
	5	0.77
2	1	0.18
	2	0.18
	3	0.04
	4	0.10
	5	0.07
	6	0.06
	7	0.11
	8	0.08
3	1	0.48
	2	0.43
	3	0.27
	4	0.25
	5	0.14
4	1 to 10	0.10
5	1 to 10	0.20
6	1 to 10	0.30

For all tests conducted, embers were visible exiting the heater box. The embers varied in size and number. It was observed that larger lint samples produced more and/or larger embers than smaller lint samples did, but two lint samples of the same size did not produce the same ember size and/or number of embers. The number and size of the embers in the heater exhaust were dependent on how and where the lint samples contacted the heating element. For example, if the lint sample became trapped on the heating element, smaller embers were produced in the exhaust as the sample burned. However, if the sample contacted the heating element, ignited, and continued through the heater box, larger embers were observed exiting the heater exhaust.

#### *2.4.4.2 Part 2 – Ignition of Target Materials Downstream from the Heater Exhaust*

Four series of tests were conducted to observe whether target materials downstream of the heater exhaust could be ignited by embers as they exited the heater exhaust. Target materials were placed inside the glass tube, as shown in Figure 68. After the target material was placed in the glass tube, lint samples were drawn into the heater box approximately every 3

to 4 seconds. The airflow was set at 800 sfpm at the heater intake. This airflow velocity simulated the airflow inside a dryer near the end of the drying cycle (when the dryer would have a full lint screen). For each of the four tests, the lint samples drawn into the heater box consisted of ten samples of 0.10g each, then 10 samples of 0.20g each and, finally, ten samples of 0.30g.

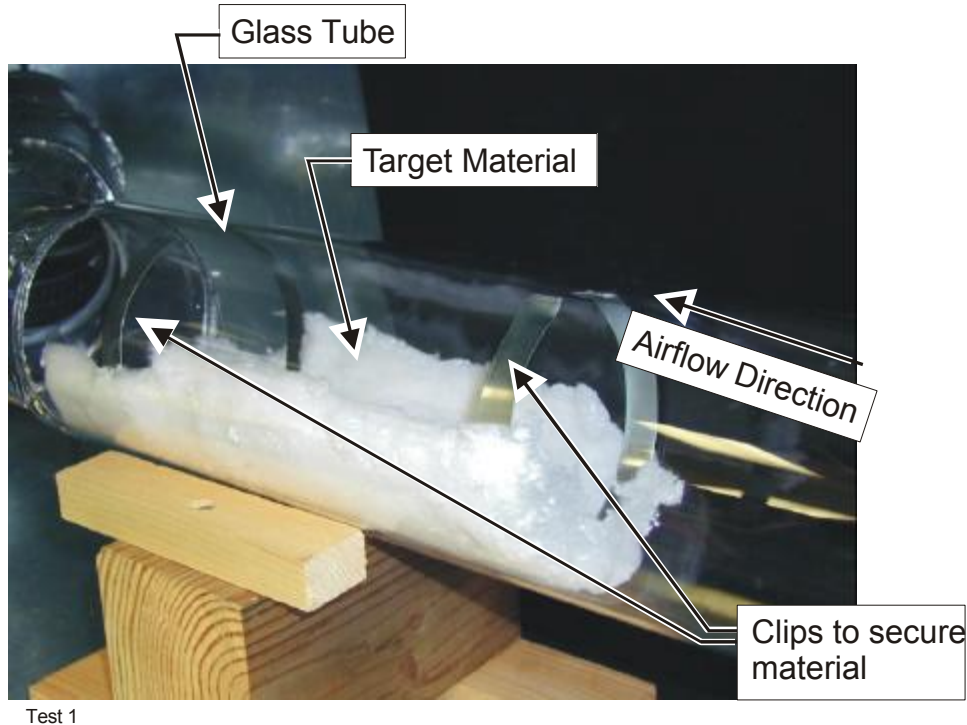

Figure 68. Setup with Target Material in the Glass Tube

Table 14 outlines the types, sizes and weights of the target materials used for each test series. The target samples were either sheets of 100% cotton lint or cotton terry towel material. The lint target samples weighed between 2 and 5 grams and measured approximately 6 x 10 inches. The lint target material varied in thickness from 1/8 to 1/2 inch. The lint target materials were collected during Task 3 testing. The cotton terry towel material was a section cut from a towel used in Task 3 testing; the section measured 7 1/2 x 10 inches and weighed 35.2 grams.

Table 14. Target Materials for Task 4 - Phase II Testing  
 (Ignition of Target Materials by Exhaust Embers)

Test Number	Target Material	Size (inches)	Weight (grams)
1	Lint Sheet	10 x 6 1/2 x 1/2 to ~	5.08
2	Lint Sheet	7 x 5 1/2 x 1/2 x ~	3.04
3	Lint Sheet	7 1/2 x 6 1/4 to ~	2.08
4	Cotton Towel	7 1/2 x 10	35.20



In all four tests, the target material ignited:

1. In Test 1, the target material ignited on the fifth lint sample of 0.10 g.
2. In Test 2, the target material ignited on the sixth sample of 0.20 g.
3. In Test 3, the target sample ignited on the tenth sample of 0.10 g.
4. In Test 4, the target material ignited on the eighth sample of 0.30 g.

Figure 69 shows the target sample igniting during Test 1. The sample was consumed in less than 6 seconds and produced additional embers downstream. The exhaust temperature, T4 thermocouple, increased to over 260° C in less than 5 seconds, as shown in Figure 70. (Test data for Tests 2, 3, and 4 are contained in Appendix H. Video clips of the lint sample testing are included in Appendix J.)

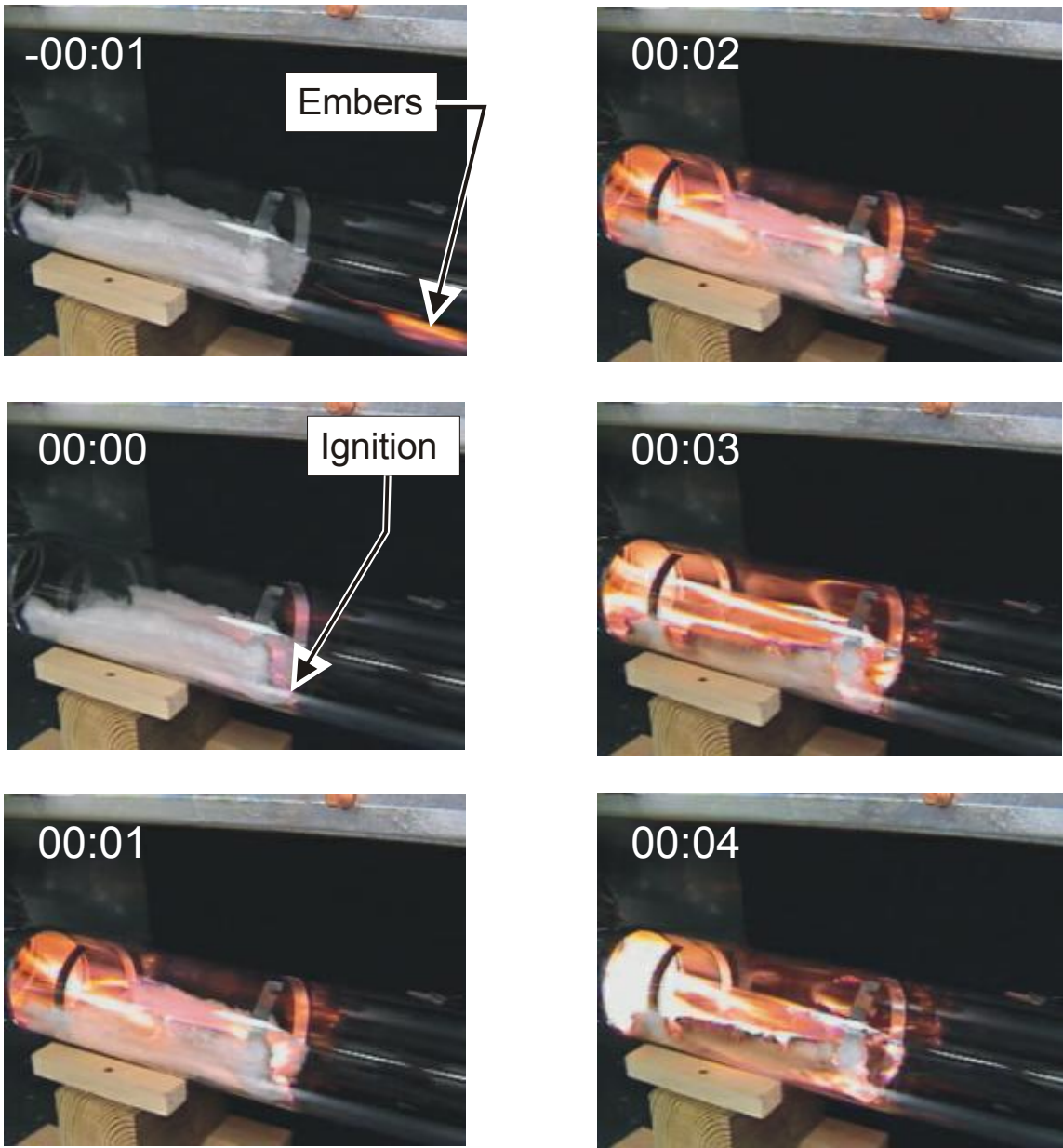

Figure 69. Target Sample Igniting During Test 1

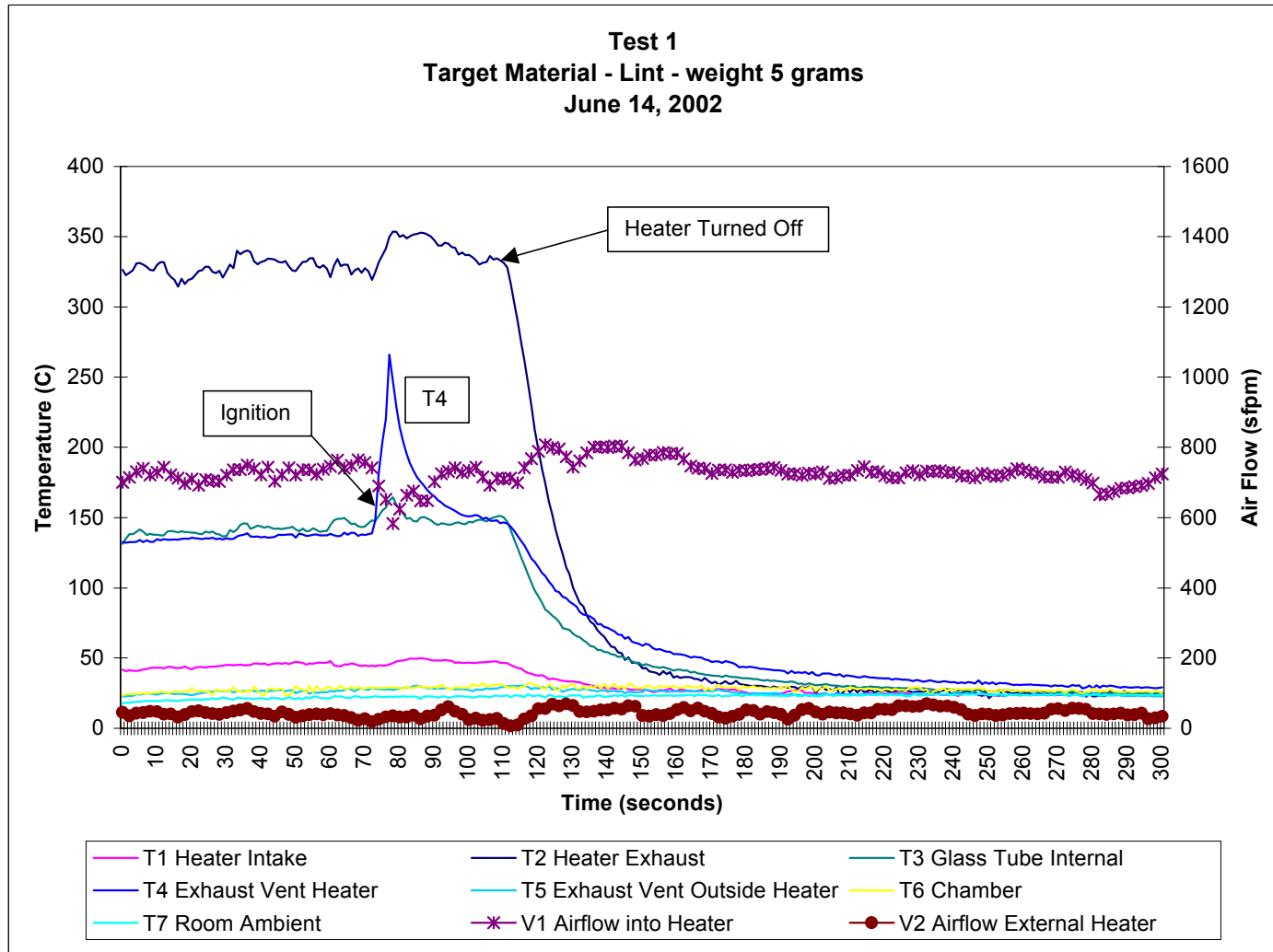

Figure 70. Test 1 – Thermocouple and Airflow Measurements Task 4- Test 1  
 (Ignition of Target Materials by Exhaust Embers)

## 3.0 DISCUSSION

This section of the report presents a discussion of the tests and the test results reported in *Section 2.0 Description of Test and Test Results* for each of the four project tasks. Each discussion section is supported by its corresponding section in Section 2.0, unless otherwise specified.

### 3.1 Task 1: Inspect and Record Dryer Design

Four clothes dryers (Dryer Designs A, B, C and D) were used for testing. As part of each dryer's exhaust system, there was a 4-inch diameter male duct, a short length of which protruded outside the dryer housing. This short length of duct was slightly tapered and was intended for connection to external venting (the external vent slid over the tapered male duct). The external vent material used for the clothes dryers was 4-inch diameter rigid metal ducting, as recommended in the manufacturers' installation instructions.

The interface of the male duct and the external venting was sealed and/or secured with a 4-inch hose clamp. The hose clamp nut was tightened by hand with a nut driver until it could not be tightened any further. The amount of torque applied to the hose clamp nut had little effect on actually tightening the connection between the male duct and the external vent. Two factors contributed to the poor seal:

1. The length of the dryer's male duct (which varied slightly among the designs) was insufficient to allow the external vent to slide far enough onto the duct to provide a secure pressure fit.
2. Both mating pieces were rigid; thus, the external venting could not compress around the dryer's male duct when the hose clamp was tightened.

(Additional comments regarding dryer designs are included in the Discussion section of Task 3: Monitor Lint Distribution.)

### 3.2 Task 2: Document Dryer Operating Characteristics

Testing showed that each dryer design reacts slightly differently when the exhaust vent is unblocked, partially blocked, or 100% blocked. The data for temperature and airflow varied slightly with each dryer, but certain characteristics were similar for all the dryer designs tested.

#### 3.2.1 Normal Operation (Unblocked Exhaust Vent)

When the dryers were tested with an unblocked exhaust vent, similar temperatures – the intake air temperature into the heater, the heater housing temperature, the intake air temperature into the blower, and the exhaust vent temperature – were measured among all dryer designs. Figures 71 through 75 show comparisons of temperatures measured for each of the dryer designs when tested with a wet load. Dryer Design D used only 7 towels so that the dryer would not operate in the high-limit cycling mode. (Additional graphs demonstrating dryer design comparisons can be found in Appendix I).

Figure 71 shows that the heater intake temperature (T1) was higher for Dryer Design C than for other dryer designs, and it reached a maximum of 75°C. Dryer Designs A and C exhibited similar maximum temperatures before the primary thermostat opened. Dryer Design B had a slightly lower maximum temperature. Since the load in Dryer Design D began riding the drum after approximately 1900 seconds, the airflow through the tumbler was less restricted causing the primary thermostat to reach its opening set point sooner.

Figure 72 shows the heater housing temperatures did not extend much higher than 120°C for all the dryer designs tested. The housing temperatures for Dryer Designs A and D were similar – until the load in Dryer Design D stopped tumbling after approximately 1900 seconds. The heater housing in Dryer Design B had a significant number of punch-outs on one side, which were used to mount the heating element inside the heater housing. This appeared to allow the heater housing to operate at a slightly cooler temperature than either Dryer Design A or D. Dryer Design C had louvers on one side of the heater housing; this allowed the heater housing to operate at an even lower temperature – approximately 66°C, as shown in the graph.

Figure 73 shows the intake temperature into the blower for all the dryer designs tested. The temperatures are very similar for all the dryers, as shown in the graph. The intake temperature into the blower did not extend much higher than 100°C for all the dryer designs tested. Dryer Design A and D had a slightly higher operating curve than the other dryers. The load in Dryer Design D began to stop tumbling at approximately 1900 seconds after the dryer was started, as shown in the graph.

Figure 74 shows the exhaust vent temperatures for all the dryer designs tested. The temperatures are very similar for all the dryers, as shown in the graph. The exhaust venting temperature did not extend much higher than 70°C for all the dryer designs tested. The exhaust vent temperatures for Dryer Design A were slightly higher than those for the other dryers.

Figure 75 shows the maximum temperatures measured at each thermocouple location for each dryer design. All the dryers had similar temperatures at each thermocouple location, except at the heater exhaust and tumbler intake. Design characteristics had a contributing factor on temperatures at these locations. Dryer Design C had an increase in temperature from the heater exhaust to the tumbler intake, which was also observed during testing in Task 2. The louvers on the side of the heater housing may have contributed to the higher temperature readings at T6, but it has not yet been determined why this actually occurred.

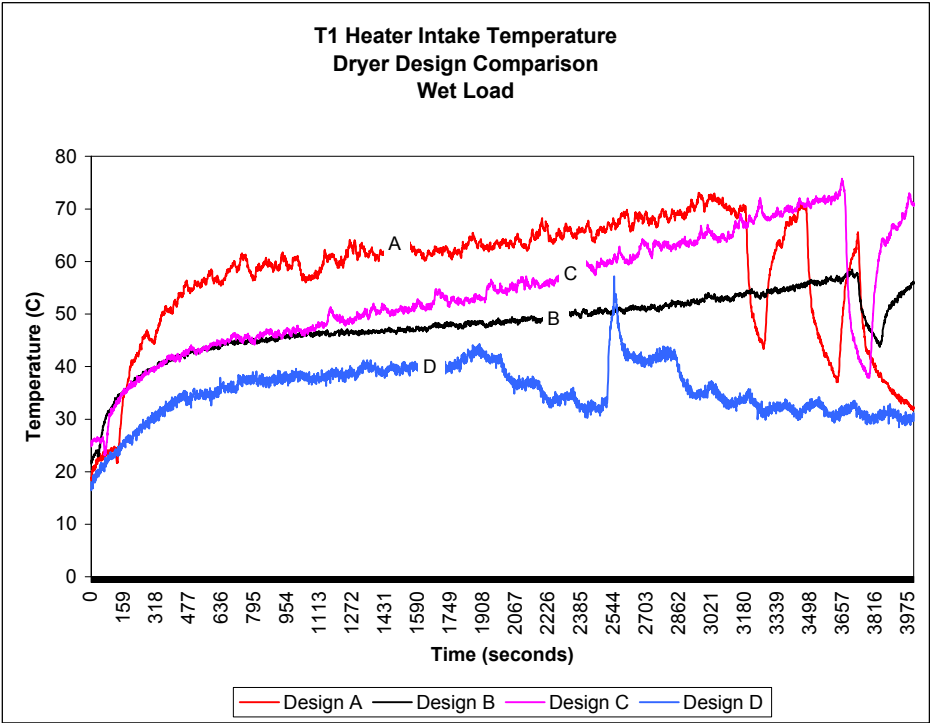

Figure 71. Dryer Design Comparison for T1, Heater Intake

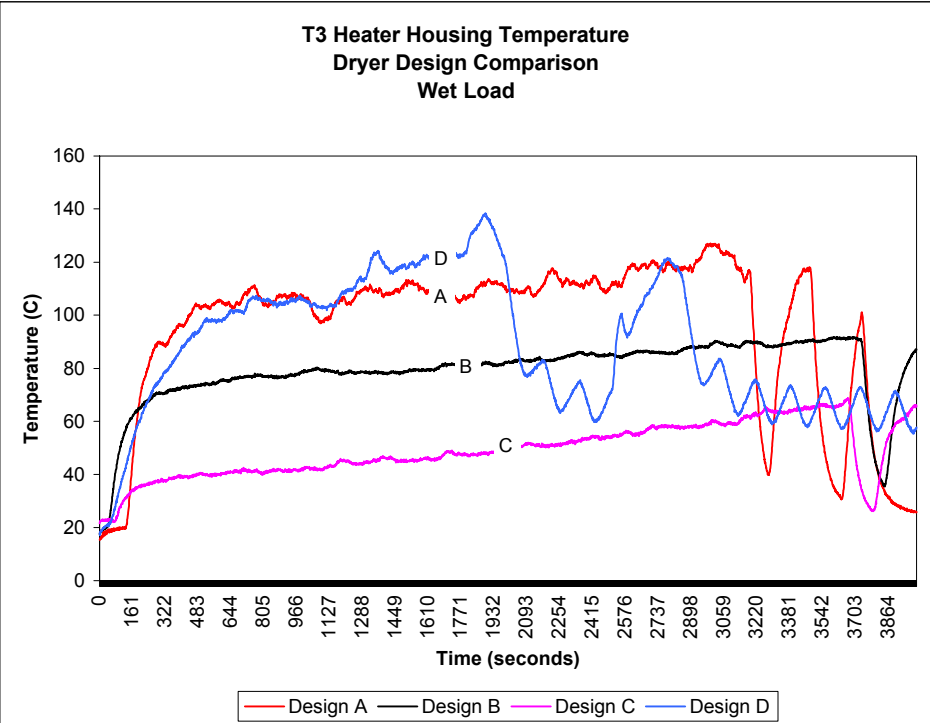

Figure 72. Dryer Design Comparison for T3, Heater Housing

US CONSUMER PRODUCT SAFETY COMMISSION  
FINAL REPORT ON ELECTRIC CLOTHES DRYERS AND LINT IGNITION CHARACTERISTICS  
May 2003

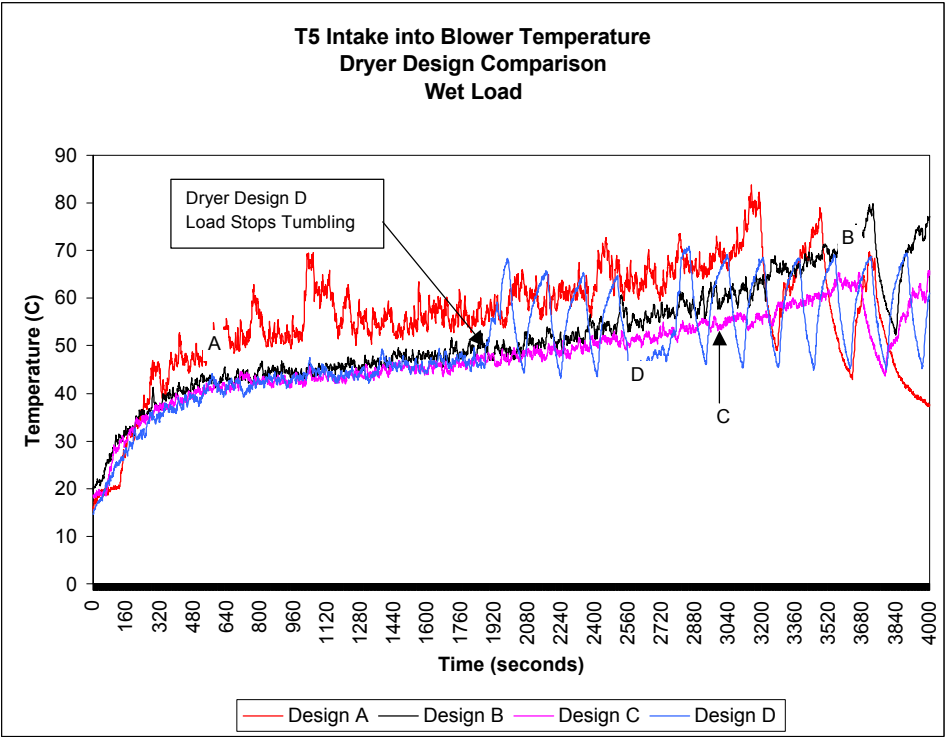

Figure 73. Dryer Design Comparison for T5, Blower Intake

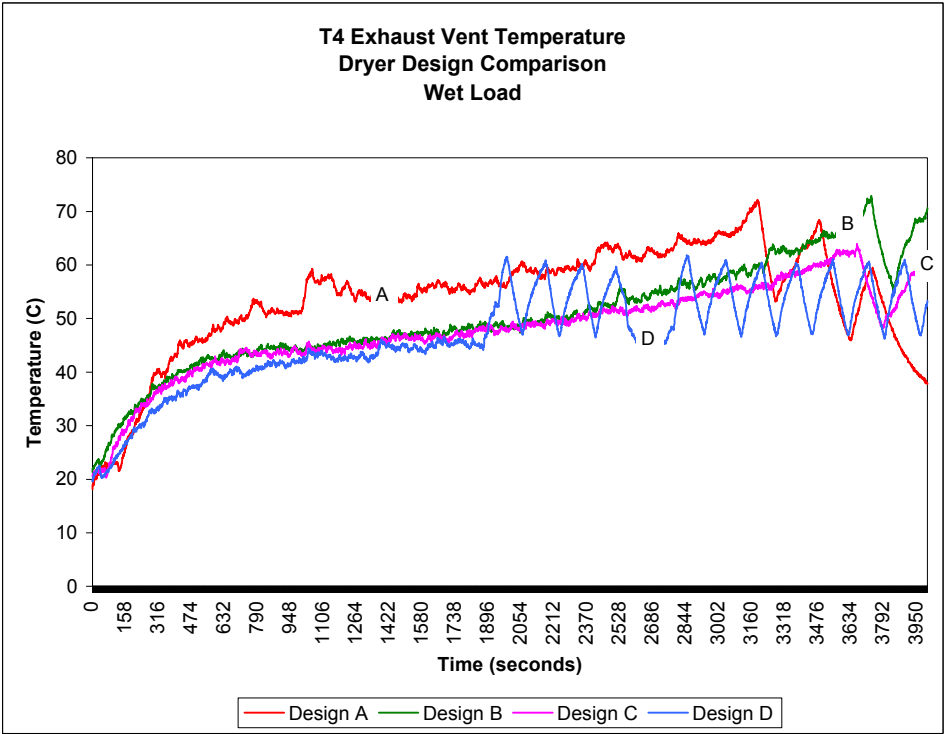

Figure 74. Dryer Design Comparison for T4, Exhaust Vent

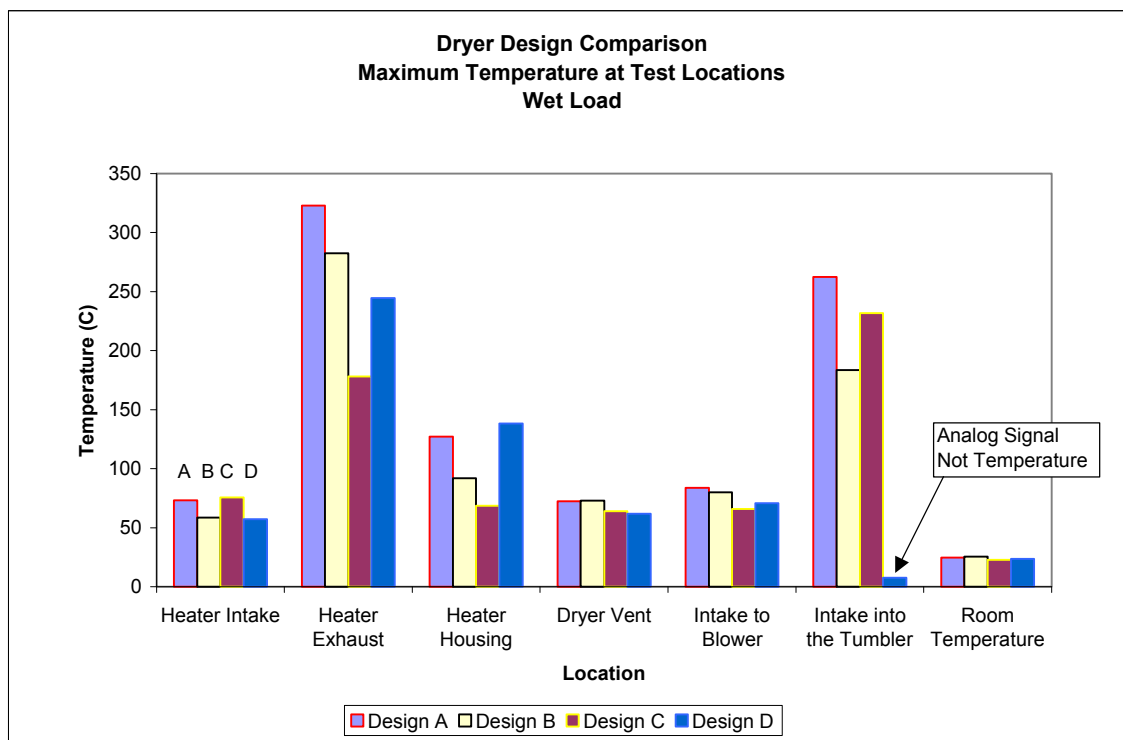

Figure 75. Maximum Temperatures Measured at Location

### 3.2.2 Partially-Blocked and 100%-Blocked Conditions

Each dryer design reacted slightly differently when the exhaust vent was partially blocked and/or 100% blocked. The responses for each dryer design were discussed in Task 2 of the Testing section. The discussion below examines the general characteristics of a dryer by analyzing the data without compensating for variances in dryer designs. The data presented in this section are in general terms and do not represent a specific dryer tested.

The data was generated from Dryer Design A/dry load, Dryer Design B/wet load, Dryer Design C/wet load, and Dryer Design D/no load. Dryer Design A/dry load was used since the operating temperatures for a dry load were similar to a wet load, although the time scale was different. Dryer Design D/no load was used to avoid using data in which the dryer quickly began operating in the high-limit cycle mode for a full load or in which operation was unpredictable (the load stopped tumbling).

The maximum temperatures measured for each dryer for each test condition (blocked exhaust vent, partially blocked vent, or unblocked vent) were extracted from each data set. The temperatures were then categorized as highest, lowest, and average for each set. Figures 76 through 81 show comparisons of maximum temperatures measured at each test location under unblocked conditions, the range of blocked conditions, and with the primary thermostat bypassed.



Figure 76 shows the range of highest to lowest maximum intake air temperatures at the heater for each test condition. The temperatures did not change significantly up to a 50% blockage of the exhaust vent. At 75% blockage, the temperatures (highest, average, and lowest) increased significantly, with the highest temperature measuring over 350°C. The average maximum temperature was slightly over 150°C with a 75% blockage. The maximum temperatures when the exhaust vent was 100% blocked were similar to the 75% blocked condition. The maximum temperatures with the primary thermostat bypassed were similar to the temperatures when the exhaust vent was 50% blocked.

Figure 77 shows the range of highest to lowest maximum heater exhaust temperatures for each test condition. The temperatures did not change significantly from the unblocked exhaust vent condition to a 25% blocked exhaust vent. As the exhaust vent was blocked beyond 25%, there was a slow increase in temperatures. The highest maximum temperature measured nearly 600°C for the 100% blocked condition. The maximum temperatures with the primary thermostat bypassed were similar to the temperatures when the exhaust vent was 75% blocked.

Figure 78 shows the range of highest to lowest maximum heater housing temperatures for each test condition. The temperatures generally showed a slight increase from the unblocked exhaust vent condition to a 50% blocked exhaust vent. When the vent was 75% blocked, the maximum temperatures increased more rapidly. When the exhaust vent was 100% blocked, the maximum temperatures were similar to the temperatures reached for a 75% blocked vent. The highest maximum temperature measured between 200°C and 250°C for the 75% and 100% blocked conditions. The maximum temperatures with the primary thermostat bypassed were similar to those for a 75% blocked exhaust vent.

Figure 79 shows the range of highest to lowest maximum dryer exhaust vent temperatures for each test condition. The temperatures did not change significantly from the unblocked exhaust vent condition to a 50% blocked exhaust vent. Beyond a 50% blockage, the maximum temperatures measured began to drop rapidly. The highest maximum temperature measured dropped from approximately 70°C to 30°C. The maximum temperatures measured when the primary thermostat was bypassed were much higher than those measured for any of the blocked or unblocked exhaust vent conditions. The highest maximum temperature measured was slightly over 100°C.

Figure 80 shows the range of highest to lowest maximum temperatures at the intake into the blower for each test condition. The temperature curves shown in this graph are similar to those for the dryer exhaust vent (Figure 79), although the changes were not as dramatic. Another similarity between Figures 80 and 79 is that, when the primary thermostat was bypassed, maximum temperatures were much higher than those measured for any of the blocked or unblocked exhaust vent conditions. The highest maximum temperature measured was slightly over 120°C.

Figure 81 shows the range of highest to lowest maximum temperatures at the intake into the tumbler for each test condition. The temperature curves shown in this graph are similar to those for the heater exhaust (Figure 77), except that the maximum temperature measured when the exhaust vent was fully blocked was lower – approximately 400°C. Another similarity between Figures 81 and 77 is that, when the primary thermostat was bypassed, maximum temperatures were similar to those for the 75% blocked condition.

US CONSUMER PRODUCT SAFETY COMMISSION  
 FINAL REPORT ON ELECTRIC CLOTHES DRYERS AND LINT IGNITION CHARACTERISTICS  
 May 2003

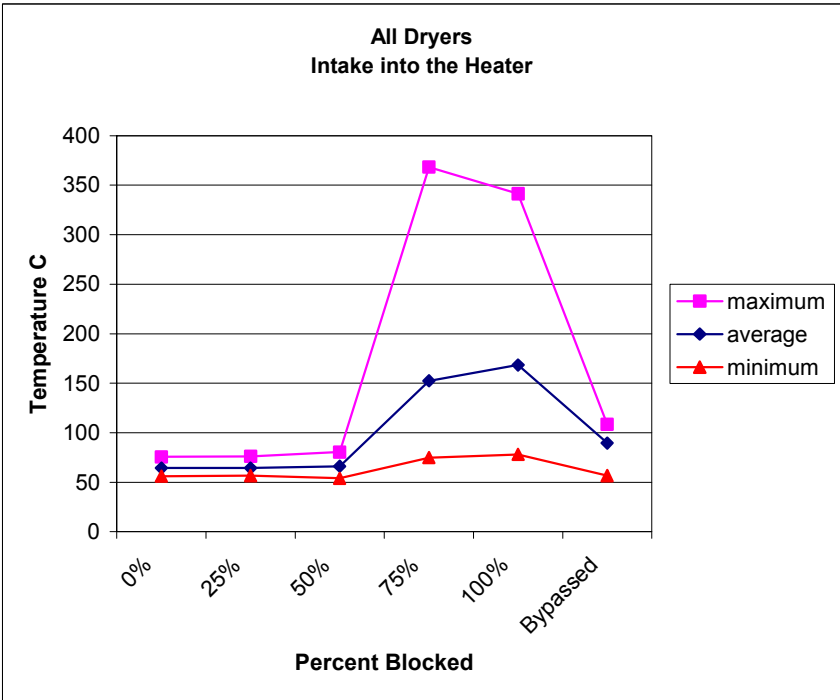

Figure 76. Intake into the Heater

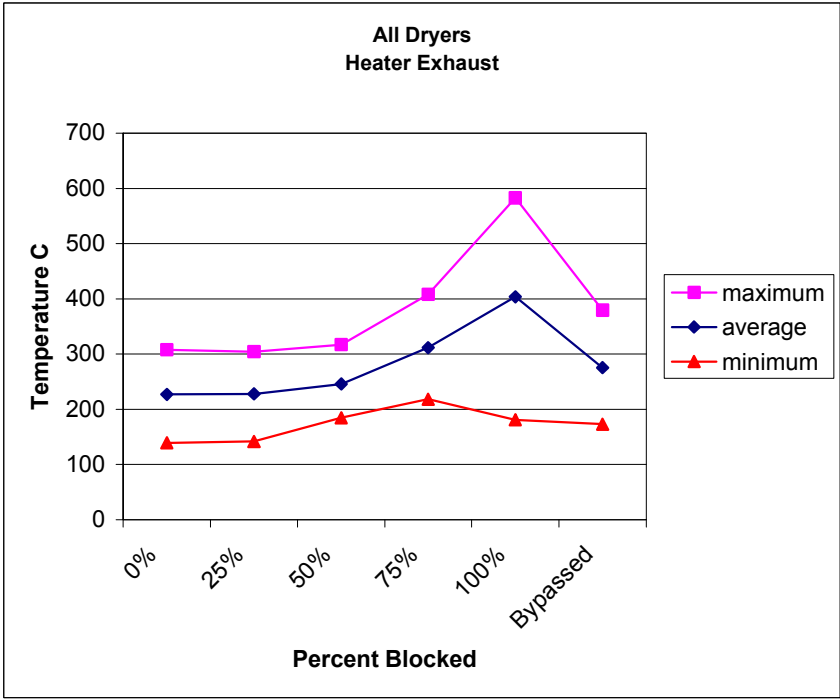

Figure 77. Heater Exhaust Temperature

US CONSUMER PRODUCT SAFETY COMMISSION  
 FINAL REPORT ON ELECTRIC CLOTHES DRYERS AND LINT IGNITION CHARACTERISTICS  
 May 2003

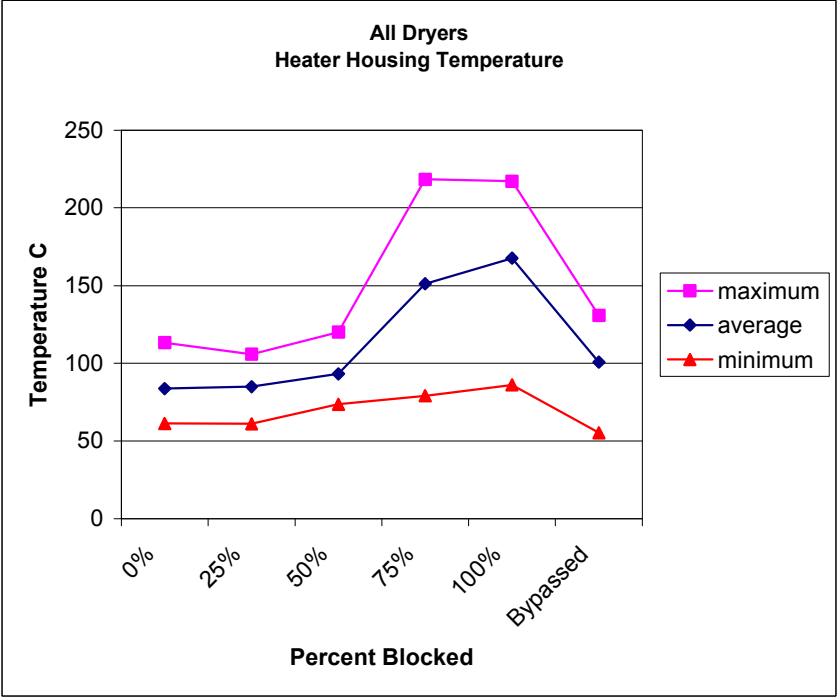

Figure 78. Heater Housing Temperature

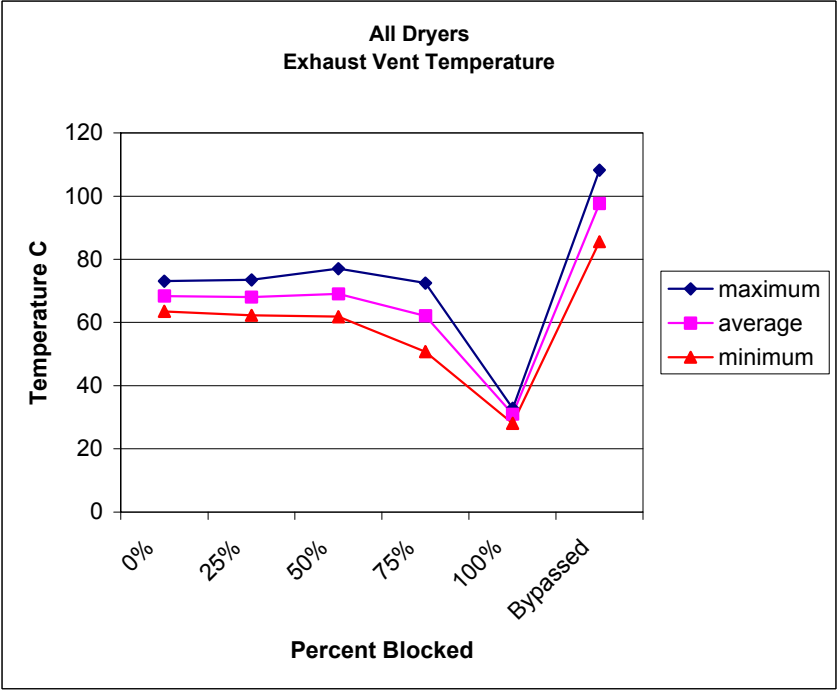

Figure 79. Exhaust Vent Temperature

US CONSUMER PRODUCT SAFETY COMMISSION  
 FINAL REPORT ON ELECTRIC CLOTHES DRYERS AND LINT IGNITION CHARACTERISTICS  
 May 2003

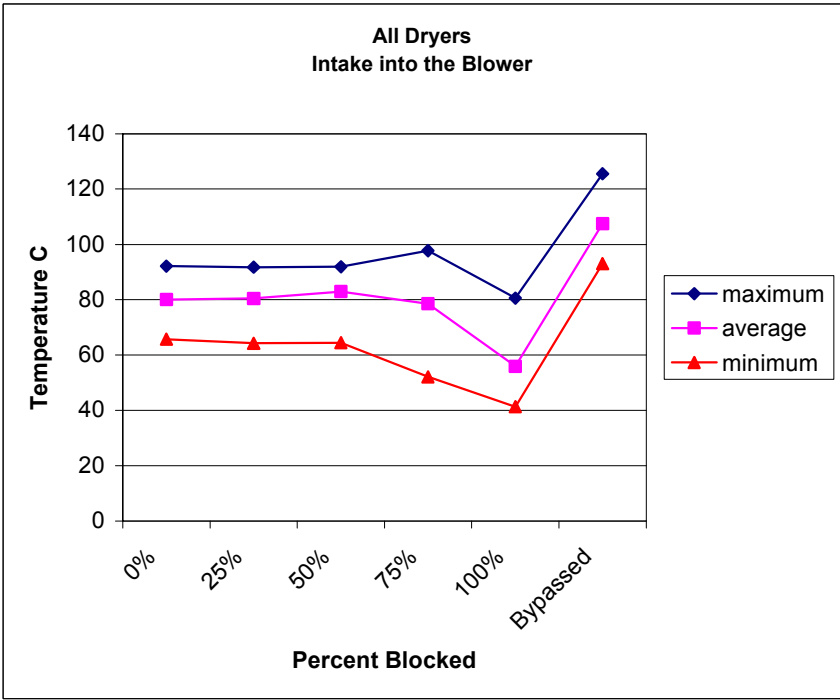

Figure 80. Intake into the Blower Temperature

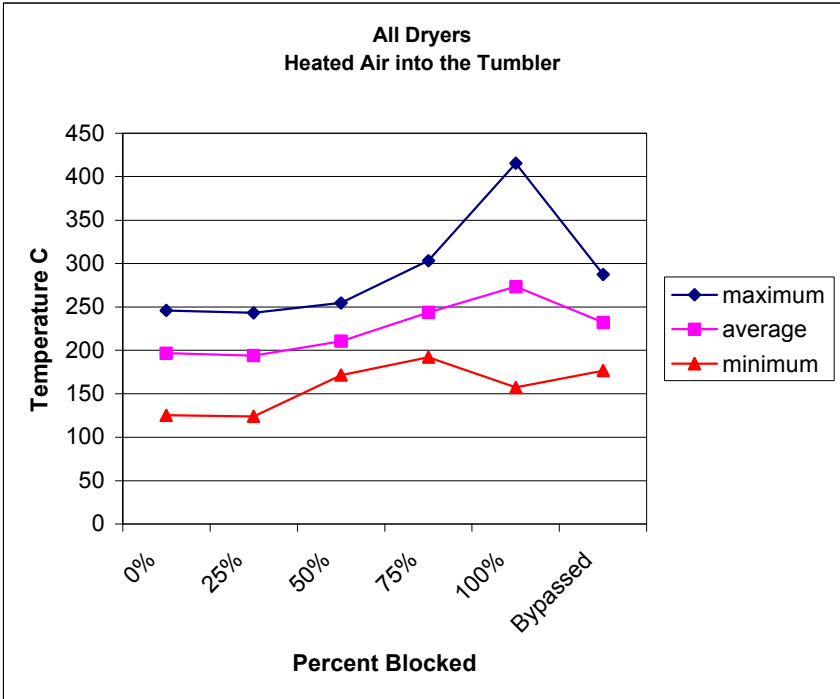

Figure 81. Intake into the Tumbler Temperature

Figure 82 shows the data from Figures 76 through 81 in an illustrated dryer configuration. The dryers' main components are illustrated in a linear representation. The figure shows the maximum temperatures for all the dryer designs at each location for the range of unblocked and blocked exhaust vent conditions, as well as for when the primary thermostat was bypassed.

The figure shows that there was a significant increase in maximum temperatures at the intake into the tumbler when the vent was 75% and 100% blocked. The air temperatures exiting the tumbler and entering the exhaust vent decreased, as expected. For the unblocked, 25% blocked and 50% blocked exhaust vent conditions, the maximum temperatures did not show a significant change. When the primary thermostat was bypassed, there was little change in maximum temperatures at T1 (heater intake) and T3 (heater housing). There was an increase in the maximum temperatures after the heater exhaust and into the exhaust vent.

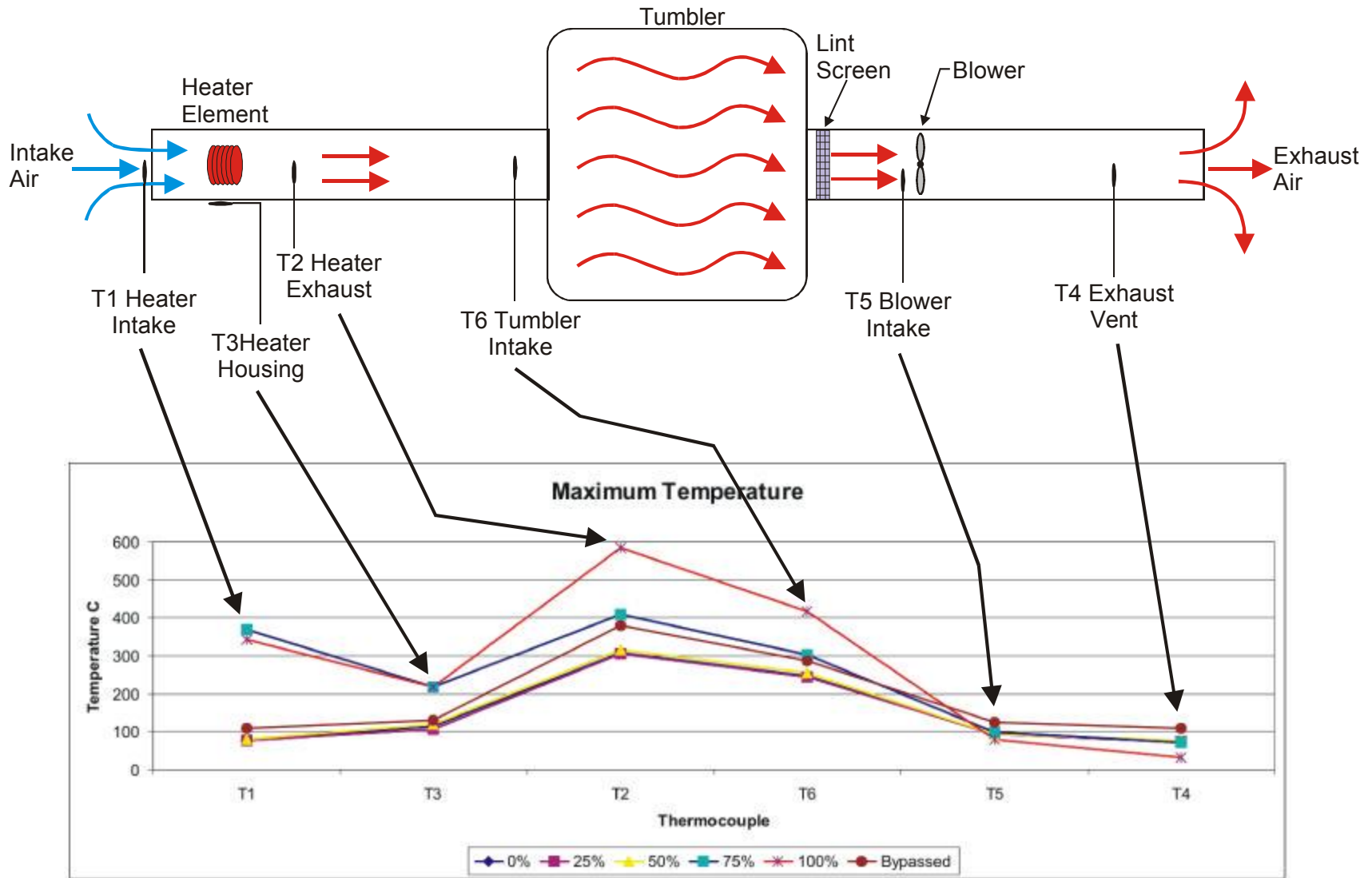

Figure 82. Maximum Temperatures for All Dryers at Each Location and Condition

US CONSUMER PRODUCT SAFETY COMMISSION  
FINAL REPORT ON ELECTRIC CLOTHES DRYERS AND LINT IGNITION CHARACTERISTICS  
May 2003

Tables 15 through 17 show the percentage of change in minimum, average and maximum temperatures for the different percentages of exhaust vent blockage conditions (and a bypassed primary thermostat) as compared to the unblocked condition for all dryer designs. There was an increase in temperature from the heater intake to the tumbler for the partially and fully blocked conditions. As shown in Table 17, there was an increase in temperature ranging from 69% to 351% from the unblocked to 100% blocked conditions, depending on the location. After the tumbler, the temperature increased between 13% to 55% from the unblocked to 100% blocked conditions, depending on the location, as expected. When the primary thermostat was bypassed, the temperature after the tumbler was higher by 38% to 48% when compared to the unblocked condition.

Table 15. Change in Minimum Temperature

Percent Blocked	Percent Change in Minimum Temperature from Unblocked Condition					
	T1 Heater Intake	T3 Heater Housing	T2 Heater Exhaust	T6 Tumbler Intake	T5 Blower Intake	T4 Exhaust Vent
25%	1%	0%	2%	-1%	-2%	-2%
50%	-4%	20%	32%	37%	-2%	-3%
75%	34%	29%	56%	53%	-21%	-20%
100%	39%	41%	30%	26%	-37%	-56%
Bypassed	1%	-10%	24%	41%	41%	35%

Table 16. Change in Average Temperature

Percent Blocked	Percent Change in Average Temperature from Unblocked Condition					
	T1 Heater Intake	T3 Heater Housing	T2 Heater Exhaust	T6 Tumbler Intake	T5 Blower Intake	T4 Exhaust Vent
25%	0%	1%	0%	-1%	0%	-1%
50%	3%	11%	8%	7%	4%	1%
75%	137%	81%	37%	24%	-2%	-9%
100%	162%	100%	78%	39%	-30%	-55%
Bypassed	39%	20%	21%	18%	34%	43%

Table 17. Change in Maximum Temperature

Percent Blocked	Percent Change in Maximum Temperature from Unblocked Condition					
	T1 Heater Intake	T3 Heater Housing	T2 Heater Exhaust	T6 Tumbler Intake	T5 Blower Intake	T4 Exhaust Vent
25%	1%	-7%	-1%	-1%	0%	1%
50%	6%	6%	3%	3%	0%	5%
75%	386%	93%	33%	23%	6%	-1%
100%	351%	92%	89%	69%	-13%	-55%
Bypassed	43%	15%	23%	17%	36%	48%

Figure 83 shows the exhaust air velocities with an unblocked vent for the different dryer designs. The graph shows that the air velocities for Dryer Designs A and D were similar throughout the 60-minute drying cycles. The graph shows that the air velocities for Dryer Designs B and C were also similar. In addition, Dryer Designs B and C showed a steady decline in exhaust air velocities as the drying cycle progressed.

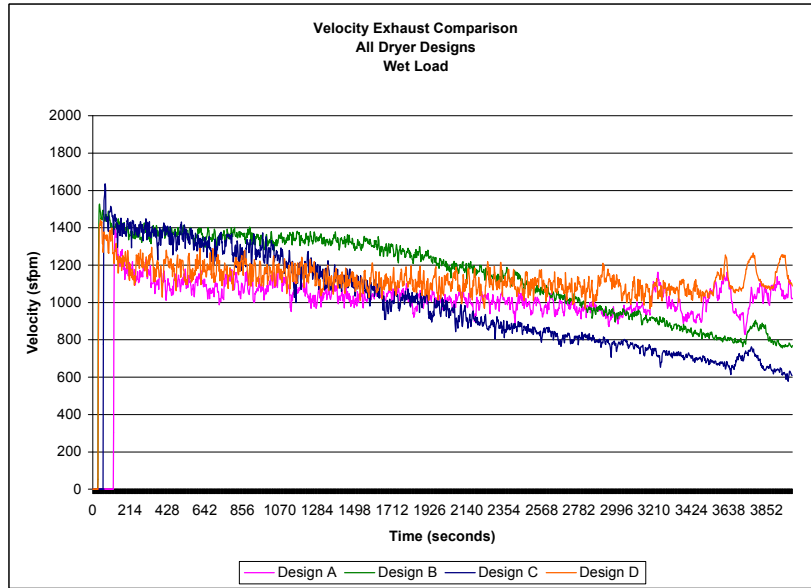

Figure 83. Comparison of Exhaust Air Velocity for all Dryer Designs

Figure 84 shows the average exhaust air velocity with an unblocked vent for all the dryer designs. The graph shows a steady decline in the exhaust velocity during the drying cycle. The average velocity drops from 1300 sfpm to 900 sfpm.

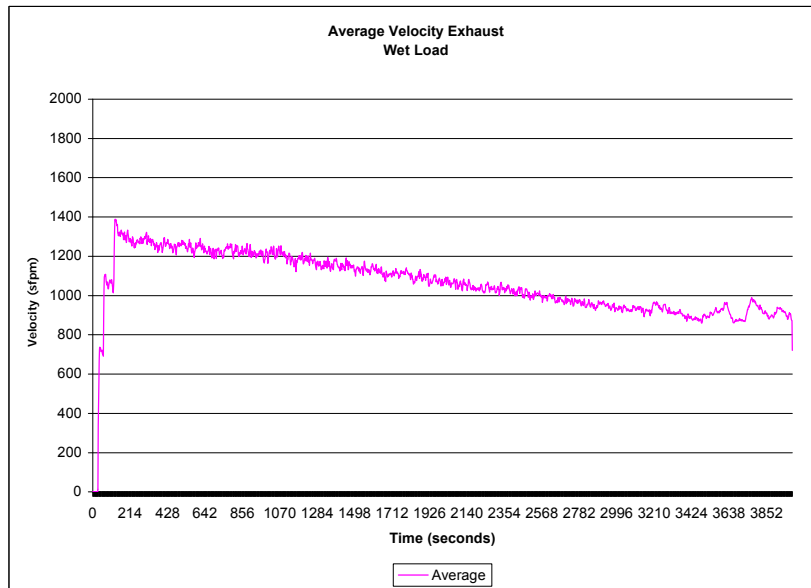

Figure 84. Calculated Average Exhaust Air Velocity



### 3.3 Task 3: Monitor Lint Distribution

Based on the test data and observations presented in Section 2.3, even when the lint filter was cleaned after each use of the dryer, there was visible lint accumulation inside the chassis. This section further evaluates the mechanisms within dryers that may allow lint to leak into the dryer structure. The areas of positive pressure in the airflow were the most likely causes for lint leaking into the dryer chassis.

#### 3.3.1 Dryer Design A at Positive Pressure

Examination of Dryer Design A showed that lint/air can leak through a sealed joint in the blower housing. To examine more closely the nature of the origin of the lint/air leak, the blower fan compartment was opened on a blower from another dryer of Design A. Figures 85(a) and (b) show the blower housing assembled and opened, respectively.



(a) Blower removed from the dryer



(b) Blower housing separated

Figures 85 (a) and (b). Dryer Design A – Blower Assembly

The blower is a centrifugal type fan. The blower operates by sucking air through the center hole at negative pressure and forcing the air outward at positive pressure as shown in

Figure 86. It is noteworthy that a foam gasket was used to seal the outer portion where there is positive pressure.

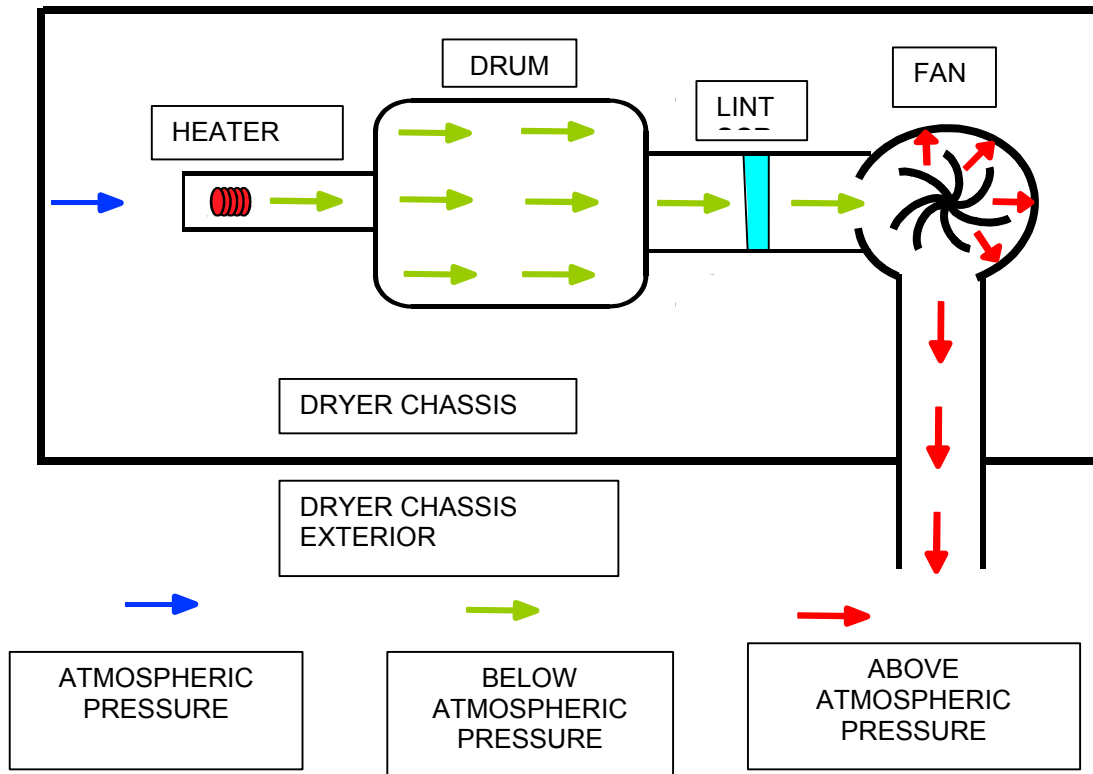
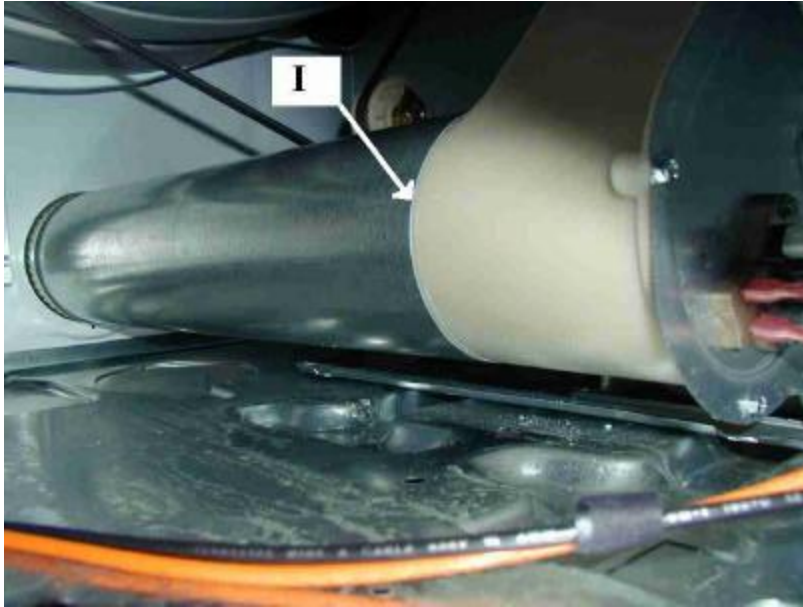

Figure 86. An Illustration of Airflow through the Dryer and Blower

### 3.3.2 Other Dryer Designs at Positive Pressure

The other dryer designs (B, C, and D) did not contain the same configuration that resulted in positive pressure after the blower. As shown in Dryer Design A, the blower was at the rear of the dryer chassis. This configuration allowed the blower housing and connection to the external dryer vent to be the same component. In the other dryer designs, the blower was located toward the front of the dryer chassis, where the lint screen was also located.

These dryers required a short section of duct between the rear of the dryer and the blower housing. The section of the dryer vent/ducting after the blower and inside the chassis was an area of positive pressure. Most importantly, the connection between the short section of duct and the blower was at positive pressure (white arrow). Though the fitting of the metal duct to the plastic nozzle of the fan was snug, it was not airtight. In some cases, there was no seal between the blower housing and the short section of exhaust vent.



Dryer Design B

Figure 87. Junction Between the Blower and Exhaust Vent

Under the test conditions, which included rigid exhaust ducting, two 90° elbows, and no blockage in the ducting, there was lint accumulation in the chassis interior. The setup produced minimal backpressure in the dryer exhaust vent (See Appendix E). In the event that a serious blockage did occur, lint leakage could be expected to increase as the backpressure in the exhaust vent increased. The extent to which leakage would be made worse would depend on the location of the leakage. Close to the blower impeller – on the side opposite of the exhaust port yet inside impeller housing – the positive pressure is greatest.

### **3.4 Task 4: Determine Characteristics Required for Lint Ignition**

Based on the test data and observations presented in Section 2.4, ignition characteristics of lint were observed on and near the heater housing (heater box) and when lint was ingested into the heater box. This section further assesses the ignition times and temperatures under the various conditions tested. This section also includes an examination of high limit devices that had failed during the course of testing.

#### **3.4.1 Lint on the Heater Housing**

Twenty-two lint samples were tested at five different locations on the heater housing. The samples at either locations B or E were more likely to ignite than samples placed at locations A, C, or D on the heater housing. The samples located at B and E ignited more frequently under conditions of no airflow and when the high-limit thermostat was bypassed. The samples would smolder but generally not ignite when placed at the other locations and/or when tested under other conditions. Instead, the lint material would be consumed by pyrolysis or thermal decomposition.

#### **3.4.2 Lint Samples at the Heater Intake**

This phase of testing was divided into three test series. The first series of tests was conducted under conditions of no airflow through the heater box, and the high-limit thermostat bypassed. This simulated a condition in which the exhaust vent was blocked and the high-limit thermostat had failed to open. The second test series was conducted with no airflow through the heater box, but the high-limit thermostat was connected in series with the heating element. This simulated a condition where the exhaust vent was fully blocked, but the high-limit thermostat was operational. The third series of tests was conducted with various airflow velocities through the heater box, and the high-limit thermostat connected in series with the heating element. This simulated a partially blocked exhaust vent with an operational high-limit thermostat.

In these tests, the primary purpose of the T3 thermocouple, which was placed on the lint sample, was to indicate when the sample ignited. The T3 thermocouple temperature data should not be used as an analysis tool to compare samples, since the placement of the thermocouple on the samples may not have been identical. The thermocouple was placed above the sample, to achieve the maximum change in temperature should the sample ignite.

##### ***3.4.2.1 High-Limit Thermostat Bypassed and No Airflow***

Eleven tests were conducted in the first series of tests. Lint samples were placed at distances ranging from 2 to 4 inches from the edge of the heater box. (This would equate to 4 to 6 inches from the heater element.) The data shows the threshold for ignition and no ignition was approximately 3 inches and 4 inches (from the edge of the heater housing), respectively. (Appendix I shows data for the lint sample tested 2 inches from the heater intake.)

Figure 88 below shows the temperatures at the T1 Heater Intake, T2 Heater Exhaust and T3 Lint Sample thermocouples for samples s3-3, s3-9, and s3-10, which were tested 3 inches from the heater housing edge. (The heating element was energized approximately 35 seconds into the test.)

Samples s3-9 and s3-10 show similar curves for the T1 thermocouple as shown in Figure 89. For tests with sample s3-3, the T1 thermocouple showed slightly lower temperatures, which coincides with the later ignition time shown by T3 thermocouple. The temperature curves for the T2 thermocouple were similar for all three samples tested as shown in Figure 90.

The times to ignition are similar for samples s3-9 and s3-10 – approximately 83 and 81 seconds after powering the heating element, respectively. Sample s3-3 had a slightly longer time to ignition – approximately 107 seconds after powering the heating element as shown in Figure 91.

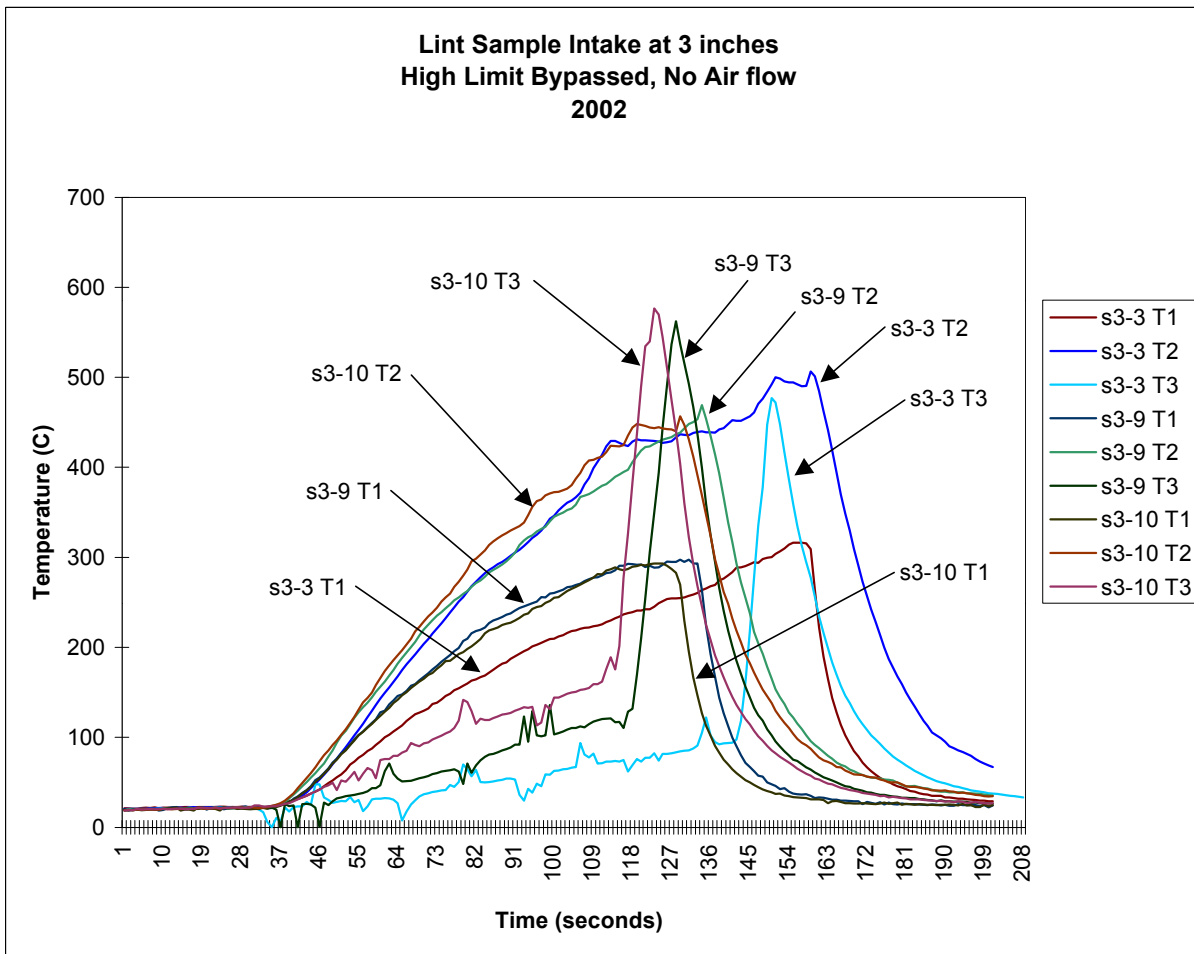

Figure 88. Lint Samples Tested 3 Inches from the Heater Housing Edge

US CONSUMER PRODUCT SAFETY COMMISSION  
FINAL REPORT ON ELECTRIC CLOTHES DRYERS AND LINT IGNITION CHARACTERISTICS  
May 2003

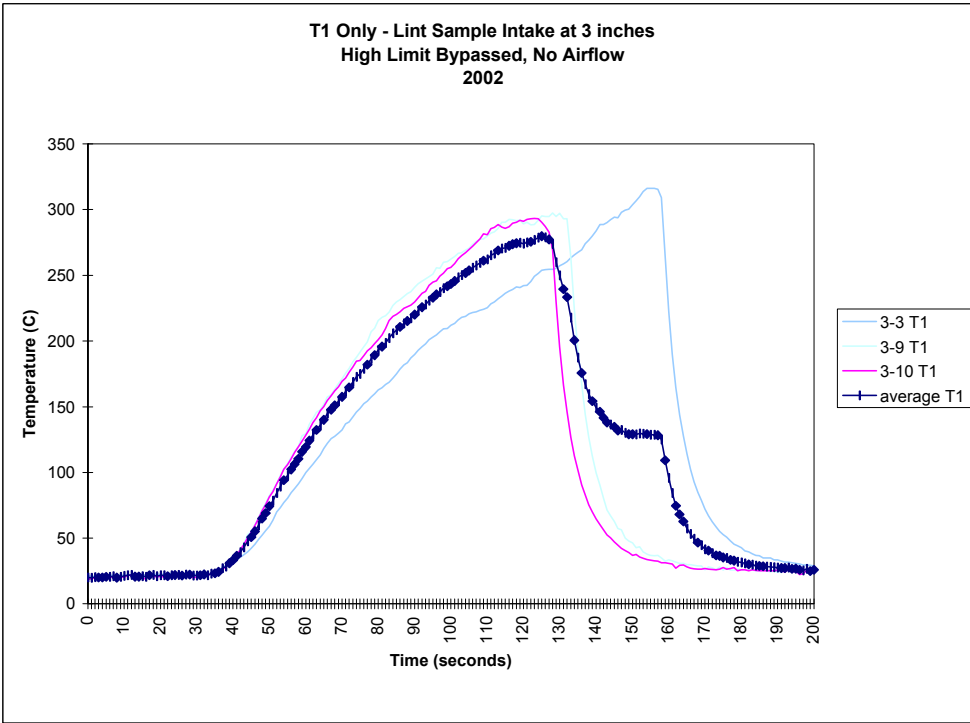

Figure 89. T1 Only - 3 Inches from the Heater Housing Edge

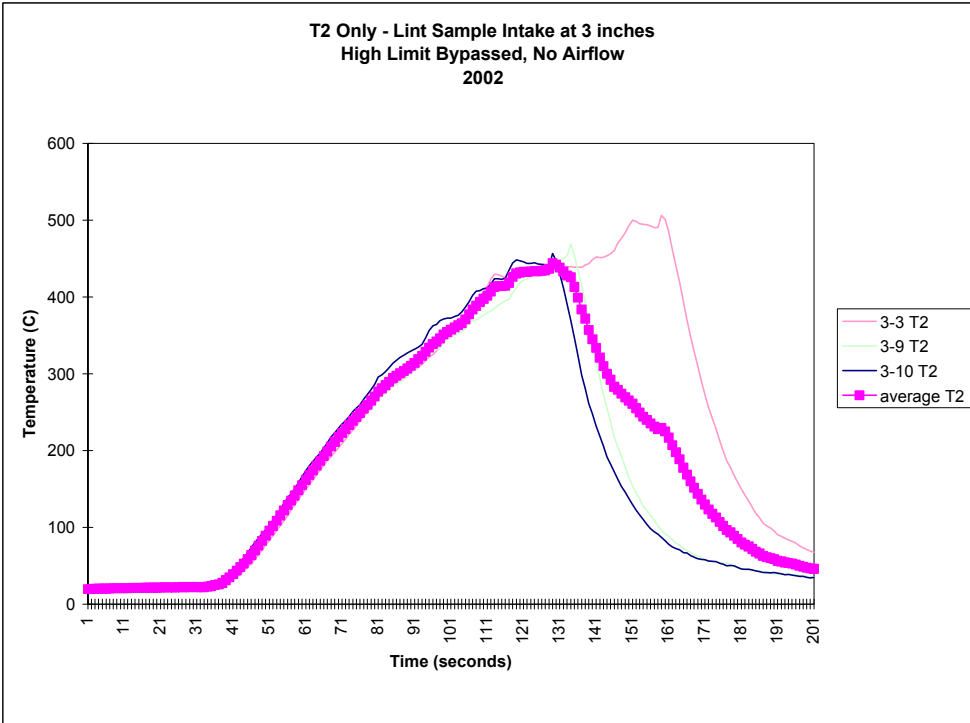

Figure 90. T2 Only - 3 Inches from the Heater Housing Edge

US CONSUMER PRODUCT SAFETY COMMISSION  
FINAL REPORT ON ELECTRIC CLOTHES DRYERS AND LINT IGNITION CHARACTERISTICS  
May 2003

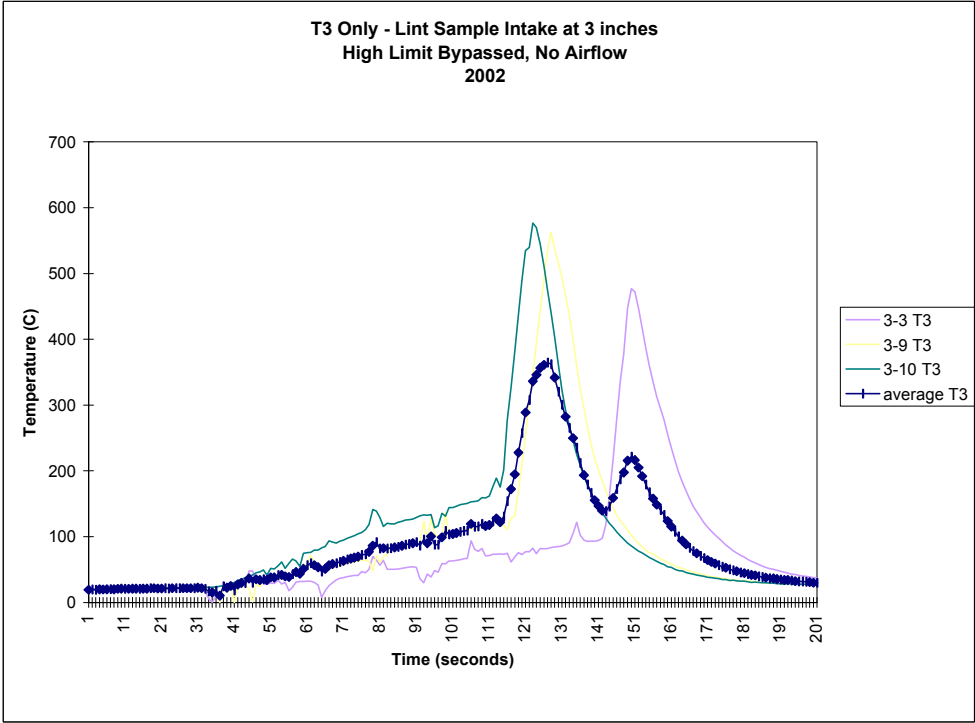

Figure 91. T3 Only - 3 Inches from the Heater Housing Edge

Figure 92 shows the temperatures at the T1, T2 and T3 thermocouples for samples s3-4, s3-11, and s3-12, which were tested 4 inches from the heater housing edge. (The heating element was energized approximately 35 seconds into the test.) All three samples smoldered, but no flames were present. The T1, T2 and T3 thermocouple traces were similar for all three samples tested.

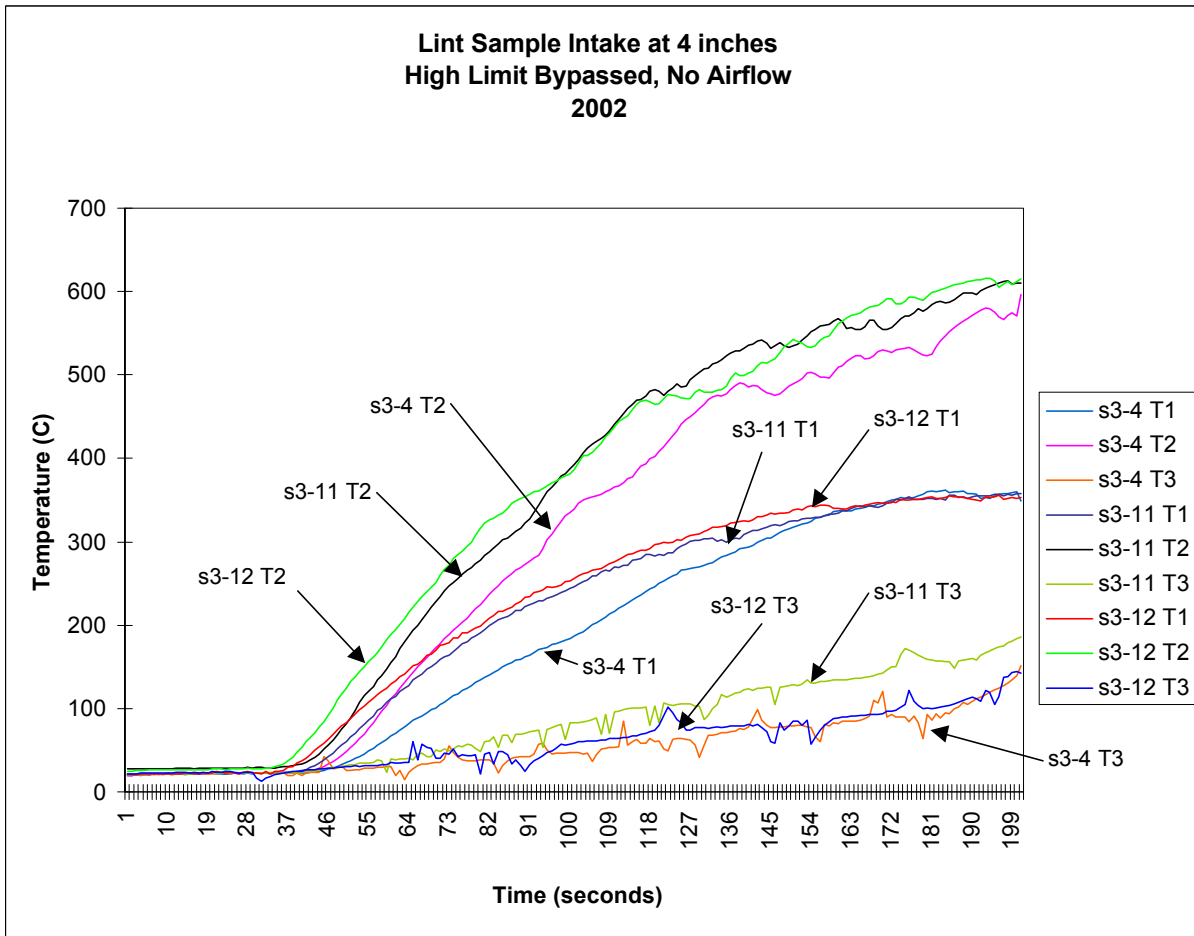

Figure 92. Lint Samples Tested 4 Inches from the Heater Housing Edge

Table 18 lists the ignition times for samples tested at 2 and 3 inches from the heater intake edge. Figure 93 plots the minimum, maximum, and average ignition times for samples tested at 2 and 3 inches from the heater edge.

Table 18. Ignition Times at Heater Intake

3 inches from Heater Intake			
Sample Number	Data Time (sec)	Heater Energized (seconds)	Actual Time (sec)
s3-3	143	36	107
s3-9	118	35	83
s3-10	115	34	81
		max	107
		average	90
		min	81

2 inches from Heater Intake			
Sample Number	Data Time (sec)	Heater Energized (seconds)	Actual Time (sec)
s3-2	108	35	73
s3-8	83	37	46
s3-5	75	37	38
s3-6	80	39	41
s3-7	76	40	36
		max	73
		average	47
		min	36



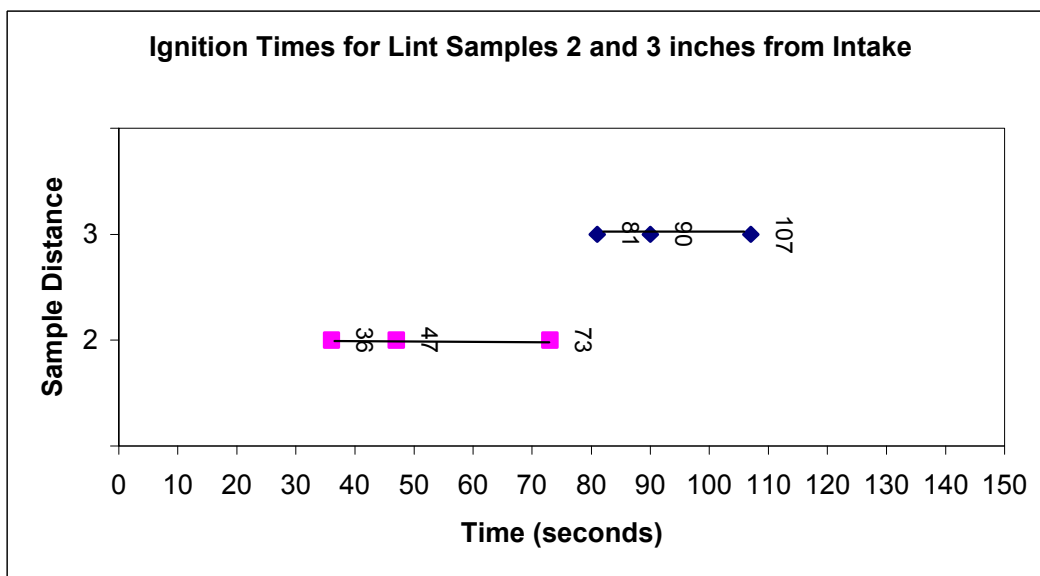

Figure 93. Ignition Time for 2 and 3 Inches from Heater Edge

### 3.4.2.2 High-Limit Connected in Series and No Airflow

Six tests were conducted in this series of tests in which the high-limit thermostat was connected in series with the heating element and there was no airflow through the heater box. Lint samples were placed at distances ranging from 0 to 2 inches from the edge of the heater box (2 to 4 inches from the heating element, respectively). The data show a threshold of between 1 and 2 inches from the heater housing edge for ignition and no ignition, respectively.

In the first test, sample s3-13 ignited, and the high-limit thermostat did not open and disconnect power to the heating element. It was determined that the high-limit thermostat had failed. (An investigation of the cause of failure for the high-limit thermostat was conducted, and the results are reported at the end of this Discussion Section.) The remainder of the discussion in this subsection, therefore, will not include data from sample s3-13.

The high-limit thermostat was replaced with a similar high-limit thermostat taken from a dryer of the same make and model. Several baseline tests were conducted to confirm that the replacement thermostat operated properly when the temperature inside the heater housing reached a set temperature.

Figure 94 shows the T1, T2, and T3 thermocouple data for samples s3-16 and s3-17, tested at a distance of 1 inch from the heater edge. The times to ignition for samples s3-16 and s3-17 were approximately 55 and 65 seconds after powering the dryer, respectively. The steep increases observed in the data for thermocouple T3 indicate ignition of the sample. The profiles of the data obtained from thermocouples T1 and T2 were similar for both samples tested.

This figure shows that the samples ignited before the high-limit thermostat opened and disconnected power to the heating element. For both samples, the sample ignited

approximately 5 to 8 seconds before the high-limit thermostat opened, which is shown by the sudden decrease in temperature for the T1 thermocouple.

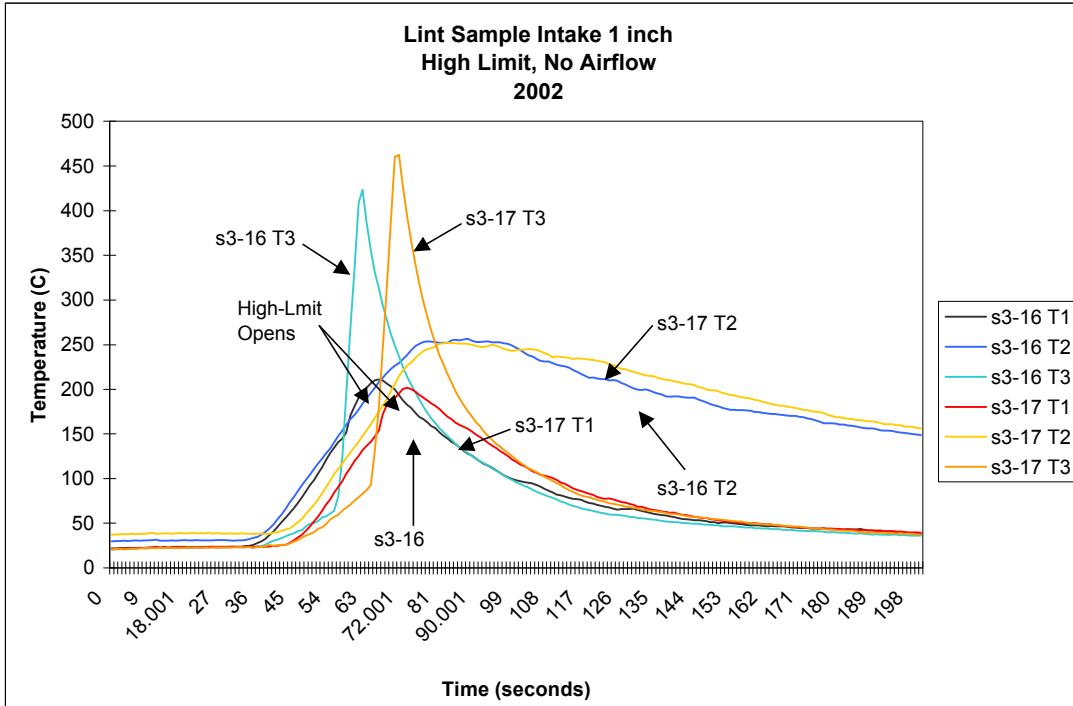

Figure 94. Lint Samples s3-16 and s3-17 Tested 1 Inch from the Heater Edge

Figure 95 shows the T1, T2, and T3 thermocouple data for samples s3-14 and s3-18, tested at a distance of 2 inches from the heater edge. Both samples smoldered, and no flames were present before the high-limit thermostat opened and disconnected power to the heating element. The profiles of the data obtained from thermocouples T1, T2 and T3 were similar for both samples tested.

US CONSUMER PRODUCT SAFETY COMMISSION  
 FINAL REPORT ON ELECTRIC CLOTHES DRYERS AND LINT IGNITION CHARACTERISTICS  
 May 2003

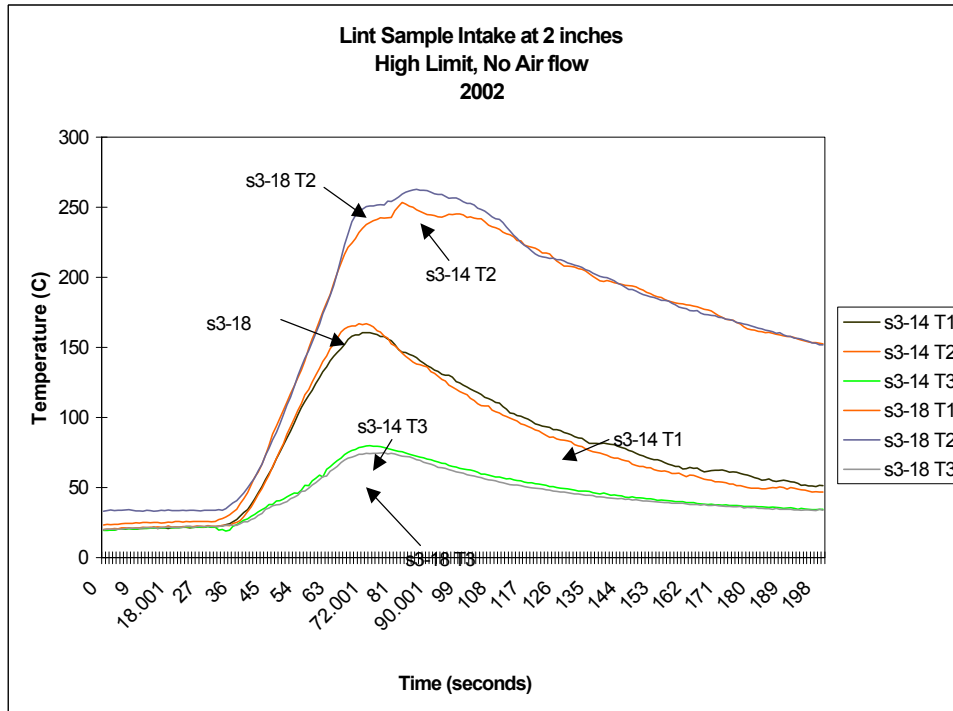

Figure 95. Lint Samples s3-14 and s3-18 Tested 2 Inches from the Heater Edge

In previous tests in which the high-limit thermostat was bypassed, a lint sample placed 2 inches from the heater edge ignited. Table 19 lists the high-limit thermostat activation times. The average activation time was 39 seconds. Figure 96 shows a similar figure as in Figure 93 but with the average high-limit thermostat activation time at 93 seconds. The figure indicates the high-limit thermostat opens 8 seconds before the average sample at 2 inches from the heater edge would ignite. In some cases, a lint sample 2 inches from the heater edge may ignite before the high limit activates as shown in the figure.

Table 19. Approximate High Limit Thermostat Activation Times

High Limit Activation 2 inches from Heater Intake with High Limit			
Sample Number	Data Time (seconds)	Heater Energized (seconds)	Actual Time (seconds)
s3-18	74	36	38
s3-14	75	35	40
average			39

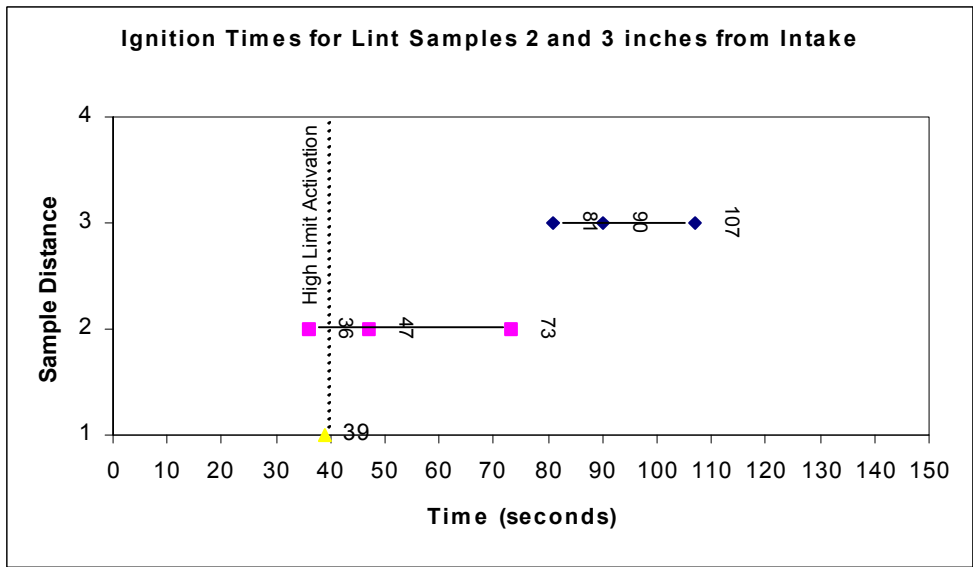

Figure 96. High Limit Activation Time Comparison at Sample 2 and 3 inches

#### 3.4.2.3 High-Limit Connected in Series and Airflow

Four tests were conducted in this last series of tests, in which the high-limit thermostat was connected in series with the heating element and airflow through the heater box was varied. Lint samples were placed at distances either 0 or 1 inch from the edge of the heater box (either 2 or 3 inches from the heating element). Airflow velocity, as measured at the intake, was varied from 200 to 400 sfpm. For a sample placed 1 inch from the heater housing edge, the thermocouple and anemometer data showed a threshold between 300 and 400 sfpm for ignition and no ignition, respectively.

Figure 97 shows T1, T2, and T3 thermocouple data for samples s3-19, s3-20, and s1-8, which were tested at a distance of 1 inch from the heater edge with different airflow velocities. The graph shows that samples tested with airflow below 300 sfpm ignited. With an airflow of 200 sfpm, the sample ignited approximately 60 seconds after powering the heating element. With an airflow of 300 sfpm, the sample ignited approximately 80 seconds after powering the heating element.

The graph also shows that samples tested with airflow below 300 sfpm ignited before the high-limit thermostat opened and disconnected power to the heating element. For both samples tested at 200 and 300 sfpm airflow, the samples ignited approximately 10 seconds before the high-limit thermostat opened (as shown by the decrease in temperature measured at thermocouple T2). Since thermocouple T1 was in close proximity to the lint sample, the thermocouple data for T1 and T3 showed similar responses. T2 thermocouple was used to approximate the time at which the high-limit thermostat opened and disconnected power to the heating element.

Sample s1-9 was placed 1 inch from the heater housing edge; the airflow was set at 400 sfpm, and the high-limit thermostat was connected in series with the heating element. Sample s1-9 did not ignite. With an intake airflow of 400 sfpm and the high-limit thermostat connected

in series with the heating element, samples at 0 or 1 inch from the edge of the heater housing did not ignite.

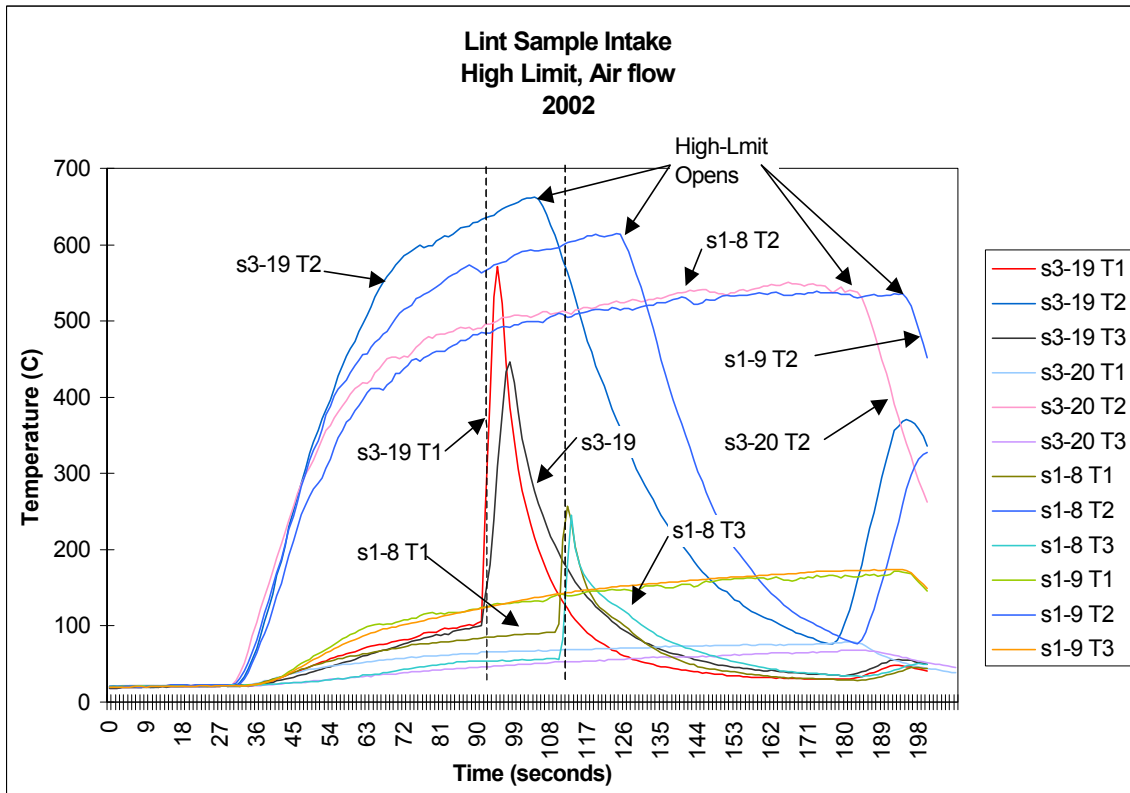

Figure 97. Lint Samples Tested 1 Inch from the Heater Edge with Airflow

Sample s1-10 was placed 1 inch from the heater housing edge; the airflow was set at 400 sfpm and the high-limit thermostat was bypassed. The sample ignited. Figure 98 shows a comparison between samples s1-9 and s1-10. The figure shows that sample s1-10 ignited approximately 25 seconds before the high-limit thermostat operated for sample s1-9.

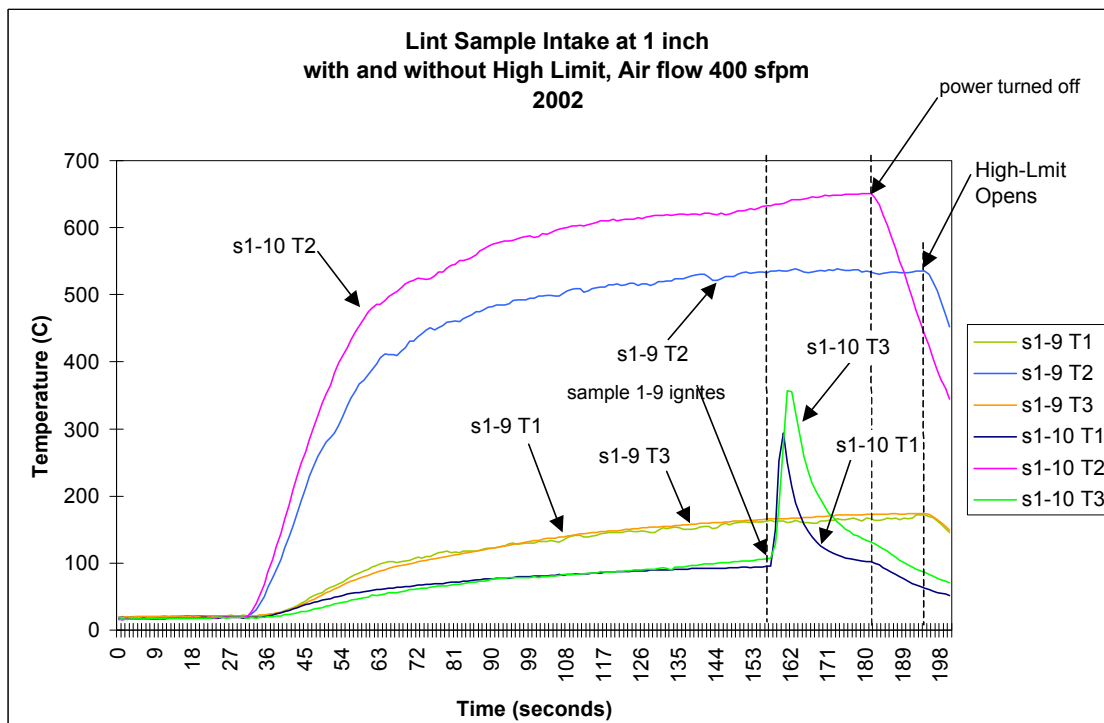

Figure 98. Samples Tested at 1 Inch, With and Without High-Limit Thermostat

### 3.4.3 Lint Samples Ingested into the Heater

The ignition characteristics of lint were evaluated by observing the heater exhaust as lint samples of varying weights and sizes were ingested into the heater box. The test setup was designed to allow the airflow into the heater intake to carry lint samples past the heating element and to exhaust any embers through a 4" diameter glass tube.

In these tests, lint samples ranging from 0.04 g to 0.48 g were observed igniting, and embers traveled through the exhaust vent. The following observations were made (small embers are defined as particles approximately the size of a pinhead; large embers are defined as particles close to the size of a thumb tack head):

1. Sample contacted the center heating element coil and ignited.  
Result – Small embers exited the heater box.
2. Sample contacted the edge of the heating coil and ignited.  
Result – Small to large embers exited the heater box. In some instances, small portions of the sample that were either flaming or contained large embers broke away.
3. Sample passed between the heating element and the heater housing.  
Result – The sample ignited and exited the heater box.

4. Sample became lodged between the two layers of heating coils, on the insulator.  
Result – Small embers exited the heater housing, and unburned lint stayed lodged on the insulator.

#### 3.4.4 Ignition of Target Material Downstream from the Heater Exhaust

Four tests were conducted to determine whether embers that exited the heater could ignite target materials placed downstream of the heater exhaust. The target material was either 100% cotton lint or 100% cotton terry towel.

In all four tests conducted, the target material ignited. The test results showed that fewer ingested lint samples were required to ignite the 100% lint target material than the 100% cotton terry target material. The target material of 100% cotton lint ignited on the fifth sample of 0.10 g, the sixth sample of 0.20 g, and the tenth sample of 0.10 g ingested into the heater box. The target material of 100% cotton terry ignited on the eighth sample of 0.30 g.

When the target material ignited, the target material would produce additional embers that were carried through the exhaust vent. The 100% cotton terry towel burned substantially longer than the lint target material. The terry towel also produced significantly more embers, which were carried further into the exhaust venting.

#### 3.4.5 High-Limit Thermostat Analysis

Two high-limit thermostats failed during the course of testing. The life histories of both thermostats were compiled and are presented in Table 20:

- Column 1 (High Limit Thermostat) labels the thermostats (HLT1 represents the high-limit thermostat that failed first, and HLT2 represents the second).
- Column 2 (Life Below 100°C) lists the approximate number of hours to which the high-limit thermostat was exposed to the following conditions: The dryer operated on the primary thermostat or it operated while the temperature at T1 (intake air into the heater box) was below 100°C. This would include testing (Task 2) in which the dryer operated with an unblocked exhaust vent or with a partially-blocked exhaust vent, and it would include testing (Task 4) with just the heater box in the unblocked and partially blocked conditions.
- Column 3 (Life Above 100°C) lists the approximate number of hours to which the high-limit thermostat was exposed to the following conditions: The high-limit thermostat was bypassed or the temperature at T1 (intake air into the heater box) was above 100°C. This would only include testing in which the heater box was installed in the test apparatus.
- Column 4 (Number of Cycles) lists the number of times the high-limit thermostat cycled; one cycle represents opening and closing of the high-limit thermostat. The high-limit cycling duration was not included in either of the total times listed in column 2 and 3.

Table 20. Life History of Failed High-Limit Thermostats

High Limit Thermostat	Life Below 100° C	Life Above 100° C	Number of Cycles
HLT1	9.3 hours	0.79 hours	47
HLT2	97.6 hours	0.20 hours	26

3.4.5.1 High-Limit Thermostat 1 (HLT1) Analysis

The first high-limit thermostat failed in June 2002 during Task 4 testing. This high-limit thermostat was used in Task 2: Dryer Design A – Document Dryer Operating Characteristics, and Task 4: Determine Characteristics Required for Lint Ignition. The high-limit thermostat was connected in series with the heating element when it was discovered that it had failed to open. Figure 99 shows the thermocouple data for test Sample s3-13 when the high-limit first failed to operate. The figure shows the sample ignited, which was unexpected, and the T1 temperature rose to almost 200°C.

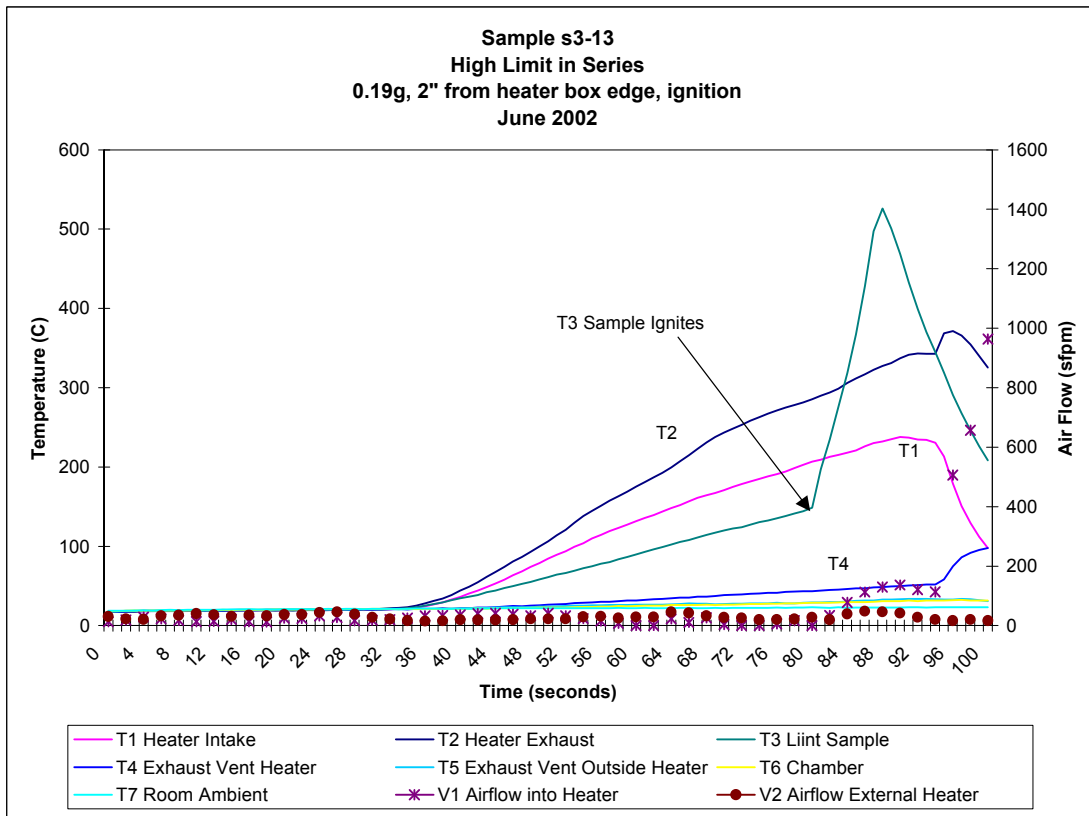

Figure 99. Sample s3-13 Test with the High Limit Thermostat in Series

Figure 100 shows a comparison for thermocouples T1, T2, and T3 between the failed high-limit thermostat (HLT1) and a replacement high-limit thermostat (HLT2). The



thermocouples were placed at the heater intake, the heater exhaust, and 2 inches from the heater edge for T1, T2 and T3, respectively. The figure shows T1 for HLT2 rose to approximately 150° C before the high-limit thermostat opened and disconnected power to the heating element. The temperatures for HLT1 continued to rise until power was manually turned off at approximately 170 seconds.

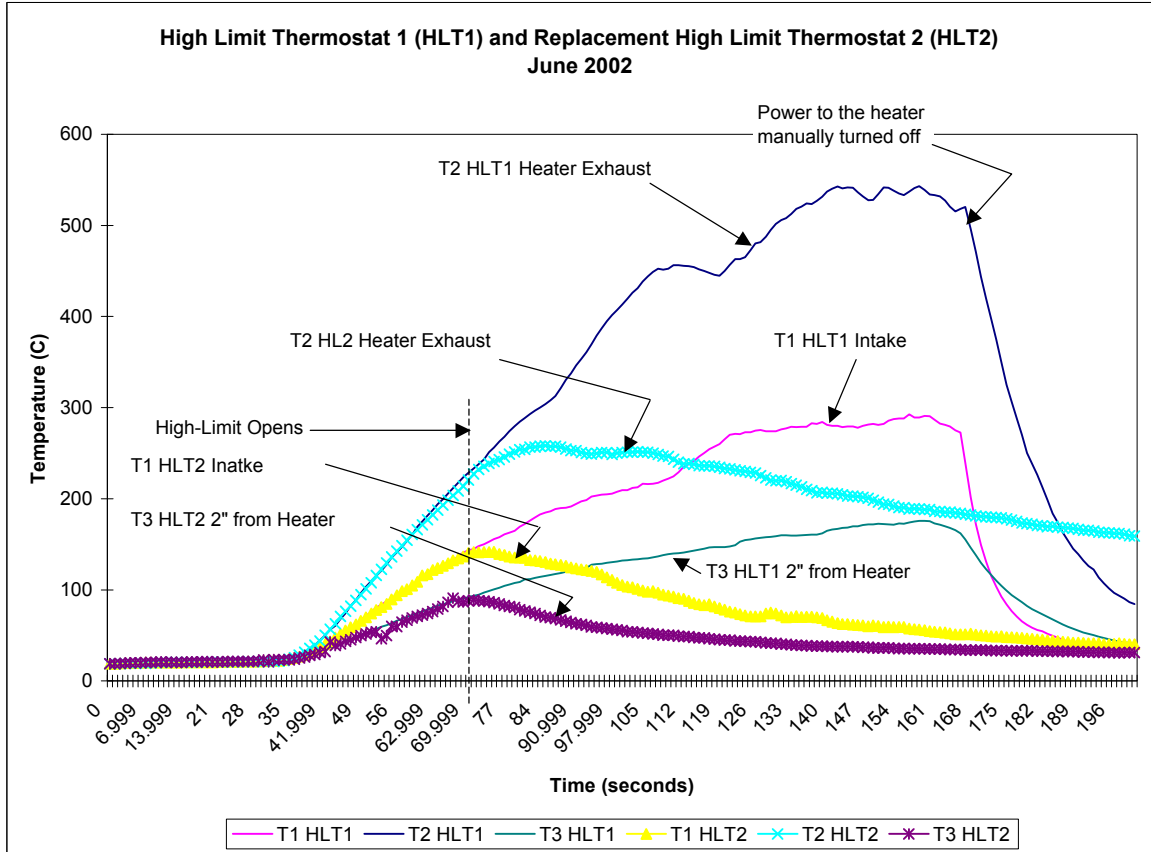

Figure 100. Failed Thermostat compared to a Replacement Thermostat

The high-limit thermostat was removed and x-rayed as shown in Figure 101. The high-limit thermostat uses a bi-metal disc that “pops” at a certain set temperature. When the concave disc pops and becomes convex, it pushes on a rod that sequentially opens the contacts. The x-rays did not reveal any abnormalities.

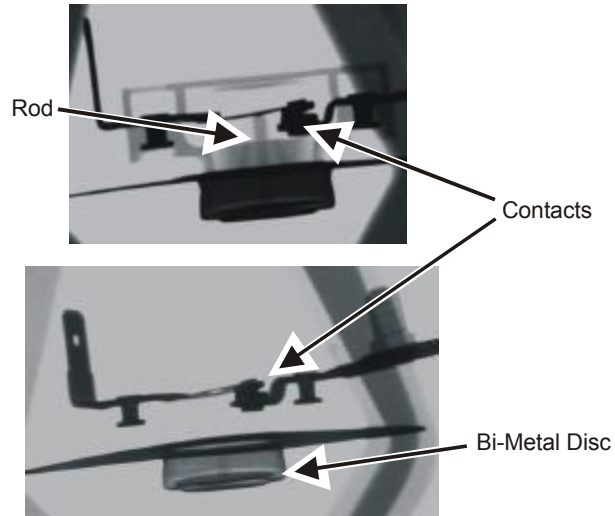

Figure 101. X-ray Images of High-Limit Thermostat 1 (HLT1)

The high-limit thermostat was opened and examined under a microscope, as shown in Figure 102. It appeared that the contacts were welded together, but this could not be confirmed.

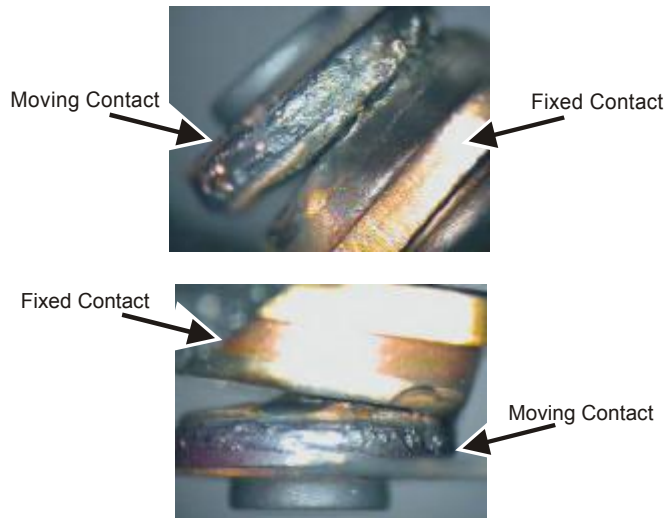

Figure 102. Contacts for High-Limit Thermostat 1 (HLT1)

Figure 103 shows the surface of the contact pads. Pitting and scorch marks are visible and indicate there was a concentration of high heat. Figures 102 and 103 also show that approximately 50% to 60% of the contact pad surfaces were making contact when the thermostat was in the closed position.

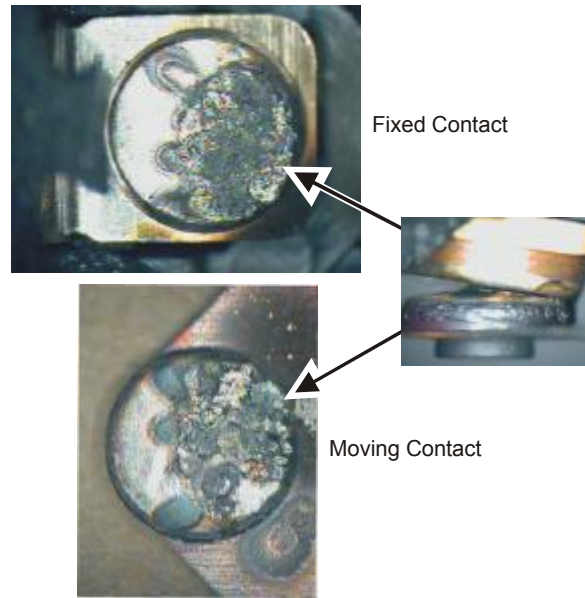

Figure 103. Contact Pads for High-Limit Thermostat 1 (HLT1)

### 3.4.5.2 High-Limit Thermostat 2 (HLT2) Analysis

The second high-limit thermostat failed during tests in July 2002 during Task 4: Determine Characteristics Required for Lint Ignition. This high-limit thermostat was used in Task 3 Monitor Lint Distribution testing and as a replacement thermostat for Task 4: Characteristics for Lint Ignition tests. The high-limit thermostat was in series with the heating element when it was discovered that it had failed to open. Figure 104 shows the thermocouple data for test Sample s5-14 when the high-limit failed to operate. The figure shows the T2 temperature rose to almost 600°C. (The T1 thermocouple and V1 anemometer were not in the heater intake air stream during this test.)

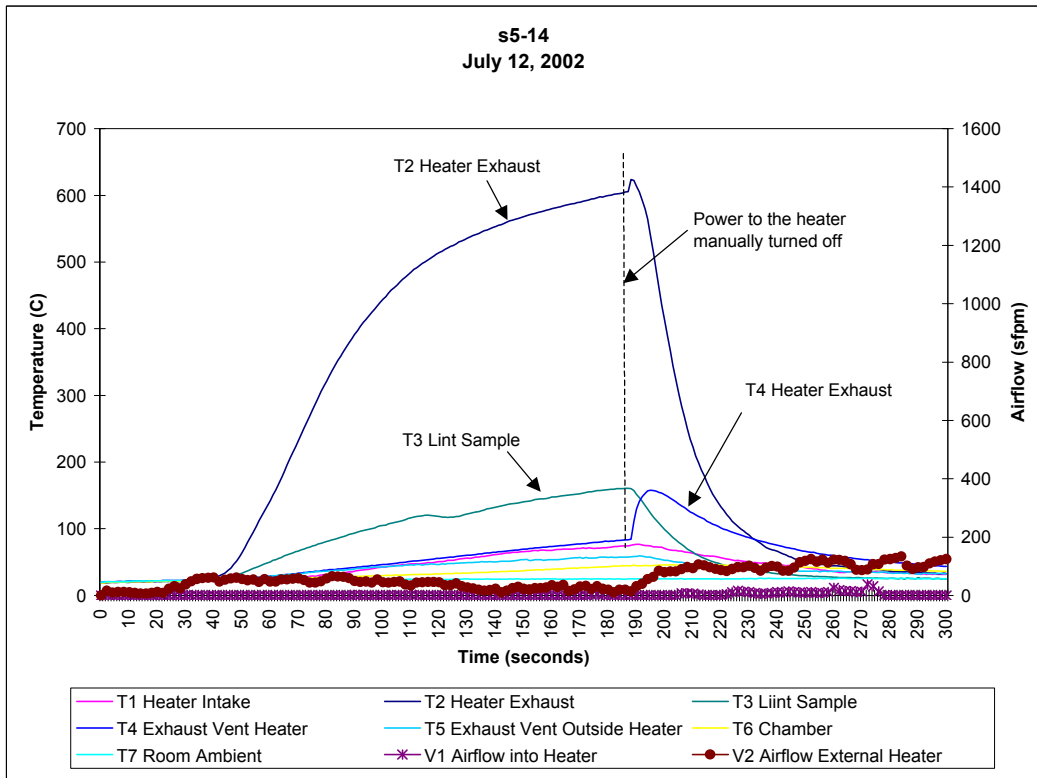

Figure 104. Sample s5-14 with High Limit Thermostat in Series

Figure 105 shows a comparison of temperature data from thermocouples T2 and T3 for the high-limit thermostat before it failed (HLT2 Before) and after it failed (HLT2 After). The thermocouples were placed at the heater exhaust and 2 inches from the heater edge for T2 and T3, respectively. (The T1 thermocouple and V1 anemometer were not in the heater intake air stream during the HL2 After test.)

The figure shows T1 temperature for HL2 Before rose to approximately 150°C before the high-limit thermostat opened and disconnected power to the heating element. The sample lint in the HLT2 After test ignited unexpectedly approximately 55 seconds after powering the heater.

The temperatures for HLT2 After continued to rise until power was manually turned off at approximately 170 seconds.

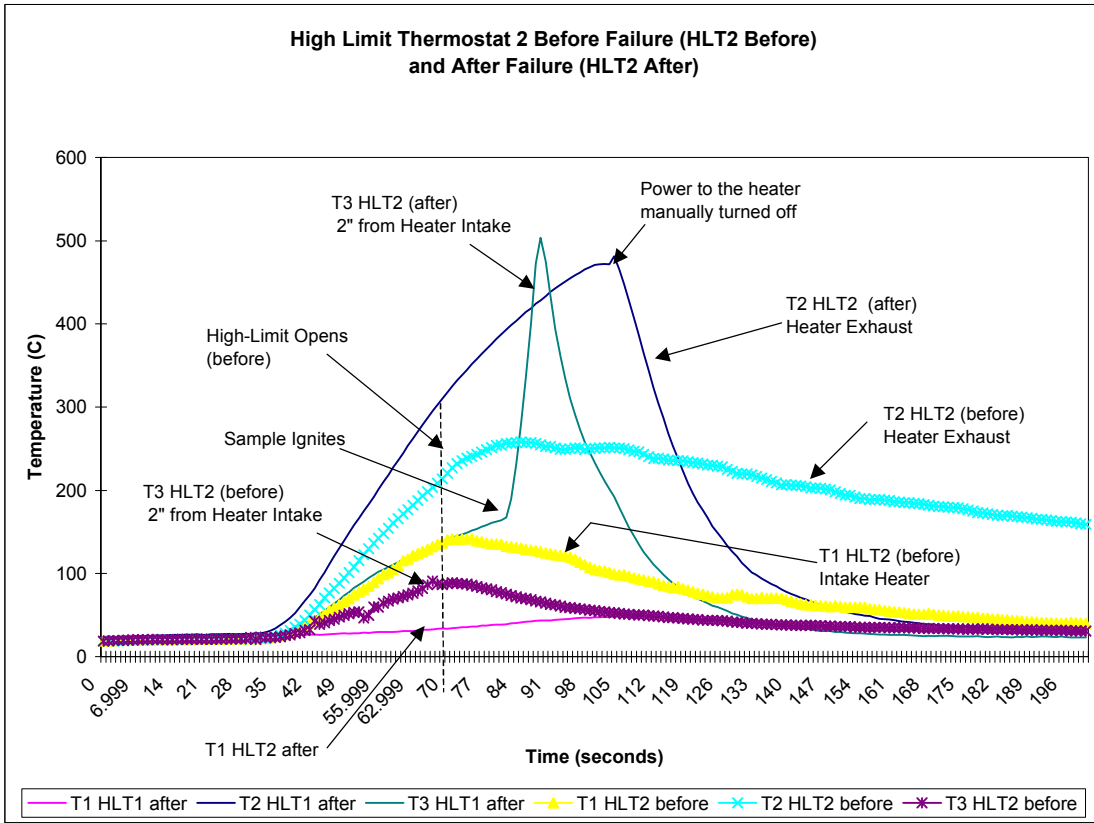

Figure 105. High-Limit Thermostat 2 (HLT2) before and after Failure

The high-limit thermostat was removed and x-rayed, as shown in Figure 106. The theory of operation for the second failed thermostat, HLT2, is the same as that for the first failed thermostat, HLT1. The x-rays did not reveal any abnormalities.

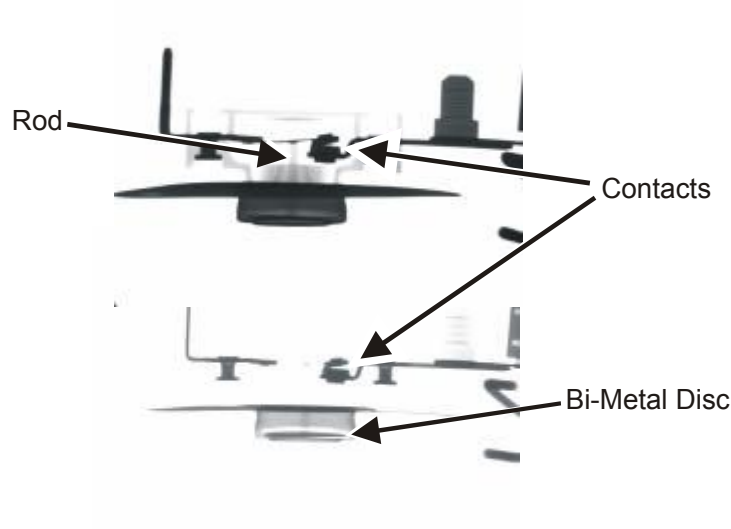

Figure 106. X-ray Images of High-Limit Thermostat 2 (HLT2)

A portion of the thermostat housing was removed to reveal the contacts and the rod, as shown in Figure 107. From visual examination, it could not be determined if the contacts were welded together or not. This sample was not disassembled, to maintain the operational integrity of the thermostat; and an inspection of the contact pad surfaces was not performed.

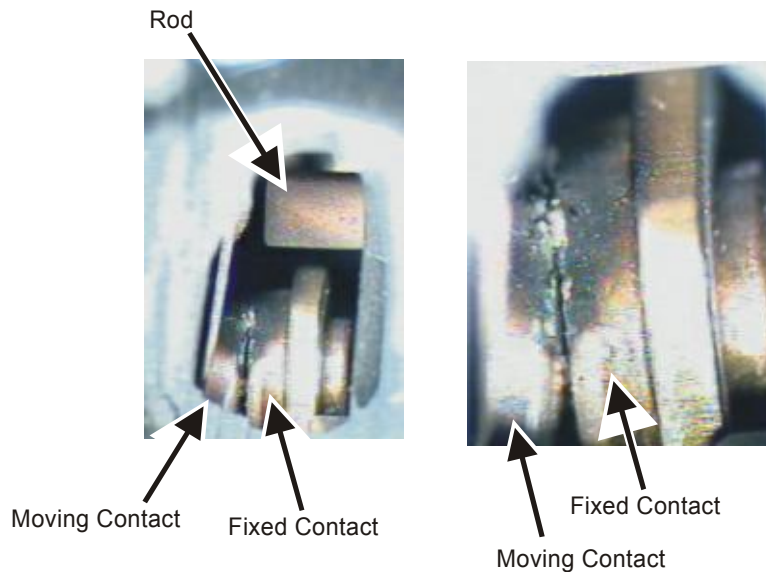

Figure 107. Internal View for High-Limit Thermostat 2

Before conducting tests of the failed thermostat HLT2, tests were first conducted on a new high limit thermostat of the same make and model. The setup included a heat gun (heat source), a microscope, and dual channel logging thermocouple temperature meter, as shown in Figure 108. Thermocouple 1 was placed at the face of the enclosure, near the bi-metal disc. Thermocouple 2 was used as an indicator of when the contacts opened and closed.

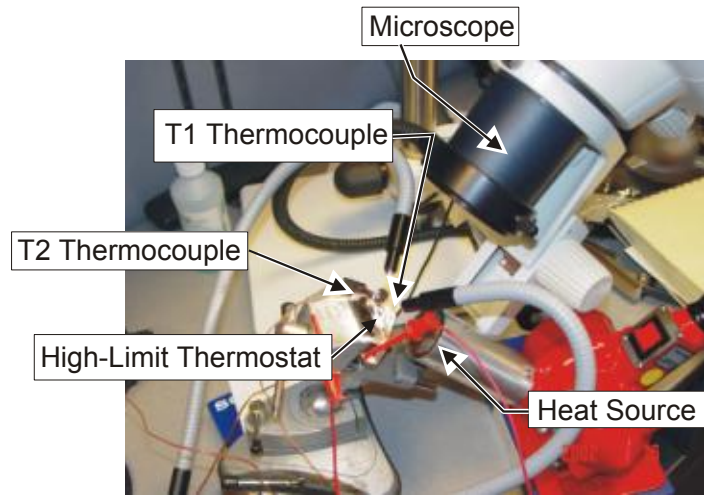

Figure 108. Setup for Testing High-Limit Thermostats

A small grinder was used to produce a small hole to reveal the internal components around the contacts of the new thermostat. Figure 109 shows a “before” picture (contacts in the normally-closed position) and an “after” picture (contacts opened). The after picture shows the rod had pushed on the arm and caused the contacts to separate.

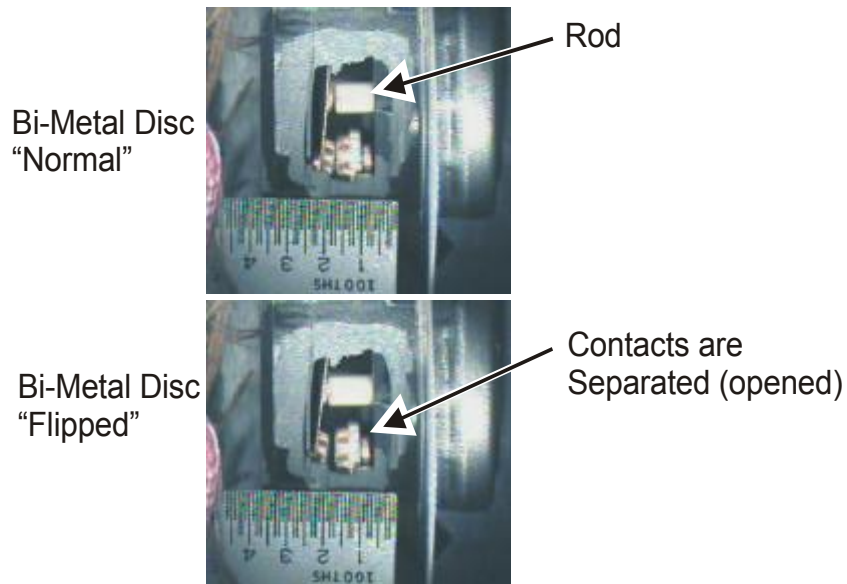

Figure 109. New High Limit Thermostat

Figure 110 shows the temperature data for T1 thermocouple at the bi-metal disc and T2 at the contacts for the new thermostat. As mentioned previously, T2 was used as an indicator of when the contacts opened and closed. The temperature values for T2 were translated to 0 and

1, where 0 indicates a closed contact and 1 indicates an open contact. The contacts opened when T1 was at 113.4°C and closed when T1 was at 49.6°C.

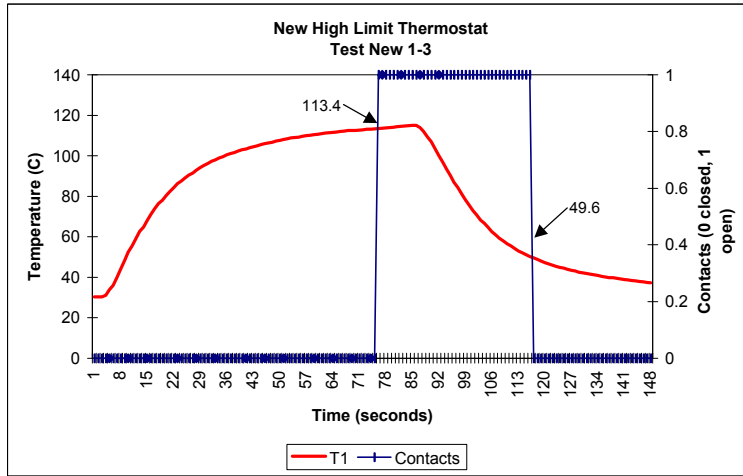

Figure 110. Thermocouple Data for the New High-Limit Thermostat

The second failed high limit thermostat (HLT2) was tested in the setup. An audible click could be heard when the bi-metal disc “popped.” When the bi-metal disc popped, it pushed on the rod, which should have separated the contacts. However, the T2 signal did not indicate a separation of the contacts. The resistance was measured at 0.0 to 0.1 ohms throughout the test.

Figure 111 shows a picture before the bi-metal disc popped and an after picture. The before picture (Bi-Metal Disc “Normal”) shows a small gap between the rod and the arm for the moving contact. The after figure shows the rod had moved and contacted the arm which should separate the contacts. However, the contacts remained closed.

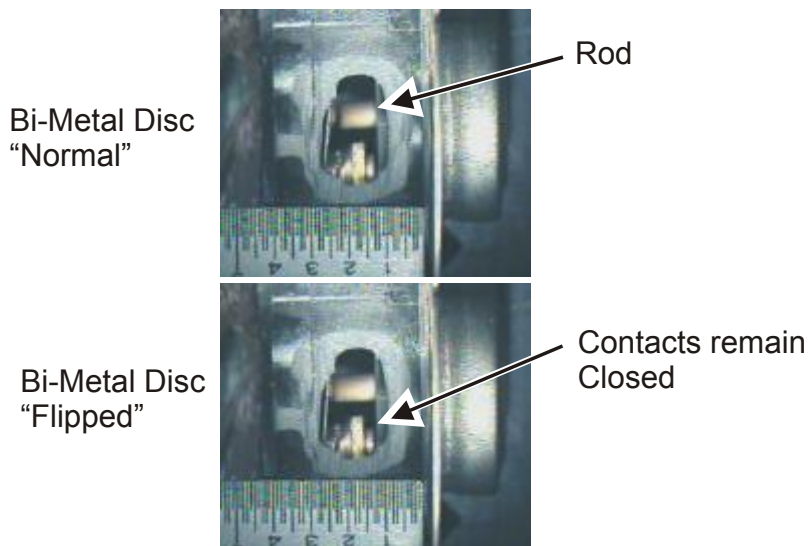

Figure 111. Second Failed High Limit Thermostat, HLT2



Figure 112 shows a comparison between a new (exemplar) high limit thermostat and the second failed high limit thermostat (HLT2). When the HLT2 thermostat was tested, an audible click could be heard at approximately 113°C and 35.5°C, indicating that the opening and closing temperatures for the failed HLT2 thermostat. The new thermostat opening and closing temperatures were similar.

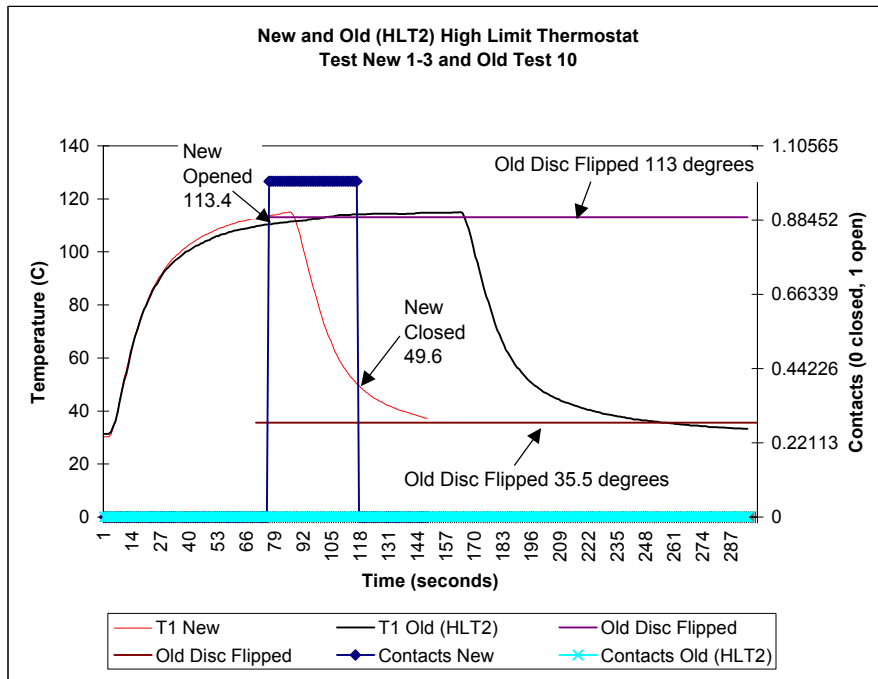

Figure 112. Comparison between New and Failed High Limit Thermostats

## 4.0 SUMMARY AND CONCLUSIONS

The overall goal of the project was to determine whether lint accumulation could result in clothes dryer fires. To accomplish this large goal, separate tasks were designed to link the cause of lint accumulation to possible dryer fires and/or lint ignition. The smaller tasks completed were:

- Task 1. Inspect and Record Dryer Designs
- Task 2. Document Dryer Operating Characteristics
- Task 3. Monitor Lint Distribution, and
- Task 4. Determine Characteristics Required for Lint Ignition.

The objective of this project was to evaluate the effects of lint accumulation and above-normal operating temperatures in electric clothes dryers and determine whether such conditions may result in dryer fires and/or lint ignition. The project demonstrated the following,

- ◆ Lint accumulates inside a dryer with properly vented exhaust ducting and with properly maintained lint screen (as discussed in Section 3.3 Task 3, Monitor Lint Distribution)
- ◆ Lint on the heater housing and in proximity to the heater intake can ignite (as discussed in Section 3.4 Task 4, Determine Characteristics Required for Lint Ignition), and
- ◆ Material downstream of the heater can be ignited by lint ingested by the heater (as discussed in Section 3.4 Task 4, Determine Characteristics Required for Lint Ignition).

The following provides a summary for each task presented in Section 3.0 Discussion:

### Task 1. Inspect and Record Dryer Design

- ◆ All four dryer designs used the same method and order for moving the air through the dryer.
  - Air was pulled into the body of the dryer through any gaps in the dryer, but typically through rear vents. It was drawn through the heater, which warmed the air, and then entered the tumbler. The air exited the tumbler and was directed through the lint screen. It passed through a duct in the dryer and into the fan. The fan forced the air through an exiting duct to the back of the dryer, where it was exhausted.
- ◆ The dryer designs had variations in the location and configuration of the heater, the location the air exited out of the tumbler, and location and size of the lint screen.
- ◆ The length of the dryer's exhaust duct extending out of the dryer may not allow the house duct to slide far enough onto the dryer's exhaust duct to provide a secure pressure fit.

- ◆ Using rigid external ducting does not allow for a secure pressure fit around the dryer's exhaust duct.

## Task 2. Document Dryer Operating Characteristics

- ◆ The temperatures within the dryer, under both normal and abnormal conditions, were similar for the four different dryer designs tested, with only slight variations due to dryer internal configurations.
  - The temperatures measured inside the heater box, heater intake, and intake into the tumbler increased when the exhaust duct was partially blocked or fully blocked. The temperatures inside the tumbler, blower and exhaust vent decreased when the exhaust vent was partially blocked or fully blocked.
  - When the exhaust vent was blocked up to 50 percent, the temperatures inside the dryer were similar to those measured when there was no blockage of the exhaust vent. When the exhaust vent was 75 percent or 100 percent blocked, temperatures in certain areas inside the dryer increased significantly.
    - For one dryer design, the heater intake temperature reached temperatures over 200° C for the 100% blocked exhaust condition, a 92% increase over the unblocked condition. For all dryer designs, the average maximum temperature was near 325° C for the 100% blocked exhaust condition, a 351% increase over the unblocked condition.
    - For one dryer design, the heater exhaust temperature reached nearly 600° C, an 89% increase over the unblocked condition. For all dryer designs, the average maximum temperature was near 600° C for the 100% blocked exhaust condition, an 89% increase over the unblocked condition.
    - For one dryer design, the heater housing temperature reached over 200° C, a 92% increase over the unblocked condition. For all dryer designs, the average maximum temperature was over 200° C for the 100% blocked exhaust condition, a 92% increase over the unblocked condition.
  - Under normal operation, the airflow inside the exhaust vent decreased dramatically as the lint screen became blocked with lint particles. For all dryer designs, the average exhaust air velocity with an unblocked exhaust vent dropped from 1300 sfpm (standard feet per minute) to 900 sfpm.
  - In general, the dryers only cycled on the high-limit thermostat when the exhaust vent was 75 or 100% blocked, which caused the temperatures near the heater to increase significantly.

- When the primary thermostat was bypassed (simulating a thermostat failure), the dryer operated at higher than normal temperatures – temperatures similar to those measured when the exhaust vent was blocked 50 to 75%. In general (3 of the 4 dryer designs tested), a failed-closed primary thermostat did not cause the dryer to cycle on the high limit thermostat for the unblocked exhaust vent condition.

### Task 3. Monitor Lint Distribution

- ◆ Lint begins to accumulate inside a dryer chassis upon first use. Lint accumulates on the dryer's components, including the heater and the dryer floor. This accumulation occurs even when the dryer's lint screen has been cleaned after each usage, and the dryer is properly exhausted.
- ◆ After 100 cycles, there was evidence of lint settling on dryer components and inside the dryer floor. Leaks in the fan housing and exhaust vent allowed lint-containing air inside the dryer chassis.
- ◆ Seals in the dryer's interior exhaust venting may not be adequate to prevent linty air from escaping into the dryer's interior.

### Task 4. Determine Characteristics Required for Lint Ignition

- ◆ Lint that accumulates on the heater housing can ignite under conditions of a failed high-limit thermostat and a blocked exhaust vent.
  - Lint on the heater housing ignited under certain conditions.
    - Lint ignited on the heater housing when the airflow through the heater was 100% blocked and the high-limit thermostat had been bypassed (simulating a thermostat failing to open).
    - Only some areas of the heater housing were susceptible to lint igniting, under certain conditions.
    - In most conditions, lint tended to be consumed by pyrolysis or thermal decomposition.
- ◆ Lint accumulating near the heater intake can ignite before the high-limit thermostat switches the heater element off.
  - Lint placed at the heater intake ignited under certain conditions. Under some conditions of reduced airflow, lint near the heater ignited even with a functional high-limit thermostat.
    - Lint ignited up to 5 inches from the heater element with no airflow into the heater and the high-limit thermostat bypassed.

- Lint ignited up to 3 inches from the heater element with no airflow through the heater and with a functional high-limit thermostat (i.e., thermostat connected in series with the heater element).
- Lint placed 3 inches from the heater element ignited with airflow into the heater reduced to 300 sfpm. The high-limit thermostat was connected in series with the heater element.
- ◆ Lint ingested by the heater and embers expelled from the heater exhaust can easily ignite additional lint or fabric in the air stream, resulting in additional embers in the dryer system and exhaust vent.
  - Lint ingested into the heater ignited material downstream.
    - In all three tests conducted, lint samples ingested into the heater ignited additional lint material downstream. The lint samples ingested by the heater weighed only 0.10 gram.
    - Lint samples ingested into the heater ignited a sample of 100% cotton towel material in the air stream. The lint samples ingested by the heater weighed 0.30 gram.

The CPSC staff noted the following during testing and analysis of the data:

- ◆ The high-limit thermostat may prematurely fail when subjected to high ambient temperatures.
  - Two high-limit thermostats failed during the test program.
    - The first high-limit thermostat failed after approximately 10 hours and 47 cycles (includes total estimated time the thermostat was exposed to temperatures above and below the upper set point).
    - The second high-limit thermostat failed after approximately 98 hours and 26 cycles (includes total estimated time the thermostat was exposed to temperatures above and below the upper set point).

## **Appendices A to J**

**The appendices can be accessed under the voluntary standards page at [www.cpsc.gov](http://www.cpsc.gov)**

### **Appendices**

Appendix A - Additional test data on Dryer Design A – Task 2

Appendix B - Additional test data on Dryer Design B – Task 2

Appendix C - Additional test data on Dryer Design C – Task 2

Appendix D - Additional test data on Dryer Design D – Task 2

Appendix E - Additional data for Task 3

Appendix F - Additional test data for Task 4 (Lint on the Heater Housing)

Appendix G - Additional test data for Task 4 (Lint at the Heater Intake)

Appendix H - Additional test data for Task 4 (Lint Ingested into the Heater)

Appendix I - Supporting test data for Discussion

Appendix J - Video clips of Task 4 testing