

MATERIAL: **COMPOSITION SHINGLE**
 PRODUCT: **LOW PROFILE (TAPERED)**

1. SELECT METAL

Standard:

 26 Gauge, G-90 Galvanized Steel
20 Year Warranty

Upgrade Options:

 .032" Aluminum
50 Year Warranty

 16 Oz. Copper
50 Year Warranty

2. SELECT FINISH

Upgrade Options:

Pre-Painted Galvanized Steel Finish*

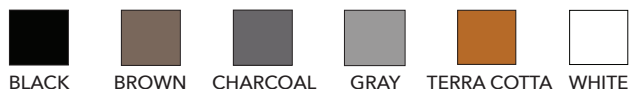

3. SELECT OPTIONS

Standard:

4" Flange

Upgrade Options:

6" Extended Flange

High Wind Diverter***

4. SELECT WIRE MESH

NFVA**

Standard:

1/4" Galvanized 72.00 sq. in.

Upgrade Options:

1/4" Stainless Steel 72.00 sq. in.

  72.00 sq. in.

1/8" Galvanized 64.80 sq. in.

1/8" Stainless Steel 64.80 sq. in.

* Colors may vary between lots, subject to increased lead times based on availability.
 ** Net Free Ventilation Area figures based on independent evaluation reports.
 *** Standard in Florida.

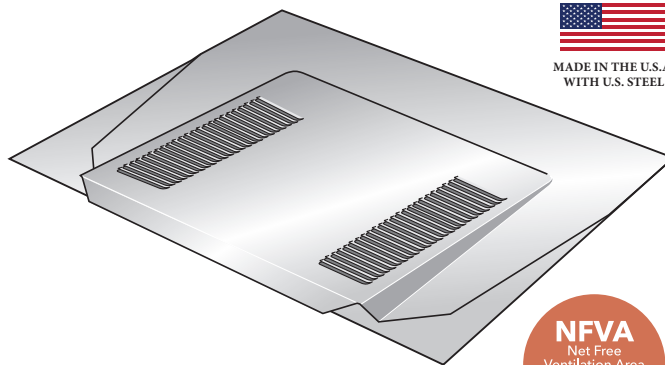

NFVA
Net Free Ventilation Area
72.00
Sq. In.

**UNIQUE LOW-PROFILE DESIGN
 FITS BELOW MOST ROOF MOUNTED
 SOLAR PANEL INSTALLATIONS**



FIRE & ICE
ATTIC
PLANS

FREE VENT LAYOUT AND CALCULATIONS

Send us your plans.
No plans? No problem.
 Provide us with your address and roofing material. We'll figure out the rest. vent@ohagin.com



STEP BY STEP
EASY
INSTALL
VIDEOS

WATCH OUR INSTALL VIDEOS

Scan this QR Code with your smart phone to watch easy step-by-step install videos.

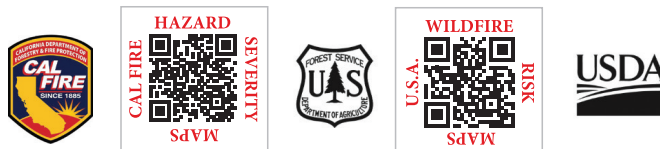

If you live in a Wildland Urban Interface area (WUI), upgrade to our **FIRE&ICE®** product line. Scan the QR Codes below with your smart phone to learn more.

LOCAL AND NATIONAL APPROVALS

O'Hagin is a recognized leader in attic ventilation testing and design.



www.ohagin.com

210 Classic Court, Suite 100 • Rohnert Park, CA 94928
 Toll Free 877-324-0444 • Fax 707-588-9187

O'HAGIN IS PROUD TO WORK WITH THESE AND MANY OTHER QUALITY MANUFACTURERS



MATERIAL: **SYNTHETIC SHAKE AND SLATE**

PRODUCT: **LOW PROFILE (TAPERED)**

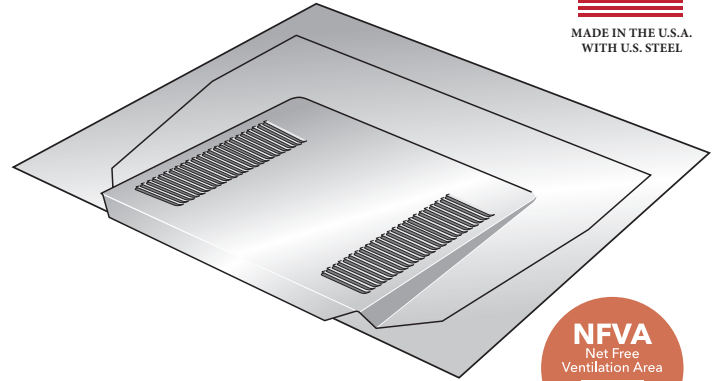

NFVA
Net Free
Ventilation Area
72.00
Sq. In.

**UNIQUE LOW-PROFILE DESIGN
FITS BELOW MOST ROOF MOUNTED
SOLAR PANEL INSTALLATIONS**

1. SELECT METAL

Standard:

 26 Gauge, G-90 Galvanized Steel
20 Year Warranty

Upgrade Options:

 .032" Aluminum
50 Year Warranty

 16 Oz. Copper
50 Year Warranty

2. SELECT FINISH

Upgrade Options:

Pre-Painted Galvanized Steel Finish*

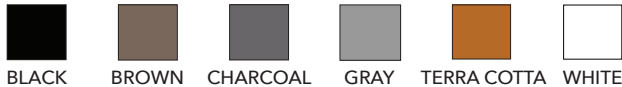

3. SELECT OPTIONS

Standard:

6" Extended Flange

Upgrade Options:

High Wind Diverter***

4. SELECT WIRE MESH

NFVA**

Standard:

1/4" Galvanized 72.00 sq. in.

Upgrade Options:

1/4" Stainless Steel 72.00 sq. in.

  72.00 sq. in.

1/8" Galvanized 64.80 sq. in.

1/8" Stainless Steel 64.80 sq. in.

* Colors may vary between lots, subject to increased lead times based on availability.
** Net Free Ventilation Area figures based on independent evaluation reports.
*** Standard in Florida.



FREE VENT LAYOUT AND CALCULATIONS

Send us your plans.

No plans? No problem.

Provide us with your address and roofing material. We'll figure out the rest. vent@ohagin.com



WATCH OUR INSTALL VIDEOS

Scan this QR Code with your smart phone to watch easy step-by-step install videos.



If you live in a Wildland Urban Interface area (WUI), upgrade to our **FIRE&ICE**® product line. Scan the QR Codes below with your smart phone to learn more.

LOCAL AND NATIONAL APPROVALS

O'Hagin is a recognized leader in attic ventilation testing and design.



www.ohagin.com

210 Classic Court, Suite 100 • Rohnert Park, CA 94928
Toll Free 877-324-0444 • Fax 707-588-9187

O'HAGIN IS PROUD TO WORK WITH THESE AND MANY OTHER QUALITY MANUFACTURERS



MATERIAL: **NATURAL SLATE**
 PRODUCT: **LOW PROFILE (TAPERED)**

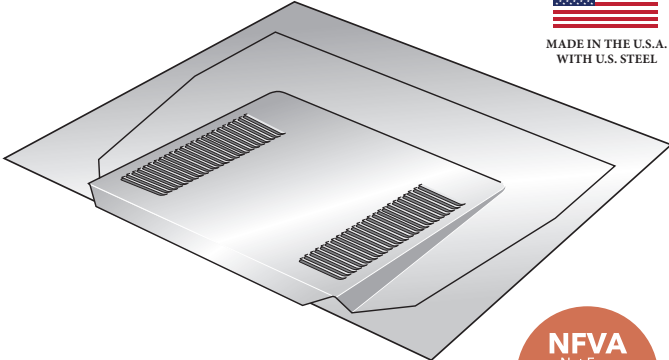

NFVA
 Net Free
 Ventilation Area
72.00
 Sq. In.

1. SELECT METAL

Standard:

 26 Gauge, G-90 Galvanized Steel
 20 Year Warranty

Upgrade Options:

 .032" Aluminum
 50 Year Warranty

 16 Oz. Copper
 50 Year Warranty

2. SELECT FINISH

Upgrade Options:

Pre-Painted Galvanized Steel Finish*

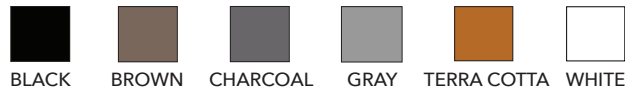

3. SELECT OPTIONS

Standard:



6" Extended Flange

Upgrade Options:

High Wind Diverter***

4. SELECT WIRE MESH

NFVA**

Standard: 1/4" Galvanized	72.00 sq. in.
Upgrade Options: 1/4" Stainless Steel	72.00 sq. in.
 	72.00 sq. in.
1/8" Galvanized	64.80 sq. in.
1/8" Stainless Steel	64.80 sq. in.

* Colors may vary between lots, subject to increased lead times based on availability.
 ** Net Free Ventilation Area figures based on independent evaluation reports.
 *** Standard in Florida.

**UNIQUE LOW-PROFILE DESIGN
 FITS BELOW MOST ROOF MOUNTED
 SOLAR PANEL INSTALLATIONS**



FREE VENT LAYOUT AND CALCULATIONS

Send us your plans. No plans? No problem.
 Provide us with your address and roofing material. We'll figure out the rest. vent@ohagin.com



WATCH OUR INSTALL VIDEOS

Scan this QR Code with your smart phone to watch easy step-by-step install videos.



If you live in a Wildland Urban Interface area (WUI), upgrade to our **FIRE&ICE**® product line. Scan the QR Codes below with your smart phone to learn more.

LOCAL AND NATIONAL APPROVALS

O'Hagin is a recognized leader in attic ventilation testing and design.



www.ohagin.com

210 Classic Court, Suite 100 • Rohnert Park, CA 94928
 Toll Free 877-324-0444 • Fax 707-588-9187

O'HAGIN IS PROUD TO WORK WITH THESE AND MANY OTHER QUALITY MANUFACTURERS



MATERIAL: **WOOD SHAKE**
 PRODUCT: **LOW PROFILE (TAPERED)**

1. SELECT METAL

Standard:

 26 Gauge, G-90 Galvanized Steel
20 Year Warranty

Upgrade Options:

 .032" Aluminum
50 Year Warranty

 16 Oz. Copper
50 Year Warranty

2. SELECT FINISH

Upgrade Options:

Pre-Painted Galvanized Steel Finish*

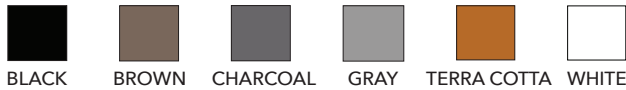

3. SELECT OPTIONS

Standard:



6" Extended Flange

Upgrade Options:

High Wind Diverter***

4. SELECT WIRE MESH

NFVA**

Standard:	NFVA**
1/4" Galvanized	72.00 sq. in.
Upgrade Options:	
1/4" Stainless Steel	72.00 sq. in.
 	72.00 sq. in.
1/8" Galvanized	64.80 sq. in.
1/8" Stainless Steel	64.80 sq. in.

* Colors may vary between lots, subject to increased lead times based on availability.

** Net Free Ventilation Area figures based on independent evaluation reports.

*** Standard in Florida.

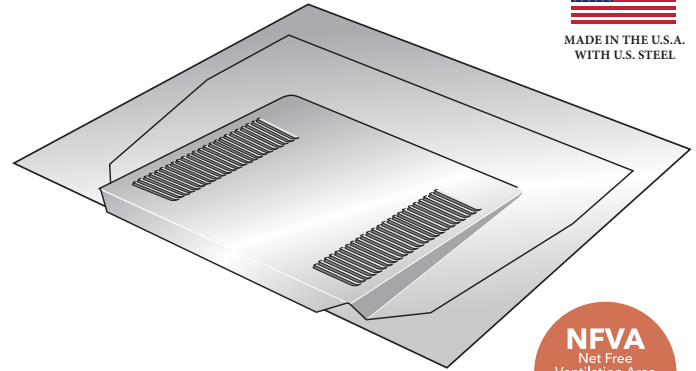

NFVA
Net Free Ventilation Area
72.00
Sq. In.

**UNIQUE LOW-PROFILE DESIGN
 FITS BELOW MOST ROOF MOUNTED
 SOLAR PANEL INSTALLATIONS**



FREE VENT LAYOUT AND CALCULATIONS

Send us your plans.
No plans? No problem.

Provide us with your address and roofing material. We'll figure out the rest. vent@ohagin.com



WATCH OUR INSTALL VIDEOS

Scan this QR Code with your smart phone to watch easy step-by-step install videos.



If you live in a Wildland Urban Interface area (WUI), upgrade to our **FIRE&ICE**® product line. Scan the QR Codes below with your smart phone to learn more.

LOCAL AND NATIONAL APPROVALS

O'Hagin is a recognized leader in attic ventilation testing and design.



www.ohagin.com

210 Classic Court, Suite 100 • Rohnert Park, CA 94928
 Toll Free 877-324-0444 • Fax 707-588-9187

O'HAGIN IS PROUD TO WORK WITH THESE AND MANY OTHER QUALITY MANUFACTURERS

