



Guide for professionals

ECOFLO | **REWATEC**



Certified to CAN/BNQ standard 3680-600



Certified to BNQ standard NQ 3680-910



Certified to NSF/ANSI standard 40 & 245



Made in Canada

People and Technologies making a difference

Premier Tech brings to life products that help feed, protect, and improve our world.

- **founded in 1923**
- **family business**
- **2,420 team members in North America**
- **4,700 team members worldwide**
- **24 manufacturing facilities in North America**
- **47 factories in 27 countries**



Through its Water and Environment business group, Premier Tech designs and manufactures sustainable local solutions for:

wastewater treatment

residential

commercial



rainwater harvesting

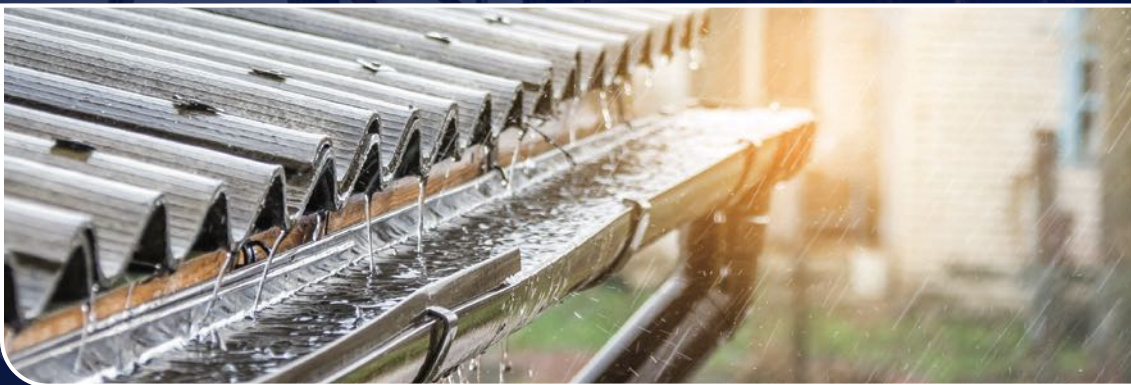

Together, we make green technologies accessible and continuously innovate to create solutions that last.

Premier Tech's 360° support

Since 1995, professionals have been the heart of our business.

IMMEDIATE ASSISTANCE

Experts available Monday to Friday to answer your field questions.



IN-PERSON FIELD SUPPORT

Experts go on site when challenges cannot be resolved with a video call.



ACCESSIBLE TRAINING

Online training programs make your installations as simple as possible.





MOST COMPLETE WARRANTY IN THE INDUSTRY

Since 1995, we have proudly developed sustainable products with warranties that are clear and complete.



AFTER-SALES SERVICE FROM THE MANUFACTURER

Largest network of local partners to maintain systems and honour warranties.



PRO SPACE

Quickly find all the documents you need in one place.



FULL CUSTOMER SUPPORT

Teams directly assist customers, so you can concentrate on your work.

Ecoflo is how we make a sustainable difference. Together.

Join us in the movement to make the world a better, more sustainable place. Protect your client's property and the environment by recommending Ecoflo, the most eco-responsible septic system available.

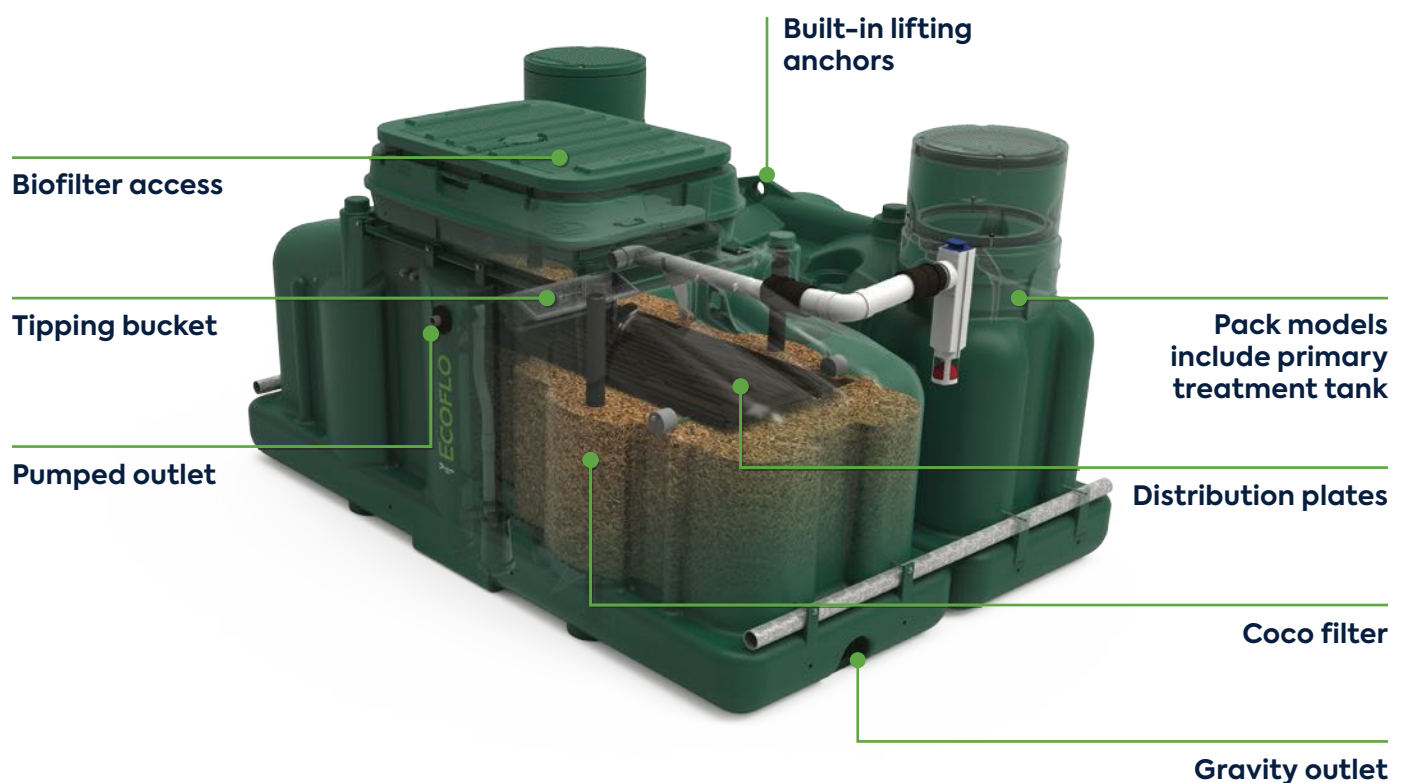

THE #1 COMPACT FILTER CHOICE!



**SEE HOW ECOFLO
IS INSTALLED**
[ECOFLO.LINK/YOUTUBE](https://www.ecoflo.com/ytube)

> QUICK INSTALLATION

- ready-to-use models
- easy-to-follow instructions
- can be installed in only one day

> MODELS FOR ANY SITE

- options for all soil conditions
- pumped or gravity discharge
- compact models

> PRODUCT AVAILABILITY

- 140 depots across North America
- quality-controlled inventory
- reliable order tracking

> 10-YEAR TOTAL WARRANTY

- all treatment-related parts and labour
- proper functioning of the filtering medium and its treatment performance
- no clogging or excess sludge

> ECOFLO OUTPERFORMS STANDARDS

(CAN/BNQ certification standard 3680-600)

| Parameter | Class B-IV Requirements* | Ecoflo Effluent† |
|-------------------------|--------------------------|------------------|
| TSS | ≤ 10 mg/L | 3 mg/L |
| CBOD₅ | ≤ 10 mg/L | 4 mg/L |
| Fecal coliforms | No requirement | — |

* 30-day average.

† With coco and peat filtering medium.

(NSF/ANSI standard 40 and 245)

| Parameter | Requirements* | Ecoflo Effluent† |
|-------------------------|----------------|------------------|
| TSS | < 25 mg/L | 8 mg/L |
| CBOD₅ | < 30 mg/L | 6 mg/L |
| Fecal coliforms | No requirement | — |

* 30-day average.

† With 100% coconut husk fragment filtering medium.

Ecoflo advantages for your clients

NATURAL, RENEWABLE, COMPOSTABLE FILTER

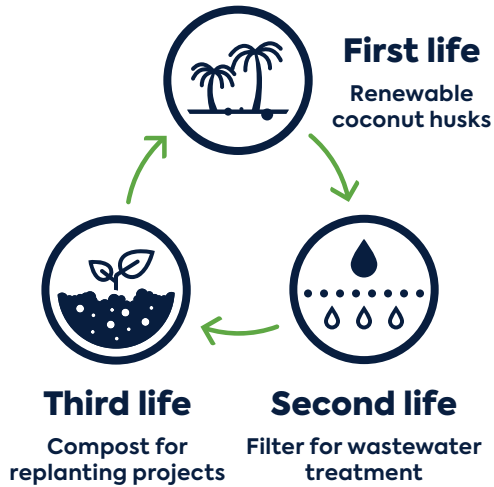

LOWEST CARBON FOOTPRINT

From production and shipping to installation, maintenance, and usage, Ecoflo has the lowest carbon footprint of any product on the market.

Total after 50-year life cycle

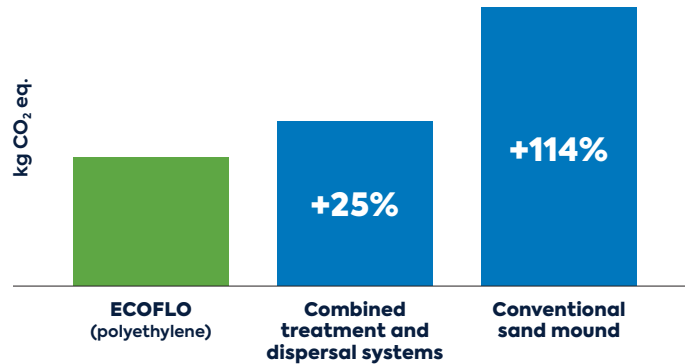

Notes

- Based on analysis of septic installations in Québec.
- Systems installed in very low permeability soil and rated for three bedrooms.
- Distances between installations and required materials assumed to be 60 km for filtration sand and stone, 33 km for backfill.
- Ecoflo installations include final dispersal to typical dispersal bed.

INSTALLED FOR LIFE

- easy installation
- never needs to be moved or replaced
- never damages your client's landscaping

PEACE-OF-MIND PERFORMANCE

- 24/7 autonomous operation
- never clogs your client's soil or contaminates their property
- worry-free warranty

BEST LONG-TERM INVESTMENT

- maintains the selling value of your client's property
- no energy bills for wastewater treatment
- no high-priced repairs or hidden costs
- no full-system replacements



A product supported by the manufacturer

INFO-SHARING VISIT

After each installation, we visit new owners on site to teach them how Ecoflo works, answer their questions, and make sure their septic system is working perfectly.

ANNUAL MAINTENANCE

We have a coast-to-coast network of partners, annually trained by us to maximize the life of your client's coco filter and protect their investment in their septic system.

- 15-point inspection
- coco filter aeration to promote healthy bacterial activity
- coco filter scarification to ensure optimal biofiltration

FILTER REPLACEMENT

By having the coco filter in their Ecoflo biofilter replaced after 10 to 15 years, your client guarantees their system always protects their property and the environment.

- no excavation required
- no damage to your client's landscaping
- used coco filters are 100% compostable (unlike petroleum-based filtering media)

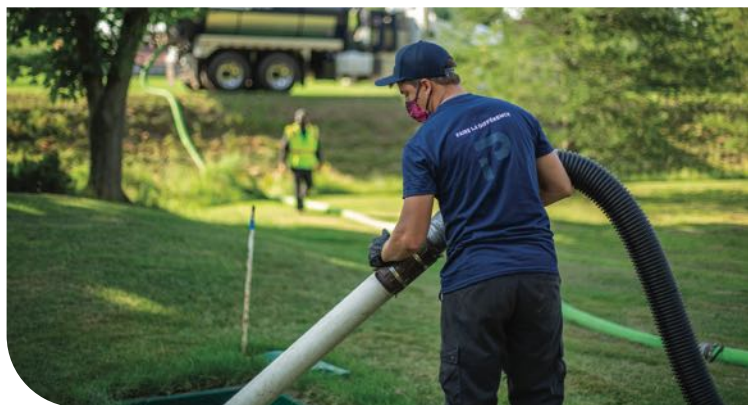

ECOFLO[®]

Polyethylene

Solution for:

- 5,000 L/d maximum capacity
- simple and quick installations
- sites with limited space

Advantages:

- install primary treatment tank and biofilter with one excavation*
- compact and lightweight*
- ready to use
- install in up to 600 mm (2') of groundwater (pumped models up to 2,800 L/d)
- one additional riser of 150 mm (6") allowed (up to 2,800 L/d)



* PACK model

ECOFLO[®]

Fibreglass

Solution for:

- 3,500 L/d maximum capacity
- sites with limited space
- remote locations

Advantages:

- Dispersal bed directly under the tank
- minimal final footprint
- compact and lightweight

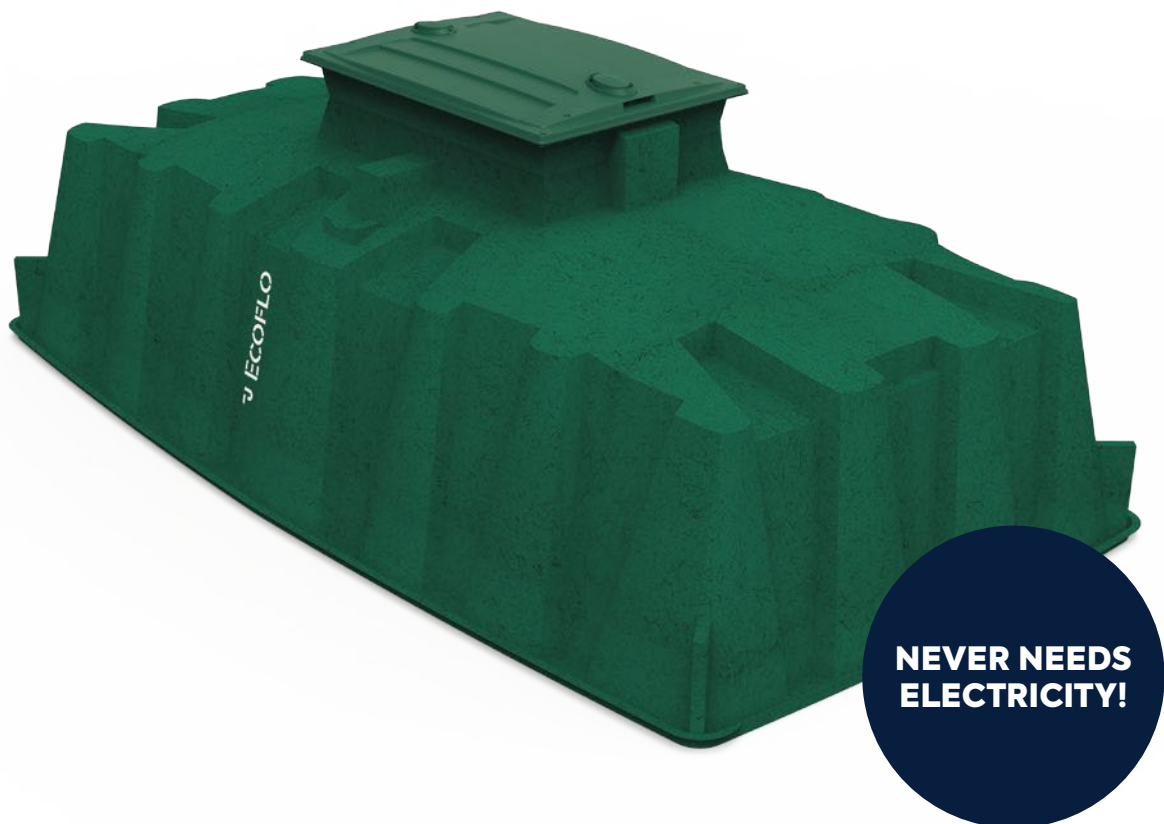

**NEVER NEEDS
ELECTRICITY!**

REWATEC™

Integrated UV disinfection (DiUV)

Our integrated DiUV option reliably kills wastewater pathogens, so you can safely send wastewater into a watercourse or ditch.

Wi-Fi system

Sends us instant alerts, so we can help your client protect their investment and the environment. If there is a problem, a service team will follow up on it.

Improved design

Strong, reliable parts ensure easy operation and maintenance.

New UV lamp

Maximizes flow while lowering energy consumption.

Integrated pump

Discharges treated wastewater in any site conditions and keeps ditch water out of the treatment unit.



READY TO INSTALL

We make installation fast and simple by pre-assembling and pre-wiring our UV disinfection units.

SOLUTIONS FOR ANY SITE

UV disinfection can be integrated in many polyethylene and concrete Ecoflo. It is also available in a separate tank.

TREATMENT RESULTS

| Parameter | BNQ* Effluent Standard | DiUV Effluent |
|-------------------------|------------------------------|-----------------------------|
| TSS | < 15 mg/L | 4 mg/L |
| CBOD₅ | < 15 mg/L | 4 mg/L |
| Fecal coliforms | < 20 CFU/100 mL [†] | < 2 CFU/100 mL [†] |

* Bureau de normalization du Québec certification, similar to NSF certification.

[†] Before photoreactivation.

INTEGRATED UV MODELS

| Models | Bedrooms |
|------------|----------|
| 2.8 | 3 |
| 3.4 | 4 |
| 4.1 | 5 |

REWATEC™

UV disinfection (DiUV)

CLASSIC UV DISINFECTION

INTEGRATED OR SEPARATE TANK

Quartz sleeve

Isolates UV lamp.

70 W UV lamp

Exposes wastewater pathogens to UV radiation.

Stainless steel pipe

Holds wastewater for UV disinfection.

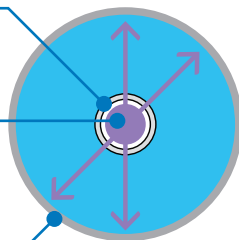

RECOMMENDED INFLUENT QUALITY

| Parameter | Level |
|----------------|------------------------|
| Iron | < 0.3 ppm (0.3 mg/L) |
| Manganese | < 0.05 ppm (0.05 mg/L) |
| Water hardness | < 7 gpg (120 mg/L) |

SELF-CLEANING UV DISINFECTION

SEPARATE TANK ONLY

Quartz sleeve

Holds wastewater for UV disinfection.

Stainless steel wiper blade

Cleans quartz sleeve six times per day.

108 W UV lamps

Expose wastewater pathogens to UV radiation.

Elliptical reflectors

Reflect UV radiation to optimize the treatment process.

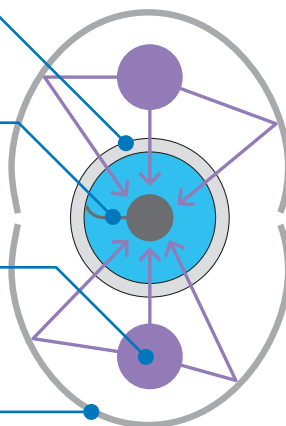

REWATEC™

Nitrogen reduction (ECDn)

Our nitrogen reduction option converts ammoniacal nitrogen into nitrogen gas, so you can safely discharge wastewater near ecologically sensitive areas.

Septic tank (with baffle)

Captures solids and clarifies wastewater.

Ecoflo

Filters wastewater through a coconut husk fragment filter. Converts ammoniacal and organic nitrogen into nitrates.

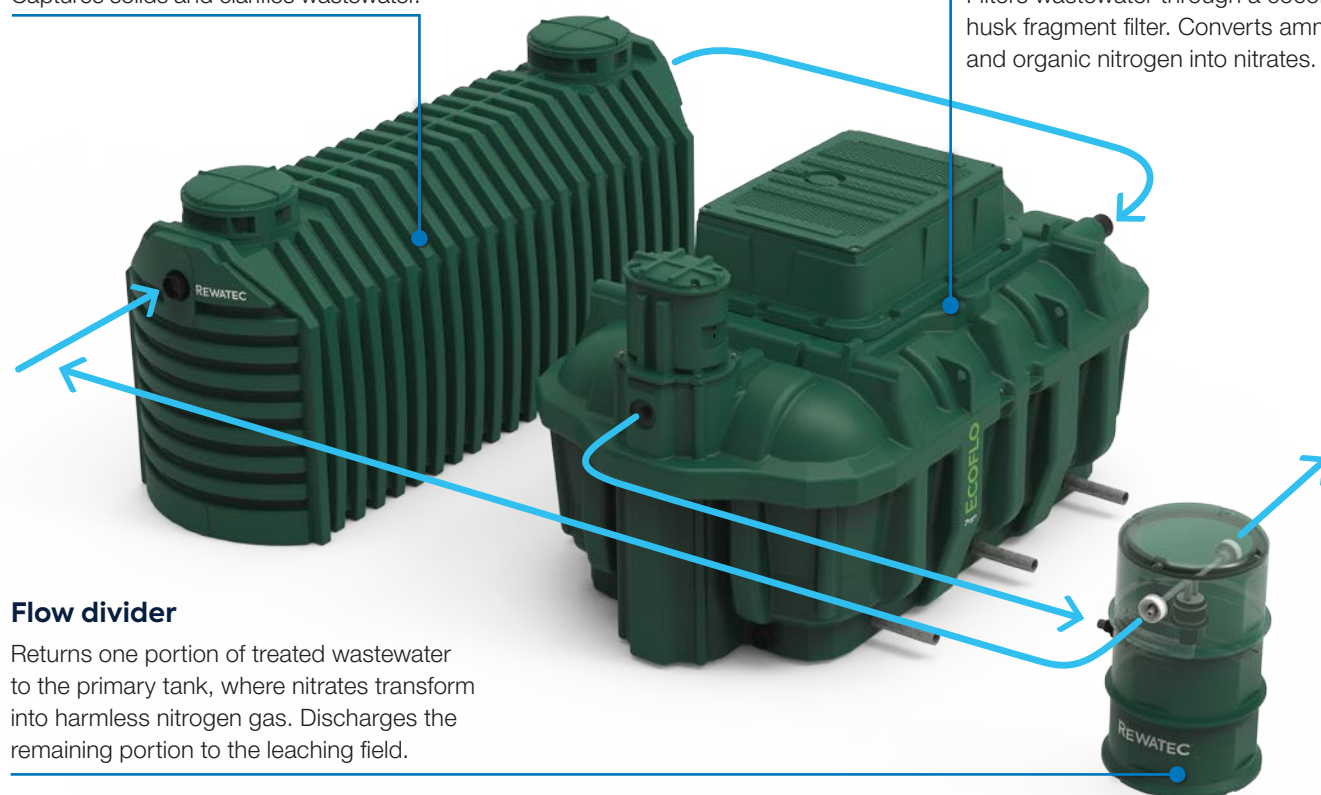

Flow divider

Returns one portion of treated wastewater to the primary tank, where nitrates transform into harmless nitrogen gas. Discharges the remaining portion to the leaching field.

COMPACT SIZE

Our nitrogen reduction option is ideal for sites with limited installation space.

SOLUTIONS FOR ANY SITE

Nitrogen reduction is available with many polyethylene and concrete Ecoflo.

TREATMENT RESULTS

| Parameter | NSF Effluent Standard | ECDn Effluent |
|--------------------------|-----------------------|---------------|
| TSS | < 30 mg/L | 2 ± 2 mg/L |
| CBOD ₅ | < 25 mg/L | 4 ± 3 mg/L |
| Total nitrogen reduction | > 50% | 54% |
| pH | 6 to 9 | 7.1 |

Refer to page 24 for technical information.

REWATEC™

Phosphorus removal (DpEC)

Without proper treatment, phosphorus in wastewater can cause harmful algae growth in lakes and rivers. Protect these sensitive areas with our phosphorus removal option.

Electrocoagulation unit

Reaction zone

Has two pairs of self-cleaning aluminum electrodes. Aluminum particles react with phosphorus in wastewater, transforming soluble phosphorus into solids compounds.

Separation zone

Clarifies wastewater. Solids return to the primary reactor for removal. Liquid wastewater flows to the sand filter for final treatment.

Watertight sand filter

Performs final wastewater treatment.

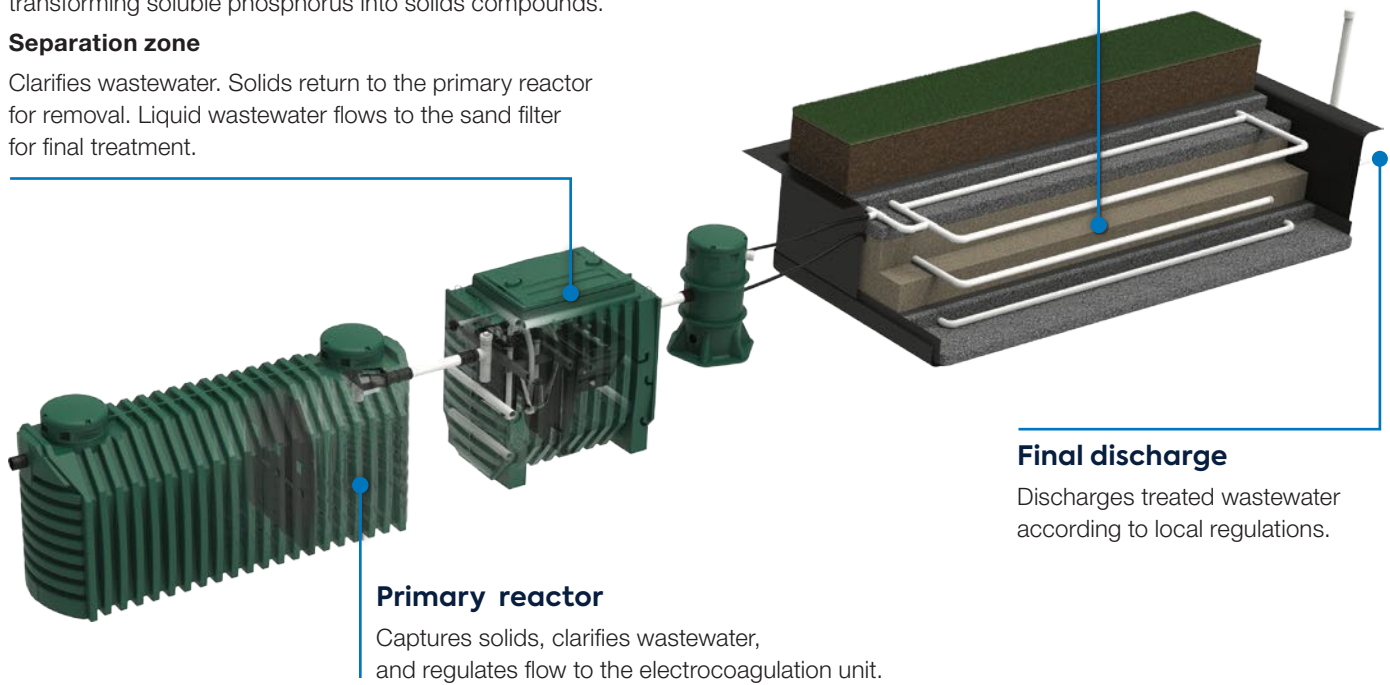

SURFACE DISCHARGE NEAR LAKES

Phosphorus removal preserves water quality in sensitive environments.

TREATMENT RESULTS

| Parameter | BNQ* Effluent Standard | DpEC + Sand Filter Effluent |
|-------------------|------------------------|-----------------------------|
| TSS | < 15 mg/L | 1 mg/L |
| CBOD ₅ | < 15 mg/L | 2 mg/L |
| Total phosphorus | < 1 mg/L | 0.04 mg/L |
| Fecal coliforms | < 200 CFU/100 mL | < 47 CFU/100 mL |

* Bureau de normalization du Québec certification, similar to NSF certification.

REWATEC™

Components and accessories

SEPTIC TANKS

- up to 6,600 L total nominal capacity
- high-strength polyethylene

Refer to page 25
for technical information.



PUMPING STATIONS

- up to 255 L effective dosing volume

Refer to page 26
for technical information.



PUMPS

- up to 0.5 hp
- reliable and durable

Refer to page 26
for technical information.



FLOW DIVIDERS

- pressurized or gravity flow
- two to 10 outlets



RISERS



- from 150 to 355 mm
(6" to 14")





Product specifications

Product line

| <div style="text-align: center;">  </div> | | |  SPECIALIZED TREATMENT OPTIONS | | |
|--|------|---------------------|--|---|---------------------------|
| | | | Integrated UV disinfection (DiUV) | UV disinfection (DiUV) in separate tank | Nitrogen reduction (ECDn) |
| Hydraulic Capacity | Size | Model | | | |
| POLYETHYLENE | | | | | |
| 1,900 L/d | 2.8 | EC7-1900-P-G/P | ✓ | ✓ | See page 24 |
| | | EC7-1900-P-G/P-PACK | ✓ | ✓ | |
| 2,200 L/d | 3.4 | EC7-2200-P-G/P | ✓ | ✓ | |
| | | EC7-2200-P-G/P-PACK | ✓ | ✓ | |
| 2,800 L/d | 4.1 | EC7-2800-P-G/P | ✓ | ✓ | |
| | | EC7-2800-P-G/P-PACK | ✓ | ✓ | |
| 4,000 L/d | 5.7 | EC7-4000-P-G/P | ✗ | ✓ | |
| 5,000 L/d | 7.3 | EC7-5000-P-G/P | ✗ | ✓ | |
| FIBREGLASS | | | | | |
| 3,500 US gal/d | 5.0 | EC7-3500-F-O | ✗ | ✗ | ✗ |

NEED HELP?

For help choosing the right Ecoflo model, specialized treatment options, and accessories, call our expert in your area. You'll get free, professional advice to transform any challenge into a custom-made septic solution.

+1 800 632-6356

Recommended distances

We recommend the following distances guidelines. Failure to abide by these guidelines may void the warranty of the installation.

| Reference Points | Polyethylene | | Fibreglass |
|---|-------------------------------|-------------|-------------------------------|
| | 2.8, 3.4, 4.1 | 5.7, 7.3 | |
| Base of excess backfill, slopes, or embankments vs. biofilter lid | A | 4 m (13') | 5 m (16') |
| Parking area vs. biofilter lid | B | 4 m (13') | 5 m (16') |
| Object or structure weighing more than 225 kg (500 lb) vs. biofilter lid | C | 4 m (13') | 5 m (16') |
| Retaining wall vs. biofilter lid | D | 4 m (13') | 5 m (16') |
| Finished landscaping vs. base of biofilter lid | E | 50 mm (2") | |
| Seasonal high groundwater table (SHGT) vs. base of gravity-discharge unit | Do not install in groundwater | | |
| Seasonal high groundwater table (SHGT) vs. base of pumped-discharge unit | Fp | 600 mm (2') | Do not install in groundwater |

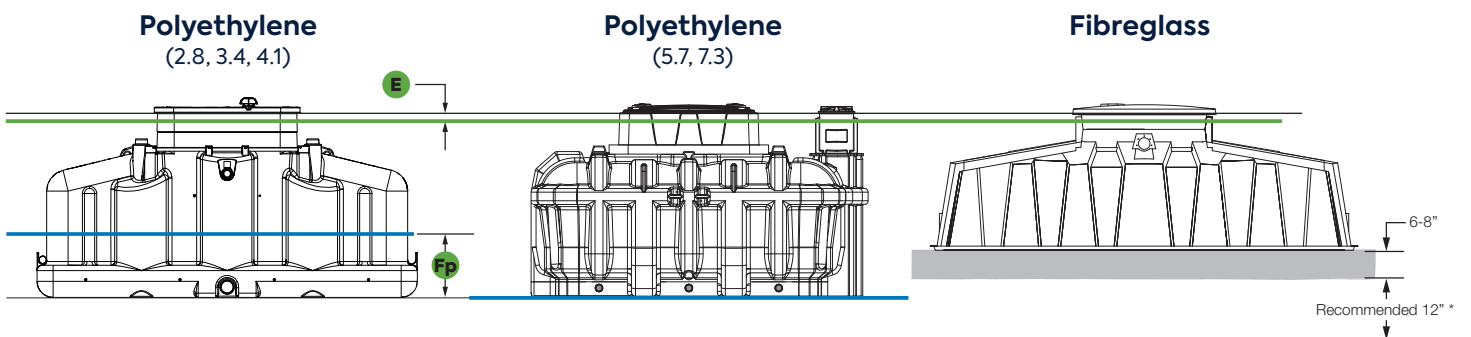
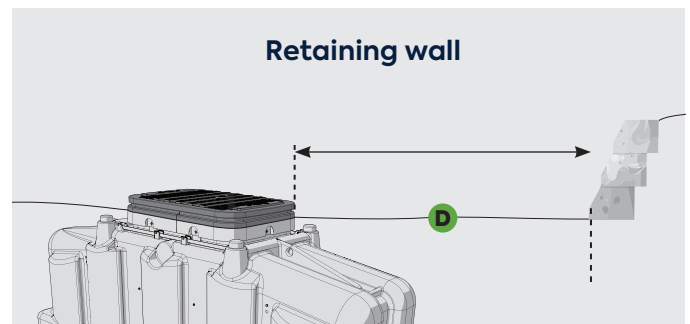
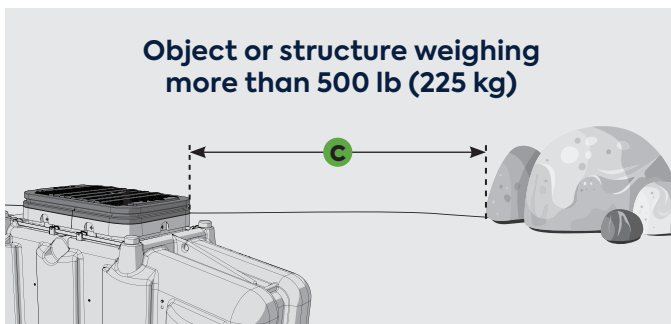
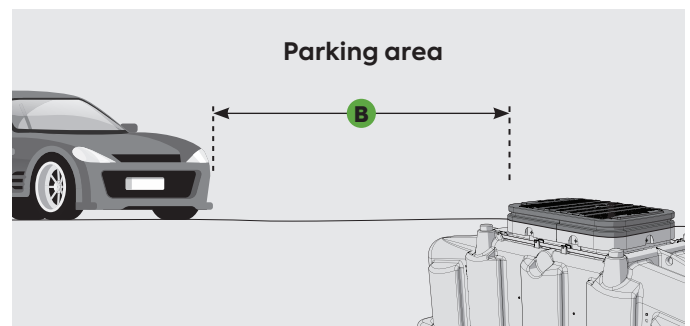
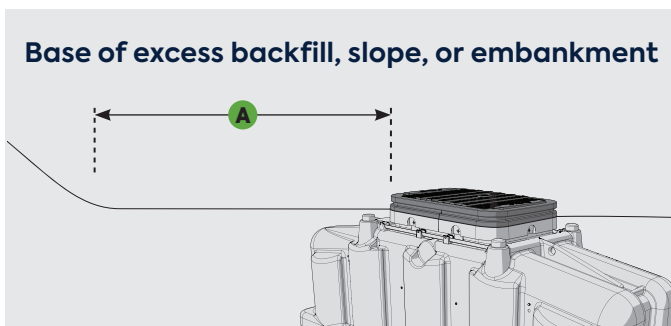

Legend: — Finished landscaping — SHGT

ECOFLO[®]

Polyethylene • PACK



| | 2.8 | 3.4 | 4.1 |
|---|----------------------|---------------------|---------------------|
| | EC7-1900-P-G/P-PACK | EC7-2200-P-G/P-PACK | EC7-2800-P-G/P-PACK |
| Hydraulic capacity | 1,900 L/d | 2,200 L/d | 2,800 L/d |
| Primary tank volume | 3,000 L | 3,785 L | 4,730 L |
| Length A | 3,120 mm (10' 3") | 3,550 mm (11' 8") | 4,050 mm (13' 4") |
| Width B | 2,480 mm (8' 2") | | |
| Height C Includes 12" of risers | 1,770 mm (5' 9-3/4") | | |
| Inlet height of primary tank from bottom D | 1,285 mm (4' 2-1/2") | | |
| Gravity water outlet height Eg | 44 mm (1-3/4") | | |
| Pumped water outlet height Ep | 1,140 mm (3' 9") | | |
| Riser height allowed | 150 mm (6") | | |
| Weight Includes internal components and coco filter | 760 kg (1,675 lb) | 850 kg (1,870 lb) | 950 kg (2,090 lb) |
| Built-in effective volume available for dosing Pumped discharge models only | 600 L | 680 L | 755 L |
| Emergency storage above alarm float | 2,065 L | 2,520 L | 2,875 L |

Water inlet

Ø 100 mm (4") nominal

Gravity water outlet

Ø 100 mm (4") nominal

Pumped water outlet

Ø 38 mm (1-1/2") or

Ø 25 mm (1") nominal

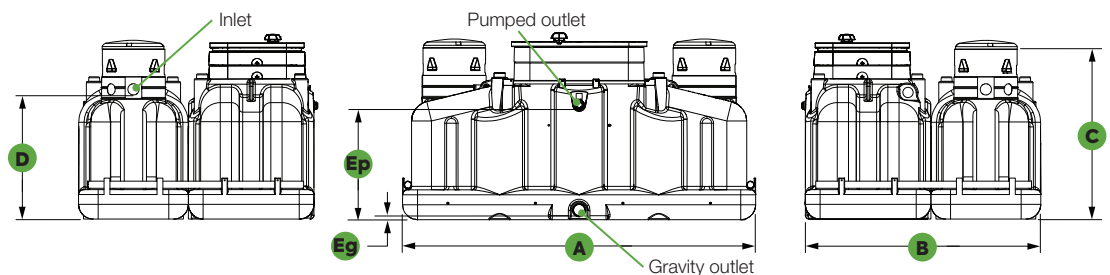

TYPICAL INSTALLATIONS

Gravity discharge to leaching field

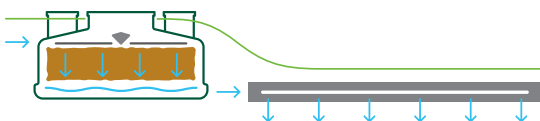

Pumped discharge to leaching field

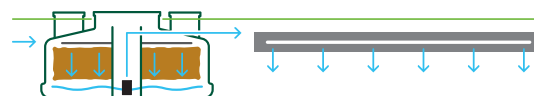

ECOFLO[®]

Polyethylene



| | 2.8 | 3.4 | 4.1 |
|--|----------------------|-------------------|-------------------|
| | EC7-1900-P-G/P | EC7-2200-P-G/P | EC7-2800-P-G/PDV |
| Hydraulic capacity | 1,900 L/d | 2,200 L/d | 2,800 L/d |
| Length A | 3,120 mm (10' 3") | 3,550 mm (11' 8") | 4,050 mm (13' 4") |
| Width B | 1,280 mm (4' 2") | | |
| Height C <small>Includes 12" of risers</small> | 1,770 mm (5' 9-1/2") | | |
| Inlet height from bottom D | 1,230 mm (4' 1/2") | | |
| Gravity water outlet height Eg | 44 mm (1-3/4") | | |
| Pumped water outlet height Ep | 1,140 mm (3' 9") | | |
| Riser height allowed | 150 mm (6") | | |
| Weight <small>Includes internal components and coco filter</small> | 560 kg (1,235 lb) | 610 kg (1,345 lb) | 660 kg (1,455 lb) |
| Built-in effective volume available for dosing <small>Pumped discharge models only</small> | 600 L | 680 L | 755 L |
| Emergency storage above alarm float | 2,065 L | 2,520 L | 2,875 L |

Water inlet

Ø 100 mm (4") nominal

Gravity water outlet

Ø 100 mm (4") nominal

Pumped water outlet

Ø 38 mm (1-1/2") or

Ø 25 mm (1") nominal

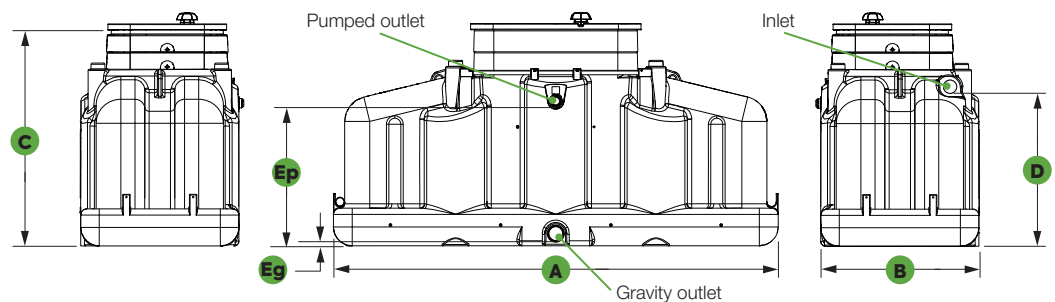

TYPICAL INSTALLATIONS

Gravity discharge to leaching field

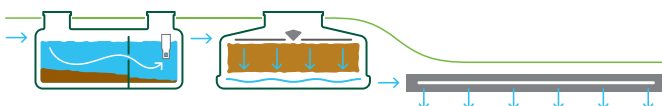

Pumped discharge to leaching field

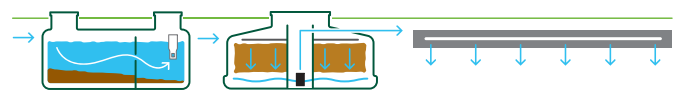

For float adjustments, see page 27.

ECOFLO[®]

Polyethylene



| | 5.7 | 7.3 |
|--|------------------------------|---------------------|
| | EC7-4000-P-G/PDV | EC7-5000-P-G/PDV |
| Hydraulic capacity | 4,000 L/d | 5,000 L/d |
| Length A | 3,380 mm (11' 1") | 4,130 mm (13' 7") |
| Width B | 1,840 mm (6' 1/2") | 2,050 mm (6' 9") |
| Height C | 1,850 mm (6' 1/2") | |
| Inlet height from bottom D | 1,260 mm (4' 2") | |
| Gravity water outlet height Eg | 76 mm (3") | |
| Pumped water outlet height Ep | 1,240 mm (4' 1") | |
| Riser height allowed | No additional risers allowed | |
| Weight <small>Includes internal components and coco filter</small> | 1,200 kg (2,640 lb) | 1,415 kg (3,120 lb) |
| Built-in effective volume available for dosing <small>Pumped discharge models only</small> | 870 L | 1,120 L |
| Total emergency storage capacity | 4,370 L | 6,030 L |

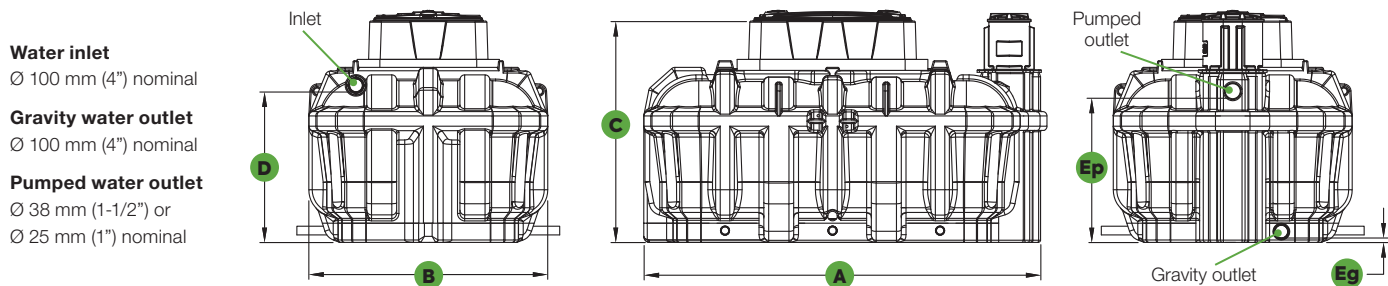

TYPICAL INSTALLATIONS

Gravity discharge to leaching field

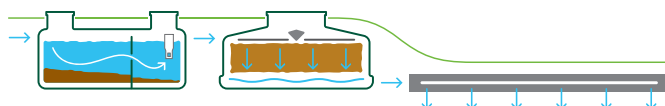

Pumped discharge to leaching field

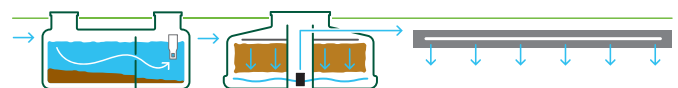

ECOFLO[®]

Fibreglass

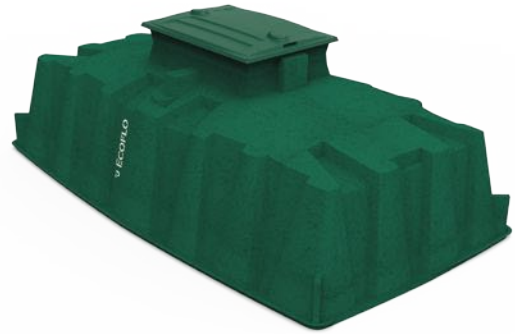

| | | 5.0 |
|--------------------------|---|-------------------|
| | | EC7-3500-F-O |
| Hydraulic capacity | | 3,500 L/d |
| Length | A | 3,345 mm (11') |
| Width | B | 2,361 mm (7' 9") |
| Height | C | 1,320 mm (4' 4") |
| Inlet height from bottom | D | 970 mm (3' 2") |
| Riser height allowed | | No risers allowed |
| Weight | | 115 kg (250 lb) |

Water inlet
 Ø 100 mm (4") nominal

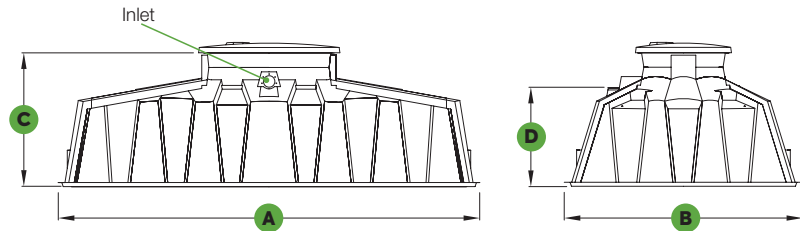

TYPICAL INSTALLATIONS

Infiltrated discharge on leaching field

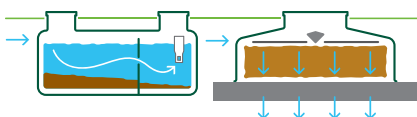

REWATEC™

Nitrogen reduction (ECDn)

TYPICAL INSTALLATION

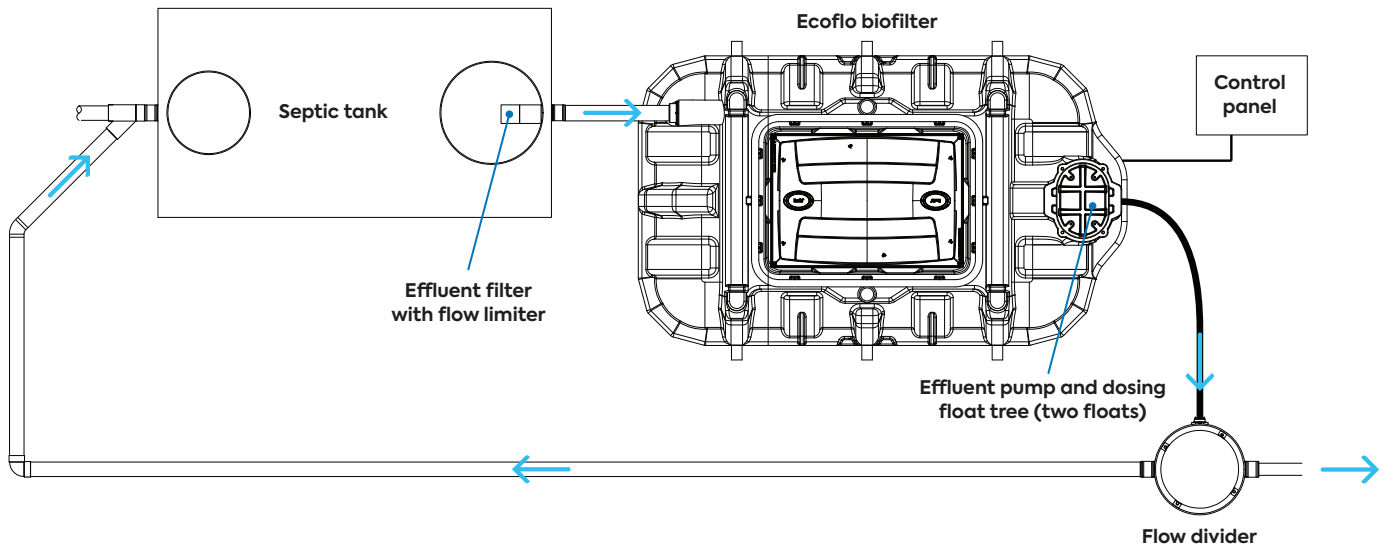

ECOFLO COMPATIBILITY

Polyethylene

| Hydraulic Capacity | Size | Model |
|--------------------|------|-------------|
| 1,900 L/d | 3.4 | ECDN-1900-P |
| 2,200 L/d | 4.1 | ECDN-2200-P |
| 3,250 L/d | 5.7 | ECDN-3250-P |
| 4,150 L/d | 7.3 | ECDN-4150-P |

REWATEC™

Septic and holding tanks



| | Septic Tanks with Effluent Filter | | | | | | Holding Tanks* |
|-----------------------------------|-----------------------------------|--------------------------|---------------------------|--------------------------|---------------------|-------------------------|--------------------|
| | PST-280 | PST-340 | PST-390 | PST-420 | PST-500 | PST-660 | PHT-660 |
| Total nominal capacity | 2,800 L | 3,400 L | 3,900 L | 4,300 L | 4,800 L | 6,650 L | 6,650 L |
| Liquid capacity | 2,260 L | 3,000 L | 3,300 L | 3,600 L | 4,100 L | 5,800 L | 5,900 L |
| Length A | 2,495 mm (8' 2") | 3,035 mm (9' 11-1/2") | 3,320 mm (10' 10-1/2") | 3,777 mm (12' 4-3/4") | 2,920 mm (9' 7") | 3,965 mm (13') | 3,965 mm (13') |
| Width B | 1,250 mm (4' 1-1/4") | | | 1,330 mm (4' 4-3/8") | | 1,330 mm (4' 4-3/8") | |
| Height C | 1,330 mm (4' 4-3/8") | | | 1,720 mm (5' 7-3/4") | | 1,890 mm (6' 2-3/8") | |
| Inlet height D | 1,055 mm (3' 5-1/2") | | | 1,400 mm (4' 7-1/8") | | 1,400 mm (4' 7-1/8") | |
| Outlet height E | 980 mm (3' 2-1/2") | | | 1,320 mm (4' 4") | | — | |
| Openings diameter F | 470 mm (1' 6-1/2") | | | | | | |
| Weight | 160 kg (353 lb) | 180 kg (397 lb) | 190 kg (419 lb) | 240 kg (529 lb) | 265 kg (584 lb) | 325 kg (717 lb) | 350 kg (772 lb) |
| Certification | BNQ/CSA | | | CSA | BNQ/CSA | | CSA |

* Certified for certain applications by Health Canada's Health Products and Food Branch.

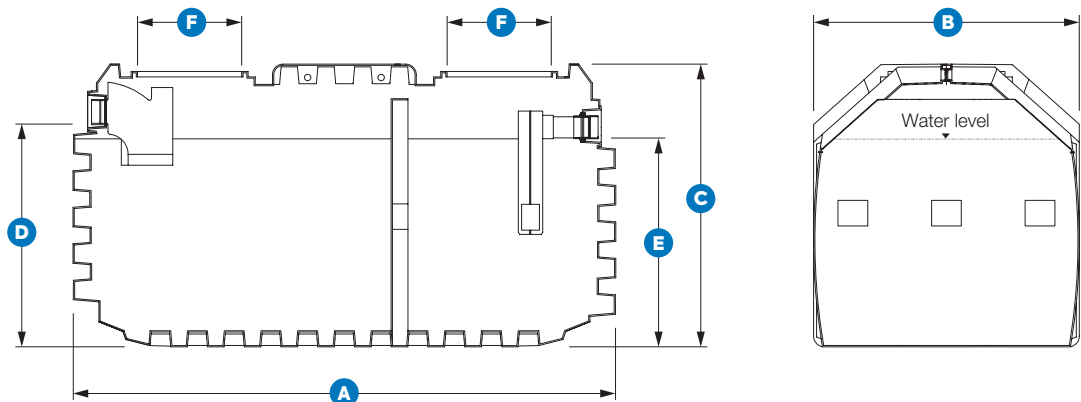

REWATEC™

Pumping stations



| | PSA-240 | PSA-240H |
|---|-------------------------------------|----------------------|
| Pump | 120 V | |
| Float | On/off pump switch and alarm switch | |
| Length of base A | 950 mm (3' 1-1/2") | |
| Width of base B | 865 mm (2' 10") | |
| Height C | 1,270 mm (4' 2") | 1,625 mm (5' 4") |
| Inlet height D | 635 mm (2' 1") | 1,060 mm (3' 5-3/4") |
| Outlet height E | 1,015 mm (3' 4") | |
| Riser height allowed | 710 mm (2' 4") | |
| Weight | 50 kg (110 lb) | 56 kg (123 lb) |
| Effective dosing volume | 150 L | 255 L |
| Total volume At water inlet level | 240 L | 400 L |

- Water inlet**
Ø 100 mm (4") nominal
- Water outlet**
Ø 38 mm (1-1/2") or
Ø 50 mm (2") nominal
- Air flow**
Ø 100 mm (4") nominal

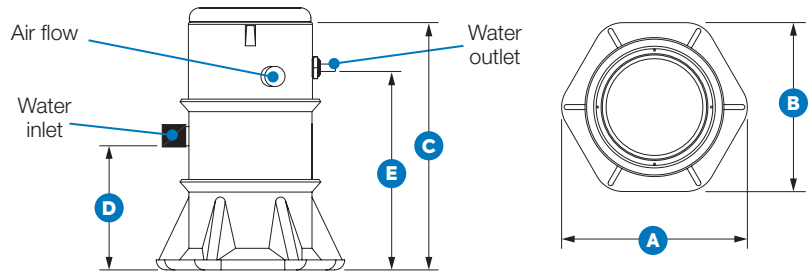

Pumps

PERFORMANCE CURVE

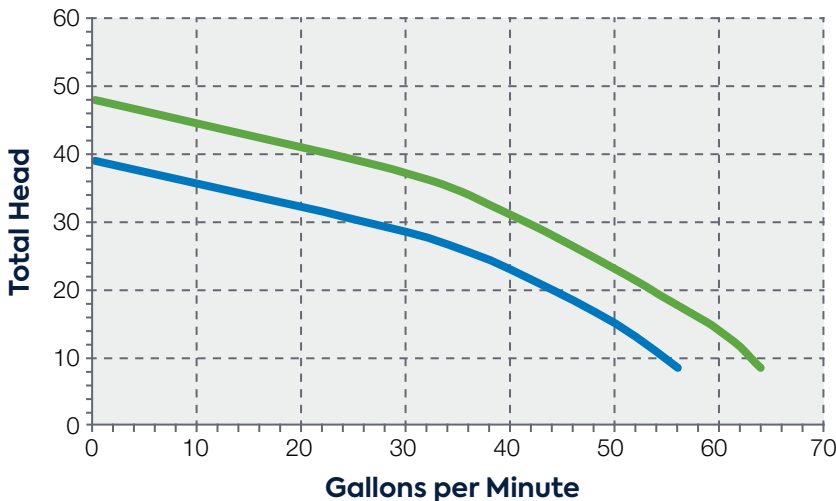

Parts and labour

Legend

- Champion 0.5 hp pump (with Ecoflo)
8.5 A, 1 phase, 60 Hz, 115 V
- Champion 0.4 hp pump (with integrated DiUV)
6.6 A, 1 phase, 60 Hz, 115 V

Float adjustments

The dose given by the on/off float depends on the length of the float stem, the length of the stem sleeve, and the position of the rubber stopper.

The factory setting will give the minimum dose. To customize the setting to accommodate local regulations or on-site requirements:

- cut a section of the stem sleeve
- lower the rubber stopper along the stem

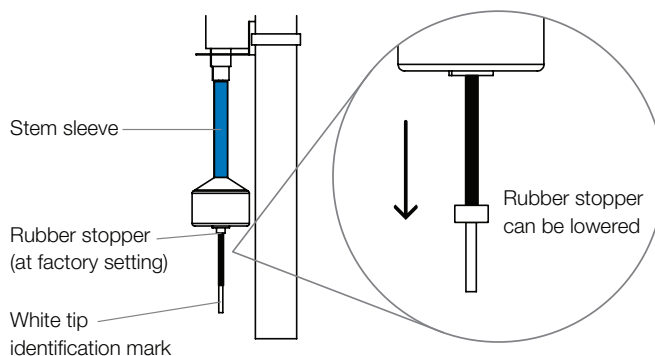

POLYETHYLENE

| Desired Dose Volume | | | | | Adjustment | Final Sleeve Length |
|---------------------|-------|-------|-------|---------|--|---------------------|
| 2.8 | 3.4 | 4.1 | 5.7 | 7.3 | | |
| 80 L | 91 L | 98 L | 76 L | | None (factory setting) | 115 mm (4-1/2") |
| 83 L | 114 L | 132 L | 114 L | 151 L | Lower rubber stopper 6 mm (1/4") along stem | 115 mm (4-1/2") |
| 303 L | 360 L | 379 L | 322 L | 435 L | Lower rubber stopper 64 mm (2-1/2") along stem* | 115 mm (4-1/2") |
| 398 L | 454 L | 492 L | 416 L | 587 L | Cut 25 mm (1") off sleeve and lower rubber stopper 64 mm (2-1/2") along stem* | 90 mm (3-1/2") |
| 492 L | 568 L | 625 L | 530 L | 738 L | Cut 50 mm (2") off sleeve and lower rubber stopper 64 mm (2-1/2") along stem* | 64 mm (2-1/2") |
| 606 L | 681 L | 757 L | 662 L | 890 L | Cut 75 mm (3") off sleeve and lower rubber stopper 64 mm (2-1/2") along stem* | 38 mm (1-1/2") |
| | | | 871 L | 1,117 L | Remove sleeve and lower rubber stopper 64 mm (2-1/2") along stem* | 0 mm (0") |

* Or until identification mark.



Premier Tech's 360° support

- exclusive and innovative service offer
- phone or interactive video assistance
- real-time diagnostics
- field support when necessary
- accessible training
- Pro Space dedicated to professionals

SALES AND SERVICES

+1 800 632-6356
info.ptwe.na@premiertech.com

ORDERS

+1 800 632-6356, ext. 16733
orders.ptwe.na@premiertech.com

CREDIT

+1 800 632-6356, ext. 16034
credit.ptwe.na@premiertech.com

Making a difference for water and the environment

At Premier Tech, People and Technologies connect in lasting, transformative ways, giving life to products and services that help feed, protect, and improve our world.

Our team of experts constantly innovates, redefining what is possible through effective, efficient, and sustainable solutions. Driven by a shared passion, we are committed to protecting our resources for the future.



PT Water and Environment

+1 800 632-6356
info.ptwe.na@premiertech.com
PT-WaterEnvironment.com



The information contained in this document was up-to-date and consistent with the information available at the time of publication. Premier Tech Ltd. makes no warranties or representations as to its accuracy. Because of its continuous improvement policy, Premier Tech Ltd. and its affiliated companies reserve the right to change and/or discontinue the manufacture of any product and/or modify technical data and prices, for any reason whatsoever and at its sole discretion, without further notice and without liability to anyone in this regard. ECOFLO®, REWATEC™, PREMIER TECH®, and PREMIER TECH & DESIGN™ are trademarks of Premier Tech Ltd. or its affiliates. Ecoflo® is protected under patents: CA2499637; US7097768; ES2285173; EP1539325 (BE, FR). Notice issued on 2019-01-11. For current data regarding all patent application(s) and patent(s) for this product or any part thereof, consult the website patentmarking.premiertech.com (reference: 3685).

© 2021 Premier Tech Ltd. All rights reserved.
Printed in Canada

Canada
20210323