

Water Specialist

1" Control Valve Series Model: WS1TC

1.25" Control Valve Series Model: WS1.25TC

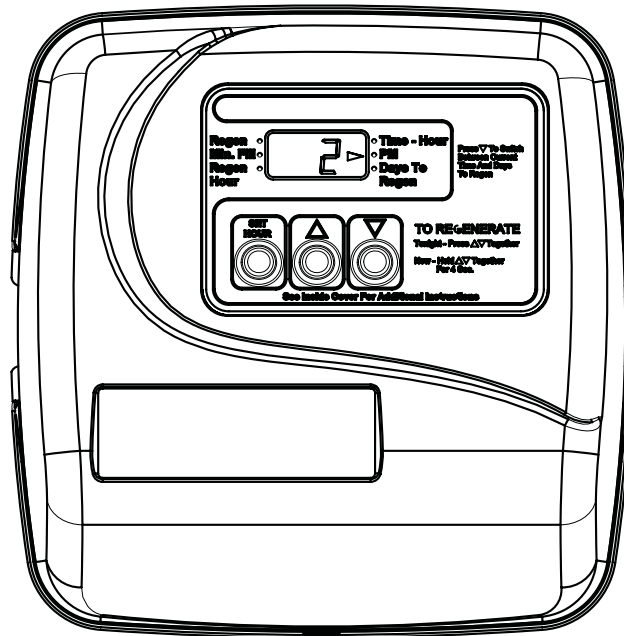

Operation and Instruction Manual for OEM Only.

Please Note: This operation and instruction manual is for the training of the OEM and for the OEM to use to train their customers. This document is not to be used as the complete system manual.

MANUAL REGENERATION

NOTE: For softeners, if brine tank does not contain salt, fill with salt and wait at least 2 hours before regeneration.

If you need to initiate a manual regeneration, either immediately, or tonight at the preprogrammed time (typically 2 a.m.), complete the following steps.

For Immediate Regeneration:

Press and hold UP and DOWN simultaneously until valve motor starts (typically 3 seconds).

Arrow will point to Regen if a regeneration is expected "Tonight."

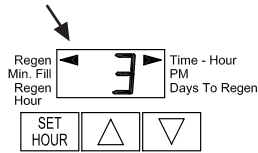

For Regeneration Tonight:

Press and release UP and DOWN simultaneously (notice that arrow points to Regen).

If the display shows "E1," "E2" or "E3" (for error), call a service technician.

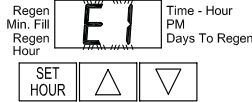

To shut off water to the system, please position arrow handles as shown in the **bypass operation** diagram below. If your valve doesn't look like the diagram below, contact your service technician for instructions on how to shut off water.

NORMAL OPERATION

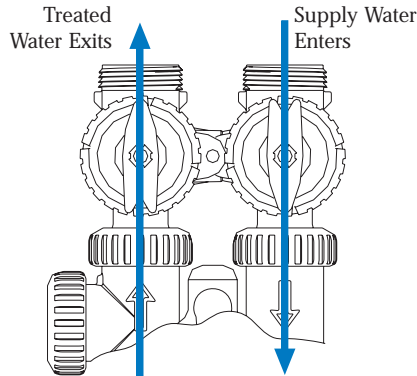

BYPASS OPERATION

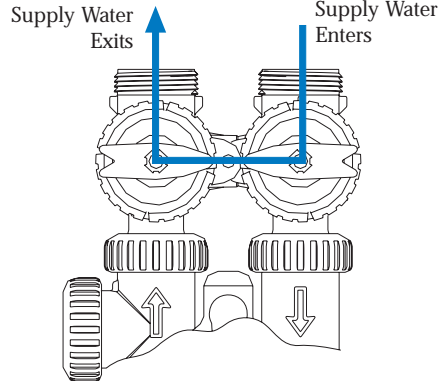

GENERAL OPERATION

When the system is operating one of two displays will be shown: time of day or days until the next regeneration. Pressing UP or DOWN will toggle between the two choices.

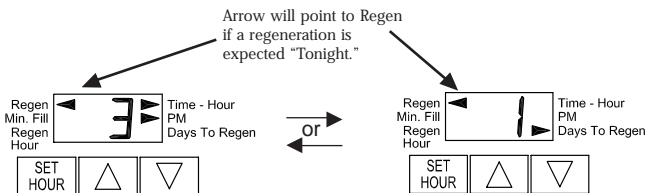

TO SET TIME OF DAY

In the event of a power outage, time of day needs to be reset. All other information will be stored in memory no matter how long the power outage. Please complete the steps as shown to the right. To access this mode, press SET HOUR.

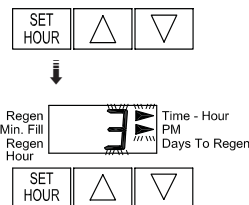

1. Accessed by pressing SET HOUR.
2. Adjust to the nearest hour using UP or DOWN. An arrow points to PM during p.m. hours.
3. Press SET HOUR to complete and return to normal operation.

TO SET TIME OF REGENERATION

For initial set-up or to make adjustments, please complete the steps as shown to the right. Access this mode by pressing SET HOUR and UP simultaneously for 3 seconds.

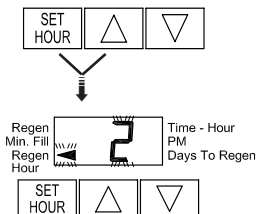

1. Accessed by pressing SET HOUR and UP simultaneously for 3 seconds.
2. Adjust time of regeneration hour using the UP or DOWN. An arrow points to PM during p.m. hours. Simultaneously press SET HOUR and DOWN to return to normal operation.

Table of Contents

Control Valve Function and Cycles of Operation	Control Valve Function and Cycles of Operation 1 - 2
OEM General Programming Instructions	Programming 1
OEM System Setup	Programming 1
Installer Displays/Settings	Programming 3
User Displays/Settings	Programming 4
Drawings and Part Numbers	
Front Cover and Drive Assembly	Drawings and Part Numbers 1
WS1TC Drive Cap, Pistons and Spacer Stack	Drawings and Part Numbers 2a
WS1.25TC Drive Cap, Pistons and Spacer Stack	Drawings and Part Numbers 2b
WS1 & WS1.25 Identification Figure	Drawings and Part Numbers 2c

FOR INFORMATION COMMON TO ALL 1” & 1.25” CONTROL VALVES REFER TO THE WS1&WS1.25 COMMON INFORMATION MANUAL

The common manual contains the Table of Contents shown below

Other Drawings and Part Numbers	
Compliance Table	No page number
Injector Cap, Injector Screen, Injector, Plug and O-ring	Drawings and Part Numbers 3a
Injector Order Information	Drawings and Part Numbers 3b
Injector Graphs US Units: Injector Draw, Slow Rinse and Total Flow Rates	Drawings and Part Numbers 3c-3d
Injector Graphs Metric Units: Injector Draw, Slow Rinse and Total Flow Rates	Drawings and Part Numbers 3e-3f
Refill Flow Control Assembly and Refill Port Plug	Drawings and Part Numbers 4
Drain Line – 3/4”	Drawings and Part Numbers 5
Drain Line – 1”	Drawings and Part Numbers 6
Water Meter, Meter Plug and Mixing Valve	Drawings and Part Numbers 7
Installation Fitting Assemblies	Drawings and Part Numbers 8a – 8b
Bypass Valve	Drawings and Part Numbers 9
Flow Diagrams – Service and Backwash	Drawings and Part Numbers 10
Flow Diagrams – Downflow and Upflow	Drawings and Part Numbers 11
Flow Diagrams – Rinse and Fill	Drawings and Part Numbers 12
WS1 Service Spanner Wrench	Drawings and Part Numbers 13
General Information	General Information 1
General Warnings (Must appear in OEM’s manual)	General Information 1
Specifications which must be included in OEM’s Manual	General Information 2
Quick Reference Specifications	General Information 2
Drive Assembly	General Information 3
Drive Cap Assembly, Main Piston and Regenerant Piston	General Information 3
Spacer Stack Assembly	General Information 4
Injector Cap, Screen, Injector Plug and Injector	General Information 4
Refill Flow Control Assembly or Refill Port Plug	General Information 4
Drain Line Flow Control and Fitting Assembly	General Information 5
Water Meter or Meter Plug	General Information 6
Mixing Valve	General Information 6
Installation Fitting Assemblies	General Information 6
Bypass Valve	General Information 7 - 8
Installation	Installation 1 - 2
Service Instructions	Service Instructions 1 - 5
Troubleshooting	Troubleshooting 1 - 2
Limited Warranty	Last Page

Control Valve Function and Cycles of Operation

This glass filled Noryl¹ (or equivalent) fully automatic control valve is designed as the primary control center to direct and regulate all cycles of a downflow regeneration water softener or filter.

The time clock control valve can be set to perform downflow regeneration or simply backwash. The time clock control valve has two calendar options for regeneration frequency:

1. an option where the user can choose the number of days (1-99) between each regeneration; and
2. a seven-day option where the user can choose which day(s) of the week a regeneration should occur.

The control valve is compatible with a variety of regenerants and resin cleaners. The control valve is capable of routing the flow of water in the necessary paths to regenerate or backwash water treatment systems. The injector regulates the flow of brine or other regenerants. The control valve regulates the flow rates for backwashing, rinsing, and the replenishing of treated water into a regenerant tank, when applicable.

The control valve uses no traditional fasteners (e.g. screws); instead clips, threaded caps and nuts and snap type latches are used. Caps and nuts only need to be firmly hand tightened because radial seals are used. Tools required to service the valve include one small blade screw driver, one large blade screw driver, pliers and a pair of hands. A plastic wrench is available which eliminates the need for screwdrivers and pliers. Disassembly for servicing takes much less time than comparable products currently on the market. Control valve installation is made easy because the distributor tube can be cut ½" above to ½" below the top of tank thread. The distributor tube is held in place by an o-ring seal and the control valve also has a bayonet lock feature for upper distributor baskets.

The AC adapter power pack comes with a 15 foot power cord and is designed for use with the control valve. The AC adapter power pack is for dry location use only. If the power goes out, only the time of day needs to be reset. All other values are permanently stored in the nonvolatile memory.

Table 1 shows the time for the backwash, regenerative, and rinse cycles for the ten available programming options. Six different programs are available for a softener, one for a regenerative filter, and three programs for backwash only filters. When the control valve is used as a:

1. softener, one or two backwashes occur and refill always occurs after the rinse cycle (P0 through P5);
2. regenerative filter, one backwash occurs and refill always occurs after the rinse cycle (P6); and
3. backwashing filter, one backwash occurs (P7 through P9).

Table 1
Regeneration Cycles and Times for Different Programs

Program	All times in Minutes				
	C1 1st Backwash	C2 Regenerate	C3 2nd Backwash	C4 Rinse	C5 Fill
P0	3	50	3	3	1-99
P1	8	50	8	4	1-99
P2	8	70	10	6	1-99
P3	12	70	12	8	1-99
P4	10	50	Skipped	8	1-99
P5	4	50	Skipped	4	1-99
P6	12	6	Skipped	12	1-99
P7	6	Skipped	Skipped	4	Skipped
P8	10	Skipped	Skipped	6	Skipped
P9	14	Skipped	Skipped	8	Skipped

NOTE: During regeneration the display will show C1, C2, etc. If the cycle is skipped, that cycle number will not be displayed.

¹ Noryl is a trademark of General Electric.

The user can initiate manual regeneration. The user has the option to request the manual regeneration at the delayed regeneration time or to have the regeneration occur immediately. Simultaneously press the UP + DOWN buttons to start a regeneration at the next delayed regeneration time. If a regeneration is to occur today an arrow will point to regeneration. For immediate regeneration, simultaneously press and hold the UP + DOWN buttons for three seconds.

When in regeneration, step through the different regeneration cycles by simultaneously pressing the UP + DOWN buttons.

OEM General Instructions

The control valve offers multiple procedures that allow the valve to be modified to suit the needs of the installation. These procedures are:

- OEM System Setup
- Installer Displays & Settings (either 1-99 Days Between Regeneration option or 7-Day option)
- User Displays

These procedures can be accessed in any order. Details on each of the procedures are provided below and on the following pages.

When in operation, normal user displays show the time of day or days remaining before regeneration. When stepping through a procedure, if no buttons are pressed within five minutes the display returns to a normal user display. Any changes made prior to the five minute time out are incorporated.

To quickly exit Installer Displays & Settings or OEM Setup, simultaneously press SET HOUR + DOWN. Any changes made prior to the exit are incorporated.

To reinitialize the control valve, check to make sure the valve is in the User Display. Then simultaneously press SET HOUR + DOWN or unplug power source plug (black wire) on the circuit board, and plug back in.

STEP 1SS

OEM System Setup

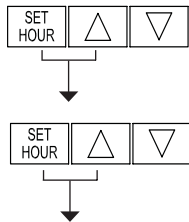

STEP 1SS – From normal mode, press SET HOUR + UP buttons simultaneously for 3 seconds and release. Then press SET HOUR + UP buttons simultaneously for 3 seconds and release.

STEP 2SS

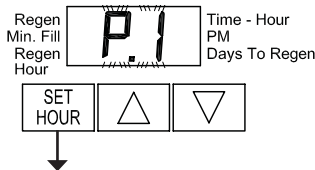

STEP 2SS – Choose the desired program by pressing the UP or DOWN buttons. Prior to selecting a program, verify the correct valve body, main piston, regenerant piston, and stack are being used, and that the injector or injector plug(s) are in the correct locations. See Compliance Table in Service Instructions under Injector Cap, Screen, Injector Plug and Injector section and Figure 6. Press SET HOUR button to go to Step 3SS.

Regeneration Cycles and Times for Different Programs

Program	All times in Minutes				
	C1 1st Backwash	C2 Regenerate	C3 2nd Backwash	C4 Rinse	C5 Fill
P0	3	50	3	3	1-99
P1	8	50	8	4	1-99
P2	8	70	10	6	1-99
P3	12	70	12	8	1-99
P4	10	50	Skipped	8	1-99
P5	4	50	Skipped	4	1-99
P6	12	6	Skipped	12	1-99
P7	6	Skipped	Skipped	4	Skipped
P8	10	Skipped	Skipped	6	Skipped
P9	14	Skipped	Skipped	8	Skipped

STEP 3SS

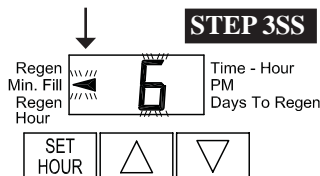

STEP 3SS – If program P0 through P6 was selected, enter in the minutes of fill using the UP or DOWN buttons. The allowable values vary from a low of 1 to a high of 99. If program P7, P8 or P9 was selected, dashes will appear for minutes of fill. Press SET HOUR button to go to Step 4SS. Note: For each minute of fill 0.5 gallons of water is added to the solution tank. With salt (sodium chloride) this equates to approximately 1 1/2 pounds of salt per minute of fill.

STEP 4SS

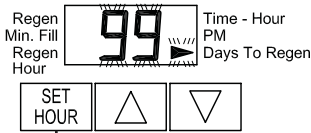

→
or
←

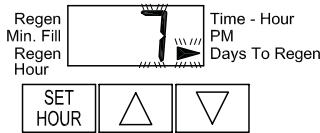

STEP 4SS — Use UP or DOWN buttons to switch between:

- 1-99 Days Between Regen; or
- 7-Day.

Press SET HOUR button to go to Step 5SS.

STEP 5SS

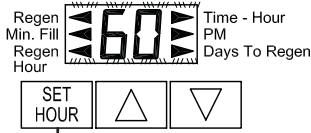

→
or
←

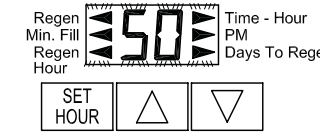

STEP 5SS — Use UP or DOWN buttons to switch between 60 Hz or 50 Hz option. Press SET HOUR button to go to Step 6SS.

STEP 6SS

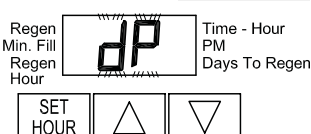

→
or
←

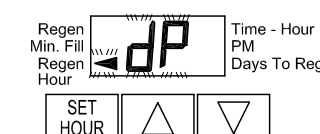

STEP 6SS — If a differential pressure switch is installed and actuated:

- a regeneration will occur immediately if no arrow points at Regen Hour; or
- a regeneration will occur at the delayed regeneration hour if an arrow points at Regen Hour.

Use UP or DOWN buttons to switch between the two choices. If a differential switch is not installed the settings in this display are ignored. Press SET HOUR to exit OEM system setup.

Return to Normal Mode



NOTE: A regeneration will be initiated or scheduled after the control has received a signal for two minutes.

- A. Differential pressure switch connection
- B. Motor wire connection
- C. AC adapter wire connection

STEP 11D

Installer Displays & Settings (1-99 Days Between Regeneration option)

STEP 11D – From normal mode, press SET HOUR + UP buttons simultaneously for 3 seconds and release.

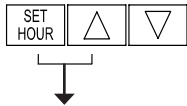

STEP 21D

STEP 21D – Regeneration Time: Set the clock to the hour the regeneration should occur by using the UP or DOWN buttons. An arrow points to PM after 12. Press SET HOUR to go to STEP 31D.

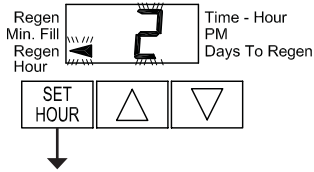

STEP 31D

STEP 31D – Days To Regen: Set the number of days between regenerations. The allowable range is 1 to 99. Press SET HOUR to exit Installer Displays & Settings.

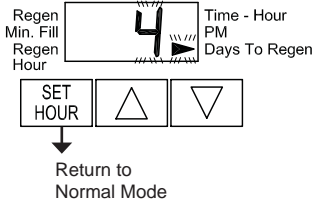

Installer Displays & Settings (7 day option)

STEP 117 – From normal mode, press SET HOUR + UP buttons simultaneously for 3 seconds and release.

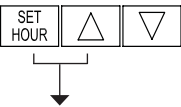

STEP 217

STEP 217 – Regeneration Time: Set the clock to the hour the regeneration should occur by using the UP or DOWN buttons. An arrow points to PM after 12. Press SET HOUR to go to STEP 317.

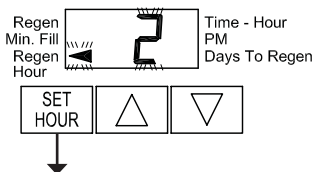

STEP 317

STEP 317 – Current Day of Week: Set the current day of the week by using the UP or DOWN buttons (See chart at right for date codes). Press SET HOUR to go to STEP 417.

Display	Day of Week
d1	Sunday
d2	Monday
d3	Tuesday
d4	Wednesday
d5	Thursday
d6	Friday
d7	Saturday

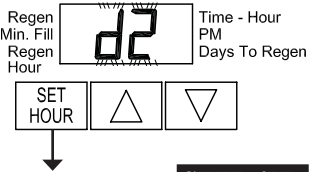

STEP 417

STEP 417 – Sunday Regeneration: To regenerate on Sunday use the UP or DOWN button until the arrow points to Regen. If the arrow does not point to Regen a regeneration will not occur on Sunday. Press SET HOUR to go to STEP 517.

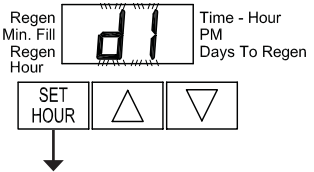

STEP 517

STEP 517 – Monday Regeneration: To regenerate on Monday use the UP or DOWN button until the arrow points to Regen. If the arrow does not point to Regen a regeneration will not occur on Monday. Press SET HOUR to go to STEP 617.

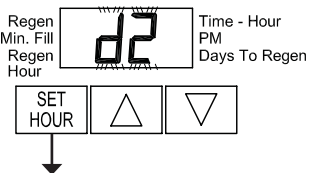

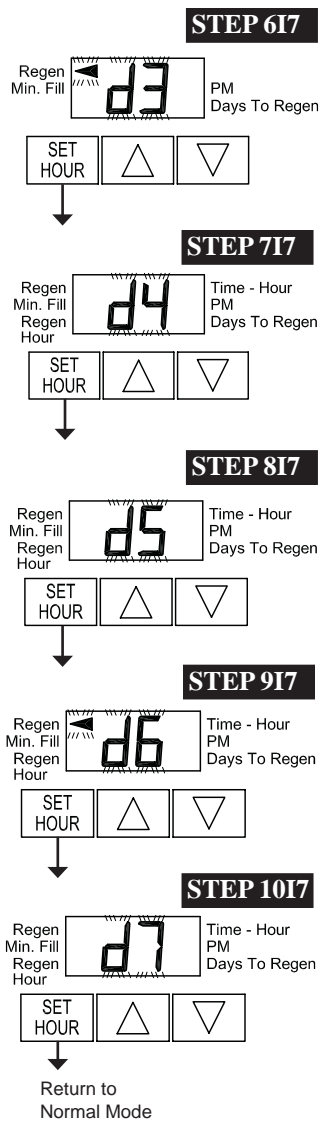

STEP 6I7 – Tuesday Regeneration: To regenerate on Tuesday use the UP or DOWN button until the arrow points to Regen. If the arrow does not point to Regen a regeneration will not occur on Tuesday. Press SET HOUR to go to STEP 7I7.

STEP 7I7 – Wednesday Regeneration: To regenerate on Wednesday use the UP or DOWN button until the arrow points to Regen. If the arrow does not point to Regen a regeneration will not occur on Wednesday. Press SET HOUR to go to STEP 8I7.

STEP 8I7 – Thursday Regeneration: To regenerate on Thursday use the UP or DOWN button until the arrow points to Regen. If the arrow does not point to Regen a regeneration will not occur on Thursday. Press SET HOUR to go to STEP 9I7.

STEP 9I7 – Friday Regeneration: To regenerate on Friday use the UP or DOWN button until the arrow points to Regen. If the arrow does not point to Regen a regeneration will not occur on Friday. Press SET HOUR to go to STEP 10I7.

STEP 10I7 – Saturday Regeneration: To regenerate on Saturday use the UP or DOWN button until the arrow points to Regen. If the arrow does not point to Regen a regeneration will not occur on Saturday. Press SET HOUR to exit Installer Displays & Settings.
NOTE: If all arrows are turned off in d1-d7, Days to Regen in the User Displays will always read 7 and a regeneration will never occur.

User Displays

General Operation

When the system is operating one of two displays will be shown. Pressing UP or DOWN button will alternate between the displays. One of the displays is always the current time of day (to the nearest hour). The second display is the days remaining until the next regeneration. If the days remaining is equal to one, a regeneration will occur at the next preset regeneration time. The user can scroll between displays as desired.

If the system has called for a regeneration that will occur at the preset time of regeneration, the arrow will point to Regen.

Regeneration Mode

Typically a system is set to regenerate at a time of low water usage. An example of a time with low water usage is when a household is asleep. If there is a demand for water when the system is regenerating, untreated water will be used.

When the system begins to regenerate, the display will change to indicate the cycle of the regeneration process (see Table 3) that is occurring and an arrow will also point to Regen. The system will run through the steps automatically and will reset itself to provide treated water when the regeneration is completed.

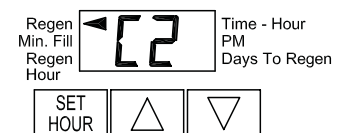
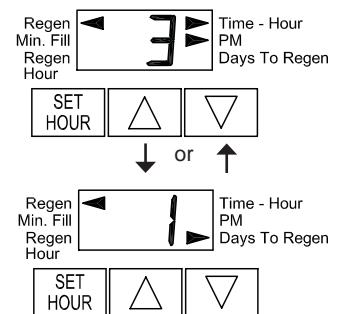

Manual Regeneration

Sometimes there is a need to regenerate the system sooner than when the system calls for it, usually referred to as a manual regeneration. There may be a period of heavy water usage because of guests or a heavy laundry day.

An arrow will point to the word Regen if a regeneration is expected "tonight."

To initiate a manual regeneration at the preset delayed regeneration time, simultaneously press UP + DOWN buttons together and release. The arrow will point to the word Regen if a regeneration is expected "tonight." To cancel the regeneration simultaneously press UP + DOWN buttons and release.

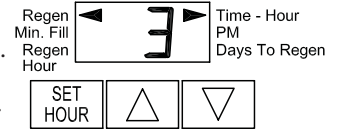

To initiate a manual regeneration immediately, simultaneously press UP + DOWN buttons together for three seconds. The system will begin to regenerate immediately. The request cannot be cancelled.

Note: For softeners, if brine tank does not contain salt, fill with salt and wait at least two hours before regenerating.

STEP 1U

Set Time of Day

STEP 1U – Press SET HOUR

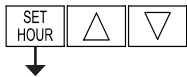

STEP 2U

STEP 2U – Current time: Set the clock to the closest hour by using the UP and DOWN button. An arrow points to PM after 12. After a power outage, the time of day will need to be reset. Press SET HOUR to exit.

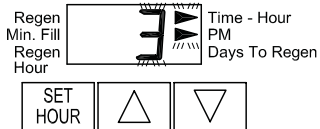

Power Loss

If the power goes out current time of day will need to be reset. If the power goes out while the system is regenerating, the cycle picks up where it was interrupted when the power returns.

Error Message

If "E1," "E2" or "E3" appears on the display contact the OEM for help. This indicates that the valve did not function properly.

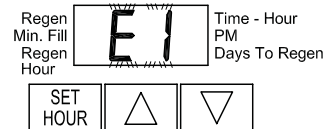

Front Cover and Drive Assembly

Drawing No.	Order No.	Description	Quantity
1	V3175TC-01	WS1TC Front Cover ASY	1
2	V3107-01	WS1 Motor	1
3	V3106-01	WS1 Drive Bracket & Spring Clip	1
4	V3108TC	WS1TC PC Board	1
5	V3110	WS1 Drive Reducing Gear 12 x 36	3
6	V3109	WS1 Drive Gear Cover	1
	V3002TC	WS1TC Drive ASY	*
Not Shown	V3186	WS1 AC Adapter 110V - 12V	1
Not Shown	V3186	WS1 AC ADAPTER 110V-12V	1
	V3186EU	WS1 AC ADAPTER 220-240V-12V EU	
	V3186UK	WS1 AC ADAPTER 220-240V-12V UK	
	V3186-01	WS1 AC ADAPTER CORD ONLY	

* Drawing number parts 2 through 6 may be purchased as a complete assembly, part V3002.

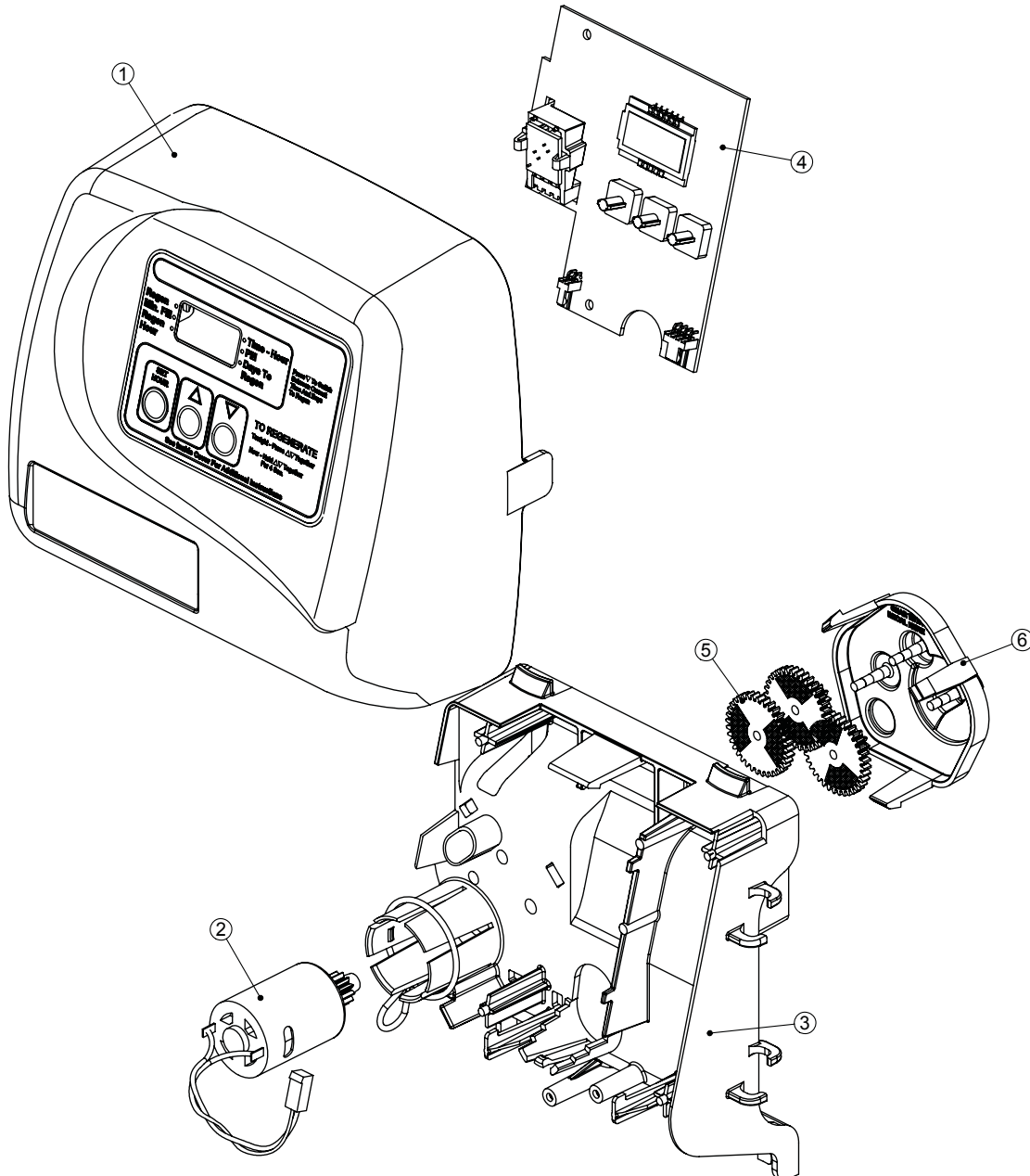

WS1TC Drive Cap Assembly, Downflow Piston, Regenerant Piston and Spacer Stack Assembly

Drawing No.	Order No.	Description	Quantity
1	V3005	WS1 Spacer Stack Assembly	1
2	V3004	Drive Cap ASY	1
3	V3178	WS1 Drive Back Plate	1
4	V3011	WS1 Piston Downflow ASY	1
5	V3174	WS1 Regenerant Piston	1
6	V3135	O-ring 228	1
7	V3180	O-ring 337	1
8	V3105	O-ring 215 (Distributer Tube)	1
Not Shown	V3001	WS1 Body ASY Downflow	1
	V3001-02	WS1 Mixing Valve Body ASY	

Note: The regenerant piston is not used in backwash only applications.

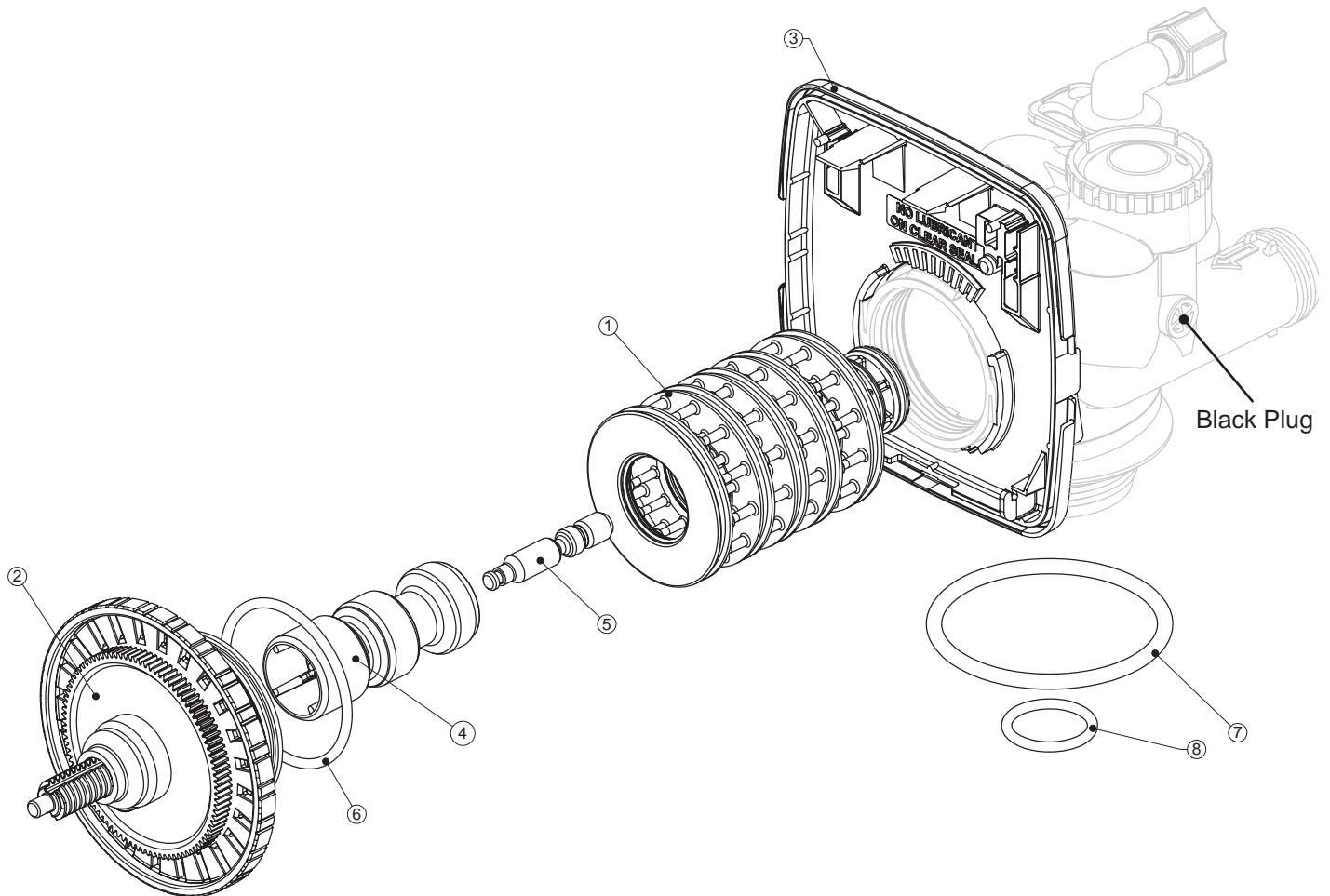

WS1.25TC Drive Cap Assembly, Downflow Piston, Regenerant Piston and Spacer Stack Assembly

Drawing No.	Order No.	Description	Quantity
1	V3430	WS1.5 Spacer Stack Assembly	1
2	V3004	Drive Cap ASY	1
3	V3178	WS1 Drive Back Plate	1
4	V3407	WS1.5 Piston Downflow ASY	1
5	V3174	WS1 Regenerant Piston	1
6	V3135	O-ring 228	1
7	V3180	O-ring 337	1
8	V3358	O-ring 219 (Distributor Tube Opening 1.32")	1
	V3357	O-ring 218 (Distributor Tube Opening 32mm)	
Not Shown	V3020	WS1.25 Body ASY Downflow (Distributor Tube Opening 1.32")	1
	V3020-01	WS1.25 Mixing Valve Body Downflow ASY (Distributor Tube Opening 1.32")	
	V3020-02	WS1.25 Body ASY Downflow (Distributor Tube Opening 32mm)	
	V3020-03	WS1.25 Mixing Valve Body Downflow ASY (Distributor Tube Opening 32mm)	

Note: The regenerant piston is not used in backwash only applications.

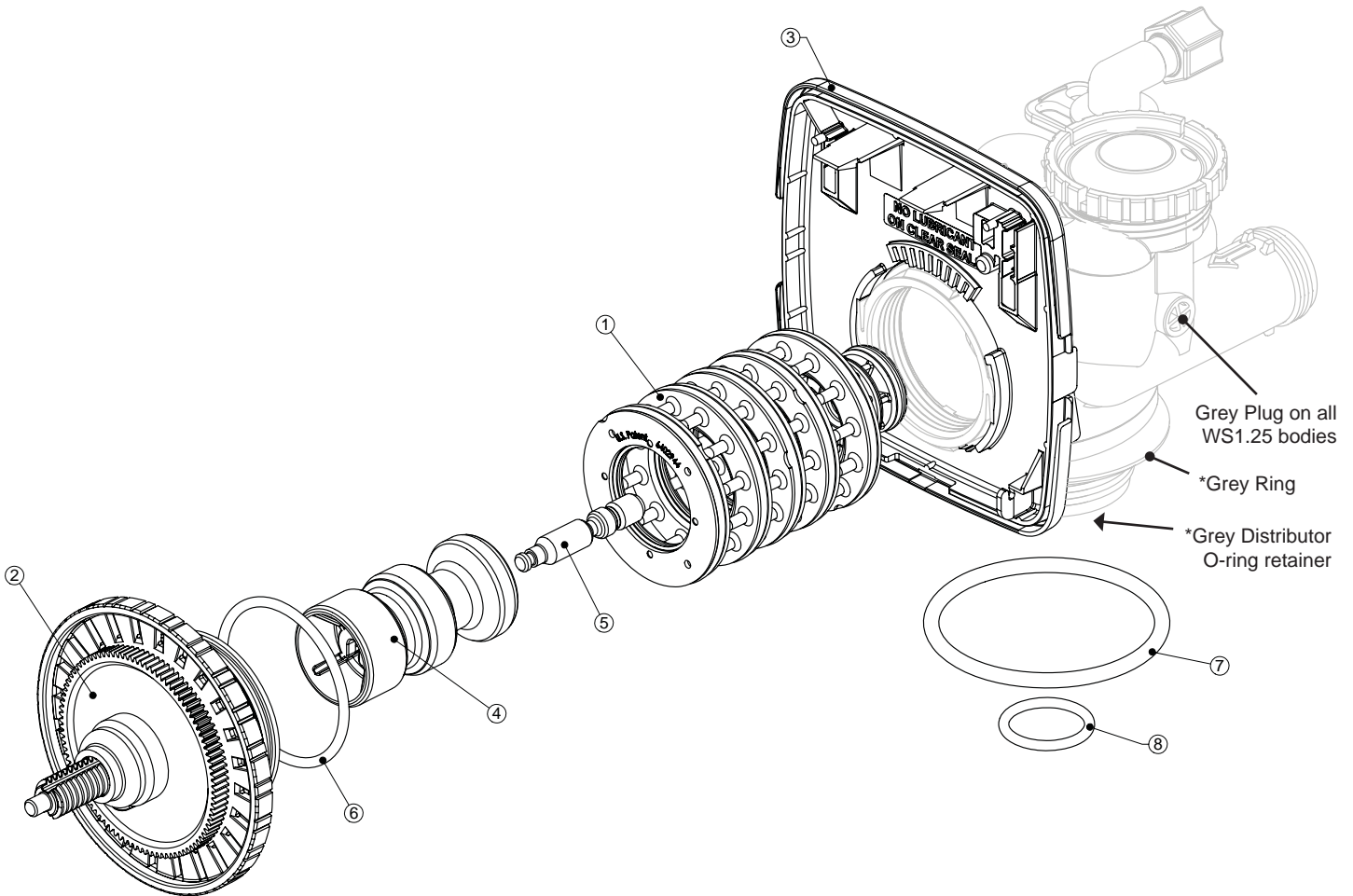

*Only for valves that have a 32mm Distributor Tube Opening

WS1 & WS1.25 Identification Figure

WS1TC with 1.050" Distributor Tube Opening Identification

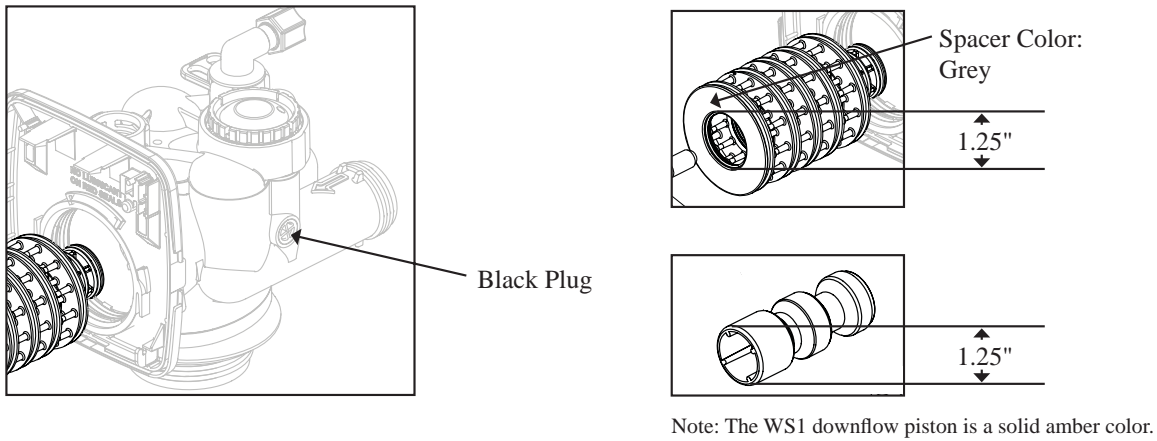

WS1.25 with 1.32" Distributor Tube Opening Identification

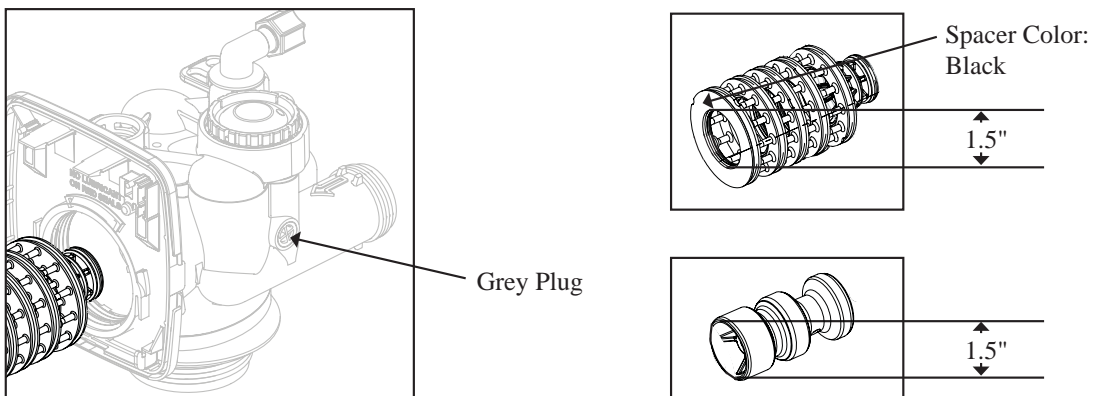

WS1.25 with 32mm Distributor Tube Opening Identification

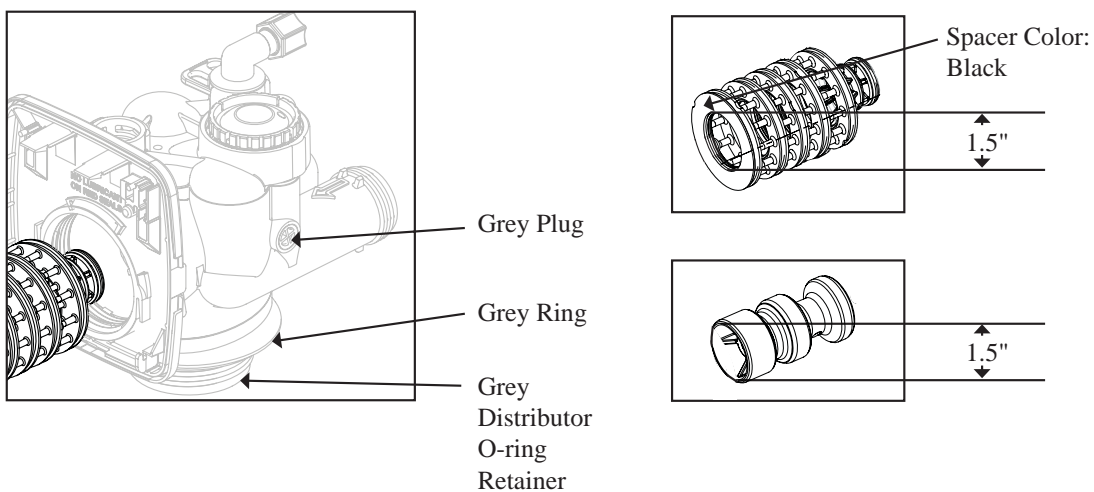

FOR INFORMATION COMMON TO ALL 1” & 1.25” CONTROL VALVES REFER TO THE WS1&WS1.25 COMMON INFORMATION MANUAL

The common manual contains the Table of Contents shown below

Other Drawings and Part Numbers

Compliance Table	No page number
Injector Cap, Injector Screen, Injector, Plug and O-ring	Drawings and Part Numbers 3a
Injector Order Information	Drawings and Part Numbers 3b
Injector Graphs US Units: Injector Draw, Slow Rinse and Total Flow Rates	Drawings and Part Numbers 3c-3d
Injector Graphs Metric Units: Injector Draw, Slow Rinse and Total Flow Rates	Drawings and Part Numbers 3e-3f
Refill Flow Control Assembly and Refill Port Plug	Drawings and Part Numbers 4
Drain Line – 3/4”	Drawings and Part Numbers 5
Drain Line – 1”	Drawings and Part Numbers 6
Water Meter, Meter Plug and Mixing Valve	Drawings and Part Numbers 7
Installation Fitting Assemblies	Drawings and Part Numbers 8a – 8b
Bypass Valve	Drawings and Part Numbers 9
Flow Diagrams – Service and Backwash	Drawings and Part Numbers 10
Flow Diagrams – Downflow and Upflow	Drawings and Part Numbers 11
Flow Diagrams – Rinse and Fill	Drawings and Part Numbers 12
WS1 Service Spanner Wrench	Drawings and Part Numbers 13

General Information

General Warnings (Must appear in OEM’s manual)	General Information 1
Specifications which must be included in OEM’s Manual	General Information 1
Quick Reference Specifications	General Information 2
Drive Assembly	General Information 2
Drive Cap Assembly, Main Piston and Regenerant Piston	General Information 3
Spacer Stack Assembly	General Information 3
Injector Cap, Screen, Injector Plug and Injector	General Information 4
Refill Flow Control Assembly or Refill Port Plug	General Information 4
Drain Line Flow Control and Fitting Assembly	General Information 4
Water Meter or Meter Plug	General Information 5
Mixing Valve	General Information 6
Installation Fitting Assemblies	General Information 6
Bypass Valve	General Information 6

Installation

Service Instructions	General Information 7 - 8
Troubleshooting	Installation 1 - 2
Limited Warranty	Service Instructions 1 - 5
	Troubleshooting 1 - 2
	Last Page