

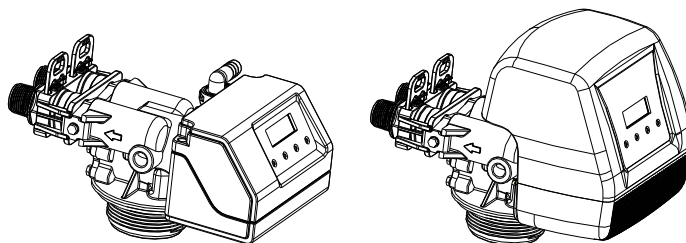

BNT 85 /185 Valve Operation Manual



Note:

1. Read all instructions carefully before operation.
2. Avoid pinched o-rings during installation by applying (provided with install kit) NSF certified lubricant to all seals.

TABLE OF CONTENTS

Introduction	3
General Valve Installation	5
Start-Up Instructions.....	5
Level I User Programming	6
Level II User Programming	8
Valve Drive Assembly Exploded View.....	12
Valve Drive Parts List.....	13
Control Valve Assembly Exploded View	14
Control Valve Parts List	15
Trouble Shooting.....	16
Guarantee	17

Introduction

This valve is controlled with simple, user- friendly electronics displayed on a large LCD screen. The main page displays the current date and time. In addition, the main page also shows key valve information and statistics including; current capacity setting, volume remaining, date of last regeneration, current flow rate, and peak flow rate.

MAY 8, 2009 9:05 AM	CAPACITY 1,350 GAL	VOLUME REMAINING 1,125 GAL
REGEN DAYS 7 DAYS	REMAINING DAYS 5 DAYS	REGENERATION TIME 2:00 AM
LAST REGEN MAY 4, 2009	CURRENT FLOW 1.5 GPM	PEAK FLOW 5.8 GPM

Figure 1. Main Page Displays

NOTE: REGEN DAYS and REMAINING DAYS are only shown in the CALENDAR CLOCK more or METER OVERRIDE mode.

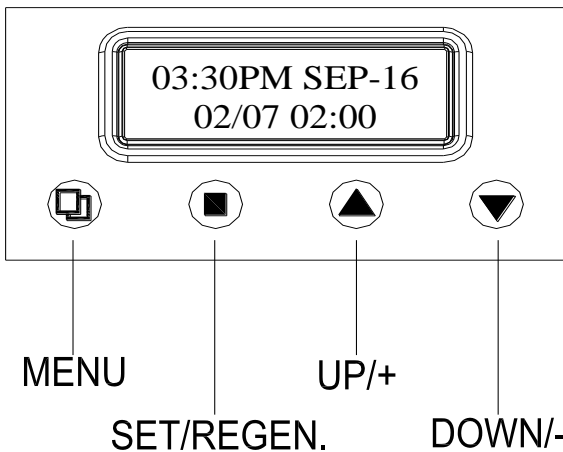

Figure 2. Key Pad Configuration

System Initialization

When power is first supplied, the valve may take up to two minutes to initialize. During this time, the valve will show "INITIALIZING WAIT PLEASE". Do not touch any buttons at this time. When the valve reaches the service position, it will display the current date and time.

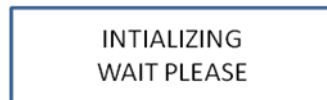

Figure 3. System Initialization Display

Main Valve Functions

VALVE OPERATION MODE:

- **SOFTENER:** Standard water softener operation.
- **FILTER:** Automatic back washing filters such as Multi-Media Depth Filter or Carbon Filter.
- **IRON FILTER:** This mode is typically used with Manganese Green Sand Filters.

REGENERATION MODE: 1. METER DELAYED 2. METER IMMEDIATE 3. CALENDAR CLOCK
4. METER OVERRIDE

CAPACITY CALCULATION: 1. AUTOMATIC 2. MANUAL

ADJUSTABLE CYCLES: All of the valve cycles are fully adjustable.
1. BACKWASH 2. BRINE / RINSE 3. RINSE
4. REFILL

NOTE: Refer to Level II User Programming for description of each mode.

During a regeneration cycle, the valve will display what position it is advancing to. Once in the correct position, the valve will display the current position along with the time remaining for that cycle. On the bottom row, the time remaining is also graphically displayed.



Figure 4. Regeneration Cycle Valve Display

MENU BUTTON “□”: The function of this key is to enter the level one programming mode where the valve settings can be adjusted.

SET / REGEN BUTTON “□”: This button has two functions. The first is to initiate a manual regeneration by holding the button for 3 or more seconds. The second function is while in programming mode, pressing this key allows the user to change the value of each setting.

UP / DOWN “▲▼”: These buttons are used to increase or decrease the value of the settings while in the programming mode.

Manual Regeneration

Press “□” SET/REGEN for three seconds to initiate a manual regeneration. When the valve reaches any cycle position, pressing any key will automatically advance the valve to the next position.

Control Operation During A Power Failure

In the event of power failure, the valve will keep track of the time and day for 48 hours. The programmed settings are stored in a non-volatile memory and will not be lost during a power failure.

If power fails while the unit is in regeneration, the valve will finish regeneration from the point it is at once power is restored. However, since the unit did not complete its regeneration, it will queue another regeneration at the next scheduled regeneration time.

If the valve misses a scheduled regeneration due to a power failure, it will queue a regeneration at the next regeneration time once power is restored.

General Valve Installation

Water Pressure	Minimum 25 PSI
Electrical Supply	Uninterrupted AC
Existing Plumbing	Free of any deposits or build-ups inside pipes.
Unit Location	Locate close to drain and connect according to plumbing codes
Bypass Valves	Always provide for bypass valve if unit is not equipped with one.
Plumbing	Softener and or other water treatment equipment should be installed to local plumbing codes

	CAUTION <ul style="list-style-type: none">▪ Do not exceed 120 psi water pressure.▪ Do not exceed 110°F water temperature.▪ Do not subject unit to freezing conditions.
---	---

1. Locate the softener tank and brine tank close to a drain where the system will be installed. The surface should be clean and level.
2. Perform all plumbing according to local plumbing codes.
 - Use a ½" minimum pipe or tubing size for the drain line
 - Use a ¾" pipe or tubing for backwash flow rates that exceed 7 gpm or length that exceeds 20ft (6 m)**NOTE: ON COPPER PLUMBING SYSTEMS BE SURE TO INSTALL A GROUNDING WIRE BETWEEN THE INLET AND OUTLET PIPING TO MAINTAIN GROUNDING.**
3. Any solder joints near the valve must be done before connecting any piping to the valve. Always leave at least 6" (152 mm) between the valve and joints when soldering pipes that are connected to the valve. Failure to do this could cause damage to the valve.
4. If the valve is not installed on the tank, cut the 1" central pipe flush with top of each tank. Lubricate the large o-ring on the valve that seals against the tank. Screw the valve on to the tank. Be careful to not cross thread the valve into the tank. Only use silicone lubricant.
5. Connect the drain line to the valve. Only use Teflon tape on the drain fitting.
6. Connect the brine line from the brine tank to the valve.
7. Add water until there is approximately 1" (25 mm) of water above the grid plate. If the tank does not have a grid, add water until it is above the air check in the brine tank. Do not add salt to the brine tank at this time.
8. Place the unit in the bypass position.
9. Slowly turn on the main water supply.
10. At the nearest cold treated water tap nearby remove the faucet screen, open the faucet and let water run a few minutes or until the system is free of any air or foreign material resulting from the plumbing work. Close the water tap when water runs clean, then proceed to start up instructions.













Start-Up Instructions

1. Plug the valve into an approved power source.
2. When power is supplied to the control, the screen will display "INITIALIZING WAIT PLEASE" while it finds the service position.
3. Press "□" SET/REGEN and hold for 3 seconds to initiate a manual regeneration and advance the valve to the Backwash position. Open the inlet on the bypass valve slowly and allow water to enter the unit. Allow all air to escape from the unit before turning the water on fully then allow water to run to drain for 3-4 minutes or until all media fines are washed out of the softener.
4. Press any button to advance to the BRINE position. Check the water level in the brine tank to insure the valve is drawing brine properly.
5. Press any button to advance to the RINSE position. Check the drain line flow. Allow the water to run for 3-4 minutes or until the water is clear.



6. Press any button to advance to the REFILL position. Check that the valve is filling water into the brine tank. Allow the valve to refill for the correct amount of time as displayed on the screen to insure a proper brine solution for the next regeneration.
7. Press any button to advance to the SERVICE position. Open the outlet valve on the bypass, then open the nearest treated water faucet and allow the water to run until clear, close the tap and replace the faucet screen.
8. Add salt into the brine tank.
9. Program hardness and people into controller using Level One Programming Instructions.

Level I User Programming



Setting Current Time

1. If screen is locked, press “ MENU” for 3 seconds to unlock. Press “ MENU” again to enter level one programming mode and adjust CURRENT TIME.
2. Press “ SET/REGEN” to adjust hours. When you have entered the change value mode, the cursor will blink. Press “ or  UP OR DOWN” arrows to change the hour values. Press “ SET/REGEN” again to accept the hour value and advance to change the minutes value. Press “ or  UP OR DOWN” arrows to change the minute values. Press “ SET/REGEN” again to accept the minute values and advance to adjust the AM/PM values. Press “ or  UP OR DOWN” to change the AM/PM value. Press “ SET/REGEN” again to accept the AM/PM value and exit. When you have exited the change value mode, the cursor will stop flashing.





Setting Current Date

1. Press “ DOWN” to advance to CURRENT DATE.
2. Using the same procedure as setting the time, press “ SET/REGEN” to enter value change mode.





Setting Number of People

1. Press “ DOWN” to advance to NUMBER OF PEOPLE.
2. Press the “ SET/REGEN” to change the value. Press up or down arrows to change the values.

Setting Water Hardness

1. Press “ DOWN” to advance to WATER HARDNESS.
2. Press the “ SET/REGEN” to change the value. Press “ or  UP OR DOWN” to change the values.

Setting Vacation Mode

1. Press “ DOWN” to advance to VACATION MODE.
2. Press the “ SET/REGEN” to change the value. Press “ or  UP OR DOWN” to change the values.

Exiting Level One User Program Mode

At any time, press the “ MENU” to accept all changes and return to main page display.

Level I User Program Mode		
PARAMETER	OPTIONS	DESCRIPTION
1	CURRENT TIME	This option is the current time of day.
2	CURRENT DATE	This option is the current date. The date is used to track the last time the system regenerated.
3	NUMBER PEOPLE	This value is the number of people living in the home. It is used to calculate the amount of water needed for daily use and the reserve capacity of the system.
4	WATER HARDNESS	This value is the maximum water hardness in grains per gallon of the raw water supply. It is used to calculate the system capacity.
5	VACATION MODE	Yes
		No
This function may be activated by the user during a prolonged absence such as vacation. The system will perform a brief backwash and rinse based on the advanced setting. The purpose is to keep the water fresh in the softener tank and plumbing system.		

Figure 5. Level I Program Options

Level I User Programming Flow Chart

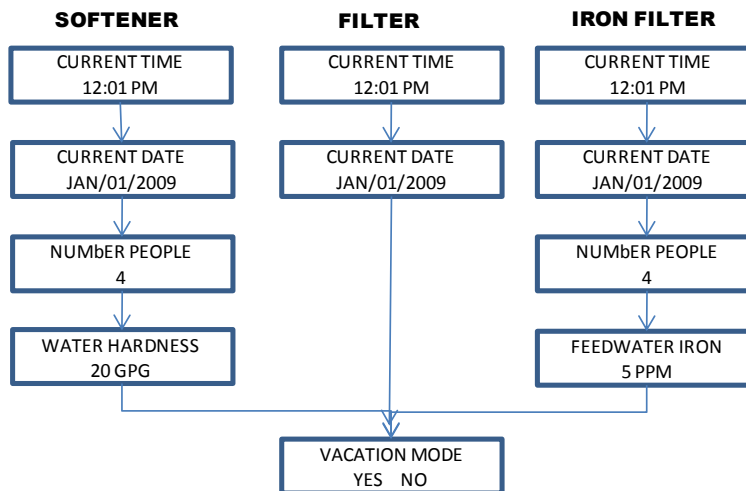

Level II User Programming

When the Level Two Master Programming Mode is entered, all available option setting displays may be viewed and set as needed. Depending on current option settings, some parameters cannot be viewed or set.

1. If screen is locked, press “**Q**” for three seconds to unlock.
2. Press and hold “**▲▼**” for three seconds to enter Level Two Master Programming.

Level II Master Program Mode			
PARAMETER	OPTIONS	DESCRIPTION	
1	SYSTEM LANGUAGE	ENGLISH	This option controls which language should be used in the valve display.
		FRENCH	
		SPANISH	
2	VALVE OPERATION	SOFTENER	There are three basic operating modes to choose depending on the system application.
		FILTER	
		IRON FILTER	
3	REGEN. MODE	METER DELAYED	This is the most common setting. When the volume remaining reaches zero gallons, the system will initiate a regeneration at the next pre-set regeneration time.
		METER IMMEDIATE	The unit will initiate a regeneration immediately after the volume remaining reaches zero.
		CALENDAR CLOCK	The unit will initiate a regeneration at the next pre-set regeneration time based on the interval of days between regeneration days.
		METER OVERRIDE	When the volume remaining reaches zero gallons, the system will initiate a regeneration at the next pre-set regeneration time. If the days between regeneration is reached before the remaining volume reaches zero, the system will override the meter setting and initiate a regeneration.
4	REGENERATION TIME		This setting controls the time of day when a regeneration cycle will start.
5	CAPACITY CALC.	AUTOMATIC	This option automatically calculates the capacity (in gallons for meter units), refill time (in minutes), or regeneration day intervals (days for calendar clock mode).
		MANUAL	The user can manually enter values for capacity, refill time, or regeneration day intervals.
6	RESIN VOLUME		This value should be the amount of resin in cubic feet that is loaded in to the tank. The value is used to calculate the system capacity and refill time.
7	SALT SETTING		This value is the salt dosage (pounds per cubic foot) to be used when regenerating the system.
8	REFILL FLOW RATE		This value is the flow rate (gallons per minute) of the brine line flow control (BLFC) button installed in the valve and is used to calculate the refill time to precisely measure the amount of water into the brine tank. (Note: This value is factory preset and should not be changed unless the BLFC button has been changed to a different size.)
9	UNIT CAPACITY		This value (GRAINS for softeners, PPM for IRON FILTERS) is the total capacity of the system. It is used to calculate the capacity of the system in gallons.
10	CAPACITY		In MANUAL CAPACITY CALC. mode, the CAPACITY can be adjusted by the user. In AUTOMATIC CAPACITY CALC. mode, the current calculated value is displayed but cannot be adjusted.
		FORMULA	$CAPACITY = (UNIT\ CAPACITY / WATER\ HARDNESS) - (NUMBER\ PEOPLE * DAILY\ USAGE)$
11	DAILY USAGE		This value is the average amount of water used per person per day. It is used to calculate the REGEN. DAYS for calendar clocks.
12	RESERVE CAPACITY		This value is the amount of water per person in gallons to be saved for a reserve capacity. It is used to calculate the CAPACITY of the system.
13	REGEN. DAYS		This value is the interval (days) between regenerations. It is used to determine how many days between regenerations in the CALENDAR CLOCK mode. It is also used as the value for the METER OVERRIDE mode. It can be set by the user in MANUAL CALC. MODE. In AUTOMATIC CAPACITY CALC. mode, the current calculated value is displayed but cannot be adjusted.
		FORMULA	$REGEN.\ DAYS = ((UNIT\ CAPACITY / WATER\ HARDNESS) / (NUMBER\ PEOPLE * DAILY\ USAGE)) - 1$
14	BACKWASH		This option controls the length of time in minutes for the unit to clean the bed by reversing the flow of water upwards through the bed and out to the drain.
15	BRINE / RINSE		This option controls the length if time in minutes for the unit to draw regenerant (brine for softeners) from the second tank and slowly rinse it from the top to bottom of the tank.
16	RINSE		This option controls the length of time to give the tank a final rinse from the top to the bottom in order remove any last traces of the regenerant (brine) from the tank.
17	REFILL		This option controls the length of time the brine valve will open to refill the second tank (brine tank for softeners) with water in order to produce the regenerate solution (brine for softeners) for the next regeneration cycle. The water is accurately measured through the valves brine line flow control to make a precise quantity of regenerant solution. In MANUAL CAPACITY CALC. mode, the REFILL time can be adjusted by the user. In AUTOMATIC CAPACITY CALC. mode, the current calculated value is displayed but cannot be adjusted.
		FORMULA	$REFILL = SALT\ SETTING * RESIN\ VOLUME / 3 / REFILL\ FLOW\ RATE$
18	RESTORE DEFAULT	YES	This option allows the current settings to be erased and changed back to the default settings.
		NO	

Figure 6. Level II Program Options

Level II User Programming Softener Flow Chart

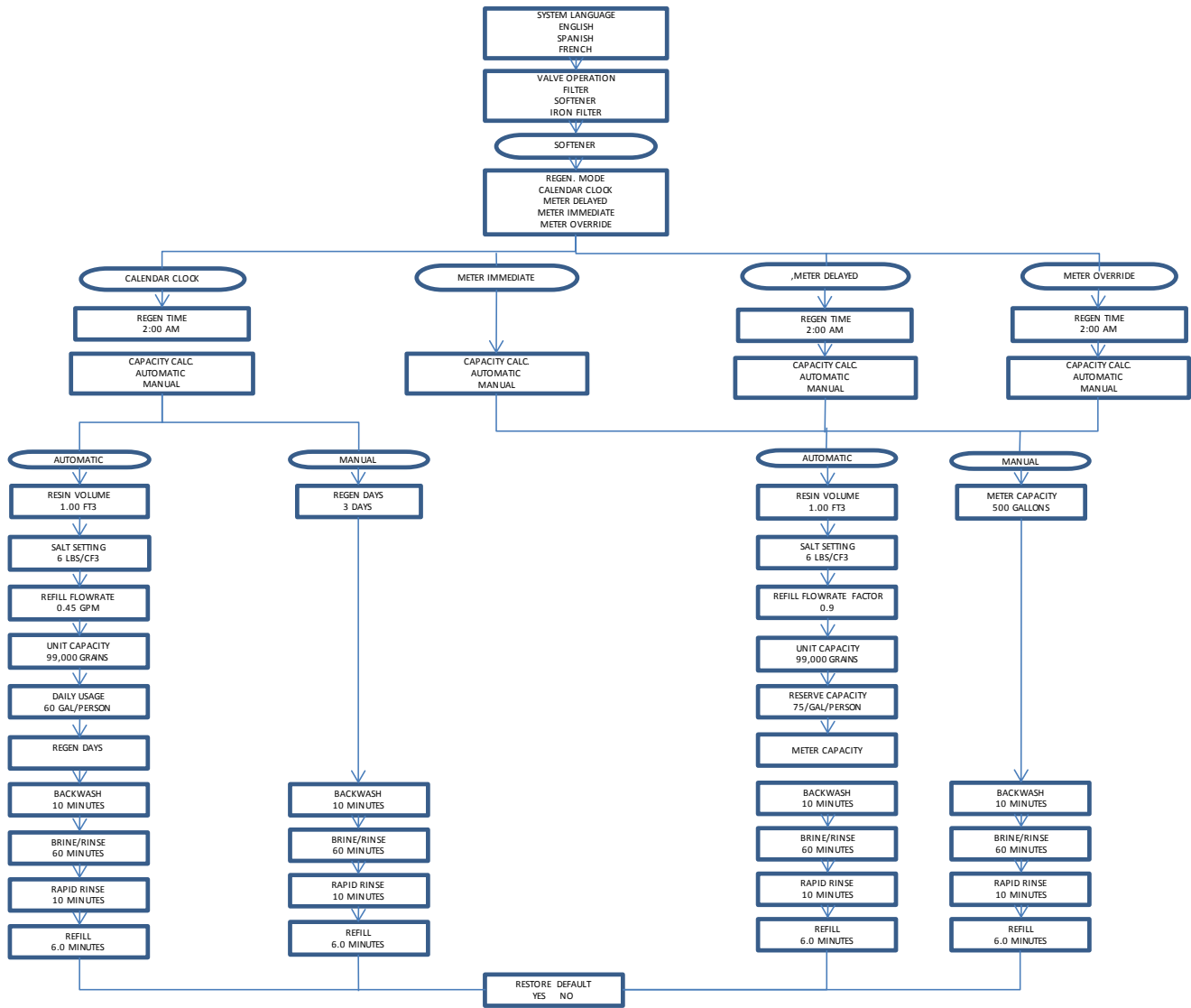

Level II User Programming Filter Flow Chart

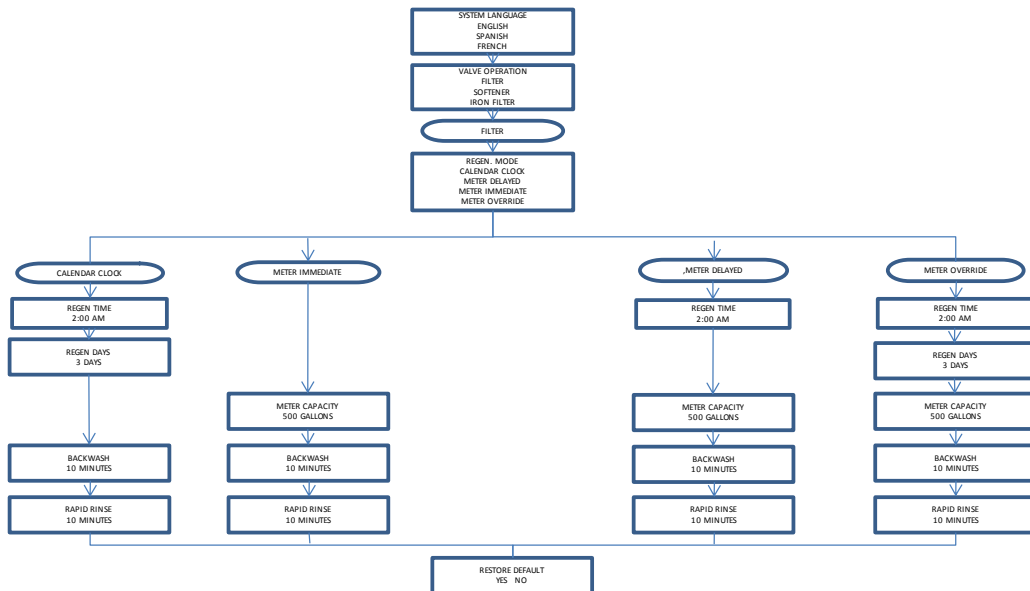

Level II User Programming Iron Filter Flow Chart

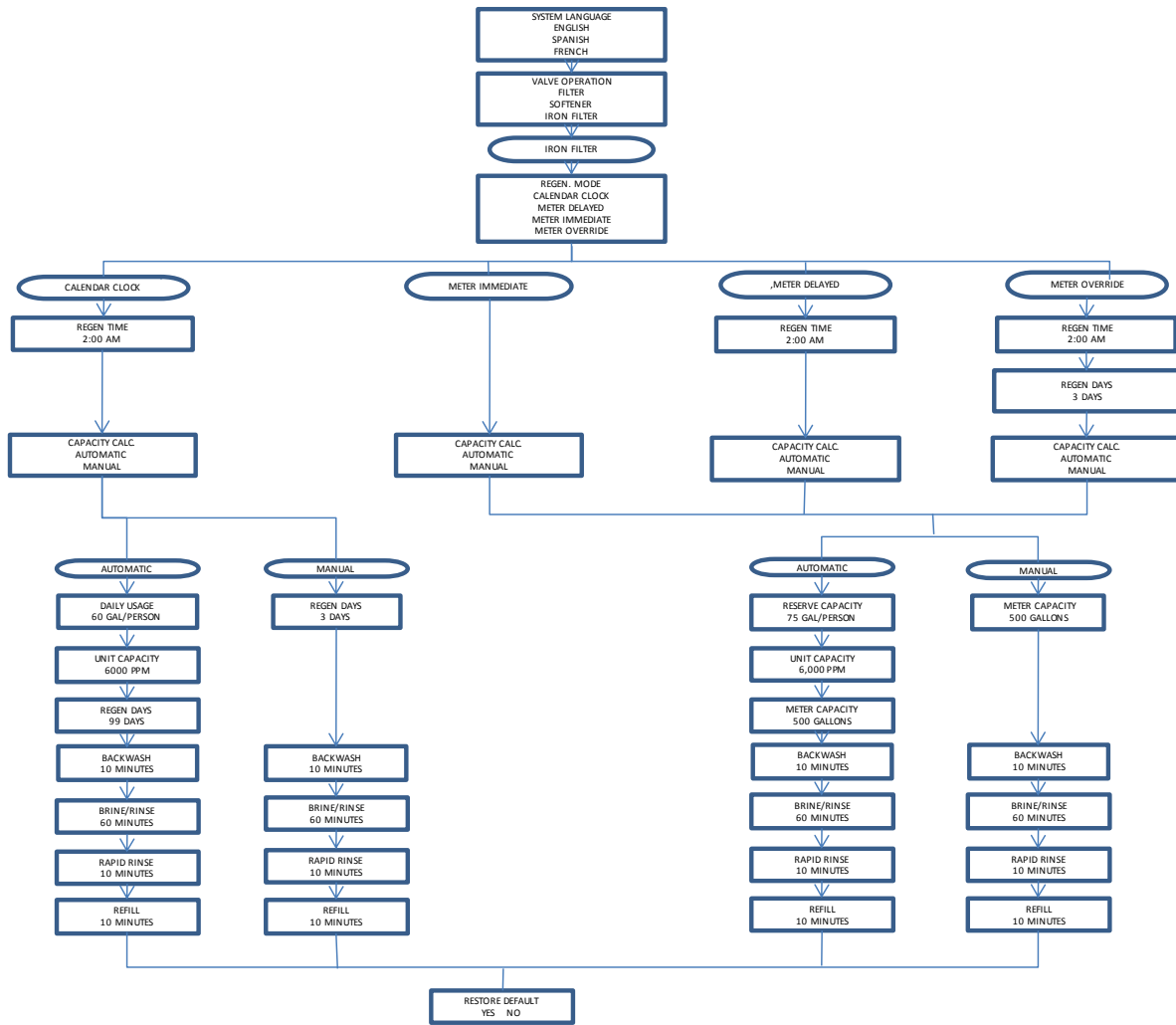



Diagnostics Mode

1. If screen is locked, press “ MENU” for three seconds to unlock.
2. Press and hold the “” DOWN button for three seconds to enter Level Diagnostics Mode. In this mode, key diagnostics can be viewed for trouble shooting and problem solving. In addition, the values can be reset to zero individually by pressing “ SET/REGEN” for 3 seconds

PARAMETER	DESCRIPTION
LAST REGEN	This value is the date the valve last performed a regeneration cycle.
TOTAL REGENS	This value is the total number of regenerations the valve has performed.
METER TOTAL	This value is the total number of gallons the system has treated.
CURRENT FLOW RATE	This is the current flow rate (gallons per minute) of water through the valve flow meter.
CURRENT REFILL	This is the current value of the REFILL calculation.
CAPACITY	This is the current value of the CAPACITY calculation.
REGEN. DAYS	This is the current value of the REGEN. DAYS calculation.
PEAK FLOW RATE	This is the highest flow rate (gallons per minute) recorded by the valves flow meter in the past 48hours.
SOFTWARE VER.	This is the current version of software.

Figure 7. Diagnostic Displays

Vacation Settings Mode

1. Press “” for three seconds to unlock screen.
2. Press “” to advance to VACATION MODE.
3. Press and hold the “ UP” for three seconds to enter the Vacation Settings Mode. In this mode the length of time for backwash and rinse along with the frequency are set while the valve is in vacation mode.

PARAMETER	DESCRIPTION
REGEN. DAYS	This value is the frequency of how often the unit should perform a brief backwash and rinse.
BACKWASH	This option controls the length of time in minutes for the unit to briefly clean the bed by reversing the flow of water upwards through the bed and out to the drain.
RINSE	This option controls the length of time to give the tank a brief rinse from the top to the bottom in order to remove any stale or stagnant water from the tank.

Figure 8. Vacation Mode Settings

Valve Cycle Settings for Softeners

RESIN VOLUME	VALVE CYCLE SETTINGS (MINUTES)					
	CLEAN WATER			PROBLEM WATER		
	BACKWASH	BRINE/RINSE	RINSE	BACKWASH	BRINE/RINSE	RINSE
0.75	5.0	50.0	5.0	10.0	60.0	10.0
1.00	5.0	50.0	5.0	10.0	60.0	10.0
1.50	5.0	50.0	5.0	10.0	60.0	10.0
2.00	5.0	50.0	5.0	10.0	60.0	10.0
2.50	5.0	50.0	5.0	10.0	60.0	10.0
3.00	5.0	50.0	5.0	10.0	60.0	10.0

Suggested Softener Valve Configuration			
Tank Size (Diameter)	Injector Set	Brine Line Flow Control (BLFC)	Drain Line Flow Control (DLFC)
6"	#000 Grey	#2 0.70 GPM	#1 (1.5 GPM)
7"			
8"	#00 Purple		
9"	#0 Red		
10"	#1 White		
12"	#2 Blue		
13"	#3 Yellow		
14"			
16"		none	

Figure 9. Valve Cycle Settings

Drain Line Flow Control

Suggested Filter Valve Configuration	
Tank Size (Diameter)	Drain Line Flow Control (DLFC)
8"	#4 (3.5 GPM)
9"	#6 (4.0 GPM)
10"	#7 (5.0 GPM)
12"	none

Suggested Iron Filter Valve Configuration			
Tank Size (Diameter)	Injector	Brine Line Flow Control (BLFC)	Drain Line Flow Control (DLFC)
8"	#2 (PVC)	(0.70 GPM)	#4 (3.5 GPM)
9"			#6 (4.0 GPM)
10"			#7 (5.0 GPM)
12"			none

Figure 10. Valve Configurations (#2 PVC Injector not included.)

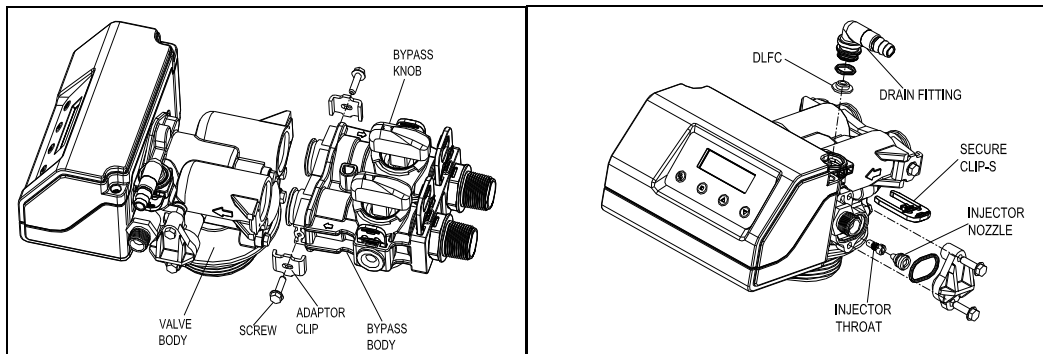
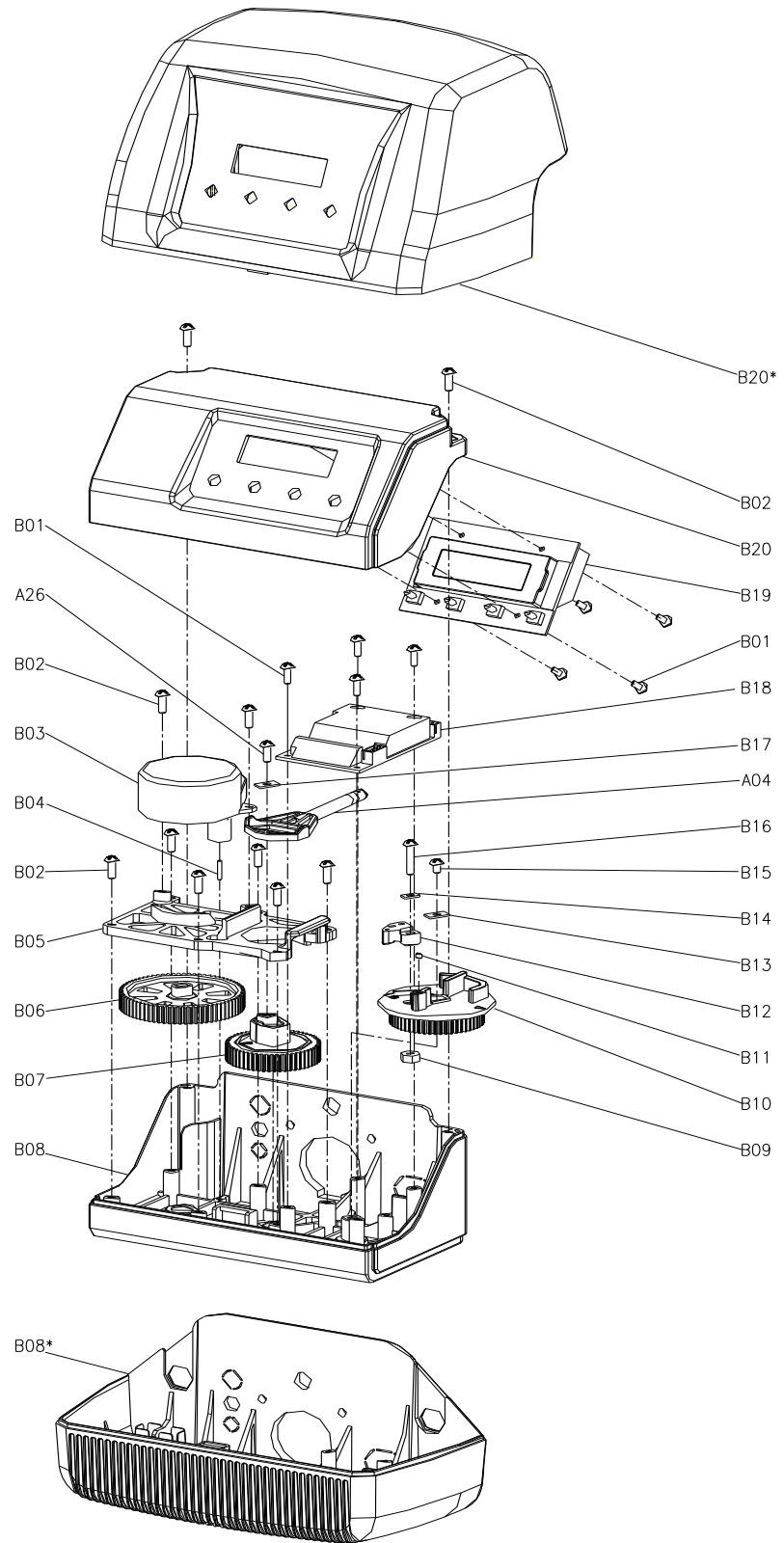

Figure 11. Valve Configuration View

Valve Drive Assembly Exploded View



Valve Drive Parts List

B01	05010037	Screw-ST2.9x10	8
A26	13000426	Screw-ST2.9x13(Large Wafer)	1
B02	05056084	Screw-ST3.5x13	8
B03	05056510	Motor-12v/2rpm	1
	05030014	Motor Power Cable	1
	11700005	Wire Connector	2
B04	05056098	Motor Pin	1
B05	05030006	Bnt85 Mounting Plate	1
B06	05030009	Bnt85 Drive Gear	1
B07	05030007	Bnt85 Main Gear	1
B08	05030005	Bnt85 Housing	1
B08*	05030016	Bnt185 Housing	1
B09	05056089	Nut-M4	1
B10	05030008	Bnt85 Brine Gear	1
B11	05010023	Magnet-φ3×2.7	1
B12	05056016	Refill Regulator	1
B13	05056141	Washer-4x12	1
B14	13111004	Washer-4x9	1
B15	05056166	Screw-ST4.2x12(Large Wafer)	1
B16	05056083	Screw-M4x14	1
A04	05030002	Bnt85 Piston Rod	1
B17	05056139	Washer-3x13	1
B18	05030010	Bnt85 Main Pcb	1
	05010031	Meter Assembly	1
	05010046	Meter Strain Relief	1
	05010029	Power Cable	1
	05010035	Power Strain Relief	1
	19010105	Wire Rope-3x100	2
B19	05030011	Bnt85 Display	1
	05030021	Bnt85 Wiring Harness	1
B20	05030003	Bnt85 Cover	1
	05030012	Bnt85 Label	1
B20*	05030015	Bnt185 Cover	1
	05030017	Bnt185 Label	1

Control Valve Assembly Exploded View

FILTER INJECTOR OPTION

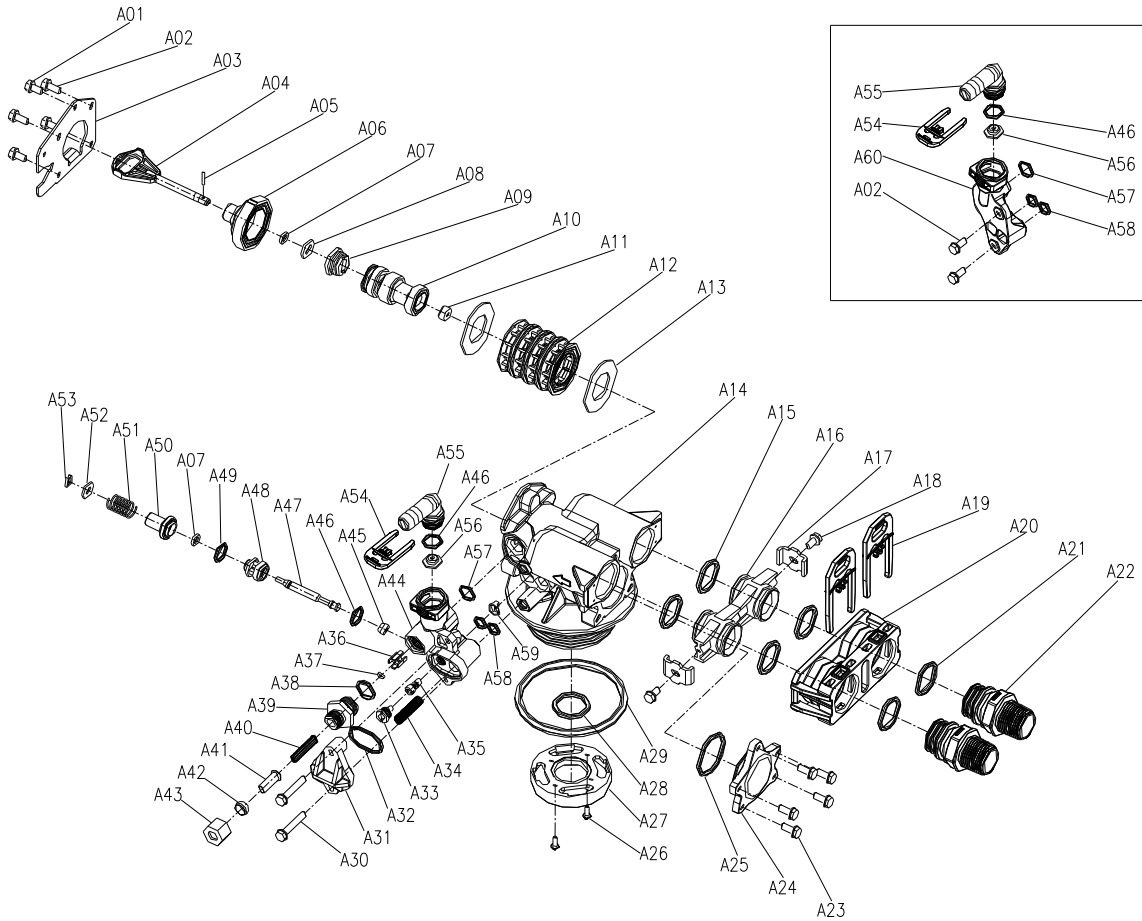

Control Valve Parts List

Item No.	Part No.	Part Description	Quantity
A01	05056087	Screw-M5x12(Hexagon)	3
A02	05056088	Screw-M5x16(Hexagon with Washer)	2
A03	05056047	End Plug Retainer	1
A04	05030002	Bnt85 Piston Rod	1
A05	05056097	Piston Pin	1
A06	05056023	End Plug	1
A07	05056070	Quad Ring	2
A08	05056024	End Plug Washer	1
A09	05056022	Piston Retainer	1
A10	05056181	Piston (Electrical)	1
A11	05056104	Muffler	1
A12	05056021	Spacer	4
A13	05056073	Seal	5
A14	05030001	Bnt85 Valve Body	1
A15	05056129	O-ring-φ23×3	4
A16	05056025	Adaptor Coupling	2
A17	05056044	Adaptor Clip	2
A18	05056090	Screw-ST4.2x13(Hexagon with Washer)	2
A19	21709003	Secure Clip	2
A20	05056140	Valve Connector	1
A21	05056065	O-ring-φ23.6×2.65	2
A22	21319006	Screw Adaptor	2
A23	05056508	Screw-M5x12(Hexagon with Washer)	5
A24	05030004	Bnt85 End Cover	1
A25	05030013	O-ring-φ30×2.65	1
A26	13000426	Screw-ST2.9x13(Large Wafer)	2
A27	07060007	Valve Bottom Connector	1
A28	26010103	O-ring-φ25×3.55	1
A29	05056063	O-ring-φ78.74×5.33	1
A30	05056086	Screw-M5x30(Hexagon with Washer)	2
A31	05056029	Injector Cover	1
A32	05056072	O-Ring-φ24×2	1
A33	05056027	Injector Nozzle	1
A34	05056103	Injector Screen	1
A35	05056028	Injector Throat	1
A36	05056035	BLFC Button Retainer	1
A37	05056191	BLFC-2#	1
A38	05056138	O-Ring-φ14×1.8	1
A39	05056100B	BLFC Fitting	1
A40	05056106	Brine Line Screen	1
A41	05056107	BLFC Tube Insert	1

Trouble Shooting

Issue	Possible Cause	Possible Solution
A. Unit fails to initiate a regeneration cycle.	1. No power supply.	Check electrical service, fuse, etc.
	2. Defective circuit board.	Replace faulty parts.
	3. Power failure.	Reset time of day.
B. Water is hard.	1. By-pass valve open.	Close by-pass valve.
	2. Out of salt.	Add salt to tank.
	3. Plugged injector / screen.	Clean parts.
	4. Flow of water blocked to brine tank.	Check brine tank refill rate.
	5. Hard water in hot water tank.	Repeat flushing of hot water tank required.
	6. Leak between valve and central tube.	Check if central tube is cracked or o-ring is damaged. Replace faulty parts.
	7. Internal valve leak.	Replace valve seals, spacer, and piston assembly.
C. Salt use is high.	1. Refill time is too high.	Check refill time setting.
D. Low water pressure.	1. Iron or scale build up in line feeding unit.	Clean pipes.
	2. Iron build up inside valve or tank.	Clean control and add resin cleaner to clean bed. Increase regeneration frequency.
	3. Inlet of control plugged due to foreign material.	Remove piston and clean control valve.
E. Resin in drain line.	1. Air in water system.	Check well system for proper air eliminator control.
	2. Incorrect drain line flow control (DLFC) button.	Check for proper flow rate.
F. Too much water in brine tank.	1. Plugged injector or screen.	Clean parts.
	2. Valve not regenerating.	Replace circuit board, motor, or control.
	3. Foreign material in brine valve.	Clean parts.
G. Unit fails to draw brine.	1. Drain line flow control is plugged.	Clean parts.
	2. Injector or screen is plugged.	Clean parts.
	3. Inlet pressure too low.	Increase pressure to 25 PSI.
	4. Internal valve leak.	Replace seals, spacers, and piston assembly.
H. Valve continuously cycles.	1. Defective position sensor PCB.	Replace faulty parts.
I. Flow to drain continuously.	1. Valve settings incorrect.	Check valve settings.
	2. Foreign material in control valve.	Clean control.
	3. Internal leak.	Replace seals, spacers, and piston assembly.

Safeway Water® Guarantee

Safeway Water guarantees that your new water conditioner is built of quality material and workmanship. When properly installed and maintained, it will give years of trouble free service.

Seven Year Complete Parts Guarantee:

Safeway Water will replace any part which fails within 84 months from date of manufacture, as indicated by the serial number, provided the failure is due to a defect in material or workmanship. The only exception shall be when proof of purchase or installation is provided and then the warranty period shall be from the date thereof.

Life Time Guarantee on Mineral Tanks and Brine Tanks:

Safeway Water will provide a replacement mineral tank or brine tank to any original equipment purchaser in possession of a tank that fails provided that the water conditioner is at all times operated in accordance with specifications and not subject to freezing.

General Provisions:

Safeway Water assumes no responsibility for consequential damage, labour or expense incurred as a result of a defect or for failure to meet the terms of these guarantees because of circumstances beyond its control.

