

CONTENTS

SAFETY INFORMATION	2
FOR YOUR SAFETY	2
SYSTEM OPERATION	2
THERMOSTATS	2
INTERMITTENT IGNITION DEVICE	2
OPERATING INSTRUCTIONS	3
EXPLAIN UNIT FUNCTION	4
GENERAL MAINTENANCE	4
HEATING SYSTEM INSPECTION	4
AIR FILTERS	5
BLOWER ASSEMBLY	5
MOTORS	6
CONDENSER COIL	6
REGISTERS	6
TROUBLESHOOTING	6
BEFORE CALLING A SERVICE TECHNICIAN: ..	6

USER'S, MAINTENANCE and SERVICE INFORMATION MANUAL

3 THRU 12.5 TON SINGLE PACKAGE AIR CONDITIONER GAS/ELECTRIC & ELECTRIC/ELECTRIC

The "User" must read all sections of this manual and keep the manual for future reference.

▲WARNING

FIRE OR EXPLOSION HAZARD

Failure to follow safety warnings exactly could result in serious injury, death, or property damage.

- Do not store or use gasoline or other flammable vapors and liquids in the vicinity of this or any other appliance.

- WHAT TO DO IF YOU SMELL GAS:

- Do not try to light any appliance.
- Do not touch any electrical switch; do not use any phone in your building.
- Leave the building immediately.
- Immediately call your gas supplier from a neighbor's phone. Follow the gas supplier's instructions.
- If you cannot reach your gas supplier, call the fire department.

- Installation and service must be performed by a qualified installer, service agency or the gas supplier.

SAFETY INFORMATION

FOR YOUR SAFETY

- Make sure that the furnace area is clear and free of combustible materials, gasoline and other flammable vapors and liquids.
- Be sure the furnace is clear and free of insulating material. Examine the furnace area after installation of the furnace or the installation of additional insulation. Some types of insulation maybe combustible.
- For proper and safe operation, the furnace needs air for combustion and ventilation. Do not block or obstruct air openings on the furnace or the space around the furnace. Maintain the required unit clearances.
- For lighting or shutting down this furnace, refer to the lighting instructions provided adjacent to the burners in the unit and also located in this manual on Pages 7 and 8.
- A blocked vent roll-out switch is provided in the burner compartment. This switch is a manual reset. If the furnace fails to operate, contact a qualified service technician.
- Should the gas supply fail to shut off or if overheating occurs, shut off the gas valve to the furnace before shutting off the electrical supply. Then call a qualified service technician.
- Do not use this furnace if any part has been under water. A flood-damaged furnace is extremely dangerous. Attempts to use the furnace can result in fire or explosion. A qualified service technician should be contacted to inspect the furnace and to replace all gas controls, control system parts, electrical parts that have been wet or the furnace if deemed necessary.
- Determine the integrity of the installation regarding the flue gas vent, the return and supply air duct. All flue gas carrying areas external to the furnace must be clear and free of obstructions. The external vent should be attached and physically sound without holes or excessive corrosion. The return-air duct connection(s) should be physically sound and sealed to the furnace casing. The physical support of the furnace should be sound without sagging, cracks, gaps with no obvious signs of deterioration. The burner flames in operation should appear as detailed in figure 3. The manufacturer recommends that main burner, ignition device and controls are inspected by a qualified service technician before each heating season.

SYSTEM OPERATION

THERMOSTATS

Set your thermostat for either heating or cooling then set it for the desired temperature. **DO NOT ADJUST THE THERMOSTAT RAPIDLY ON AND OFF, OR BACK AND FORTH FROM HEAT TO COOL. THIS COULD DAMAGE YOUR EQUIPMENT.**

Always allow at least 5 minutes between changes. Find the temperature that is most comfortable to you and then **LEAVE YOUR THERMOSTAT ALONE.** (Exception is for night or vacation “set back” to conserve energy).

Manually moving the thermostat up or down will not speed up temperature changes in your rooms. This only causes the thermostat switch to function at your command rather than responding to room temperature.

Heat generated by devices other than the furnace may interfere with thermostat performance. Therefore, lamps, radios, television sets, etc. should not be placed near the thermostat.

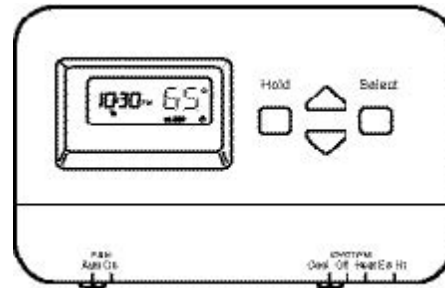

FIGURE 1- TYPICAL THERMOSTAT

INTERMITTENT IGNITION DEVICE

CAUTION

This furnace is equipped with an intermittent automatic ignition system. **Do Not** attempt to manually relight the burners. Personal injury could result.

When the thermostat calls for heat, gas is supplied and at the same time, sparking occurs to light the burner. With the burner lit, the flame sensor rod closes a circuit to the igniter control which allows the burner to continue to fire.

When the room thermostat is satisfied, the electrical circuit to the gas valve is opened, closing main burner gas. If the burner should fail to light, contact your heating contractor or gas utility for service to insure that proper operating conditions are restored.

INPUT

The correct heat capacity of the furnace is regulated by the burner orifices and the gas pressure. The proper orifices are furnished but the gas pressure regulator must be adjusted by the installer or gas utility service technician.

OPERATING INSTRUCTIONSTO SHUT DOWN THE FURNACE:

1. Close the main gas shutoff valve(s).
2. Turn off the electric power supply.

TO LIGHT THE FURNACE:

WARNING

FIRE OR EXPLOSION HAZARD

Failure to follow safety warnings exactly could result in serious injury, death, or property damage.

- Do not store or use gasoline or other flammable vapors and liquids in the vicinity of this or any other appliance.
- WHAT TO DO IF YOU SMELL GAS:
 - Do not try to light any appliance.
 - Do not touch any electrical switch; do not use any phone in your building.
 - Leave the building immediately.
 - Immediately call your gas supplier from a neighbor's phone. Follow the gas supplier's instructions.
 - If you cannot reach your gas supplier, call the fire department.
- Installation and service must be performed by a qualified installer, service agency or the gas supplier.

1. Do not attempt to light manually.
2. Open the main gas shutoff valve(s).
3. Adjust the set point of the room thermostat above the temperature in the space.
4. Turn on the electric power supply.
5. The draft fan will operate. After an adequate purge time, the electric spark igniter will light the burners.
6. The burners will extinguish and relight automatically upon the demand of the room thermostat.

VENT SAFETY SYSTEM:

This gas furnace is equipped with a manual reset high temperature sensor or rollout switch which in the unlikely event of a sustained main burner flame rollout will shut off the flow of gas by closing the main gas valve. The ignition modules will also be disabled, preventing the flow of gas to the valve. The switch is located inside the gas heat access panel above the burner inlet. Flame rollout can be caused by blockage of the power vent system, improper gas pressure or adjustment. If this event occurs the furnace will not operate properly. The gas supply to the furnace should be shut off and no attempt should be made to place the furnace in operation. The system should be inspected by a qualified service technician. Refer to Figure 2 for a typical installation.

100% SHUT OFF:

The ignition modules are designed for 100% shut-off. If the furnace fails to ignite after three ignition attempts, the flow of gas will be shut off and the ignition module will lock out. The module can be reset by:

- A. Turning the system switch on the room thermostat to the "OFF" position and back to the "HEAT" position.
- B. Decreasing the set point of the room thermostat below the temperature in the conditioned space and returning it to its original setting.
- C. Opening and closing the unit's main disconnect switch.

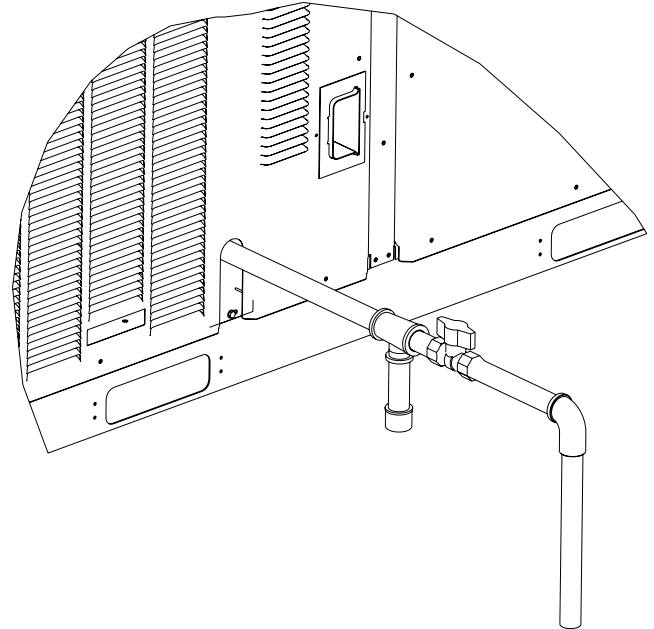
**FIGURE 2- TYPICAL INSTALLATION**

If the furnace continues to lock out, a qualified service technician should be called to determine the cause of the problem.

⚠ WARNING

ELECTRICAL SHOCK, FIRE OR EXPLOSION HAZARD

Failure to follow safety warnings exactly could result in dangerous operation, serious injury, death or property damage.

Improper servicing could result in dangerous operation, serious injury, death or property damage.

- Before servicing, disconnect all electrical power to furnace.
- When servicing controls, label all wires prior to disconnecting. Reconnect wires correctly.
- Verify proper operation after servicing.

⚠ WARNING

Prior to any of the following maintenance procedures, shut off all power to the unit to avoid personal injury.

EXPLAIN UNIT FUNCTION

When the system is functioning properly, show the owner the location of all disconnect switches and the thermostat. Explain how to start and stop the unit and how to adjust temperature settings within the limitations of the system. Advise that the flue exhaust hood surface and the immediate area will experience high temperatures during the heating cycle, and that all unauthorized personnel and debris must be kept away from this area.

GENERAL MAINTENANCE

In order to insure long and trouble free service from your system, we recommend periodic inspection, cleaning, lubrication and adjustment by your installing Dealer/Contractor. Be sure to ask about this service. For those who prefer to do-it-yourself, please follow the instructions listed below to care for your system.

Snow or debris should not be allowed to accumulate in or around the unit. Do not permit overhanging structures or shrubs to obstruct outdoor air discharge, combustion air inlets or vent outlets on your unit. These provide air for combustion and ventilation. Adequate air is important to the safe and proper operation of the unit.

HEATING SYSTEM INSPECTION

It is the owner's responsibility to insure that an annual inspection of the entire heating portion of the unit is made by a qualified service technician. This should include inspection of the burner, heating element and flue for any corrosion or soot accumulation which may require cleaning and also checking of burner and controls for proper operation.

In addition, at least once during the heating season, the owner shall make a visual inspection of the flue outlet for evidence of black soot or blockage of flue outlet by leaves or other debris. If any soot is found, it is recommended a qualified service technician be called immediately. If any blockage is found, it must be cleared immediately. After removing the debris, check the manual reset rollout switch located above the burner shield and reset as needed. (See Figure 3.)

Check for obvious signs of deterioration of the unit. Check that the return and supply ducts attached to the unit are sound and air tight. Check that the unit's physical support, concrete slab or roof curb, is sound and not in need of repair. Make sure there are no gaps between the roof curb and the unit where rain could leak into the building.

Start the furnace. The vent motor should start, the igniter will start to spark and ignite the burner. If it does not, contact a qualified service technician for assistance. Check the appearance of the main burner flame. The flame should have a blue appearance. (See Figure 3.)

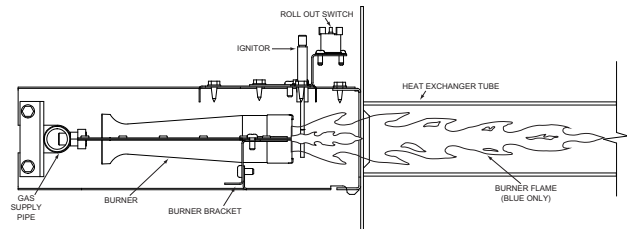

FIGURE 3- TYPICAL FLAME

BURNER CHECK

Periodically (at least annually at the beginning of each heating season) make a visual check of the main burner flame to determine if the burners need cleaning.

CLEANING BURNERS

Remove them from the furnace as explained the in BURNER/ORIFICE INSTRUCTIONS section in the Unit Installation Instructions. Clean burners with wire brush and vacuum as needed.

CLEANING FLUE PASSAGES & HEATING ELEMENTS

With proper combustion adjustment, the heat exchanger tubes of a gas-fired furnace will seldom need cleaning. If the tubes should become sooted, they can be cleaned as follows:

1. Remove the burner assembly as outlined in "BURNER/ORIFICES INSTRUCTIONS" of the unit Installation Instructions.
2. Remove the screws holding the flue collector box. Carefully remove the flue collector box.
3. Remove the flue baffles from the tube interiors.
4. Using a wire brush on a flexible wand, brush out the inside of each heat exchanger from the burner inlet and flue outlet ends.

5. Brush out the inside of the flue collector box and the flue baffles.
6. Run the wire brush into the flue exhaust tube from the flue collector end. Do not damage the flue exhaust screen, remove if necessary.
7. If soot build-up is particularly bad, remove the draft motor and clean the wheel and housing.
8. After brushing is complete, blow away all brushed areas with air or nitrogen. Vacuum as needed.
9. Replace parts in the reverse order that they were removed in Steps 1 through 3.
10. Assure that all seams on the vent side of the combustion system are airtight. Apply a high temperature (500°F+) sealing compound where needed.

AIR FILTERS

ZX 3, 4, 5 ton and ZY 3 ton units require 2 filters. All other units contain four filters. The filter racks on these units will

receive either 1" or 2" filters. Filters can also be installed in the building at a suitable return air location if an economizer or outside air accessory is not used. Filters must always be used. They should be inspected once a month and thoroughly cleaned or replaced if it appears they are beginning to accumulate excessive dirt.

To install the filters, remove the filter access panel as shown in Figure 4.

NOTE: Filters must be installed with "Air Flow" arrows pointing inward -- toward the indoor coil. In the event the spacers in the filter section are removed, they must be reinstalled in their original position.

Slide filters all the way into the filter racks provided. When more than one filter in a filter rack is required, they must butt each other when sliding into position. Replace the filter access panel.

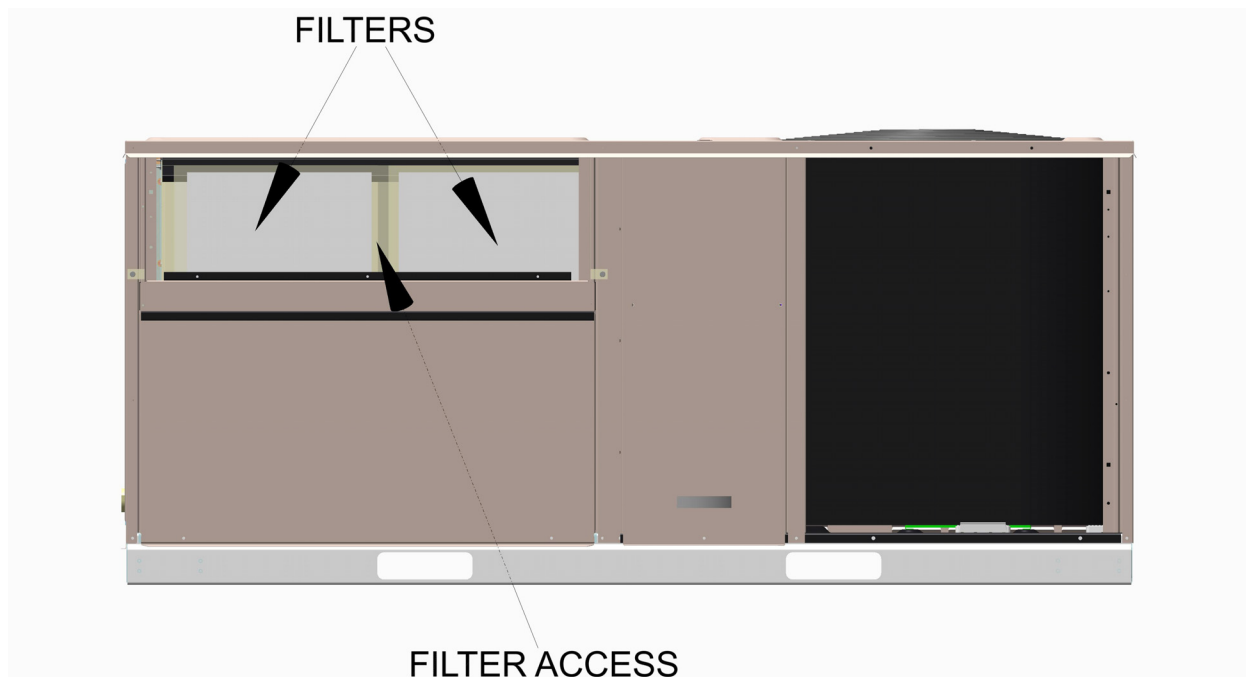

FIGURE 4- FILTER ACCESS

BLOWER ASSEMBLY

Even with good filters properly in place, blower wheels and motors will become dust laden after many months of operation. The entire blower assembly should be inspected annually. If the motor and wheel are heavily coated with dust, they can be brushed and cleaned with a vacuum cleaner.

These units are supplied with blower shaft bearings that do not require maintenance but may be lubricated if desired. Every three years, using a low pressure grease gun, pump

grease into the bearing grease fitting until grease just begins to show at the seals. Do not over lubricate. Use any lithium base grease recommended for ball bearing service.

WARNING

Perform all maintenance operations on the blower assembly and motor with electric power disconnected from the unit. Do not attempt to lubricate bearings with the unit in operation.

MOTORS

Outdoor fan motors are permanently lubricated and do not require maintenance.

Ventor motor is factory lubricated for an estimated 10 year life.

The indoor blower motor features ball bearings that do not require periodic lubrication. However, if the motor has grease fittings, periodic lubrication of the motor bearings can extend the life of components but is optional.

WARNING

Perform all maintenance operations on the blower motor with electric power disconnected from the unit. Do not attempt to lubricate bearings with the unit in operation.

If desired, every three years, using a low pressure grease gun, pump grease into the bearing grease fitting until grease just begins to show at the seals. Do not over lubricate. Use any lithium base grease recommended for ball bearing service.

CAUTION

Damage can occur if the bearings are overlubricated. Use grease sparingly.

CONDENSER COIL

An annual check and cleaning, if necessary, of the outdoor coil should be done. Cleaning should be as often as necessary to keep the coil clean. Cleaning should be as often as necessary to keep the coil clean. Clean any debris and dirt from the outside coil face with a brush being careful not to damage the fins. If extremely dirty, a hose can be used to wash the coil from the inside out while brushing a soapy solution on the outside.

REGISTERS

Supply and return air registers must be open when the unit is in operation. Obstructions must not be allowed to block air-flow in or out of the registers.

TROUBLESHOOTING

BEFORE CALLING A SERVICE TECHNICIAN:

- A. Check thermostat setting and insure thermostat is calling for heat or cooling.
- B. Check thermostat for lint, etc.
- C. Check fuses or circuit breakers.
- D. Check filters for excessive dust accumulation.

LIGHTING INSTRUCTIONS / INSTRUCTIONS D'ALLUMAGE

FOR YOUR SAFETY READ BEFORE OPERATING

WARNING: If you do not follow these instructions exactly, a fire or explosion may result causing property damage, personal injury, or loss of life.

- This appliance does not have a pilot. It is equipped with an ignition device which automatically lights the burner. Do **not** try to light the burner by hand.
- BEFORE OPERATING** smell all around the appliance area for gas. Be sure to smell next to the floor because some gas is heavier than air and will settle on the floor.

WHAT TO DO IF YOU SMELL GAS:

- Do not try to light any appliance.
 - Do not touch any electric switch; do not use any phone in your building.
 - Immediately call your gas supplier from a neighbor's phone. Follow the gas supplier's instructions.
 - If you cannot reach your gas supplier, call the fire department.
- Use only your hand to push the gas control switch. Never use tools. If the switch will not push by hand, don't try to repair it, call a qualified service technician. Force or attempted repair may result in a fire or explosion.
 - Do not use this appliance if any part has been under water. Immediately call a qualified service technician to inspect the appliance and to replace any part of the control system and any gas control which has been under water.

POUR PLUS DE SÉCURITÉ, LIRE AVANT DE METTRE EN MARCHÉ

AVERTISSEMENT: Quiconque ne respecte pas à la lettre les instructions dans le présent manuel risque de déclencher un incendie ou une explosion pouvant entraîner des dommages matériels, des blessures ou la mort.

- Cet appareil ne comporte pas de veilleuse. Il est muni d'un dispositif d'allumage qui allume automatiquement le brûleur. Ne **pas** tenter d'allumer le brûleur manuellement.
- Avant de faire fonctionner l'appareil, renifler tout autour de l'appareil à la recherche d'une odeur de gaz. Renifler près du plancher, car certains gaz sont plus lourds que l'air et peuvent s'accumuler au niveau du sol.

QUE FAIRE VOUS SENTEZ UNE ODEUR DE GAZ:

- Ne pas tenter d'allumer d'appareils.
 - Ne toucher à aucun interrupteur; ne pas vous servir des téléphones dans le bâtiment.
 - Appelez immédiatement votre fournisseur de gaz depuis un voisin. Suivez les instructions du fournisseur de gaz.
 - Si vous ne pouvez rejoindre le fournisseur de gaz, appelez le service des incendies.
- Ne pousser le commutateur d'admission du gaz qu'à la main. Ne jamais employer d'outil à cette fin. Si le commutateur reste coincée, ne tentez pas de la réparer; appelez un technicien qualifié. Quiconque tente de forcer le commutateur ou de la réparer peut provoquer une explosion ou un incendie.
 - Ne pas se servir de cet appareil s'il a été plongé dans l'eau, même partiellement. Faire inspecter l'appareil par un technicien qualifié et remplacer toute partie du système de contrôle et toute commande qui ont été plongées dans l'eau.

OPERATING INSTRUCTIONS

- STOP!** Read the safety information above on this label
- Set the thermostat to lowest setting.
- Turn off all electric power to the appliance.
- This appliance is equipped with an ignition device which automatically lights the burner. **Do not try to light the burner by hand.**
- Remove control access panel.
- Move gas control switch to "OFF" position. Do not force.
- Wait five (5) minutes to clear out any gas. Then smell for gas, including near the floor.** If you smell gas, STOP! Follow "B" in the SAFETY INFORMATION above on this label. If you don't smell gas, go to the next step.
- Move gas control switch to "ON" position. Do not force.
- Replace control access panel.
- Turn on all electric power to the appliance.
- Set thermostat to the desired setting.
- If the appliance will not operate, follow the instructions "TO TURN OFF GAS TO APPLIANCE" and call your service technician or gas supplier.

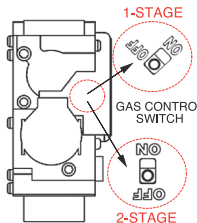

MISE EN MARCHÉ

- ARRÊTEZ!** Lisez les instructions de sécurité dans la section supérieure de cette étiquette.
- Régler le thermostat à la température la plus basse.
- Couper l'alimentation électrique de l'appareil.
- Cet appareil est équipé d'un système d'ignition qui allume automatiquement le brûleur. **Ne tentez pas de l'allumer manuellement.**
- Enlevez le panneau d'accès aux contrôles.
- Placez le commutateur du contrôle du gaz à la position OFF. Ne forcez pas.
- Attendre cinq (5) minutes pour laisser échapper tout le gaz.** Reniflez tout autour de l'appareil, y compris près du plancher, pour détecter une odeur de gaz. Si vous sentez une odeur de gaz, **ARRÊTEZ!** Passez à l'étape B des instructions de sécurité sur la portion supérieure de cette étiquette. S'il n'y a pas d'odeur de gaz, passez à l'étape suivante.
- Placez le commutateur de contrôle à la position ON. Ne forcez pas.
- Remplacez le panneau d'accès aux contrôles.
- Mettez l'appareil sous tension.
- Régler le thermostat à la température désirée.
- Si l'appareil ne se met pas en marche, suivre les instructions intitulées "COMMENT COUPER L'ADMISSION DE GAZ DE L'APPAREIL" et appeler un technicien qualifié ou le fournisseur de gaz.

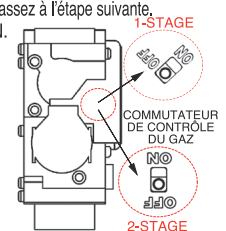

TO TURN OFF GAS TO APPLIANCE

- Set the thermostat to lowest setting.
- Turn off all electric power to the appliance if service is to be performed.
- Remove control access panel.
- Move gas control switch to "OFF" position.
- Replace control access panel.

COMMENT COUPER L'ADMISSION DE GAZ DE L'APPAREIL

- Régler le thermostat à la température la plus basse.
- Couper l'alimentation électrique de l'appareil s'il faut effectuer des opérations d'entretien.
- Enlevez le panneau d'accès aux contrôles.
- Placez le commutateur de contrôle des gaz à la position OFF.
- Remettez le panneau d'accès aux contrôles.

1072090-A-0913

FIGURE 5- LIGHTING INSTRUCTIONS FOR ZX04 THRU 07 AND ZY04 THRU 06

LIGHTING INSTRUCTIONS / INSTRUCTIONS D'ALLUMAGE

FOR YOUR SAFETY READ BEFORE OPERATING

WARNING: If you do not follow these instructions exactly, a fire or explosion may result causing property damage, personal injury, or loss of life.

- A. This appliance does not have a pilot. It is equipped with an ignition device which automatically lights the burner. Do **not** try to light the burner by hand.
 B. BEFORE OPERATING smell all around the appliance area for gas. Be sure to smell next to the floor because some gas is heavier than air and will settle on the floor.

WHAT TO DO IF YOU SMELL GAS:

- Do not try to light any appliance.
 - Do not touch any electric switch; do not use any phone in your building.
 - Immediately call your gas supplier from a neighbor's phone. Follow the gas supplier's instructions.
 - If you cannot reach your gas supplier, call the fire department.
- C. Use only your hand to push the gas control switch. Never use tools. If the switch will not push by hand, don't try to repair it, call a qualified service technician. Force or attempted repair may result in a fire or explosion.
- D. Do not use this appliance if any part has been under water. Immediately call a qualified service technician to inspect the appliance and to replace any part of the control system and any gas control which has been under water.

POUR PLUS DE SÉCURITÉ, LIRE AVANT DE METTRE EN MARCHÉ

AVERTISSEMENT: Quiconque ne respecte pas à la lettre les instructions dans le présent manuel risque de déclencher un incendie ou une explosion pouvant entraîner des dommages matériels, des blessures ou la mort.

- A. Cet appareil ne comporte pas de veilleuse. Il est muni d'un dispositif d'allumage qui allume automatiquement le brûleur. Ne **pas** tenter d'allumer le brûleur manuellement.
 B. Avant de faire fonctionner l'appareil, renifler tout autour de l'appareil à la recherche d'une odeur de gaz. Renifler près du plancher, car certains gaz sont plus lourds que l'air et peuvent s'accumuler au niveau du sol.

QUE FAIRE VOUS SENTEZ UNE ODEUR DE GAZ:

- Ne pas tenter d'allumer d'appareils.
 - Ne toucher à aucun interrupteur; ne pas vous servir des téléphones dans le bâtiment.
 - Appelez immédiatement votre fournisseur de gaz depuis un voisin. Suivez les instructions du fournisseur de gaz.
 - Si vous ne pouvez rejoindre le fournisseur de gaz, appelez le service des incendies.
- C. Ne pousser le commutateur d'admission du gaz qu'à la main. Ne jamais employer d'outil à cette fin. Si le commutateur reste coincée, ne tentez pas de la réparer; appelez un technicien qualifié. Quiconque tente de forcer le commutateur ou de la réparer peut provoquer une explosion ou un incendie.
- D. Ne pas se servir de cet appareil s'il a été plongé dans l'eau, même partiellement. Faire inspecter l'appareil par un technicien qualifié et remplacer toute partie du système de contrôle et toute commande qui ont été plongées dans l'eau.

OPERATING INSTRUCTIONS

1. **STOP!** Read the safety information above on this label
2. Set the thermostat to lowest setting.
3. Turn off all electric power to the appliance.
4. This appliance is equipped with an ignition device which automatically lights the burner. **Do not try to light the burner by hand.**
5. Remove control access panel.
6. Move gas control switch to "OFF" position. Do not force.
7. **Wait five (5) minutes to clear out any gas. Then smell for gas, including near the floor.** If you smell gas, STOP! Follow "B" in the SAFETY INFORMATION above on this label. If you don't smell gas, go to the next step.
8. Move gas control switch to "ON" position. Do not force.
9. Replace control access panel.
10. Turn on all electric power to the appliance.
11. Set thermostat to the desired setting.
12. If the appliance will not operate, follow the instructions "TO TURN OFF GAS TO APPLIANCE" and call your service technician or gas supplier.

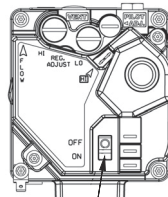

GAS CONTROL SWITCH

MISE EN MARCHÉ

1. **ARRÊTEZ!** Lisez les instructions de sécurité dans la section supérieure de cette étiquette.
2. Régler le thermostat à la température la plus basse.
3. Couper l'alimentation électrique de l'appareil.
4. Cet appareil est équipé d'un système d'ignition qui allume automatiquement le brûleur. **Ne tentez pas de l'allumer manuellement.**
5. Enlevez le panneau d'accès aux contrôles.
6. Placez le commutateur du contrôle du gaz à la position OFF. Ne forcez pas.
7. **Attendez cinq (5) minutes pour laisser échapper tout le gaz.** Reniflez tout autour de l'appareil, y compris près du plancher, pour détecter une odeur de gaz. Si vous sentez une odeur de gaz, ARRÊTEZ! Passez à l'étape B des instructions de sécurité sur la portion supérieure de cette étiquette. S'il n'y a pas d'odeur de gaz, passez à l'étape suivante.
8. Placez le commutateur de contrôle à la position ON. Ne forcez pas.
9. Remplacez le panneau d'accès aux contrôles.
10. Mettre l'appareil sous tension.
11. Régler le thermostat à la température désirée
12. Si l'appareil ne se met pas en marche, suivre les instructions intitulées "COMMENT COUPER L'ADMISSION DE GAZ DE L'APPAREIL" et appeler un technicien qualifié ou le fournisseur de gaz.

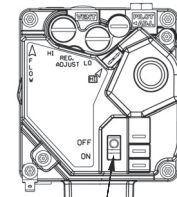

COMMUTATEUR DE CONTRÔLE DU GAZ

TO TURN OFF GAS TO APPLIANCE

1. Set the thermostat to lowest setting.
2. Turn off all electric power to the appliance if service is to be performed.
3. Remove control access panel.
4. Move gas control switch to "OFF" position.
5. Replace control access panel.

COMMENT COUPER L'ADMISSION DE GAZ DE L'APPAREIL

1. Régler le thermostat à la température la plus basse.
2. Couper l'alimentation électrique de l'appareil s'il faut effectuer des opérations d'entretien.
3. Enlevez le panneau d'accès aux contrôles.
4. Placez le commutateur de contrôle des gaz à la position OFF.
5. Remettez le panneau d'accès aux contrôles.

1072161-A-0913

FIGURE 6- LIGHTING INSTRUCTIONS FOR ZX08 THRU 14 AND ZY07 THRU 12

OWNER please have your installer fill in the following information immediately after unit has been installed and is properly operating.

Installed by _____

Installer's Address _____

Installation Date _____

Owner's Name _____

Owner's Address _____

Equipment installed at (address) _____

Model Number _____ Serial Number _____

Distributor from whom the equipment was purchased _____

The owner should keep this information in a place where it can be found if needed for warranty purposes.



Subject to change without notice. Printed in U.S.A.
Copyright © 2011 by Johnson Controls, Inc. All rights reserved.

1046287-UUM-A-1013
Supersedes: Nothing

**York International Corporation
5005 York Drive
Norman, OK 73069**

