



INSTALLATION AND MAINTENANCE INSTRUCTIONS

TYPE "L" VENT

TYPE "L" TEMPERATURE VENTING SYSTEMS

GENERAL ASSEMBLY INSTRUCTIONS



This symbol on the nameplate means this product is listed by Underwriters Laboratories, Inc. Listing No. MH 16402

Style P Round Metal-Fab Type L Vent
For Oil Burning Appliances

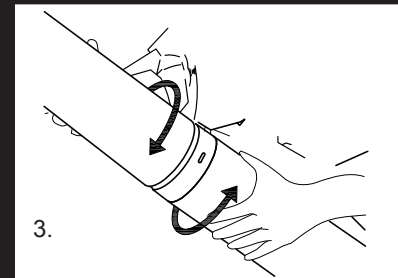
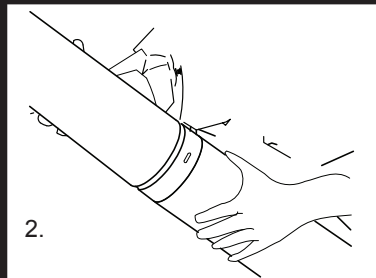
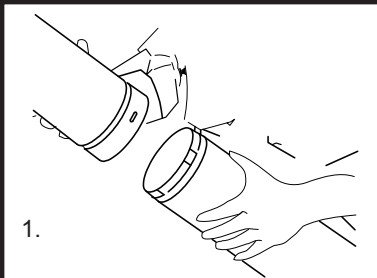

General Installation Notes

1. Metal-Fab L-Vent pipe and fittings are intended for installation to form a continuous passageway from either above the roof or horizontally through a wall. To comply with UL listings and Metal-Fab warranty, use only vent parts defined by these instructions or Metal-Fab brochure.
 2. Consult local building or fire officials about restrictions and installation inspection in your area.
 3. Metal-Fab L-Vent systems are listed for gas and oil furnaces that do not exceed 570°F at the outlet temperature, and for 1700°F for a 10-minute "safety over-fire" situation. Metal-Fab L-Vent is only allowed for use with appliances requiring a negative or neutral pressure venting system.
 4. A Metal-Fab L-Vent cap should be used on all installations to prevent back draft and to keep out rain and debris.
 5. For extra corrosion resistance with oil-burning equipment, vent components installed exterior to a building should include stainless cap, stainless jacketed pipe section(s) and stainless or aluminum flashings and storm collars.
 6. Use of commercially available combustion enhancing, acid-neutralizing fuel additives are recommended. Sulfur compounds becoming sulfuric acid and having a high dew point temperature are detrimental to any masonry or metal chimney vent system. High sulfur content and/or condensation in the vent system may result in unwanted staining of roof and siding.
 7. Inspect each part for damage, before installing.
 8. Maintain a 3" minimum clearance to combustibles when passing through a combustible wall, ceiling or roof. **Always** use a Firestop when penetrating a floor or ceiling.
- NOTE: Combustible materials include: materials made of or surfaced with wood, compressed paper, plant fibers, plastics or other material that will ignite and burn. Such material is considered combustible even though flame proofed, fire retarded or plastered.**
9. Type L-Vent is not listed for use with wood or coal fired appliances.
 10. When venting horizontally (see power vented section) maintain a clearance of 48" from doors, windows and public walkways.
 11. An increaser may be used at any point in the vent system to meet appliance manufacturers requirements.
 12. Before installing, consider the design and construction of the building so as to minimize the need to pass through existing structural supports.
 13. Minimum vent height is 6 feet. Maximum vent height should not exceed 60 feet. A vertical support is required at least every 30 feet.
 14. Elbows are designed for 45° and 90° turns, but can be adjusted (excluding 4" dia. size). All directional changes for 4" dia. L-Vent must be made at 45° or 90°.

Installation Instructions

Standard Interior Installation (See Fig. 1)

1. Start off of appliance flue collar with one of the following:

- Securely attach appliance adaptor (PSA) to flue collar using 3 evenly spaced sheet metal screws.
- If downsizing an oversized flue outlet (see sizing information, page 5) start with a single wall decreaser screwed to the flue outlet.
- For a combustion testing “access port”, a short length of single wall may be used from the flue outlet, attached to L-Vent connector. The normally required 3/8” hole may be drilled in the decreaser or short length of single wall.

Attach single wall pipe or fittings to starter section of L-Vent using 3 sheet metal screws.

2. Mark on the ceiling the vertical centerline of the intended vertical path of the L-Vent. A plumb bob is normally used to locate the centerline.

NOTE: A horizontal connector can be transitioned to vertical using a 90° Tee (PT). The bottom of the tee can be useful for inspection and cleaning.

3. Use a **Barometric Damper** when required by the appliance manufacturer. These may be connected to the tap of a standard Tee (PT) and are usually required in the vertical section in close proximity to the appliance outlet. Connect the barometric damper to the flue (inner wall) of the Tee tap, using sheet metal screws.

4. Cut a 14-1/2” square hole through the ceiling.

NOTE: When passing through a ceiling, it is recommended that the hole be framed. Use the same size joists as are present.

5. On the ceiling side, install the Firestop spacer (PFS).

NOTE: If the attic is directly above, install the Firestop spacer from the attic side.

6. Continue to run L-Vent main assembly up through the ceiling utilizing lengths of pipe twist-locked securely into place. In occupied spaces on succeeding floors, L-Vent should be enclosed with construction of equal fire rating to the surrounding structure. **Always maintain 3” minimum clearance to combustibles.** On succeeding floors, a Firestop (PFS) is required on each floor level (Consult local codes). Minimum framing opening requirements are shown in **TABLE 1**.

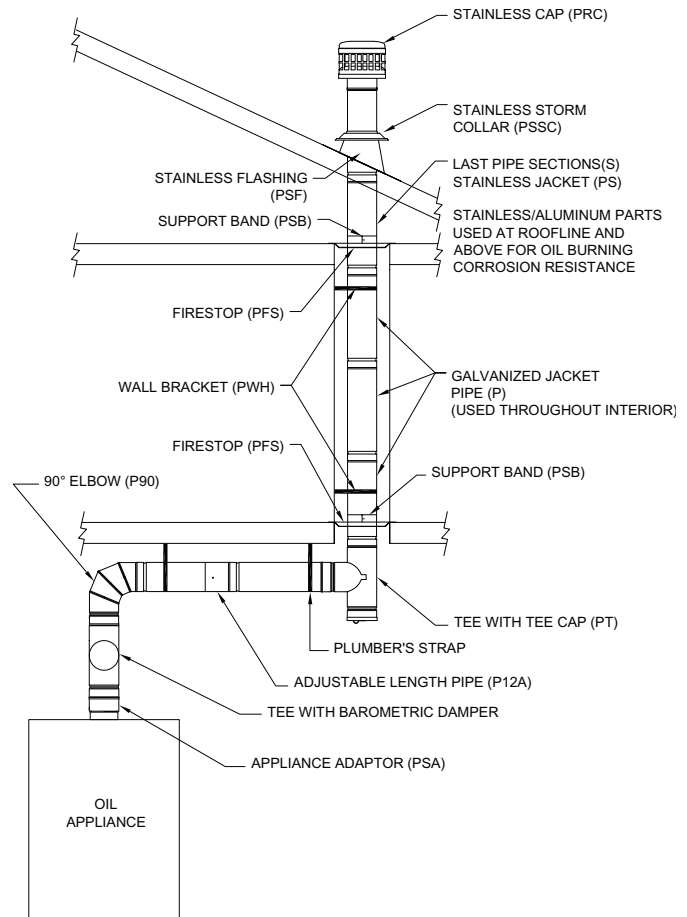

FIG. 1

7. Proceed up to the attic through the Firestop Spacer. In the attic, slip the Support Band (PSB) over the pipe with the flange of the band resting on the Firestop plate. Tighten the Band around the vent pipe, using the two (2) bolts and nuts provided. Note that an additional Firestop Spacer and Support Band can be used as a re-support for succeeding floors for vent systems taller than 30’.

IMPORTANT: All insulation or other combustible materials must be kept a minimum of 3” away from the pipe at all times.

8. If elbows are needed to position the vent away from obstructions in the attic, support the offset using chimney straps (plumber’s straps).

9. For L-Vent passing through the roof or overhang, cut a hole, per **TABLE 1**

TABLE 1

PIPE DIA.	REQ'D OPENING
4"	10-1/2" x 10-1/2"
5"	11-1/2" x 11-1/2"
6"	12-1/2" x 12-1/2"

10. Use appropriate aluminum or stainless steel flashing for roof pitch as follows:

PSFT – Tall Cone Flashing – Flat Roof to 2/12 pitch

PSF – Standard Flashing – 2/12 to 5/12 pitch

PSF-12 – High Pitch Flashing – 6/12 to 12/12 pitch

On a pitched roof, the upper half of flashing base should be mounted underneath shingles and lower half is positioned on top of surrounding shingles. Nail securely in place and caulk exposed edges.

11. Remember to use stainless steel jacketed pipe section for vent exposed above the roof. Install the pipe section through the flashing. Apply a thick ring of mastic tape around the vent pipe and then slide a storm collar down onto the mastic ring and secure.

12. Install stainless steel vent cap, twisting clockwise to secure at joint.

13. For cleaning or inspection, the vent cap may be removed by twisting counter clockwise and pull straight up.

14. If multiple sections of vent pipe (over 5' – over 14/12 pitch) are required above the roof, the top section should be guyed securely to the roof, in three equally spaced positions. Use plumber's strap as a band and #8 wire (minimum) from the strap secured to the roof joists with eyebolts.

Offsets and Sizing

1. Metal-Fab L-Vent terminations are UL Listed and wind-tested. Vertical terminations require a 2' horizontal space from the roof surface. Extra exposed height above the roof and the over-length offsets in a cold attic are undesirable contributors to condensation problems associated with modern oil fired appliances.

2. Offsets in attics should be minimal. 30° and 45° angles are preferred although one 60° offset may be permitted. Maximum horizontal length (L in **Fig. 2**) is limited to 18" per inch of vent diameter as follows:

Vent I.D.	L – Total Horizontal Length
4"	6 feet
5"	7.5 feet
6"	9 feet

OFFSETS

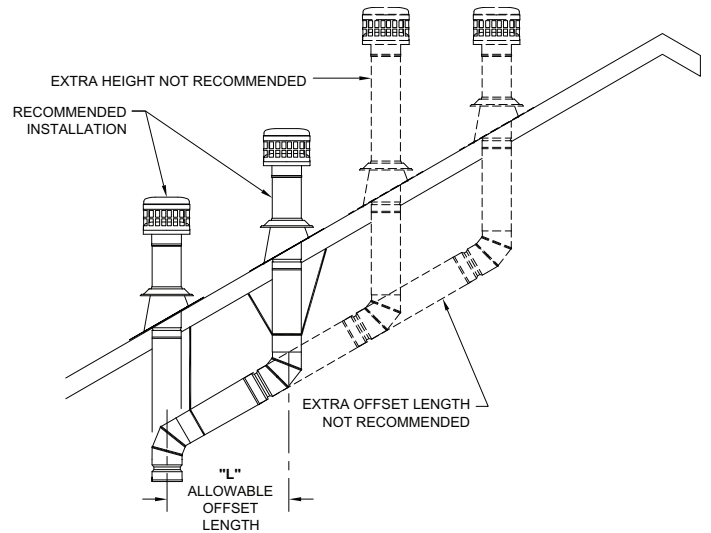

FIG. 2

3. Metal-Fab's wind-tested vent cap (PRC) is permitted to terminate in accordance with **Fig. 3** (Chart and drawing) provided it is at least 8 feet from a vertical wall.

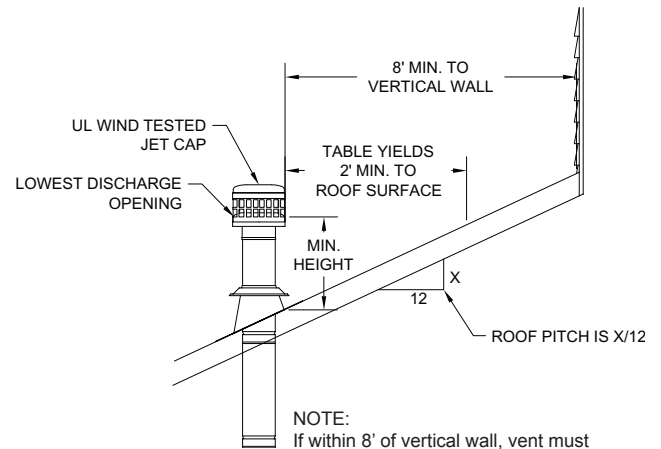

FIG. 3

ROOF PITCH	MINIMUM HEIGHT
FLAT TO 7/12	2.5 FEET*
OVER 7/12 TO 8/12	2.5 FEET*
OVER 8/12 TO 9/12	2.5 FEET*
OVER 9/12 TO 10/12	2.5 FEET
OVER 10/12 TO 11/12	3.25 FEET
OVER 11/12 TO 12/12	4.0 FEET
OVER 12/12 TO 14/12	5.0 FEET
OVER 14/12 TO 16/12	6.0 FEET
OVER 16/12 TO 18/12	7.0 FEET
OVER 18/12 TO 20/12	7.5 FEET
OVER 20/12 TO 21/12	8.0 FEET

* Lower height allowable with gas equipment. 2.5 feet recommended for oil fired equipment.

Negative Pressure Power Venting

1. Metal-Fab L-Vent may be used with negative pressure power venters to minimize condensation problems.
2. Follow step 1 of Standard Interior Installation instructions for connection of vent to appliance. If required follow step 3 of Standard Interior Installations for use with **Barometric damper**.
3. L-Vent may be **Used in Joist Spaces** which are normally 16" on center yielding 14-1/2" opening. **Always maintain a minimum of 3" clearance to combustibles.** Support with support band (PSB).
4. Attach male end of L-Vent pipe to 90° elbow to collar of power venter using 3 equally spaced sheet metal screws. Follow proper power venter manufacturer's sizing and installation instructions.

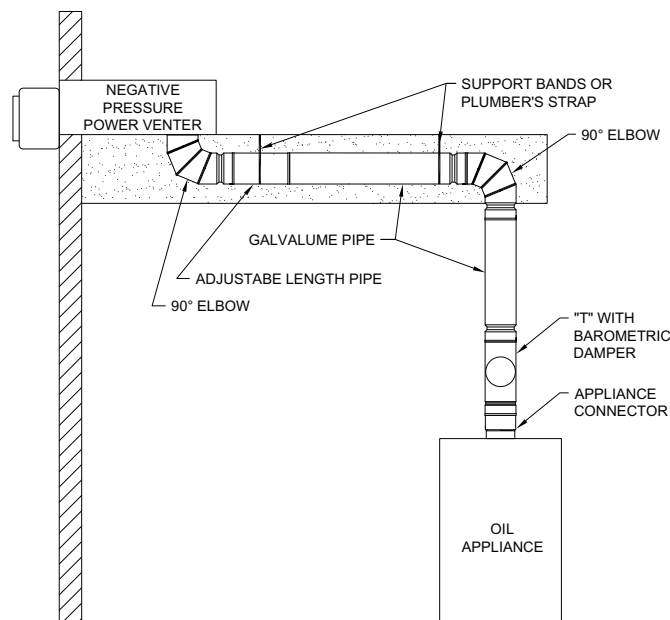

FIG. 4

Type L-Vent as a Chimney Liner

1. Type L-Vent may be used as a chimney liner in an unoccupied masonry chimney. It may be used in conjunction with stainless steel flexible liners or connectors in chimneys with offsets.
2. Follow step 1 of Standard Interior Installation instructions for connection of vent to appliance. If required follow step 3 of Standard Interior Installations for use with **Barometric damper**.
3. Cut a large enough hole out of the side of the masonry chimney for a capped tee (PT) to be used at the base of the masonry chimney. Support the tee by drilling holes to place 2 each 3/8" minimum rods into the tile liner to support the tee. (See Fig. 5).

4. Securely lock sections of pipe together from the top of the chimney, feeding pipe down to connect with the capped tee at the base. Finish the top of chimney with a tall cone flashing attached to masonry, storm collar and cap.

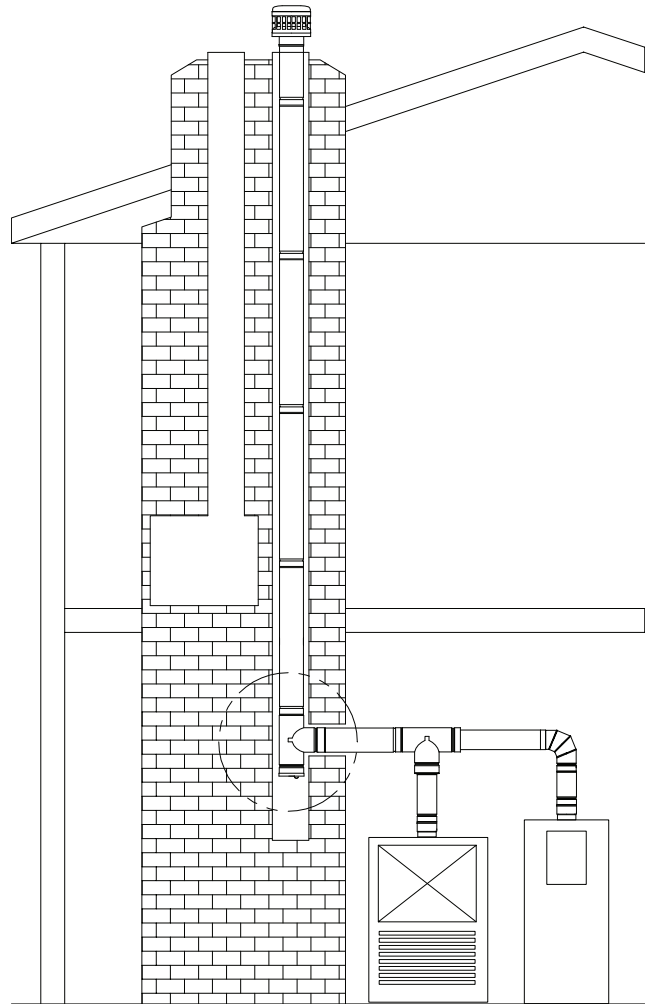
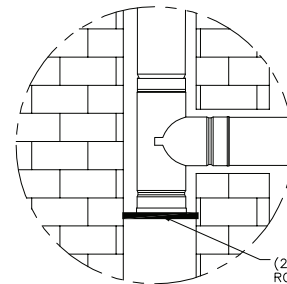

FIG. 5



(2) TWO 3/8" DIAMETER SUPPORT RODS PLACED INTO THE LINER DIRECTLY BELOW THE TEE

5. Use a Wall Thimble (WT) for all penetrations through combustible walls (See Fig. 5). Refer to **TABLE 2** for minimum opening size to install Wall thimble.

TABLE 2

PIPE DIA.	REQ'D OPENING
4"	7-1/2" x 7-1/2"
5"	8-1/2" x 8-1/2"
6"	9-1/2" x 9-1/2"

OIL VENT SIZING

Vent sizing is **Very Important** with modern high efficiency oil equipment. Sizing vent for proper draft per NFPA guidelines has a very successful track record in minimizing condensation/corrosion problems associated with lower venting temperatures that result from higher efficiency appliances.

The following sizing recommendations are based on, and in accordance with published information of U.S. standard NFPA 31 and Canadian Standard B 139. Sizing is for single appliance systems or multiple appliances totaling listed BTU values or G.P.H. values.

L-Vent Sizing Table

BTU Input (Thousands)	GPH	Vent I.D.		Metal-Fab Recommended I.D.	Minimum Recommended Base Temperature °F for Chimney Height				
		Min.	Max.		10'	15'	25'	35'	45'
77	.55	4	5	4	290	390	430	475	510
90	.65	4	5	5	275	340	410	470	495
105	.75	4	5	5	260	320	380	440	480
119	.85	4	5	5	250	300	355	430	465
140	1.00	4	6	5	255	300	365	430	450
175	1.25	4	6	5	240	275	320	365	425
210	1.50	5	7	6	240	275	320	365	425
245	1.75	5	7	6	230	265	295	330	385

- Above information is based on venting systems with less than 10' connector length.
- Deduct 10% from maximum values for angled offset in main vent (see page 4)

Limitations of horizontal length are as follows:

Vent Diameter	30°, 45°, 60° Offset Max. Horizontal Length
4"	6 Feet
5"	7.5 Feet
6"	9 Feet

- Smaller diameter is preferred in overlap sizing situations. The following shows effect on vent free area with one sheet metal size change.

I.D.	Free Area% Square Inches	Difference vs. Previous Sheet Metal Size
4"	12.56 sq. in.	
5"	19.62 sq. in.	56% vs. 4"
6"	28.26 sq. in.	44% vs. 5"
7"	38.46 sq. in.	36% vs. 6"
8"	50.24 sq. in.	131% vs. 7"



P.O. Box 1138 • WICHITA, KANSAS 67201
(316) 943-2351 • FAX (316) 943-2717
info@mtl-fabinc.com • www.mtl-fabinc.com